



pizzato elettrica

Control and signalling devices EROUND line



EROUND

Introduction EROUND line

New design and maximum reliability in one single series

Elegance and functionality in one single series: Pizzato Elettrica presents its products range by introducing EROUND, the innovative line of control and signalling devices.

The new series, ergonomically studied to consent a comfortable and easy use of the devices, presents a particularly pleasant line with high attention to details making the products suitable for applications also on machineries with refined design.

EROUND devices thanks to their shape and functionality guarantee max reliability and adaptability to any application.



New generation of products



Created with the intent to improve the functionalities of the products already present in the market, the control and signalling devices of the EROUND line have technical characteristics so as to make the series one of the most complete in the industrial safety sector.

The new design, the attention to details and the elegance of the product combined with its maximum safety and reliability, take the series to the forefront of the market.

Maximum protection

All the EROUND control and signalling devices have protection degree IP67 allowing the installation of the products on any kind of application also in the hardest environmental conditions.

Almost all of the devices besides having protection degree IP67 have successfully passed the test for protection degree IP69K according to standard DIN 40050. Therefore they are suitable for use in machineries subjected to intense washing with high pressure and high temperature water jets and for any condition or environment where a particular attention for cleanness and hygiene is required.



Safety at a glance



Thanks to their shape, their materials and their high brilliancy LED, the indicator lights of the EROUND line guarantee a higher safety by increasing the signalling and visibility degree in any situation.

Under the sign of innovation

The EROUND series self-monitored contact block by Pizzato Elettrica is the first contact block worldwide which has the same vertical and side dimensions of an ordinary contact.

This contact block is recommended for all those devices in which any malfunction detection is deemed useful, particularly for emergency buttons.

In fact, with the electrical circuit opened, the self-monitored contact block automatically detects the following situations:

- contact block detached from the respective fixing adapter;
- fixing adapter detached from the activating device.

Provided with 1 NC positive opening contact, the EROUND self-monitored contact block is available both in panel-mounted and box-mounted versions.



Customizing possibilities



In order to adjust itself to the various applications of this new series, as well as suiting the needs of the customer, Pizzato Elettrica offers the possibility to customize the control and signalling devices of the EROUND line by inscriptions and symbols.

Furthermore it is possible to choose among different colours for the actuators in order to distinguish the functions depending on the applications. Same possibility also for their rings, this way esthetically improving the integration between the EROUND control device and its setting.

Other finishings on request.

Satin-finish chrome



Shiny black



Shiny black chrome (on request)



Shiny gold (on request)

Laser marking

Pizzato Elettrica has introduced a new laser marking for control and signalling devices of the EROUND line. Thanks to this new system which excludes the use of labels, markings on the products are indelible. Furthermore, in case of machineries subjected to intense high pressure water jets, there is no risk of labels detaching from the product.



Guaranteed endurance

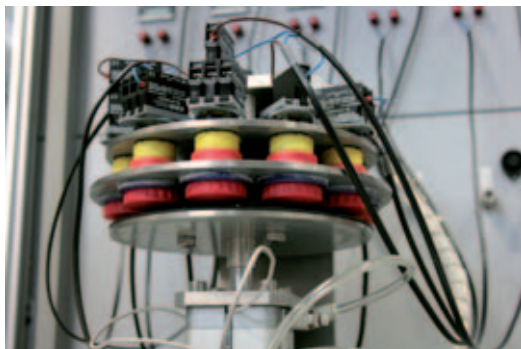

Pizzato Elettrica has tested the control and signalling devices of the EROUND line which underwent specific tests in accordance with EN 60947-5-1. The particular design and the materials employed allow to obtain remarkable mechanical endurance, expressed in number of cycles the articles were subjected to: the contact blocks reached and passed 20 million cycles, the pushbuttons 15 million cycles and the emergency pushbuttons 300.000 cycles.

2D and 3D drawings

On Pizzato Elettrica website (www.pizzato.com) are available drawings in 2D (DXF format) and 3D (STEP format) of all items shown on this brochure. All the files are freely downloadable.



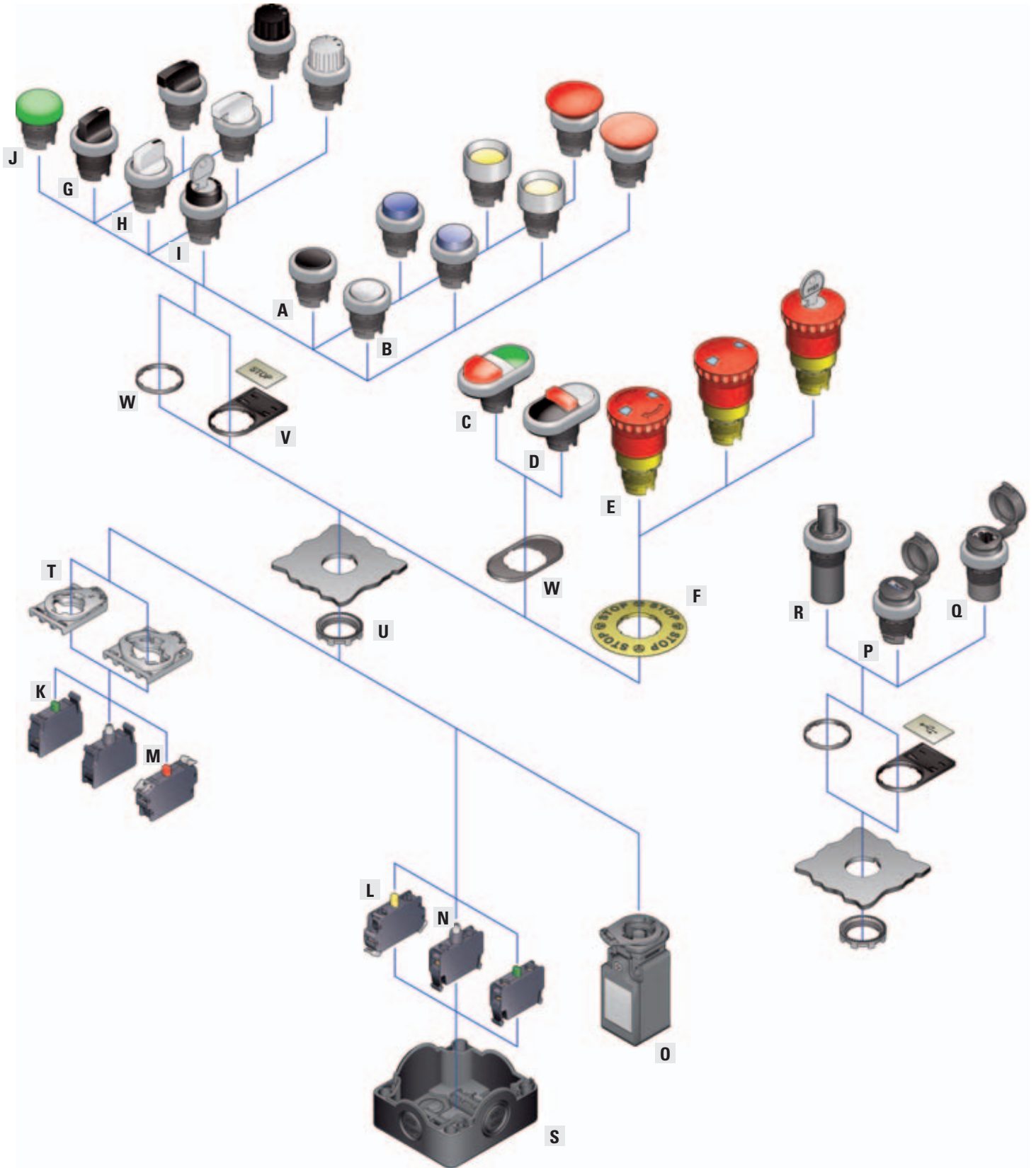

Control and signalling devices

			page	chapter
A	Pushbutton	E2 1PU series	5	1
B	Illuminated pushbutton	E2 1PL series	5	1
C	Double pushbutton	E2 1PD series	13	2
D	Triple pushbutton	E2 1PT series	13	2
E	Emergency pushbutton	E2 1PE series	19	3
F	Label with shaped hole	VE TF series	19	3
G	Selector	E2 1SE series	25	4
H	Illuminated selector	E2 1SL series	25	4
I	Key selector	E2 1SC series	25	4
J	Indicator light	E2 1IL series	37	5
K	Single contact blocks	E2 C series	41	6
L	Single self-monitored contact blocks	E2 C series	41	6
M	Double contact blocks	E2 L series	47	7
N	LED holder	E2 L series	51	8
O	Protected contact blocks	FR, FK, FX	57	9
P	USB sockets	E2 USB series		Available as from 2013
Q	RJ45 sockets	E2 RJ45 series		Available as from 2013
R	Potentiometers	E6 DM series		Available as from 2013

Enclosures

S	Enclosures	ES series	61	10
	Enclosures	EA series	69	11

Accessories

T	Fixing adapters	E2 1BA series	75	12
U	Fixing rings	VE GF series	75	12
V	Label holders	VE PT series	75	12
	Labels	VE TR series	75	12
	Fixing tool	VE CH series	75	12
W	Shaped rings	VE GP series	75	12
	Protection guards	VE GP series	75	12
	Protection hoods	VE CA series	75	12
	Blanking plug	E2 1TA series	75	12
	Dust protection	VE PR series	75	12

Appendix

	Utilization requirements		78	13
--	--------------------------	--	----	-----------

Selection diagram

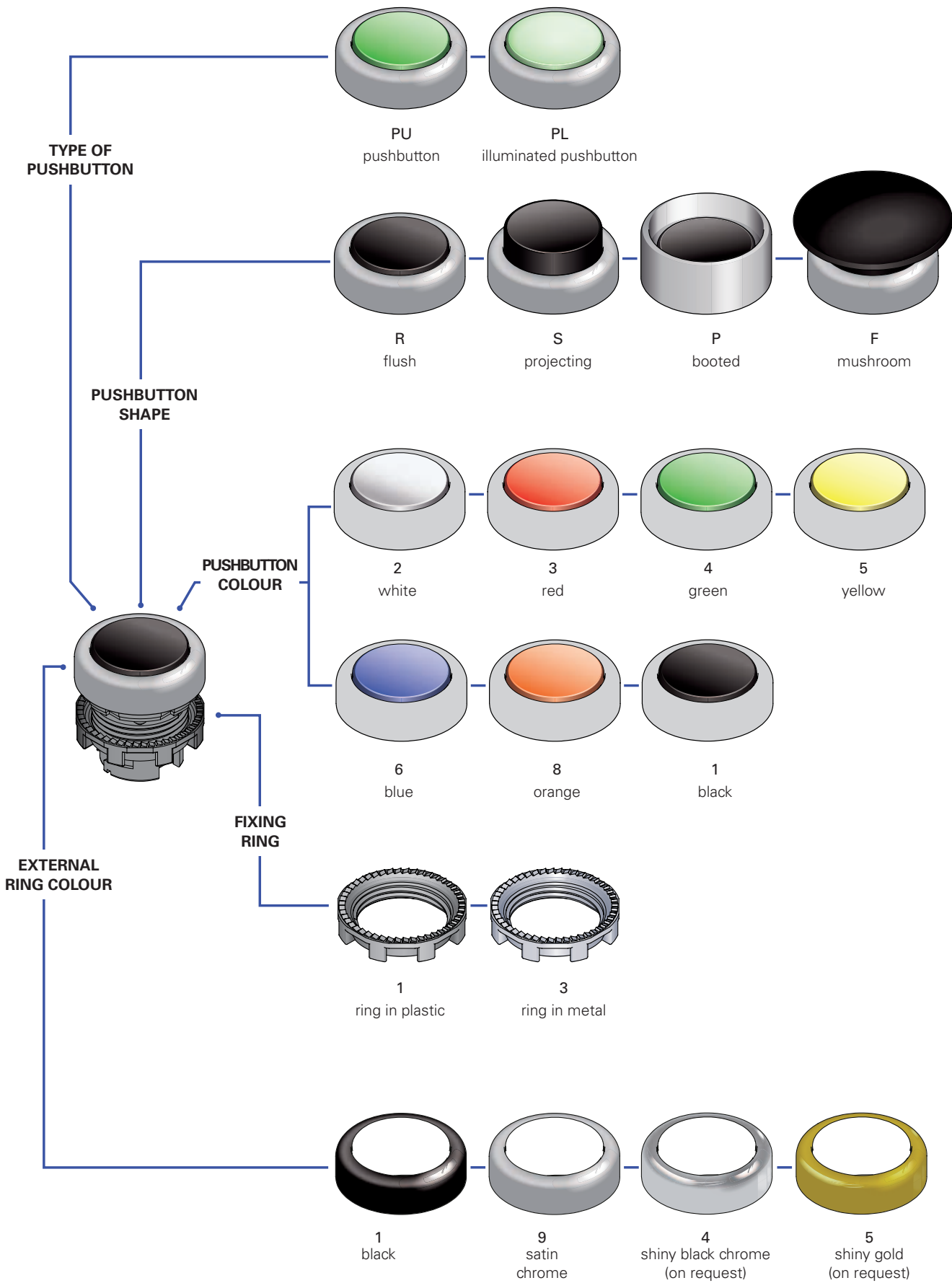

Pushbuttons code structure

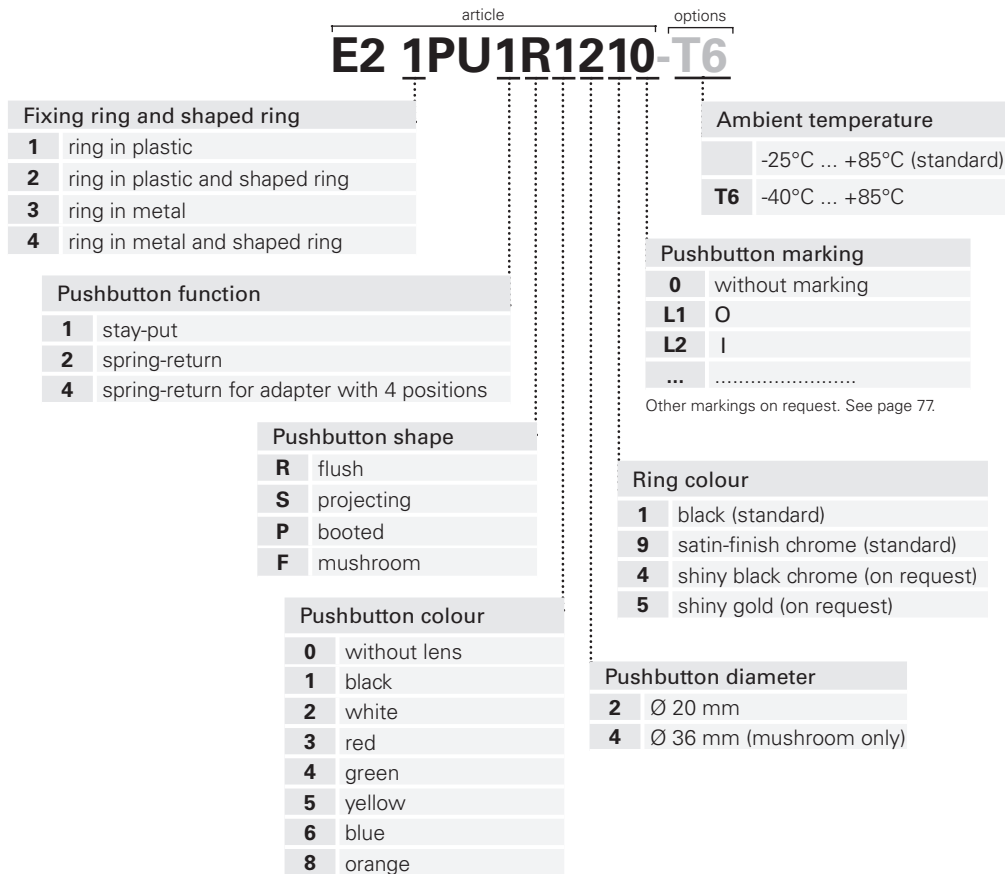

Attention! The feasibility of a code number does not mean the effective availability of a product. Please contact our sales office.

Illuminated pushbuttons code structure

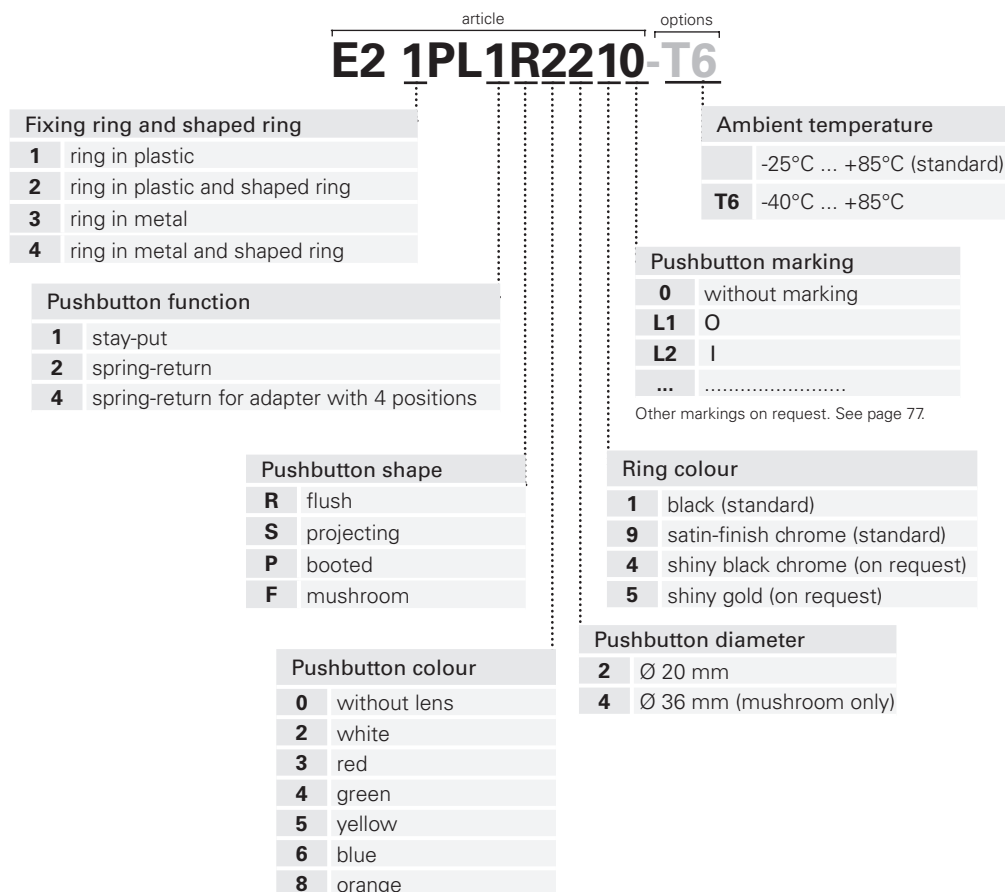

Attention! The feasibility of a code number does not mean the effective availability of a product. Please contact our sales office.



Main features

- Protection degree IP67 and IP69K
- 4 different shapes
- 7 colours available
- Versions for - 40°C
- Stay-put or spring-return versions

Markings and quality marks:



Approval GOST: POCC IT.AB24.B04512

Technical data

General data

Protection degree:	IP67 according to IEC 60529 IP69K according to DIN 40050
Ambient temperature:	-25°C +80°C
Mechanical endurance:	15 million operations cycles (Spring-return pushbutton) 1 million operations cycles (Stay-put pushbutton)
Max operating frequency:	3600 operations cycles/hour
Actuating force at end travel:	spring-return 3,7 N (without contact) stay-put 4,4 N (without contact)
Maximum travel:	5 mm
Ring driving torque:	2 ... 2,5 Nm
Utilization requirements:	see page 78

In conformity with standards:

IEC 60947-1, IEC 60947-5-1, IEC 60204-1, EN 60947-1, EN 60947-5-1, EN 60204-1, UL 508, CSA 22-2 N°14

⚠ Installation for safety applications:

Use only switches with marking with the symbol . The safety circuit must always be connected with the **NC contacts** (normally closed contacts: 1-2) as stated in the standard EN 60947-5-1, encl. K, par. 2.

In conformity with requirements requested by:

Low Voltage Directive 2006/95/EC, Machinery Directive 2006/42/EC and Electromagnetic Compatibility 2004/108/EC.

Positive contact opening in conformity with standards:

IEC 60947-5-1, EN 60947-5-1, VDE 0660-206.

General characteristics

Protection degree IP67 and IP69K

IP69K
IP67

Designed to be employed also in severe environment conditions, Pizzato Elettrica pushbuttons have protection degree IP67 and IP69K, suitable for use in machineries subjected to intense washing with high pressure and high temperature water jets.

Fixing ring

A fixing ring in metal is also available in addition to the fixing ring in technopolymer.

The fixing ring in metal is particularly suitable for those applications which require tighter fitting of the panel-mounted device, such as for example in metal panels having holes without reference notches. Both rings feature a toothed surface which comes into contact with the inside of the panel in order to make it easier for the device to be secured to the actual panel.

Shaped ring

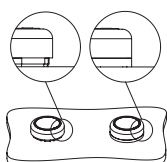

The shaped ring can be used when no label holders or other devices are applied; it prevents dirt and other residues from settling between the pushbutton and the panel or box. This turns out to be particularly useful in the sectors where high standards of cleanness and hygiene are required.

Functions

Depending on the application, Pizzato Elettrica EROUND pushbuttons are available in two versions: stay-put (once the button is pushed a second manual intervention is needed to release it) and spring-return (the pushbutton hasn't any stable stop system).



Customizing possibilities

In order to suit the various requests and needs of the customers, Pizzato Elettrica offers the possibility to customize the EROUND control and signalling devices: the rings can be requested in different colours (gold satinized, bright black chrome, black and satin chrome), while the lens can be customized with inscriptions, symbols and colours.

Temperature range extended

-40°C

Special versions can be ordered for use in environments where the temperature changes from +80°C to -40°C.

They can be installed inside cold stores, sterilizers or other equipments with very low ambient temperature. Special materials that have been used to realize these versions, maintain unchanged their features also in these conditions, widening the installation possibilities.

Pushbuttons selection table

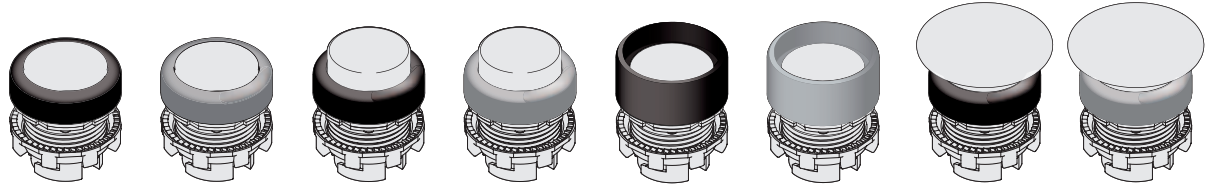

Actuator colour and marking	Flush		Projecting		Booted		Mushroom	
	black ring	satin chrome ring	black ring	satin chrome ring	black ring	satin chrome ring	black ring	satin chrome ring
without lens	E2 1PU2R0210	E2 1PU2R0290	-	-	E2 1PU2P0210	E2 1PU2P0290	-	-
black	E2 1PU2R1210	E2 1PU2R1290	E2 1PU2S1210	E2 1PU2S1290	E2 1PU2P1210	E2 1PU2P1290	E2 1PU2F1410	E2 1PU2F1490
white	E2 1PU2R2210	E2 1PU2R2290	E2 1PU2S2210	E2 1PU2S2290	E2 1PU2P2210	E2 1PU2P2290	E2 1PU2F2410	E2 1PU2F2490
red	E2 1PU2R3210	E2 1PU2R3290	E2 1PU2S3210	E2 1PU2S3290	E2 1PU2P3210	E2 1PU2P3290	E2 1PU2F3410	E2 1PU2F3490
green	E2 1PU2R4210	E2 1PU2R4290	E2 1PU2S4210	E2 1PU2S4290	E2 1PU2P4210	E2 1PU2P4290	E2 1PU2F4410	E2 1PU2F4490
yellow	E2 1PU2R5210	E2 1PU2R5290	E2 1PU2S5210	E2 1PU2S5290	E2 1PU2P5210	E2 1PU2P5290	E2 1PU2F5410	E2 1PU2F5490
blue	E2 1PU2R6210	E2 1PU2R6290	E2 1PU2S6210	E2 1PU2S6290	E2 1PU2P6210	E2 1PU2P6290	E2 1PU2F6410	E2 1PU2F6490
orange	E2 1PU2R8210	E2 1PU2R8290	E2 1PU2S8210	E2 1PU2S8290	E2 1PU2P8210	E2 1PU2P8290	E2 1PU2F8410	E2 1PU2F8490
red with lens	E2 1PU2R321L1	E2 1PU2R329L1	E2 1PU2S321L1	E2 1PU2S329L1	-	-	E2 1PU2F341L1	E2 1PU2F349L1
green with lens	E2 1PU2R421L2	E2 1PU2R429L2	E2 1PU2S421L2	E2 1PU2S429L2	E2 1PU2P421L2	E2 1PU2P429L2	E2 1PU2F441L2	E2 1PU2F449L2
black with lens	E2 1PU2R121L1	E2 1PU2R129L1	E2 1PU2S121L1	E2 1PU2S129L1	-	-	E2 1PU2F141L1	E2 1PU2F149L1
white with lens	E2 1PU2R221L2	E2 1PU2R229L2	E2 1PU2S221L2	E2 1PU2S229L2	E2 1PU2P221L2	E2 1PU2P229L2	E2 1PU2F241L2	E2 1PU2F249L2

For ordering a stay-put pushbutton substitute in the article codes 1PU2 with 1PU1.
Example: E2 1PU2R0210 → E2 1PU1R0210

Illuminated pushbuttons selection table

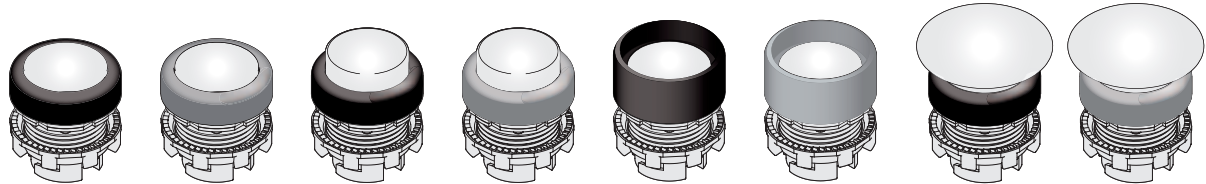

Actuator colour and marking	Flush		Projecting		Booted		Mushroom	
	black ring	satin chrome ring	black ring	satin chrome ring	black ring	satin chrome ring	black ring	satin chrome ring
without lens	E2 1PL2R0210	E2 1PL2R0290	-	-	E2 1PL2P0210	E2 1PL2P0290	-	-
white	E2 1PL2R2210	E2 1PL2R2290	E2 1PL2S2210	E2 1PL2S2290	E2 1PL2P2210	E2 1PL2P2290	E2 1PL2F2410	E2 1PL2F2490
red	E2 1PL2R3210	E2 1PL2R3290	E2 1PL2S3210	E2 1PL2S3290	E2 1PL2P3210	E2 1PL2P3290	E2 1PL2F3410	E2 1PL2F3490
green	E2 1PL2R4210	E2 1PL2R4290	E2 1PL2S4210	E2 1PL2S4290	E2 1PL2P4210	E2 1PL2P4290	E2 1PL2F4410	E2 1PL2F4490
yellow	E2 1PL2R5210	E2 1PL2R5290	E2 1PL2S5210	E2 1PL2S5290	E2 1PL2P5210	E2 1PL2P5290	E2 1PL2F5410	E2 1PL2F5490
blue	E2 1PL2R6210	E2 1PL2R6290	E2 1PL2S6210	E2 1PL2S6290	E2 1PL2P6210	E2 1PL2P6290	E2 1PL2F6410	E2 1PL2F6490
orange	E2 1PL2R8210	E2 1PL2R8290	E2 1PL2S8210	E2 1PL2S8290	E2 1PL2P8210	E2 1PL2P8290	E2 1PL2F8410	E2 1PL2F8490
red with lens	E2 1PL2R321L1	E2 1PL2R329L1	E2 1PL2S321L1	E2 1PL2S329L1	-	-	E2 1PL2F341L1	E2 1PL2F349L1
green with lens	E2 1PL2R421L2	E2 1PL2R429L2	E2 1PL2S421L2	E2 1PL2S429L2	E2 1PL2P421L2	E2 1PL2P429L2	E2 1PL2F441L2	E2 1PL2F449L2
white with lens	E2 1PL2R221L1	E2 1PL2R229L1	E2 1PL2S221L1	E2 1PL2S229L1	-	-	E2 1PL2F241L1	E2 1PL2F249L1
white with lens	E2 1PL2R221L2	E2 1PL2R229L2	E2 1PL2S221L2	E2 1PL2S229L2	E2 1PL2P221L2	E2 1PL2P229L2	E2 1PL2F241L2	E2 1PL2F249L2

For ordering a stay-put pushbutton substitute in the article codes 1PL2 with 1PL1.
Example: E2 1PL2R0210 → E2 1PL1R0210

Items with code on the green background are available in stock

Complete units with pushbuttons

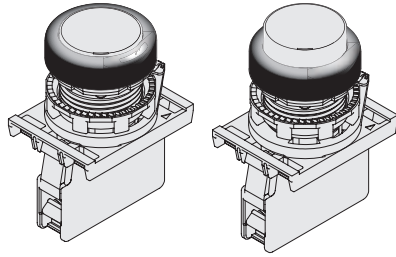

Complete units with illuminated pushbuttons

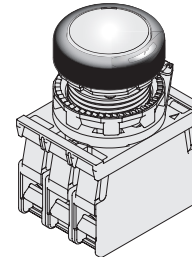

Actuator colour and marking	Contacts			Flush	
	pos 2	pos 3	pos 1	black ring	black ring
● black	-	1NO	-	E2 AC-DXBC1204 E2 1PU2R1210 + E2 1BAC11 + E2 CP10G2V1	
○ white	-	1NO	-	E2 AC-DXBC1200 E2 1PU2R2210 + E2 1BAC11 + E2 CP10G2V1	
● red	-	1NC ⊕	-	E2 AC-DXBC1208 E2 1PU2R3210 + E2 1BAC11 + E2 CP01G2V1	E2 AC-DXBC1209 E2 1PU2S3210 + E2 1BAC11 + E2 CP01G2V1
● green	-	1NO	-	E2 AC-DXBC1201 E2 1PU2R4210 + E2 1BAC11 + E2 CP10G2V1	
● yellow	-	1NO	-	E2 AC-DXBC1206 E2 1PU2R5210 + E2 1BAC11 + E2 CP10G2V1	
● blue	-	1NO	-	E2 AC-DXBC1207 E2 1PU2R6210 + E2 1BAC11 + E2 CP10G2V1	
● red ⊕	-	1NC ⊕	-	E2 AC-DXBC1211 E2 1PU2R321L1 + E2 1BAC11 + E2 CP01G2V1	E2 AC-DXBC1212 E2 1PU2S321L1 + E2 1BAC11 + E2 CP01G2V1
● green ⊕	-	1NO	-	E2 AC-DXBC1210 E2 1PU2R421L2 + E2 1BAC11 + E2 CP10G2V1	
● black ⊕	-	1NC ⊕	-	E2 AC-DXBC1227 E2 1PU2R121L1 + E2 1BAC11 + E2 CP01G2V1	
● white ⊕	-	1NO	-	E2 AC-DXBC1226 E2 1PU2R221L2 + E2 1BAC11 + E2 CP10G2V1	

Actuator colour and marking	Contacts			Flush	
	pos 2	pos 3	pos 1	black ring	
○ white ⊕	1NC ⊕	LED	1NO	E2 AC-DXBC0400 E2 1PL2R2210 + E2 1BAC11 + E2 CP01G2V1 + E2 LP1A2V1 + E2 CP10G2V1	
● red ⊕	1NC ⊕	LED	1NO	E2 AC-DXBC0402 E2 1PL2R3210 + E2 1BAC11 + E2 CP01G2V1 + E2 LP1A3V1 + E2 CP10G2V1	
● green ⊕	1NC ⊕	LED	1NO	E2 AC-DXBC0401 E2 1PL2R4210 + E2 1BAC11 + E2 CP01G2V1 + E2 LP1A4V1 + E2 CP10G2V1	
● yellow ⊕	1NC ⊕	LED	1NO	E2 AC-DXBC0404 E2 1PL2R5210 + E2 1BAC11 + E2 CP01G2V1 + E2 LP1A2V1 + E2 CP10G2V1	
● blue ⊕	1NC ⊕	LED	1NO	E2 AC-DXBC0403 E2 1PL2R6210 + E2 1BAC11 + E2 CP01G2V1 + E2 LP1A6V1 + E2 CP10G2V1	

→ For the contact block and LED block characteristics see the respective chapters.

Dimensions

Flush pushbutton

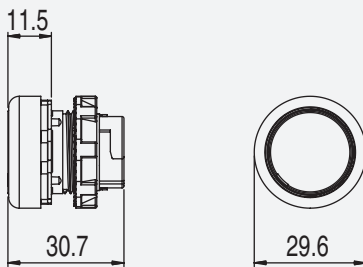

Projecting pushbutton

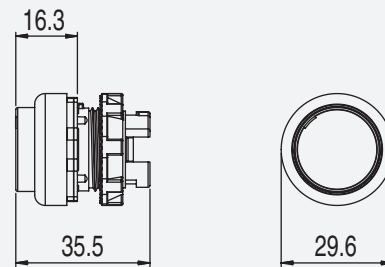

Booted pushbutton

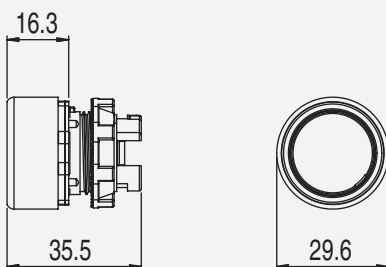

Mushroom pushbutton

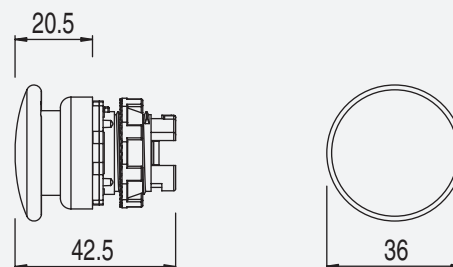



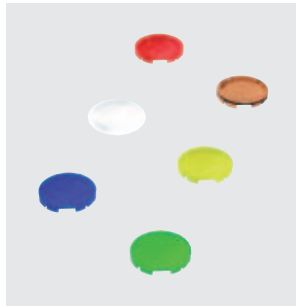

All measures in the drawings are in mm

Lenses for E2 1PU pushbuttons and E2 1PL illuminated pushbuttons



For ordering E2 1PL lenses with marking:

in the article code substitute ●●● with the marking code in the table at page 77.
 Example: lens for flush pushbuttons with "O" marking, black colour.
 VE LP 22R1●●● → VE LP 22R1L1

Article	Marking	Description	Colours	Pcs/Packs
VE LP21R10		Lens for black flush pushbutton, without marking	●	10
VE LP22R20		Lens for white flush pushbutton, without marking	○	10
VE LP22R30		Lens for red flush pushbutton, without marking	●	10
VE LP22R40		Lens for green flush pushbutton, without marking	●	10
VE LP22R50		Lens for yellow flush pushbutton, without marking	●	10
VE LP22R60		Lens for blue flush pushbutton, without marking	●	10
VE LP22R80		Lens for orange flush pushbutton, without marking	●	10
VE LP22RA0		6 lens without marking for flush pushbutton, colours: black, white, red, green, yellow, blue, orange	● ○ ● ● ● ● ●	1
VE LP21S10		Lens for black projecting pushbutton, without marking	●	10
VE LP22S20		Lens for white projecting pushbutton, without marking	○	10
VE LP22S30		Lens for red projecting pushbutton, without marking	●	10
VE LP22S40		Lens for green projecting pushbutton, without marking	●	10
VE LP22S50		Lens for yellow projecting pushbutton, without marking	●	10
VE LP22S60		Lens for blue projecting pushbutton, without marking	●	10
VE LP22S80		Lens for orange projecting pushbutton, without marking	●	10
VE LP22SA0		6 lens without marking for projecting pushbutton, colours: black, white, red, green, yellow, blue, orange	● ○ ● ● ● ● ●	1
VE LP21R1●●●		Lens for black flush pushbutton, with marking	●	1
VE LP22R2●●●		Lens for white flush pushbutton, with marking	○	1
VE LP22R3●●●		Lens for red flush pushbutton, with marking	●	1
VE LP22R4●●●		Lens for green flush pushbutton, with marking	●	1
VE LP22R5●●●		Lens for yellow flush pushbutton, with marking	●	1
VE LP22R6●●●		Lens for blue flush pushbutton, with marking	●	1
VE LP21S1●●●		Lens for black projecting pushbutton, with marking	●	1
VE LP22S2●●●		Lens for white projecting pushbutton, with marking	○	1
VE LP22S3●●●		Lens for red projecting pushbutton, with marking	●	1
VE LP22S4●●●		Lens for green projecting pushbutton, with marking	●	1
VE LP22S5●●●		Lens for yellow projecting pushbutton, with marking	●	1
VE LP22S6●●●		Lens for blue projecting pushbutton, with marking	●	1

Black coloured lenses cannot be applied on illuminated pushbuttons.

Items with code on the green background are available in stock

Blanking plug

10 pcs packs



Article	Description
VE AS1211	Central blanking plug for E2 1PL●●●●● illuminated pushbuttons. For fixing adapter with 3 positions. It closes the illuminated button central hole allowing to install a contact instead of the LED.

Actuator for adapter with 4 positions

10 pcs packs



Article	Description
VE AS1218	Long closed actuator for fixing adapter with 4 positions. It must be installed after fixing the push-button to the wall. For E2 1PU●●●●● pushbuttons.

Accessories

→ [More ACCESSORIES](#) at page 75

Contacts maximum number

Fixing adapter with 3 positions

Fixing adapter with 4 positions

Spring-return pushbutton
E2 1PU2●●●●●

Stay-put pushbutton
E2 1PU1●●●●●

Illuminated spring-return pushbutton
E2 1PL2●●●●●

Illuminated stay-put pushbutton
E2 1PL1●●●●●

Spring-return pushbutton
E2 1PU4●●●●●

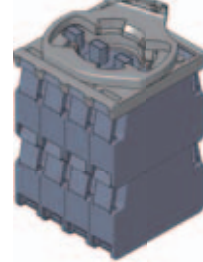
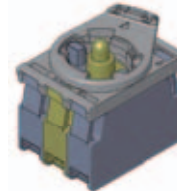
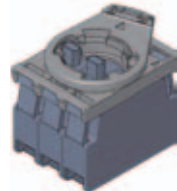
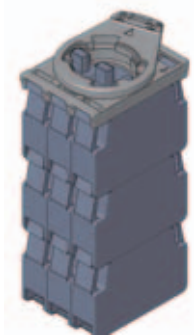

Contacts maximum number: 9

Contacts maximum number: 3

Contacts maximum number: 6

Contacts maximum number: 2

Contacts maximum number: 8

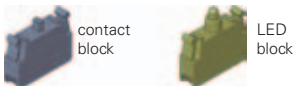
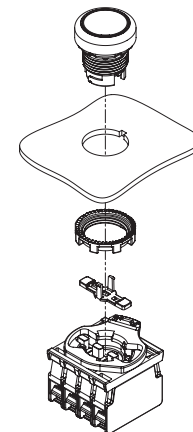
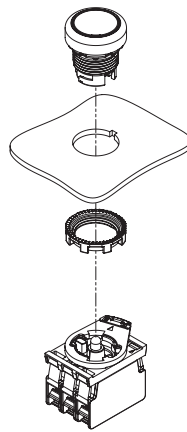
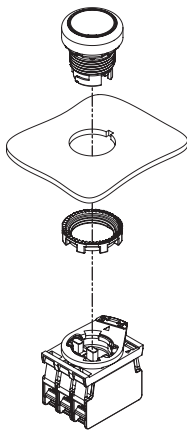

The actuator for an adapter with 4 positions must be mounted after fixing the push-button.

Selection diagram

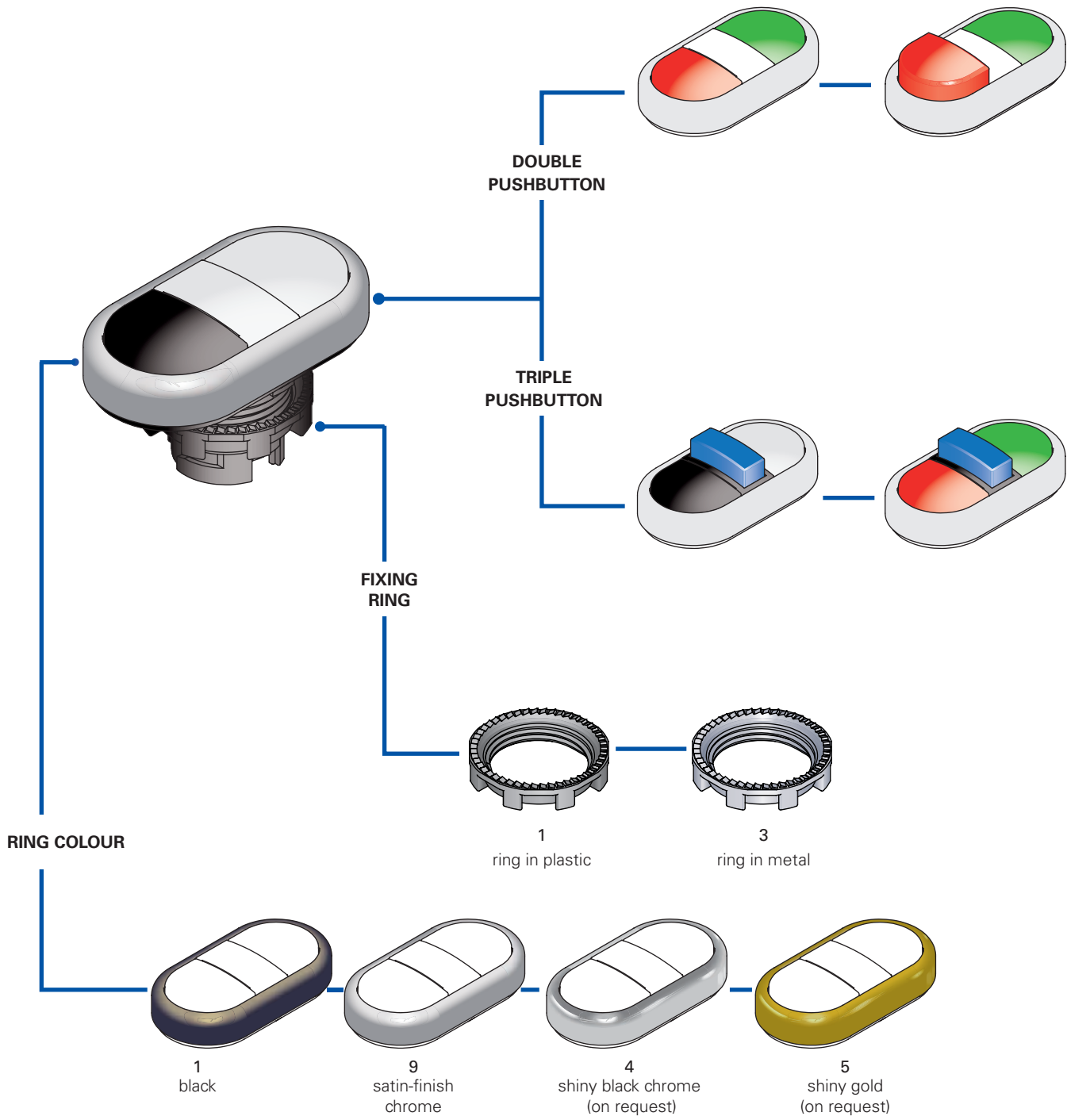

Double and triple pushbuttons code structure

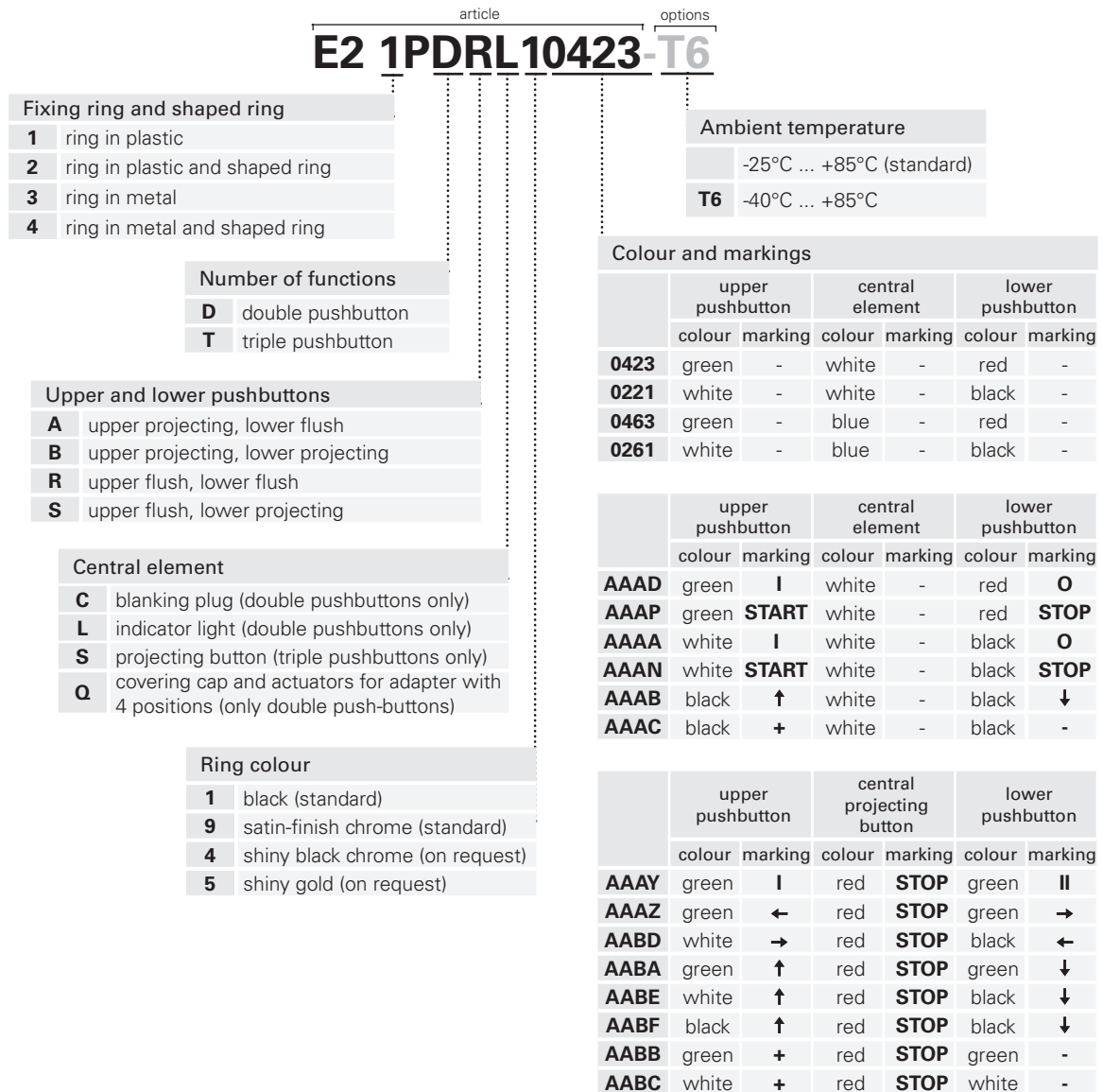

Attention! The feasibility of a code number does not mean the effective availability of a product. Please contact our sales office.



Main features

- Protection degree IP67
- 2 or 3 pushbuttons versions
- Versions for -40°C
- Version with luminous central cap

Markings and quality marks:



Approval GOST: POCC IT.AB24.B04512

Technical data

General

Protection degree:	IP67 according to IEC 60529
Ambient temperature:	-25°C +80°C
Mechanical endurance:	1 million operations cycles
Max operating frequency:	3600 operations cycles/hour
Actuating force at end travel:	4,4 (without contacts)
Maximum travel:	5 mm
Ring driving torque:	2 ... 2,5 Nm
Utilization requirements:	see page 78

In conformity with standards:

IEC 60947-1, IEC 60947-5-1, IEC 60204-1, EN 60947-1, EN 60947-5-1, EN 60204-1, UL 508, CSA 22-2 N°14

⚠ Installation for safety applications:

Use only switches marked with the symbol ⊕. The safety circuit must always be connected with the **NC contacts** (normally closed contacts: 1-2) as stated in the standard EN 60947-5-1, encl. K, par. 2.

In conformity with requirements requested by:

Low Voltage Directive 2006/95/EC, Machinery Directive 2006/42/EC and Electromagnetic Compatibility 2004/108/EC.

Positive contact opening in conformity with standards:

IEC 60947-5-1, EN 60947-5-1, VDE 0660-206.

General characteristics

Shape

The new EROUND line double and triple pushbuttons are available in two shapes in order to suit any kind of application: projecting and flush. The possibility to choose shapes, colours and symbols allows various codes combinations.

Illuminated version

A version with central indicator light is available for double pushbuttons.

Fixing ring

A fixing ring in metal is also available in addition to the fixing ring in technopolymer.

The fixing ring in metal is particularly suitable for those applications which require tighter fitting of the panel-mounted device, such as for example in metal panels having holes without reference notches. Both rings feature a toothed surface which comes into contact with the inside of the panel in order to make it easier for the device to be secured to the actual panel.

Shaped ring

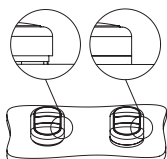

The shaped ring can be used when no label holders or other devices are applied; it prevents dirt and other residues from settling between the pushbutton and the panel or box. This turns out to be particularly useful in the sectors where high standards of cleanness and hygiene are required.

Mechanical endurance

Thanks to their particular design Pizzato Elettrica double and triple pushbuttons guarantee a Mechanical endurance of more than 1.000.000 operations.

Protection degree IP67

IP67 This series pushbuttons all have protection degree IP67, this way guaranteeing a total protection also in hard environmental conditions.





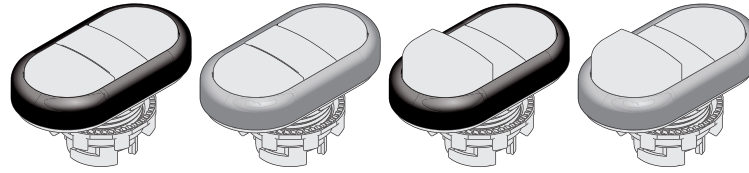

Temperature range extended

-40°C Special versions can be ordered for use in environments where the temperature changes from +80°C to -40°C.

They can be installed inside cold stores, sterilizers or other equipments with very low ambient temperature. Special materials that have been used to realize these versions, maintain unchanged their features also in these conditions, widening the installation possibilities.





Double pushbuttons selection table



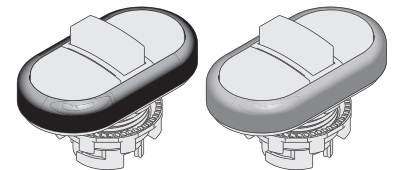
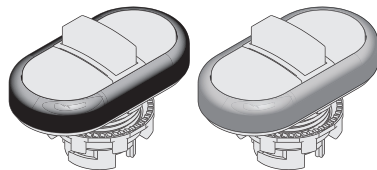





Actuator colour and marking	flush upper pushbutton flush central element flush lower pushbutton		flush upper pushbutton flush central element projecting lower pushbutton	
	black ring	satin chrome ring	black ring	satin chrome ring
 green pushbutton white indicator light red pushbutton "I"	E2 1PDRL10423	E2 1PDRL90423	E2 1PDSL10423	E2 1PDSL90423
 green pushbutton white indicator light "O" red pushbutton "START"	E2 1PDRL1AAAD	E2 1PDRL9AAAD	E2 1PDSL1AAAD	E2 1PDSL9AAAD
 green pushbutton white indicator light "STOP" red pushbutton white pushbutton white indicator light	E2 1PDRL1AAAP	E2 1PDRL9AAAP	E2 1PDSL1AAAP	E2 1PDSL9AAAP
 black pushbutton "I"	E2 1PDRL10221	E2 1PDRL90221	E2 1PDSL10221	E2 1PDSL90221
 white pushbutton white indicator light "O" black pushbutton "START"	E2 1PDRL1AAAA	E2 1PDRL9AAAA	E2 1PDSL1AAAA	E2 1PDSL9AAAA
 white pushbutton white indicator light "STOP" black pushbutton "↑"	E2 1PDRL1AAAN	E2 1PDRL9AAAN	E2 1PDSL1AAAN	E2 1PDSL9AAAN
 black pushbutton white indicator light "↓" black pushbutton	E2 1PDRL1AAAB	E2 1PDRL9AAAB	E2 1PDSL1AAAB	E2 1PDSL9AAAB

Triple pushbuttons selection table



Actuator colour and marking	flush upper pushbutton projecting central pushbutton flush lower pushbutton	
	black ring	satin chrome ring
 green pushbutton "STOP" red pushbutton "II"	E2 1PTRS1AAAY	E2 1PTRS9AAAY
 green pushbutton "STOP" red pushbutton "←"	E2 1PTRS1AAAZ	E2 1PTRS9AAAZ
 green pushbutton "STOP" red pushbutton "→"	E2 1PTRS1AABD	E2 1PTRS9AABD
 black pushbutton "STOP" red pushbutton "←"	E2 1PTRS1AABA	E2 1PTRS9AABA
 green pushbutton "STOP" red pushbutton "↑"	E2 1PTRS1AABA	E2 1PTRS9AABA

Actuator colour and marking	flush upper pushbutton projecting central pushbutton flush lower pushbutton	
	black ring	satin chrome ring
 white pushbutton "STOP" red pushbutton "↓"	E2 1PTRS1AABE	E2 1PTRS9AABE
 black pushbutton "STOP" red pushbutton "↑"	E2 1PTRS1AABF	E2 1PTRS9AABF
 black pushbutton "STOP" red pushbutton "↓"	E2 1PTRS1AABB	E2 1PTRS9AABB
 green pushbutton "STOP" red pushbutton "+"	E2 1PTRS1AABB	E2 1PTRS9AABB
 green pushbutton "STOP" red pushbutton "+"	E2 1PTRS1AABC	E2 1PTRS9AABC
 white pushbutton "STOP" red pushbutton "+"	E2 1PTRS1AABC	E2 1PTRS9AABC

Items with code on the green background are available in stock

Double pushbuttons complete units

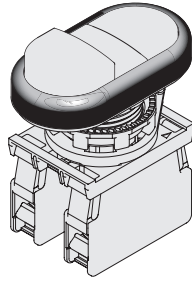

Actuator colour and marking		Contacts			flush upper button flush central element projecting lower button
		pos 2	pos 3	pos 1	black ring
	"I" green pushbutton	1NC ⊕	-	1NO	E2 AC-DXBC0601 E2 1PDC1AAAK + E2 1BAC11 + E2 CP01G2V1 E2 CP10G2V1
	black blanking plug "O" red pushbutton				

Triple pushbuttons complete units

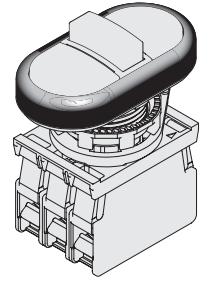

Actuator colour and marking		Contacts			flush upper button projecting central button flush lower pushbutton
		pos 2	pos 3	pos 1	black ring
	"I" green pushbutton	1NO	1NC ⊕	1NO	E2 AC-DXBC0801 E2 1PTRS1AAAY + E2 1BAC11 + E2 CP10G2V1 + E2 CP01G2V1 + E2 CP10G2V1
	"STOP" red pushbutton "II" green pushbutton				

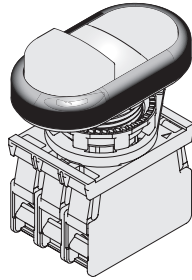

Actuator colour and marking		Contacts			flush upper button flush central element projecting lower button
		pos 2	pos 3	pos 1	black ring
	"I" green pushbutton	1NC ⊕	LED	1NO	E2 AC-DXBC0602 E2 1PDSL1AAAD + E2 1BAC11 + E2 CP01G2V1 + E2 LP1A2V1 + E2 CP10G2V1
	white indicator light "O" red pushbutton				

→ For the contact block and LED block characteristics see the respective chapters.

Protection hood 10 pcs packs

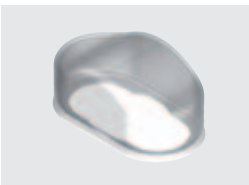

Article	Description
VE CA1C1	Protection hood for double and triple pushbutton E2 1PD..... E2 1PT.....

The shaped ring is not to be fitted when the protection hood is present.

Shaped ring 50 pcs packs



Article	Description
VE GP12L1A	Shaped ring for double and triple pushbutton 2 1PD..... E2 1PT.....

The protection hood is not to be fitted when the shaped ring is present.

Assembling minimum distances

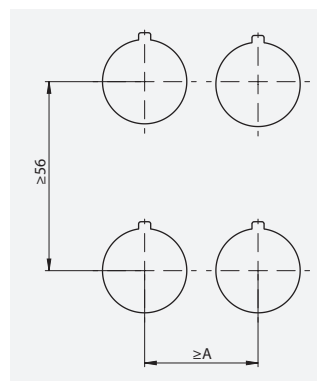

Fixing adapter with 3 positions
A=30 mm

Fixing adapter with 4 positions
A=40 mm

Accessories

→ ACCESSORIES at page 75

Dimensions

Flush double pushbutton

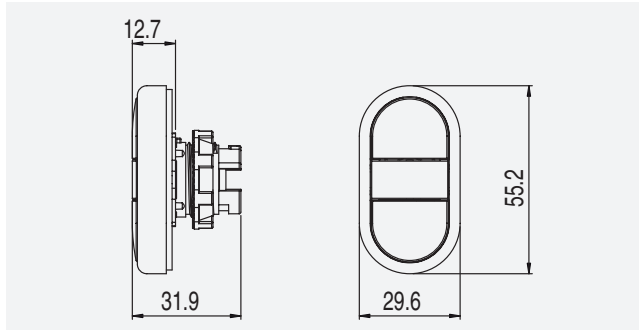

Projecting double pushbutton

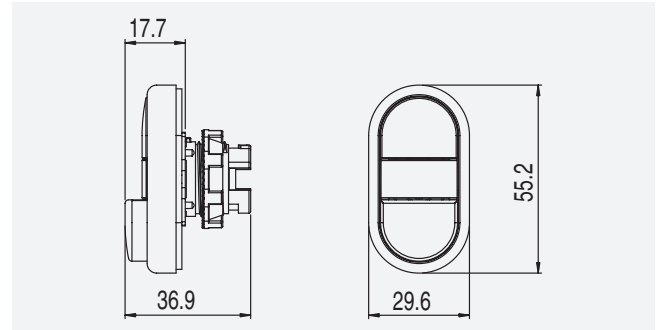

Triple pushbutton

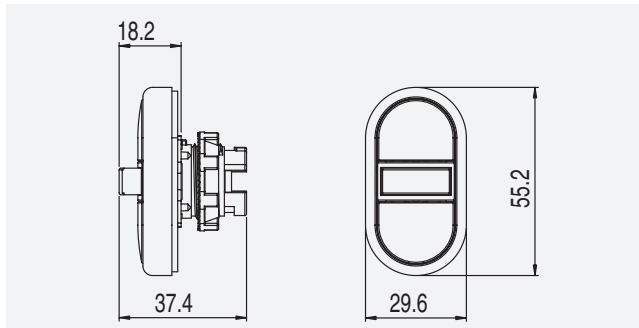

All measures in the drawings are in mm

→ I2D and 3D files available on www.pizzato.com

Contacts maximum number

Fixing adapter with 3 positions

Double pushbutton E2 1PD●●●●●●

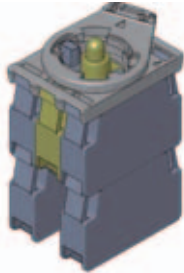

Contacts maximum number: 4

Triple pushbutton E2 1PT●●●●●●

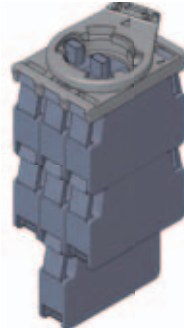

Contacts maximum number: 7

Fixing adapter with 4 positions

Double pushbutton E2 1PD●Q●●●●

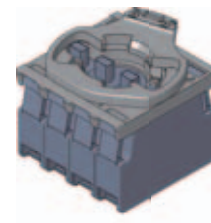

Contacts maximum number: 4

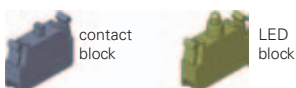
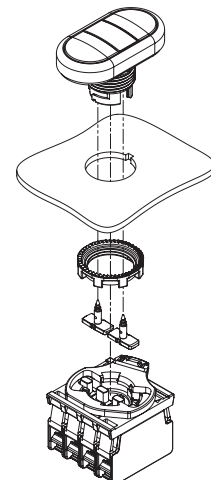
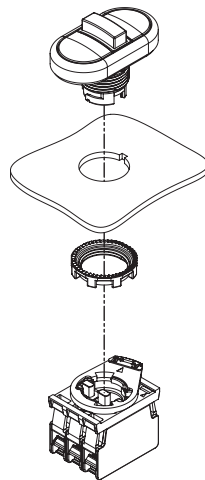

The actuators provided with the specific pushbutton for an adapter with 4 positions must be mounted after fixing the pushbutton.

Selection diagram

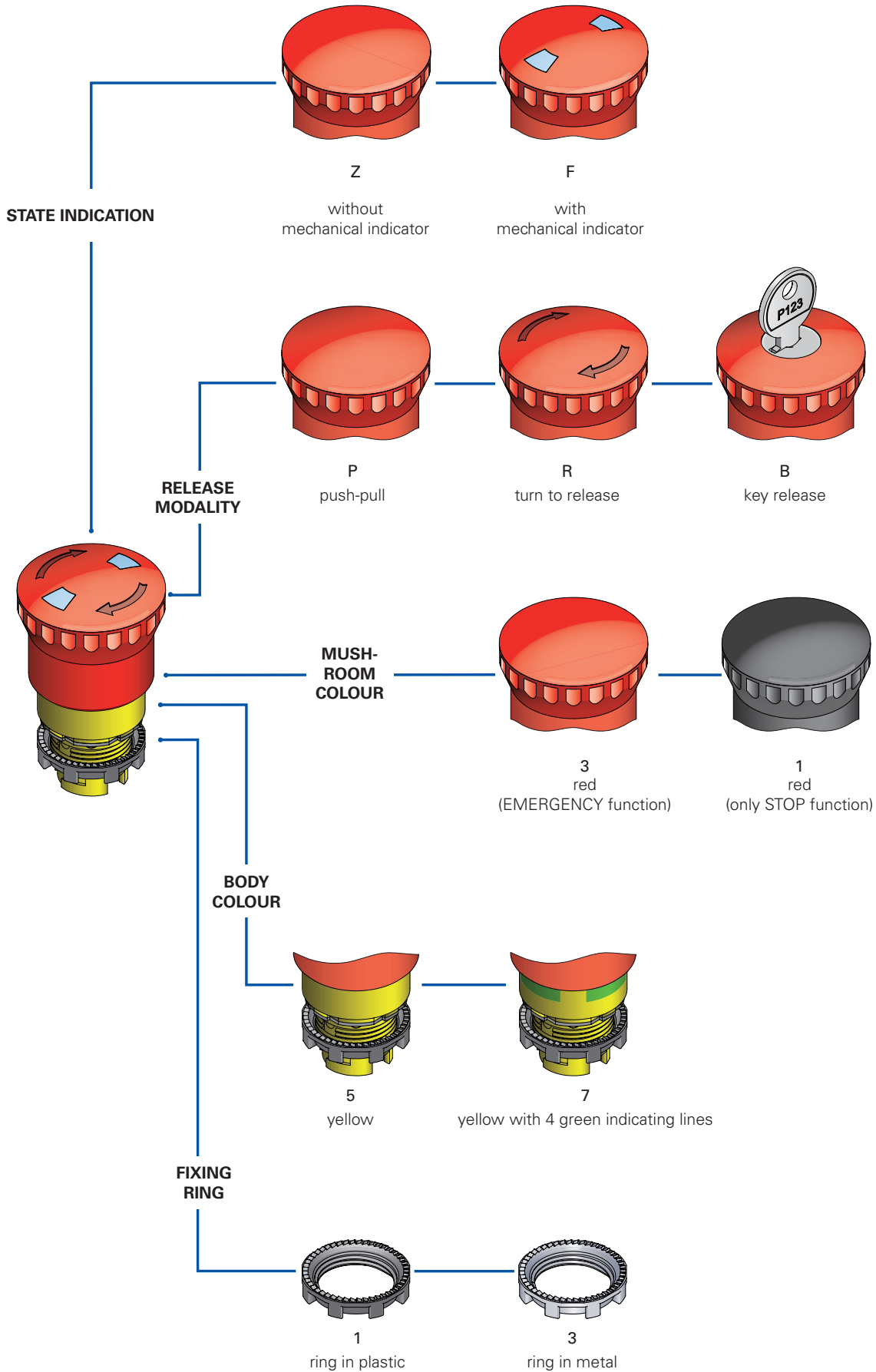

Emergency pushbuttons code structure

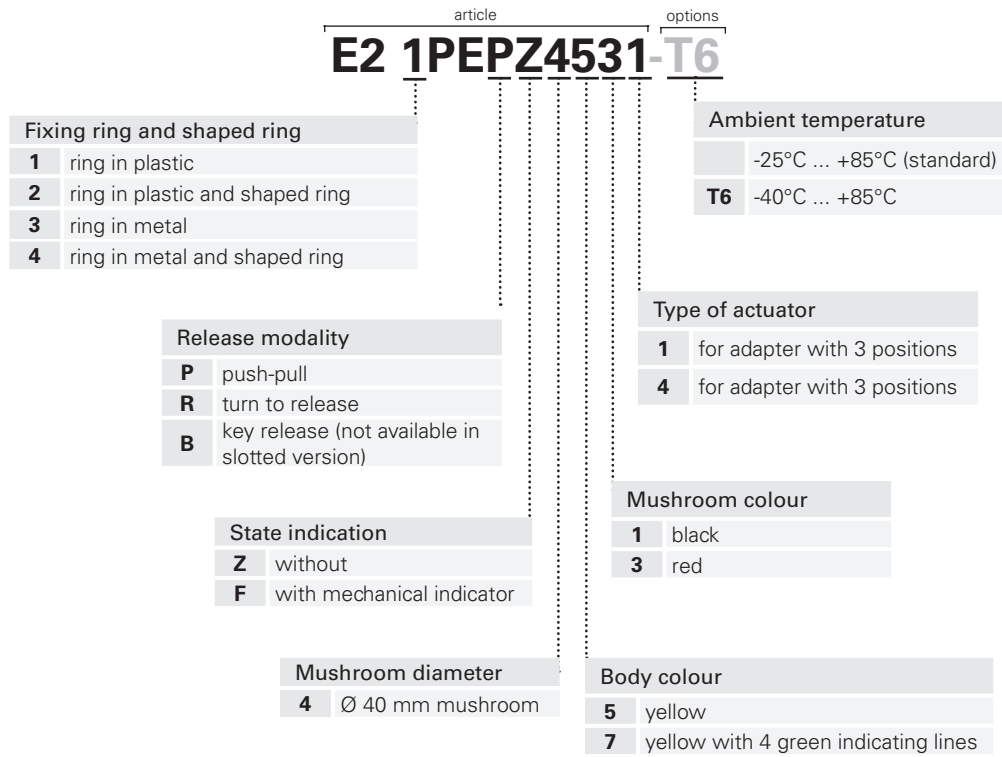

Attention! The feasibility of a code number does not mean the effective availability of a product. Please contact our sales office.



Main features

- Protection degree IP67 and IP69K
- 3 different release modality
- Version with mechanical indicator
- Versions for -40°C

Markings and quality marks:



Approval GOST: POCC IT.AB24.B04512

Technical data

General

Protection degree:	IP67 according to IEC 60529 IP69K according to DIN 40050
Ambient temperature:	-25°C +80°C
Mechanical endurance:	300.000 operations cycles
Max operating frequency:	3600 operations cycles/hour
Actuating travel:	4 mm (NO contact), 4 mm (NC contact)
Actuating force:	25 N
Actuating force at end travel:	Push-pull 18,5 N (without contacts) Turn to release 35 N (without contacts)
Maximum travel:	9 mm
Ring driving torque:	2 ... 2,5 Nm
Utilization requirements:	see page 78

In conformity with standards:

IEC 60947-1, IEC 60947-5-1, IEC 60947-5-5, IEC 60204-1, EN 60947-1, EN 60947-5-1, EN 60947-5-5, EN 60204-1, EN ISO 13850, UL 508, CSA 22-2 N°14

⚠ Installation for safety applications:

Use only switches marked with the symbol ⊕. The safety circuit must always be connected with the **NC contacts** (normally closed contacts: 1-2) as stated in the standard EN 60947-5-1, encl. K, par. 2.

In conformity with requirements requested by:

Low Voltage Directive 2006/95/EC, Machinery Directive 2006/42/EC and Electromagnetic Compatibility 2004/108/EC.

Positive contact opening in conformity with standards:

IEC 60947-5-1, EN 60947-5-1, VDE 0660-206.

General characteristics

State indication

The push-pull and turn to release emergency pushbutton can be provided with a visual state indication through a mechanical indicator. The state is indicated by green colour when the pushbutton is not actuated and red colour when it is actuated.

Mechanical endurance

All emergency pushbuttons have been tested to endure 300.000 mechanical cycles.

Fixing ring

A fixing ring in metal is also available in addition to the fixing ring in technopolymer.

The fixing ring in metal is particularly suitable for those applications which require tighter fitting of the panel-mounted device, such as for example in metal panels having holes without reference notches. Both rings feature a toothed surface which comes into contact with the inside of the panel in order to make it easier for the device to be secured to the actual panel.

Shaped ring

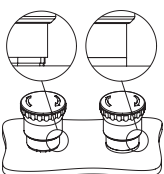

The shaped ring can be used when no label holders or other devices are applied; it prevents dirt and other residues from settling between the pushbutton and the panel or box. This turns out to be particularly useful in the sectors where high standards of cleanness and hygiene are required.

Available versions

Pizzato Elettrica new emergency pushbuttons, which function is to allow the operator to stop a device or a machine in case of danger by pushing the same button, are classified by their release modality: push-pull, turn to release and key release.

Protection degree IP67 and IP69K

IP69K
IP67

Designed to be employed also in severe environment conditions, Pizzato Elettrica pushbuttons have protection degree IP67 and IP69K, suitable for use in machineries subjected to intense washing with high pressure and high temperature water jets.

Temperature range extended





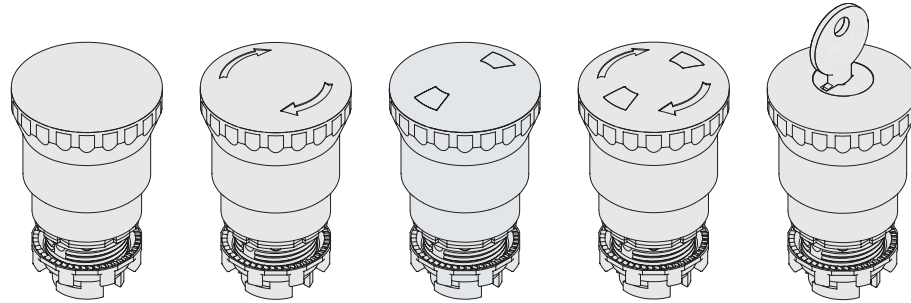

-40°C

Special versions can be ordered for use in environments where the temperature changes from +80°C to -40°C.

They can be installed inside cold stores, sterilizers or other equipments with very low ambient temperature. Special materials that have been used to realize these versions, maintain unchanged their features also in these conditions, widening the installation possibilities.

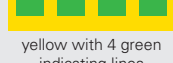
Emergency pushbuttons selection table









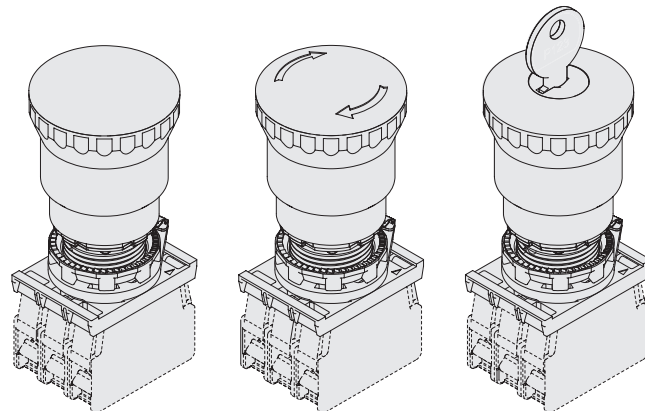







Body colour and marking	Actuator colour and marking	Push-pull	Turn to release	Push-pull with mechanical indicator	Turn to release with mechanical indicator	Release with key Key number PY333
 yellow	 red	E2 1PEPZ4531	E2 1PERZ4531	E2 1PEPF4531	E2 1PERF4531	E2 1PEBZ4531
 yellow with 4 green indicating lines	 red	E2 1PEPZ4731	E2 1PERZ4731	E2 1PEPF4731	E2 1PERF4731	E2 1PEBZ4731
 yellow	 black	E2 1PEPZ4511	E2 1PERZ4511	-	-	E2 1PEBZ4511

Warning! For safety application use only red emergency pushbutton, the black one can be used only for STOP function.

Complete units with emergency pushbuttons



Body colour and marking	Actuator colour and marking	Contacts			Push-pull	Turn to release	Release with key Key number PY333
		pos 2	pos 3	pos 1			
 yellow	 red	-	1NC 	-	E2 AC-DXBC1005 E2 1PEPZ4531 + E2 1BAC11 + E2 CP01G2V1	E2 AC-DXBC1006 E2 1PERZ4531 + E2 1BAC11 + E2 CP01G2V1	E2 AC-DXBC1007 E2 1PEBZ4531 + E2 1BAC11 + E2 CP01G2V1
 yellow	 red	-	1NC  SELF-MONITORED	-	E2 AC-DXBC1022 E2 1PEPZ4531 + E2 1BAC11 + E2 CP01S2V1	E2 AC-DXBC1023 E2 1PERZ4531 + E2 1BAC11 + E2 CP01S2V1	E2 AC-DXBC1024 E2 1PEBZ4531 + E2 1BAC11 + E2 CP01S2V1
 yellow	 red	1NC 	-	1NC 	E2 AC-DXBC1010 E2 1PEPZ4531 + E2 1BAC11 + E2 CP01G2V1 + E2 CP01G2V1	E2 AC-DXBC1002 E2 1PERZ4531 + E2 1BAC11 + E2 CP01G2V1 + E2 CP01G2V1	E2 AC-DXBC1011 E2 1PEBZ4531 + E2 1BAC11 + E2 CP01G2V1 + E2 CP01G2V1
 yellow	 red	1NC 	1NC 	1NO	E2 AC-DXBC1012 E2 1PEPZ4531 + E2 1BAC11 + E2 CP01G2V1 + E2 CP10G2V1	E2 AC-DXBC1000 E2 1PERZ4531 + E2 1BAC11 + E2 CP01G2V1 + E2 CP10G2V1	E2 AC-DXBC1013 E2 1PEBZ4531 + E2 1BAC11 + E2 CP01G2V1 + E2 CP10G2V1

→ For the contact block characteristics see page 41.

Items with code on the **green** background are available in stock

Dimensions

Emergency pushbutton

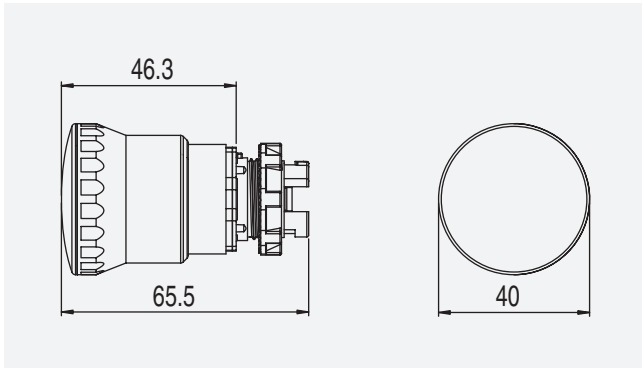

Emergency pushbutton with key

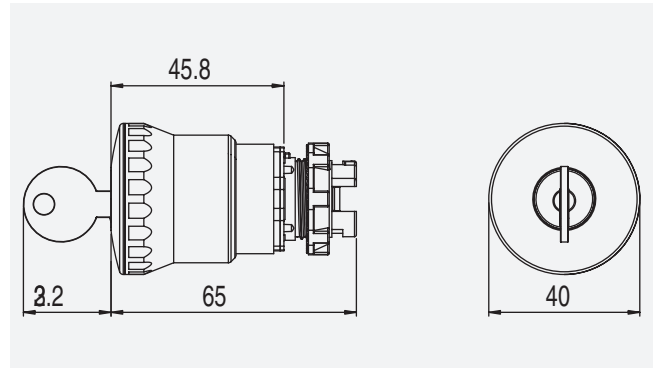

Contacts maximum number

Fixing adapter with 3 positions

Emergency pushbuttons E2 1PE•••••1

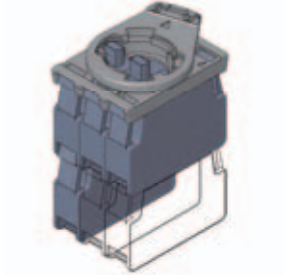

Contacts maximum number: 4

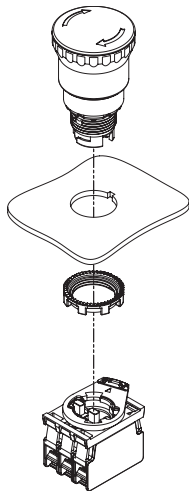

Fixing adapter with 4 positions

Emergency pushbuttons E2 1PE•••••4

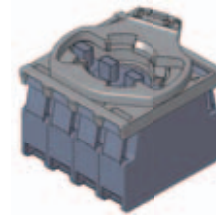

Contacts maximum number: 4

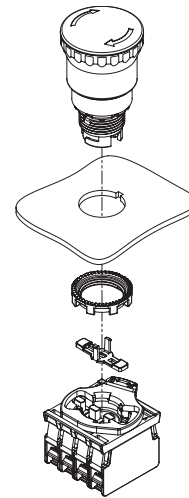

The actuator for an adapter with 4 positions must be mounted after fixing the push-button.



Actuator for adapter with 4 positions 10 pcs packs

	Article	Description
	VE AS1218	Long closed actuator for fixing adapter with 4 positions. It must be installed after fixing the push-button to the wall. For E2 1PE●●●●●● pushbuttons.

Label with shaped hole

5 pcs packs

Suited for the devices E2 1PE●●●●●●.
According to EN ISO 13850.
Adjustable in 90° steps.
Other languages on request.

It does not alter the device protection degrees IP67 and IP69K.

	Article	Description
	VE TF32A5700	Label with shaped hole, Ø 60 mm yellow disc, no writing
	VE TF32D5700	Label with shaped hole, Ø 90 mm yellow disc, no writing
	VE TF32A5101	Label with shaped hole, yellow disc Ø 60 mm, writing: STOP  EMERGENZA 
	VE TF32D5101	Label with shaped hole, yellow disc Ø 90 mm, writing: STOP  EMERGENZA 
	VE TF32A5102	Label with shaped hole, yellow disc Ø 60 mm, writing: EMERGENCY  STOP 
	VE TF32D5102	Label with shaped hole, yellow disc Ø 90 mm, writing: EMERGENCY  STOP 
	VE TF32A5109	Label with shaped hole, yellow disc Ø 60 mm, writing: STOP  STOP  STOP  STOP 
	VE TF32D5109	Label with shaped hole, yellow disc Ø 90 mm, writing: STOP  STOP  STOP  STOP 
	VE TF32A5120	Label with shaped hole, yellow disc Ø 60 mm, writing: STOP EMERGENZA  ARRET D'URGENCE  NOT AUS  EMERGENCY STOP 
	VE TF32D5120	Label with shaped hole, yellow disc Ø 90 mm, writing: STOP EMERGENZA  ARRET D'URGENCE  NOT AUS  EMERGENCY STOP 
	VE TF32G5700	Label with shaped hole, rectangular 30x60 mm, no writing
	VE TF32G5103	Label with shaped hole, rectangular 30x60 mm, writing STOP 

Assembling minimum distances

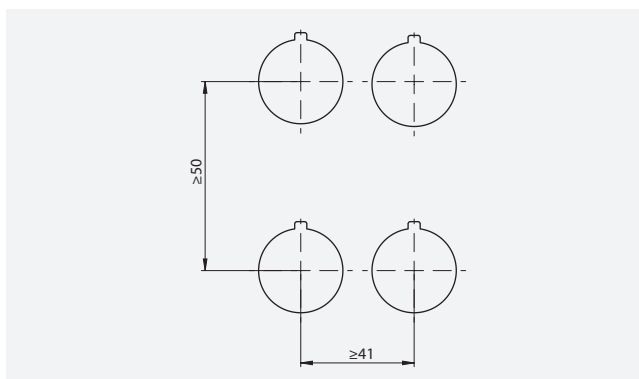

Locking keys

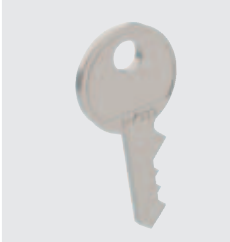
Article	Description
VE KE1A00-PY333	Locking key
	Extra copy of the locking keys to be purchased if further key is needed. All keys have the same code. Other codes on request.

Accessories

→ [More ACCESSORIES at page 75](#)

Items with code on the **green** background are available in stock

Selection diagram

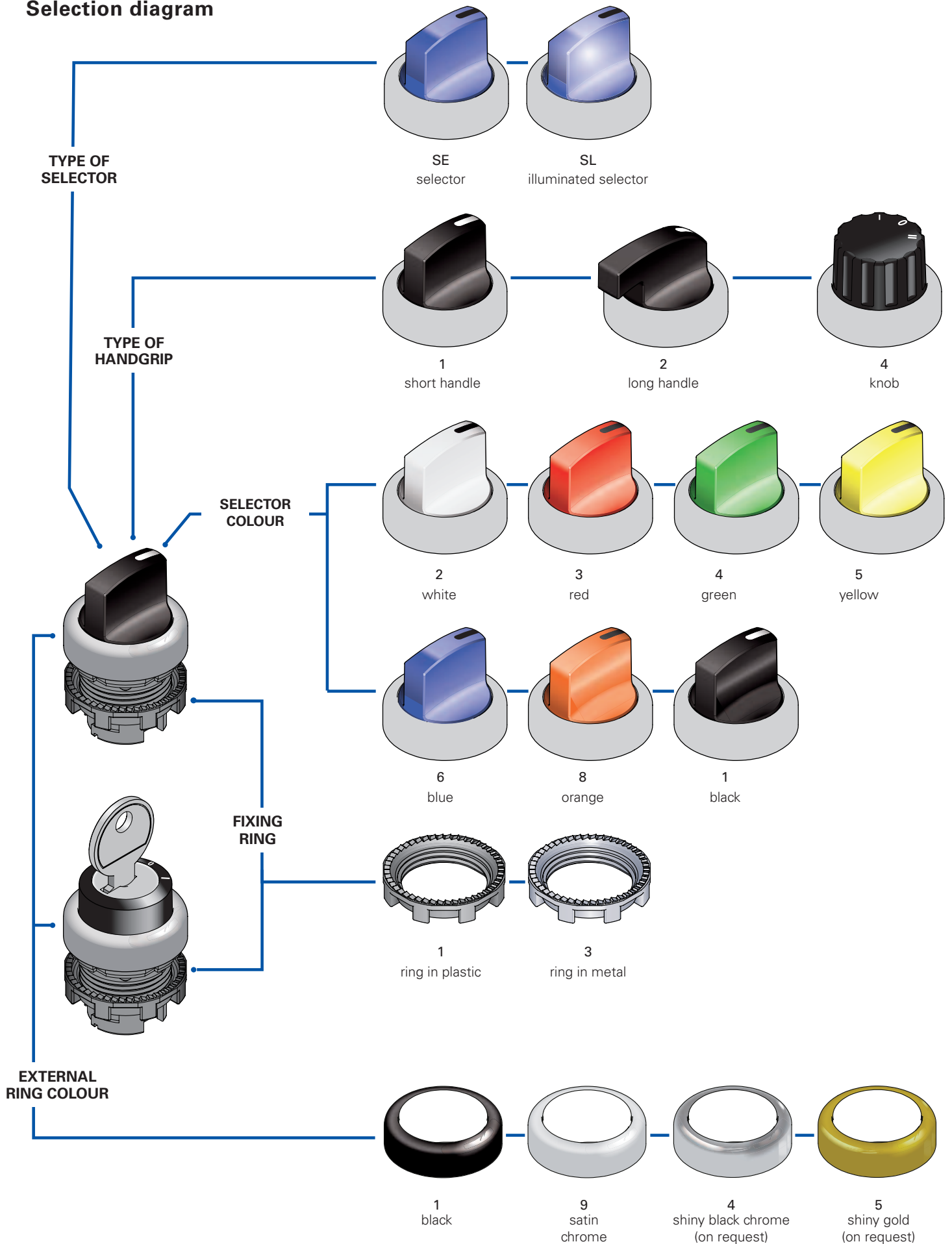

Selectors code structure

E2 1SE13ACE11AB











Fixing ring and shaped ring

- 1 ring in plastic
- 2 ring in plastic and shaped ring
- 3 ring in metal
- 4 ring in metal and shaped ring

Handle

- 1 short handle
- 2 long handle
- 4 knob

Positions

2AV		2AC		3GC	
2EV		2EC			
2FV		3AC			
2FC		3EC			
2BC		3FC			



Cams and actuators

- A** double cam with right wide actuator and left wide actuator (2 positions) for fixing adapter with 3 positions
- E** single cam with right wide actuator and left wide actuator (3 positions) for fixing adapter with 3 positions
- Q** double cam with right wide actuator and left wide actuator (2 positions) for fixing adapter with 4 positions
- R** single cam with right wide actuator and left wide actuator (3 positions) for fixing adapter with 4 positions

Selector colour

- 1 black
- 2 white
- 3 red
- 4 green
- 5 yellow
- 6 blue
- 8 orange

Marking

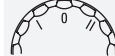
AB		Indication notch (standard)
AC		2 positions knob
AD		3 positions knob

Ring colour

- 1 black (standard)
- 9 satin-finish chrome (standard)
- 4 shiny black chrome (on request)
- 5 shiny gold (on request)

Versions with long handle will be available from 2013.

Illuminated selectors code structure

E2 1SL13ACH21AB











Fixing ring and shaped ring

- 1 ring in plastic
- 2 ring in plastic and shaped ring
- 3 ring in metal
- 4 ring in metal and shaped ring

Handle

- 1 short handle
- 2 long handle
- 4 knob

Positions

2AV		2AC		3GC	
2EV		2EC			
2FV		3AC			
2FC		3EC			
2BC		3FC			



Cams and actuators

- D** double cam with right narrow actuator and left narrow actuator (2 positions)
- H** single cam with right narrow actuator and left narrow actuator (3 positions)

Selector colour

- 2 white
- 3 red
- 4 green
- 5 yellow
- 6 blue
- 8 orange

Marking

AB		Indication notch (standard)
AC		2 positions knob
AD		3 positions knob

Ring colour

- 1 black (standard)
- 9 satin-finish chrome (standard)
- 4 shiny black chrome (on request)
- 5 shiny gold (on request)

Versions with long handle will be available from 2013.





















Key selectors code structure

E2 1SC2ACA11AA

Fixing ring and shaped ring

- 1 ring in plastic
- 2 ring in plastic and shaped ring
- 3 ring in metal
- 4 ring in metal and shaped ring

Positions and key withdrawal

2AV		3BC		3LC	
2BV		3CC		3MC	
2CV		3DC		3NC	
2DV		3EC		3PC	
2AC		3FC		3QC	
2BC		3GC		3RC	
3AC		3HC			



Cams and actuators

- A** double cam with right wide actuator and left wide actuator (2 positions) for fixing adapter with 3 positions
- E** single cam with right wide actuator and left wide actuator (3 positions) for fixing adapter with 3 positions
- Q** double cam with right wide actuator and left wide actuator (2 positions) for fixing adapter with 4 positions
- R** single cam with right wide actuator and left wide actuator (3 positions) for fixing adapter with 4 positions

Selector colour



- 1 black

Marking

AA	without marking (standard)
AC	 2 positions selectors
AD	 3 positions selectors
AE	 V selectors

Ring colour

- 1 black (standard)
- 9 satin-finish chrome (standard)
- 4 shiny black chrome (on request)
- 5 shiny gold (on request)

Legend:  Stay-pull  Spring-return  Key withdrawal position

Attention! The feasibility of a code number does not mean the effective availability of a product. Please contact our sales office.



Main features

- Protection degree IP67 and IP69K
- 4 different shapes
- Standard or illuminated versions
- Stay-put or spring-return versions

Markings and quality marks:



Approval GOST: POCC IT.AB24.B04512



Technical data

General data

Protection degree:	IP67 according to IEC 60529 IP69K according to DIN 40050
Ambient temperature:	-25°C +80°C
Mechanical endurance:	1 million operations cycles (SE, SL series) 0,3 million operations cycles (SC series)
Max operating frequency:	3600 operations cycles/hour
Actuating force at end travel:	0,07 Nm (without contacts)
Maximum travel:	60° (2 stay-put positions) 40° (2 spring-return positions) ±60° (3 stay-put positions) ±40° (3 spring-return positions)
Ring driving torque:	2 ... 2,5 Nm
Utilization requirements:	see page 78

In conformity with standards:

IEC 60947-1, IEC 60947-5-1, IEC 60204-1, EN 60947-1, EN 60947-5-1, EN 60204-1, UL 508, CSA 22-2 N°14

⚠ Installation for safety applications:

Use only switches marked with the symbol ⊕. The safety circuit must always be connected with the **NC contacts** (normally closed contacts: 1-2) as stated in the standard EN 60947-5-1, encl. K, par. 2.

In conformity with requirements requested by:

Low Voltage Directive 2006/95/EC, Machinery Directive 2006/42/EC and Electromagnetic Compatibility 2004/108/EC.

Positive contact opening in conformity with standards:

IEC 60947-5-1, EN 60947-5-1, VDE 0660-206.

General characteristics

Protection degree IP67 and IP69K

IP69K IP67

Designed to be employed also in severe environment conditions, Pizzato Elettrica pushbuttons have protection degree IP67 and IP69K, suitable for use in machineries subjected to intense washing with high pressure and high temperature water jets.

Fixing ring

A fixing ring in metal is also available in addition to the fixing ring in technopolymer.

The fixing ring in metal is particularly suitable for those applications which require tighter fitting of the panel-mounted device, such as for example in metal panels having holes without reference notches. Both rings feature a toothed surface which comes into contact with the inside of the panel in order to make it easier for the device to be secured to the actual panel.

Shaped ring

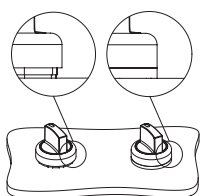

The shaped ring can be used when no label holders or other devices are applied; it prevents dirt and other residues from settling between the pushbutton and the panel or box. This turns out to be particularly useful in the sectors where high standards of cleanness and hygiene are required.

Selectors actuators

There are 3 types of actuators which work on the contacts wipers combined with the selector: a white actuator which allows the commutation of a single contact block and a black or gray actuator which simultaneously commutes 2 side by side contact blocks. White, black (3 positions) and gray (4 positions) actuators can be disassembled and removed any time, this way allowing to freely configure the commutation exercised by the selector on the contacts.

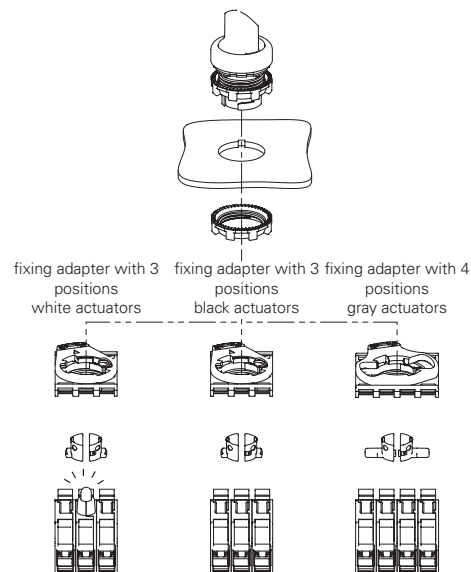

Selectors selection table

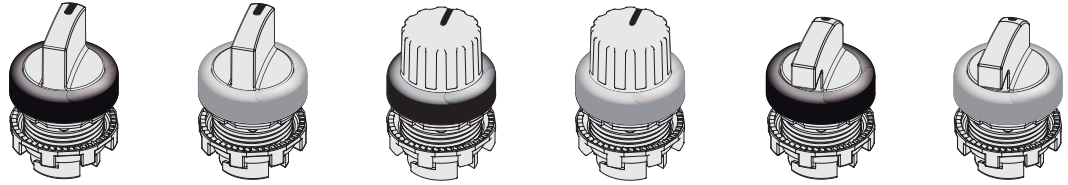

Actuator colour and marking	2 positions	short handle		knob		long handle	
		black ring	satin chrome ring	black ring	satin chrome ring	black ring	satin chrome ring
black	✓	E2 1SE12AVA11AB	E2 1SE12AVA19AB	E2 1SE42AVA11AB	E2 1SE42AVA19AB	E2 1SE22AVA11AB	E2 1SE22AVA19AB
white	✓	E2 1SE12AVA21AB	E2 1SE12AVA29AB	E2 1SE42AVA21AB	E2 1SE42AVA29AB	E2 1SE22AVA21AB	E2 1SE22AVA29AB
red	✓	E2 1SE12AVA31AB	E2 1SE12AVA39AB	E2 1SE42AVA31AB	E2 1SE42AVA39AB	E2 1SE22AVA31AB	E2 1SE22AVA39AB
green	✓	E2 1SE12AVA41AB	E2 1SE12AVA49AB	E2 1SE42AVA41AB	E2 1SE42AVA49AB	E2 1SE22AVA41AB	E2 1SE22AVA49AB
yellow	✓	E2 1SE12AVA51AB	E2 1SE12AVA59AB	E2 1SE42AVA51AB	E2 1SE42AVA59AB	E2 1SE22AVA51AB	E2 1SE22AVA59AB
blue	✓	E2 1SE12AVA61AB	E2 1SE12AVA69AB	E2 1SE42AVA61AB	E2 1SE42AVA69AB	E2 1SE22AVA61AB	E2 1SE22AVA69AB
orange	✓	E2 1SE12AVA81AB	E2 1SE12AVA89AB	E2 1SE42AVA81AB	E2 1SE42AVA89AB	E2 1SE22AVA81AB	E2 1SE22AVA89AB
black	↘	E2 1SE12EVA11AB	E2 1SE12EVA19AB	E2 1SE42EVA11AB	E2 1SE42EVA19AB	E2 1SE22EVA11AB	E2 1SE22EVA19AB
white	↘	E2 1SE12EVA21AB	E2 1SE12EVA29AB	E2 1SE42EVA21AB	E2 1SE42EVA29AB	E2 1SE22EVA21AB	E2 1SE22EVA29AB
red	↘	E2 1SE12EVA31AB	E2 1SE12EVA39AB	E2 1SE42EVA31AB	E2 1SE42EVA39AB	E2 1SE22EVA31AB	E2 1SE22EVA39AB
green	↘	E2 1SE12EVA41AB	E2 1SE12EVA49AB	E2 1SE42EVA41AB	E2 1SE42EVA49AB	E2 1SE22EVA41AB	E2 1SE22EVA49AB
yellow	↘	E2 1SE12EVA51AB	E2 1SE12EVA59AB	E2 1SE42EVA51AB	E2 1SE42EVA59AB	E2 1SE22EVA51AB	E2 1SE22EVA59AB
blue	↘	E2 1SE12EVA61AB	E2 1SE12EVA69AB	E2 1SE42EVA61AB	E2 1SE42EVA69AB	E2 1SE22EVA61AB	E2 1SE22EVA69AB
orange	↘	E2 1SE12EVA81AB	E2 1SE12EVA89AB	E2 1SE42EVA81AB	E2 1SE42EVA89AB	E2 1SE22EVA81AB	E2 1SE22EVA89AB
black	✓	E2 1SE12ACA11AB	E2 1SE12ACA19AB	E2 1SE42ACA11AB	E2 1SE42ACA19AB	E2 1SE22ACA11AB	E2 1SE22ACA19AB
white	✓	E2 1SE12ACA21AB	E2 1SE12ACA29AB	E2 1SE42ACA21AB	E2 1SE42ACA29AB	E2 1SE22ACA21AB	E2 1SE22ACA29AB
red	✓	E2 1SE12ACA31AB	E2 1SE12ACA39AB	E2 1SE42ACA31AB	E2 1SE42ACA39AB	E2 1SE22ACA31AB	E2 1SE22ACA39AB
green	✓	E2 1SE12ACA41AB	E2 1SE12ACA49AB	E2 1SE42ACA41AB	E2 1SE42ACA49AB	E2 1SE22ACA41AB	E2 1SE22ACA49AB
yellow	✓	E2 1SE12ACA51AB	E2 1SE12ACA59AB	E2 1SE42ACA51AB	E2 1SE42ACA59AB	E2 1SE22ACA51AB	E2 1SE22ACA59AB
blue	✓	E2 1SE12ACA61AB	E2 1SE12ACA69AB	E2 1SE42ACA61AB	E2 1SE42ACA69AB	E2 1SE22ACA61AB	E2 1SE22ACA69AB
orange	✓	E2 1SE12ACA81AB	E2 1SE12ACA89AB	E2 1SE42ACA81AB	E2 1SE42ACA89AB	E2 1SE22ACA81AB	E2 1SE22ACA89AB
black	▷	E2 1SE12ECA11AB	E2 1SE12ECA19AB	E2 1SE42ECA11AB	E2 1SE42ECA19AB	E2 1SE22ECA11AB	E2 1SE22ECA19AB
white	▷	E2 1SE12ECA21AB	E2 1SE12ECA29AB	E2 1SE42ECA21AB	E2 1SE42ECA29AB	E2 1SE22ECA21AB	E2 1SE22ECA29AB
red	▷	E2 1SE12ECA31AB	E2 1SE12ECA39AB	E2 1SE42ECA31AB	E2 1SE42ECA39AB	E2 1SE22ECA31AB	E2 1SE22ECA39AB
green	▷	E2 1SE12ECA41AB	E2 1SE12ECA49AB	E2 1SE42ECA41AB	E2 1SE42ECA49AB	E2 1SE22ECA41AB	E2 1SE22ECA49AB
yellow	▷	E2 1SE12ECA51AB	E2 1SE12ECA59AB	E2 1SE42ECA51AB	E2 1SE42ECA59AB	E2 1SE22ECA51AB	E2 1SE22ECA59AB
blue	▷	E2 1SE12ECA61AB	E2 1SE12ECA69AB	E2 1SE42ECA61AB	E2 1SE42ECA69AB	E2 1SE22ECA61AB	E2 1SE22ECA69AB
orange	▷	E2 1SE12ECA81AB	E2 1SE12ECA89AB	E2 1SE42ECA81AB	E2 1SE42ECA89AB	E2 1SE22ECA81AB	E2 1SE22ECA89AB

Fixing adapter with 3 positions

Fixing adapter with 4 positions

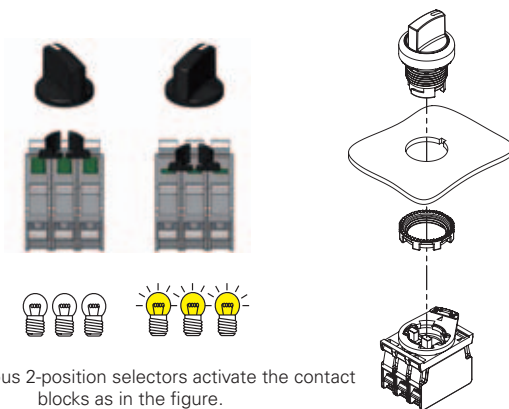

Non-luminous 2-position selectors activate the contact blocks as in the figure.

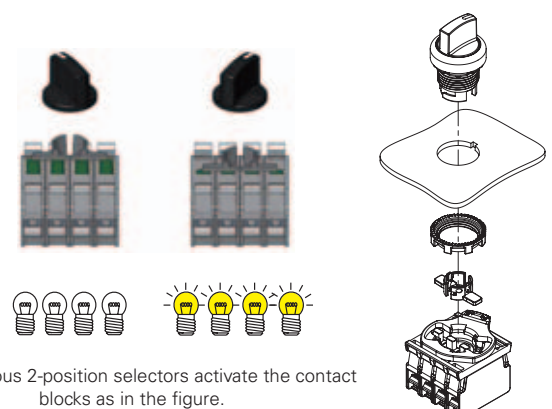

Non-luminous 2-position selectors activate the contact blocks as in the figure.

The actuators for an adapter with 4 positions must be mounted after fixing the selector.

Legend: ✓ Stay-put ▷ Spring-return

Knob selectors can be customized with inscriptions and symbols.

Items with code on the **green** background are available in stock

Selectors selection table

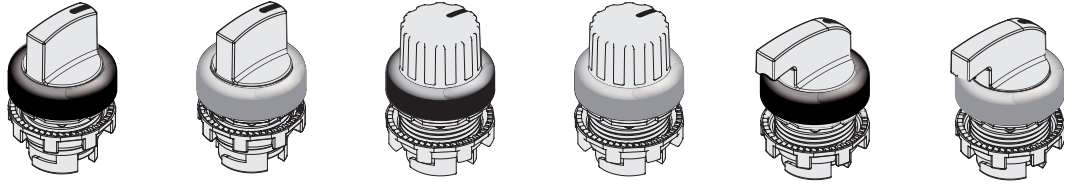

Actuator colour and marking	3 positions	short handle		knob		long handle	
		black ring	satin chrome ring	black ring	satin chrome ring	black ring	satin chrome ring
● black	↙	E2 1SE13ACE11AB	E2 1SE13ACE19AB	E2 1SE43ACE11AB	E2 1SE43ACE19AB	E2 1SE23ACE11AB	E2 1SE23ACE19AB
○ white	↙	E2 1SE13ACE21AB	E2 1SE13ACE29AB	E2 1SE43ACE21AB	E2 1SE43ACE29AB	E2 1SE23ACE21AB	E2 1SE23ACE29AB
● red	↙	E2 1SE13ACE31AB	E2 1SE13ACE39AB	E2 1SE43ACE31AB	E2 1SE43ACE39AB	E2 1SE23ACE31AB	E2 1SE23ACE39AB
● green	↙	E2 1SE13ACE41AB	E2 1SE13ACE49AB	E2 1SE43ACE41AB	E2 1SE43ACE49AB	E2 1SE23ACE41AB	E2 1SE23ACE49AB
● yellow	↙	E2 1SE13ACE51AB	E2 1SE13ACE59AB	E2 1SE43ACE51AB	E2 1SE43ACE59AB	E2 1SE23ACE51AB	E2 1SE23ACE59AB
● blue	↙	E2 1SE13ACE61AB	E2 1SE13ACE69AB	E2 1SE43ACE61AB	E2 1SE43ACE69AB	E2 1SE23ACE61AB	E2 1SE23ACE69AB
● orange	↙	E2 1SE13ACE81AB	E2 1SE13ACE89AB	E2 1SE43ACE81AB	E2 1SE43ACE89AB	E2 1SE23ACE81AB	E2 1SE23ACE89AB
● black	↘	E2 1SE13ECE11AB	E2 1SE13ECE19AB	E2 1SE43ECE11AB	E2 1SE43ECE19AB	E2 1SE23ECE11AB	E2 1SE23ECE19AB
○ white	↘	E2 1SE13ECE21AB	E2 1SE13ECE29AB	E2 1SE43ECE21AB	E2 1SE43ECE29AB	E2 1SE23ECE21AB	E2 1SE23ECE29AB
● red	↘	E2 1SE13ECE31AB	E2 1SE13ECE39AB	E2 1SE43ECE31AB	E2 1SE43ECE39AB	E2 1SE23ECE31AB	E2 1SE23ECE39AB
● green	↘	E2 1SE13ECE41AB	E2 1SE13ECE49AB	E2 1SE43ECE41AB	E2 1SE43ECE49AB	E2 1SE23ECE41AB	E2 1SE23ECE49AB
● yellow	↘	E2 1SE13ECE51AB	E2 1SE13ECE59AB	E2 1SE43ECE51AB	E2 1SE43ECE59AB	E2 1SE23ECE51AB	E2 1SE23ECE59AB
● blue	↘	E2 1SE13ECE61AB	E2 1SE13ECE69AB	E2 1SE43ECE61AB	E2 1SE43ECE69AB	E2 1SE23ECE61AB	E2 1SE23ECE69AB
● orange	↘	E2 1SE13ECE81AB	E2 1SE13ECE89AB	E2 1SE43ECE81AB	E2 1SE43ECE89AB	E2 1SE23ECE81AB	E2 1SE23ECE89AB
● black	↔	E2 1SE13FCE11AB	E2 1SE13FCE19AB	E2 1SE43FCE11AB	E2 1SE43FCE19AB	E2 1SE23FCE11AB	E2 1SE23FCE19AB
○ white	↔	E2 1SE13FCE21AB	E2 1SE13FCE29AB	E2 1SE43FCE21AB	E2 1SE43FCE29AB	E2 1SE23FCE21AB	E2 1SE23FCE29AB
● red	↔	E2 1SE13FCE31AB	E2 1SE13FCE39AB	E2 1SE43FCE31AB	E2 1SE43FCE39AB	E2 1SE23FCE31AB	E2 1SE23FCE39AB
● green	↔	E2 1SE13FCE41AB	E2 1SE13FCE49AB	E2 1SE43FCE41AB	E2 1SE43FCE49AB	E2 1SE23FCE41AB	E2 1SE23FCE49AB
● yellow	↔	E2 1SE13FCE51AB	E2 1SE13FCE59AB	E2 1SE43FCE51AB	E2 1SE43FCE59AB	E2 1SE23FCE51AB	E2 1SE23FCE59AB
● blue	↔	E2 1SE13FCE61AB	E2 1SE13FCE69AB	E2 1SE43FCE61AB	E2 1SE43FCE69AB	E2 1SE23FCE61AB	E2 1SE23FCE69AB
● orange	↔	E2 1SE13FCE81AB	E2 1SE13FCE89AB	E2 1SE43FCE81AB	E2 1SE43FCE89AB	E2 1SE23FCE81AB	E2 1SE23FCE89AB
● black	↔	E2 1SE13GCE11AB	E2 1SE13GCE19AB	E2 1SE43GCE11AB	E2 1SE43GCE19AB	E2 1SE23GCE11AB	E2 1SE23GCE19AB
○ white	↔	E2 1SE13GCE21AB	E2 1SE13GCE29AB	E2 1SE43GCE21AB	E2 1SE43GCE29AB	E2 1SE23GCE21AB	E2 1SE23GCE29AB
● red	↔	E2 1SE13GCE31AB	E2 1SE13GCE39AB	E2 1SE43GCE31AB	E2 1SE43GCE39AB	E2 1SE23GCE31AB	E2 1SE23GCE39AB
● green	↔	E2 1SE13GCE41AB	E2 1SE13GCE49AB	E2 1SE43GCE41AB	E2 1SE43GCE49AB	E2 1SE23GCE41AB	E2 1SE23GCE49AB
● yellow	↔	E2 1SE13GCE51AB	E2 1SE13GCE59AB	E2 1SE43GCE51AB	E2 1SE43GCE59AB	E2 1SE23GCE51AB	E2 1SE23GCE59AB
● blue	↔	E2 1SE13GCE61AB	E2 1SE13GCE69AB	E2 1SE43GCE61AB	E2 1SE43GCE69AB	E2 1SE23GCE61AB	E2 1SE23GCE69AB
● orange	↔	E2 1SE13GCE81AB	E2 1SE13GCE89AB	E2 1SE43GCE81AB	E2 1SE43GCE89AB	E2 1SE23GCE81AB	E2 1SE23GCE89AB

Fixing adapter with 3 positions

Fixing adapter with 4 positions

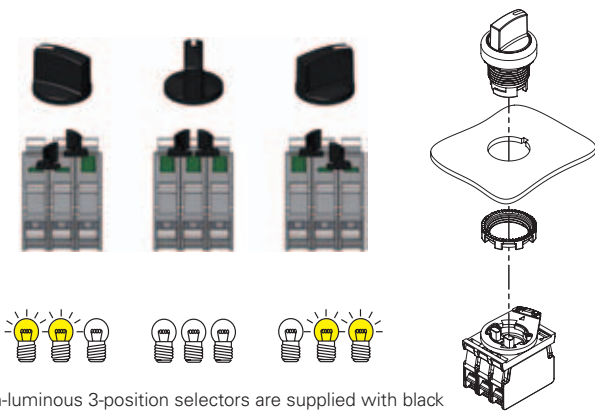

Non-luminous 3-position selectors are supplied with black actuators which activate the contact blocks as in the figure.

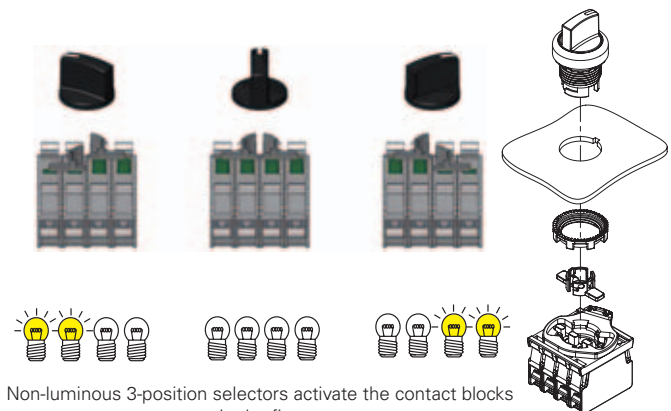

Non-luminous 3-position selectors activate the contact blocks as in the figure.

The actuators for an adapter with 4 positions must be mounted after fixing the selector.

Legend: ↙ Stay-put ↘ Spring-return

Knob selectors can be customized with inscriptions and symbols.

Items with code on the **green** background are available in stock

Illuminated selectors selection table

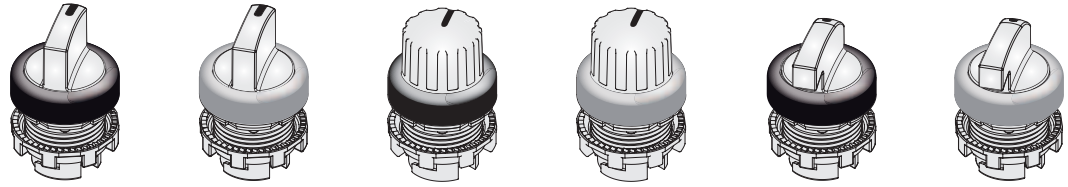

Actuator colour and marking	2 positions	short handle		knob		long handle	
		black ring	satin chrome ring	black ring	satin chrome ring	black ring	satin chrome ring
white	∨	E2 1SL12AVD21AB	E2 1SL12AVD29AB	E2 1SL42AVD21AB	E2 1SL42AVD29AB	E2 1SL22AVD21AB	E2 1SL22AVD29AB
red	∨	E2 1SL12AVD31AB	E2 1SL12AVD39AB	E2 1SL42AVD31AB	E2 1SL42AVD39AB	E2 1SL22AVD31AB	E2 1SL22AVD39AB
green	∨	E2 1SL12AVD41AB	E2 1SL12AVD49AB	E2 1SL42AVD41AB	E2 1SL42AVD49AB	E2 1SL22AVD41AB	E2 1SL22AVD49AB
yellow	∨	E2 1SL12AVD51AB	E2 1SL12AVD59AB	E2 1SL42AVD51AB	E2 1SL42AVD59AB	E2 1SL22AVD51AB	E2 1SL22AVD59AB
blue	∨	E2 1SL12AVD61AB	E2 1SL12AVD69AB	E2 1SL42AVD61AB	E2 1SL42AVD69AB	E2 1SL22AVD61AB	E2 1SL22AVD69AB
orange	∨	E2 1SL12AVD81AB	E2 1SL12AVD89AB	E2 1SL42AVD81AB	E2 1SL42AVD89AB	E2 1SL22AVD81AB	E2 1SL22AVD89AB
white	∨	E2 1SL12EVD21AB	E2 1SL12EVD29AB	E2 1SL42EVD21AB	E2 1SL42EVD29AB	E2 1SL22EVD21AB	E2 1SL22EVD29AB
red	∨	E2 1SL12EVD31AB	E2 1SL12EVD39AB	E2 1SL42EVD31AB	E2 1SL42EVD39AB	E2 1SL22EVD31AB	E2 1SL22EVD39AB
verde	∨	E2 1SL12EVD41AB	E2 1SL12EVD49AB	E2 1SL42EVD41AB	E2 1SL42EVD49AB	E2 1SL22EVD41AB	E2 1SL22EVD49AB
yellow	∨	E2 1SL12EVD51AB	E2 1SL12EVD59AB	E2 1SL42EVD51AB	E2 1SL42EVD59AB	E2 1SL22EVD51AB	E2 1SL22EVD59AB
blue	∨	E2 1SL12EVD61AB	E2 1SL12EVD69AB	E2 1SL42EVD61AB	E2 1SL42EVD69AB	E2 1SL22EVD61AB	E2 1SL22EVD69AB
orange	∨	E2 1SL12EVD81AB	E2 1SL12EVD89AB	E2 1SL42EVD81AB	E2 1SL42EVD89AB	E2 1SL22EVD81AB	E2 1SL22EVD89AB
white	∨	E2 1SL12ACD21AB	E2 1SL12ACD29AB	E2 1SL42ACD21AB	E2 1SL42ACD29AB	E2 1SL22ACD21AB	E2 1SL22ACD29AB
red	∨	E2 1SL12ACD31AB	E2 1SL12ACD39AB	E2 1SL42ACD31AB	E2 1SL42ACD39AB	E2 1SL22ACD31AB	E2 1SL22ACD39AB
verde	∨	E2 1SL12ACD41AB	E2 1SL12ACD49AB	E2 1SL42ACD41AB	E2 1SL42ACD49AB	E2 1SL22ACD41AB	E2 1SL22ACD49AB
yellow	∨	E2 1SL12ACD51AB	E2 1SL12ACD59AB	E2 1SL42ACD51AB	E2 1SL42ACD59AB	E2 1SL22ACD51AB	E2 1SL22ACD59AB
blue	∨	E2 1SL12ACD61AB	E2 1SL12ACD69AB	E2 1SL42ACD61AB	E2 1SL42ACD69AB	E2 1SL22ACD61AB	E2 1SL22ACD69AB
orange	∨	E2 1SL12ACD81AB	E2 1SL12ACD89AB	E2 1SL42ACD81AB	E2 1SL42ACD89AB	E2 1SL22ACD81AB	E2 1SL22ACD89AB
white	▷	E2 1SL12ECD21AB	E2 1SL12ECD29AB	E2 1SL42ECD21AB	E2 1SL42ECD29AB	E2 1SL22ECD21AB	E2 1SL22ECD29AB
red	▷	E2 1SL12ECD31AB	E2 1SL12ECD39AB	E2 1SL42ECD31AB	E2 1SL42ECD39AB	E2 1SL22ECD31AB	E2 1SL22ECD39AB
verde	▷	E2 1SL12ECD41AB	E2 1SL12ECD49AB	E2 1SL42ECD41AB	E2 1SL42ECD49AB	E2 1SL22ECD41AB	E2 1SL22ECD49AB
yellow	▷	E2 1SL12ECD51AB	E2 1SL12ECD59AB	E2 1SL42ECD51AB	E2 1SL42ECD59AB	E2 1SL22ECD51AB	E2 1SL22ECD59AB
blue	▷	E2 1SL12ECD61AB	E2 1SL12ECD69AB	E2 1SL42ECD61AB	E2 1SL42ECD69AB	E2 1SL22ECD61AB	E2 1SL22ECD69AB
orange	▷	E2 1SL12ECD81AB	E2 1SL12ECD89AB	E2 1SL42ECD81AB	E2 1SL42ECD89AB	E2 1SL22ECD81AB	E2 1SL22ECD89AB

Fixing adapter with 3 positions

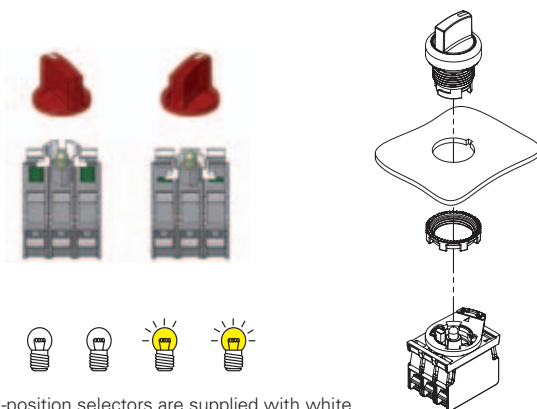

Luminous 2-position selectors are supplied with white actuators which activate the contact blocks as in the figure.

Legend: ∨ Stay-put ▷ Spring-return

Knob selectors can be customized with inscriptions and symbols.

Items with code on the **green** background are available in stock

Illuminated selectors selection table

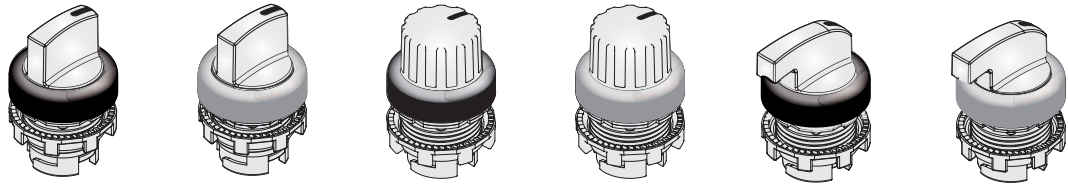

Actuator colour and marking	3 positions	short handle		knob		long handle	
		black ring	satin chrome ring	black ring	satin chrome ring	black ring	satin chrome ring
white	↙	E2 1SL13ACH21AB	E2 1SL13ACH29AB	E2 1SL43ACH21AB	E2 1SL43ACH29AB	E2 1SL23ACH21AB	E2 1SL23ACH29AB
red	↙	E2 1SL13ACH31AB	E2 1SL13ACH39AB	E2 1SL43ACH31AB	E2 1SL43ACH39AB	E2 1SL23ACH31AB	E2 1SL23ACH39AB
green	↙	E2 1SL13ACH41AB	E2 1SL13ACH49AB	E2 1SL43ACH41AB	E2 1SL43ACH49AB	E2 1SL23ACH41AB	E2 1SL23ACH49AB
yellow	↙	E2 1SL13ACH51AB	E2 1SL13ACH59AB	E2 1SL43ACH51AB	E2 1SL43ACH59AB	E2 1SL23ACH51AB	E2 1SL23ACH59AB
blue	↙	E2 1SL13ACH61AB	E2 1SL13ACH69AB	E2 1SL43ACH61AB	E2 1SL43ACH69AB	E2 1SL23ACH61AB	E2 1SL23ACH69AB
orange	↙	E2 1SL13ACH81AB	E2 1SL13ACH89AB	E2 1SL43ACH81AB	E2 1SL43ACH89AB	E2 1SL23ACH81AB	E2 1SL23ACH89AB
white	↘	E2 1SL13ECH21AB	E2 1SL13ECH29AB	E2 1SL43ECH21AB	E2 1SL43ECH29AB	E2 1SL23ECH21AB	E2 1SL23ECH29AB
red	↘	E2 1SL13ECH31AB	E2 1SL13ECH39AB	E2 1SL43ECH31AB	E2 1SL43ECH39AB	E2 1SL23ECH31AB	E2 1SL23ECH39AB
verde	↘	E2 1SL13ECH41AB	E2 1SL13ECH49AB	E2 1SL43ECH41AB	E2 1SL43ECH49AB	E2 1SL23ECH41AB	E2 1SL23ECH49AB
yellow	↘	E2 1SL13ECH51AB	E2 1SL13ECH59AB	E2 1SL43ECH51AB	E2 1SL43ECH59AB	E2 1SL23ECH51AB	E2 1SL23ECH59AB
blue	↘	E2 1SL13ECH61AB	E2 1SL13ECH69AB	E2 1SL43ECH61AB	E2 1SL43ECH69AB	E2 1SL23ECH61AB	E2 1SL23ECH69AB
orange	↘	E2 1SL13ECH81AB	E2 1SL13ECH89AB	E2 1SL43ECH81AB	E2 1SL43ECH89AB	E2 1SL23ECH81AB	E2 1SL23ECH89AB
white	↔	E2 1SL13FCH21AB	E2 1SL13FCH29AB	E2 1SL43FCH21AB	E2 1SL43FCH29AB	E2 1SL23FCH21AB	E2 1SL23FCH29AB
red	↔	E2 1SL13FCH31AB	E2 1SL13FCH39AB	E2 1SL43FCH31AB	E2 1SL43FCH39AB	E2 1SL23FCH31AB	E2 1SL23FCH39AB
verde	↔	E2 1SL13FCH41AB	E2 1SL13FCH49AB	E2 1SL43FCH41AB	E2 1SL43FCH49AB	E2 1SL23FCH41AB	E2 1SL23FCH49AB
yellow	↔	E2 1SL13FCH51AB	E2 1SL13FCH59AB	E2 1SL43FCH51AB	E2 1SL43FCH59AB	E2 1SL23FCH51AB	E2 1SL23FCH59AB
blue	↔	E2 1SL13FCH61AB	E2 1SL13FCH69AB	E2 1SL43FCH61AB	E2 1SL43FCH69AB	E2 1SL23FCH61AB	E2 1SL23FCH69AB
orange	↔	E2 1SL13FCH81AB	E2 1SL13FCH89AB	E2 1SL43FCH81AB	E2 1SL43FCH89AB	E2 1SL23FCH81AB	E2 1SL23FCH89AB
white	↔	E2 1SL13GCH21AB	E2 1SL13GCH29AB	E2 1SL43GCH21AB	E2 1SL43GCH29AB	E2 1SL23GCH21AB	E2 1SL23GCH29AB
red	↔	E2 1SL13GCH31AB	E2 1SL13GCH39AB	E2 1SL43GCH31AB	E2 1SL43GCH39AB	E2 1SL23GCH31AB	E2 1SL23GCH39AB
verde	↔	E2 1SL13GCH41AB	E2 1SL13GCH49AB	E2 1SL43GCH41AB	E2 1SL43GCH49AB	E2 1SL23GCH41AB	E2 1SL23GCH49AB
yellow	↔	E2 1SL13GCH51AB	E2 1SL13GCH59AB	E2 1SL43GCH51AB	E2 1SL43GCH59AB	E2 1SL23GCH51AB	E2 1SL23GCH59AB
blue	↔	E2 1SL13GCH61AB	E2 1SL13GCH69AB	E2 1SL43GCH61AB	E2 1SL43GCH69AB	E2 1SL23GCH61AB	E2 1SL23GCH69AB
orange	↔	E2 1SL13GCH81AB	E2 1SL13GCH89AB	E2 1SL43GCH81AB	E2 1SL43GCH89AB	E2 1SL23GCH81AB	E2 1SL23GCH89AB

Fixing adapter with 3 positions

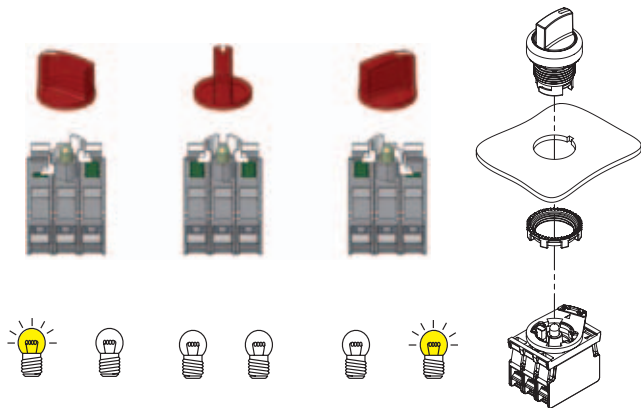

Luminous 3-position selectors are supplied with white actuators which activate the contact blocks as in the figure.





Legend: ↙ Stay-put ↘ Spring-return

Knob selectors can be customized with inscriptions and symbols.

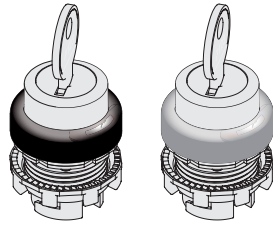
Items with code on the **green** background are available in stock

Key selectors selection table



Actuator colour and marking	2 positions	key selector	
		black ring	satin chrome ring
● black		E2 1SC2AVA11AA	E2 1SC2AVA19AA
		E2 1SC2BVA11AA	E2 1SC2BVA19AA
		E2 1SC2CVA11AA	E2 1SC2CVA19AA
		E2 1SC2DVA11AA	E2 1SC2DVA19AA
		E2 1SC2ACA11AA	E2 1SC2ACA19AA

Selector standard colour in above mentioned codes is **BLACK**. Other colours on request. Key selectors can be customized with inscriptions and symbols. All selectors keys have the PY333 code. Other codes on request.

Fixing adapter with 3 positions







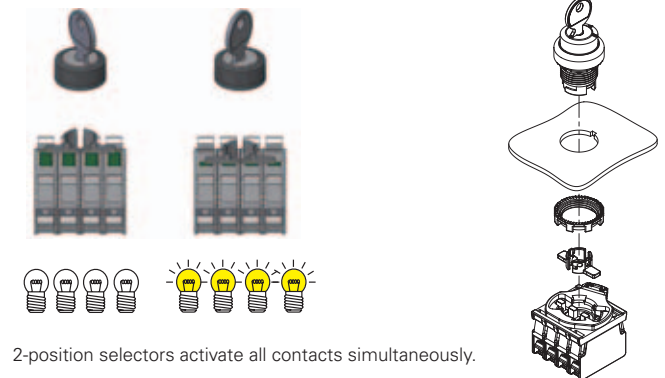



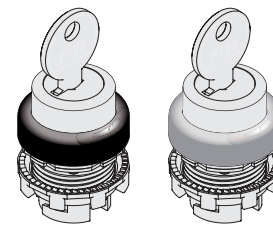





2-position selectors activate all contacts simultaneously.

Fixing adapter with 4 positions



2-position selectors activate all contacts simultaneously.



Actuator colour and marking	3 positions	key selector	
		black ring	satin chrome ring
● black		E2 1SC3ACE11AA	E2 1SC3ACE19AA
		E2 1SC3BCE11AA	E2 1SC3BCE19AA
		E2 1SC3CCE11AA	E2 1SC3CCE19AA
		E2 1SC3DCE11AA	E2 1SC3DCE19AA
		E2 1SC3ECE11AA	E2 1SC3ECE19AA
		E2 1SC3FCE11AA	E2 1SC3FCE19AA
		E2 1SC3GCE11AA	E2 1SC3GCE19AA
		E2 1SC3HCE11AA	E2 1SC3HCE19AA
		E2 1SC3LCE11AA	E2 1SC3LCE19AA
		E2 1SC3MCE11AA	E2 1SC3MCE19AA
		E2 1SC3NCE11AA	E2 1SC3NCE19AA
		E2 1SC3PCE11AA	E2 1SC3PCE19AA
		E2 1SC3QCE11AA	E2 1SC3QCE19AA
		E2 1SC3RCE11AA	E2 1SC3RCE19AA

Selector standard colour in above mentioned codes is **BLACK**. Other colours on request. Key selectors can be customized with inscriptions and symbols. All selectors keys have the PY333 code. Other codes on request.

Fixing adapter with 3 positions

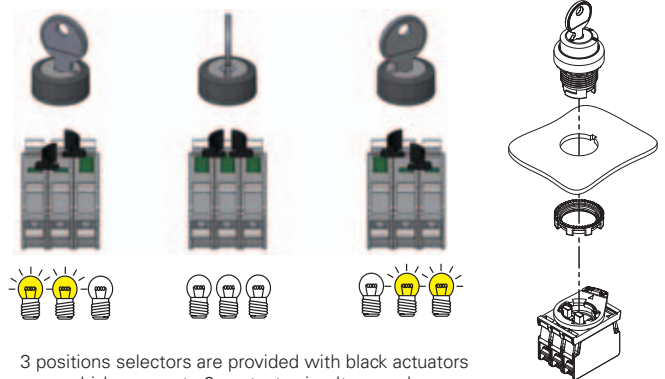

3 positions selectors are provided with black actuators which commute 2 contacts simultaneously.

Fixing adapter with 4 positions

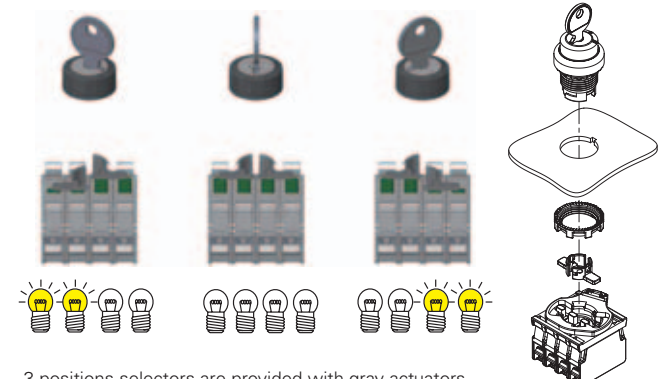

3 positions selectors are provided with gray actuators which commute 2 contacts simultaneously.

Items with code on the **green** background are available in stock

Legend:  Stay-put  Spring-return  Key withdrawal position

Complete units with selectors

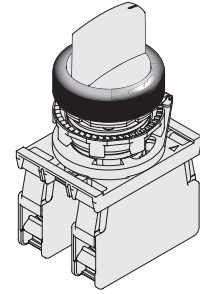
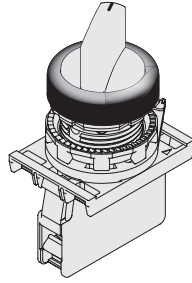

Actuator colour and marking	Contacts			Position	2 positions
	pos 2	pos 3	pos 1		black ring
● black	-	1NO	-	↙	E2 AC-DXBC1401 E2 1SE12AVA11AB + E2 1BAC11 + E2 CP10G2V1
● black	-	1NO	-	↘	E2 AC-DXBC1402 E2 1SE12EVA11AB + E2 1BAC11 + E2 CP10G2V1

Actuator colour and marking	Contacts			Position	3 positions
	pos 2	pos 3	pos 1		black ring
● black	1NO	-	1NO	↙	E2 AC-DXBC1405 E2 1SE13ACE11AB + E2 1BAC11 + E2 CP10G2V1 + E2 CP10G2V1
● black	1NO	-	1NO	↘	E2 AC-DXBC1406 E2 1SE13GCE11AB + E2 1BAC11 + E2 CP10G2V1 + E2 CP10G2V1

Complete units with illuminated selectors

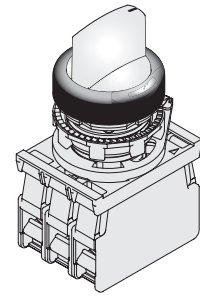
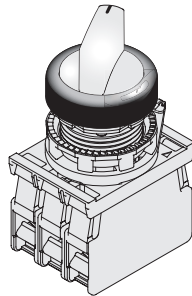

Actuator colour and marking	Contacts			Position	2 positions
	pos 2	pos 3	pos 1		black ring
○ white	1NO	LED	1NC ⊕	↙	E2 AC-DXBC1805 E2 1SL12AVD21AB + E2 1BAC11 + E2 CP10G2V1 + E2 LP1A2V1 + E2 CP01G2V1
● green	1NO	LED	1NC ⊕	↙	E2 AC-DXBC1801 E2 1SL12AVD41AB + E2 1BAC11 + E2 CP10G2V1 + E2 LP1A4V1 + E2 CP01G2V1

Actuator colour and marking	Contacts			Position	3 positions
	pos 2	pos 3	pos 1		black ring
○ white	1NO	LED	1NC ⊕	↙	E2 AC-DXBC1806 E2 1SL13ACH21AB + E2 1BAC11 + E2 CP10G2V1 + E2 LP1A2V1 + E2 CP01G2V1
● green	1NO	LED	1NC ⊕	↙	E2 AC-DXBC1803 E2 1SL13ACH41AB + E2 1BAC11 + E2 CP10G2V1 + E2 LP1A4V1 + E2 CP01G2V1

Complete units with key selectors

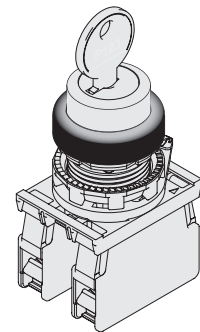
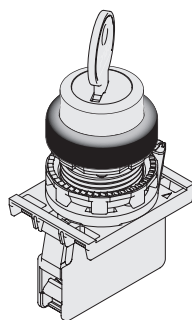

Actuator colour and marking	Contacts			Position	2 positions
	pos 2	pos 3	pos 1		black ring
● black	-	1NO	-	↙	E2 AC-DXBC1601 E2 1SC2AVA11AA + E2 1BAC11 + E2 CP10G2V1
● black	-	1NO	-	↙	E2 AC-DXBC1605 E2 1SC2CVA11AA + E2 1BAC11 + E2 CP10G2V1
● black	-	1NO	-	↘	E2 AC-DXBC1606 E2 1SC2DVA11AA + E2 1BAC11 + E2 CP10G2V1

Actuator colour and marking	Contacts			Position	3 positions
	pos 2	pos 3	pos 1		black ring
● black	1NO	-	1NO	↙	E2 AC-DXBC1607 E2 1SC3DCE11AA + E2 1BAC11 + E2 CP10G2V1 + E2 CP10G2V1 Key number PY333

Key number PY333

Legend: ↙ Stay-put ↘ Spring-return ⊕ Key withdrawal position

→ For the contact block and LED block characteristics see the respective chapters.

Locking keys

Article	Description
VE KE1A00-PY333	Locking key





Extra copy of the locking keys to be purchased if further key is needed. All keys have the same code. Other codes on request.

Accessories

→ [More ACCESSORIES at page 75](#)

Actuators

10 pcs packs

Article	Description
 VE AS1212	Black closed actuator for base with 3 positions. It simultaneously operates 2 contact blocks. For selectors: E2 1SE●●●●●●●●, E2 1SL●●●●●●●●, E2 1SC●●●●●●●●
 VE AS1213	White open actuator for base with 3 positions. It operates 1 contact block. For selectors: E2 1SE●●●●●●●●, E2 1SL●●●●●●●●, E2 1SC●●●●●●●●
 VE AS1216	Grey closed actuator for base with 4 positions. It simultaneously operates 2 contact blocks. For selectors: E2 1SE●●●●●●●●, E2 1SL●●●●●●●●, E2 1SC●●●●●●●●

Items with code on the **green** background are available in stock

Contacts maximum number

Fixing adapter with 3 positions	Fixing adapter with 4 positions
---------------------------------	---------------------------------

Selectors E2 1SE/1SC



Contacts maximum number: 6

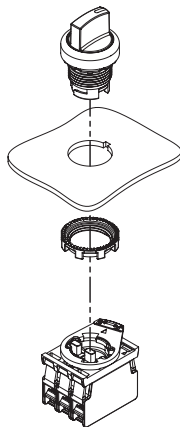

Illuminated selectors E2 1SL



Contacts maximum number: 6

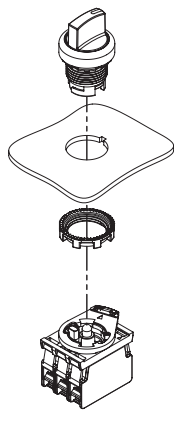

Selectors E2 1SE/1SC

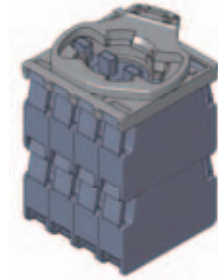

Contacts maximum number: 8

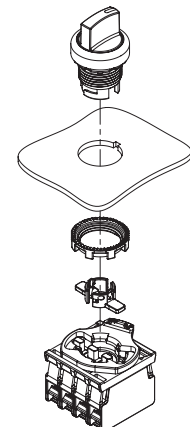

The actuators for an adapter with 4 positions must be mounted after fixing the selector.

Dimensions

Short handle selector

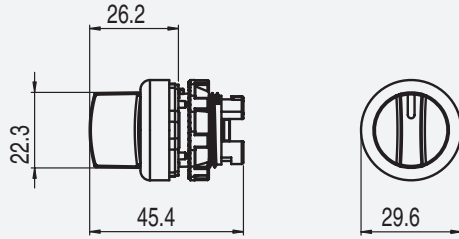

Knob selector

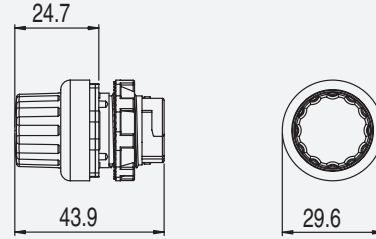

Key selector

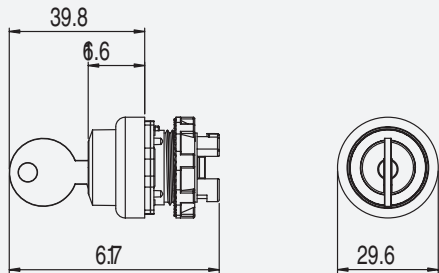

Long handle selector

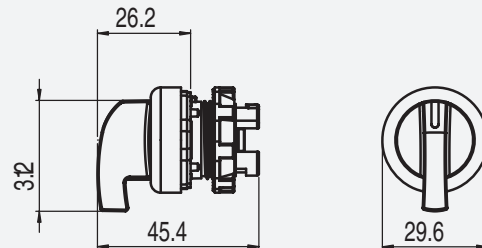

→ 2D and 3D files available on www.pizzato.it

Assembling minimum distances

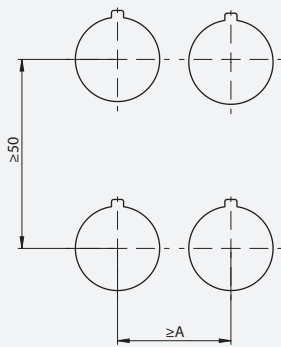

Fixing adapter with 3 positions
A=30 mm

Fixing adapter with 4 positions
A=40 mm

Selection diagram

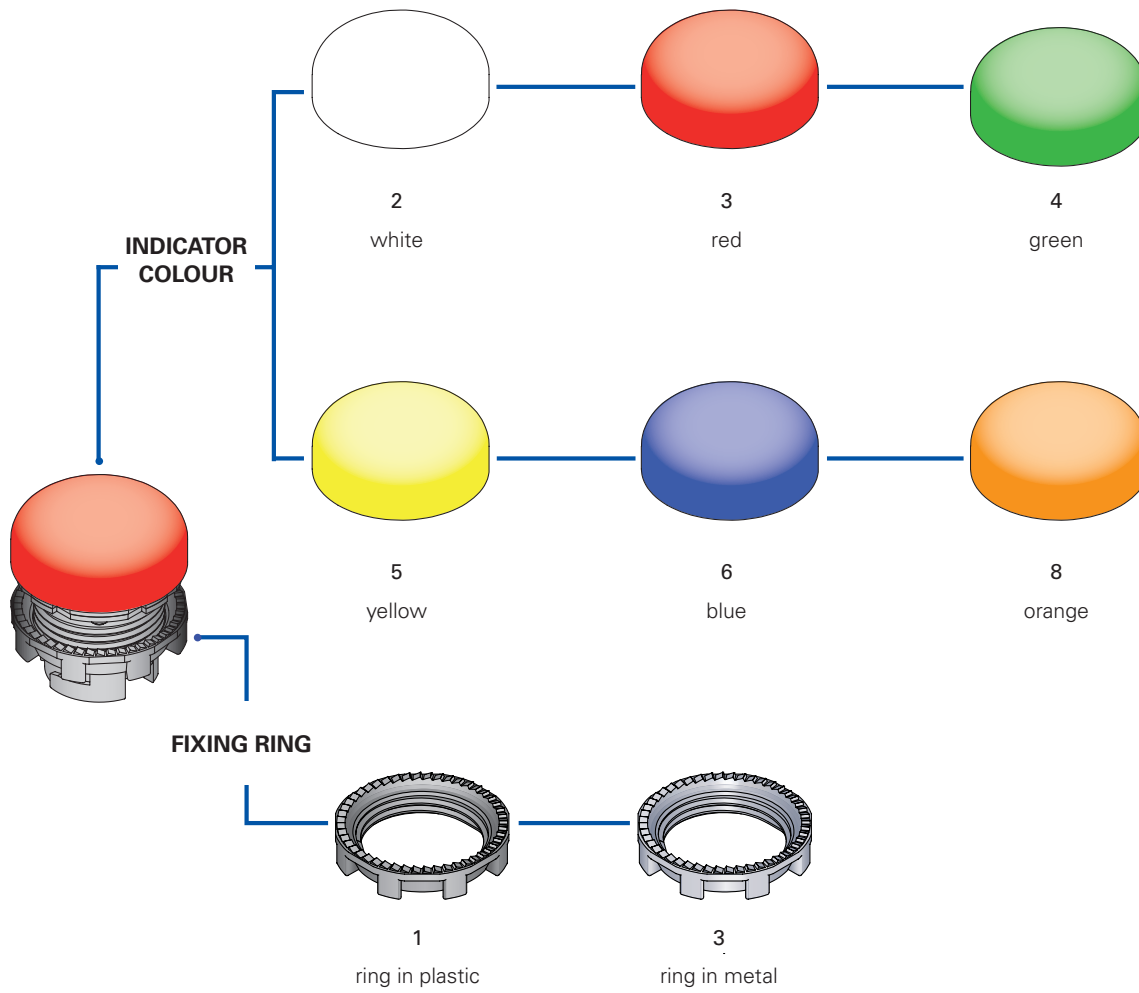

Indicator lights code structure**E2 1ILA210**

Fixing ring and shaped ring	
1	ring in plastic
2	ring in plastic and shaped ring
3	ring in metal
4	ring in metal and shaped ring

Lens shape	
A	flat and smooth

Marking	
0	without marking (standard)
GB7	RUN
GB8	FAULT
L54	
...

Other markings on request. See page 77

Lens colour	
0	without lens
2	white
3	red
4	green
5	yellow
6	blue
8	orange

Attention! The feasibility of a code number does not mean the effective availability of a product. Please contact our sales office.



Technical data

General data

Protection degree:	IP67 according to IEC 60529 IP69K according to DIN 40050
Ambient temperature:	-25°C +70°C
Illumination type:	provided with LED holder E2 LP●●●●, E2 LF●●●● series
Fixing ring driving torque:	2 ... 2,5 Nm
Utilization requirements:	see page 78

In conformity with standards:

IEC 60947-1, IEC 60947-5-1, IEC 60204-1, EN 60947-1, EN 60947-5-1, EN 60204-1, UL 508, CSA 22-2 N°14.

In conformity with requirements requested by:

Low Voltage Directive 2006/95/EC, Machinery Directive 2006/42/EC and Electromagnetic Compatibility 2004/108/EC.

Main features

- Protection degree IP67 and IP69K
- Optional customisation with symbols
- Removable coloured lens

Markings and quality marks:



Approval GOST: POCC IT.AB24.B04512

General characteristics

Protection degree IP67 and IP69K

IP69K
IP67

Designed to be employed also in severe environment conditions, Pizzato Elettrica pushbuttons have protection degree IP67 and IP69K, suitable for use in machineries subjected to intense washing with high pressure and high temperature water jets.

Customizing possibilities

In order to suit the various requests and needs of the customers, Pizzato Elettrica offers the possibility to customize the EROUND control and signalling devices: the rings can be requested in different colours (gold satinized, bright black chrome, white, black and satin chrome), while the lens can be customized with inscriptions, symbols and colours.

Fixing ring

A fixing ring in metal is also available in addition to the fixing ring in technopolymer.

The fixing ring in metal is particularly suitable for those applications which require tighter fitting of the panel-mounted device, such as for example in metal panels having holes without reference notches. Both rings feature a toothed surface which comes into contact with the inside of the panel in order to make it easier for the device to be secured to the actual panel.

Shaped ring

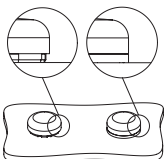

The shaped ring can be used when no label holders or other devices are applied; it prevents dirt and other residues from settling between the pushbutton and the panel or box. This turns out to be particularly useful in the sectors where high standards of cleanness and hygiene are required.

LED and lens colours combinations

LED colour	Lens colour
white	white / yellow
red	red
green	green
blue	blue
orange	orange

Note: LED colours combined with lens colours different from the indicated ones could result in a not expected final colour.

Indicator lights lens selection table

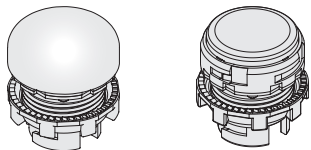

Actuator colour and marking	With lens	Without lens
Without lens	-	E2 11LA010
white	E2 11LA210	-
red	E2 11LA310	-
green	E2 11LA410	-
yellow	E2 11LA510	-
blue	E2 11LA610	-
orange	E2 11LA810	-

Complete units with indicator lights

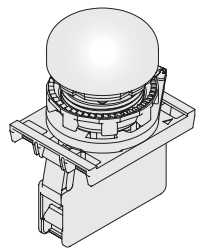

Actuator colour and marking	LED			Article
	pos 2	pos 3	pos 1	
white	-	LED	-	E2 AC-DXBC0200 E2 11LA210 + E2 1BAC11 + E2 LP1A2V1
red	-	LED	-	E2 AC-DXBC0201 E2 11LA310 + E2 1BAC11 + E2 LP1A3V1
green	-	LED	-	E2 AC-DXBC0202 E2 11LA410 + E2 1BAC11 + E2 LP1A4V1
yellow	-	LED	-	E2 AC-DXBC0203 E2 11LA510 + E2 1BAC11 + E2 LP1A2V1
blue	-	LED	-	E2 AC-DXBC0204 E2 11LA610 + E2 1BAC11 + E2 LP1A6V1
orange	-	LED	-	E2 AC-DXBC0205 E2 11LA810 + E2 1BAC11 + E2 LP1A8V1

E2 11L indicator light lenses



Article	Description	Colours	Pcs/Packs
VE LN2A20	white indicator light lens, without marking		10
VE LN2A30	red indicator light lens, without marking		10
VE LN2A40	green indicator light lens, without marking		10
VE LN2A50	yellow indicator light lens, without marking		10
VE LN2A60	blue indicator light lens, without marking		10
VE LN2A80	orange indicator light lens, without marking		10
VE LN2AA0	6 lens without marking, colours: white, red, green, yellow, blue, orange light,		1
VE LN2A2●●●	white indicator light lens, with marking		1
VE LN2A3●●●	red indicator light lens, with marking		1
VE LN2A4●●●	green indicator light lens, with marking		1
VE LN2A5●●●	yellow indicator light lens, with marking		1
VE LN2A6●●●	blue indicator light lens, with marking		1

For ordering E2 11L indicator lights lenses with marking: substitute the ●●● with the marking code in the table at page 77.
Example: indicator light lens with marking "4", red colours VE LN 2A2●●● → VE LN 2A2L54

Assembling minimum distances

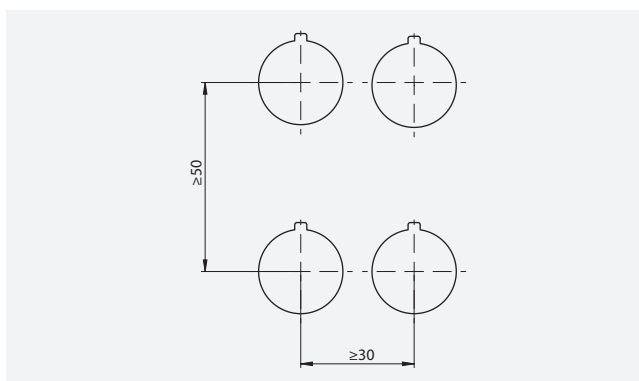

Dimensions

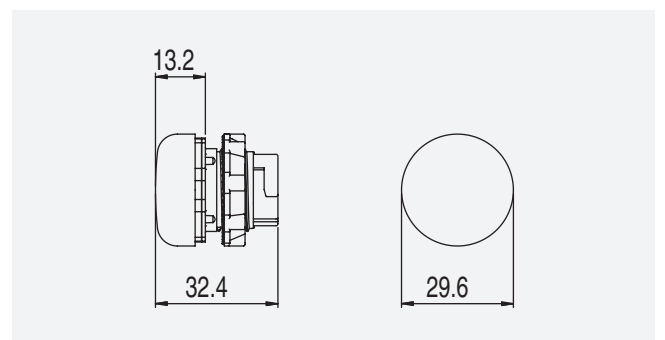

Accessories

→ More ACCESSORIES at page 75

Items with code on the green background are available in stock

Selection diagram

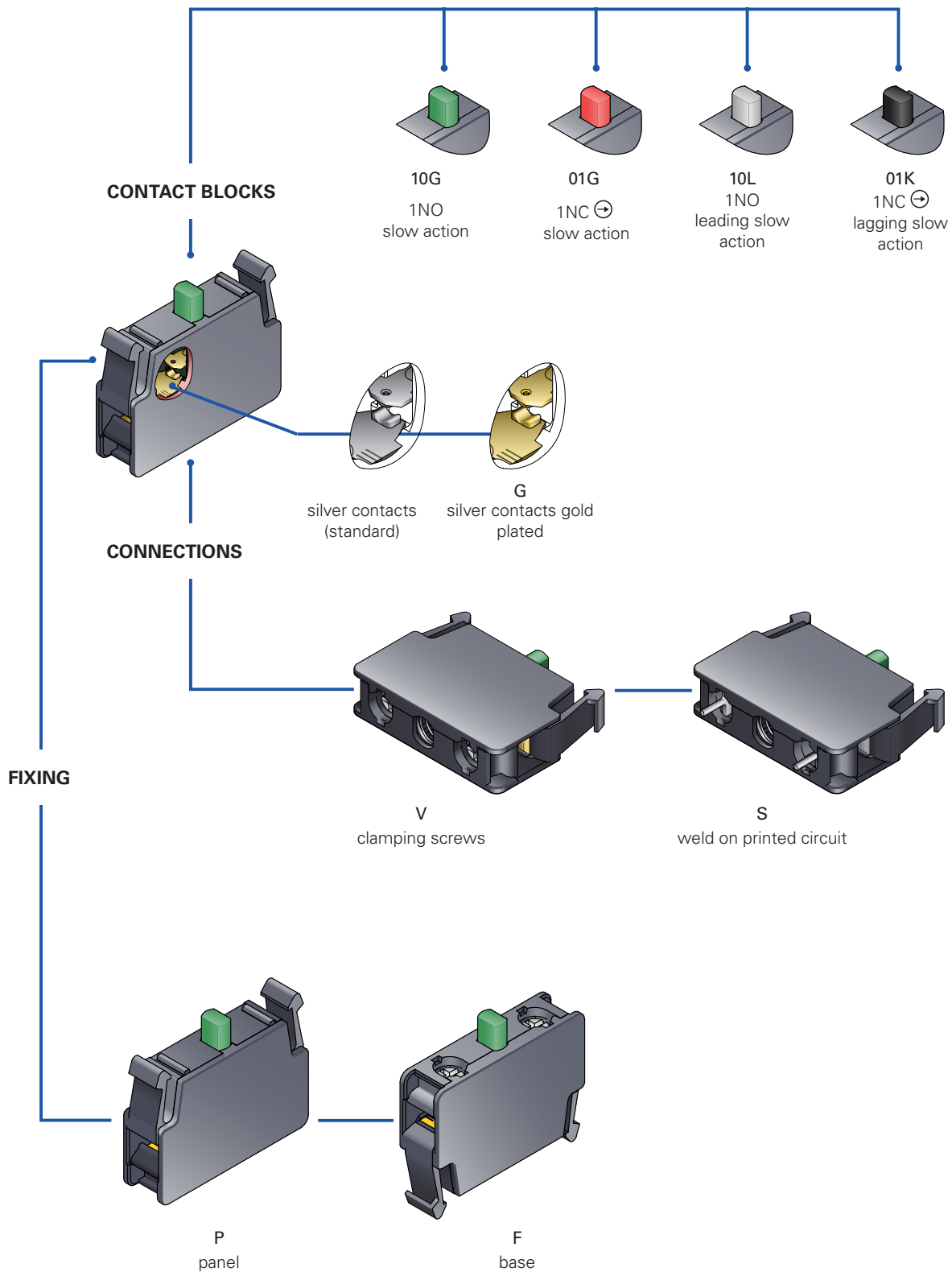

Contact block code structure

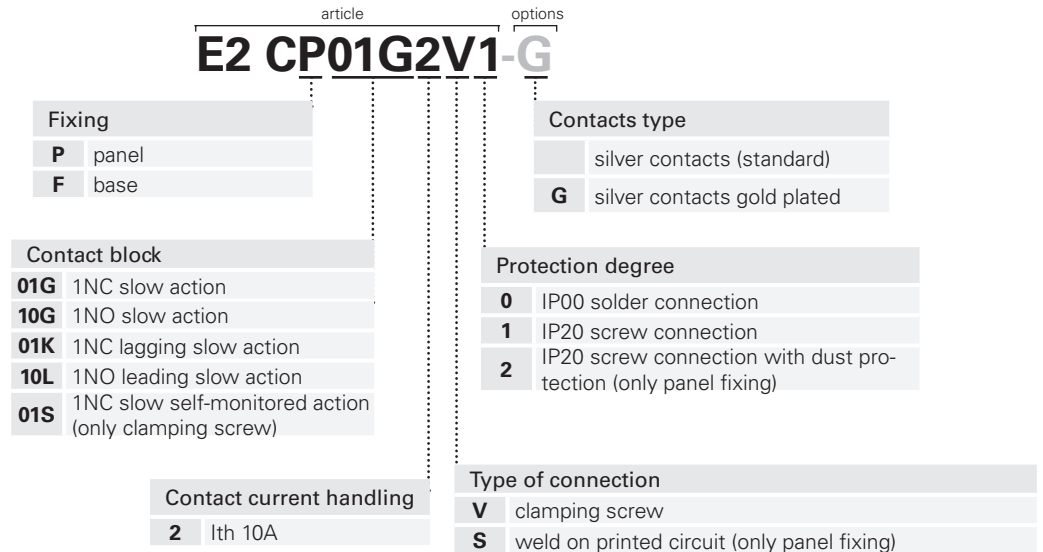

Versions with solder connection will be available from 2013.

Attention! The feasibility of a code number does not mean the effective availability of a product. Please contact our sales office.

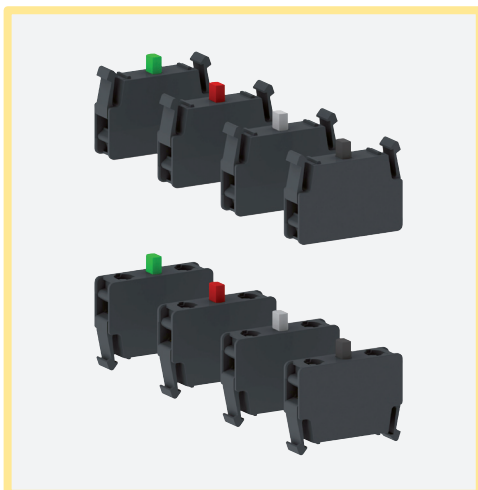

Main features

- High reliability contact blocks with quadruple contact points self-cleaning contacts
- Gold plated contacts version
- Positive opening NC contacts according to IEC 6097-5-1

Markings and quality marks:



Approval IMQ: CA02.04805

Approval UL: E131787

Approval GOST: POCC IT.AB24.B04512

Technical data

General data

Protection degree:	IP20 on the terminals according to IEC 60529
Ambient temperature:	-40°C +80°C
Mechanical endurance:	20 million operations cycles
Max operating frequency:	3600 operations cycles/hour
Utilization requirements:	see page 78

Contact block

Contacts commutation force:	1,8 N (NO) / 1,4 N (NC) 1,7 N (NO leading) / 1,4 N (NC lagging)
Actuating force at end travel:	3,5 N (NO) / 2,3 N (NC) 3,5 N (NO leading) / 1,9 N (NC lagging)
Positive opening force:	17 N
Activating speed:	min 1 mm/s max 0,5 m/s
Contacts material:	silver contacts (standard) Contacts for weak current in silver, 1µm thick gold-plating (on request)
Contacts form:	"V shape" self-cleaning contacts with quadruple contact points
Conductors cross section:	min 1 x 0,5 mm ² (1 x AWG 20) max 2 x 2,5 mm ² (2 x AWG 14)
Screw terminal driving torque:	0,6 ... 0,8 Nm

In conformity with standards:

IEC 60947-1, IEC 60947-5-1, IEC 60204-1, EN 60947-1, EN 60947-5-1, EN 60204-1, UL 508, CSA 22-2 N°14.

⚠ Installation for safety applications:

Use only switches marked with the symbol ⊕. The safety circuit must always be connected with the **NC contacts** (normally closed contacts: .1-.2) as stated in the standard EN 60947-5-1, encl. K, par. 2.

In conformity with requirements requested by:

Low Voltage Directive 2006/95/EC, Machinery Directive 2006/42/EC and Electromagnetic Compatibility 2004/108/EC.

Positive contact opening in conformity with standards:

IEC 60947-5-1, EN 60947-5-1, VDE 0660-206.

Electrical data

Thermal current (I _{th}):	10 A
Rated insulation voltage (U _i):	500 Vac/dc
Protection against short circuits:	fuse 10 A 500 V type gG/gL
Rated impulse withstand voltage (U _{imp}):	8 kV
Pollution degree:	3

Utilization categories

Alternate current: AC15 (50-60 Hz)					
U _e (V)	24	48	120	250	400
I _e (A)	6	6	6	6	3
Direct current: DC13					
U _e (V)	24	48	125	250	
I _e (A)	2,5	1,3	0,6	0,3	

General characteristics

Positive opening

All NC contacts are suitable for safety applications. NC contacts have positive opening according to IEC 60947-5-1.

High reliability self-cleaning contacts

"V shape" self-cleaning contacts with quadruple contact points. This shape, thanks to its quadruple support, allows to reduce the probability of contact wrong switching. Furthermore it highly improves the contacts reliability in case of dust.

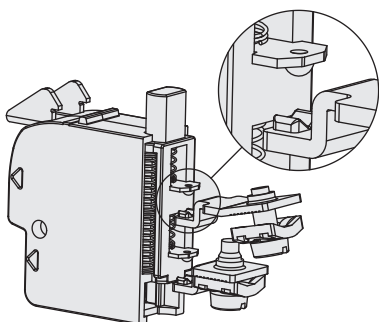

Clamping screw plates

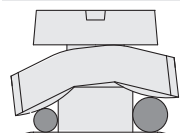

The clamping screw plates of the contact blocks have a particular "roofing tile" structure and are connected loosely to the clamping screw. In this way, during the wires fixing, the clamping screw plate is able to suit to cables of different diameter (see picture) and tends to tighten the wires toward the screw instead of permitting them to escape towards the outside.

Connection to be welded on printed circuit

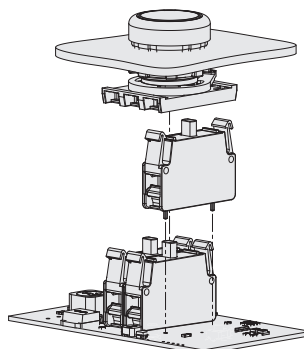

A number of new EROUND contact blocks provided with pins to be welded are now available. These contact blocks, available in panel-mounted versions, are suitable in cases where a printed circuit is used instead of wiring, and therefore the contact blocks are welded directly onto the printed circuit.

Data type approved by UL

Utilization category: A600 pilot duty (720 VA, 120-600 Vac)
Q300 pilot duty (69 VA, 125-250 Vdc)

Note:
- Use copper wire (Cu) 60 or 75 °C rigid or flexible with cross section 12-20 AWG.
- Terminals tightening torque 7.1 Lb In (0.8 Nm).

Data type approved by IMQ



Rated insulation voltage (Ui): 500 V
Thermal current in free air (Ith): 10 A
Thermal current in housing (Ithe): 10 A
Rated impulse withstand voltage (Uimp): 8 kV
Housing protection degree: IP20
Terminals: screw clamps
Category of use: AC15



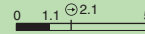
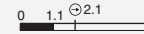
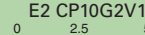
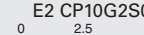

Operating voltage (Ue): 400 Vac (50/60 Hz)
Operating current (Ie): 3 A
Kinds of contact element: X, Y
Positive contact opening on O1G and O1K contact blocks
Conformity with standards: EN 60947-1, EN 60947-5-1:2004 + A1:2009, fundamental requirements of 2006/95/CE Low Voltage Directive.

Contact block selection table

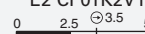
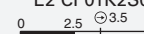
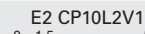
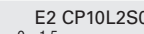
10 pcs packs



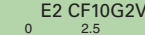

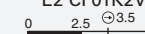
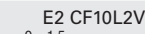

Contact block	Panel fixing	
	Screw connection	Solder connection
1NC slow action 	E2 CP01G2V1 	E2 CP01G2S0 
1NO slow action	E2 CP10G2V1 	E2 CP10G2S0 
1NC 	E2 CP01K2V1 	E2 CP01K2S0 
1NO leading slow action	E2 CP10L2V1 	E2 CP10L2S0 

Contact block	Base fixing
	Screw connection
1NC slow action 	E2 CF01G2V1 
1NO slow action	E2 CF10G2V1 
1NC 	E2 CF01K2V1 
1NO leading slow action	E2 CF10L2V1 

Complete units with contact block and fixing adapter



Contacts			Panel fixing Screw connection
pos 2	pos 3	pos 1	
-	1NO	-	E2 AC-XXBC0010 E2 1BAC11 + E2 CP10G2V1
-	1NC 	-	E2 AC-XXBC0009 E2 1BAC11 + E2 CP01G2V1

Contacts			Panel fixing Screw connection
pos 2	pos 3	pos 1	
1NO	-	1NO	E2 AC-XXBC0012 E2 1BAC11 + E2 CP10G2V1 + E2 CP10G2V1
1NC 	-	1NC 	E2 AC-XXBC0011 E2 1BAC11 + E2 CP01G2V1 + E2 CP01G2V1
1NC 	-	1NO	E2 AC-XXBC0028 E2 1BAC11 + E2 CP10G2V1 + E2 CP01G2V1

Dimensions

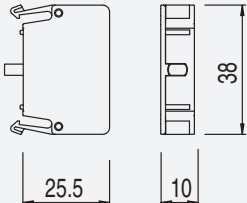
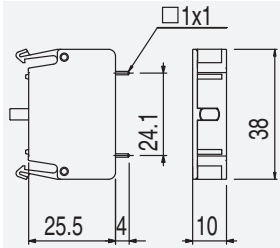
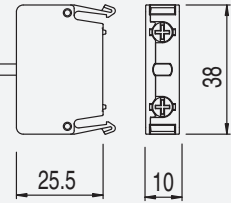
Panel fixing contact block screw connection	Panel fixing contact block solder connection	Base fixing contact block screw connection
	 Holes on PCB Ø 1,4 mm	

Dust protection

50 pcs packs

Article	Description
 VE PR3A70	Transparent dust protection for contact block E2 series. Applicable to all contacts fixed on panels.

Items with code on the green background are available in stock

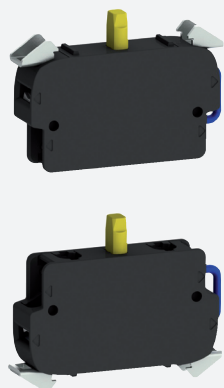

Main features

- Self-monitored contact block. Electrical circuit opening indicates separation from the device
- Gold plated contacts version
- Positive opening NC contacts according to IEC 6097-5-1

Markings and quality marks:



Approval GOST: POCC IT.AB24.B04512

Technical data

General data

Protection degree:	IP20 on the terminals according to IEC 60529
Ambient temperature:	-40°C +80°C
Mechanical endurance:	20 million operations cycles
Max operating frequency:	3600 operations cycles/hour
Utilization requirements:	see page 78

Contact block

Contacts commutation force:	2,9 N
Actuating force at end travel:	5 N
Positive opening force:	17 N
Velocità di azionamento:	min 1 mm/s max 0,5 m/s
Contacts material:	silver contacts (standard) Contacts for weak current in silver, 1µm thick gold-plating (on request)
Contacts form:	"V shape" self-cleaning contacts with quadruple contact points
Conductors cross section:	min 1 x 0,34 mm ² (1 x AWG 22) max 2 x 1,5 mm ² (2 x AWG 16)
Screw terminal driving torque:	0,6 ... 0,8 Nm

In conformity with standards:

IEC 60947-1, IEC 60947-5-1, IEC 60204-1, EN 60947-1, EN 60947-5-1, EN 60204-1, UL 508, CSA 22-2 N°14.

⚠ Installation for safety applications:

Use only switches marked with the symbol . The safety circuit must always be connected with the **NC contacts** (normally closed contacts: .1-.2) as stated in the standard EN 60947-5-1, encl. K, par. 2.

In conformity with requirements requested by:

Low Voltage Directive 2006/95/EC, Machinery Directive 2006/42/EC and Electromagnetic Compatibility 2004/108/EC.

Positive contact opening in conformity with standards:

IEC 60947-5-1, EN 60947-5-1, VDE 0660-206.

Electrical data

Thermal current (I _{th}):	10 A
Rated insulation voltage (U _i):	250 Vac/dc
Protection against short circuits:	fuse 10 A 500 V type gG/gL
Rated impulse withstand voltage (U _{imp}):	4 kV
Pollution degree:	3

Utilization categories

Alternate current: AC15 (50-60 Hz)				
U _e (V)	24	48	120	250
I _e (A)	6	6	6	6
Direct current: DC13				
U _e (V)	24	48	125	250
I _e (A)	2,5	1,3	0,6	0,3

General characteristics

Fitting of several single, double and self-monitored contact blocks

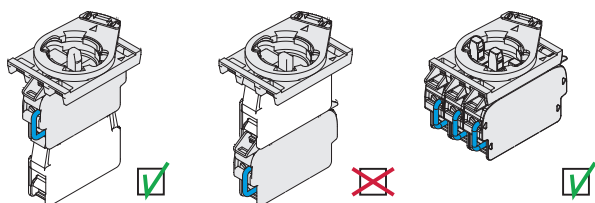

Always install self-monitored contact blocks directly on the fixing adapter.

Do not fix self-monitored contact blocks to standard contact blocks. Forbidden application!



Fix no more than three self-monitored contact blocks per device.

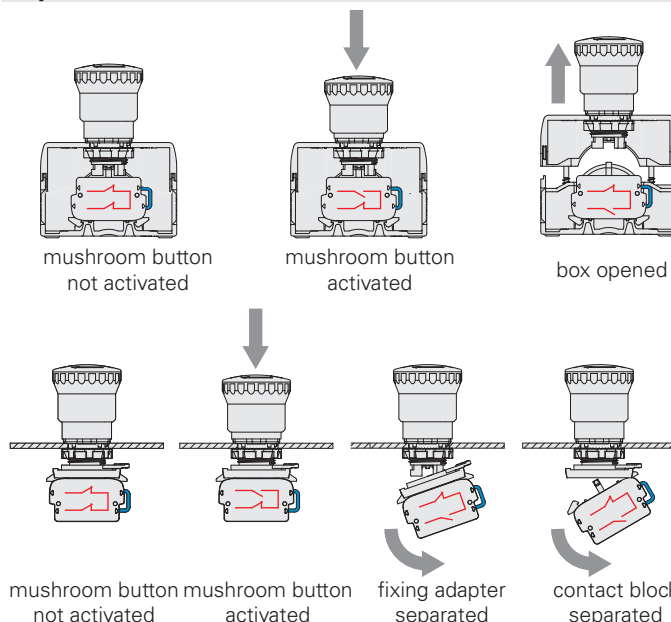

Operation of self-monitored contact blocks

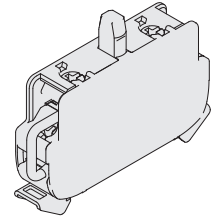
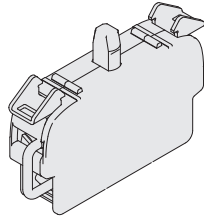

Contact block selection table 5 pcs packs



Contact block	Panel fixing Screw connection
1NC  slow self-monitored action 	E2 CP01S2V1 2.3 0.8 0 1.1  2.1 5

Contact block	Base fixing Screw connection
1NC  slow self-monitored action 	E2 CF01S2V1 2.3 0.8 0 1.1  2.1 5

Complete units with contact block and fixing adapter

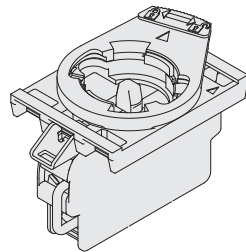

Contacts			Panel fixing Screw connection
pos 2	pos 3	pos 1	
-	1NC  SELF-MONITORED	-	E2 AC-XXBC0139 E2 1BAC11 + E2 CP01S2V1

Dimensions

Panel fixing contact block E2 CP01S...

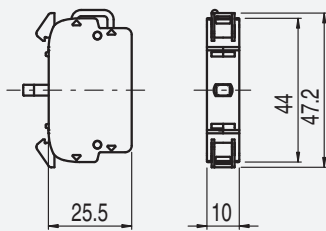

Base fixing contact block E2 CF01S...

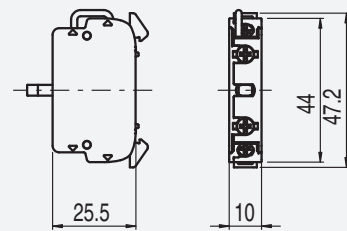

Dust protection 50 pcs packs

Article	Description
 VE PR3A70	Transparent dust protection for contact block E2 series. Applicable to all contacts fixed on panels.

Items with code on the green background are available in stock

Selection diagram

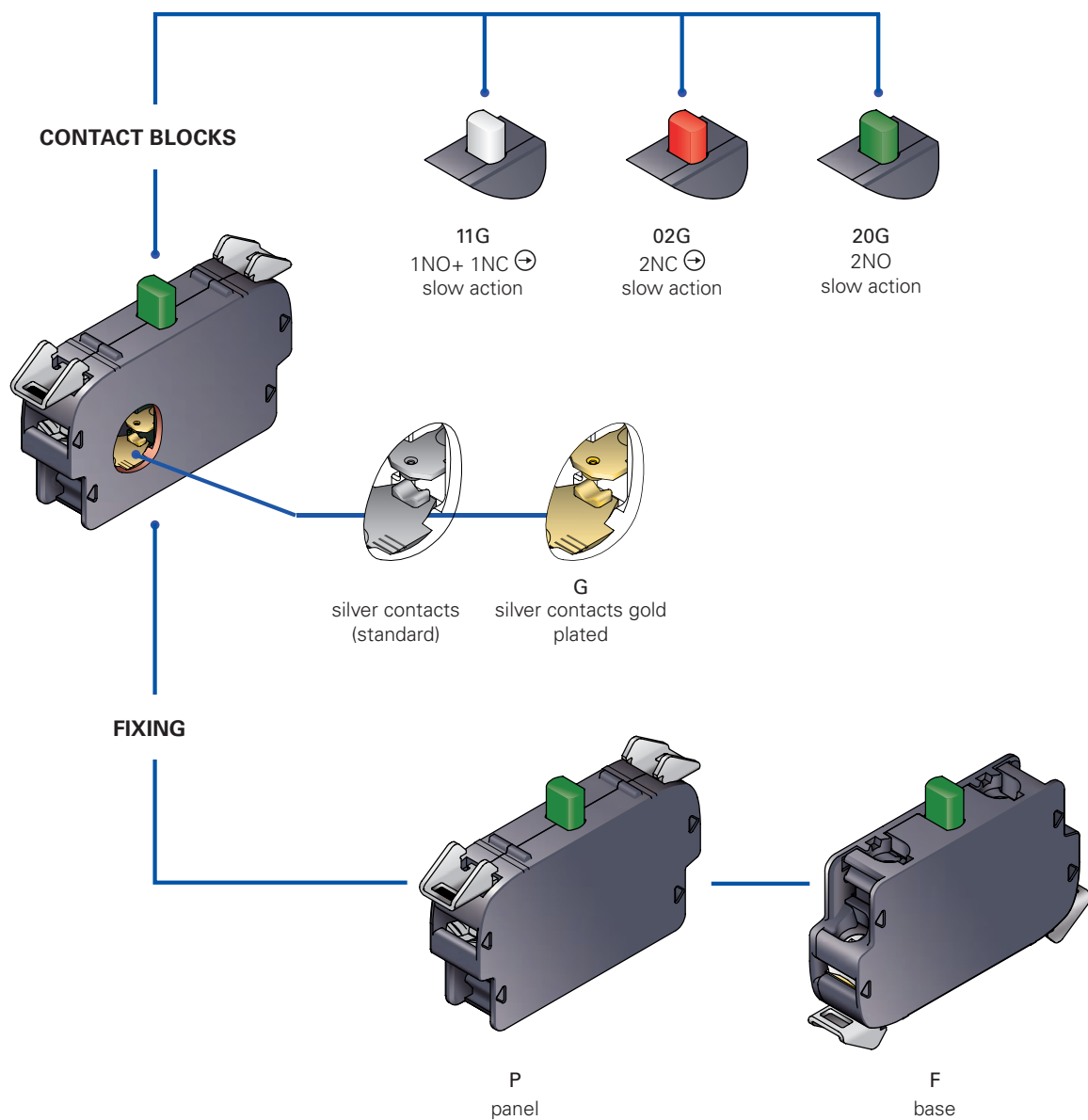

Contact block code structure

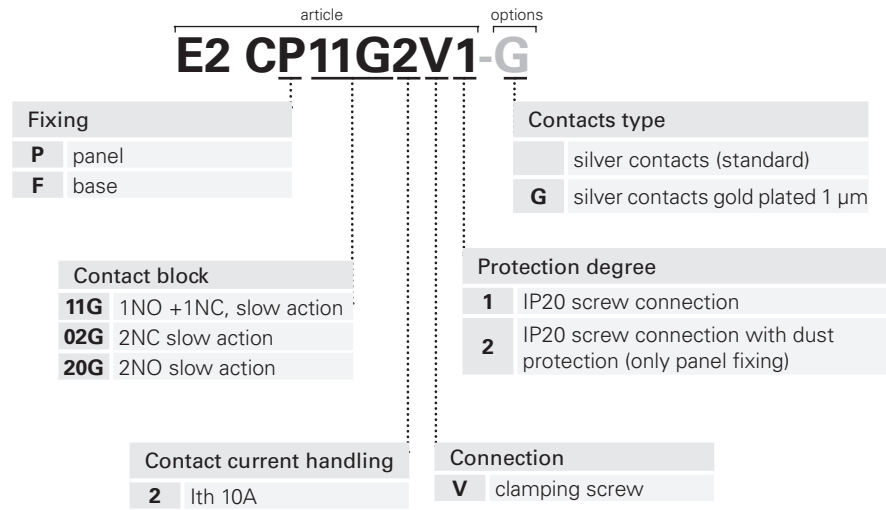

Attention! The feasibility of a code number does not mean the effective availability of a product. Please contact our sales office.

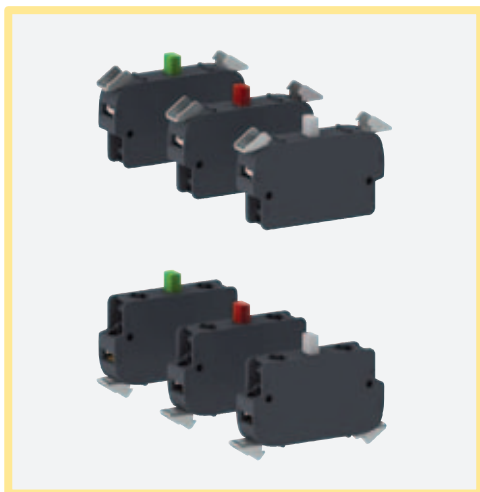

Main features

- High reliability contact blocks with quadruple contact points self-cleaning contacts
- Gold plated contacts version
- Positive opening NC contacts according to IEC 6097-5-1

Markings and quality marks:



Approval GOST: POCC IT.AB24.B04512

Technical data

General data

Protection degree:	IP20 on the terminals according to IEC 60529
Ambient temperature:	-40°C +80°C
Mechanical endurance:	20 million operations cycles
Max operating frequency:	3600 operations cycles/hour
Utilization requirements:	see page 78

Contact block

Contacts commutation force:	2NO: 1,7 N 2NC: 2 N 1NO+1NC: 2,7 N (NO), 2,2 N (NC)
Actuating force at end travel:	2NO: 3,8 N, 2NC: 3,8 N 1NO+1NC: 4,5 N
Positive opening force:	17 N
Activating speed:	min 1 mm/s max 0,5 m/s
Contacts material:	silver contacts (standard) Contacts for weak current in silver, 1µm thick gold-plating (on request) "V shape" self-cleaning contacts with quadruple contact points
Contacts form:	min 1 x 0,34 mm ² (1 x AWG 22) max 2 x 1,5 mm ² (2 x AWG 16)
Conductors cross section:	0,6 ... 0,8 Nm
Screw terminal driving torque:	

In conformity with standards:

IEC 60947-1, IEC 60947-5-1, IEC 60204-1, EN 60947-1, EN 60947-5-1, EN 60204-1, UL 508, CSA 22-2 N°14.

⚠ Installation for safety applications:

Use only switches marked with the symbol ⊕. The safety circuit must always be connected with the **NC contacts** (normally closed contacts: 1-2) as stated in the standard EN 60947-5-1, encl. K, par. 2.

In conformity with requirements requested by:

Low Voltage Directive 2006/95/EC, Machinery Directive 2006/42/EC and Electromagnetic Compatibility 2004/108/EC.

Positive contact opening in conformity with standards:

IEC 60947-5-1, EN 60947-5-1, VDE 0660-206.

Electrical data

Thermal current (I _{th}):	10 A
Rated insulation voltage (U _i):	250 Vac/dc
Protection against short circuits:	fuse 10 A 500 V type gG/gL
Rated impulse withstand voltage (U _{imp}):	4 kV
Pollution degree:	3

Utilization categories

Alternate current: AC15 (50÷60 Hz)				
U _e (V)	24	48	120	250
I _e (A)	6	6	6	6
Direct current: DC13				
U _e (V)	24	48	125	250
I _e (A)	2,5	1,3	0,6	0,3

General characteristics

Positive opening

All NC contacts are suitable for safety applications. NC contacts have positive opening according to IEC 60947-5-1.

High reliability self-cleaning contacts

"V shape" self-cleaning contacts with quadruple contact points. This shape, thanks to its quadruple support, allows to reduce the probability of contact wrong switching. Furthermore it highly improves the contacts reliability in case of dust.

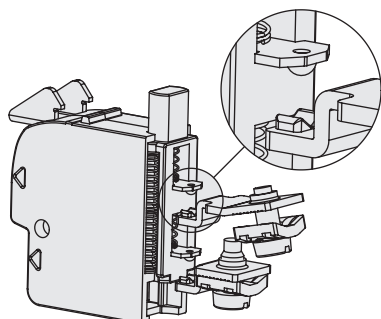

Modularity and compact dimensions



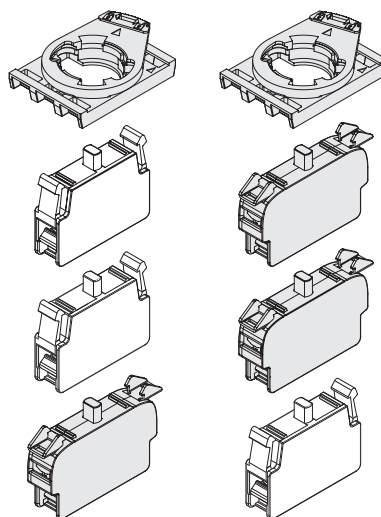

The EROUND double contact blocks are distinguished by their more compact dimensions as compared to the other double contact blocks found on the market. Thanks to their compact dimensions, these versions can also be mounted on the bottom of boxes. However, these double contact blocks have the same vertical overall dimensions of the EROUND single contact blocks: this ensures that single and double contact blocks can be piled up together on several levels, and can be interchanged during the installation stage.



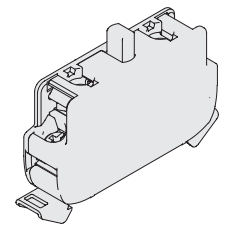
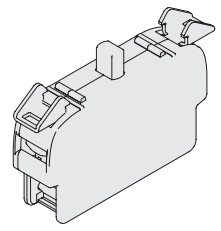

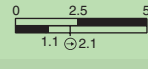

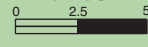
Contact block selection table

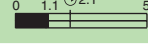
5 pcs packs



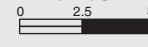

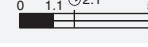

Contact block	Panel fixing Screw connection
1NO+1NC slow action 	E2 CP11G2V1 
2NO slow action 	E2 CP20G2V1 
2NC  slow action 	E2 CP02G2V1 

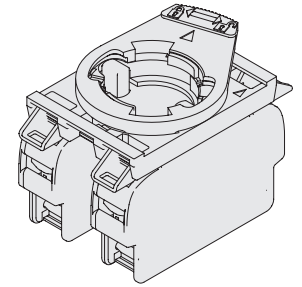
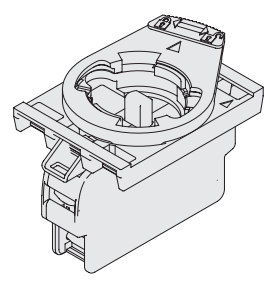
Contact block	Base fixing Screw connection
1NO+1NC slow action 	E2 CF11G2V1 
2NO slow action 	E2 CF20G2V1 
2NC  slow action 	E2 CF02G2V1 

Complete units with contact block and fixing adapter



Contacts			Panel fixing Screw connection
pos 2	pos 3	pos 1	
-	1NO+ 1NC 	-	E2 AC-XXBC0135 E2 1BAC11 + E2 CP11G2V1
-	2NO	-	E2 AC-XXBC0136 E2 1BAC11 + E2 CP20G2V1
-	2NC 	-	E2 AC-XXBC0137 E2 1BAC11 + E2 CP02G2V1

Contacts			Panel fixing Screw connection
pos 2	pos 3	pos 1	
1NO+ 1NC 	-	1NO+ 1NC 	E2 AC-XXBC0138 E2 1BAC11 + E2 CP11G2V1+ E2 CP11G2V1

Dimensions

Panel fixing contact block E2 CP••G•••

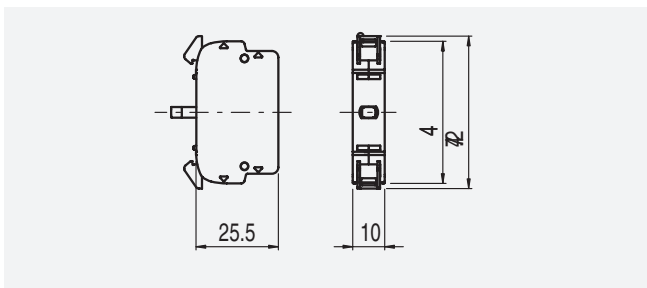

Base fixing contact block E2 CF••G•••

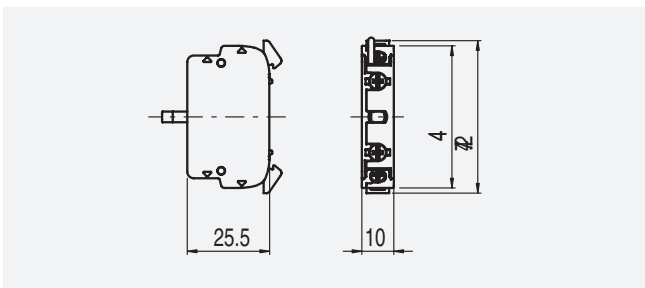

Dust protection

50 pcs packs

Article	Description
VE PR3A70	Transparent dust protection for contact block E2 series. Applicable to all contacts fixed on panels.

Items with code on the green background are available in stock

Selection diagram

PANEL FIXING LED HOLDERS

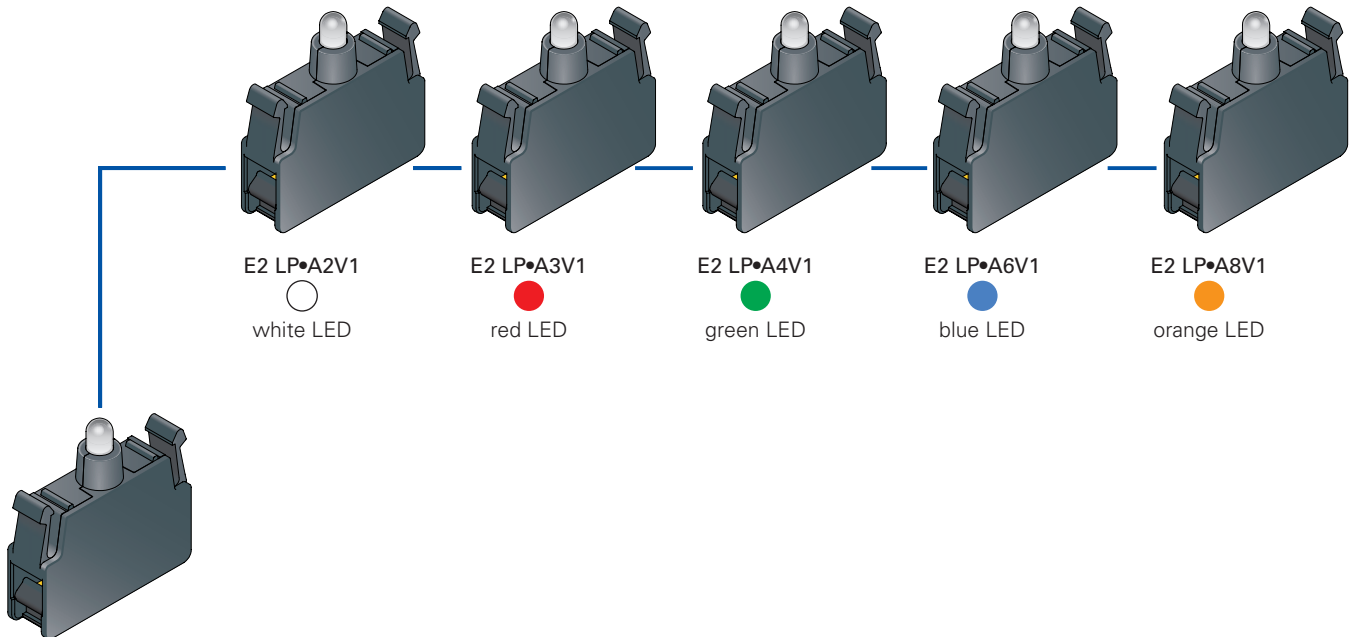

BASE FIXING LED HOLDERS

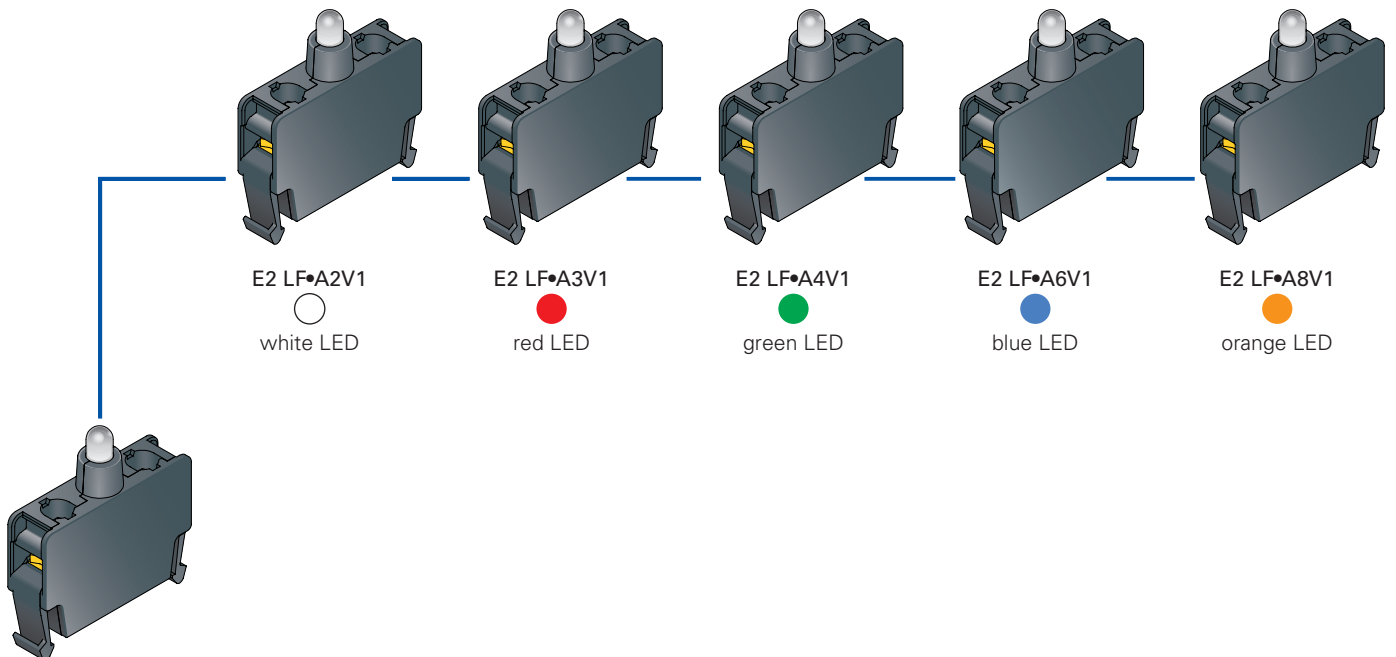

LED holders code structure

E2 LP1A3V1

Fixing	
P	panel
F	base

Connection	
V	clamping screw

Supply voltages	
1	12 ... 30 Vac/dc (high luminosity)
3	120 Vac (high luminosity)
4	230 Vac (high luminosity)
7	120 Vac (standard luminosity)
8	230 Vac (standard luminosity)

LED colour	
2	white
3	red
4	green
6	blue
8	orange

Attention! The feasibility of a code number does not mean the effective availability of a product. Please contact our sales office.

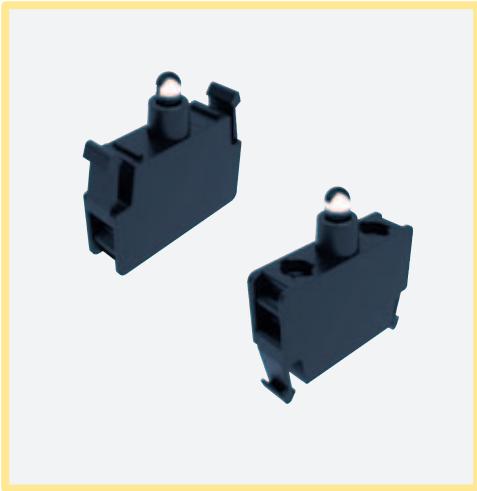

Main features

- High brilliancy LED
- 3 power supply:
12 ... 30 Vac/dc, 120 Vac, 230 Vac
- Protection degree IP20 according to IEC 60529
- Panel and base fixing versions

Markings and quality marks:



Approval IMQ: CA02.04805
Approval UL: E131787
Approval GOST: POCC IT.AB24.B04512

Technical data

General data

Protection degree:	IP20 on terminals according to IEC 60529
Ambient temperature:	-25°C +70°C
Endurance:	100.000 hours
Utilization requirements:	(at rated voltage and ambient temperature +25 °C) see page 78

LED holders

Conductor cross section:	min 1 x 0,5 mm ² (1 x AWG 20) max 2 x 2,5 mm ² (2 x AWG 14)
Operation voltage and current: (high luminosity)	12 ... 30 Vac/dc; 5 ... 15 mA 102 ... 138 Vac; 10 ... 12 mA 195 ... 264 Vac; 9 ... 10 mA
Operation voltage and current: (standard luminosity)	102 ... 138 Vac; 2,5 mA 195 ... 264 Vac; 2,5 mA
Screw terminal driving torque:	0,6 ... 0,8 Nm

In conformity with standards:

IEC 60947-1, IEC 60947-5-1, IEC 60204-1, EN 60947-1, EN 60947-5-1, EN 60204-1, UL 508, CSA 22-2 N°14.

In conformity with requirements requested by:

Low Voltage Directive 2006/95/EC, Machinery Directive 2006/42/EC and Electromagnetic Compatibility 2004/108/EC.

General characteristics

Protection degree

All contact blocks have protection degree IP20 on terminals.

Clamping screw plates

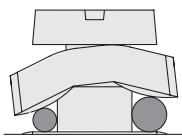

The clamping screw plates of the contact blocks have a particular "roofing tile" structure and are connected loosely to the clamping screw. In this way, during the wires fixing, the clamping screw plate is able to suit to cables of different diameter (see picture) and tends to tighten the wires toward the screw instead of permitting them to escape towards the outside.

High luminous efficiency LED

The LED holders to be combined with the illuminated devices have LED (Light Emitting Diodes) with a high luminous efficiency in order to guarantee better visibility.

Using integrated LED instead of incandescent lamps is a great advantage since they solve problems related to the endurance and the high power consumption typical of lamps. LED characteristics in fact are a high reliability, low consumption and elevate resistance to vibrations.

Available versions

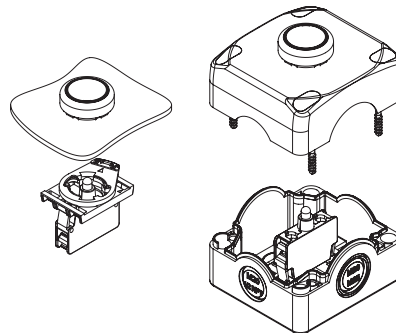

The LED holders of the control and signalling devices have two types of fixing: panel and base fixing.

Wide voltage range

The LED holders of the control and signalling devices offer a wide voltage range, always maintaining an unchanged brilliancy.

Data type approved by UL

Rated supply voltage U_n : 12-30 Vac/dc,
Rated supply current I_n : 5-15 mA

Note:

- Use copper wire (Cu) 60 or 75 °C rigid or flexible with cross section 12-20 AWG.
- Terminals tightening torque 7,1 Lb In (0,8 Nm).

Data type approved by IMQ





Rated insulation voltage (U_i): 500 V
Type of luminous indicator: incorporated LED
Fixing hole diameter: D22
Terminals: screw clamps
Rated operating voltage (U_e): 12-30 V a.c./d.c. (5 – 15 mA),
120 V a.c. (10 mA), 230 V a.c. (10 mA)



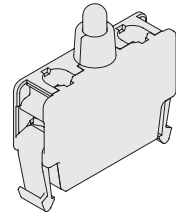
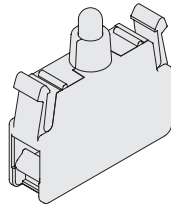

Conformity with standards: EN 60947-1, EN 60947-5-1:2004 + A1:2009, fundamental requirements of 2006/95/CE Low Voltage Directive.

LED holders selection table

5 pcs packs







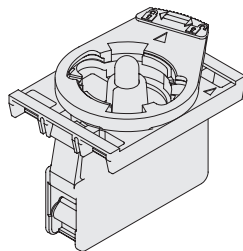

LED colour	Actuator colour	Panel fixing		
		Operation voltage		
		12 ... 30 Vac/dc	120 Vac	230 Vac
 white	white / yellow	E2 LP1A2V1	E2 LP3A2V1	E2 LP4A2V1
 red	red	E2 LP1A3V1	E2 LP3A3V1	E2 LP4A3V1
 green	green	E2 LP1A4V1	E2 LP3A4V1	E2 LP4A4V1
 blue	blue	E2 LP1A6V1	E2 LP3A6V1	E2 LP4A6V1
 orange	orange	E2 LP1A8V1	E2 LP3A8V1	E2 LP4A8V1

LED colour	Actuator colour	Base fixing		
		Operation voltage		
		12 ... 30 Vac/dc	120 Vac	230 Vac
 white	white / yellow	E2 LF1A2V1	E2 LF3A2V1	E2 LF4A2V1
 red	red	E2 LF1A3V1	E2 LF3A3V1	E2 LF4A3V1
 green	green	E2 LF1A4V1	E2 LF3A4V1	E2 LF4A4V1
 blue	blue	E2 LF1A6V1	E2 LF3A6V1	E2 LF4A6V1
 orange	orange	E2 LF1A8V1	E2 LF3A8V1	E2 LF4A8V1

Attention! Comply with the combination between Led and actuators colours.

Complete units with LED holders and fixing adapter



LED colour	LED			Panel fixing
	pos 2	pos 3	pos 1	Operation voltage
				12 ... 30 Vac/dc
 white	-	LED	-	E2 AC-XXBC0053 E2 1BAC11 + E2 LP1A2V1
 red	-	LED	-	E2 AC-XXBC0055 E2 1BAC11 + E2 LP1A3V1
 green	-	LED	-	E2 AC-XXBC0054 E2 1BAC11 + E2 LP1A4V1
 blue	-	LED	-	E2 AC-XXBC0056 E2 1BAC11 + E2 LP1A6V1
 orange	-	LED	-	E2 AC-XXBC0057 E2 1BAC11 + E2 LP1A8V1

Items with code on the **green** background are available in stock

Complete units with LED holders, contact block and fixing adapter

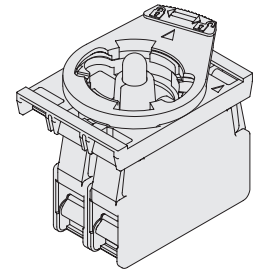
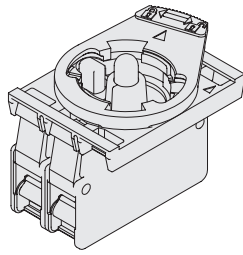

LED colour	Contacts			Panel fixing
	pos 2	pos 3	pos 1	Operation voltage
				12 ... 30 Vac/dc
blanc	1NC ⊕	LED	-	E2 AC-XXBC0020 E2 1BAC11 + E2 CP01G2V1 + E2 LP1A2V1
rouge	1NC ⊕	LED	-	E2 AC-XXBC0037 E2 1BAC11 + E2 CP01G2V1 + E2 LP1A3V1
vert	1NC ⊕	LED	-	E2 AC-XXBC0029 E2 1BAC11 + E2 CP01G2V1 + E2 LP1A4V1
bleu	1NC ⊕	LED	-	E2 AC-XXBC0045 E2 1BAC11 + E2 CP01G2V1 + E2 LP1A6V1
orange	1NC ⊕	LED	-	E2 AC-XXBC0058 E2 1BAC11 + E2 CP01G2V1 + E2 LP1A8V1

LED colour	Contacts			Panel fixing
	pos 2	pos 3	pos 1	Operation voltage
				12 ... 30 Vac/dc
blanc	-	LED	1NO	E2 AC-XXBC0021 E2 1BAC11 + E2 LP1A2V1 + E2 CP10G2V1
rouge	-	LED	1NO	E2 AC-XXBC0039 E2 1BAC11 + E2 LP1A3V1 + E2 CP10G2V1
vert	-	LED	1NO	E2 AC-XXBC0031 E2 1BAC11 + E2 LP1A4V1 + E2 CP10G2V1
bleu	-	LED	1NO	E2 AC-XXBC0047 E2 1BAC11 + E2 LP1A6V1 + E2 CP10G2V1
orange	-	LED	1NO	E2 AC-XXBC0059 E2 1BAC11 + E2 LP1A8V1 + E2 CP10G2V1

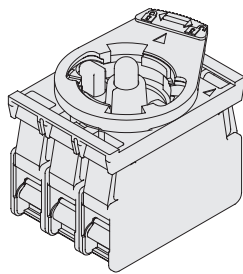

LED colour	Contacts			Panel fixing
	pos 2	pos 3	pos 1	Operation voltage
				12 ... 30 Vac/dc
blanc	1NC ⊕	LED	1NO	E2 AC-XXBC0027 E2 1BAC11 + E2 CP01G2V1 + E2 LP1A2V1 + E2 CP10G2V1
rouge	1NC ⊕	LED	1NO	E2 AC-XXBC0044 E2 1BAC11 + E2 CP01G2V1 + E2 LP1A3V1 + E2 CP10G2V1
vert	1NC ⊕	LED	1NO	E2 AC-XXBC0036 E2 1BAC11 + E2 CP01G2V1 + E2 LP1A4V1 + E2 CP10G2V1
bleu	1NC ⊕	LED	1NO	E2 AC-XXBC0052 E2 1BAC11 + E2 CP01G2V1 + E2 LP1A6V1 + E2 CP10G2V1
orange	1NC ⊕	LED	1NO	E2 AC-XXBC0060 E2 1BAC11 + E2 CP01G2V1 + E2 LP1A8V1 + E2 CP10G2V1

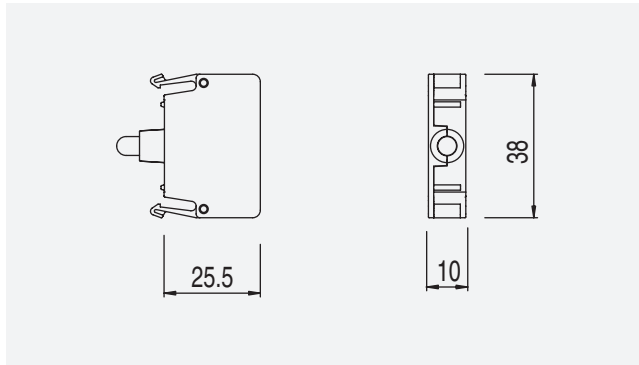
Dimensions**Panel fixing contact block**

All measures in the drawings are in mm

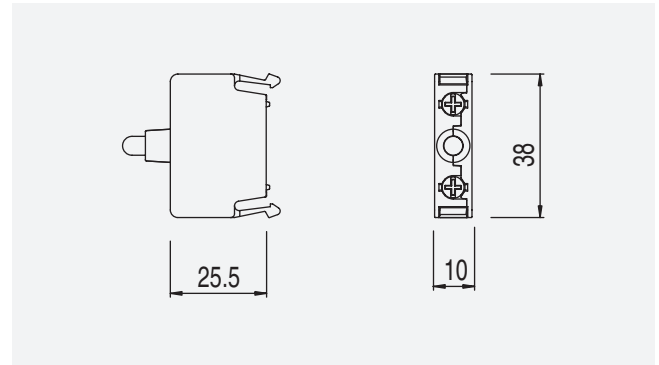
Base fixing contact block

→ 2D and 3D files available on www.pizzato.it

Selection diagram

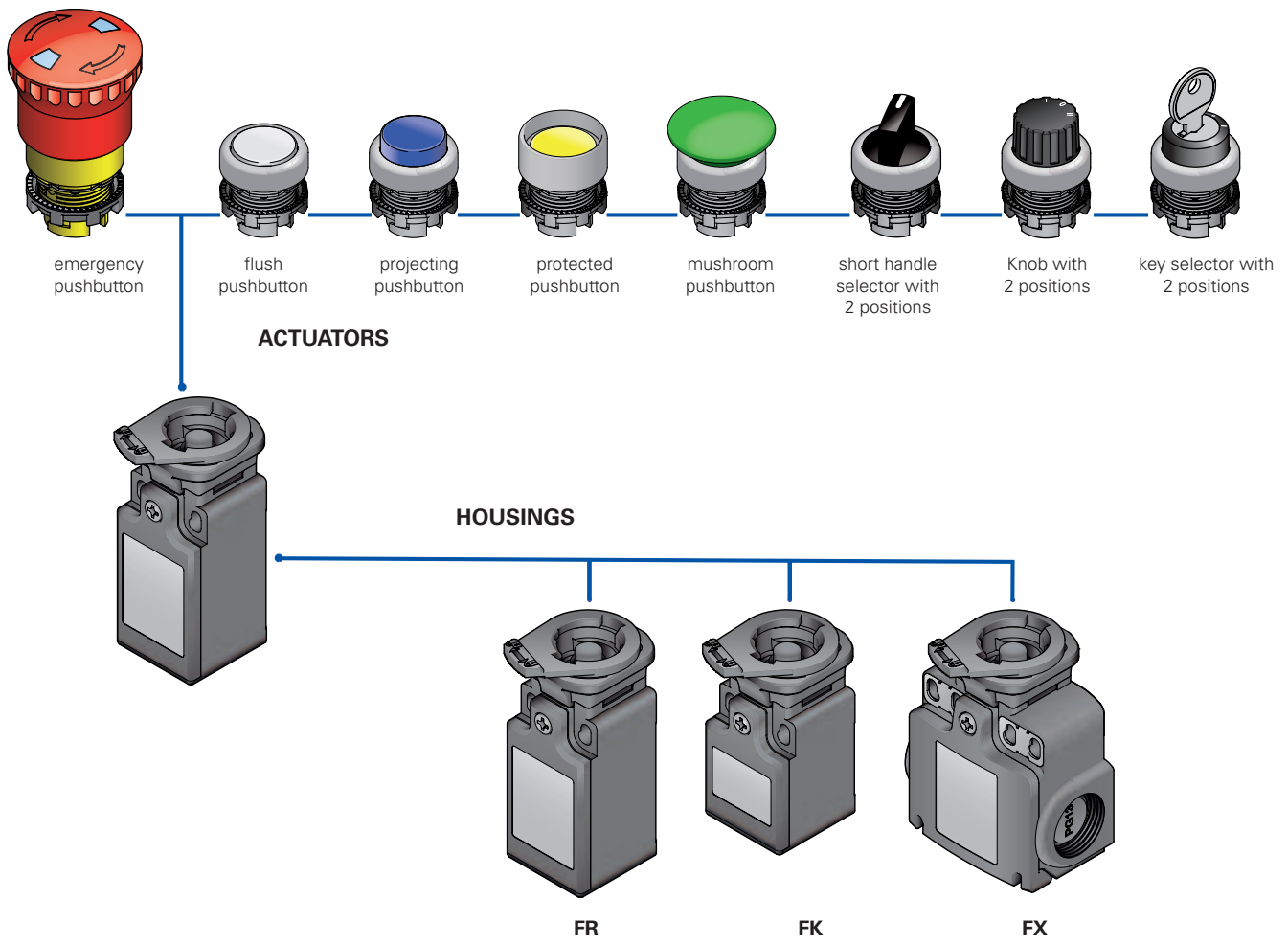

Contact block code structure

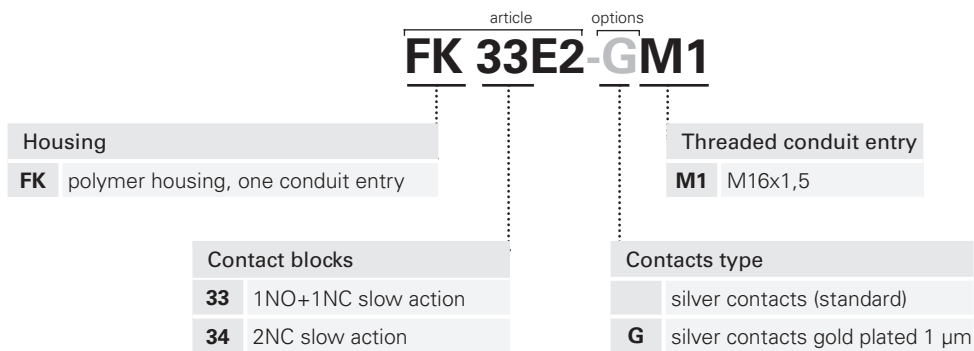
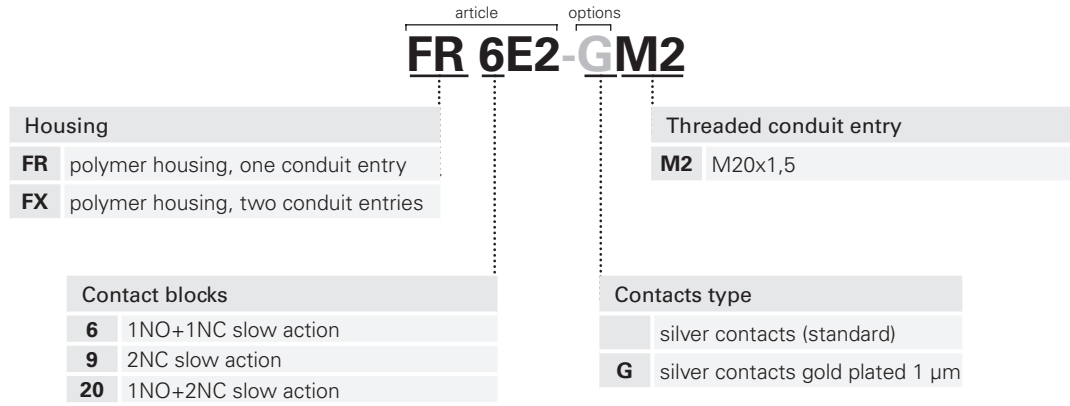

Attention! The feasibility of a code number does not mean the effective availability of a product. Please contact our sales office.



Main data

- Protection degree IP67
- Made of glass-reinforced polymer
- Silver contacts gold plated versions

Markings and quality marks:



Approval UL: E131787

Approval GOST: POCC IT.AB24.B04512

In conformity with requirements requested by:

Low Voltage Directive 2006/95/EC, Machinery Directive 2006/42/EC and Electromagnetic Compatibility 2004/108/EC.

Positive contact opening in conformity with standards:

IEC 60947-5-1, EN 60947-5-1, VDE 0660-206.

The protected contact block only prevents dust and water from the switchboard to enter inside the electrical contacts.

The protected contact block can be combined only to the following devices:

- pushbutton E2 1PU●●●●●●
- emergency pushbuttons E2 1PE●●●●●●
- two-position selectors E2 1SE●2●●●●●●
- two-position key selectors E2 1SC2●●●●●●.

Technical data

General data

Made of glass-reinforced polymer, self-extinguishing, shock-proof thermoplastic resin and with double insulation □

FR and FK series one conduit entry

FX series two conduit entries

Protection degree:

IP67 according to IEC 60529 with cable gland having equal or higher protection degree (electrical contacts)

Ambient temperature:

from -25°C to +80°C

Max actuation frequency:

3600 operations cycles¹/hour

Mechanical endurance:

20 million operations cycles¹

Utilization requirements:

see page 78

(1) One operation cycle means two movements, one to close and one to open contacts, as foreseen by EN 60947-5-1 standard.

Contact block

Contacts commutation force FR, FX series

1NO+1NC: 3,3 N (NC) / 6 N (NO)

2NC: 6,5 N

1NO+2NC: 5,8 N (NC) / 6,5 N (NO)

Contacts commutation force FK series

1NO+1NC: 4,5 N (NC) / 5,3 N (NO)

2NC: 4,4 N

End travel force FR, FX series

1NO+1NC: 9 N

2NC: 8,5 N

1NO+2NC: 10,3 N

End travel force FK series

1NO+1NC: 9,3 N

2NC: 8 N

Positive opening force: 25 N

Activating speed: min 1 mm/s

max 0,5 m/s

Contacts material:

silver contacts (standard)

Contacts for weak current in silver, 1µm thick gold-plating (on request)

Contact blocks 20, 33, 34: min. 1 x 0,34 mm² (1 x AWG 22)

max. 2 x 1,5 mm² (2 x AWG 16)

Contact blocks 6, 9:

min. 1 x 0,5 mm² (1 x AWG 20)

max. 2 x 2,5 mm² (2 x AWG 14)

Screw terminal driving torque:

0,6 ... 0,8 Nm

In conformity with standards:

IEC 60947-5-1, EN 60947-5-1, EN 60947-1, EN 50047, IEC 60204-1, EN 60204-1, EN 1088, EN ISO 12100-1, EN ISO 12100-2, IEC 60529, EN 60529, NFC 63-140, VDE 0660-200, VDE 0113.

⚠ Installation for safety applications:

Use only contact blocks marked with the symbol ⊕. The safety circuit must always be connected with the **NC contacts** (normally closed contacts: 11-12, 21-22 or 31-32) as stated in the **standard EN 60947-5-1, encl. K, par. 2**. The switch must be actuated **at least up to the positive opening travel** shown in the travels diagrams with the symbol ⊕. The switch must be actuated at least with the positive opening force, shown in the general data.

Electrical data

without connector	Thermal current (I _{th}):	10 A
	Rated insulation voltage (U _i):	500 Vac 600 Vdc 400 Vac 500 Vdc (contact blocks 20, 33, 34)
	Rated impulse withstand voltage (U _{imp}):	6 kV 4 kV (contact blocks 20, 33, 34)
	Conditional short circuit current:	1000 A according to EN 60947-5-1
	Protection against short circuits:	fuse 10 A 500 V type aM
	Pollution degree:	3

Utilization categories

Alternate current: AC15 (50...60 Hz)			
U _e (V)	250	400	500
I _e (A)	6	4	1
Direct current: DC13			
U _e (V)	24	125	250
I _e (A)	6	1,1	0,4

Data type approved by UL

Utilization categories Q300 (69 VA, 125-250 Vdc)
A600 (720 VA, 120-600 Vac)

Data of the housing type 1, 4X "indoor use only", 12, 13

For all contact blocks except 2 and 3 use 60 or 75 °C copper (Cu) conductor and wire size No. 12-14 AWG. Terminal tightening torque of 7,1 lb in (0,8 Nm).
For contact blocks 2 and 3 use 60 or 75 °C copper (Cu) conductor and wire size No. 14 AWG. Terminal tightening torque of 12 lb in (1,4 Nm).

In conformity with standard: UL 508

Applications







Protected contact block for control devices on switchboards with presence of dust. This contact block allows all its electrical contacts to be IP67.

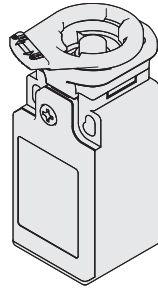

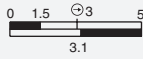

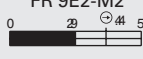
Please contact our technical service for the list of approved products.

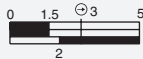
Contact block selection table

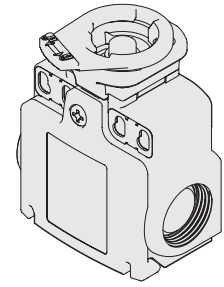

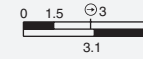

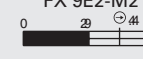
Contact blocks	Article
1NO+1NC slow action 	FR 6E2-M2 
2NC slow action 	FR 9E2-M2 
1NO+2NC slow action 	FR 20E2-M2 

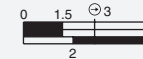

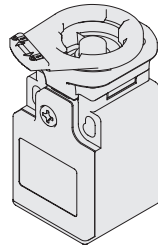
Contact blocks	Article
1NO+1NC slow action 	FX 6E2-M2 
2NC slow action 	FX 9E2-M2 
1NO+2NC slow action 	FX 20E2-M2 

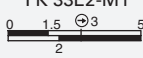

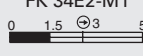
Contact blocks	Article
1NO+1NC slow action 	FK 33E2-M1 
2NC slow action 	FK 34E2-M1 

Dimensions

FR series

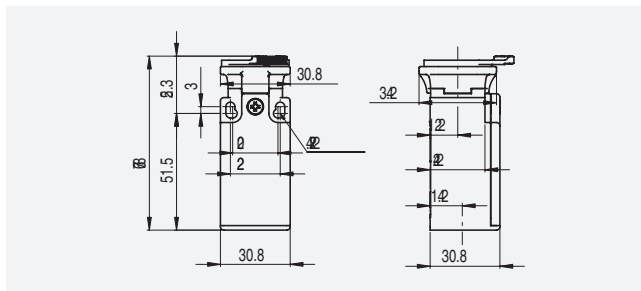

FX series

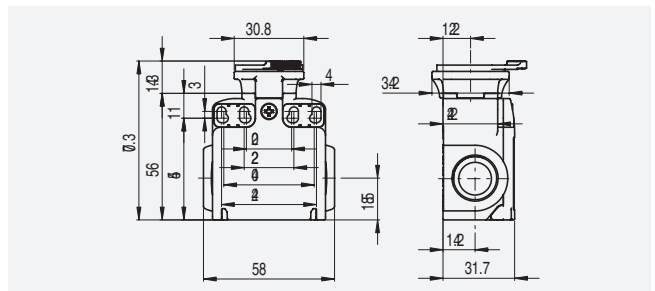

FK series

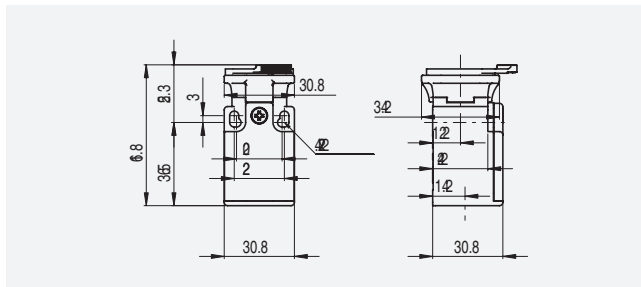

Selection diagram

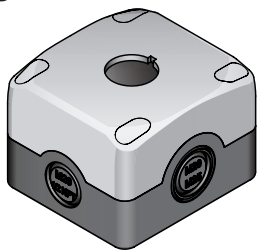

ES 31000
grey cover
1 hole, Ø 22 mm

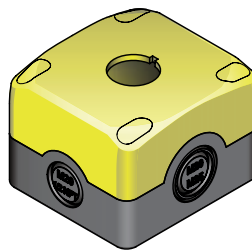

ES 31001
yellow cover
1 hole, Ø 22 mm

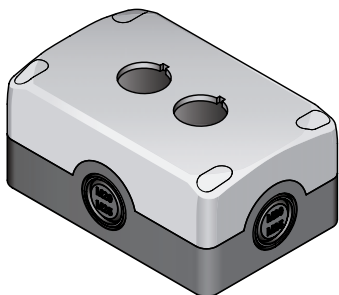

ES 32000
grey cover
2 holes, Ø 22 mm

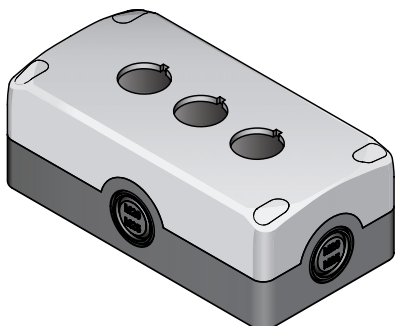

ES 33000
grey cover
3 holes, Ø 22 mm

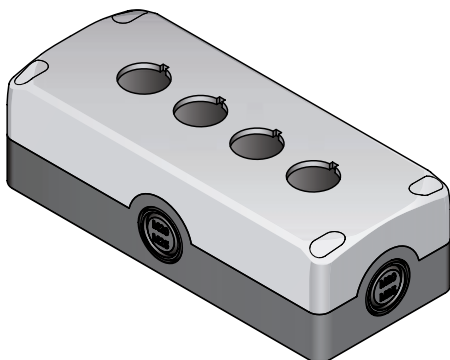

ES 34000
grey cover
4 holes, Ø 22 mm



ES 36000
grey cover
6 holes, Ø 22 mm

Enclosure code structure

ES 31001

Housing material		Configuration	
3	polycarbonate PC (standard)	000	black base, grey cover
		001	black base, yellow cover
	
Box dimensions			
1	72x80h56 mm		
2	120x80h56 mm		
3	153x80h56 mm		
4	186x80h56 mm		
6	252x80h56 mm		

Attention! The feasibility of a code number does not mean the effective availability of a product. Please contact our sales office.



Main features

- Protection degree IP67 and IP69K
- Stainless steel retained screws
- 4 lateral knock out conduit entries
- Supplied with screw caps

Markings and quality marks:



Approval GOST: POCC IT.AB24.B04512

Technical data

Housing

Material:

Shock-proof, self-extinguishing polymer with double insulation, UV resistant, fibreglass-reinforced material, high-impact resistance.

Screw material:

Stainless steel

Protection degree:

IP67 according to IEC 60529

Conduit entries:

1 hole housing:

• 2 upper and lower knock out conduit entries M20 - 1/2 NPT

• 2 lateral knock out conduit entries M20 - 1/2 NPT - M25

• 2 base knock out conduit entries M16

2-3-4-6 holes housings:

• 4 lateral knock out conduit entries M20 - 1/2 NPT - M25

• 2 base knock out conduit entries M20

Devices assembling:

Suit for assembling with control and signalling Ø 22 mm devices.

Ø 22 mm hole according to EN 60947-5-1

Utilization requirements:

see page 78

General data

Ambient temperature:

-40°C +80°C

Cover screws driving torque:

1 ... 1,4 Nm

In conformity with standards:

IEC 60947-1, IEC 60947-5-1, IEC 60204-1, EN 60947-1, EN 60947-5-1, EN 60204-1, UL 508, CSA 22-2 N°14.

In conformity with requirements requested by:

Low Voltage Directive 2006/95/EC, Machinery Directive 2006/42/EC and Electromagnetic Compatibility 2004/108/EC.

General characteristics

Protection degree IP67 and IP69K

Designed to be employed also in severe environment conditions, Pizzato Elettrica enclosures have protection degree IP67 and IP69K, suitable for use in machineries subjected to intense washing with high pressure and high temperature water jets.

Fitting the EROUND boxes

The new EROUND line boxes by Pizzato Elettrica feature 4 additional holes in the cover, which make it possible to fit the boxes to a wall by inserting the screws through their external part, therefore without needing to open their cover to gain access to the holes.

The wall-fitting screws and the box cover closing screws can be sealed by means of 4 caps (caps supplied with the box) which, besides improving the appearance of the box line, avoid any dirt being deposited inside the screw recesses and

make tampering more difficult.

External fitting turns out to be particularly advantageous for prewired boxes, since the entire installation work becomes simpler; all that is needed is to fix the box and attach the connector which, thanks to the cable inlets available on the four sides of the box, can be positioned in the chosen direction.

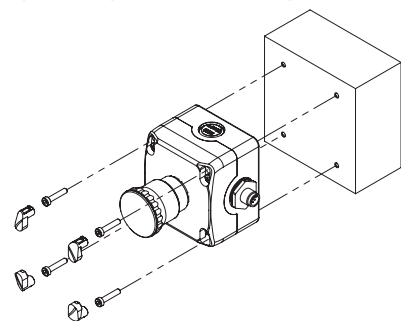

One housing, two solutions

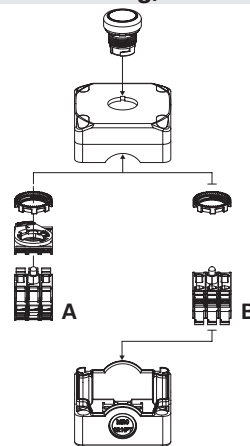

The same housing can have up to 3 contact/LED blocks with panel fixing (E2 CP, E2 LP) to be applied through the fixing adapter (A) or up to 3 contact/LED blocks with base fixing (E2 CF, E2 LF) to be fixed directly to the enclosure base (B).

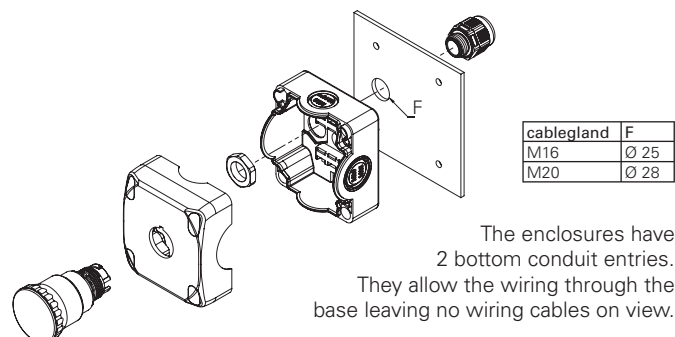

Wiring through the lower surface

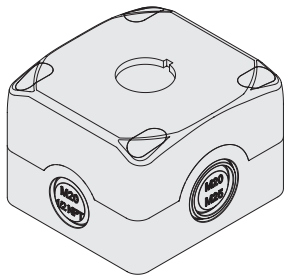

The enclosures have 2 bottom conduit entries. They allow the wiring through the base leaving no wiring cables on view.

Enclosures selection table



Cover colour	Article
 yellow RAL 1003	ES 31001
 grey RAL 7035	ES 31000

The standard colour of the base in above mentioned codes is **BLACK RAL 9005**.

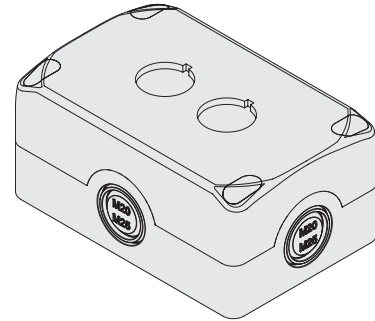

Cover colour	Article
 grey RAL 7035	ES 32000

The standard colour of the base in above mentioned codes is **BLACK RAL 9005**.

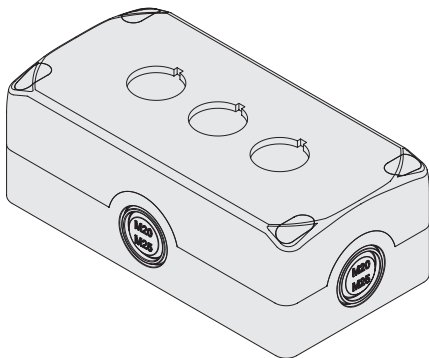

Cover colour	Article
 grey RAL 7035	ES 33000

The standard colour of the base in above mentioned codes is **BLACK RAL 9005**.

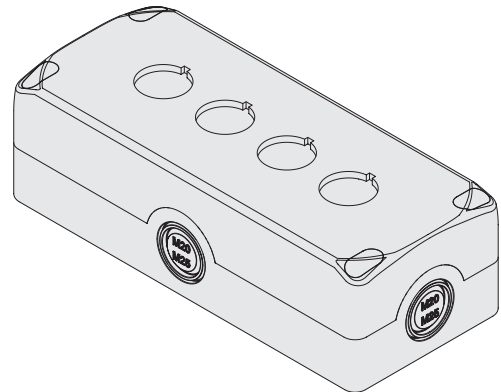

Cover colour	Article
 grey RAL 7035	ES 34000

The standard colour of the base in above mentioned codes is **BLACK RAL 9005**.

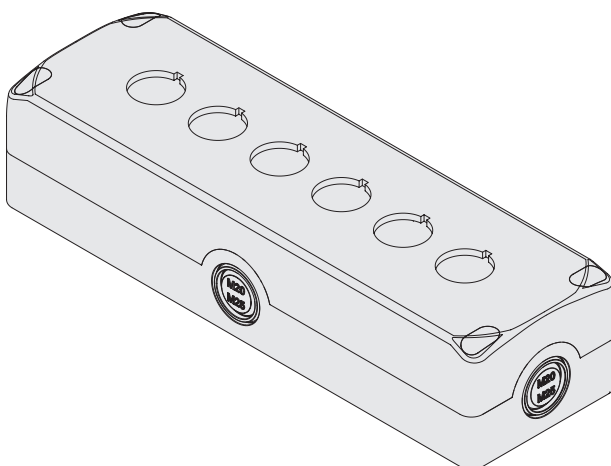

Cover colour	Article
 grey RAL 7035	ES 36000

The standard colour of the base in above mentioned codes is **BLACK RAL 9005**.

Items with code on the **green** background are available in stock

Complete units with enclosures

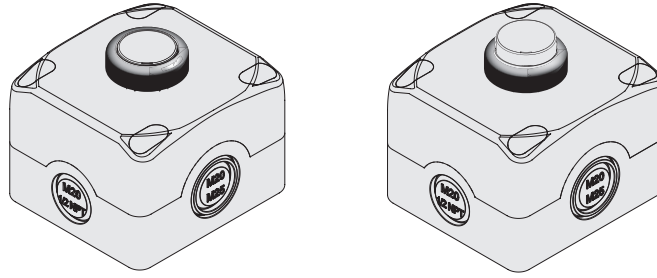

Box cover colour	Actuator colour and marking	Contacts			Flush pushbutton Black ring	Projecting pushbutton Black ring
		pos 2	pos 3	pos 1		
grey RAL 7035	green	-	1NO	-	ES AC31001 ES 31000 + E2 1PU2R421L2 + E2 CF10G2V1	-
grey RAL 7035	red	-	1NC 	-	ES AC31002 ES 31000 + E2 1PU2R321L1 + E2 CF01G2V1	ES AC31017 ES 31000 + E2 1PU2S321L1 + E2 CF01G2V1
grey RAL 7035	green	-	1NO	-	ES AC31015 ES 31000 + E2 1PU2R421GB1 + E2 CF10G2V1	-
grey RAL 7035	red	-	1NC 	-	ES AC31016 ES 31000 + E2 1PU2R321GB0 + E2 CF01G2V1	ES AC31018 ES 31000 + E2 1PU2S321GB0 + E2 CF01G2V1

The standard colour of the base in above mentioned codes is **BLACK RAL 9005**.

→ For contact blocks and pushbuttons characteristics see the relative chapters.

Complete units with enclosures

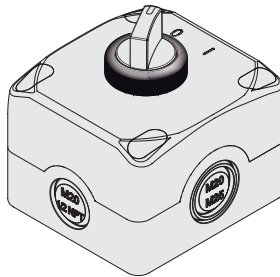

Box cover colour	Position	Contacts			Two positions black selector Black ring
		pos 2	pos 3	pos 1	
grey RAL 7035		-	1NO	-	ES AC31019 ES 31002 + E2 1SE12AVA11AB + E2 CF10G2V1

The standard colour of the base in above mentioned codes is **BLACK RAL 9005**.

→ For contact blocks and LED holders characteristics see the relative chapters.

Complete units with enclosures

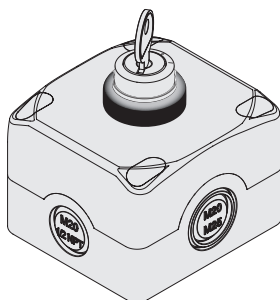

Box cover colour	Position	Contacts			Two positions key black selector Black ring
		pos 2	pos 3	pos 1	
grey RAL 7035		-	1NO	-	ES AC31020 ES 31000 + E2 1SC2AVA11AE + E2 CF10G2V1





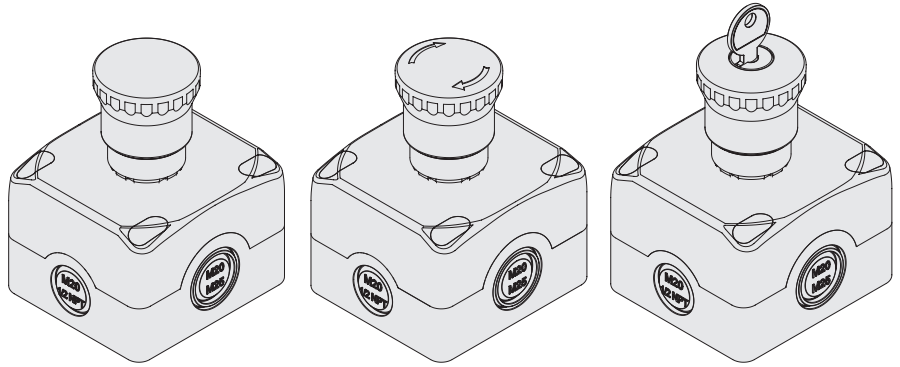

The standard colour of the base in above mentioned codes is **BLACK RAL 9005**.

→ For contact blocks and LED holders characteristics see the relative chapters.

Legend: Stay-put Spring-return Key withdrawal position

Complete units with enclosures







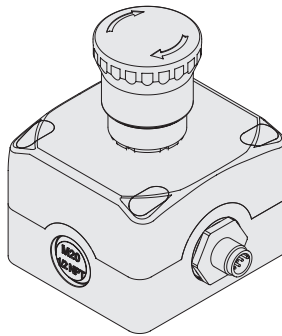

Box cover colour	Actuator colour and marking	Contacts			Push-pull emergency button	Turn to release emergency pushbutton	Key release emergency pushbutton
		pos 2	pos 3	pos 1			
yellow RAL 1023	red	-	1NC 	-	ES AC31004 ES 31001 + E2 1PEPZ4531 + E2 CF01G2V1	ES AC31003 ES 31001 + E2 1PERZ4531 + E2 CF01G2V1	ES AC31022 ES 31001 + E2 1PEBZ4531 + E2 CF01G2V1
yellow RAL 1023	red	-	1NC  SELF-MONITORED	-	ES AC31081 ES 31001 + E2 1PEPZ4531 + E2 CF01S2V1	ES AC31082 ES 31001 + E2 1PERZ4531 + E2 CF01S2V1	ES AC31083 ES 31001 + E2 1PEBZ4531 + E2 CF01S2V1
Yellow RAL 1023	red	1NC 	-	1NC 	-	ES AC31005 ES 31001 + E2 1PERZ4531 + E2 CF01G2V1 + E2 CF01G2V1	ES AC31023 ES 31001 + E2 1PEBZ4531 + E2 CF01G2V1 + E2 CF01G2V1
yellow RAL 1023	red	1NC 	-	1NO	-	ES AC31006 ES 31001 + E2 1PERZ4531 + E2 CF01G2V1 + E2 CF10G2V1	ES AC31011 ES 31001 + E2 1PEBZ4531 + E2 CF01G2V1 + E2 CF10G2V1
yellow RAL 1023	red	1NC 	1NC 	1NO	-	ES AC31021 ES 31001 + E2 1PERZ4531 + E2 CF01G2V1 + E2 CF01G2V1 + E2 CF10G2V1	ES AC31024 ES 31001 + E2 1PEBZ4531 + E2 CF01G2V1 + E2 CF01G2V1 + E2 CF10G2V1

The standard colour of the base in above mentioned codes is BLACK RAL 9005.

→ For contact blocks and emergency pushbuttons characteristics see the relative chapters.



Box cover colour	Actuator colour and marking	Contacts			Turn to release emergency pushbutton Plastic wired M12 connector
		pos 2	pos 3	pos 1	
yellow RAL 1023	red	-	1NC 	-	ES AC31025
yellow RAL 1023	red	-	1NC  SELF-MONITORED	-	ES AC31084
yellow RAL 1023	red	1NC 	-	1NC 	ES AC31026
yellow RAL 1023	red	1NC 	-	1NO	ES AC31027
yellow RAL 1023	red	1NC 	1NC 	1NO	ES AC31028

The standard colour of the base in above mentioned codes is BLACK RAL 9005.

→ For contact blocks and emergency pushbuttons characteristics see the relative chapters.

Spare caps

Article	Description
 VETS35RA1	4 spare caps for box covers ES series. Colour: yellow
 VETS39RA1	4 spare caps for box covers ES series. Colour: grey

Accessories

→ [More ACCESSORIES at page 75](#)

Items with code on the green background are available in stock



ES AC32012				
Description	Characteristics			Diagram
Pushbutton - 1NO E2 1PU2R221L9 Contacts 1x E2 CF10G2V1	Flush, spring-return, white			
	pos 2 /	pos 3 1NO	pos 1 /	
Pushbutton - 1NO E2 1PU2R121L10 Contacts 1x E2 CF10G2V1	Flush, spring-return, black			
	pos 2 /	pos 3 1NO	pos 1 /	



ES AC32010				
Description	Characteristics			Diagram
Pushbutton - 1NO E2 1PU2R421L35 Contacts 1x E2 CF10G2V1	Flush, spring-return, green			
	pos 2 /	pos 3 1NO	pos 1 /	
Pushbutton - 1NC E2 1PU2S321L1 Contacts 1x E2 CF01G2V1	Projecting, spring-return, red			
	pos 2 /	pos 3 1NC ⊖	pos 1 /	



ES AC32011				
Description	Characteristics			Diagram
Pushbutton - 1NO E2 1PU2R421L51 Contacts 1x E2 CF10G2V1	Flush, spring-return, green			
	pos 2 /	pos 3 1NO	pos 1 /	
Pushbutton - 1NC E2 1PU2S321L48 Contacts 1x E2 CF01G2V1	Projecting, spring-return, red			
	pos 2 /	pos 3 1NC ⊖	pos 1 /	



ES AC33017				
Description	Characteristics			Diagram
Pushbutton - 1NO E2 1PU2R221L9 Contacts 1x E2 CF10G2V1	Flush, spring-return, white			
	pos 2 /	pos 3 1NO	pos 1 /	
Pushbutton - 1NC E2 1PU2S321L1 Contacts 1x E2 CF01G2V1	Projecting, spring-return, red			
	pos 2 /	pos 3 1NC ⊖	pos 1 /	
Pushbutton - 1NO E2 1PU2R121L10 Contacts 1x E2 CF10G2V1	Flush, spring-return, black			
	pos 2 /	pos 3 1NO	pos 1 /	



ES AC33013				
Description	Characteristics			Diagram
Indicator light E2 1LA310 + E2 LF1A3V1	Red indicator light 12 ... 30 Vac/dc			
Pushbutton - 1NO E2 1PU2R421L35 Contacts 1x E2 CF10G2V1	Flush, spring-return, green			
	pos 2 /	pos 3 1NO	pos 1 /	
Pushbutton - 1NC E2 1PU2S321L1 Contacts 1x E2 CF01G2V1	Projecting, spring-return, red			
	pos 2 /	pos 3 1NC ⊖	pos 1 /	



ES AC33016				
Description	Characteristics			Diagram
Pushbutton - 1NO E2 1PU2R421L35 Contacts 1x E2 CF10G2V1	Flush, spring-return, green			
	pos 2 /	pos 3 1NO	pos 1 /	
Pushbutton - 1NC E2 1PU2S321L1 Contacts 1x E2 CF01G2V1	Projecting, spring-return, red			
	pos 2 /	pos 3 1NC ⊖	pos 1 /	
Pushbutton - 1NO E2 1PU2R421L36 Contacts 1x E2 CF10G2V1	Flush, spring-return, green			
	pos 2 /	pos 3 1NO	pos 1 /	

Dimensions

Enclosures (1 hole)

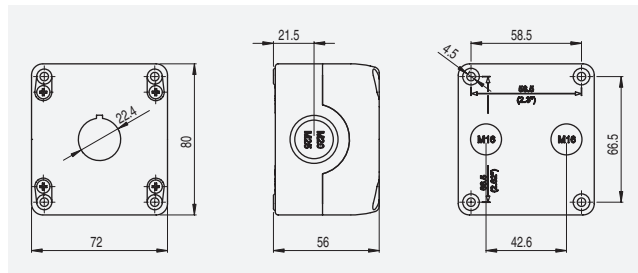

Enclosures (2 holes)

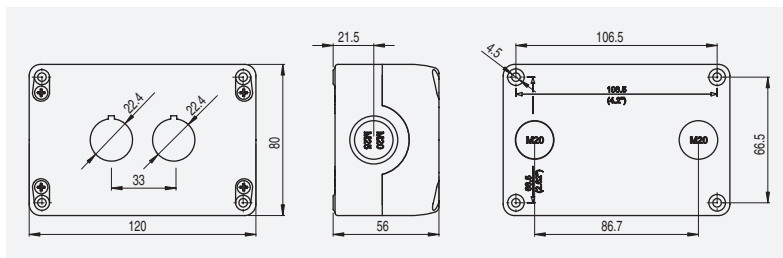

Enclosures (3 holes)

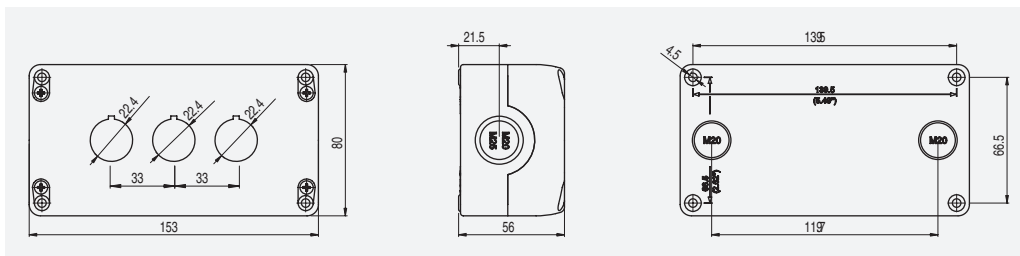

Enclosures (4 holes)

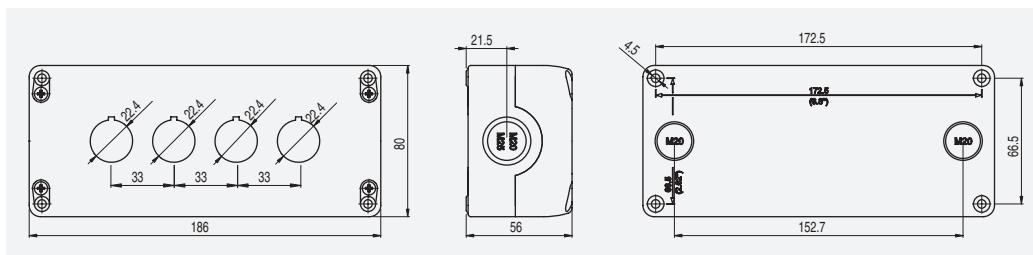

Enclosures (6 holes)

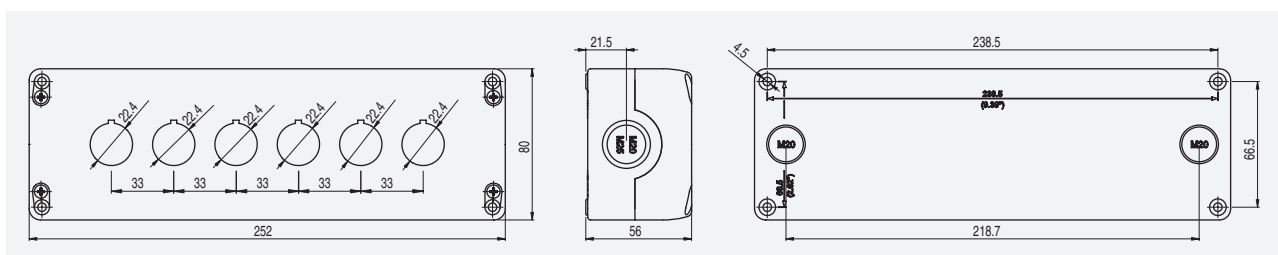

All measures in the drawings are in mm

Selection diagram

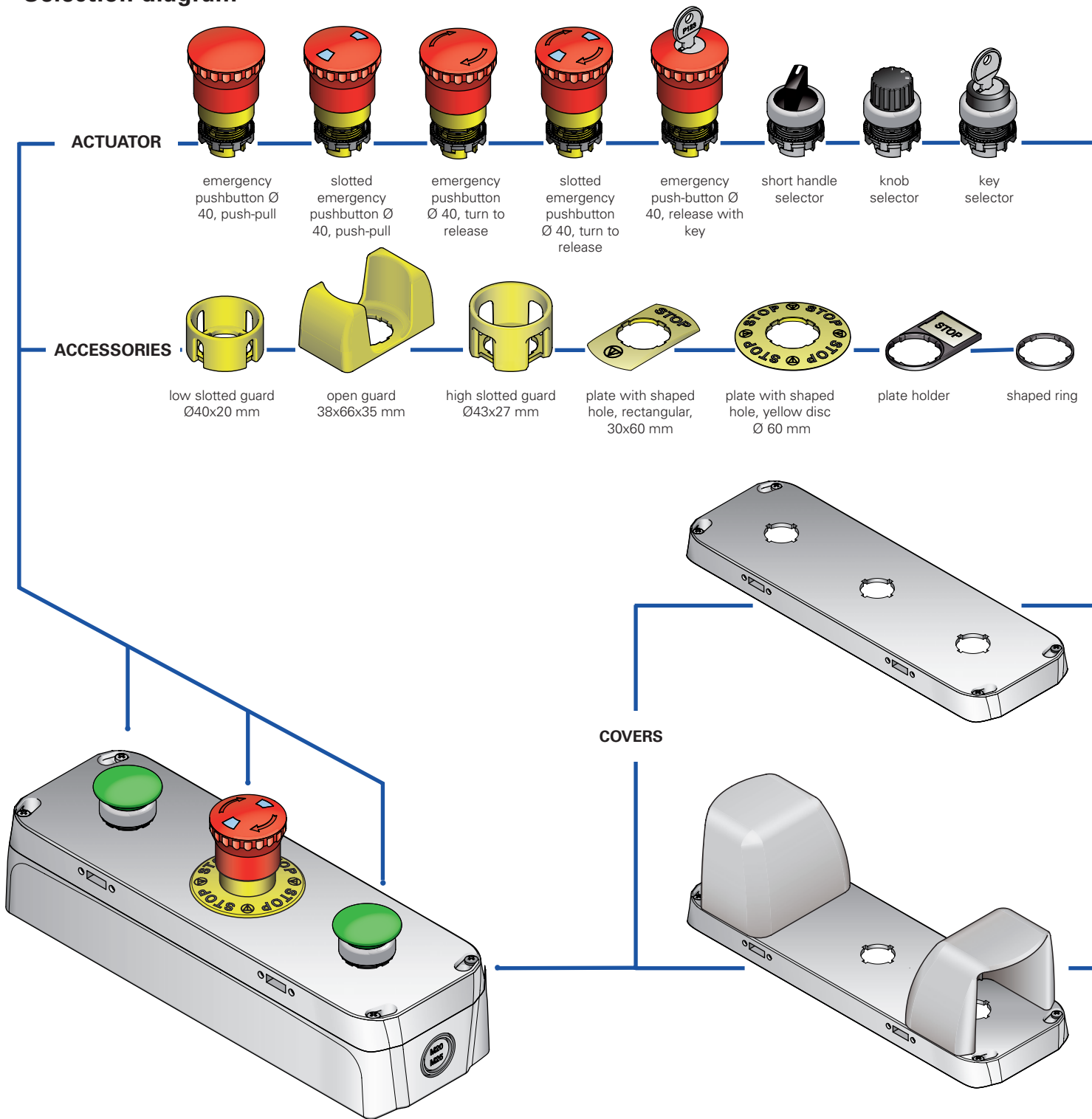

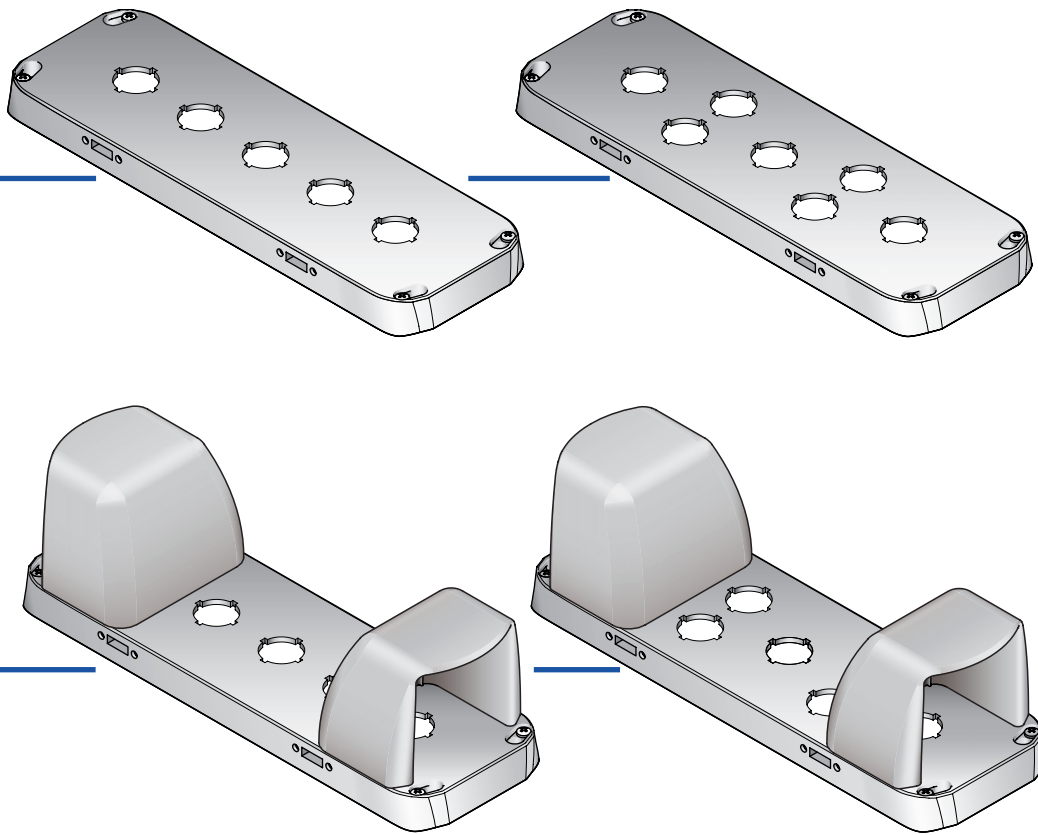
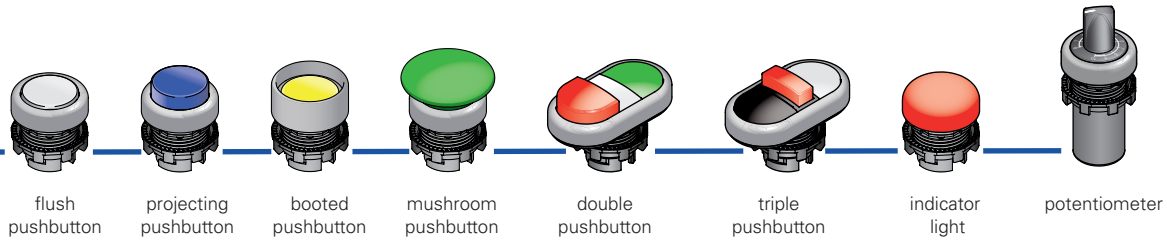

Enclosure code structure

EA 37010

Housing material	3 polycarbonate PC (standard)	Configuration	010 grey base, grey cover
Box dimensions	7 280x90 mm

Attention! The feasibility of a code number does not mean the effective availability of a product. Please contact our sales office.



Technical data

Housing

Material:

Shock-proof, self-extinguishing polymer with double insulation, UV resistant, fibreglass-reinforced material, high-impact resistance.

Screw material:

Stainless steel

Protection degree:

IP65 according to IEC 60529 with cable gland having equal or higher protection degree

Conduit entries:

2 lateral knock out conduit entries

M20 - M25 -1/2 NPT

2 lower knock out conduit entries

M20 - M25 -1/2 NPT

Devices assembling:

Suit for assembling with control and signalling Ø 22 mm devices.

Ø 22 mm hole according to EN 60947-5-1

Utilization requirements:

see page 78

Main features

- Protection degree IP67 and IP69K
- Stainless steel retained screws
- 2 lateral knock out conduit entries + 2 lower knock out conduit entries

General data

Ambient temperature:

-40°C +80°C

Cover screws driving torque:

1 ... 1,4 Nm

In conformity with standards:

IEC 60947-1, IEC 60947-5-1, IEC 60204-1, EN 60947-1, EN 60947-5-1, EN 60204-1, UL 508, CSA 22-2 N°14.

Markings and quality marks:



In conformity with requirements requested by:

Low Voltage Directive 2006/95/EC, Machinery Directive 2006/42/EC and Electromagnetic Compatibility 2004/108/EC.

General characteristics

Fitting the EROUND boxes

The new EROUND line boxes by Pizzato Elettrica feature 4 additional holes in the cover, which make it possible to fit the boxes to a wall by inserting the screws through their external part, therefore without needing to open their cover to gain access to the holes. External fitting turns out to be particularly advantageous for prewired boxes.

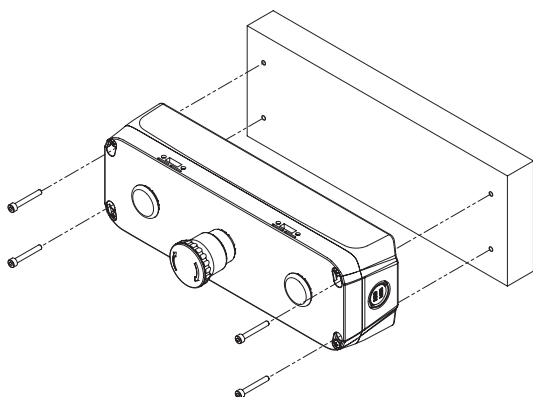

Wiring through the lower surface

The enclosures have 2 bottom conduit entries. They allow the wiring through the base leaving no wiring cables on view.

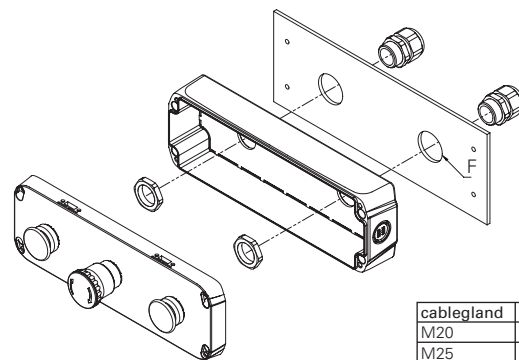

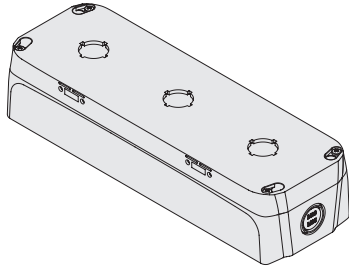

cablegland	F
M20	Ø 28
M25	Ø 34

Enclosures selection table

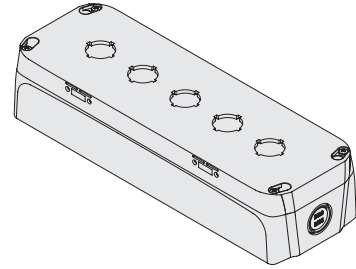

Colour	Article
 grey RAL 7035	EA 37014



Colour	Article
 grey RAL 7035	EA 37010

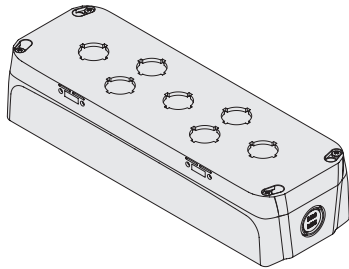

Colour	Article
 grey RAL 7035	EA 37012

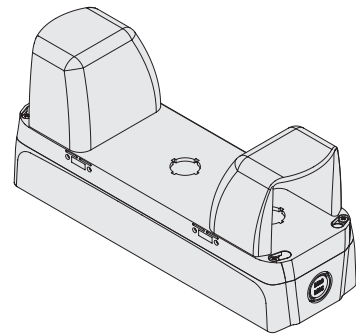

Colour	Article
 grey RAL 7035	EA 37015

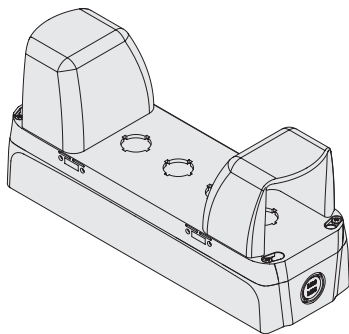

Colour	Article
 grey RAL 7035	EA 37011

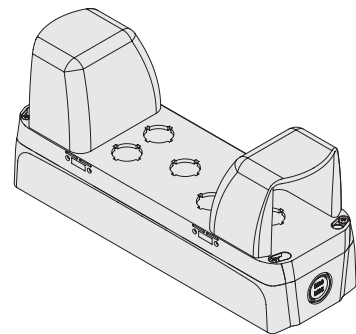

Colour	Article
 grey RAL 7035	EA 37013

Items with code on the **green** background are available in stock

Complete units with enclosures

EA AC37011

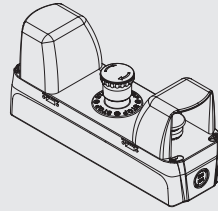
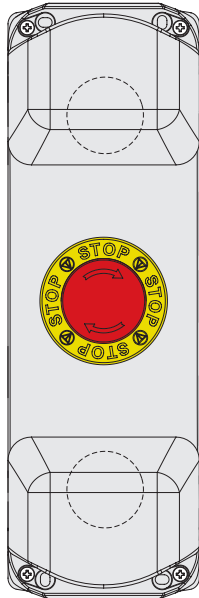

Description	Characteristics			Diagram
Mushroom pushbutton - 1NO E2 1PU2F4490	spring-return, green			
Guard VE GG3AA9A				
Contacts 1x E2 CP10G2V1	pos 2 /	pos 3 1NO	pos 1 /	
Emergency pushbutton Ø 40 - 1NC E2 1PERZ4531	turn to release, 40mm diameter, red			
Plate VE TF32A5109				
Contacts 1x E2 CP01G2V1	pos 2 /	pos 3 1NC ⊖	pos 1 /	
Mushroom pushbutton - 1NO E2 1PU2F4490	spring-return, green			
Guard VE GG3AA9A				
Contacts 1x E2 CP10G2V1	pos 2 /	pos 3 1NO	pos 1 /	

EA AC37010

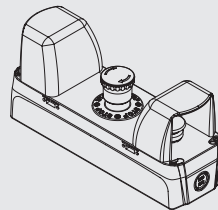
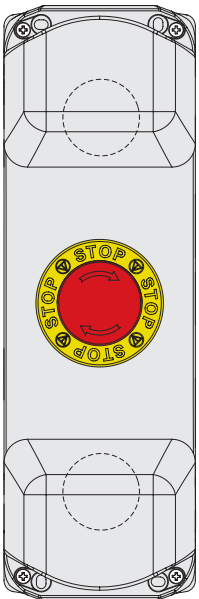

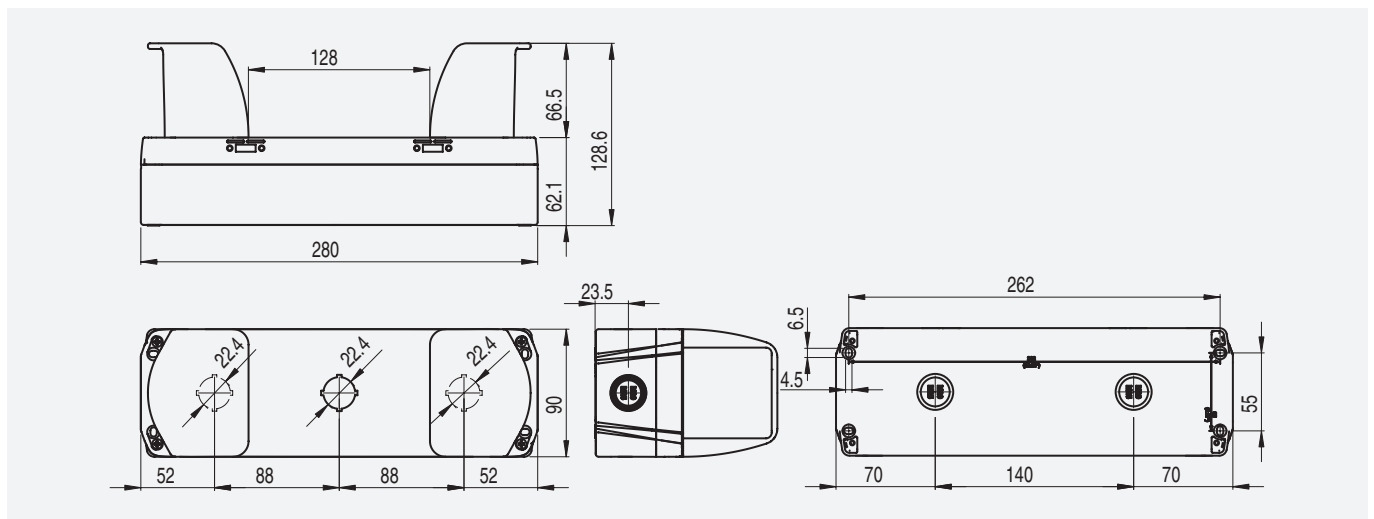
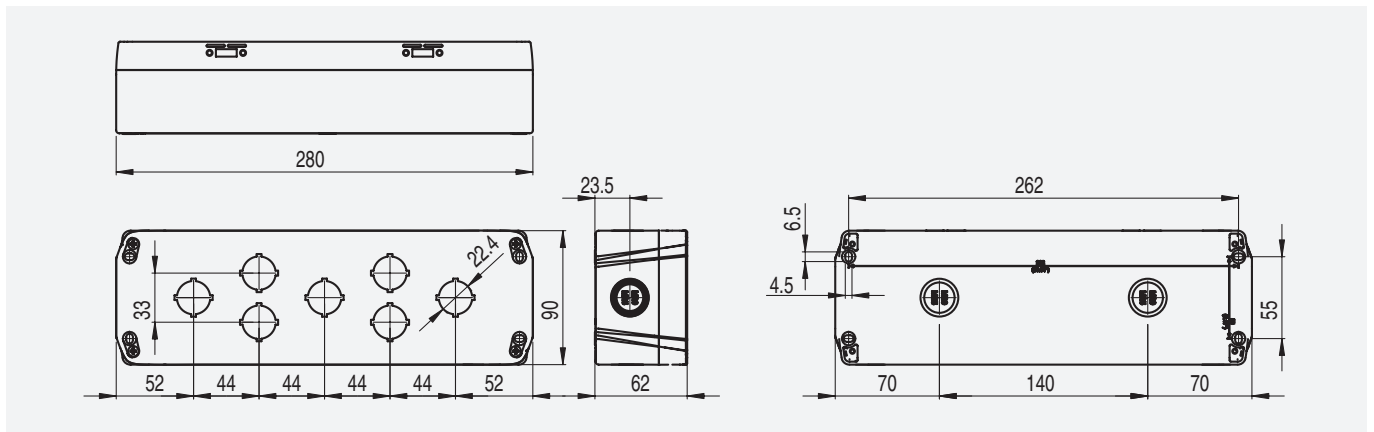
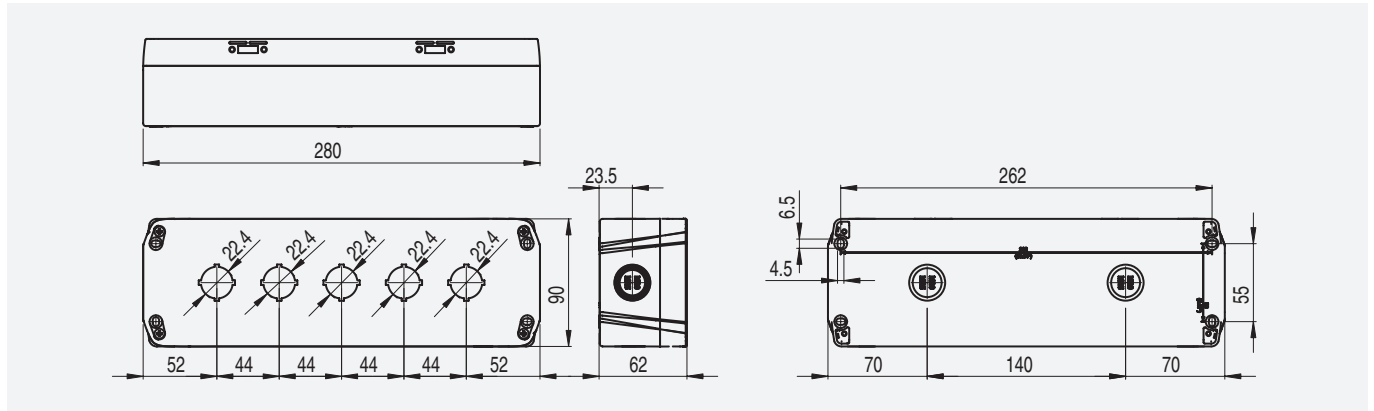

Description	Characteristics			Diagram
Mushroom pushbutton - 1NO+1NC E2 1PU2F4490	spring-return, green			
Guard VE GG3AA9A				
Contacts E2 CP10G2V1 + E2 CP01G2V1	pos 2 /	pos 3 1NO	pos 1 1NC	
Emergency pushbutton Ø 40 - 1NC E2 1PERZ4531	turn to release, 40mm diameter, red			
Plate VE TF32A5109				
Contacts 1x E2 CP01G2V1	pos 2 /	pos 3 1NC ⊖	pos 1 /	
Mushroom pushbutton - 1NO+1NC E2 1PU2F4490	spring-return, green			
Guard VE GG3AA9A				
Contacts E2 CP10G2V1 + E2 CP01G2V1	pos 2 /	pos 3 1NO	pos 1 1NC	

Dimensions



Fixing ring

20 pcs packs

	Article	Description
	VE GF121A	Polymer fixing ring
	VE GF720A	Metal fixing ring

Fixing tool

	Article	Description
	VE CH121A1	Polymer fixing tool for VE GF •••• fixing rings

Fixing adapter

10 pcs packs

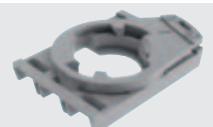
	Article	Description
	E2 1BAC11	Fixing adapter with 3 positions for E2 CP contact block and E2 LP LED holder

	Article	Description
	E2 1BAC21	Fixing adapter with 4 positions for E2 CP contact block

Can be exclusively combined with selectors E2 1SE••••••••, key selectors E2 1SC••••••••, pushbuttons E2 1PU••••••, double pushbuttons E2 1PD••••••••, emergency pushbuttons E2 1PE••••••, configured in the appropriate versions for adapters with 4 positions.

Label holders



Label holder for single device.

Adjustable in 90° steps. Labels from other manufacturer (examples: 3M article KE-7270-2691-3 or GRAFOPLAST article SITM612X) can be used as long as the following dimensions are observed: base 27 +0/-0.4 mm, height 18+0/-0.4 mm, thickness 0,8 ±0,4 mm

Not applicable with double and triple E2 1PD•••••••• - E2 1PT•••••••• pushbuttons.

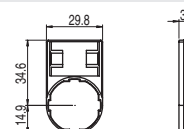
It does not alter the device IP protection degree.

Article	Description	Pcs/ pack
VE PT32A00A0	Label holder with shaped hole, for 18x27 mm label, without label	10
VE PT32A10A0	Label holder with shaped hole, for 18x27 mm label, with transparent protective label, without marking	10
VE PT32A09A•••	Label holder with shaped hole, for 18x27 mm label, with grey label and black marking	1

Not applicable when a shaped ring or a protection hood is fitted



For ordering labels with marking: substitute ••• in the article code with the marking code on table at page 77.

Example: Label holder with label, "STOP" marking

VE PT32A09A••• → VE PT32A09AGB0

Shaped ring

50 pcs packs

	Article	Description
	VE GP12H1A	Shaped ring for single device
	VE GP12L1A	Shaped ring for double and triple E2 1PD•••••••• - E2 1PT••••~•••• pushbuttons

Not applicable when a shaped ring or plate holder is fitted

It does not alter the device IP protection degree.

Labels

	Article	Description	Pcs/ pack
	VE TR3A770	Protective label for VE PT label holder, rectangular 18x27mm thickness 0,4 mm transparent anti-reflective polycarbonate without marking. Ideal for protecting the plate underneath	100
	VE TR4A970	Label for VE PT label holder, rectangular 18x27 mm thickness 0,8 mm gloss aluminium colour RAL 9006 without marking	100
	VE TR4A91•••	Label for VE PT label holder, rectangular 18x27 mm thickness 0,8 mm gloss aluminium colour RAL 9006 with black marking	1

For ordering labels with marking: substitute ••• in the article code with the marking code on table at page 77.

Example: Label holder with label, "STOP" marking

VE TR4A91••• → VETR4A91GB0

Items with code on the green background are available in stock

Slotted protection guard



Article	Description
VE GP22A5A	Cylindrical yellow protection guard with 4 slots Ø 40x20 mm

It does not alter the device IP protection degree.

Cylindrical protection guard

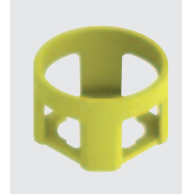

Article	Description
VE GP32B5A	Cylindrical yellow Ø43x27 mm protection guard

Not suitable for emergency pushbuttons E2 1PE..... series
It does not alter the device IP protection degree.

Open protection guard

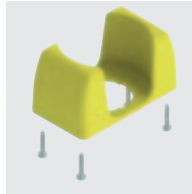

Article	Description
VE GP32F5A	Rectangular open yellow 66x38 h35 mm protection guard

It does not alter the device IP protection degree.

Examples of guard application

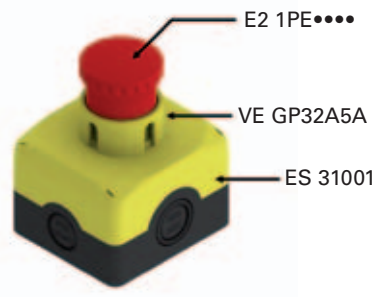
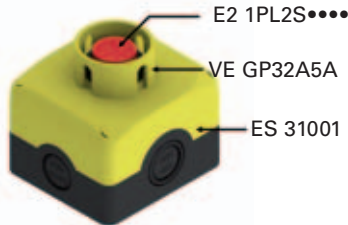
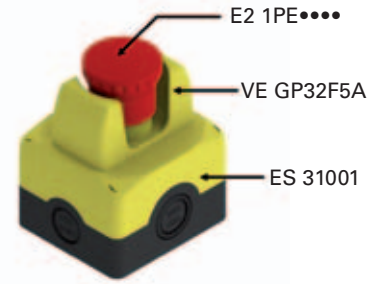
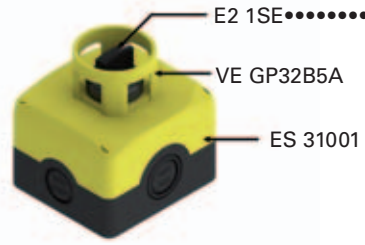
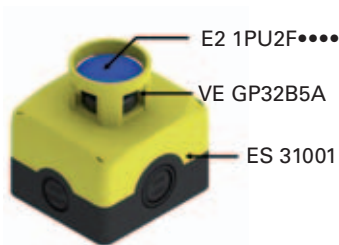

Protection hood

10 pcs packs

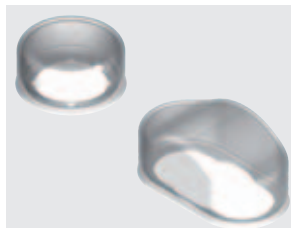

Technical data:
Material: Silicone, suitable for contact with food
Protection degree: IP67
Ideal for dusty food storage environment or in presence of water and sand.

Article	Description
VE CA1A1	Protection hood for flush pushbuttons (wall thickness from 1 to 5 mm)
VE CA1C1	Protection hood for double and triple push-buttons E2 1PD..... - E2 1PT..... (wall thickness from 1 to 6 mm)

Not applicable when a shaped ring or plate holder is fitted

Blanking plug

10 pcs packs



Technical data:
Body and nut material: polymer
Protection degree: IP67 and IP69K
Driving torque: from 2 to 2,5 Nm
Installation prescriptions: page 78

Article	Description
E2 1TA1A110	Black blanking plug for Ø 22 mm holes

Dust protection

50 pcs packs



Article	Description
VE PR3A70	Transparent dust protection for contact block E2 series. Applicable to all contacts fixed on panels.

MARKINGS table (inscription)

Code	Symbol	Code	Symbol	Code	Symbol	Code	Symbol
		GB0	STOP	FR0	ARRÊT	DE0	HALT
IT1	AVVIO	GB1	START	FR1	MARCHE	DE1	START
IT2	CHIUSO	GB2	CLOSE	FR2	FERMÉ	DE2	ZU
IT3	SU	GB3	UP	FR3	MONTÉE	DE3	AUF
IT4	GIÙ	GB4	DOWN	FR4	DESCENTE	DE4	AB
IT5	SPENTO	GB5	OFF	FR5	ARRÊT	DE5	AUS
IT6	ACCESO	GB6	ON	FR6	MARCHE	DE6	EIN
IT7	IN SERVIZIO	GB7	RUN	FR7	EN SERVICE	DE7	BETRIEB
IT8	ERRORE	GB8	FAULT	FR8	PANNE	DE8	STÖRUNG
IT9	TEST	GB9	TEST	FR9	ESSAI	DE9	PRÜFUNG
IT10	SPENTO ACCESO	GB10	OFF ON	FR10	ARRÊT MARCHE	DE10	AUS EIN
IT11		GB11	MAN. AUTO	FR11	MAN. AUTO	DE11	HAND AUTO
IT12		GB12	MAN. 0 AUTO	FR12	MAN. 0 AUTO	DE12	HAND 0 AUTO
IT13		GB13		FR13		DE13	ANTRIEB
IT14	RIAVVIA	GB14	RESET	FR14	REARM.	DE14	ENTSPERREN
IT15	AVANTI	GB15	FORWARD	FR15	AVANT	DE15	VORWÄRTS
IT16	INDIETRO	GB16	REVERSE	FR16	ARRIÈRE	DE16	RÜCKWÄRTS
IT17	AUMENTA	GB17	RAISE	FR17	MONTER	DE17	HEBEN
IT18	DIMINUISCI	GB18	LOWER	FR18	DESCENDRE	DE18	SENKEN
IT19	SINISTRA	GB19	LEFT	FR19	GAUCHE	DE19	LINKS
IT20	DESTRA	GB20	RIGHT	FR20	DROITE	DE20	RECHTS
IT21	FRENO	GB21	BRAKE	FR21	FERMER/OUVRIR	DE21	BREMSEN
IT22	ALTO	GB22	HIGH	FR22		DE22	HOCH
IT23	BASSO	GB23	LOW	FR23		DE23	NIEDRIG
IT24	VELOCE	GB24	FAST	FR24		DE24	SCHNELL
IT25	LENTO	GB25	SLOW	FR25		DE25	LANGSAM
IT26	PIÙ VELOCE	GB26	FASTER	FR26		DE26	
IT27	PIÙ LENTO	GB27	SLOWER	FR27		DE27	
IT32	APRIRE	GB32	OPEN	FR32		DE32	ÖFFNEN
IT63	CHIAMATA	GB63	CALL	FR63		DE63	
IT64	OCCUPATO	GB64	OCCUPIED	FR64		DE64	
IT99	ARRESTO D'EMERGENZA	GB99	EMERGENCY-STOP	FR99	ARRÊT D'URGENCE	DE99	NOT-AUS

MARKINGS table (symbols)

Code	Standard	Symbol	Code	Standard	Symbol	Code	Standard	Symbol
L1	IEC 60417-2	○	L21	-	0	L72		8
L2	IEC 60417-2		L22	-	0	L73		9
L3	-		L24	-	↗	L74		0
L4	-		L25	-	↑↓	L83		▶◀
L7	-	↑	L27	ISO 7000	⊙	L84		◀▶
L8	-	↓	L31	-	↔	L86		⊠
L9	-	←	L54	-	⚡			
L10	-	→	L59		⊕			
L11	IEC 60417-2	+	L60		☂			
L12	IEC 60417-2	—	L61		👁			
L14	IEC 60417-2	🔔	L65		1			
L15	-	R	L66		2			
L16	IEC 60417-2	💡	L67		3			
L17	ISO 7000	👉	L68		4			
L18	ISO 7000	📏	L69		5			
L19	-	0	L70		6			
L20	-	0	L71		7			

Panel drilling according to EN 60947-5-1

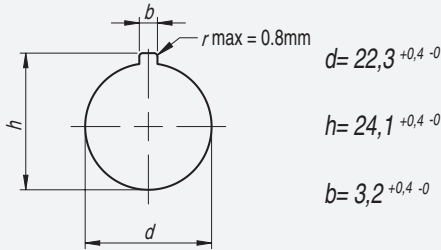

Gasket

Thanks to its configuration, the gasket assures a prefixing on the panel.

This way the ring nut can be applied with no need of keeping in position the device.

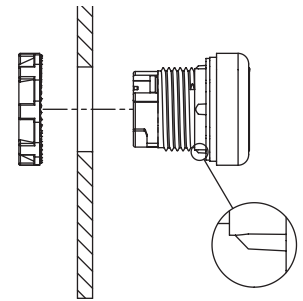

Alignment lug

The alignment lug in the external diameter of the EROUND series devices allows to obtain an exact alignment of the device while installing it on the panel avoiding any rotation.

If the application hole does not have the lug slot, it is sufficient to remove the lug by levering it with a screwdriver and paying attention not to damage the gasket.

It is not advisable to remove the alignment lug for turn to release selector (E2 1SE, E2 1SL, E21SC series) and emergency pushbuttons (E2 1PE series) since these are devices with rotating actuation.

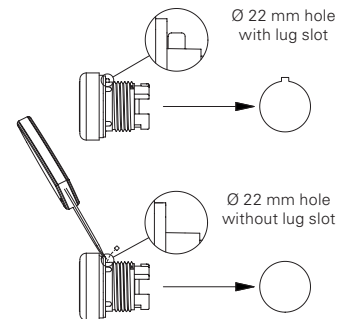

Device connection to the fixing adapter

After having fixed the control device to the panel through its proper ring, connect it to the fixing adapter by turning the locking lever.

The lever has two indications: open position (open padlock) and locked position (close padlock).

The locking lever rotation is easier if using a slotted screwdriver.

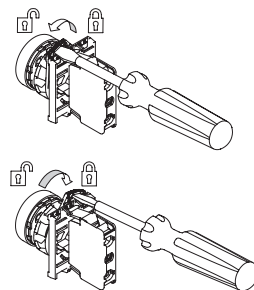

Panel fixing

The signalling and control devices have to be fixed behind the panel through a ring which has to be screwed with the fixing tool provided as accessory.

The driving torque for a correct fixing has to be between 2 and 2,5 Nm.

After fixing the ring it is possible to apply the fixing adapter and the panel contact block or LED holder.

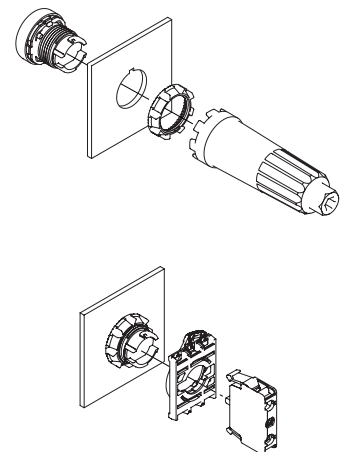

Contact and LED holders hooking

Each contact and LED holders have two snap tabs which assure a stable fixing to the adapter, for panel mount versions, or to the enclosure for base fixing versions. Panel contact blocks can be hooked between them, up to a maximum of three, provided that the limits for every actuator are respected as written in the relative chapters.

Contact and LED holders are quickly removed by levering with a slotted screwdriver on the snap tabs.

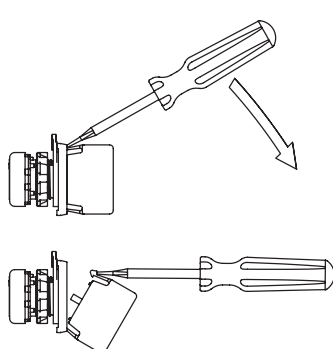

Contact block release from collar

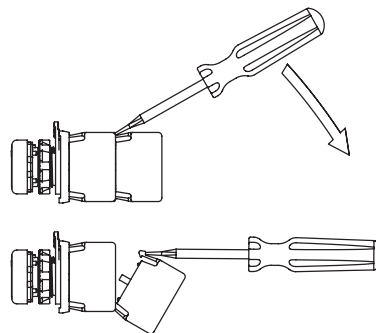

Contact block release from other block

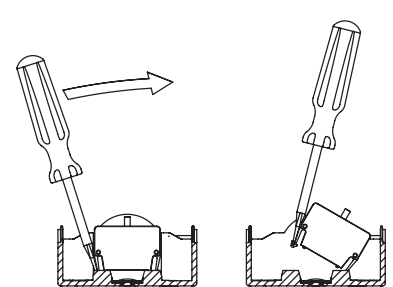

Contact block release from enclosure base

Lenses for indicator lights

The indicator lights are provided with lenses of different colours which are interchangeable. The lenses can be fixed and removed by simply turning them clockwise and anticlockwise without needing any tool.

For a good chromatic output, it is necessary a correct combination of lens and LED holder colours.

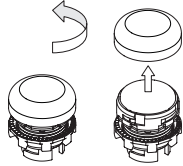

Lenses for illuminated pushbuttons

Pushbuttons and illuminated pushbuttons can have interchangeable lenses too. Their lens can be removed by putting a pointed tool under the notch on the lens external diameter and levering it.

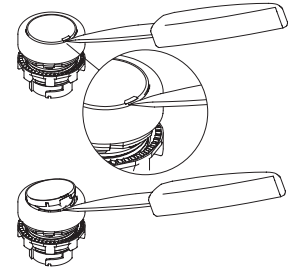

Inserting and removing the screw caps

The cover caps supplied for the new EROUND series boxes allow the screw seats to be closed, therefore preventing any dirt from being deposited and making any attempt at tampering more difficult.

These caps are integrated with the box surfaces to create a uniform assembly, with no screws showing, therefore accurately designed from an aesthetic point of view.

The caps are fastened to the cover by simply exerting pressure until the flexible tab is heard to click.

To remove them, insert the tip of a tool (e.g. a small screwdriver) in the appropriate slot found in each cap, and exert a levering action on the tab until it is released.

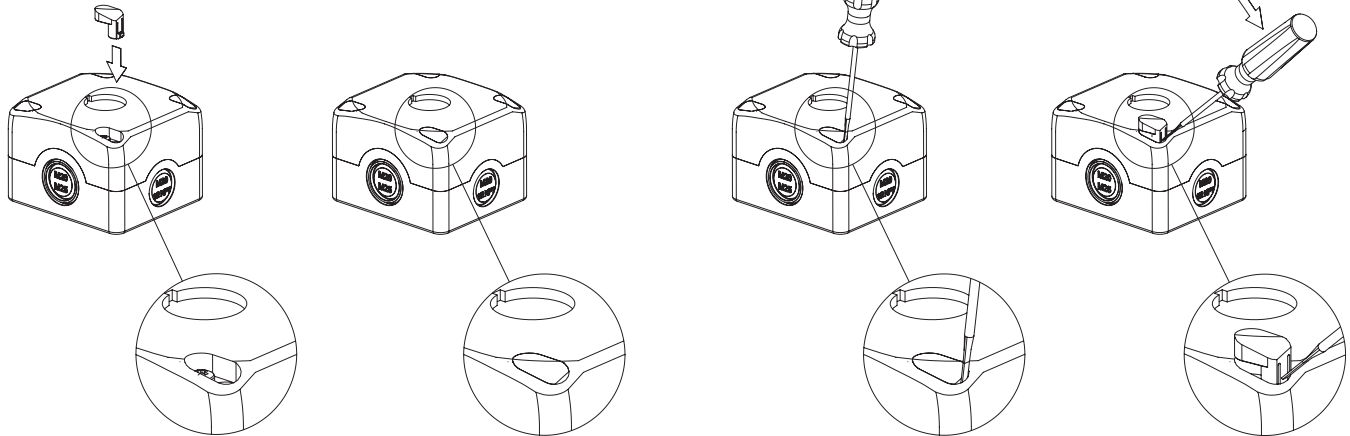

General prescription

The product is designed to be installed into electrical board or enclosures destined to contain electric circuits. All EROUND series components and electrical devices destined to be installed inside boards or enclosures, (e.g. E2 CP, E2 CF, E2 LP, E2 LF), do not have adequate protection against: water, dust in high quantity, condensate, humidity, steam, corrosive agents, explosive and inflammable gas or other polluting agents. The boards and enclosures protection degree have to guarantee the necessary protection for the EROUND series electrical components installed inside, as according to the application.

Devices utilization

- All devices of the EROUND series are projected for manual operation.
- Do not apply excessive force to the device once it has reached the end of its actuating travel.
- Do not pass the actuating maximum travel.
- Do not disassemble or try to repair the device, in case of defect or fault replace the whole device.
- In case the device is deformed or damaged replace it completely. There is no guarantee of working for a deformed or damage device.
- Always attached the following instructions for use in the manual of the machine were the switch is installed.
- The preservation of the following instructions for use has to allow their consultation for the whole utilization period of the device.

Impacts and vibrations

- Avoid collisions with devices. Excessive impacts and vibrations could not guarantee the correct working of the device.

Wiring and installation

- The installation has to be made by qualified personnel.
- Comply with minimum distances between devices.
- Comply with the driving torque.
- Keep the electrical load beneath the value indicated on the utilization category.
- Turn off the power before access to the contacts, also during the wiring.
- Do not paint or varnish the devices.
- It is possible to install the product only on surfaces with thickness between 1 and 6mm.
- The protection degree and its correct working are guaranteed only installing the product on flat and smooth surfaces with holes diameter 22 mm according to IEC 60947-5-1.
- After and during the wiring do not pull the electrical cables connected to the contact block. If an elevate traction force is applied to the cables the contact blocks could be separated from the actuator.
- During hooking and release operation of the contact block and the fixing adapter or the enclosure base do not deform or stress the fixing tabs. Tabs deformation could cause the separations between the contact block and the fixing adapter.
- After the installation and before machine working, verify:
 - the correct device working;
 - the correct and complete locking of the E2 1BAC11 fixing adapter to the device;
 - the correct hooking of the contact block.
- Periodically verify the devices correct working.

Do not use in the following environments:

- Environment where dust and dirt can cover the device and by sedimenting stop its correct working.
- Environment where sudden changes of temperature cause condensation.
- Environment where ice formation on the device is possible.
- Environment where the application causes knocks or vibrations which can damage the device.
- Environment with explosive and inflammable gas presence.

Utilization limits

- Use the devices following the instructions, complying with their working limits and the standards in force.
- The devices have specific application limits (min. and max ambient temperature, mechanical endurance, protection degree, etc.). These limits are satisfied by the different devices only if singularly taken and not in combination among them. For further information contact our Technical department.
- The utilization implies compliance and acknowledgement of the following standards: IEC 60204-1, IEC 60947-5-1, ISO 12100-1, ISO12100-2.
- Contact our Technical dept. for information and assistance (phone +39.0424.470.930 / fax +39.0424.470.955/ e-mail tech@pizzato.com) in the following cases:
 - Cases not mentioned on the following instructions;
 - In nuclear power stations, trains, airplanes, cars, incinerators, medical devices or any application where the safety of two or more persons depend on the correct device working.

Additional prescription for safety application

- Provided that all previous requirements for the devices installed for safety application are fulfilled, further additional prescriptions have to be observed:
- The utilization in any case implies compliance and acknowledgement of the following standards: IEC 60204-1, IEC 60947-5-1, EN 60954-1, EN 13849, EN ISO 13850, ISO 12100-1, ISO12100-2
 - In the emergency mushroom the safety circuit has to be connected to NC 1-2 contacts when the device is not actuated. Auxiliary NO 3-4 contacts have to be used only in the signalling circuit.
 - Always connect in series the protection fuse (or equivalent device) to the NC 1-2 contacts of the safety circuit.
 - Periodically verify the correct working of the safety devices, the periodicity of this verification is settled by the machine manufacturer based on the machine danger degree and it doesn't have to be less than one a year.
 - After the installation and before machine working, verify:
 - the correct device working;
 - the correct and complete locking of the E2 1BAC11 fixing adapter to the device;
 - the correct hooking of the contact block.
 - Do not leave the key inserted in the emergency mushroom with key-release. A sudden actuation of the emergency mushroom with the key inserted could hurt the operator.

Protection degree of the housings for electrical material according to IEC 60529 standard

This table indicates the protection degrees according to IEC 60529, EN 60529, CEI 70-1 standards. The degrees are identified by the letters IP and two numbers. Two more letters can be added, in order to give the protection degree for people or other features. The first number means the degree of protection against penetration of external solid materials. The second one indicates the degree of protection against penetration of water.

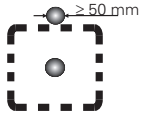
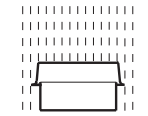
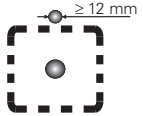
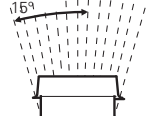
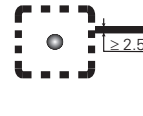
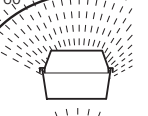
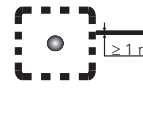
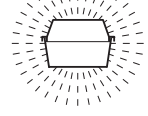
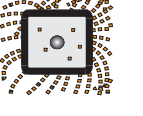
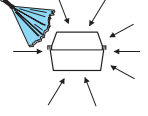
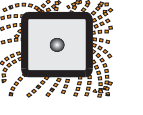
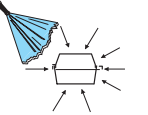
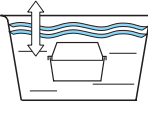
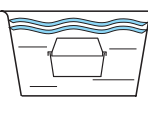
1° number	Description	Protection for the machine	Protection for the people	2° number	Description	Protection for the machine
0		No protection	No protection	0		No protection
1		Protected from solid bodies of more than 50 mm in diameter	No access to hazardous parts with back of the hands (Ø 50 mm)	1		Protected from drops of water that falling vertically
2		Protected from solid bodies of more than 12 mm in diameter	No access to hazardous parts with a finger (Ø 12 mm)	2		Protected from drops of water that falling from 15° max
3		Protected from solid bodies of more than 2.5 mm in diameter	No access to hazardous parts with tool (Ø 2.5 mm)	3		Protected from sprayed water that falling from 60° max
4		Protected from solid bodies of more than 1 mm in diameter	No access to hazardous parts with wire (Ø 1 mm)	4		Protected from splashes of water around it
5		Protected from dust	No access to hazardous parts with wire (Ø 1 mm)	5		Protected from jets of water discharged around it
6		Totally protected from dust	No access to hazardous parts with wire (Ø 1 mm)	6		Protected from strong jets of water around it
				7		Protected from temporary water immersion (30 minutes in a depth of one meter)
				8		Protected from continuous water immersion by agreement

Protection degree IP69K according to standard DIN 40050

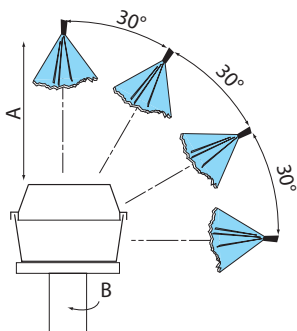

The standard provides that a device have to pass a particularly heavy test which simulates the conditions of pressure washing in the industrial environments with water jets having pressure between 80 and 100 bar, flow rate between 14 e 16 l/min. and temperature 80°C.

Test features:

- Rotation speed (B): 5 ± 1 rpm
- Distance from water jet (A): 100 +50/-0 mm
- Water flow rate: 15 ± 1 l/min
- Water pressure: 9000 ± 1000 kPa
- Water temperature: 80 ± 5 °C
- Test duration: 30 s each position

Any information or application example, included the connection diagrams, described in this document are to be intended as purely descriptive. The choice and application of the products in conformity with the Standards, in order to avoid damages to persons or goods, is under the responsibility of the user.

The drawings and data contained in this catalog are not binding, and we reserve the right to improve the quality of our products to modify them at any time without prior notification.

This publication cannot be copied in whole or in part without prior permission from the publisher.

All rights reserved. © 2012 Copyright Pizzato Elettrica



General Catalog



Production program



ATEX brochure



LIFT
General Catalog



Cd-rom



Web site
www.pizzato.com



pizzato elettrica

Passion for Quality

Pizzato Elettrica s.r.l. Via Torino, 1 - 36063 Marostica (VI) Italy
Phone +39.0424.470.930 - Fax +39.0424.470.955
E-mail: info@pizzato.com - Web site: www.pizzato.com

ZE BRC10A12-ENG

