

**Notice to Customer**

Thank you very much for purchasing our PATLITE product.

- Request the installation and wiring be performed by a professional contractor if construction work is involved.
- Prior to installation, read this manual thoroughly before using this product to ensure correct use.
- Re-read this manual before conducting maintenance, inspections, repairs, and so on.

If you have any questions about this product, please contact the service and repair desk listed on the website.

- Before using this product, update to the latest version of the firmware.

You can download the latest version of the firmware by registering as a member from our website.

- This manual describes functions supported by the NHB Series and NHV Series.

Depending on the product that you are using, some functions may not be available or the screen layout may differ from that shown in this manual.

**To the Contractor**

- Prior to installation, read this manual thoroughly to ensure it is installed correctly.
- Return this manual to the customer.

**Network Signal Tower**  
**TYPE NHB Series**

**Network Signal Tower with Voice Annunciator**

**TYPE NHV Series**

**Instruction Manual**  
**[Web Version]**

	<i>page</i>
1. Before You Begin	<b>9</b>
2. Models	<b>15</b>
3. Contents	<b>16</b>
4. Part Names and Dimensions	<b>17</b>
5. Product Features and Functions	<b>19</b>
6. Mounting, Installation, Wiring, and Powering on	<b>75</b>
7. Before Use	<b>91</b>
8. Operation	<b>118</b>
9. Web Setup Screen Descriptions	<b>238</b>
10. MIB List	<b>314</b>
11. Specifications	<b>321</b>
12. Troubleshooting	<b>326</b>
13. Replacement and Optional Parts	<b>333</b>
14. Free Software License Agreement	<b>334</b>

# Table of Contents

<b>1. Before You Begin</b>	<b>9</b>
1.1. About Safety Symbols	9
1.2. Safety Precautions	10
1.3. About laws and regulations in each country	12
1.4. Trademarks	14
1.5. Copyright	14
1.6. Network Security	14
<b>2. Models</b>	<b>15</b>
2.1. NHB Series	15
2.2. NHV Series	15
2.3. Supported Additional Units	15
<b>3. Package Contents</b>	<b>16</b>
3.1. NHB Series	16
3.2. NHV Series	16
<b>4. Part Names and Dimensions</b>	<b>17</b>
4.1. NHB Series	17
4.2. NHV Series	18
<b>5. Product Features and Functions</b>	<b>19</b>
5.1. Product Features	19
5.1.1. Installation	19
5.1.2. PoE Support	19
5.1.3. Multilingual Support	19
5.1.4. Operations When Connecting to a Cloud Environment	20
5.2. Product Functions	20
5.2.1. Signal Tower, Buzzer, Audio Playback	20
5.2.2. Voice Synthesizer	20
5.2.3. Monitoring the Status	21
5.2.4. Email detection	21
5.2.5. Commands for Control of Communication	22
5.2.6. Status Notification	22
5.3. Function Descriptions	23
5.3.1. Signal Tower and Buzzer Notification Functions	23
5.3.2. Audio Playback Function	24
5.3.3. Line Out Function	28



5.3.4. Voice Synthesizer Function .....	28
5.3.5. External Contact Output Function .....	29
5.3.6. Send Email Function .....	31
5.3.7. SNMP TRAP/Inform Transmission Function .....	34
5.3.8. Send HTTP Command Function .....	34
5.3.9. Send HTTP Command Function .....	34
5.3.10. RSH/SSH Command Function .....	35
5.3.11. PNS Command Function (product compatibility commands) .....	43
5.3.12. PHN Command Function (product compatibility commands) .....	52
5.3.13. HTTP Command Reception Function .....	54
5.3.14. SNMP Command Functions .....	60
5.3.15. Ping Monitoring Function .....	62
5.3.16. SNMP TRAP Reception Function .....	63
5.3.17. SNMP Device Monitoring Function .....	64
5.3.18. Detect Change in State of Contact Input .....	67
5.3.19. Contact Input Match Detection .....	68
5.3.20. Detect Email Function .....	69
5.3.21. Clear Operation Function .....	70
5.3.22. Self-test Function .....	72
5.3.23. Cloud Function .....	73

**6. Mounting, Installation, Wiring, and Powering on \_\_\_\_\_ 95**

6.1. Attaching and Detaching Additional Units .....	76
6.1.1. NHB Series, NHV Series .....	76
6.1.2. Procedure for Attaching/Detaching LED Units .....	77
6.1.3. Procedure for Attaching/Detaching LED Units and Transmitter .....	77
6.2. Product Installation and Mounting Method .....	79
6.2.1. When Stationary .....	79
6.2.2. Mounting on a Tripod .....	80
6.2.3. When Using Mounting Brackets (optional part) .....	81
6.3. Line Out Connection Method .....	85
6.4. Digital Input/Output Wiring Method .....	86
6.4.1. Wiring procedures .....	86
6.4.2. Circuit Diagram .....	87
6.5. LAN Cable Wiring Method .....	88
6.6. Power Supply Method .....	89
6.6.1. When Using AC Adapter Power Supply .....	89
6.6.2. When Using PoE to Supply Power .....	90
6.6.3. Checking at Startup .....	90

**7. Before Use \_\_\_\_\_ 91**

7.1. Enabling DHCP Function .....	92
7.2. Setting Up Network Settings on the PC .....	93
7.3. Setting Up User Authentication (User Name and Password).....	96
7.4. Displaying the Web Setup Screen .....	97
7.5. Setting Up Product Network Settings .....	100
7.6. Setting Up the Clock .....	102
7.7. Setting Up Security .....	104
7.8. Setting Up the Product Name, Installation Location, and Contact.....	106
7.9. Setting Up the Buzzer .....	107
7.10. Setting Up the Speaker Volume .....	108
7.11. Setting Up the Line Out Volume .....	109
7.12. Setting Up Audio Playback Mode .....	110
7.13. Setting Up LED Unit (Multi-color) and Transmitter Unit Settings.....	111
7.14. Setting Up LED Unit Brightness Adjustment .....	112
7.15. Setting Up Normal Status .....	113
7.16. Setting Up Voice Registration .....	114
7.16.1. Audio Registration .....	114
7.16.2. Changing the Audio Title .....	116
7.16.3. Audio Line Out Output.....	116
7.16.4. Playing and Stopping Audio Playback .....	116
7.16.5. Deleting Audio .....	117

**8. Operation **118****

8.1. Notifying Equipment .....	118
8.1.1. Setting Up SNMP (Trap Inform) Notification Settings .....	118
8.1.1.1. Setup Procedure .....	118
8.1.2. Setting Up Email Notification Settings .....	122
8.1.2.1. Setup Procedure .....	122
8.1.3. Setting Up HTTP Command Sending Settings .....	125
8.1.3.1. Setting Up Content of Send HTTP Command.....	125
8.1.3.2. Setting Up Triggers for Send HTTP Command .....	125
8.1.3.3. Setting Up State Change Transmissions .....	126
8.1.4. Setting Up Contact Output Settings .....	127
8.1.4.1. Setting Up Contact Output .....	127
8.1.4.2. Setting Up Triggers for Contact Output.....	127
8.2. Using the Cloud .....	128
8.2.1. Using Microsoft Azure .....	128
8.2.1.1. Setting Up Azure .....	128
8.2.1.2. Setting Up Microsoft Azure Connection Settings .....	129
8.2.1.3. Using Device Twin .....	130

8.2.1.4. Using Direct Method .....	132
8.2.1.5. Using Device-to-cloud message .....	134
8.2.1.6. Using Cloud-to-device message .....	138
8.2.2. Using AWS .....	140
8.2.2.1. Setting Up AWS .....	140
8.2.2.2. Setting Up the AWS Connection .....	144
8.2.2.3. Checking Connection with AWS IoT Core .....	145
8.2.2.4. Using MQTT Subscribe Function .....	146
8.2.2.5. Using MQTT Publish Function .....	149
8.2.2.6. Using Device Shadow Function .....	153
8.3. Checking and Controlling the Status of This Product .....	155
8.3.1. Checking and Controlling the Status of This Product with Commands .....	155
8.3.1.1. Setting Up the Command Main Unit Operation Settings .....	155
8.3.1.2. Checking the Signal Tower State .....	162
8.3.1.3. Controlling Signal Tower States .....	165
8.3.1.4. Controlling Audio .....	168
8.3.1.5. Play Any Text.....	170
8.3.1.6. Clearing the Status of This Product .....	171
8.3.1.7. Checking the Contact Input/Output States .....	172
8.3.1.8. Controlling Contact Output .....	173
8.3.1.9. Performing the Self-test Operation .....	175
8.3.2. Checking and Controlling the Signal Tower on the Web Setup Screen.....	176
8.3.2.1. Checking the Signal Tower States.....	176
8.3.2.2. Controlling Signal Tower States .....	176
8.3.3. Operating the Product with the Clear Button .....	177
8.3.3.1. Setting Up the Clear Operation Settings .....	177
8.3.3.2. Using Clear Button to Execute Clear Operation .....	179
8.4. Monitoring .....	180
8.4.1. Ping Monitoring .....	180
8.4.1.1. Setup Procedure .....	180
8.4.2. SNMP TRAP Monitoring .....	189
8.4.2.1. Setup Procedure .....	189
8.4.3. SNMP Device Monitoring .....	195
8.4.3.1. Setup Procedure .....	195
8.4.4. Contact Input Status Monitoring .....	205
8.4.4.1. Setting Up Contact Input Function.....	205
8.4.5. Contact Input Condition Monitoring .....	210
8.4.5.1. Setting Up Contact Input Condition .....	210
8.4.6. Detecting Email .....	214
8.4.6.1. Setup Procedure .....	214

8.5. Doing Maintenance .....	219
8.5.1. Checking the Product Settings.....	219
8.5.1.1. Screen Display Procedure .....	219
8.5.1.2. Using Status LED to Check the Status of this Product .....	221
8.5.2. Initializing This Product .....	222
8.5.2.1. Initialization on the Web Setup Screen.....	222
8.5.2.2. Initialization with DIP Switches .....	223
8.5.3. Restarting this Product .....	224
8.5.3.1. Restarting from the Web Setup Screen .....	224
8.5.3.2. Restarting with the Reset Button .....	225
8.5.4. Changing the Sound Volume .....	226
8.5.4.1. Adjusting the Volume on the Web Setup Screen .....	226
8.5.4.2. Adjusting the Volume with + / - Volume Control Buttons .....	227
8.5.4.3. Muting the Volume .....	228
8.5.5. Verifying the Self-test Operation .....	229
8.5.5.1. Enabling the Test Button Function.....	229
8.5.6. Changing User Authentication Settings .....	230
8.5.6.1. User Authentication Settings .....	230
8.5.7. Exporting and Importing Product Settings (Configuration) .....	231
8.5.7.1. Extracting the Configuration .....	231
8.5.7.2. Writing to Configuration .....	232
8.5.8. Updating Firmware.....	233
8.5.8.1. Updating Firmware .....	233
8.5.9. Checking the Event Log .....	234
8.5.9.1. Displaying the Event Log .....	234
8.5.9.2. Downloading the Log .....	234
8.5.9.3. Event Log contents .....	235

**9. Web Setup Screen Descriptions \_\_\_\_\_ 238**

9.1. Main Unit Settings .....	239
9.1.1. Function Activation .....	239
9.1.2. Network Settings .....	241
9.1.3. Clock Settings .....	243
9.1.4. Basic Settings .....	244
9.2. Command Reception Settings.....	246
9.2.1. Socket Communication Settings .....	246
9.2.2. RSH/SSH Command Reception Settings .....	247
9.2.3. SNMP Command Reception Settings .....	251
9.3. Monitor Settings .....	253
9.3.1. Ping Monitoring Settings .....	253

9.3.1.1. Individual Settings .....	253
9.3.1.2. Group Settings .....	256
9.3.2. TRAP Reception Settings .....	259
9.3.2.1. Basic Settings .....	259
9.3.2.2. Receive Settings .....	261
9.3.3. SNMP Device Monitoring Settings .....	264
9.3.3.1. Basic Settings .....	264
9.3.3.2. Match Detection Settings .....	266
9.3.3.3. Change Detection Settings .....	269
9.3.4. Contact Input Setting .....	272
9.3.4.1. Status Change Detection Settings .....	272
9.3.4.2. Match Detection Settings .....	275
9.3.5. Mail Detection Setting Screen .....	278
9.3.5.1. Mail Server Settings.....	278
9.3.5.2. Filter Rule Settings .....	281
9.4. Notification Settings .....	284
9.4.1. SNMP Notification Settings .....	284
9.4.2. Email Notification Settings .....	288
9.4.3. HTTP Transmission Settings .....	294
9.5. Cloud Settings .....	295
9.5.1. Azure Connection Settings .....	295
9.5.2. AWS Connection Settings.....	297
9.6. Main Unit Operation Settings .....	298
9.6.1. Clear Operation Settings .....	298
9.6.2. Test Button Setting .....	300
9.6.3. Contact Output Setting .....	301
9.6.4. Signal Tower Operation .....	303
9.7. Voice Registration .....	305
9.8. Management .....	307
9.8.1. Settings Initialization .....	307
9.8.2. Restart .....	308
9.8.3. Configuration .....	309
9.8.4. Updating Firmware.....	310
9.8.5. Event Log.....	311
9.8.6. User Authentication Settings .....	312
9.8.7. Security Settings.....	313



<b>10. MIB List</b>	<b>314</b>
10.1. NHB Series	314
10.2. NHV Series	316
10.3. MIB Description	318
<b>11. Specifications</b>	<b>321</b>
11.1. NHB Series	321
11.2. NHV Series	323
<b>12. Troubleshooting</b>	<b>326</b>
12.1. Troubleshooting	326
12.1.1. Common to NHB and NHV Series	326
12.1.2. NHB Series	330
12.1.3. NHV Series	330
12.1.4. NHV-DP Series	331
<b>13. Replacement and Optional Parts</b>	<b>333</b>
13.1. Replacement Parts	333
13.2. Optional Parts	333
<b>14. Free Software License Agreement</b>	<b>334</b>
14.1. GNU GENERAL PUBLIC LICENSE	334
14.1.1. Version 1.0	334
14.1.2. Version 2.0	338
14.1.3. Version 3.0	343
14.2. GNU LIBRARY GENERAL PUBLIC LICENSE	353
14.2.1. Version 2.1	353
14.2.2. Version 3.0	360
14.3. BSD License	363
14.3.1. <b>2</b> -Clause	363
14.3.2. <b>3</b> -Clause	363
14.3.3. <b>4</b> -Clause	364
14.4. Python Software Foundation License	365
14.5. OpenSSL License	369
14.6. Open Software Licence 3.0	371
14.7. MIT License	374
14.8. Apache License	375
14.9. Academic Free License	378
14.10. Texas Instruments Incorporated Technology and Software Publicly	381

# 1. Before You Begin



## 1.1. About Safety Symbols

To prevent injuries to the user and other personnel, as well as to prevent damage to assets, note the following:

- The following symbols classify warnings and cautions, and describe the level of harm and damage that will occur when the corresponding instructions are ignored.



 <b>WARNING</b>	This symbol indicates, "Failure to follow the instructions may lead to death or serious injury."
 <b>CAUTION</b>	This symbol indicates, "Failure to follow the instructions may lead to injury or property damage."

- The following symbols classify and describe the content of associated messages.

 <b>Prohibited</b>	This symbol identifies "Prohibited" operations that should never be carried out.
 <b>Mandatory</b>	This symbol identifies "Mandatory" instructions that should always be carried out.
	This symbol identifies general "Caution" related information.



## 1.2. Safety Precautions

### **WARNING**

 <p><b>Prohibited</b></p>	<ul style="list-style-type: none"> <li>● Do not modify or disassemble this product. Failure to follow this instruction could result in fire or electric shock.</li> <li>● Do not use this product when there is condensation. Failure to follow this instruction could result in fire or electric shock.</li> <li>● Do not use the product or leave the product with the LED unit either removed or cracked. Failure to follow this instruction could result in fire or electric shock.</li> <li>● Do not touch the AC plug with wet hands. Failure to follow this instruction could result in electric shock.</li> <li>● Do not apply voltage that exceeds the acceptable range. The rated voltage is 100 to 240 VAC (AC adapter input). If you apply more than the rated voltage, internal circuits will be damaged. Failure to follow this instruction could result in fire or electric shock.</li> <li>● While power is still applied to the AC adapter, do not connect or disconnect the DC power plug. Failure to follow this instruction could result in electric shock or equipment damage.</li> <li>● Do not use or install the product in locations where liquids such as water is present, oil will splatter, or locations that are humid or dusty. Failure to follow this instruction could result in fire, electric shock or equipment damage.</li> <li>● Do not use or control this product in equipment or devices that, directly or indirectly, affect human life, or in equipment or devices where a high degree of reliability is required. If this product is used for these applications, we cannot be held responsible in the event of death, injury, or property damage.</li> <li>● Do not allow liquids on the product, and do not allow it to have contact with metallic objects. Failure to follow this instruction could result in fire or electric shock.</li> <li>● After installation, do not use this product to climb up onto equipment. Failure to follow this instruction will result in product damage and/or falling off the machinery.</li> </ul>
 <p><b>Mandatory</b></p>	<ul style="list-style-type: none"> <li>● Request the installation and wiring be performed by a professional contractor if construction work is involved. Failure to follow this instruction could result in fire, electric shock, or falling of the product.</li> <li>● Turn off the power before performing any electric wiring or product installation. Failure to follow this instruction could result in electric shock.</li> <li>● If an unusual condition occurs while using this product, such as emitting smoke, heat, abnormal odor, or unusual sound, stop the application, disconnect the power, and contact your nearest PATLITE Sales Representative.</li> <li>● When plugging the AC adapter into an outlet, confirm there is no dust, and connect all the way to the root of the power plug. Using the AC plug with dust on it could result in fire or equipment damage.</li> <li>● Regularly clean dust off the AC plug and outlet. Due to the tracking phenomenon, using a power plug with dust on it could result in fire or equipment damage.</li> <li>● To prevent injuries and property damage that could result from product failure or malfunction, ensure sufficient safety by using this product together with other equipment.</li> <li>● To prevent accidents when operating or maintaining the product, in addition to the safety guidelines identified in the instructions of this manual, follow all general safety guidelines. We cannot foresee all circumstances concerning the handling and dangers associated with this product. Therefore, not every possible danger is indicated in this instruction manual.</li> <li>● In case the product falls over or falls down, install in a location where it will not hit any people or other objects.</li> </ul>



 **CAUTION**

 <p><b>Prohibited</b></p>	<ul style="list-style-type: none"> <li>● Do not use in locations near fire or environments with high temperature and humidity. Do not use this product where corrosive, flammable gas is present.</li> <li>● Do not use this product if liquids (such as water or chemicals) or foreign metallic objects (such as copper wire) have entered this product. Failure to follow this instruction could result in product damage.</li> <li>● Do not bend the power cable unnecessarily. Failure to follow this instruction could result in disconnection and malfunction or equipment damage.</li> <li>● Do not use this product near equipment (such as a solenoid) or wires that generate strong electric or magnetic fields. Failure to follow this instruction could result in malfunction due to inductive noise.</li> <li>● Do not use excessive force on this product. Failure to follow this instruction could result in deformed frame and product damage.</li> <li>● Do not use sharp tipped objects with this product. Operation may become impossible as scratches develop on buttons and contacts are interfered with.</li> <li>● Do not use this product near chemicals. This product could melt or become deformed if any chemicals adhere to it.</li> <li>● Do not wipe dirt on this product with thinners, benzine, gasoline, oil, chemicals, and so on. Failure to follow this instruction could result in discoloration and deterioration. Wipe with a soft cloth, dampened with water and wrung tightly.</li> <li>● When using a tripod with this product, do not move or transport while the tripod is attached. Failure to follow this instruction could result in equipment damage if the product falls over.</li> </ul>
 <p><b>Mandatory</b></p>	<ul style="list-style-type: none"> <li>● Use only the specified replacement parts listed in this manual.</li> </ul>

### 1.3. About laws and regulations in each country

#### ● For Customers in U.S.A.

This equipment has been tested and found to comply with the limits for a Class A digital device, pursuant to Part 15 of the FCC Rules.

These limits are designed to provide reasonable protection against harmful interference when the equipment is operated in a commercial environment.

The equipment generates, uses, and can radiate radio frequency energy and, if not installed and used in accordance with the instruction manual, may cause harmful interference to radio communications.

Operation of this equipment in a residential area is likely to cause harmful interference in which case the user will be required to correct the interference at his own expense.

(Responsible party in U.S.A.) 20130 S. Western Ave. Torrance, CA90501, U.S.A.

#### ● For Customers in Europe

This product has been tested and found to comply with the limits for a Class A device.

These limits are designed to provide reasonable protection against harmful interference when the equipment is operated in a commercial environment.

This product must not be used in residential areas.

#### ● For Customers in Korea

사용자안내문

이 기기는 업무용 환경에서 사용할 목적으로 적합성평가를 받은 기기로서 가정용 환경에서 사용하는 경우 전파간섭의 우려가 있습니다.

## ● For Customers in Russia



(Местный представитель)  
ООО «Омега»

Адрес : 117342, Москва, улица Бутлерова, дом 17б, этаж 3, пом XII, ком 86, оф 1, каб 16  
Номер телефона : +79277089646  
Эл. почта : omegaimports@yandex.ru

(Импортер)  
PneumoElectroService

Адрес : P.O.Box № 41 Торфяная дорога 9, 197374 г. Санкт-Петербург  
Тел : +7-812-326-3100  
Факс : +7-812-36-3108

Электронная почта [info@pes-rus.ru](mailto:info@pes-rus.ru)  
URL <http://pes-rus.ru>

(Контакт)  
Importer in EU: PATLITE Europe GmbH  
P.O.Box 10 10 51, 41410, Neuss, Germany

(Способ подтверждения производственной площадки и производственной партии)

Заводская табличка

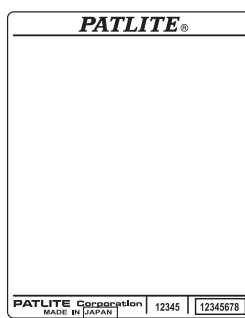

Номер производственной партии

Производственная зона

## 1.4. Trademarks

- Microsoft Edge, Azure, Azure Active Directory, and Outlook are registered trademarks of Microsoft Corporation in the United States and other countries.
- Google Chrome, Google Cloud Platform, and Gmail are trademarks or registered trademarks of Google LLC.
- Amazon Web Services, the "Powered by AWS" logo, and any other AWS trademarks used in such materials are trademarks of Amazon.com, Inc. or its affiliates in the United States and other countries.
- Other company and product names that are used are the registered trademarks or trademarks of those respective companies.

## 1.5. Copyright

- Work that was recorded or copied from music CDs, other media, or a paid service, and used in public or public places may be subject to copyright infringement. When using such works, obtain permission from the rights holder.
- In addition, copyrights of audio/music data distributed or sold by PATLITE Corporation belongs to PATLITE. It is strictly prohibited to copy/reprint, whole or in part, contents of audio/music data belonging to PATLITE Corporation, or to transfer/sell such material on computer networks without the permission of the rights holder.

## 1.6. Network Security

The user is responsible for the network security of this product and its use.

Take appropriate network security measures to avoid security breaches.

- Use this unit in a network secured by a firewall, etc.
- Change the login password periodically.
- Save user authentication information (user names and passwords) in such a way that it is kept out of the hands of third parties

This product cannot connect directly to the Internet.

When connecting this product to the Internet, use a router or similar device.

## 2. Models

### 2.1. NHB Series

Model Number	Model	Signal Tower Type		Number of LED Tiers	AC Adapter Included or Not		LED Unit Color
	<b>NHB</b>	↓	-	↓	↓	-	<b>RYGBC</b>

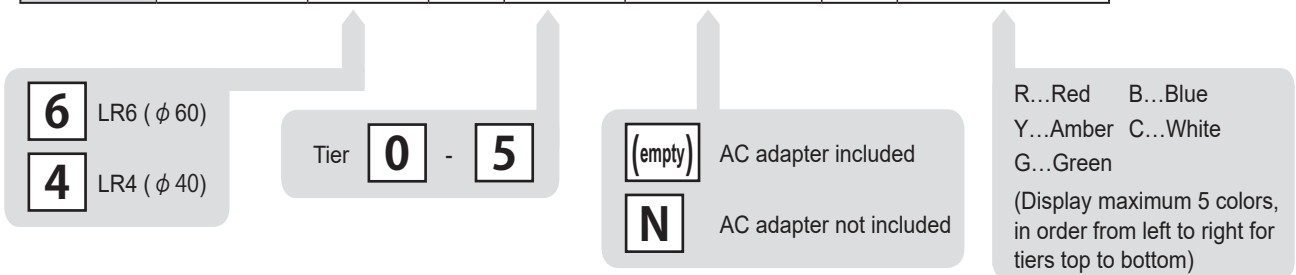

### 2.2. NHV Series

Model Number	Model	Signal Tower Type		Number of LED Tiers	External Contact Input/Output	Software Specification	AC Adapter Included or Not		LED Unit Color
	<b>NHV</b>	↓	-	↓	↓	↓	↓	-	<b>RYGBC</b>

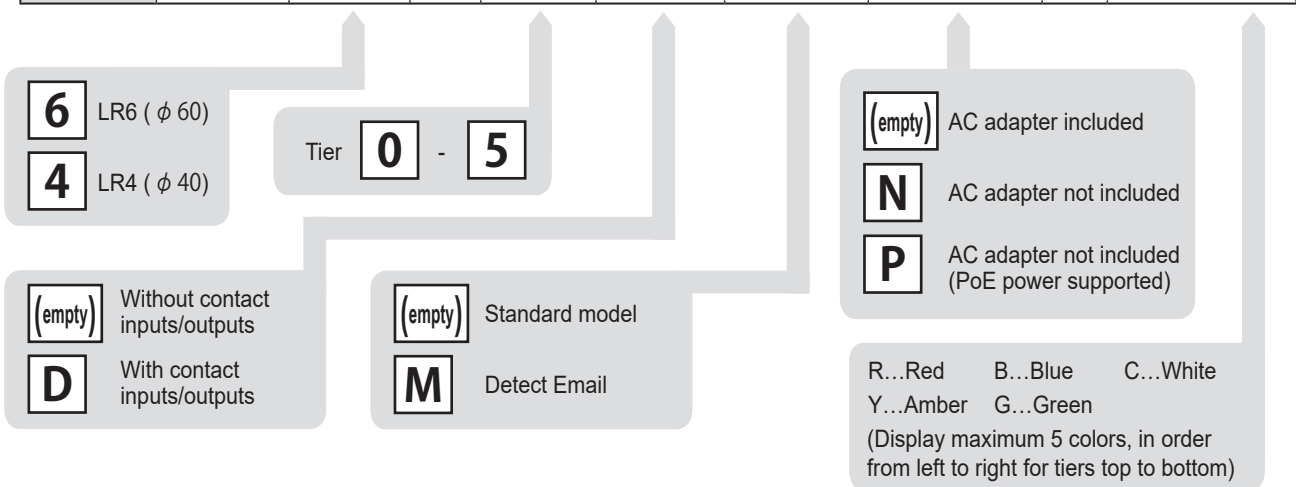

### 2.3. Supported Additional Units

NHB Series

NHV Series

	NHB6, NHV6	NHB4, NHV4
LED Unit (Colored lens)	LR6-E- □ ( □ : R, Y, G, B, C)	LR4-E- □ ( □ : R, Y, G, B, C)
LED Unit (Clear lens)	LR6-E- □ Z ( □ : R, Y, G, B)	LR4-E- □ Z ( □ : R, Y, G, B)
LED Unit (Multi-color)	LR6-E-MZ	-
Transmitter unit	WDT-6LR-Z2	WDT-4LR-Z2

## 3. Package Contents

### 3.1. NHB Series

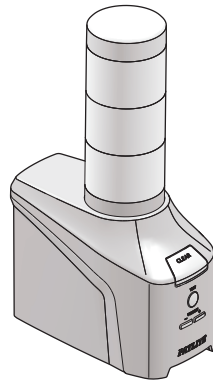

Main Unit: 1

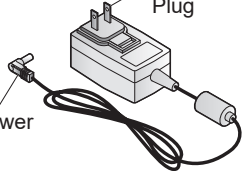
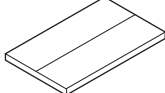
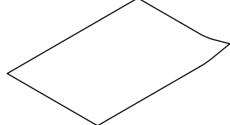
Accessories		
<p>AC Adapter</p> <p>AC Power Plug</p> <p>DC Power Plug</p>  <p>* Not included in <b>N</b> model</p> <p>x 1</p>	<p>Adhesive Sheet</p>  <p>2 Sheets (1 Set)</p>	<p>Installation Manual</p>  <p>x 1</p>

### 3.2. NHV Series

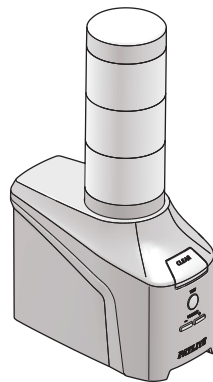

Main Unit: 1

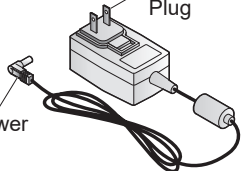
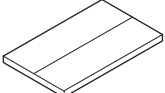
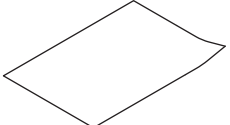
Accessories		
<p>AC Adapter</p> <p>AC Power Plug</p> <p>DC Power Plug</p>  <p>* Not included in <b>N</b>-<b>P</b> model</p> <p>x 1</p>	<p>Adhesive Sheet</p>  <p>2 Sheets (1 Set)</p>	<p>Installation Manual</p>  <p>x 1</p>

# 4. Part Names and Dimensions

## 4.1. NHB Series

### ● NHB6

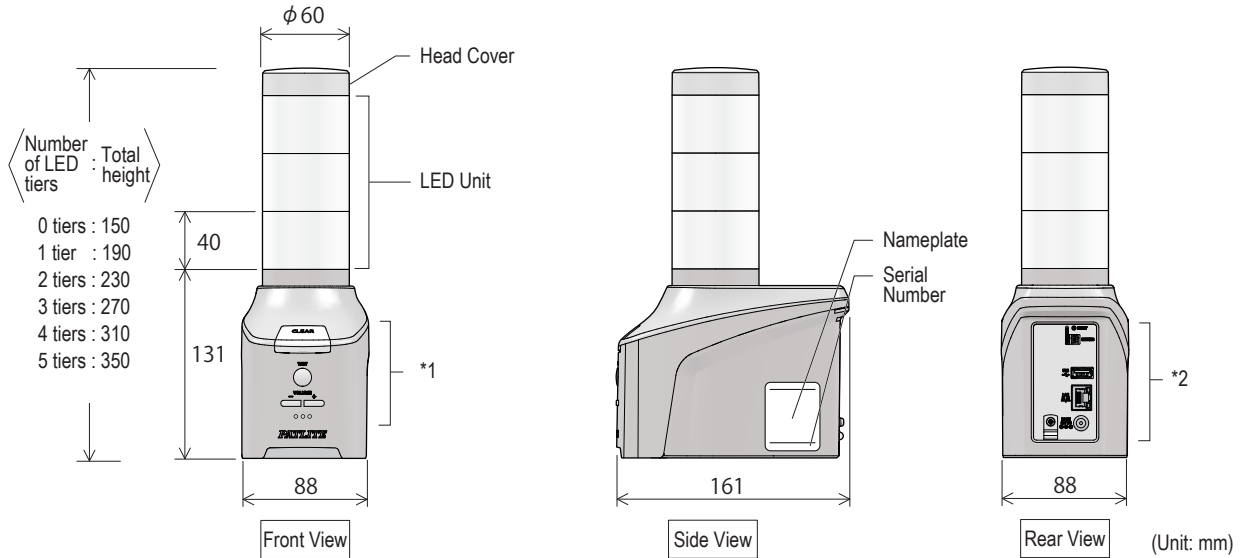

### ● NHB4

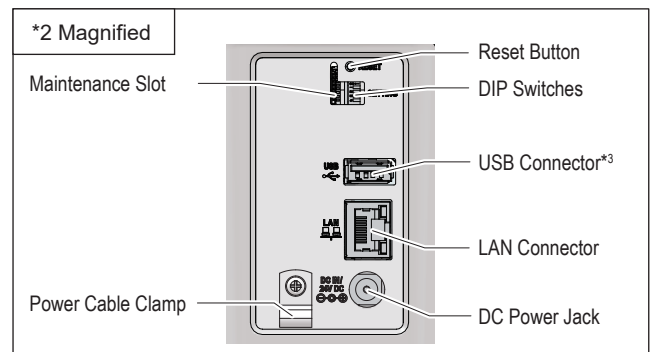
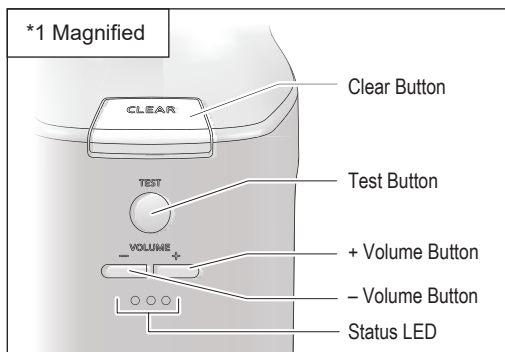
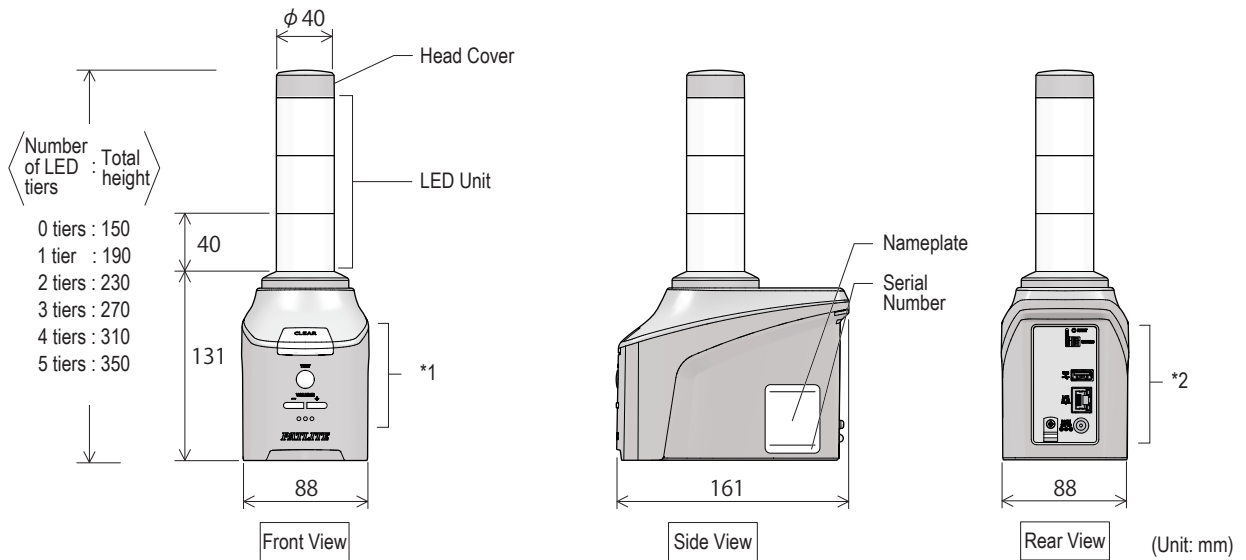

\*3 Do not use the USB connector as a power supply or for charging.

## 4.2. NHV Series

### ● NHV6

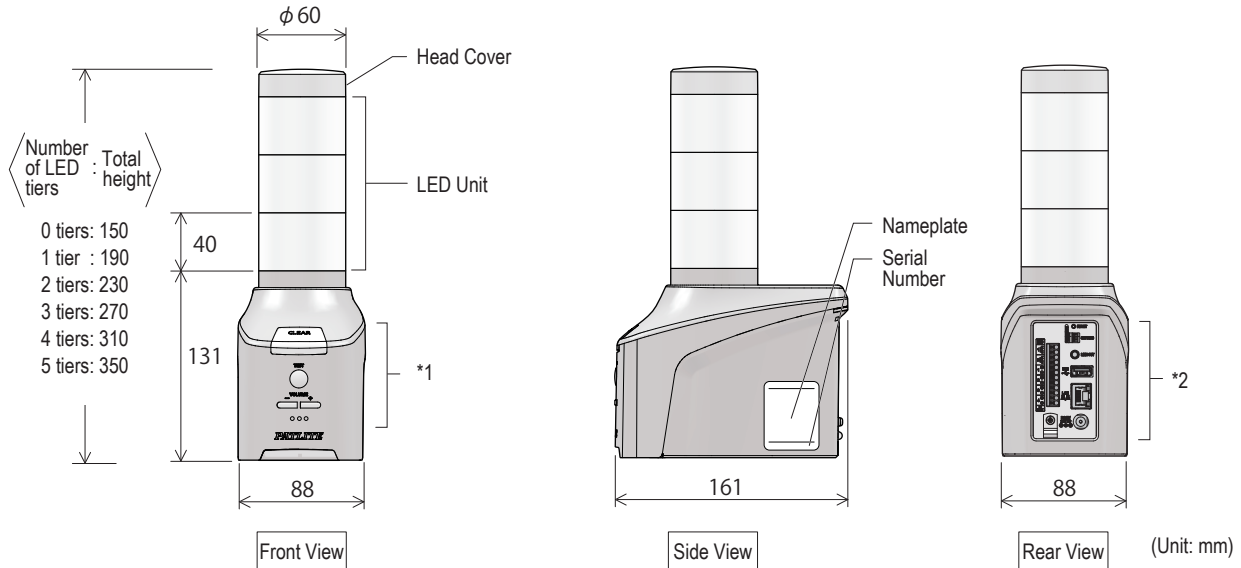

### ● NHV4

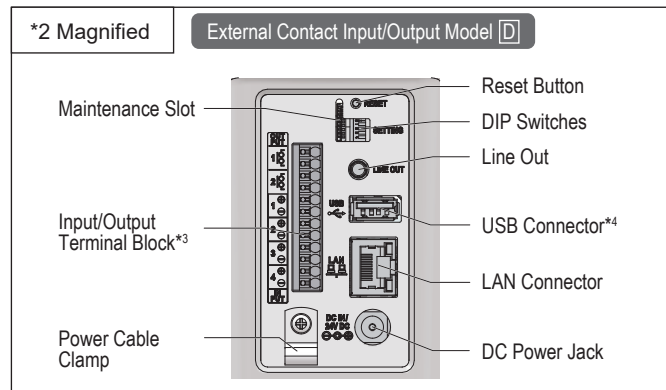
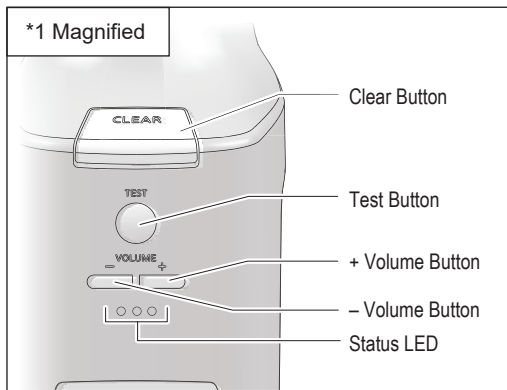
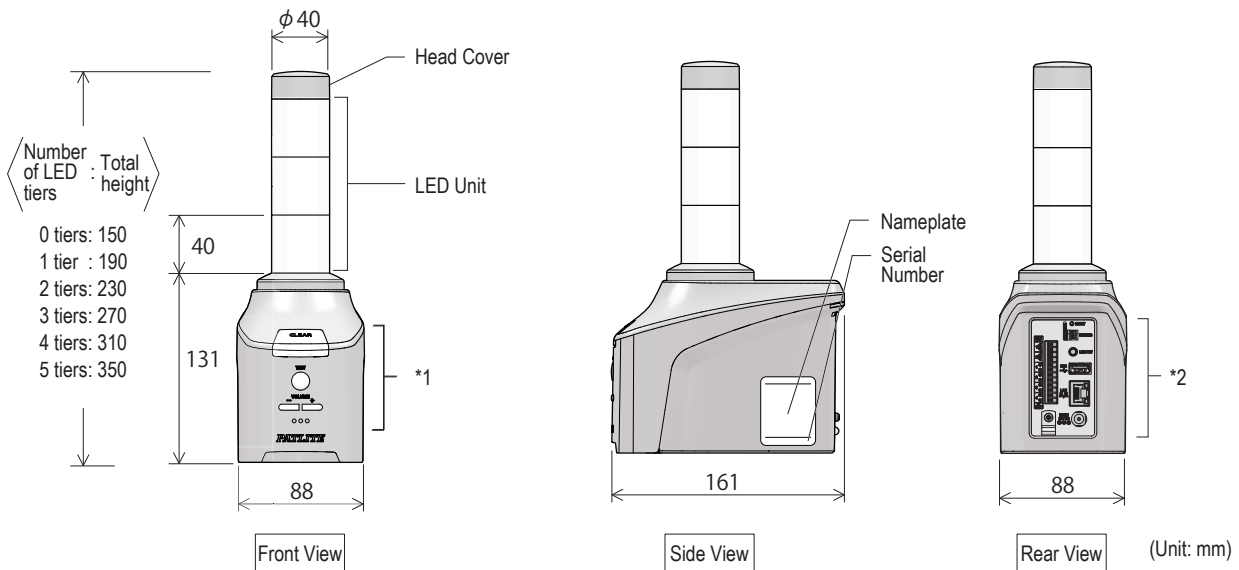

\*3 For "For models without contact inputs/outputs", there is no input/output terminal block.

\*4 Do not use the USB connector as a power supply or for charging.



## 5. Product Features and Functions

### 5.1. Product Features

#### 5.1.1. Installation NHB Series NHV Series

You can choose from various installation methods suitable for your environment.

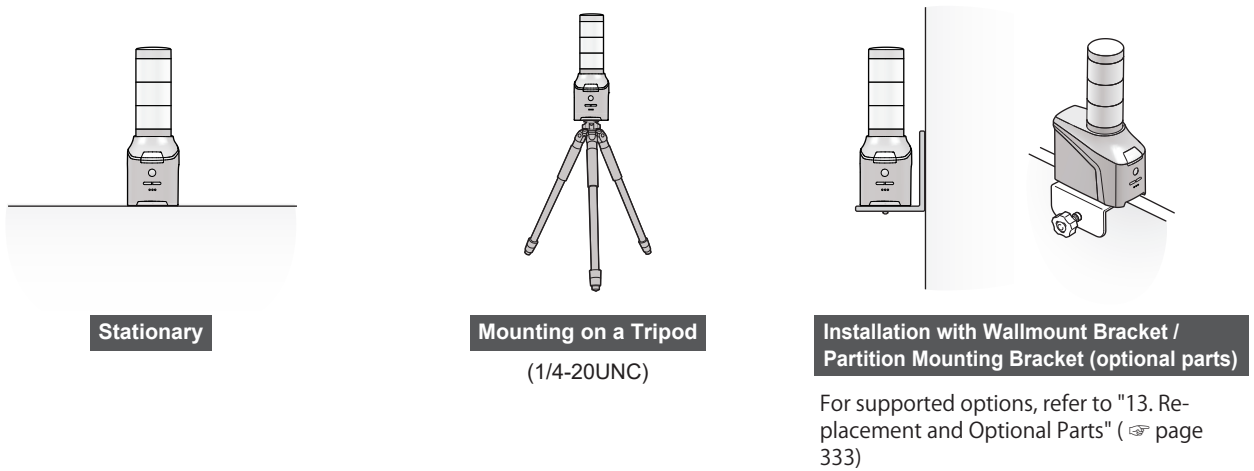

#### 5.1.2. PoE Support NHV Series (P model)

PoE (Power over Ethernet) support allows for an easy power supply without requiring an AC adapter.

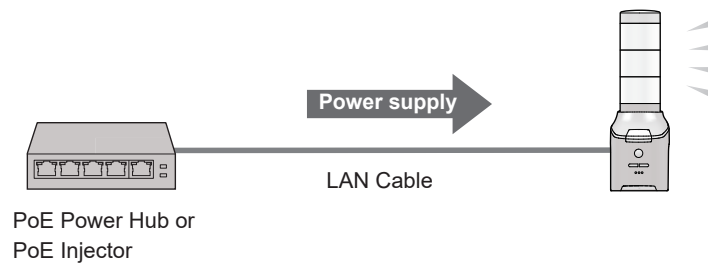

#### 5.1.3. Multilingual Support NHB Series NHV Series

You can work with the Web Setup Screen in multiple supported languages.



##### Supported languages

Japanese, English, Traditional Chinese, Simplified Chinese, Korean, Thai, German, French, Italian, Spanish, Spanish (International), Spanish (Mexico)

### 5.1.4. Operations When Connecting to a Cloud Environment

NHB Series

NHV Series

From the cloud, you can control your products and get their status.  
You can also send the product status to the cloud.



## 5.2. Product Functions

### 5.2.1. Signal Tower, Buzzer, Audio Playback

NHB Series

NHV Series

You can use various ways to notify people about what's going on.

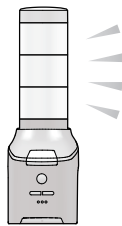

Signal Tower

- Red, Amber, Green, Blue, White, Light off, Light on, 4 flashing patterns
- Adjust between 4 levels of brightness

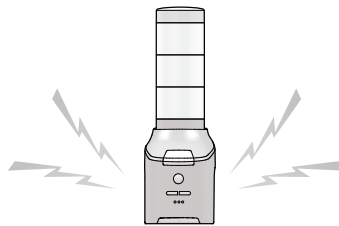

Buzzer

5 buzzer patterns



Audio Playback

NHV Series

- 71 types of message playback (11 preset types)
- 3 patterns of playback modes (one-shot playback, repeat playback, and endless playback)

### 5.2.2. Voice Synthesizer

NHV Series

You can generate and play audio from text information.



### 5.2.3. Monitoring the Status NHB Series NHV Series

You can use various methods for alive monitoring of network devices with contact outputs.



#### PING monitoring

Alive monitoring of the network and devices.  
 This product can perform alive monitoring of up to 24 nodes.  
 If there are any issues in the lines connected to nodes, or there is no response from monitored equipment, the product considers it a problem and performs predefined operations.

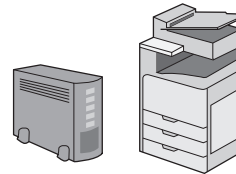

#### SNMP v1 v2c v3

Monitor the state of network equipment at a low cost.  
 This product, as an SNMP manager, receives SNMP TRAPs from equipment on the network (UPS, printers, routers, switches, and so on) and performs predefined operations. Also, the product sends SNMP commands to equipment on the network to monitor their state.

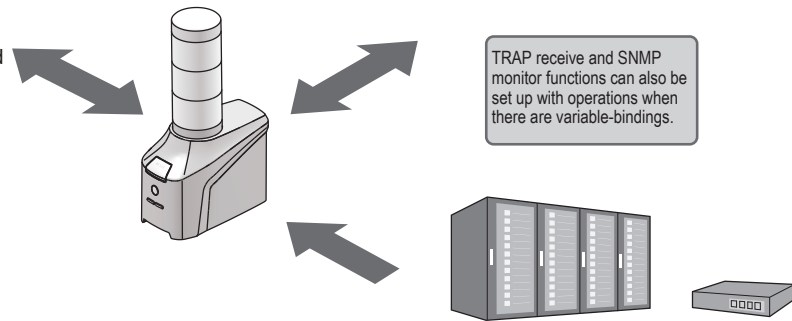

#### Digital input NHV Series (D model)

Monitors the state of equipment with contact outputs.  
 This product, with its four digital inputs, monitors signals from equipment with contact outputs. The product performs predefined operations in response to changes in the input state of equipment.

### 5.2.4. Email detection NHV Series (M model)

You can automatically detect incoming email and report important email only.

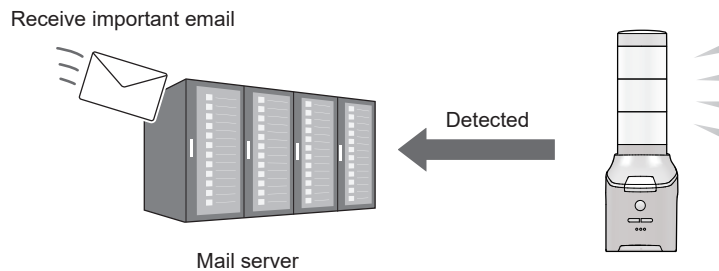

**5.2.5. Commands for Control of Communication** NHB Series NHV Series

- You can use various commands to control or notify the product, as well as check its status.
- You can control this product using the same commands as the NH-FB and NH-FV series.

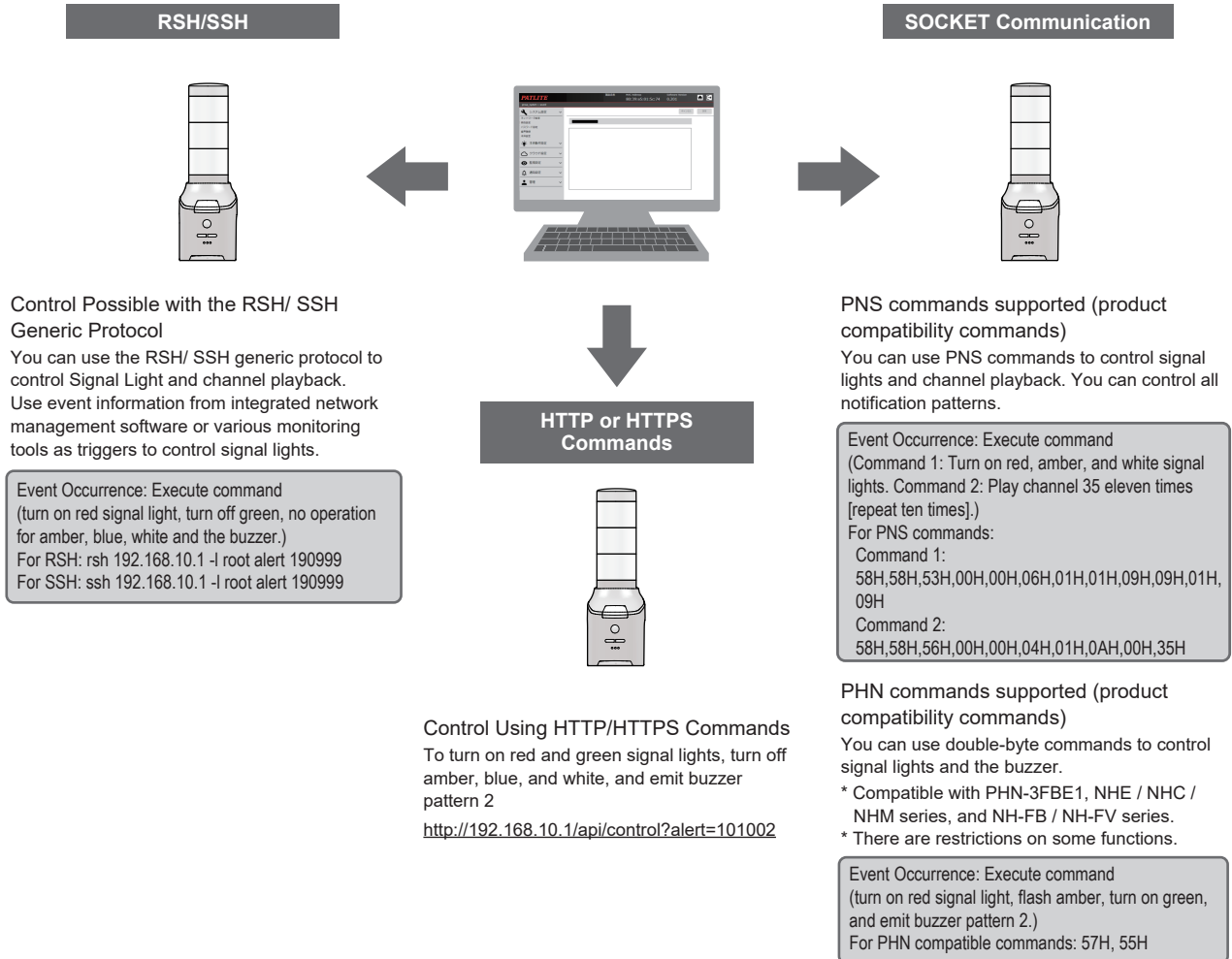

**5.2.6. Status Notification** NHB Series NHV Series

When an event occurs, notifications can be sent in various ways.

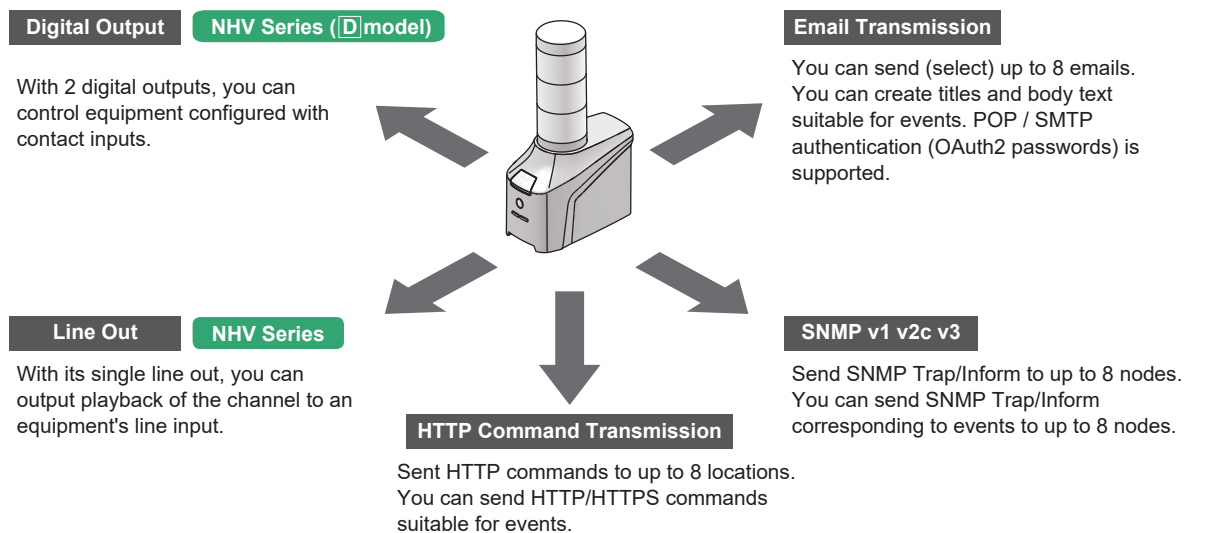

## 5.3. Function Descriptions

This section describes the functions of this product.

### 5.3.1. Signal Tower and Buzzer Notification Functions

- You can turn on, turn off or flash the Signal Tower, or emit a buzzer in response to events.

The following three operation patterns are available.

#### ● Signal Tower operation pattern

Light ON



Flashing Pattern 1



Flashing Pattern 2



Flashing Pattern 3



Flashing Pattern 4



#### ● Signal Tower dimming pattern

You can adjust 4 levels of brightness.

#### ● Buzzer operation pattern

Buzzer Pattern 1



Buzzer Pattern 2



Buzzer Pattern 3



Buzzer Pattern 4



Buzzer Pattern 5



### 5.3.2. Audio Playback Function NHV Series

- You can play back\*1 audio messages (MP3 files) stored in internal memory in response to events.
- This product handles saved messages in "channel" units.

#### ● Types of Channels

There are 71 channels, from 1 to 71, divided into two categories by channel number.

Channel Number	Name	Description
Channels 1 – 60	Registered Channels*2	Channels where users can register messages.
Channels 61 – 71	Preset Channels*3*4	Channels with fixed messages registered at time of shipment.

\*1 You can set the volume for audio playback with the Web Setup Screen or the +/- volume buttons on the front of the product.

\*2 Registration to channels is done from the Web Setup Screen.

\*3 You cannot delete or edit preset channels.

\*4 The line out function is not available for preset channels.

#### ● Audio Playback Pattern for Each Channel

On a channel, you can set a playback pattern for each event. There are three playback patterns.

Playback Pattern	Description
One-shot playback	Playback the channel 1 time. Audio playback will not be repeated.
Repeat playback*1*2	After a channel is played once, repeats playback the set number of times.
Endless playback	Repeatedly playback the channel.

\*1 If the number of times to repeat is set to 0, operates the same as One-shot playback.

\*2 If the number of times to repeat is set to 255, playback will be endless.

#### ● Audio Playback Mode

For the audio playback mode, you can select either [Playback from latest input mode] or [Memory playback mode]. For features about each mode, refer to the following.

##### • Playback from Latest Input Mode

When a new playback event occurs, the channel currently playing is interrupted and a new channel begins playing.

To play the channel at the same time as the event occurs, use this function to synchronize the timing of event operation with channel playback.

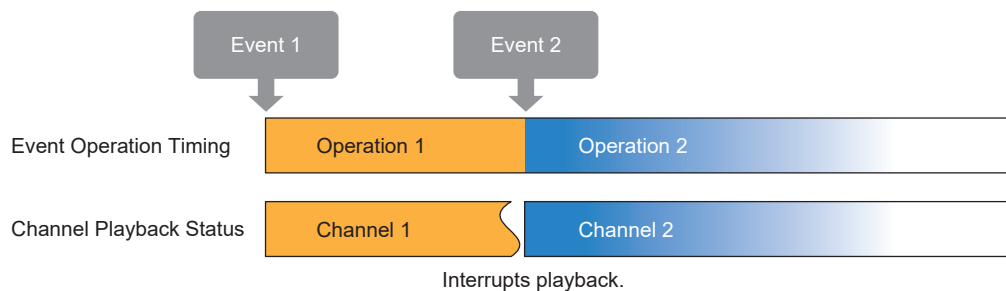

• **Memory Playback Mode (when channel 61 to 64 or 71 is not included)**

When a new playback event occurs, the channel number to play is registered in channel memory. When playback of a channel ends, plays channels in the order they were registered in channel memory. Use this option when you want to play a channel until the end, or when you want to play a channel a set number of times or in a set order.

While Playing	Playback Event
Other than Buzzer Pattern (channel 61 to 64 or 71)	Other than Buzzer Pattern (channel 61 to 64 or 71)

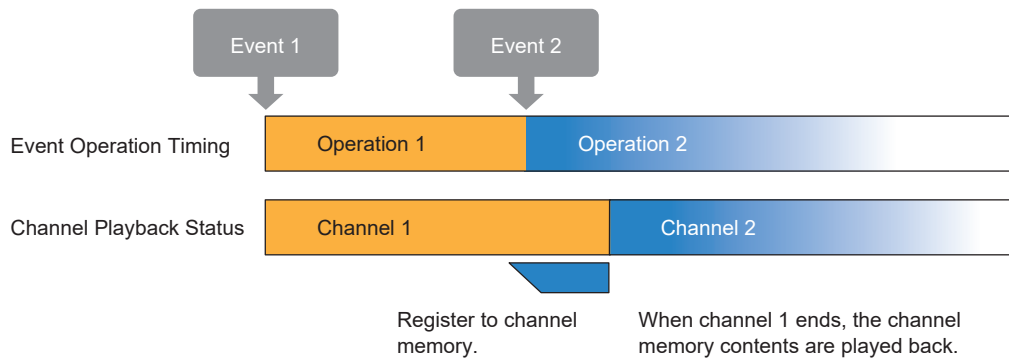

<b>⚠ CAUTION</b>	
⚠	The maximum number of channels that can be registered in channel memory is 5. If you exceed 5 channels, additional channels are not registered in channel memory and are discarded. However, operations set for events (Signal Tower, send email , SNMP notification, and so on) will execute.
⚠	In Memory playback mode, there is a delay between the channel playback and execution of event operations.

• **Memory Playback Mode (when channel 61, 62, 63, 64 or 71 is included)**

In Memory playback mode, when executing operations that include a preset channel (61 to 64 or 71, buzzer pattern 1 to 5), the operation is different from other channels as shown below.

When a playback event occurs while playing channel 61 to 64 or 71 (buzzer pattern 1 to 5)

While a buzzer pattern is playing and a playback event (event 2) occurs, operations can be divided as follows.

Operation	While Playing	Playback Event
A	Buzzer Pattern (channel 61 to 64 or 71)	Other than Buzzer Pattern (channel 61 to 64 or 71)
B	Buzzer Pattern (channel 61 to 64 or 71)	Buzzer Pattern (channel 61 to 64 or 71)

Operation A: When the playback event does not use channel 61 to 64 or 71 (buzzer pattern 1 to 5)

The current buzzer pattern continues to play, and event 2 is registered in channel memory.

As the buzzer pattern's Repeat playback is set as endless playback, use one of the following methods to play Event 2 in the channel memory.

- In the Clear Operation Settings, set [Skip] and press the clear button.
- Execute the RSH/SSH Command [STOP Command].

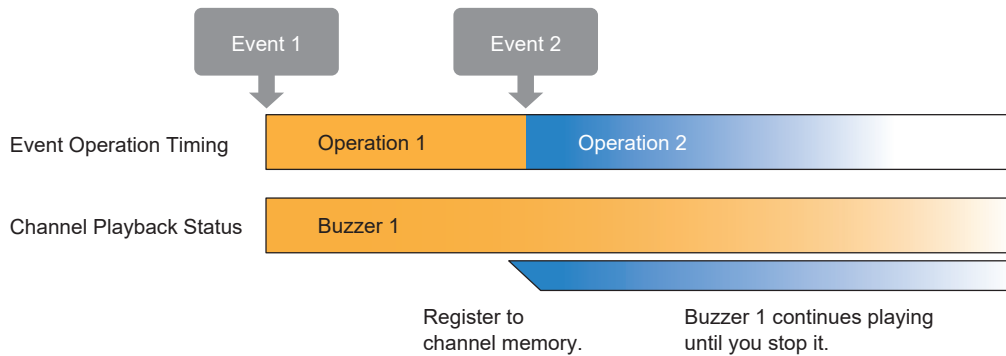



**Operation B: When the playback event that occurred is channel 61 to 64 or 71 (buzzer pattern 1 to 5)**

Even if another channel is playing, instead of registering to channel memory, interrupts the currently playing channel and immediately plays buzzer 2 for event 2. At the start of playback, erases all channels registered in channel memory.

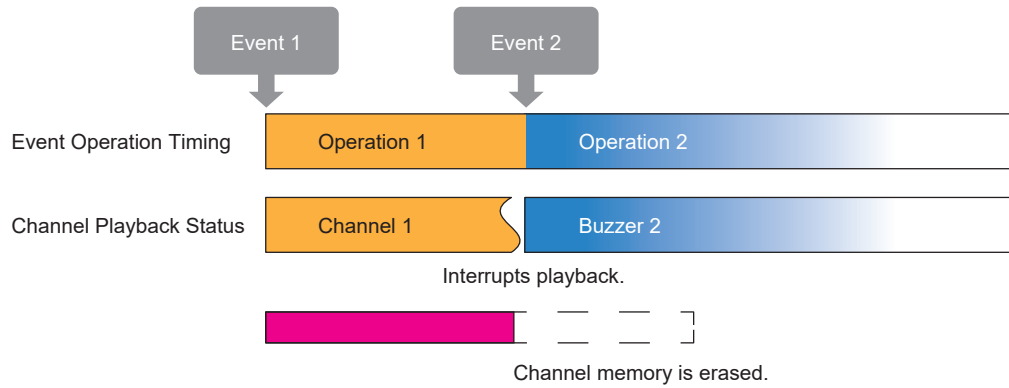

The following audio is registered in the preset channels.

Channel	Registered Content
Channel 61	Buzzer pattern 1
Channel 62	Buzzer pattern 2
Channel 63	Buzzer pattern 3
Channel 64	Buzzer pattern 4
Channel 65	Chime 1 (ET Doorbell)
Channel 66	Chime 2 (start of notification)

Channel	Registered Content
Channel 67	Chime 3 (end of notification)
Channel 68	A problem is detected on the network
Channel 69	A problem has occurred
Channel 70	Problem has been cleared
Channel 71	Buzzer pattern 5

### 5.3.3. Line Out Function NHV Series

Signals from line out can be output in conjunction with audio playback. You can [Enabled] or [Disabled] the line out for each channel.

**CAUTION**

- Do not connect headphones, earphones, or passive speakers (speakers without a built-in amplifier) to line out.
- Do not connect multi-pole mini plugs other than mono or stereo plugs.
- When playing preset channels, no signal is output from line out.

**Point**

- Using the Busy output of the External Contact Output Function, you can set a delay time from when an event occurs until the signal is sent to the line out.
- You can set the signal volume of the line out on the Web Setup Screen.

### 5.3.4. Voice Synthesizer Function NHV Series

- This product can render speech from text and perform audio playback.
- Messages (MP3 files) registered in internal memory from the Web Setup Screen can be played back in response to received digital inputs or control commands. They can also be played directly using HTTP Commands.
- For audio playback using HTTP Commands, refer to "8.3.1.5. Play Any Text" (👉 page 170).
- When using the voice synthesizer, pay attention to the following items to create more natural messages.
- For information on how to register text, refer to "7.16. Setting Up Voice Registration" (👉 page 114).

#### ●Precautions About Input When Performing Voice Synthesis

No.	Input	Description
1	About phonetic reading	On-yomi and Kun-yomi can be distinguished segment by segment, but not the context. Enter hiragana characters to suit your purpose.
2	About phrases	Words that are connected are considered a segment, and emphasis in a syllable or word is placed accordingly. Enter spaces between words if necessary.
3	For words that can be read in multiple ways	The context or name cannot be determined. Enter hiragana characters so it is read correctly.
4	About symbols (such as [ ~ ] and [ * ])	Read aloud using the original character reading. Enter hiragana characters to suit your purpose.
5	About units	Some units are not identified. Enter hiragana characters to suit your purpose.

**CAUTION**

- The specification allows you to enter 200 characters, but if you enter a large number of bytes there would be a long wait for the language analysis process to complete. To resolve long wait times, reduce text inputs to the length of a single, short sentence.
- You cannot stop the language analysis process by executing a clear operation.



### 5.3.5. External Contact Output Function NHV Series (D model)

This product has two external contact output ports. By connecting equipment with a contact input, you can perform contact control.

For the output mode, you can select [Digital Output Mode] or [Busy Output Mode].

#### ● Digital Output Mode

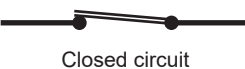
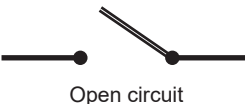
- In response to events, you can control external contact output as a digital output port.
- Contact A (normally open) or Contact B (normally closed).
- The following defines ON and OFF for digital output.
- The contact output can be automatically turned OFF after a period of time from the initial contact control.

Operation Status		ON	OFF	Description
Digital Boolean Value		1 01H	0 00H	
Contact Status	Contact A (make contact) (normally open)	 Closed circuit	 Open circuit	OFF opens the contact. ON closes the contact and allows power to flow.
	Contact B (break contact) (normally closed)	 Open circuit	 Closed circuit	OFF closes the contact and allows power to flow. ON opens the contact.

**⚠ CAUTION**

⚠ When you set the automatic contact output OFF time, after contact output is controlled ON, the contact output automatically turns OFF after the set time elapses.

⚠ If the contact output is controlled ON again before the set time has elapsed, the elapsed time up to that point is cleared.

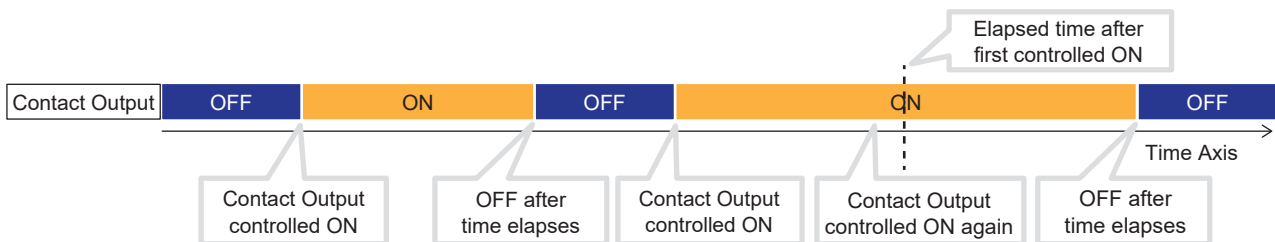

## ● Busy Output Mode

- You can link the signal output from line out with the contact output.
- While signal is output from line out, the contact output is closed, and is opened when the output is stopped.
- In consideration of the rise time of equipment connected to the line out output, you can delay the signal output timing from line out by using the output delay time.



### CAUTION

- ⚠ The logic setting is fixed to Contact A (normally open). Contact B (normally closed) cannot be selected.
- ⚠ You cannot use control commands to control contact output.
- ⚠ For playback of preset channels, as line out output does not take place, Busy output does not work.
- ⚠ For Playback from latest Input mode, if a new event occurs while the output delay time has not fully elapsed, the output delay time is canceled and the next event operation is executed.
- ⚠ If an event occurs within 1 second after the line out output is stopped, the Busy output remains closed. In this case, the output delay is disabled and the line out output occurs without delay.

### 5.3.6. Send Email Function

- In response to an event, you can send email to registered email addresses (up to 8).
- Supported Authentication methods are SMTP authentication (password, OAuth2), POP authentication, and no authentication.
- Supported encryption methods are SSL/TLS, STARTTLS, and None.
- The structure of the contents of the email that is sent is as follows.

①
Installation location : ② Equipment name : ③ Contact : ④ Event that occurred : ⑤ Information : ⑥
⑦

No.	Function	Description
①	Subject*	Displays the subject specified by the event notification.
②	Installation location	Displays the set installation location.
③	Equipment name	Displays the set name of equipment.
④	Contact	Displays the set contact information.
⑤	Event that occurred	Displays the name of the event that took place.
⑥	Information	Displays information about the event.
⑦	Body text*	Includes the body text specified in the event notification.

\* You can select the subject and body text from among a total of 17, 16 that you can register for events and 1 that is fixed.

\* When using the fixed subject (17th item), the subject of the sent email is in the following format.

**<Installation location>:<YY/MM/DD hh:mm>:<Event details>:<Name>**

Year Month Date Hours Seconds

\* When using the fixed text (17th item), the information of Installation location, Equipment name, Contact, Event that occurred, Information, and Body text are not sent.

## ● List of Event Content and Names

In response to the event that occurred, event content and name are listed with the following information.

Event that occurred	Event Content	Name
TRAP received	<none>	Group name as registered in the TRAP monitoring settings
Cleared using push-button switch	": CLEAR-Button"	<none>
Cleared using SNMP	": CLEAR-Snmp"	<none>
Cleared using RSH/SSH	": CLEAR-Rsh/Ssh"	<none>
Ping monitoring error detected	": PING-Error"	Unit name as registered in the Ping Monitoring Settings
Ping monitoring recovery detected	": PING-Recover"	Unit name as registered in the Ping Monitoring Mettings
Ping group monitoring error detected	": PING_Group-Error"	<none>
Ping group monitoring recovery detected	": PING_Group-Recover"	<none>
RSH/SSH Command executed	": RSH/SSH-Executes"	<none>
Test button pressed	": TEST-Button"	<none>
Digital input contact changed to ON state	": DINPUT-On"	Number of the digital input that turned on, DI1 to DI4
Digital input contact changed to OFF state	": DINPUT-Off"	Number of the digital input that turned off, DI1 to DI4
Condition matched for SNMP Device Monitoring	": SNMPGET-Match"	Equipment name registered in SNMP Device Monitoring Settings - Match Detection Settings
Condition released for SNMP Device Monitoring	": SNMPGET-Release"	Equipment name registered in SNMP Device Monitoring Settings - Release condition settings
Change detected for SNMP Device Monitoring	": SNMPGET-Change"	<none>
Match digital input condition	": DINPUT-Condition"	Number of the digital input (1 to 4) whose condition matched the condition setting
Detect email	": MAILFILTER-Match"	Number registered in Mail detection setting - Filter rule settings

## ● List of Additional Information

In response to the event that occurred, additional information is listed with the following content.

Event Listed	Additional Information Listed
TRAP was received.	Group name: Registered address
The "Clear" Button was pushed.	None
A "Clear" was made by the SNMP.	None
A "Clear" was made by the RSH/SSH.	IP address
Ping Monitor Abnormality detected.	Unit name: Registered address
Ping Monitor Recovery detected.	Unit name: Registered address
Ping Group Monitor Abnormality detected.	Unit name: Registered address : Group
Ping Group Monitor Recovery detected.	Unit name: Registered address : Group
RSH/SSH Command was executed.	IP address
Test Button was pressed.	None
Digital input was set to ON.	Port number (1 to 4)
Digital input was set to OFF.	Port number (1 to 4)
Conditions agreed with the SNMP supported equipment.	Equipment Name: Monitored address
Conditions agreed with the SNMP supported equipment were cancelled.	Equipment Name: Monitored address
SNMP supported equipment changes were detected.	Equipment Name: Monitored address
Digital Input conditions agree.	Input condition (1 to 4)
Conditions agreed with the Mail detection.	Matched Filter: Registered filter number

### 5.3.7. SNMP TRAP/Inform Transmission Function

- In response to events, you can send SNMP Trap/Inform to 8 SNMP-enabled equipment.
- Supported SNMP versions are v1, v2c, and v3.
- For the notification method, you can choose either TRAP or Inform transmission.
- For information on Trap transmission, refer to "10. MIB List" (☞ page 314).
- For the procedure on using SNMP TRAP transmissions, refer to "8.1.1. Setting Up SNMP (Trap Inform) Notification Settings" (☞ page 118).

#### ● Communication Protocols

Protocol	Port Number
UDP	162

### 5.3.8. Send HTTP Command Function

- In response to events, you can send HTTP/HTTPS Commands to 8 equipment on the network.
- For the protocol, select either [HTTP] or [HTTPS].
- For the procedure on sending HTTP Commands, refer to "8.1.3. Setting Up HTTP Command Sending Settings" (☞ page 125).

#### ● Communication Port

Protocol	Port Number
HTTP	80
HTTPS	443

### 5.3.9. Send HTTP Command Function

- In response to changing Signal Tower, you can transmit the change information of Signal Tower and buzzer via HTTP/HTTPS to 8 equipment on the network.
- For the protocol, select either [HTTP] or [HTTPS].
- Change information is transmitted using HTTP command with "alert" parameter.

"● Parameters You Can Execute" on page 55

#### ● Communication Port

Protocol	Port Number
HTTP	80
HTTPS	443



### 5.3.10. RSH/SSH Command Function

You can use this product with RSH (Remote Shell) or SSH (Secure Shell) to execute shell commands from another computer.

By executing commands, you can get and control the status of the Signal Tower.

There are two different formats for executing shell commands. For information on each command, refer to explanations on the commands.

#### RSH

- rsh Space <IP address> [Space-l Space<login name>] Space<command> [Space<option>]
- rsh Space <IP address> Space-l Space<common login name> Space<command> [Space<option>]

#### SSH

ssh Space <IP address> [Space-l Space<login name>] Space<command> [Space<option>]

**Point**

- You can omit [ ].
- For the IP address, specify [IPv4 address], [IPv6 address], or [Host name].
- When executing without the login name, make sure you set the source IP address and login name in the command reception settings.
- Do not forget a space between each element in the command.
- In the RSH Command Reception Settings, when the send-from address restriction is [Disabled], execute the command using a common login name.

### ● Commands You Can Execute

Command	Description
alert	Controls the Signal Tower and buzzer.
alert do	Controls digital output.
color	Controls the Signal Tower and buzzer.
sound	Controls the Signal Tower and audio playback.
stop	Stops playing audio.
clear	Executes the clear operation and returns to the normal operation status.
doclear	
status	Gets the state of the Signal Tower, buzzer, audio playback channel, and digital I/O.
test	Runs a self-test.
dotest	

## ● Descriptions of Each Command

### • alert Command

Overview	Control Signal Tower (rygbc) and buzzer (bz)
Format	alert <r><y><g><b><c><bz> [<sec>]
Return Value	<r><y><g><b><c><bz> (state of Signal Tower after command is executed)

Type		Value
r	Red unit	Light pattern 0: Light off 1: Light on 2: Flashing pattern 1 3: Flashing pattern 2 4: Flashing pattern 3 5: Flashing pattern 4 9: No control
y	Amber unit	
g	Green unit	
b	Blue unit	
c	White unit	
bz	Buzzer	Buzzer pattern 0: Buzzer off 1: Buzzer pattern 1 2: Buzzer pattern 2 3: Buzzer pattern 3 4: Buzzer pattern 4 5: Buzzer pattern 5 9: No control
sec	Control time	Control time (seconds) 0: Do not specify the control time (can be omitted) 1 to 99: Specified amount of control time



## CAUTION

 If you execute an alert command while another alert command is running, the control time is overwritten. However, in the RSH/SSH Command Reception Settings, if restore timer is set individually, you can also individually specify the control time.

### Point

- Items in brackets [ ] are optional. Can be omitted.
- When the set time elapses, returns to the Signal Tower state and operation of channels 61 to 64 or 71 (buzzer pattern 1 to 5) before the alert command was executed.
- When the control time is omitted, the control state is continuous.

• **alert do Command** NHV Series (D model)

Overview	Control digital output <do1><do2>
Format	alert do <do1><do2>
Return Value	<do1><do2> (digital output state after command is executed)

Type		Value
do1	Digital Output 1	Digital Output State 0: OFF
do2	Digital Output 2	1: ON 9: No control

 **CAUTION**

- ⚠ In the External Contact Output settings, ports set to Busy output cannot be controlled.
- ⚠ When set to Busy output, the digital output status is OFF regardless of the actual output state.
- ⚠ ON and OFF indicate the digital boolean value of each port.
- ⚠ You can omit do2, but you cannot omit do1.

• **color Command**

Overview	Control a Signal Tower’s LED unit (multi-color) and buzzer
Format	color <col> [<c-pat>] [-b <b-pat>]
Return Value	<col> [<c-pat>] [-b <b-pat>] (state of Signal Tower after command is executed)

Type		Value
col	LED Unit Color	Color of light for LED unit (multi-color) Red Amber Green Blue White Purple Light blue OFF: Light off NONE: No control
c-pat	Light on, flashing pattern	Light on, flashing pattern 1: Light on 2: Flashing pattern 1 3: Flashing pattern 2 4: Flashing pattern 3 5: Flashing pattern 4
b-pat	Buzzer	Buzzer pattern 0: Buzzer off 1: Buzzer pattern 1 2: Buzzer pattern 2 3: Buzzer pattern 3 4: Buzzer pattern 4 5: Buzzer pattern 5 9: No control

 <b>CAUTION</b>
❗ The color command should only be used when a Multi-color unit is installed.

<b>Point</b>
● Items in brackets [ ] are optional. Can be omitted.

• **sound Command** NHV Series

Overview	Control Signal Tower (rygbc) and audio playback (ch)
Format	sound [-r <repeat>] [-c <r><y><g><b><c>] <ch>
Return Value	<ch> (audio playback channel for after command is executed)

Type		Value
repeat	Number of times to repeat	Number of times to repeat 0: One-shot playback (can be omitted) 1 to 254: Number of times to repeat 255: Endless playback
r	Red unit	Light pattern 0: Light off 1: Light on 2: Flashing pattern 1 3: Flashing pattern 2 4: Flashing pattern 3 5: Flashing pattern 4 9: No control
y	Amber unit	
g	Green unit	
b	Blue unit	
c	White unit	
ch	Audio channel	Audio playback channel 1 to 71: Audio channel

**CAUTION**

If you omit the number of times to repeat, plays one time.

Channels 61 to 64 and 71 are always played back in [Playback from latest input mode].

**Point**

- Items in brackets [ ] are optional. Can be omitted.

• **stop Command** NHV Series

Overview	<ul style="list-style-type: none"> <li>• Stop audio playback (ch) (when using [Playback from latest input mode])</li> <li>• Skip Track (in Memory playback mode)</li> </ul>
Format	stop
Return Value	<ch> (audio playback channel before command is executed)

Type		Value
ch	Audio channel	Audio playback channel 0: Stop 1 to 71: Audio channel

• **clear Command, doclear Command**

Overview	Execute the clear operation and return to normal operating status
Format	clear [-p] [-z]
	doclear [-p] [-z]
Return Value	<r><y><g><b><c><bz> (state of Signal Tower after command is executed)

Type		Value
r	Red unit	Light pattern 0: Light off 1: Light on 9: Uncontrolled
y	Amber unit	
g	Green unit	
b	Blue unit	
c	White unit	
bz	Buzzer	Buzzer pattern 0: Buzzer off 9: Uncontrolled

 <b>CAUTION</b>
<p> When the option "-p" is added, buzzer and audio playback are not controlled.</p> <p> When the option "-z" is added, Signal Tower units (Red, Amber, Green, Blue, and White) are not controlled.</p>

<b>Point</b>
<ul style="list-style-type: none"> <li>● Items in brackets [ ] are optional. Can be omitted.</li> <li>● For information about the clear operation, refer to "5.3.21. Clear Operation Function" (  page 70).</li> </ul>

• **status Command**

Overview	Get the digital I/O state of Signal Tower, buzzer, and audio playback channels	
Format	status [-s] [di] [do]	
Return Value	No option	<r><y><g><b><c><bz> (state of Signal Tower when command is executed)
	Option -s	<ch> (audio playback channel when command is executed)
	Option di	DI: <di1><di2><di3><di4> (state of digital input when command is executed)
	Option do	DO: <do1><do2> (state of digital output when command is executed)

Type		Value
r	Red unit	Light pattern 0: Light off 1: Light on 2: Flashing pattern 1 3: Flashing pattern 2 4: Flashing pattern 3 5: Flashing pattern 4
y	Amber unit	
g	Green unit	
b	Blue unit	
c	White unit	
bz	Buzzer	Buzzer pattern 0: Buzzer off 1: Buzzer pattern 1 2: Buzzer pattern 2 3: Buzzer pattern 3 4: Buzzer pattern 4 5: Buzzer pattern 5
ch	Audio channel	Audio playback channel 0: Stopped 1 to 71: Audio channel
di1	Digital Input 1	Digital Input State 0: OFF 1: ON
di2	Digital Input 2	
di3	Digital Input 3	
di4	Digital Input 4	
do1	Digital Output 1	Digital Output State 0: OFF 1: ON
do2	Digital Output 2	

 **CAUTION**

 When set to Busy output, the digital output status is OFF regardless of the actual output state.

 Options "-s", "di", and "do" cannot be specified at the same time.

**Point**

● Items in brackets [ ] are optional. Can be omitted.

• **test Command, dotest Command**

For information about self-test, refer to "5.3.22. Self-test Function" (☞ page 72).

Overview	Runs a self-test
Format	test
	dotest
Return Value	None

 <b>CAUTION</b>
<ul style="list-style-type: none"> <li>❗ The monitoring function continues operating while self-test is running. Be careful when checking the operation.</li> <li>⚠️ If PNS and PHN Commands are executed during or after execution of self-test, an error response is returned. The RSH or SSH Command returns a Busy response.</li> </ul>

<b>Point</b>
<ul style="list-style-type: none"> <li>● For information on the clear process during self-test, refer to "5.3.21. Clear Operation Function" (☞ page 70).</li> </ul>



### 5.3.11. PNS Command Function (product compatibility commands)

By entering NH series commands, this product can get the state of the Signal Tower, as well as control the Signal Tower.

#### ● Communication Protocols

Protocol	Port Number
TCP	5000 to 65535
UDP	

#### ● Commands You Can Execute

Command	ID	Description
Signal Tower and Buzzer control Commands	S	Controls the Signal Tower and buzzer.
Audio Playback control Commands	V	Controls audio playback.
Digital output control Commands	D	Controls digital output.
Signal Tower and Audio Playback control Commands	W	Controls Signal Tower and audio playback.
Get status Command	G	Gets the state of the Signal Tower and buzzer.
Clear Command	C	Executes the clear operation and returns to the normal operation status.
Multi-color unit control Commands	M	Controls Multi-color units and audio playback.

● Descriptions of Each Command

• Signal Tower and Buzzer control Commands

Request Command

Product Category		ID	Unused	Data Size		Data					
X	X	S	-	-	-	Signal Tower					Buzzer
58H	58H	53H	00H	00H	06H	Red	Amber	Green	Blue	White	
1 byte	1 byte	1 byte	1 byte	2 bytes		1 byte	1 byte	1 byte	1 byte	1 byte	1 byte

Type		Value
Signal Tower	Red	Light pattern 00H: Light off
	Amber	01H: Light on
	Green	02H: Flashing pattern 1 03H: Flashing pattern 2
	Blue	04H: Flashing pattern 3
	White	05H: Flashing pattern 4 09H: No control
Buzzer		Buzzer pattern 00H: Buzzer off 01H: Buzzer pattern 1 02H: Buzzer pattern 2 03H: Buzzer pattern 3 04H: Buzzer pattern 4 05H: Buzzer pattern 5 09H: No control

Response Command

Normal response
ACK
06H
1 byte

Error response
NAK
15H
1 byte

• **Audio Playback Control Commands**

**Request Command**

Product Category		ID	Unused	Data Size		Data			
X	X	V	-	-	-	Playback Pattern	Number of times to repeat	(unused)	Audio Channel
58H	58H	56H	00H	00H	04H			00H	
1 byte	1 byte	1 byte	1 byte	2 bytes		1 byte	1 byte	1 byte	1 byte

Type	Value
Playback Pattern	Playback Pattern 00H: Stop playback (skip track) 01H: Repeat playback
Number of times to repeat	Number of times to repeat 00H: One-shot playback 01H to FEH: Number of times to repeat FFH: Endless playback
Audio Channel	Audio playback channel 01H to 71H: Audio channel *Specify using BCD format.

**Response Command**

Normal response
ACK
06H
1 byte

Error response
NAK
15H
1 byte

• **Digital Output Control Commands**

**Request Command**

Product Category		ID	Unused	Data Size		Data	Data
X	X	D	-	-	-	Digital Output 1	Digital Output 2
58H	58H	44H	00H	00H	02H		
1 byte	1 byte	1 byte	1 byte	2 bytes		1 byte	1 byte

Type	Value
Digital Output 1	Digital Output State 00H: OFF
Digital Output 2	01H: ON 09H: No control

**Response Command**

Normal response
ACK
06H
1 byte

Error response
NAK
15H
1 byte

 <b>CAUTION</b>
 In the External Contact Output settings, ports set to Busy output cannot be used for control.

• **Signal Tower and Audio Playback Control Commands**

**Request Command**

Product Category		ID	Unused	Data Size	
X	X	W	-	-	-
58H	58H	57H	00H	00H	0AH
1 byte	1 byte	1 byte	1 byte	2 bytes	

Data									
Signal Tower					(unused)	Playback Pattern	Number of times to repeat	(unused)	Audio Channel
Red	Amber	Green	Blue	White	00H			00H	
1 byte	1 byte	1 byte	1 byte	1 byte	1 byte	1 byte	1 byte	1 byte	1 byte

Type	Value	
Signal Tower	Red	Light Pattern 00H: Light off
	Amber	01H: Light on
	Green	02H: Flashing pattern 1
		03H: Flashing pattern 2
	Blue	04H: Flashing pattern 3
White	05H: Flashing pattern 4 09H: No control	
Playback Pattern	Playback Pattern 00H: Stop playback (skip track) 01H: Repeat playback	
Number of times to repeat	Number of times to repeat 00H: One-shot playback 01H to FEH: Number of times to repeat FFH: Endless playback	
Audio Channel	Audio Playback Channel 01H to 71H: Audio channel *Specify in BCD format.	

**Response Command**

Normal response
ACK
06H
1 byte

Error response
NAK
15H
1 byte

• **Get Status Command**

**Request Command**

Product Category		ID	Unused	Data Size	
X	X	G	-	-	-
58H	58H	47H	00H	00H	00H
1 byte	1 byte	1 byte	1 byte	2 bytes	

**Response Command**

Response Data					
Signal Tower					
Red	Amber	Green	Blue	White	Buzzer
1 byte	1 byte	1 byte	1 byte	1 byte	1 byte

Type	Value
Signal Tower	Red Light Pattern
	Amber 00H: Light off 01H: Light on
	Green 02H: Flashing pattern 1 03H: Flashing pattern 2
	Blue 04H: Flashing pattern 3
	White 05H: Flashing pattern 4
Buzzer	Buzzer pattern 00H: Buzzer off 01H: Buzzer pattern 1 02H: Buzzer pattern 2 03H: Buzzer pattern 3 04H: Buzzer pattern 4 05H: Buzzer pattern 5

## • Clear Command

### Request Command

Product Category		ID	Unused	Data Size	
X	X	C	-	-	-
58H	58H	43H	00H	00H	00H
1 byte	1 byte	1 byte	1 byte	2 bytes	

### Response Command

Normal response	Error response
ACK	NAK
06H	15H
1 byte	1 byte

• **Multi-color unit control Commands**

**Request Command**

Product Category		ID	Unused	Data Size	
X	X	M	-	-	-
58H	58H	4DH	00H	00H	07H
1 byte	1 byte	1 byte	1 byte	2 bytes	

Data						
Multi-color unit		Buzzer	Audio Playback			
			Playback Pattern	Number of times to repeat	(unused)	Audio Channel
Color	Lighting pattern	00H				
1 byte	1 byte	1 byte	1 byte	1 byte	1 byte	1 byte

Type	Value
Color	Color of the Multi-color unit 01H: Red 02H: Amber 03H: Green 04H: Blue 05H: White 06H: Purple 07H: Light blue
Lighting pattern	Lighting pattern 00H: Light off 01H: Light on 02H: Flashing pattern 1 03H: Flashing pattern 2 04H: Flashing pattern 3 05H: Flashing pattern 4
Buzzer	Buzzer pattern 00H: Buzzer off 01H: Buzzer pattern 1 02H: Buzzer pattern 2 03H: Buzzer pattern 3 04H: Buzzer pattern 4 05H: Buzzer pattern 5 09H: No control





Type	Value
Playback Pattern	Playback Pattern 00H: Stop playback (skip track) 01H: Repeat playback
Number of times to repeat	Number of times to repeat 00H: One-shot playback 01H to FEH: Number of times to repeat FFH: Endless playback
Audio Channel	Audio playback channel 01H to 71H: Audio channel *Specify using BCD format.



**Response Command**

Normal response	Error response
ACK	NAK
06H	15H
1 byte	1 byte

**CAUTION**

-  The Multi-color unit control Commands should only be used when a Multi-color unit is installed.
-  When playing audio playback, do not control the buzzer.
-  You can omit audio playback.
-  When you play audio playback in NHB series, it is ignored.

### 5.3.12. PHN Command Function (product compatibility commands)

By entering PHN series commands, this product can get the state of the Signal Tower, as well as control the Signal Tower.

#### ● Communication Protocols

Protocol	Port Number
TCP	5000 to 65535
UDP	

#### ● Commands You Can Execute

Command	Description
W	Write Command
R	Read Command

#### ● Descriptions of Each Command

##### • Write Command

Request Command

Request Command	Operation Data							
	Signal Tower / Flashing pattern 1			Buzzer pattern (Audio Channel)		Signal Tower / Flashing pattern		
W	Green	Amber	Red	Buzzer pattern 2 (62)	Buzzer pattern 1 (61)	Green	Amber	Red
57H								
1 byte	1 byte							

Item	Value
Signal Tower / Flashing pattern 1	Green
	Amber
	Red
Buzzer	Buzzer pattern 2
	Buzzer pattern 1
Signal Tower / Flashing pattern	Green
	Amber
	Red

### CAUTION

 Can control the Signal Tower's Red, Amber, and Green lights and buzzer patterns 1 and 2 only.

**Response Command**

Normal response			Error response		
A	C	K	N	A	K
41H	43H	4BH	4EH	41H	4BH
1 byte	1 byte	1 byte	1 byte	1 byte	1 byte

• **Read Command**

**Request Command**

Request Command
R
52H
1 byte

**Response Command**

Response Command	Operation Data								
R	Signal Tower / Flashing pattern 1			Buzzer pattern(Audio Channel)			Signal Tower / Flashing pattern		
52H	Green	Amber	Red	Buzzer pattern 2 (62)	Buzzer pattern 1 (61)	Green	Amber	Red	
1 byte	1 byte								

Item	Value
Signal Tower / Flashing pattern 1	Green
	Amber
	Red
Buzzer	Buzzer pattern 2
	Buzzer pattern 1
Signal Tower / Flashing pattern	Green
	Amber
	Red

### 5.3.13. HTTP Command Reception Function

This product can use HTTP/HTTPS commands to get the state of the Signal Tower, as well as control the Signal Tower.

#### ● Protocol

Protocol	Port Number
HTTP	80
HTTPS	443

#### ● Request Method

GET

#### ● Format

The format for executing HTTP Commands is as follows.

HTTP

http://<address of this product>/api/<command>?<parameter>=<value>[&<parameter>=<value>][&<parameter>=<value>]

HTTPS

https://<address of this product>/api/<command>?<parameter>=<value>[&<parameter>=<value>][&<parameter>=<value>]

#### Point

- Square brackets [ ] can be specified for specific commands and parameters only.
- You can specify the address using [IPv4 Address], [IPv6 Address], or [Host Name].

#### ● Commands You Can Execute

Command	Description
control	Control the Signal Tower in accordance with the request specified by the parameter.
status	Return Signal Tower information in accordance with the request specified by the parameter.

## ● Parameters You Can Execute

For command control

Parameter	Value		Description
alert	<r><y><g><b><c><bz>	r: Signal Tower Red y: Signal Tower Amber g: Signal Tower Green b: Signal Tower Blue c: Signal Tower White bz: Buzzer	Controls the Signal Tower and buzzer. Light Pattern 0: Light off 1: Light on 2: Flashing pattern 1 3: Flashing pattern 2 4: Flashing pattern 3 5: Flashing pattern 4 9: No control Buzzer pattern 0: Buzzer off 1: Buzzer pattern 1 2: Buzzer pattern 2 3: Buzzer pattern 3 4: Buzzer pattern 4 5: Buzzer pattern 5 9: No control
output	<do1><do2>	do1: digital output 1 do2: digital output 2	Controls digital output. 0: OFF 1: ON 9: No control
led	<r><y><g><b><c>	r: Signal Tower Red y: Signal Tower Amber g: Signal Tower Green b: Signal Tower Blue c: Signal Tower White	Controls the Signal Tower. Light Pattern 0: Light off 1: Light on 2: Flashing pattern 1 3: Flashing pattern 2 4: Flashing pattern 3 5: Flashing pattern 4 9: No control
color	<color>		Controls the multi-color. Red: Red Amber: Amber Green: Green Blue: Blue White: White Purple: Purple Cyan: Cyan NONE: No control

Parameter	Value	Description
c-pat	<c-pat>	Controls the multi-color pattern. This parameter is used as an additional parameter for the color command. 1: Light on 2: Flashing pattern 1 3: Flashing pattern 2 4: Flashing pattern 3 5: Flashing pattern 4
b-pat	<b-pat>	Controls the buzzer This parameter is used as an additional parameter for the color command. 0: Buzzer off 1: Buzzer pattern 1 2: Buzzer pattern 2 3: Buzzer pattern 3 4: Buzzer pattern 4 5: Buzzer pattern 5 9: No control
sound	<ch>	Controls audio playback. 1 to 71: Audio channel
repeat	<repeat>	Specifies the number of times to repeat audio playback. This parameter is used as an additional parameter for the sound and speech command. 0: One-shot playback 1 to 254: Number of times to repeat 255: Endless playback
restore	<restore>	Specifies the control time (seconds). 0: Do not specify the control time (can be omitted) 1 to 99: Specified amount of control time
stop	1	The following operations are performed in accordance with product settings. • Stop audio playback (Playback from latest input mode) • Skip track (Memory playback mode)
clear	1	Executes the clear operation and returns to the normal operation status.
speech	<text>	Plays back audio of any text that was entered. Maximum 50 characters
lang	<lang>	Selects the language for audio playback. This parameter is used as an additional parameter for the speech command. jp Japanese en English
voice	<voice>	Selects the language for audio. This parameter is used as an additional parameter for the speech command. male / female
speed	-5 to 5	Specifies the speed of audio playback. This parameter is used as an additional parameter for the speech command.
tone	-5 to 5	Specifies the pitch of the voice for audio playback. This parameter is used as an additional parameter for the speech command.

 **CAUTION**

- ❗ Specify "restore" at the same time as you specify "alert". It will not operate when you specify other parameters.
- ⚠ Environment-dependent characters such as "©" and "♠" and some symbols such as "¥" and "〜" may not be synthesized correctly.

**Point**

- You can specify "led" at the same time as "sound" or "speech" at the same time.

For command status

Parameter	Value	Description
format	<format>	Returns the state of the Signal Tower in the specified format. xml: Data in XML format json: Data in JSON format

● **Responses When Executing HTTP Commands**

For command control

When successful	Success.
When failed	Error.<error code>

Error Code	Description
002	Invalid command.
003	The command is not specified.
004	The value is not specified.
005	Invalid value.

For command status

When successful	Data of response in the specified format
When failed	Error.

● List of Data You Can Get

XML

Data			Description
color	color name	Name of Signal Tower Color	LED1: Red LED2: Amber LED3: Green LED4: Blue LED5: White MULTI_COL: Multi-color MULTI_PAT: Multi-color pattern
	value	State of Signal Tower	• LED 1 to 5, MULTI_PAT 0: Light off 1: Light on 2: Flashing pattern 1 3: Flashing pattern 2 4: Flashing pattern 3 5: Flashing pattern 4 • MULTI_COL 0: Light off 1: Red 2: Amber 3: Green 4: Blue 5: White 6: Purple 7: Light blue
buzzer	buzzer name	Buzzer Name	BUZZER Sounds
	value	Buzzer pattern	0: Stop 1: Buzzer pattern 1 2: Buzzer pattern 2 3: Buzzer pattern 3 4: Buzzer pattern 4 5: Buzzer pattern 5
sound	sound name	Name of Audio Playback	SOUND Audio Playback
	value	Audio Playback Channel	0: Stop audio 1 to 71: Audio channel
port	port name	Name of Digital Input/Output	DO-1: Digital Output 1 DO-2: Digital Output 2 DIN-1: Digital Input 1 DIN-2: Digital Input 2 DIN-3: Digital Input 3 DIN-4: Digital Input 4
	value	State of Digital Input/Output	0: OFF 1: ON



json

Command		Type	Description
Unit_Status	Status of Signal Tower Color	number	Indicate the pattern in order, R (Red) → Y (Amber) → G (Green) → B (Blue) → C (White) 0: Light off 1: Light on 2: Flashing pattern 1 3: Flashing pattern 2 4: Flashing pattern 3 5: Flashing pattern 4
Multi_Color	Multi-color		0: Light off 1: Red 2: Amber 3: Green 4: Blue 5: White 6: Purple 7: Light blue
Multi_Pattern	Multi-color pattern		0: Light off 1: Light on 2: Flashing pattern 1 3: Flashing pattern 2 4: Flashing pattern 3 5: Flashing pattern 4
Buzzer_Pattern	Buzzer pattern		0: Stop 1: Buzzer pattern 1 2: Buzzer pattern 2 3: Buzzer pattern 3 4: Buzzer pattern 4 5: Buzzer pattern 5
Sound_CH	Audio Playback Channel		0: Stop audio 1 to 71: Audio channel
Digital_Output	Digital output		0: OFF 1: ON
Digital_Input	Digital input		0: OFF 1: ON
Software_Version	Software version		string
MAC_Address	MAC address	The MAC address on this product	

### 5.3.14. SNMP Command Functions

- This product can use the SNMP function to get the state of the Signal Tower, as well as control the Signal Tower.
- SNMP versions v1, v2c, and v3 are supported.
- For information on OID for getting and controlling, refer to "10. MIB List" (☞ page 314).
- For the procedure on using SNMP Commands, refer to "8.3.1. Checking and Controlling the Status of This Product with Commands" (☞ page 155).

#### ● Communication Protocols

Protocol	Port Number
UDP	161

#### ● Commands You Can Execute

SNMP Command
SNMP GET
SNMP SET

## ● OID List

OID	Object ID	Description
1.3.6.1.2.1.1.3	sysUptime	Time that has elapsed since the SNMP management system was restarted (in hundredths of a second)
1.3.6.1.2.1.1.4	sysContact	Main unit settings - Basic Settings Contact Information
1.3.6.1.2.1.1.5	sysName	Main unit settings - Network Settings Host Name Information
1.3.6.1.2.1.1.6	sysLocation	Main unit settings - Basic Settings Installation Location Information
1.3.6.1.4.1.20440.4.1.1.1	identSwInitVersion	Operating System Version Information
1.3.6.1.4.1.20440.4.1.1.2	identSwAgentVersion	Application Version Information
1.3.6.1.4.1.20440.4.1.1.3	identHwVersion	Hardware Version Information
1.3.6.1.4.1.20440.4.1.4.1.1	pingServerNumEntries	Number of Ping Monitoring
1.3.6.1.4.1.20440.4.1.4.1.2.1.1	pingServerTableIndex	Setting Number for Ping Monitoring
1.3.6.1.4.1.20440.4.1.4.1.2.1.2	pingServerName	Unit name for Ping Monitoring
1.3.6.1.4.1.20440.4.1.4.1.2.1.3	pingServerAlertValue	Ping Monitoring Status
1.3.6.1.4.1.20440.4.1.4.1.2.1.4	pingServerIpAddress	IP Address for Ping Monitoring
1.3.6.1.4.1.20440.4.1.4.4.1	diEntry1	State of Digital Input 1
1.3.6.1.4.1.20440.4.1.4.4.2	diEntry2	State of Digital Input 2
1.3.6.1.4.1.20440.4.1.4.4.3	diEntry3	State of Digital Input 3
1.3.6.1.4.1.20440.4.1.4.4.4	diEntry4	State of Digital Input 4
1.3.6.1.4.1.20440.4.1.4.5.1	doEntry1	State of Digital Output 1
1.3.6.1.4.1.20440.4.1.4.5.2	doEntry2	State of Digital Output 2
1.3.6.1.4.1.20440.4.1.5.1.1	controlLightNumEntries	Number of Signal Tower to Control
1.3.6.1.4.1.20440.4.1.5.1.2.1.1	controlLightDeviceColor	Values of Signal Tower Color Information
1.3.6.1.4.1.20440.4.1.5.1.2.1.2	controlLightControlState	State of the Signal Tower to Control
1.3.6.1.4.1.20440.4.1.5.1.2.1.3	controlLightControlTimer	Number of Seconds Until Control State is Reflected
1.3.6.1.4.1.20440.4.1.5.1.2.1.4	controlLightCurrentState	Current State of the Signal Tower
1.3.6.1.4.1.20440.4.1.5.1.3	controlLightSnmpClear	Clear Control Status
1.3.6.1.4.1.20440.4.1.5.2.1	controlSoundChannel	Control and Current State of Audio Channel
1.3.6.1.4.1.20440.4.1.5.2.2	controlSoundLight	Control State of the Signal Tower with a 12-digit Number
1.3.6.1.4.1.20440.4.1.5.3.1	controlMultiColorUnit	Control State of the Multi-color unit with a 2-digit Number

### 5.3.15. Ping Monitoring Function

- Using ping communication, you can monitor equipment on the network to detect error and recovery states.
- You can monitor up to 24 nodes.
- Ping monitoring starts after ping monitoring setup is complete.

**! CAUTION**

⚠ Detecting the recovery state occurs when recovering from a monitoring error state.

⚠ When monitoring error states, performing a clear operation restores monitoring to a normal state, but the recovered state is not detected.

- The following example describes timing details of error states and when they are detected.

**Example 1** When number of transmissions is 2, and number of items to send is 3

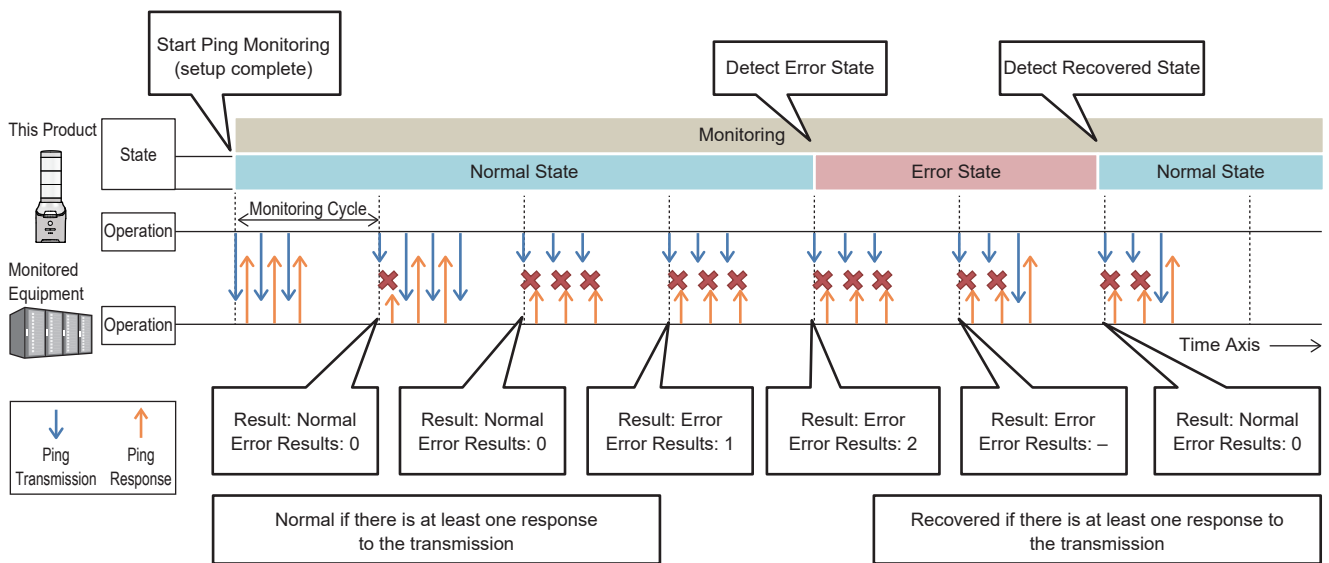

**Example 2** If clear operation is performed while monitoring for error states (set the number of transmissions to 2, and number of items to send to 3)

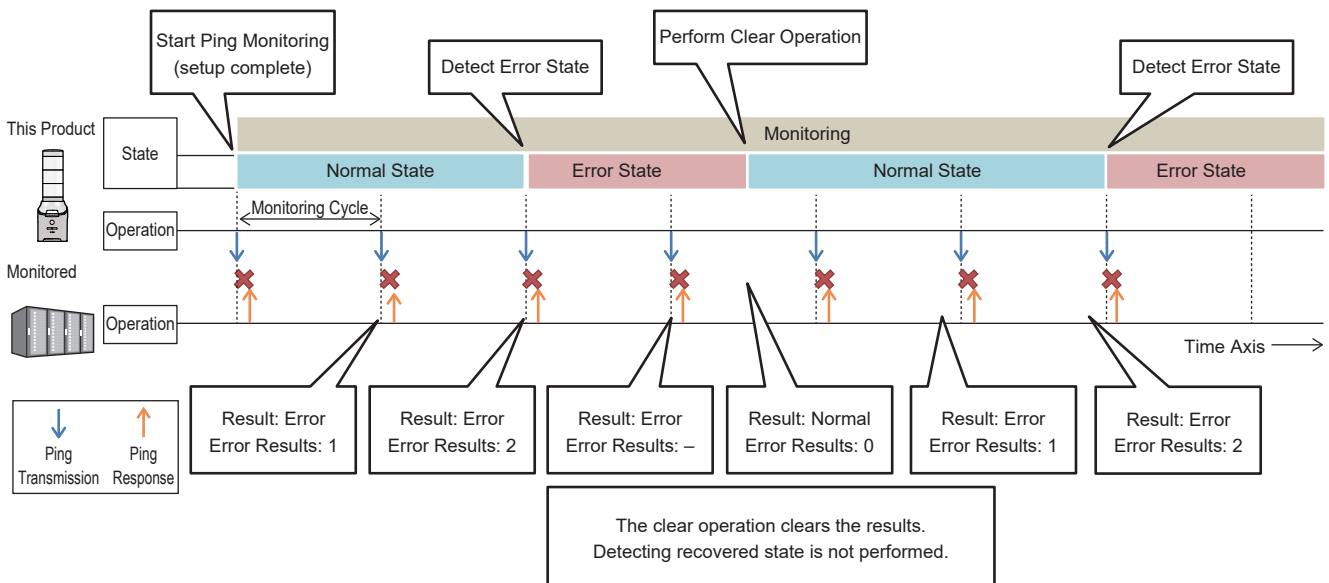

### 5.3.16. SNMP TRAP Reception Function

- You can receive TRAP that contain the specified IP address of equipment or the specified OID.
- SNMP versions V1, V2c, and V3 are supported.
- You can have a maximum 16 group settings, and in each group you can register 4 TRAP.
- For the procedure on using SNMP Commands, refer to "8.4.2. SNMP TRAP Monitoring" (☞ page 189).

#### ● Communication Protocols

Protocol	Port Number
UDP	162

### CAUTION

- ❗ If the [GenericTrap type] of the TRAP received is 6 (enterprisespecific), at the end of the received TRAP append "0. (specific-trap value)".
- ⚠ The number of variable-bindings that can be identified is limited to 64 per TRAP. When a TRAP is received with more than 64 variable-bindings, the 65th and subsequent variable-bindings will not be identified.
- ⚠ The types of values that can be identified are integer, OCTET STRING (string), and OCTET STRING (Binary).

Value in OCTET STRING (string) is treated as a string.

**Example** When value is A, Judgment is "A"

Value in OCTET STRING (Binary) is treated as binary data.

**Example** When value is A, Judgment is 0000 1010

### 5.3.17. SNMP Device Monitoring Function

- Using SNMP Commands, you can monitor SNMP-enabled equipment on the network and notify changes in state.
- You can set up match detection if the monitored data exceeds or falls below a threshold value, or to detect changes in monitored data.
- There are 20 types of match detection and 5 types of change patterns that can be detected.

#### ● Communication Protocols

Protocol	Port Number
UDP	161

#### ● Description of Detection

##### • Match Detection

- When you get the state of SNMP-enabled equipment and the state matches the set condition, the operation for when the condition matches is performed.
- When the state no longer matches the set condition, the release condition operation is performed.

**⚠ CAUTION**

- ⚠ The release condition operation is performed when the condition match is released after condition match status.
- ⚠ Even if a clear operation is performed while in a match status, the monitoring status will not be recovered. The match status will continue.
- ⚠ If you need to return the match status to the monitoring status, reconfigure the SNMP Device Monitoring Settings.
- ⚠ If the [Operation during communication timeout] is set to [Enabled], and a timeout is identified, the release condition operation is performed.
- ⚠ If re-evaluation of match is specified as the release condition operation, the status of the specified setting becomes monitoring status.
- ⚠ The types of values that can be identified are [integer], [OCTET STRING (string)], and [OCTET STRING (Binary)].

Value in OCTET STRING (string) is treated as a string.

**Example** When value is A, Judgment is "A"

Value in OCTET STRING (Binary) is treated as binary data.

**Example** When value is A, Judgment is 0000 1010

- The following example describes timing details when condition matches and release condition are detected.

#### Example 1 Match and release condition operations when match condition is A

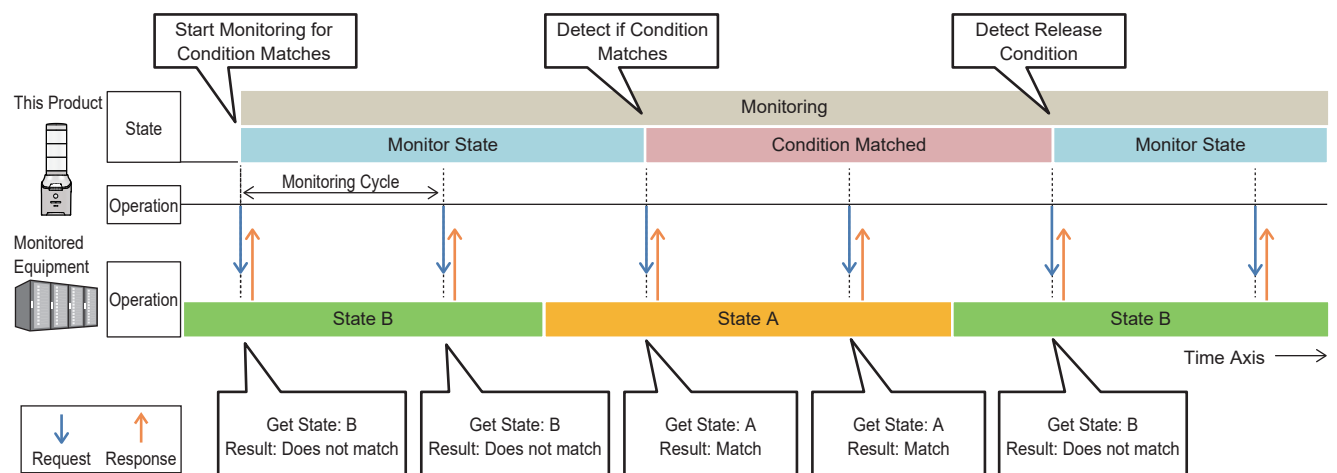

**Example 2 Clear operation when match condition is A**

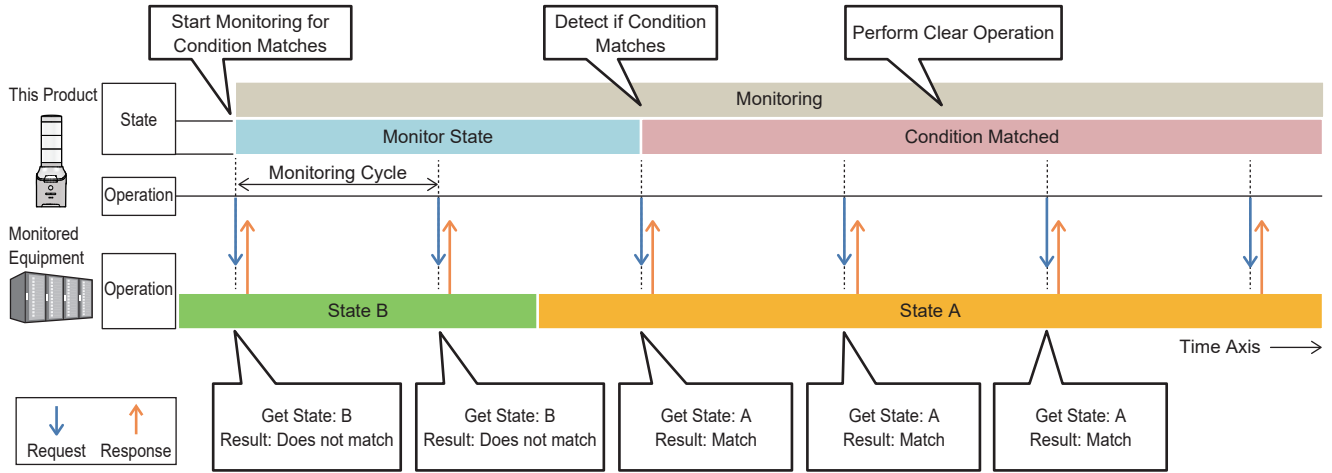

**Example 3 When match condition is A, operation during communication timeout (Number of retries set to 2) is enabled**

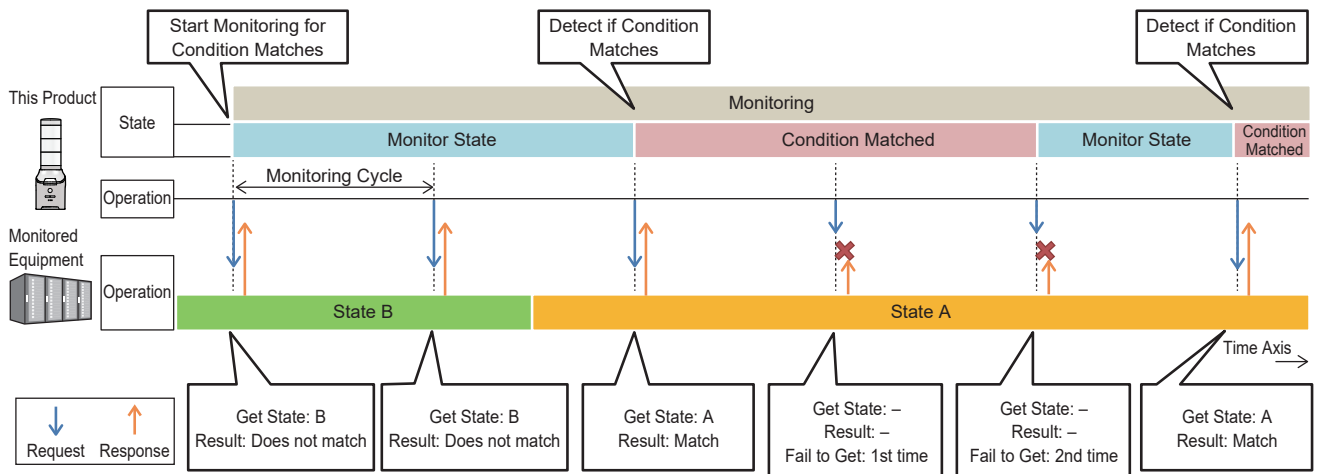

**Example 4 When match condition is A and monitor setting 2 is specified for re-evaluation of match of monitor setting 1**

In this example, the flow of communication with the monitored equipment has been omitted because it is the same as previous examples.

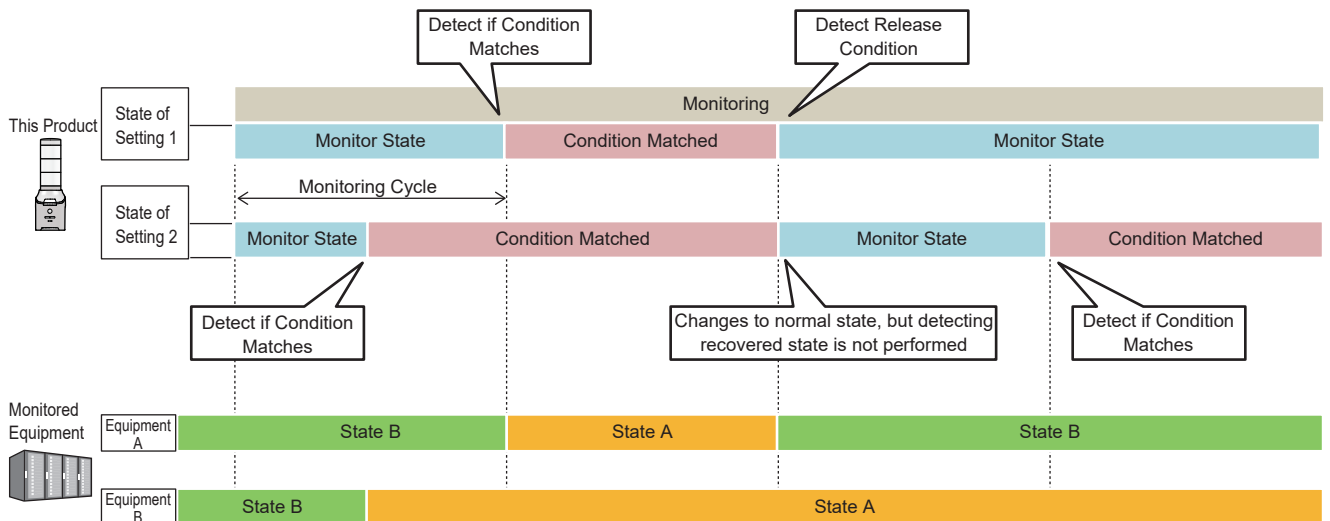

• **Detect Change**

- Gets the state of SNMP enabled equipment, and when there is a state change, performs the operation for when a change is detected.

**⚠ CAUTION**

⚠ Changes in state that occur during a communication timeout are not detected.

⚠ Integer is the only type of value that can be identified.

- The following example describes timing details when condition matches and release condition are detected.

**Example 1 Normal Detect Change Operation**

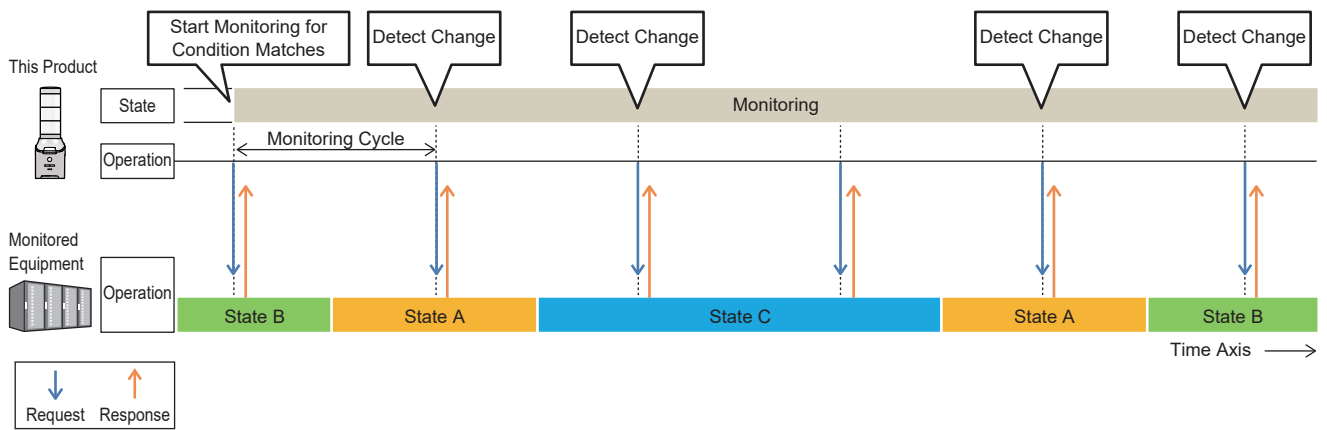

**Example 2 Detect Change Operation When Timeout Occurs**

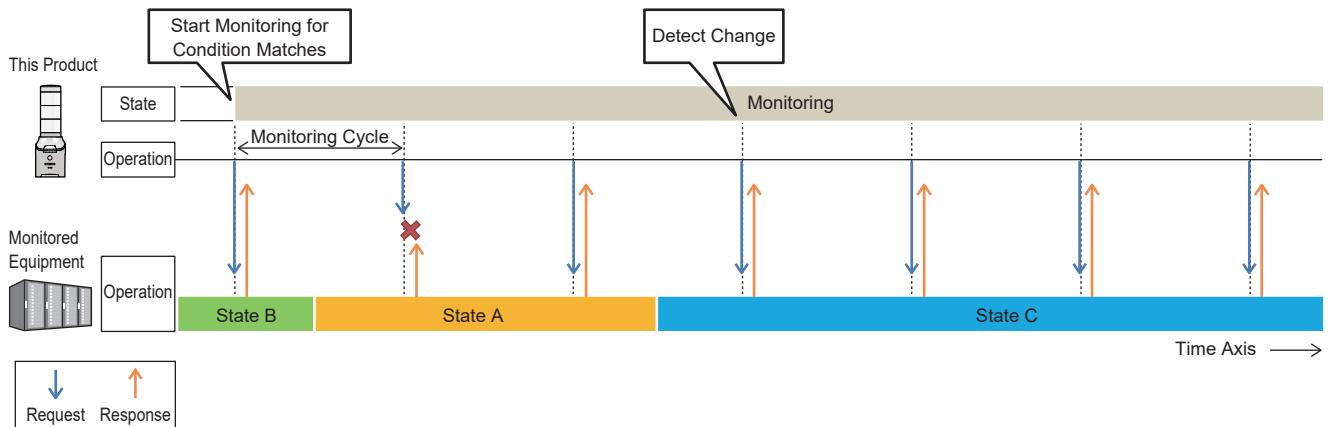





### 5.3.18. Detect Change in State of Contact Input

- By monitoring the state of external contact inputs, this function detects any changes in the state.
- Digital signals to four external contact inputs are used to monitor the state of digital input.
- Digital input can refer to digital logic settings (Contact A [normally open] or Contact B [normally closed]).

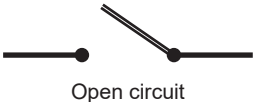
#### ● Definition of ON and OFF for Digital Input

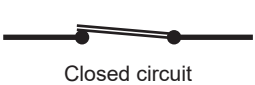
Operation Status		ON	OFF	Description
Digital Boolean value		1 01H	0 00H	
Contact Status	Contact A (make contact) (normally open)	 Closed circuit	 Open circuit	OFF opens the contact. ON closes the contact and allows power to flow.
	Contact B (break contact) (normally closed)	 Open circuit	 Closed circuit	OFF closes the contact and allows power to flow. ON opens the contact.

- This product detects the state under the following conditions.

#### ● Conditions When the Product can Detect

Status	Description
ON Status Change	Detect state when digital input turns ON ( ① ).
OFF Status Change	Detect state when digital input turns OFF ( ② ).
Status change	Detect a change in state from ON to OFF, or OFF to ON.

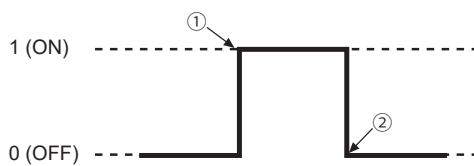

### CAUTION

- ❗ The monitoring cycle for the digital input is 110 ms. Maintain the input signal for 110 ms or longer.
- ⚠ If the state of digital input is continually changing, there may be delays in operations and detecting changes may be missed.

### 5.3.19. Contact Input Match Detection

- You can detect changes in the contact input state based on set conditions.
- Determining the condition is executed in order, Condition 1 → Condition 2 → Condition 3 → Condition 4.
- If a condition matches, the operation when condition matches is performed.
- You can detect when there is continuous input for a specified period of time (detect continuous).
- The maximum length of time for detecting continuous input is 3600 seconds.
- You can use the Clear button to reset the measured time, or after conditions match run the detect operation again.

 **CAUTION**

 The condition can be set for ON status change only.

- The following example describes operation details.

**Example 1** Operation condition is set as Continuous On Time: 10 seconds, clear operation condition disabled, and re-evaluation is enabled

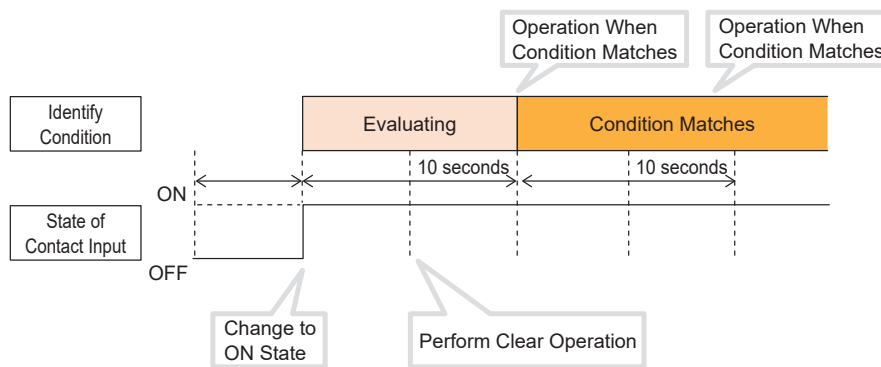

**Example 2** Operation condition is set as Continuous ON Time: 10 seconds, clear operation condition enabled, and re-evaluation disabled

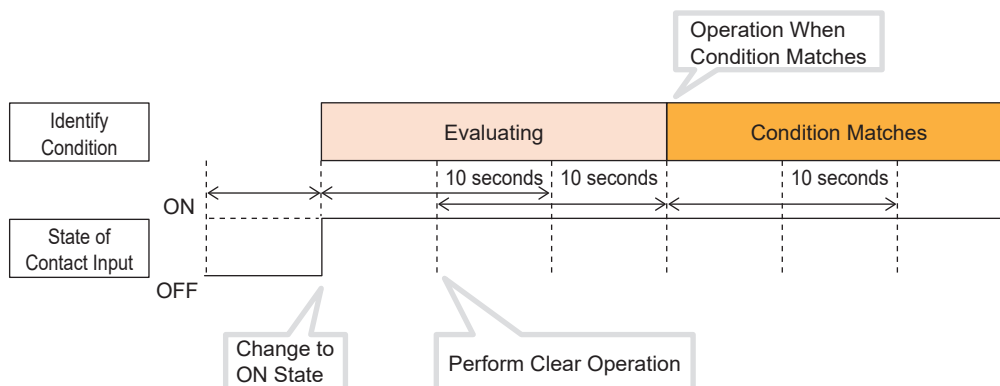

### 5.3.20. Detect Email Function NHV Series (M model)

- Connect to the mail server and periodically check for new email.
- Following registered filter rules, notify when receiving email by sender, subject, and body text.
- Register up to 20 patterns of filter rules for detecting email.
- Set up each filter rule with up to five conditions.
- You can set any matching conditions "Meets all of following", "Meets one of the following", and "None" when registering multiple rules.
- Apply the filter "Matches with", "Beginning with", "Include", "Be free of" to the sender, subject, and body text.

**CAUTION**

- The maximum size of email is 5MB (both POP / IMAP), and emails that exceed the maximum size may not be detected.
- Attachments are ignored (text information in attachments is not subject to filter detection)
- When "Delete the mail in the server after receiving" is enabled in POP authentication, emails older than the latest 200 will be deleted without filter detection.
- If you receive a large number of emails during the first reception or during the period from the previous email check to this time, it may take some time to receive the emails.

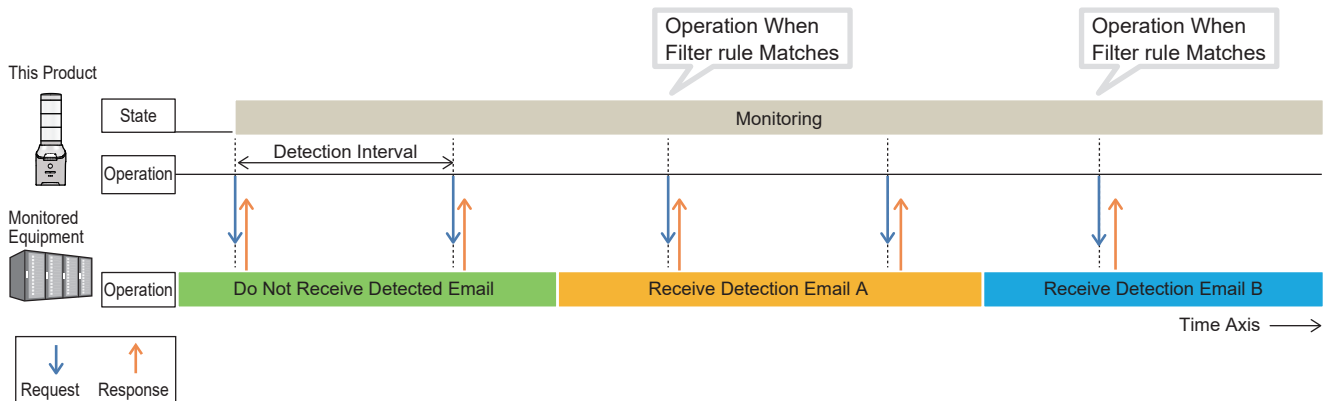

- The following example describes registering filter rules.

**Example 1** If you want this product to detect email receiving from specified email address (patlite@example.com)

Matching conditions	Meets all of following / Meets one of the following	
rule 1	Filtering target	Sender
	Filtering content	patlite@example.com
	Condition	Matches with"

**Example 1** If you want this product to detect email receiving from specified email address (patlite@example.com) and including the word "important" in subject

Matching conditions	Meets all of following	
rule 1	Filtering target	Sender
	Filtering content	patlite@example.com
	Condition	Matches with
rule 2	Filtering target	Subject
	Filtering content	"important"
	Condition	Include

**Example 1** If you want this product to detect all received email

Matching conditions	None
rule 1 to 5	-

### 5.3.21. Clear Operation Function

By executing a clear operation, you can clear operations of various functions on the product.

#### ● Details of Clear Operation

The clear operation varies depending on how it is executed.

Function	Clear Operation Execution Method		
	RSH/SSH Commands SNMP Command	PNS Command HTTP Command Signal Tower Control Screen	Clear Button
Signal Tower	Result in normal operation state		Result in the state as set in the Clear Button Setup screen
Buzzer	Stop		
Digital Output	Turn OFF		
Busy Output	Turn OFF		Play Audio: ON Stop Audio: OFF
Audio Playback	Stop		Result in the state as set in the Clear Button Setup screen
Self-test Operation	Result in normal operation state		
Send Email	Transmission Possible	Transmission Not Possible	Transmission Possible
TRAP Transmission	Transmission Possible	Transmission Not Possible	Transmission Possible
Ping Monitoring	Return to Monitoring Status		
SNMP Device Monitoring	Continue Current State		
Digital Input Condition	Continuous ON Time is reset		Depends on the operation setting when the Clear button is pressed

 **CAUTION**

 The following action plays audio playback even after the clear operation.

- When synthesizing the voice of the text entered on the WEB Setup Screen
- When text received by command or cloud is being synthesized by voice

**Point**

- The Signal Tower state can be set off individually for each color only by pressing the clear button.

#### ● Operation when Clear button is pressed

By pressing the Clear button, you can execute operations such as those below.

- For [Clear stages], you can specify clear all or two-stage clear.

Clear All	Simultaneously clear the Signal Tower, digital output, and buzzer/audio playback.
Depress twice to Clear all	The first press of the button stops the buzzer/audio playback and contact output, and the second press clears the Signal Tower.

- You can send email, TRAP, HTTP Commands, and MQTT.
- You can stop audio playback or skip tracks. NHV Series

Stop	Stops playing audio. Also clears audio stored in channel memory.
Skip	Stops audio playback and starts playback of audio registered in channel memory. Stops when memory is empty.

### ● Detailed Timing Example

#### Example 1 When playback mode is [Playback from latest input mode]

Pressing the Clear button interrupts playback of the channel and turns OFF Busy output.

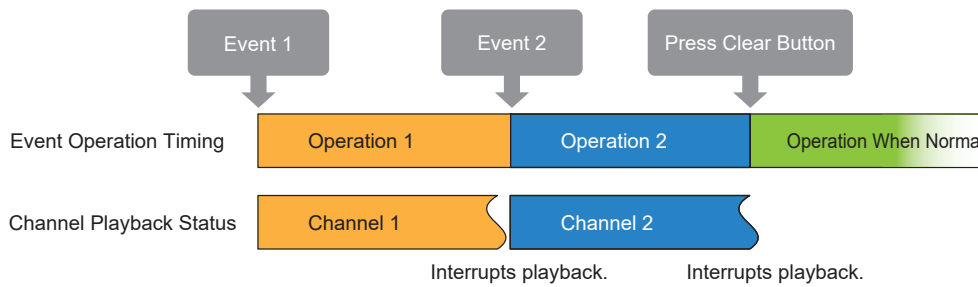

#### Example 2 When playback mode is [Memory playback mode]

In Memory playback mode, [Channel Memory] is handled differently depending on the [Clear Operation] setting.

##### • Stop

Pressing the Clear button interrupts playback of the current channel and stops Busy output. Erases channels registered in channel memory.

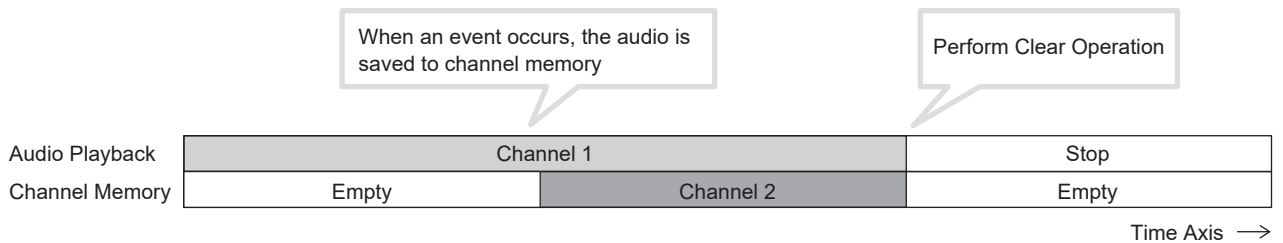

##### • Skip Track

Pressing the Clear button interrupts playback of the current channel and plays the channel registered in channel memory. Busy continues to output while the channel is still playing.

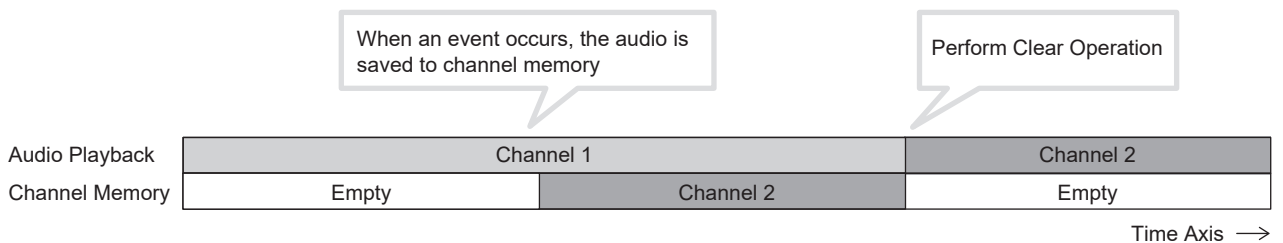

### 5.3.22. Self-test Function

- Execute the self-test operation function to check the Signal Tower operation.
- When self-test is executed, the following operations are performed.

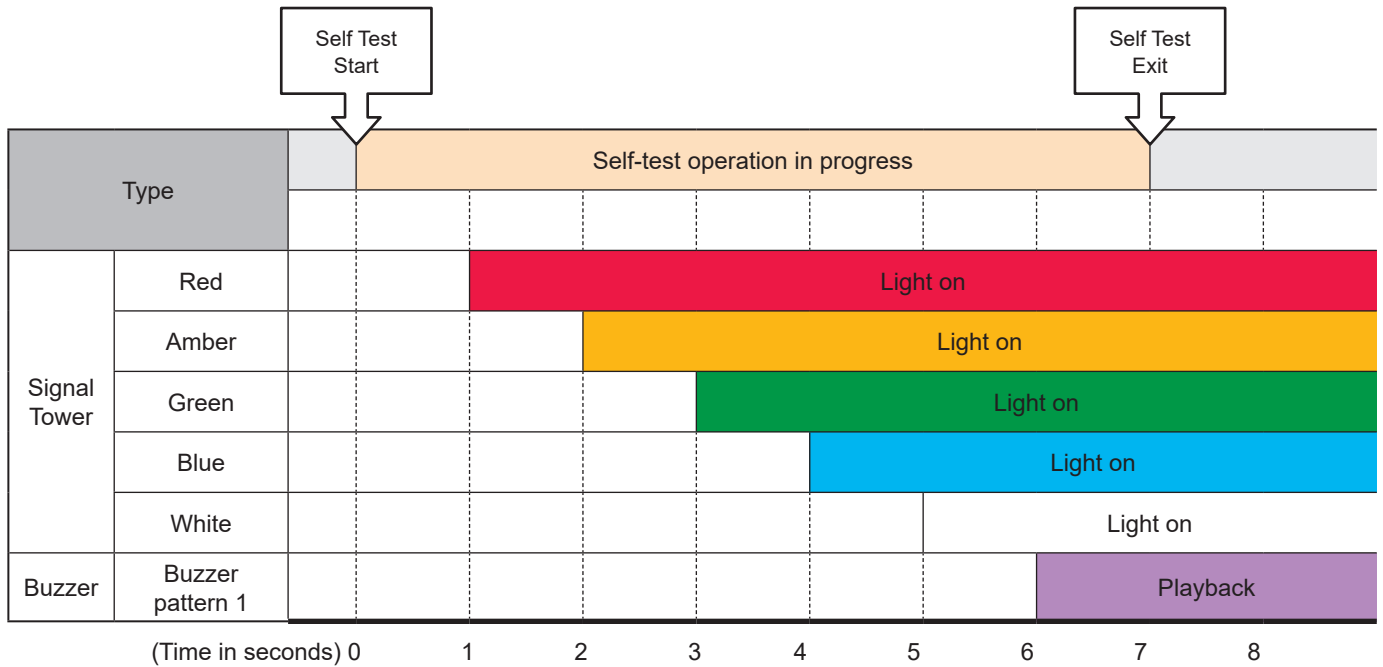

**⚠ CAUTION**

- ❗ Self-test operation automatically activates the Signal Tower and audio playback. Thoroughly check the surrounding area before executing.
- ⚠ When volume is 0 or mute, the audio does not play.
- ⚠ You cannot stop the self-test operation midway.
- ⚠ While the self-test operation is executing, the clear operation is not accepted.
- ⚠ The monitoring function continues running while self-test is executed. Be careful when running self-test.
- ⚠ During and after execution of self-test, PNS and PHN Commands return an error response. RSH/SSH Commands return a Busy response.
- ⚠ When self-test operation is executed, channel memory is cleared.

**Point**

- After self-test is completed, you can return to normal operation state by pressing the clear button.
- When clear button function is disabled, you can return to normal operation state by pressing the test button.

### 5.3.23. Cloud Function

You can use the Cloud function to link to a compatible cloud platform and control the main unit, get the status of the main unit, and send the status of the main unit.

#### ● Supported Cloud Platforms and Features

Supported Cloud Platforms		Microsoft Azure
		Amazon AWS
Supported Connection Methods	Microsoft Azure	Azure IoT Central/DPS (IoT Plug and Play)
		Azure IoT Hub (IoT Plug and Play)
	Amazon AWS	AWS IoT Core
Supported Platform Functions	Microsoft Azure	Device Twin
		Direct Method
		Device-to-cloud Message
		Cloud-to-device Message
	Amazon AWS	Device Shadow
		MQTT Client
Function	Main Unit Control	Signal Tower and buzzer control
		Audio playback
		Digital output control
		Voice synthesizer
	Get status of Main Unit	State of the Signal Tower and buzzer
		Audio playback function
		Digital output state
	Send status of Main Unit	When there is a change in state for the Signal Tower and buzzer
		When there is a change in state for audio playback
		When Clear button is pressed or clear operation is executed
		When there is a change in state for external input
		When there is a change in state for digital output

Function	Send status of Main Unit	When ping monitoring error occurs
		When ping monitoring recovery performs
		When ping group monitoring error occurs
		When ping group monitoring recovery performs
		When TRAP is received
		When condition of SNMP device monitoring is matched
		When condition of SNMP device monitoring is released
		When condition of SNMP device monitoring is changed
		When condition of contact input is matched
		When Test button is pressed
		When e-mail is received



## 6. Mounting, Installation, Wiring, and Powering on



### WARNING

- ❗ Before performing any work, disconnect the product's power supply.
- ❗ In case the product falls over or falls down, install in a location where it will not hit any people or other objects.



### CAUTION

- ⊘ This product is for indoors only. Do not use outdoors.
- ⊘ Do not apply excessive force to the units or this product. Failure to follow this instruction could result in equipment damage.
- ⊘ Do not install this product with its adhesive sheet on material that includes a large amount of plasticizer.
- ⊘ Avoid using this product in the following locations. Failure to follow this instruction could result in malfunction or equipment damage.
  - Places exposed to direct sunlight
  - Places near fire or environments with high temperatures and humidity
  - Environments where temperature changes are severe, and where there is condensation
  - Environments with poor breathability and ventilation
  - Places where external vibrations are directly transmitted to this product
  - Environments where corrosive gas is present
  - Locations exposed to salty sea air
  - Environments where there is dust or iron powder
  - Environments where chemicals and oil mist are present
  - Places subject to rain and water
  - Near equipment that generate strong electrical or strong magnetic fields
  - Locations where the product may fall and break
- ❗ The adhesive sheet used for this product may be difficult to remove depending on the environment in which it is used. Check the installation location for this product beforehand. Failure to follow this instruction could result in damage to the coating.
- ❗ Install this product in a stable and level location.

## 6.1. Attaching and Detaching Additional Units

Always follow the instructions below when attaching or detaching additional units (such as LED unit, transmitter) to and from this product.

### ⚠ CAUTION

- ⊘ Do not touch the connectors on the unit or this product, or parts inside the additional unit. Failure to follow this instruction could result in equipment damage.
- ⊘ Do not connect incompatible additional units. Failure to follow this instruction could result in decreased performance or equipment failure for the product or unit.
- ⊘ Limitations on mounting additional units to this product depend on the type of unit itself. Do not mount beyond this limit. Failure to follow this instruction could result in decreased performance and equipment damage.
  - Do not install multiple LED units of the same color.
  - The maximum number of colored lenses and clear lenses you can assemble is 5. The total for multi-color is one.
  - You cannot assemble LED units with a colored lens or clear lens and an LED unit that is multi-color at the same time.
  - The maximum number of transmitter units you can assemble is 1. However, this number does not include LED units.
- ⓘ Use the following method when attaching and detaching LED units. Failure to follow these instructions could result in equipment damage.
  - Attaching Units: Attach units to this product one at a time.
  - Detaching Units: Detach units from this product one at a time.

### 6.1.1. NHB Series, NHV Series

For NHB6 and NHV6

#### ■ Attach

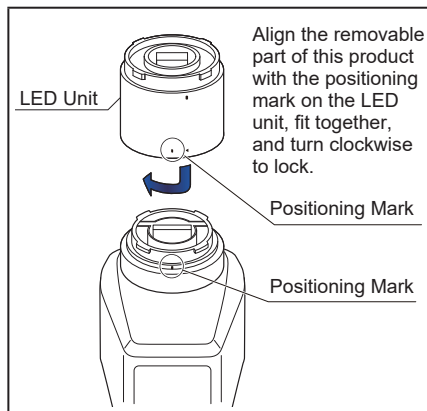

#### ■ Detach

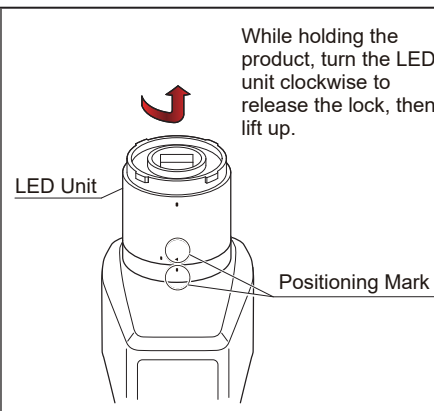

#### ■ Positioning Mark

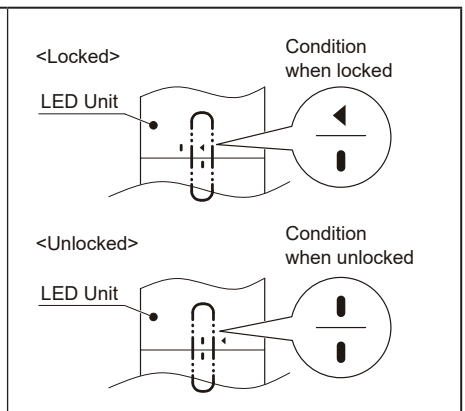

For NHB4 and NHV4

#### ■ Attach

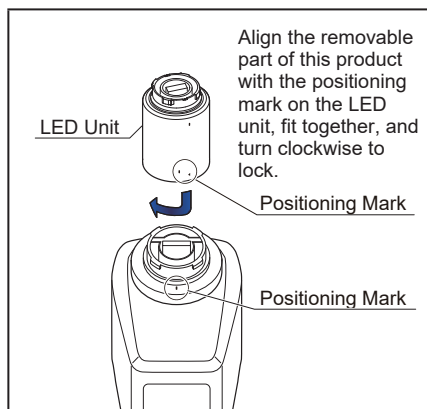

#### ■ Detach

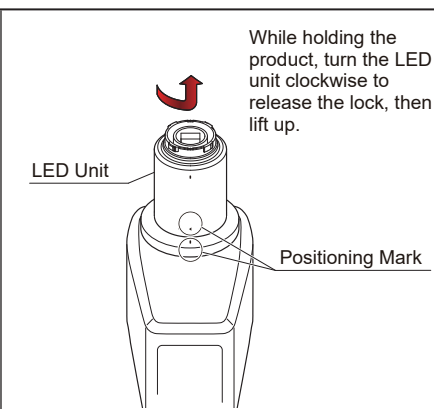

#### ■ Positioning Mark

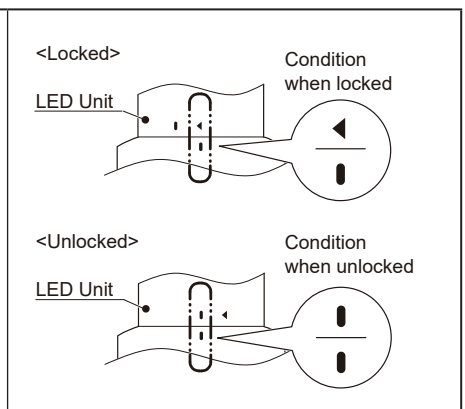

### 6.1.2. Procedure for Attaching/Detaching LED Units

- Attach or detach LED units in the prescribed order ① to ④.
- Attach or detach LED units one at a time.

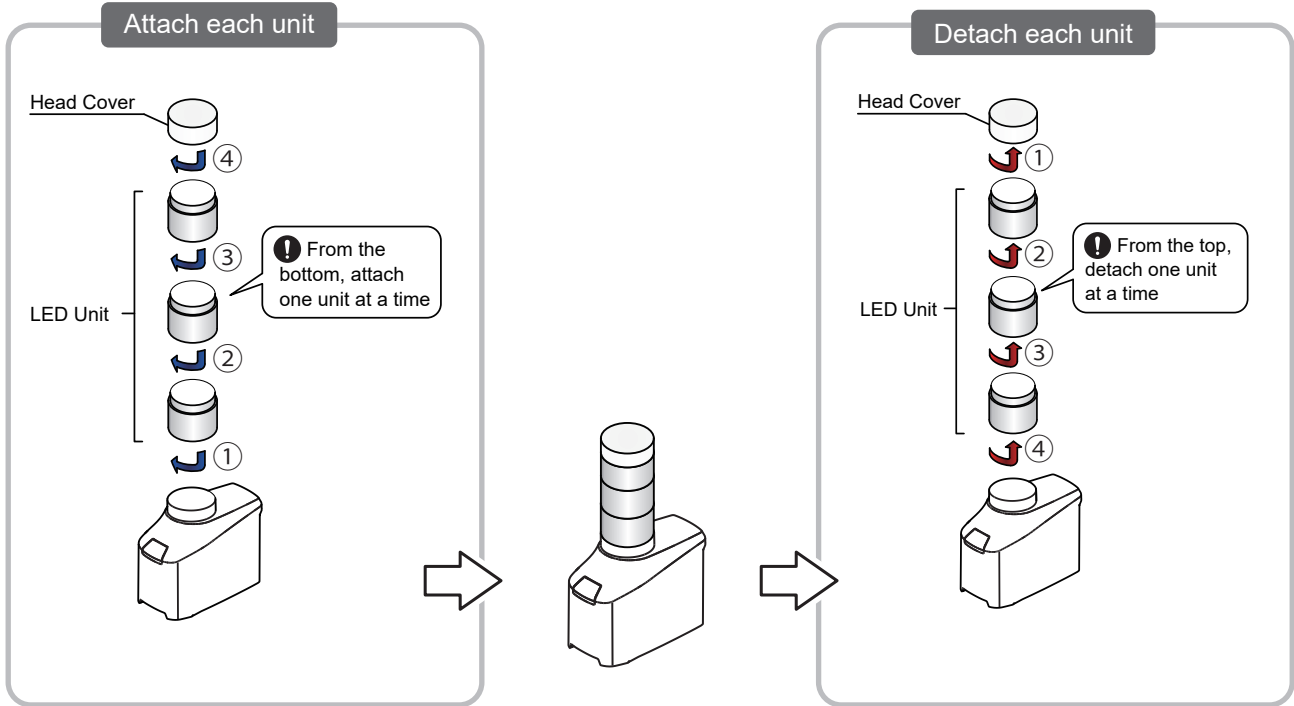

### 6.1.3. Procedure for Attaching/Detaching LED Units and Transmitter

- Attach or detach the transmitter and LED units in the prescribed order ① to ⑤.
- Attach or detach LED units one at a time.
- Attach the transmitter on the bottom tier. If you attach the transmitter on top of an LED unit, it is difficult to assess the status shown by the lamp on this product.

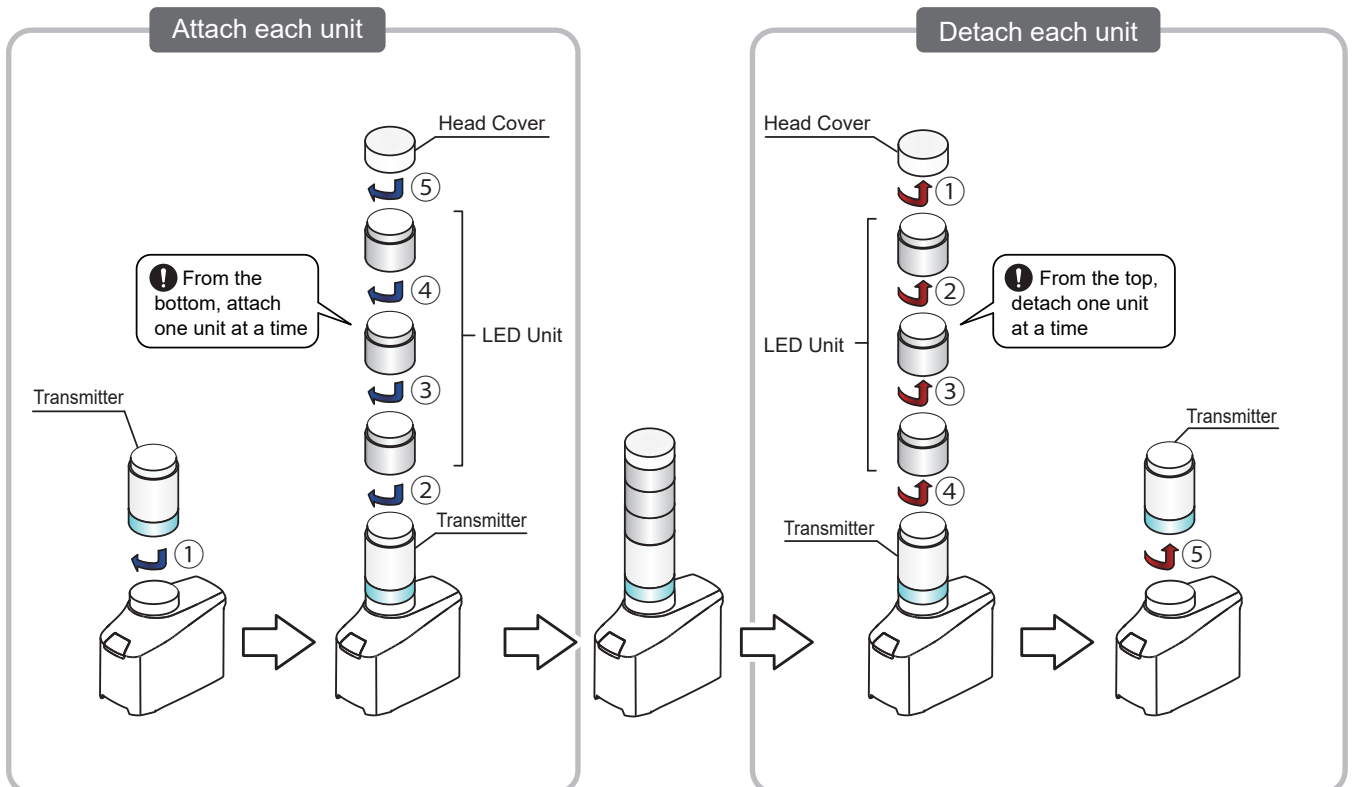

## CAUTION

-  If an additional unit does not attach properly to this product, confirm that the tab of the cylinder-shaped part at the top of the unit is fitted correctly into the groove. Depending on how additional units are detached, the tab may come out of the groove when detaching additional units from this product. If the product is attached again while the tab is still in this state, it may become damaged.

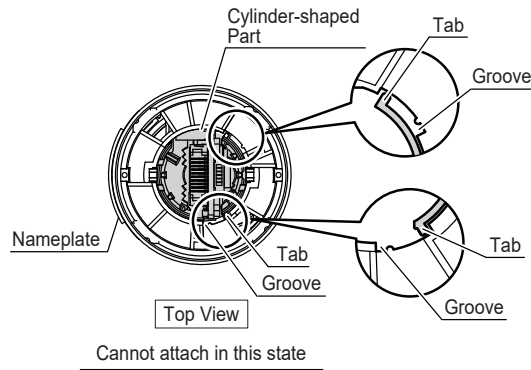

-  If a unit does not attach properly to this product, follow the steps below.
- In the center of the underside of the product, turn the cylinder-shaped part counter-clockwise.
  - Turn the cylinder-shaped part until it snaps into place, then attach it to this product.

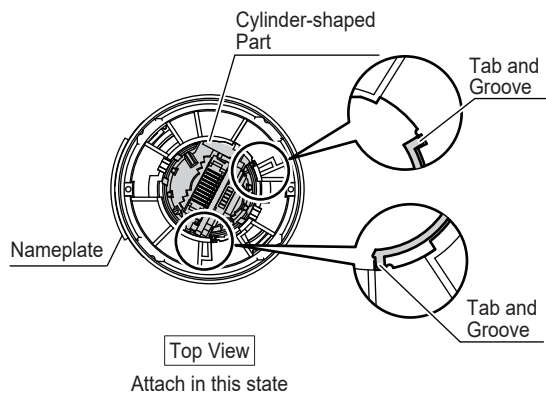

## 6.2. Product Installation and Mounting Method

This section describes how to install and mount this product. Adjust to fit your requirement and perform the work.

### CAUTION

- ❗ Before attaching the adhesive sheet to the product, wipe away any dust, water, oil and other unwanted material from the main unit and installation location.
- ❗ When removing the adhesive sheet, firmly hold the outer edge of the product near the bottom and peel away slowly.
- ❗ Use the recommended torque when attaching parts for installation.
- ❗ After installation, check again if there is a risk of the product falling.
- ❗ The following requirements are necessary for a proper mounting location.
  - Low vibration
  - Sufficient strength
  - Flat location

### 6.2.1. When Stationary

**1** Peel away the yellow non-stick paper from the adhesive sheet and attach it to the recess of the attachment location on the bottom of this product.

**2** After attaching it to the product, peel off the clear non-stick paper and affix to the mounting surface.

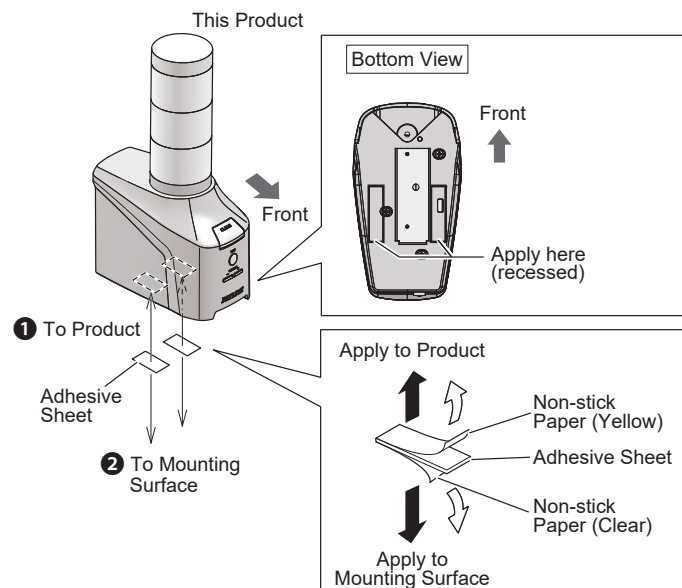

### 6.2.2. Mounting on a Tripod

#### 1 Attach the product to a tripod.

For information on mounting methods, refer to the instruction manual of the tripod.

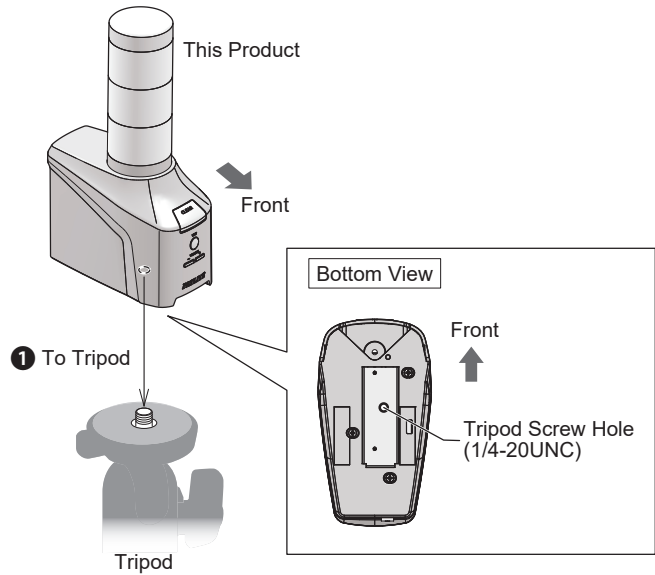

### CAUTION

- ❗ When using a tripod, its screw should be shorter than 5.5 mm. When the screw is 5.5 mm or longer, the product cannot be affixed firmly to the tripod, which could lead to product damage.
- ❗ Use a tripod with a load capacity of 6 kg or more.
- ⊘ When using a tripod with this product, do not move or transport while the tripod is attached. Failure to follow this instruction could result in equipment damage if the product falls over.

### 6.2.3. When Using Mounting Brackets (optional part)

- By using mounting brackets (optional part), you can install this product on a wall, VESA compliant device, or partition. Please provide your own screws for mounting.
- There are two types of mounting brackets: Wall Mounting Bracket (for mounting on a wall or VESA compliant device), and Partition Mounting Bracket (for mounting on partitions).
- For information on mounting methods, refer to the instruction manual of the corresponding mounting bracket.

## ! CAUTION

- ⊘ Mount only in the directions described in this manual. Failure to follow this instruction could result in the product falling or equipment damage.
- ⊘ When using this product, do not use the adhesive sheet included with the product you are mounting. Depending on the thickness of the adhesive sheet, you may not be able to tighten the screws firmly when mounting the bracket, or they may loosen over time.
- ! The following requirements are necessary for a proper mounting location.
  - Low vibration
  - Sufficient strength
  - Flat location
- ! Turn off the power before attaching this product to the mounting bracket. Failure to follow this instruction could result in fire or electric shock.
- ! Use the recommended torque when attaching parts for installation.
- ! After installation, check again if there is risk of the product falling. Additionally, periodically check for damage or loosening of the mounting parts.

### ● Mounting on a Wall

- To mount on a wall, use the Wall Mounting bracket. Provide your own screws for mounting to the wall.
- Using Wall Mounting brackets, you can mount this product on the wall in one of two different ways. The pitch of mounting holes is different depending on the mounting direction. When mounting, refer to the mounting dimensions shown below.
- Tighten to match the torque recommended for the material of the wall surface.

#### 1 Attach the mounting bracket to the wall.

- Select the mounting pattern that best suits your use.

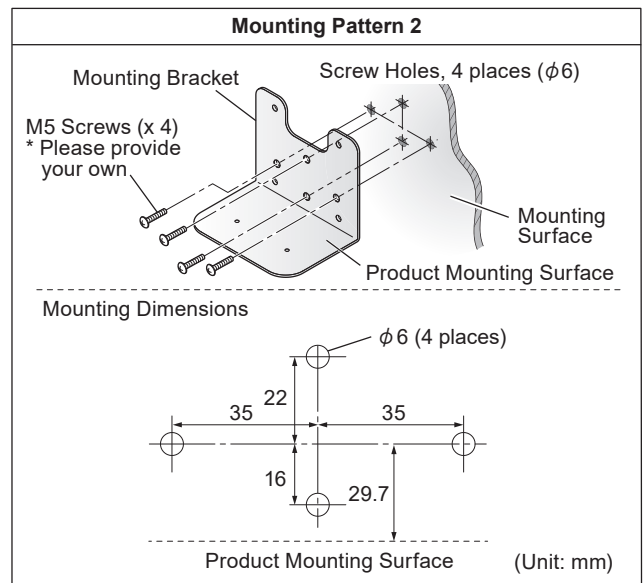
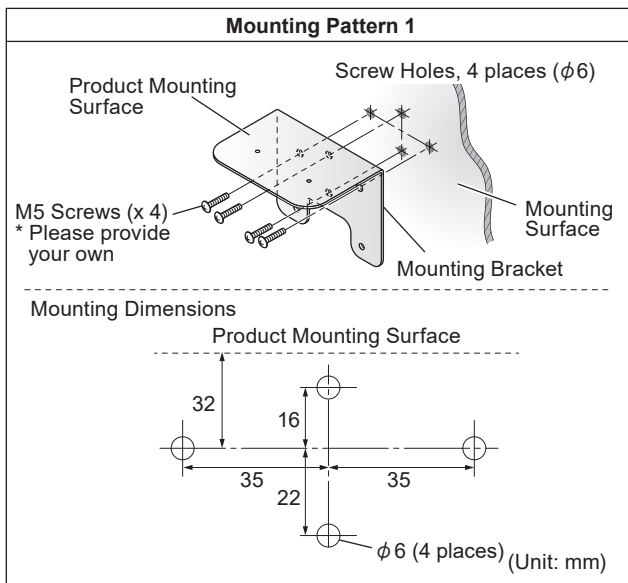

**2**

Attach the product to the mounting bracket.

Recommended Torque
0.6 N·m (approximate)

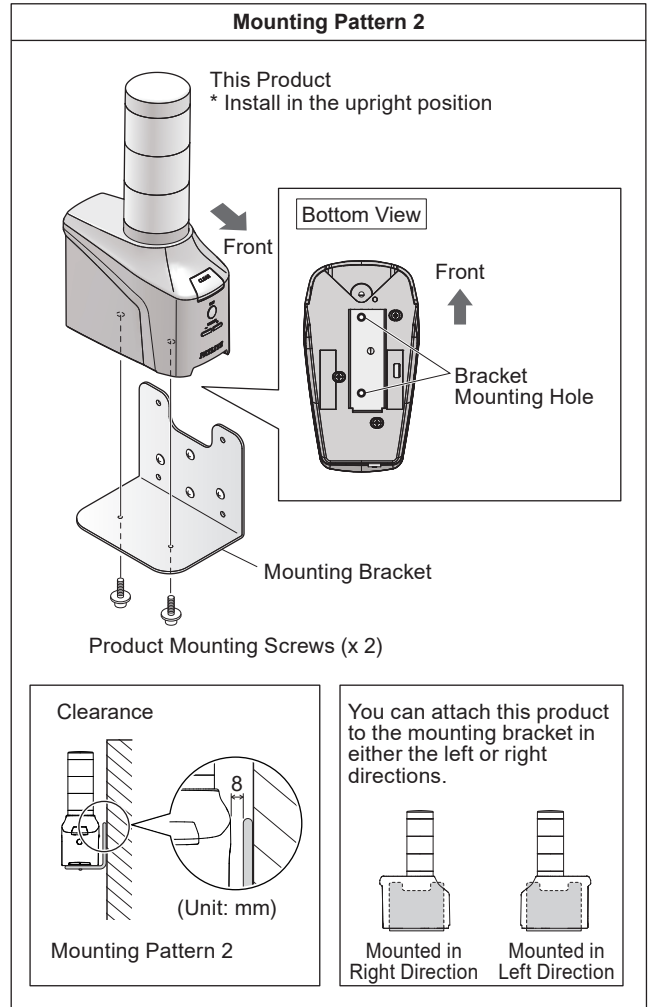
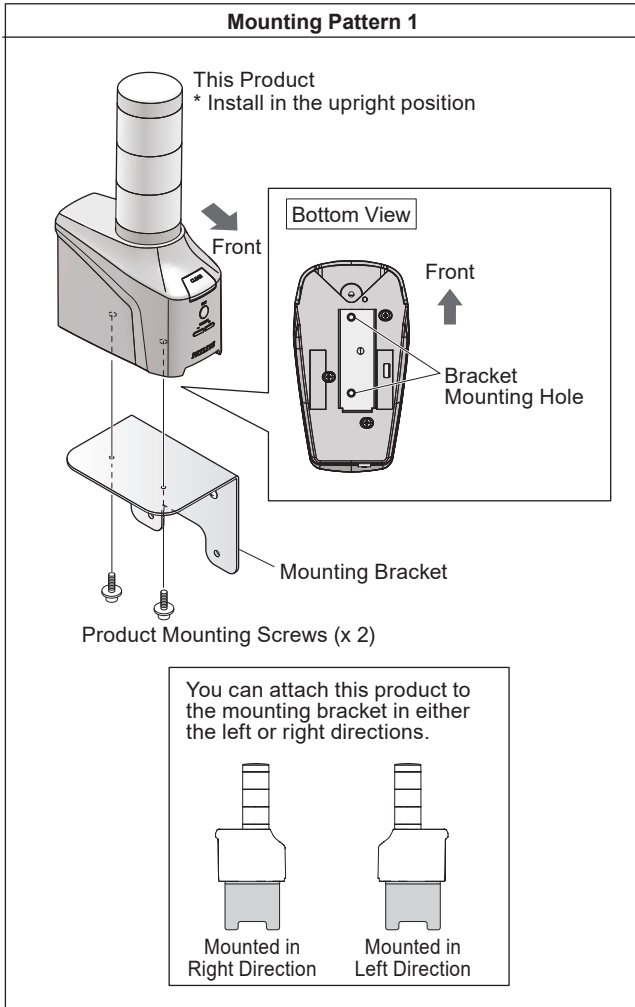



### ● Attaching to a VESA Compliant Device

- To mount on a VESA compliant device, use the Wall Mounting bracket. Provide your own screws for mounting to the VESA compliant device.
- For information on mounting methods, refer to the instruction manual of your equipment.
- Use VESA compliant equipment with a load capacity of 6 kg or more.
- For VESA compliant devices, use only Mounting Pattern 2.

**1** Attach mounting bracket to the VESA compliant device.

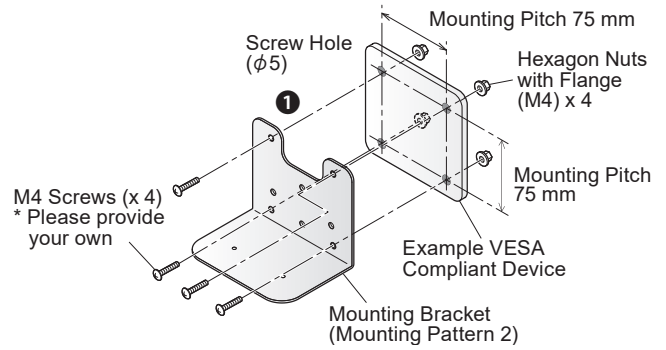

**2** Attach the product to the mounting bracket.

Recommended Torque
0.6 N·m (approximate)

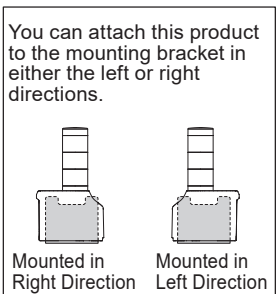
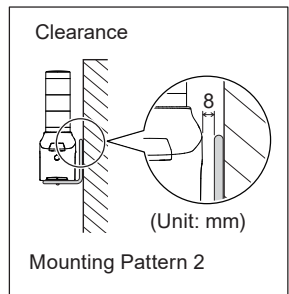
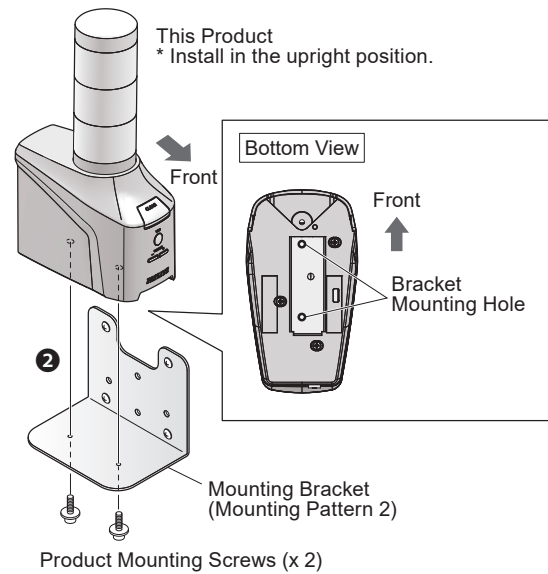

### ● When Mounting on a Partition

- To install on a partition, use the partition mounting bracket.
- By using a partition mounting bracket (optional part), you can install this product on the top part of a partition. (A partition is a barrier that separates space and line of sight)

**1** Secure this product and the mounting bracket with the product mounting screws.

Recommended Torque
0.6 N · m (approximate)

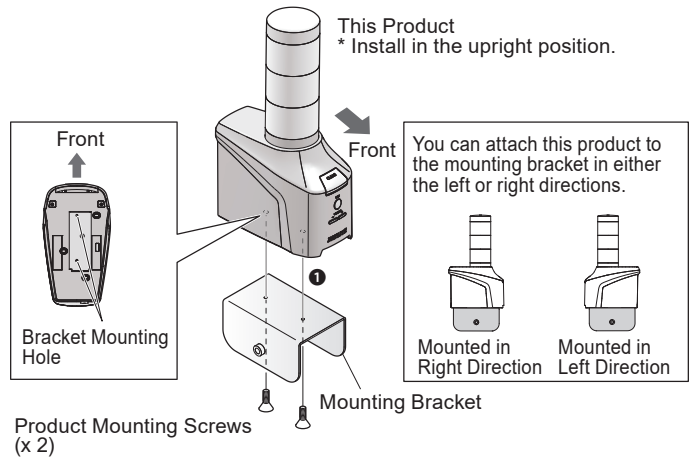

**2** After passing the tightening screw through the mounting bracket, attach the metal fitting.

**3** Secure to the partition by turning the tightening screw clockwise.

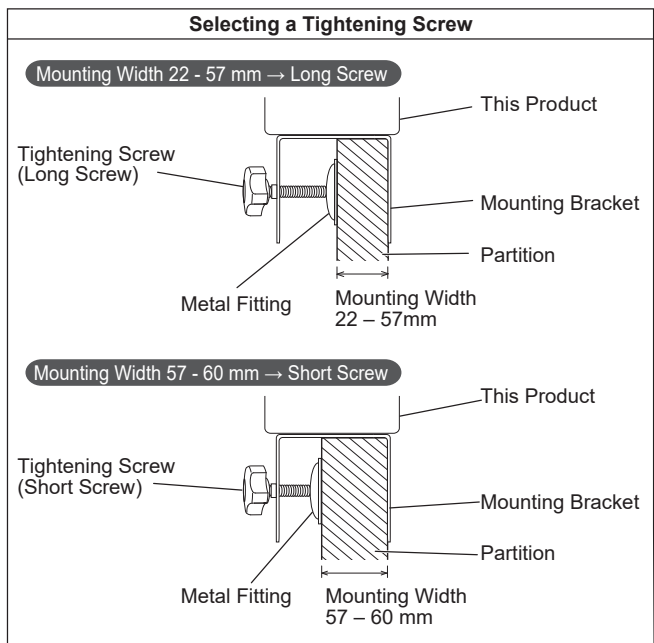
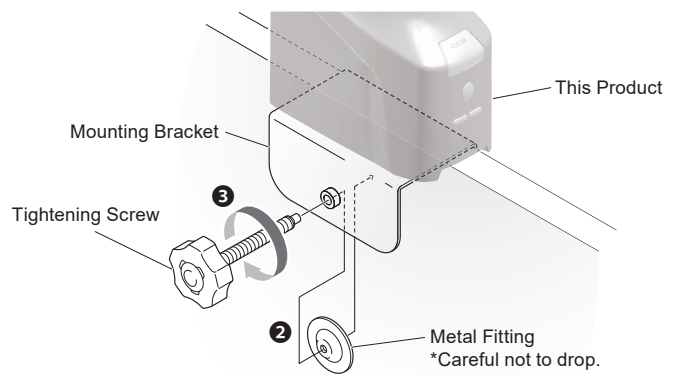

### 6.3. Line Out Connection Method NHV Series

- This product can output audio externally.
- To output audio, connect equipment with a line input.
- Mini-plug cable is not included with this product. Please provide your own.

## ⚠ CAUTION

- ⊘ Do not use equipment that does not conform to the Line Out terminal (600 Ω 0 dBV). Connecting headphones or passive speakers (speakers with no built-in amplifier, 32 Ω or less) could result in product failure.
- ⊘ Do not connect multi-pole mini plugs other than mono or stereo plugs. Failure to follow this instruction could result in product damage.

**1** Connect the mini plug cable to the Line Out terminal on the back of the product.

- Confirm the other end of the cable is connected to line input on the target device.
- You can use a mono mini-plug cable.  
If you use a stereo mini-plug cable, only the left channel signal is output.

#### ■ Line Out Signal Specifications

Signal level	0 dBv (600 Ω connection, sine wave playback)
Audio Channel Type	1 ch (mono)
Connector Shape	Mini Jack

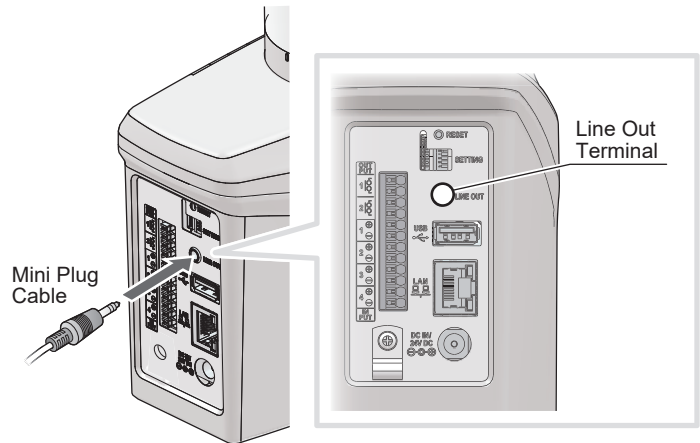

## 6.4. Digital Input/Output Wiring Method NHV Series (D model)

- When monitoring signal inputs from equipment with contact outputs, use digital inputs. To control equipment with contact inputs, use digital outputs.
- Follow the instructions below to wire the input terminal block and output terminal block.

### ⚠ CAUTION

- ❗ Be sure the wiring is done properly. Any mistake in wiring may result in damage or fire.
- ❗ Wire so that the core of the lead wire is not exposed. Failure to follow this instruction could cause a short circuit leading to fire or equipment damage.
- ❗ After completing the wiring, check for any loose wires. Failure to follow this instruction could result in malfunction or electric shock.
- ⊘ Current and voltage of equipment connected to the output terminal block should not exceed the following rated values.  
Port 1 – 2: 30 VDC, 3 A inrush current 5 A or less / minimum current 5 VDC, 1 mA (reference value)
- ⊘ Equipment connected to the input terminal block should meet the following ratings.  
Port 1 – 4 (NPN transistor): Output ON current 6 mA or less / when port is OFF terminal voltage of 24 V, leakage current 0.1 mA or less

### 6.4.1. Wiring procedures

- 1** Use a flat-blade screwdriver to push in the lever on the terminal block.
  - We recommend a flat-blade screwdriver with a blade-edge width of 2 mm or less and thickness of 0.5 mm or less (or equivalent).
- 2** Insert the lead wire into the insertion slot. (Keep the lever pressed down)
- 3** With the lead wire inserted, release the lever to lock.
  - Check if the lead wire is locked into place.
  - Do not push the lever harder than necessary with the screwdriver. Failure to follow this instruction could result in equipment damage.
  - When removing the lead wire, do not simply pull the wire to remove it. (Make sure you work the lever to release the lock)

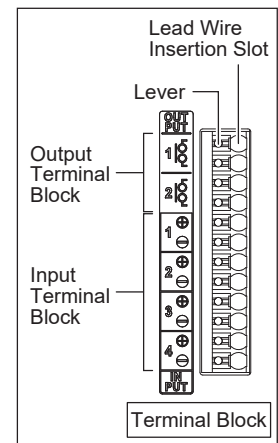
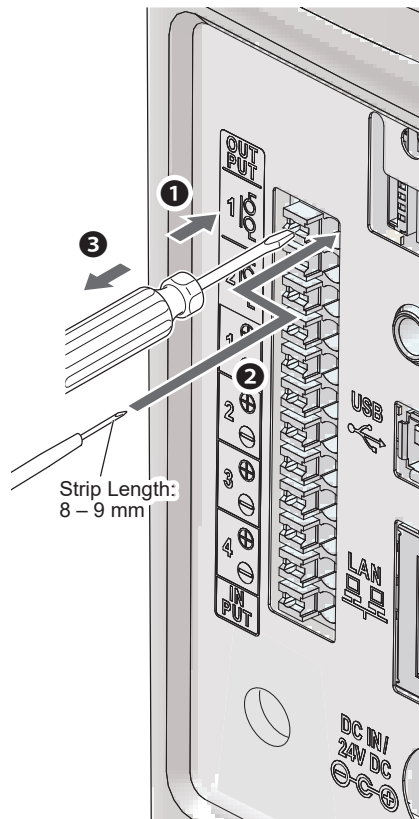

#### ■ Supported Wire Diameter

Single Wire	φ 0.4 to 0.8 mm (AWG26-20)
Stranded Wire	0.13 to 0.52 mm <sup>2</sup> (AWG26-20)

### 6.4.2. Circuit Diagram

● Digital input circuit diagram

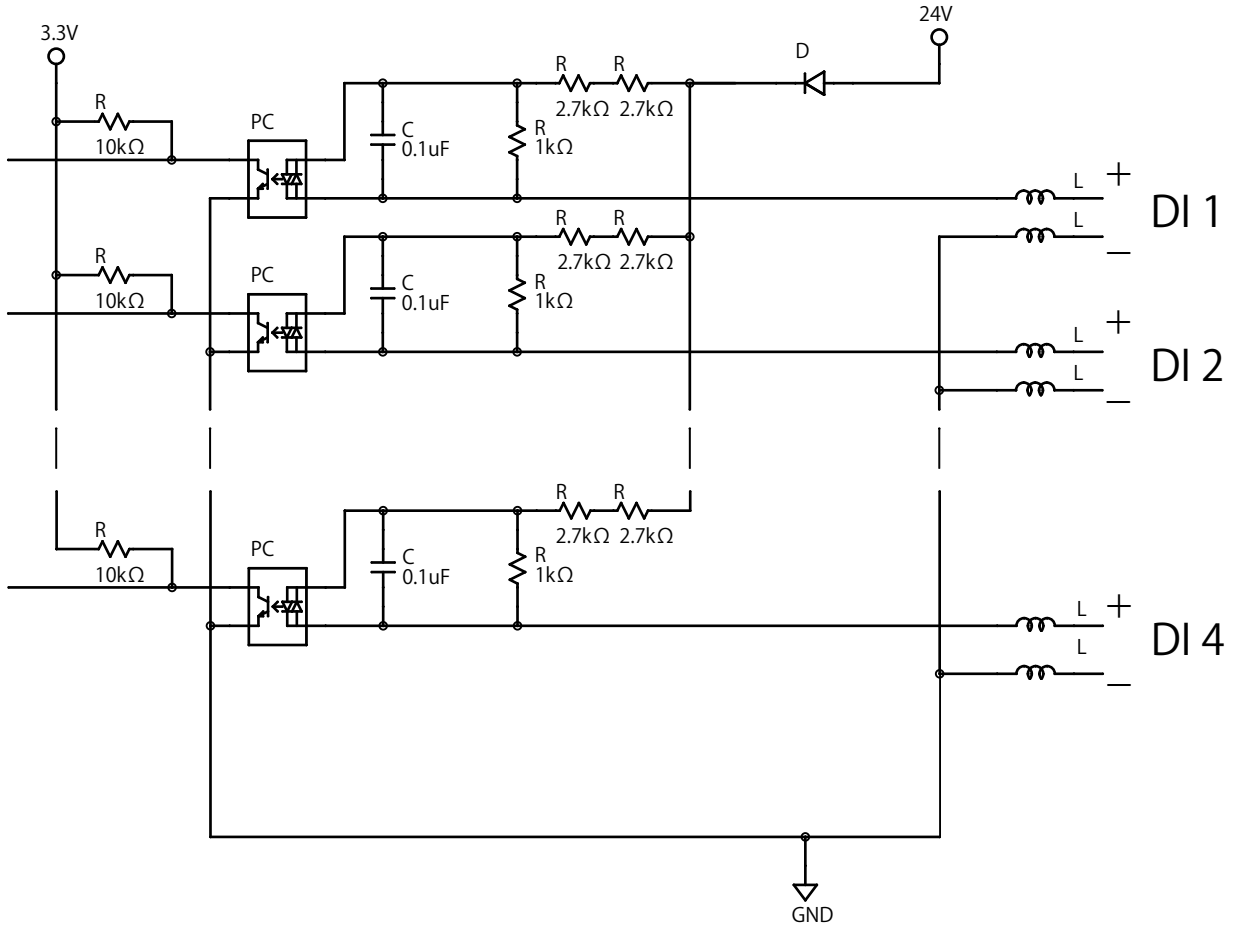

● Digital output circuit diagram

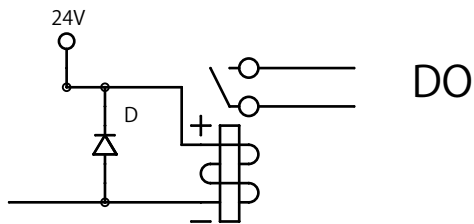

## 6.5. LAN Cable Wiring Method

LAN cable is not included with this product. Please provide your own.

### CAUTION

- ❗ The LAN cable should have an RJ-45 connector and be rated for Category 5e or higher (Category 6 or higher recommended).

- 1 Connect the LAN cable to the LAN connector on the back of the product.

Note: Push in the LAN cable until it clicks.

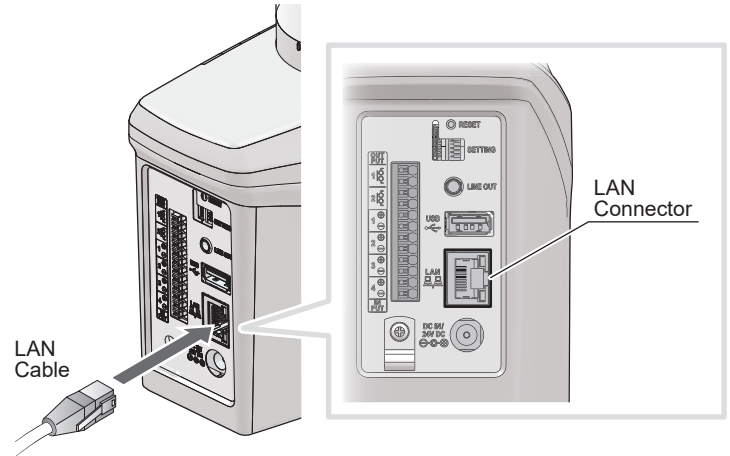

## 6.6. Power Supply Method

There are two different power supplies for this product: AC adapter and PoE power supply.

### 6.6.1. When Using AC Adapter Power Supply

#### WARNING

- ⊘ While power is still applied to the AC adapter, do not connect or disconnect the DC power plug. Failure to follow this instruction could result in electric shock or equipment damage.
- ⊘ Do not touch the power outlet with wet hands. Failure to follow this instruction could result in electric shock.
- ⚠ When using an AC adapter other than the one provided (ADP-001), use an AC adapter that meets the recommended specifications. Using an AC adapter that does not meet the recommended specifications could result in fire or equipment damage.
- ⚠ Use an AC adapter equipped with overcurrent protection. Using an AC adapter without overcurrent protection could result in fire or equipment damage.

#### CAUTION

- ⚠ Use the AC adapter supplied with this product. If you need to order the AC adapter separately, order our AC adapter (ADP-001).
- ⚠ If you use an AC adapter other than ADP-001, use an AC adapter that meets the specifications below.

##### Recommended AC Adapter Specifications

- Secondary voltage (DC)
- Voltage: 24 VDC  $\pm$  5%
- Current: 0.75 A or more, 1 A or less (with overcurrent protection)
- Plug Length: 9.5 mm or longer
- Housing:  $\phi$  10 mm or shorter
- Outer Diameter of Plug:  $\phi$  5.5 mm
- Inner Diameter of Plug:  $\phi$  2.1 mm

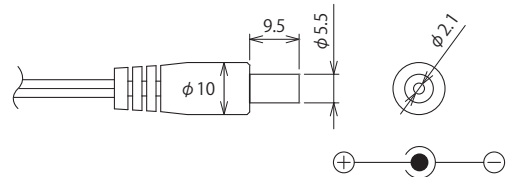

**1** Loosen the screw with a Phillips screwdriver and detach the power cable clamp.

**2** Pass the AC adapter power cable through the power cable clamp.

**3** Insert the DC plug into the product body with some extra in the power cable.

**4** Secure the power cable clamp with the screw without applying excessive force on the cable.

Recommended Torque	0.3 N·m (approximate)
--------------------	-----------------------

**5** Process the extra portion of cord.

**6** Plug the AC adapter into the power outlet.

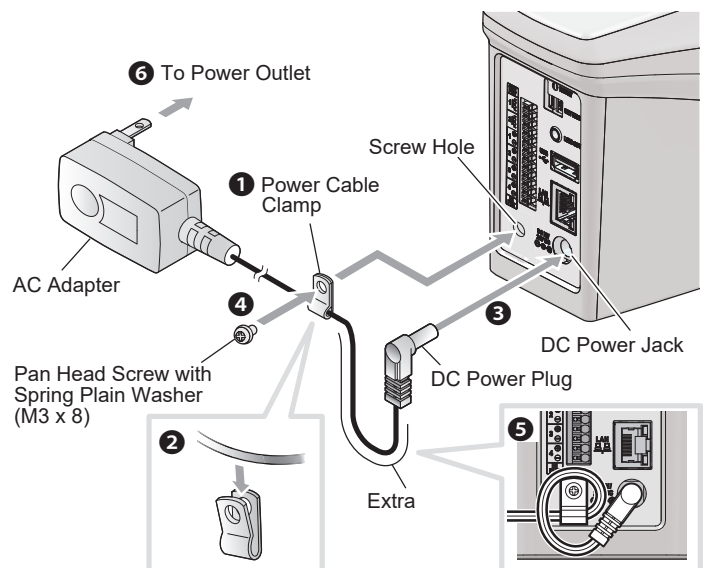

\* Illustration is of a  model.

### 6.6.2. When Using PoE to Supply Power NHV Series (P model)

**⚠ CAUTION**

- ⊘ Make sure the PoE network is indoors and that none of the LAN cable is run outdoors. Failure to follow this instruction could result in equipment damage due to transient voltage from lightning.
- ⚠ When using a PoE power supply, IEEE802.3at compliant PoE+ power supply devices (HUB, injector) are required. When using a IEEE802.3af compliant PoE power supply device, the main unit cannot supply USB power from its USB connector.
- ⚠ When power is supplied from a PoE device, power is not required from an AC adapter. If both PoE and AC adapter supply power at the same time, priority is given to the PoE power supply.

### 6.6.3. Checking at Startup

After power is turned on, it takes approximately 60 seconds to complete startup.

**1** Immediately after turning on the power, check the states of the LED unit and status LED.

- LED Unit: All lights turn on (for about 3 seconds) \*Except 0-tier models
- Status LED: Green light on

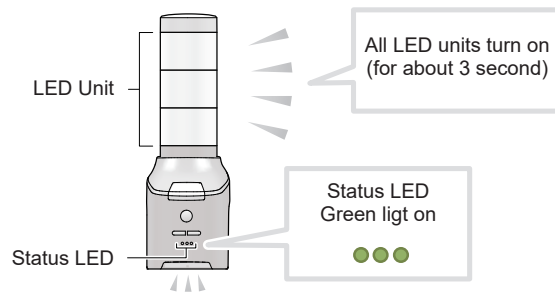

**2** After dozens of seconds, check the states of the LED unit and status LED.

- LED Unit: All lights turn on again (for about 1 seconds) \*Except 0-tier models ➡ Light off
- Status LED: Blue light on

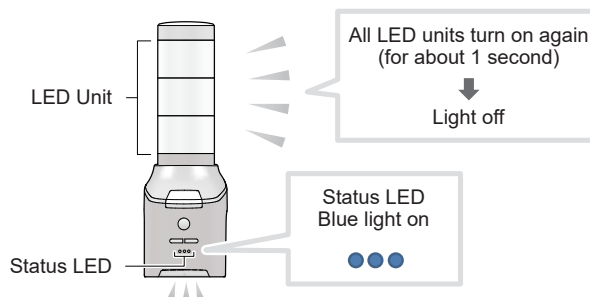



## 7. Before Use

This section describes the setup procedure required to use this product. Follow the steps below for setup.

**STEP 1** As per your application, determine how the IP address is allocated

**Constant Address**

**STEP 2** Add network settings

**Automatic Address**

**STEP 2** Set DHCP function to [Enabled]

**STEP 3** Set up user authentication

**STEP 4** Display the Web Setup Screen

**STEP 5** Set up this product's Basic Settings

**STEP 6** Use this product

**This manual**

"7.2. Setting Up Network Settings on the PC" (🔗 page 93)

**This manual**

"7.1. Enabling DHCP Function" (🔗 page 92)

**This manual**

"7.3. Setting Up User Authentication (User Name and Password)" (🔗 page 96)



Must be done at the time of purchase or initialization of settings. After setup, the login screen will display.

**This manual**

"7.4. Displaying the Web Setup Screen" (🔗 page 97)

**This manual**

- Network Settings "7.5. Setting Up Product Network Settings" (🔗 page 100)
- Clock Settings "7.6. Setting Up the Clock" (🔗 page 102)
- Security Settings "7.7. Setting Up Security" (🔗 page 104)
- Product name and installation location settings "7.8. Setting Up the Product Name, Installation Location, and Contact" (🔗 page 106)
- Speaker Volume Settings "7.9. Setting Up the Buzzer" (🔗 page 107)
- LED unit (multi-color) and transmitter unit settings "7.13. Setting Up LED Unit (Multi-color) and Transmitter Unit Settings" (🔗 page 111)
- Adjusting brightness of the LED unit "7.14. Setting Up LED Unit Brightness Adjustment" (🔗 page 112)
- Normal State Settings "7.15. Setting Up Normal Status" (🔗 page 113)

**NHB Series**

- Buzzer settings "7.9. Setting Up the Buzzer" (🔗 page 107)

**NHV Series**

- Speaker volume settings "7.10. Setting Up the Speaker Volume" (🔗 page 108)
- Line Out volume settings "7.11. Setting Up the Line Out Volume" (🔗 page 109)
- Audio Playback Mode Settings "7.12. Setting Up Audio Playback Mode" (🔗 page 110)
- Voice Registration "7.16. Setting Up Voice Registration" (🔗 page 114)



After completing the desired setup configuration, reboot this product by pressing the "reset" button, or removing the power for a few seconds and reapplying it for the changes to take effect.





**This manual**

"8. Operation" (🔗 page 118)

## 7.1. Enabling DHCP Function

- By enabling the DHCP function, this product can access the DHCP server and automatically get network information.
- To enable the DHCP function, you can operate buttons on the main unit or use the Web Setup Screen. When using the Web Setup Screen, refer to "7.5. Setting Up Product Network Settings" (☞ page 100).

### CAUTION

-  If access to the DHCP server is unavailable, product starts up using the factory default network information.
-  If you enable the DHCP function, DHCP will also be enabled in subsequent startups. To disable the DHCP function, in the Web Setup Screen's network settings, change the setup method to [Manual Settings].
-  When using DIP Switches, do not use excessive force.
-  After completing setup, to use this product, set all DIP switches OFF.

#### When Using DIP Switches to Enable DHCP Function

**1** At the back of the product, turn ON DIP switch 4.

**2** Power up the product.

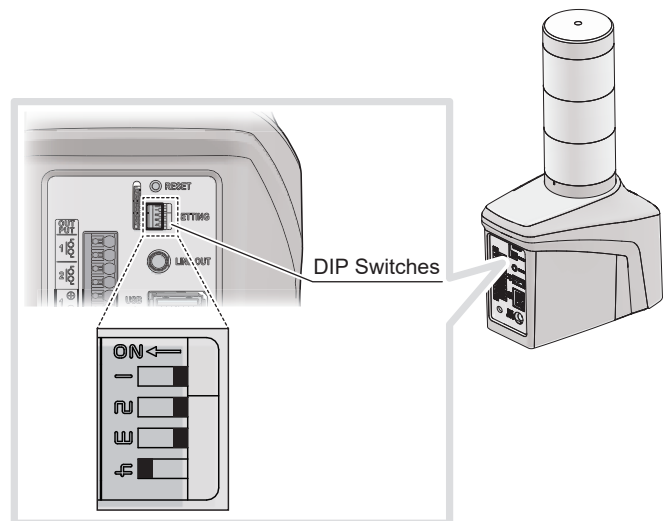

**3** The DHCP function is [Enabled].

- When the DHCP function is [Enabled], the Status LED turns Amber.
- For the NHV series, the message "DHCP client function was enabled. Return the setting switch and restart the main unit." is played.

**4** After enabling the DHCP function, turn off the power.

**5** Turn all the DIP switches OFF.

- As required, start up and set up the product.

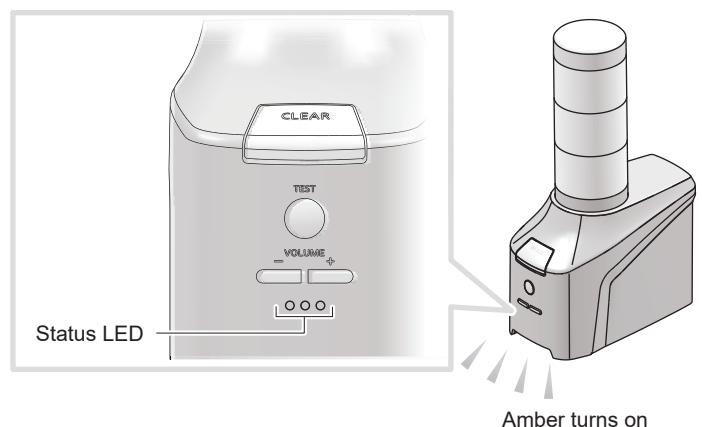

## 7.2. Setting Up Network Settings on the PC

- To display the product’s Web Setup Screen, set up is required on a personal computer. The following procedure is based on factory default settings.
- When enabling the DHCP function on the Web Setup Screen, configure the settings to match your environment.

**1** From the taskbar’s [Windows Start menu], click [Settings] to enter the [Settings] screen.

**2** Click [Network & Internet] to enter the [View network status and tasks] screen.

**3** From [View network status and tasks], click [Change adapter options] to display the [Network Connections] screen.

**4** Double-click either [Ethernet] or [Local Area Connection], used to connect the product.

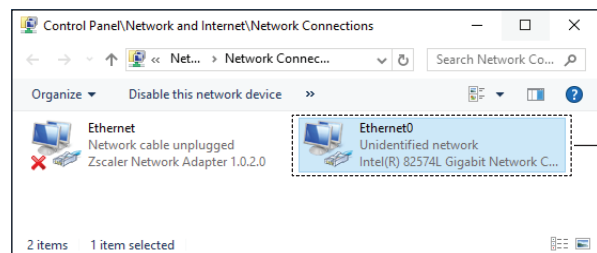
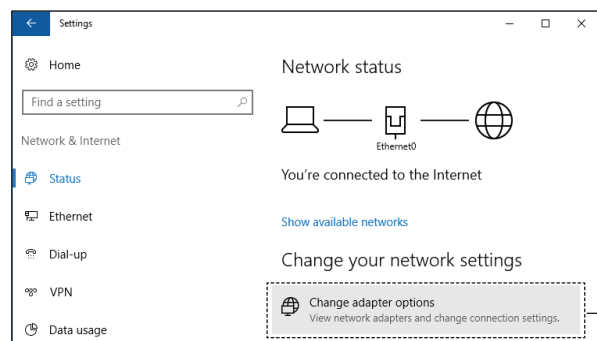
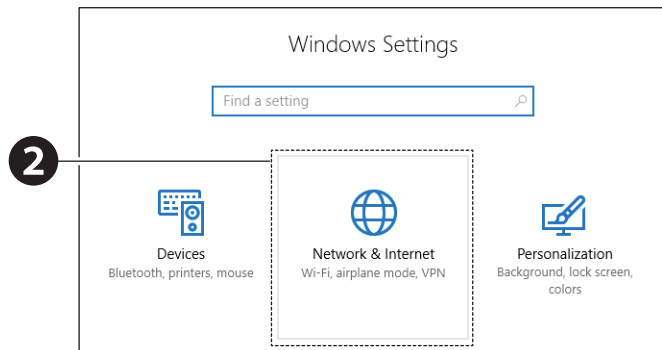

**5** Click [Properties].

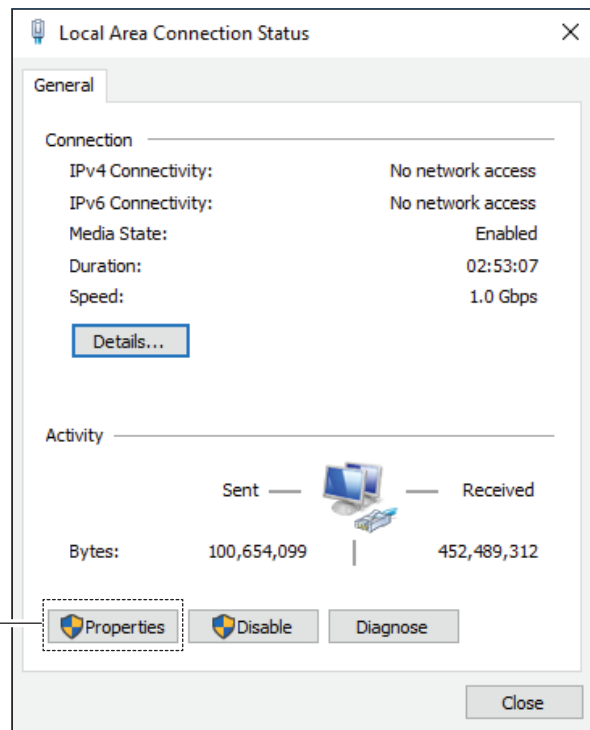

**6** Select [Internet Protocol Version 4 (TCP/IPv4)] and click [Properties].

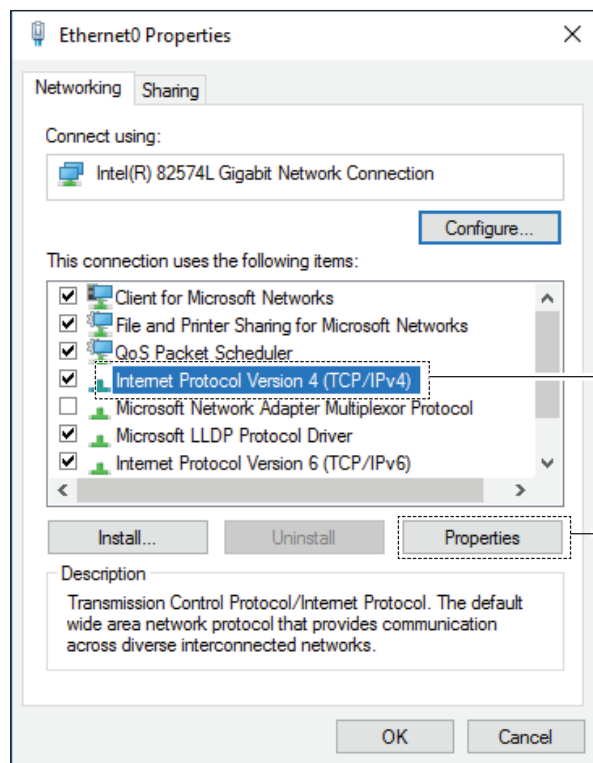

**7** In the [General] tab, select the [Use the following IP address:] check box and set the items.

- IP address: 192.168.10.2 to 254
- Subnet mask: 255.255.255.0
- Default gateway: No setting is required for a direct connection. When connecting to a network, check with the network administrator.
- \* Determine beforehand the settings you plan to use at run time.

**8** After the entries are complete, click [OK].

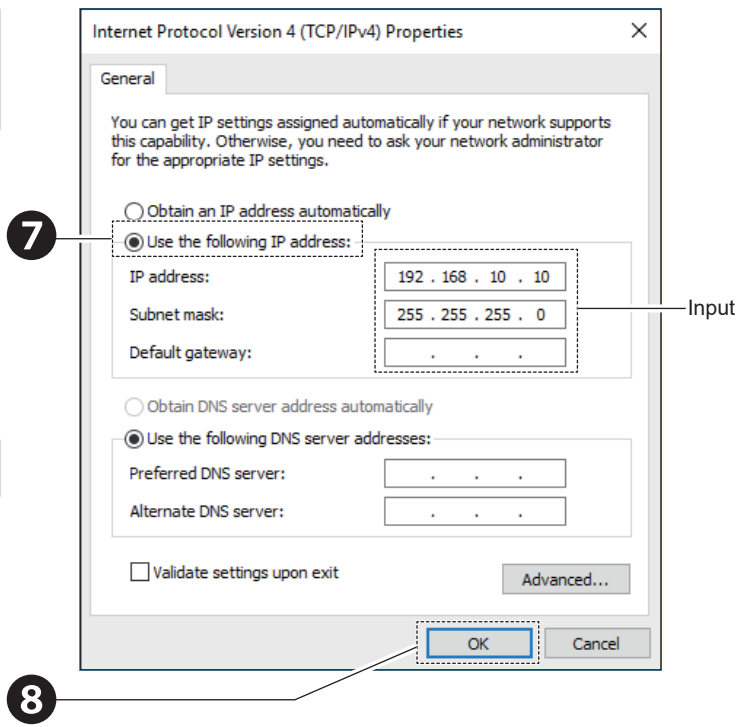

### 7.3. Setting Up User Authentication (User Name and Password)

- Web browsers supported by this product are Google Chrome and Microsoft Edge.
- To specify various settings on this product, a user name and password are required.
- After purchase, either the first time you use a browser to open the Web Setup Screen, or after initializing you use a browser to open the Web Setup Screen, instead of the login screen the User authentication settings screen will appear.

#### ⚠ CAUTION

⚠ Do not forget the user name and password. If you cannot remember either one, login will not be possible. In the unlikely event you cannot remember the user name and password, run initialization and set up the user name and password again.

**1** Start a Web browser.

**2** In the Web browser address bar, enter the IP address\* set for this product.

- \* The default IP address for this product is "192.168.10.1".
- \* If the User authentication settings screen does not appear, confirm your computer's network settings are set up correctly. "7.2. Setting Up Network Settings on the PC" (👉 page 93)

**3** Review the important statements about the product and press [Agree].

**4** Configure settings for each item.



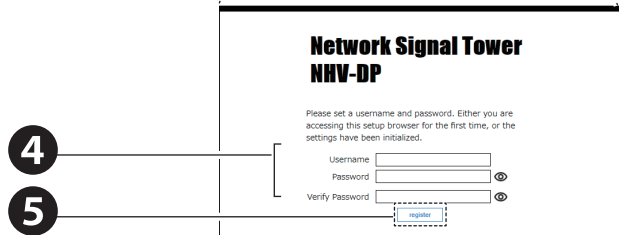
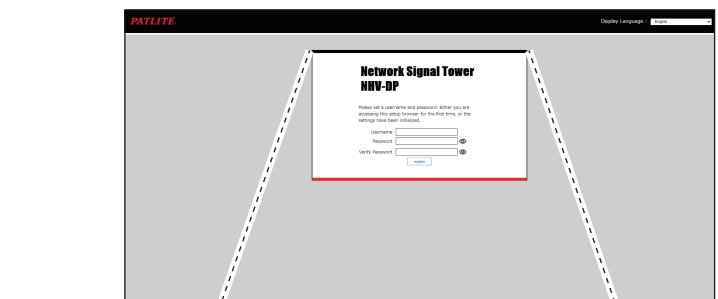
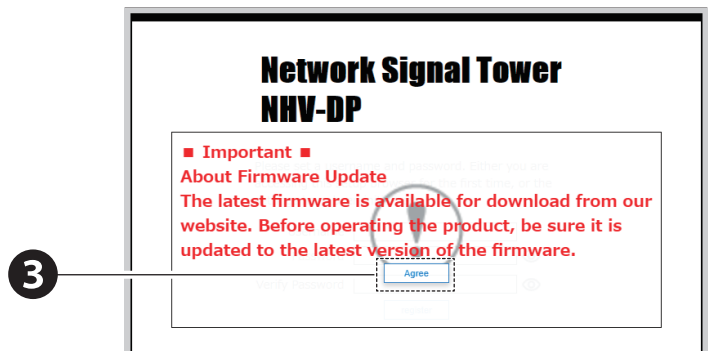
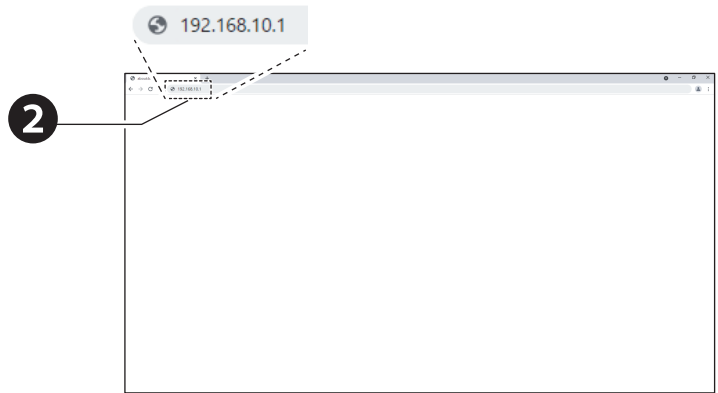

- [Username]: Set the user name you want to use
- [Password]: Set the password you want to use
- [Verify Password]: Enter the password again for confirmation

**5** Click [register] to apply the defined settings.



## 7.4. Displaying the Web Setup Screen

### CAUTION

-  While logged in, after a specified period of inactivity you are automatically logged out.
-  You can set the amount of time before you are automatically logged out from the Security Settings screen's Auto Logout Time property.  
"9.8.7. Security Settings" (  page 313)
-  If the screen does not display correctly due to corrupted characters, change the character encoding to Unicode (UTF-8).
-  To prevent set up from multiple locations at the same time, duplicate logins are not allowed.

**1** Start a Web browser.

**2** In the Web browser address bar, enter the IP address\* set for this product.

- \* The default IP address for this product is "192.168.10.1".
- \* If the User authentication settings screen does not appear, confirm your computer's network settings are set up correctly.  
"7.2. Setting Up Network Settings on the PC" (  page 93)



**3** Select a language and configure settings for each item.

- [Username]: Configured user name
- [Password]: Configured password

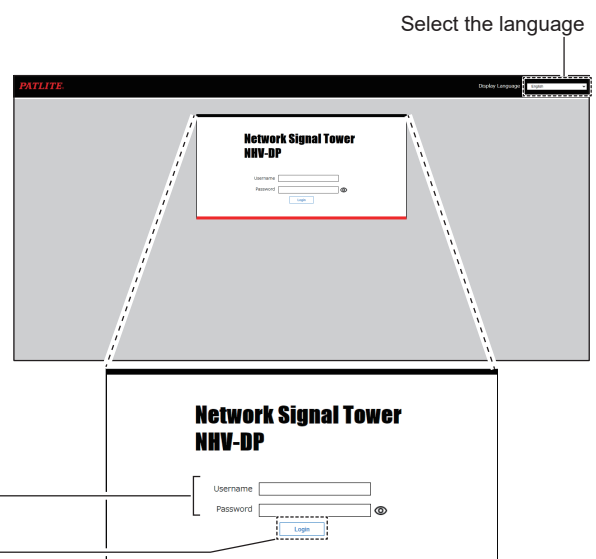
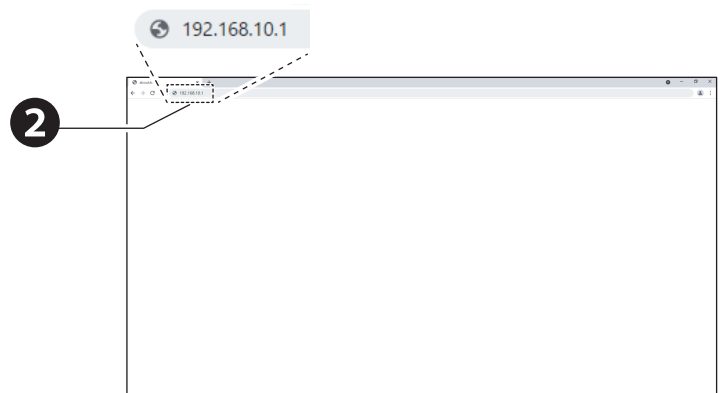
**4** Click the [Login] button to log in.



**5** On a successful log in, the Web Setup Screen (home screen) is displayed.

- \* Click  to return to the login screen.
- \* Click  to return to the home screen.

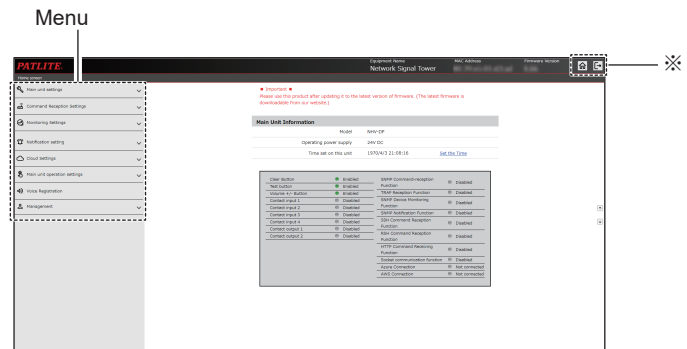

**Point**

- To configure a setting, from the menu on the left-hand side click the item you want to set. The selected set up screen is displayed.
- After entering settings on each setup screen, click [Set] to apply.

 Setup is now complete : Settings are successfully applied.

 Check the contents of the settings : There are errors in the settings.

**● How to Read the Home Screen**

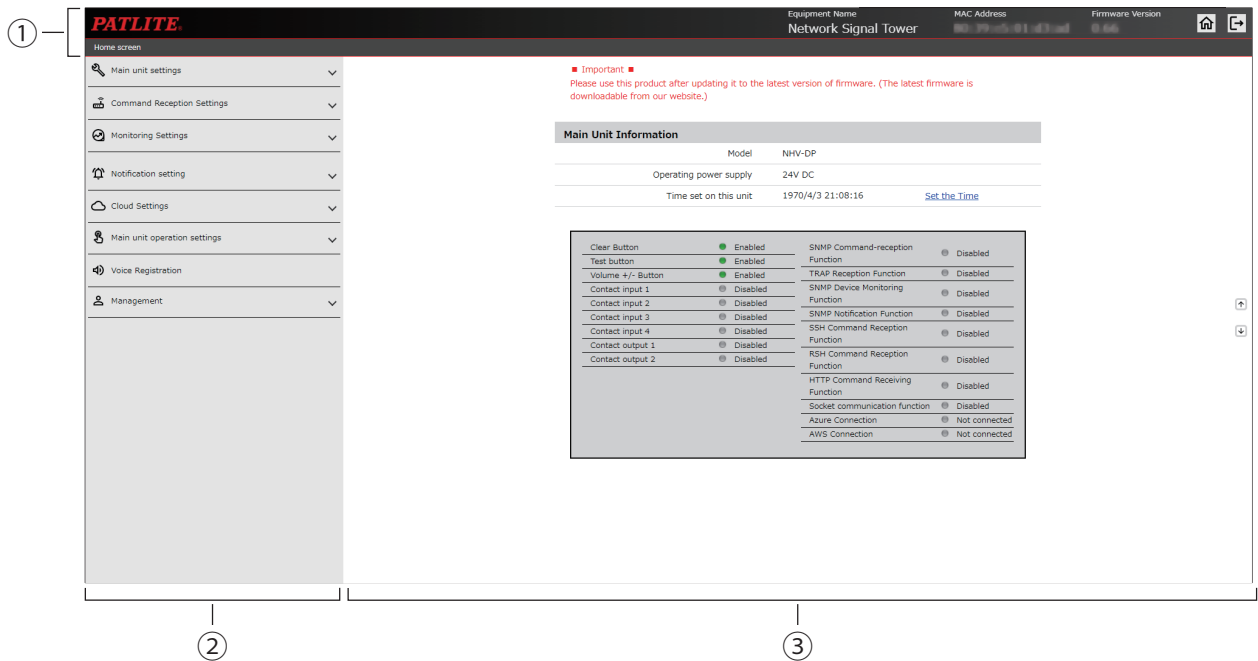

No.	Name	Description
①	Header	There are product information, home button, and logout button.
②	Menu	Enter the setting screen of each function.
③	Setting Screen	Set each function.



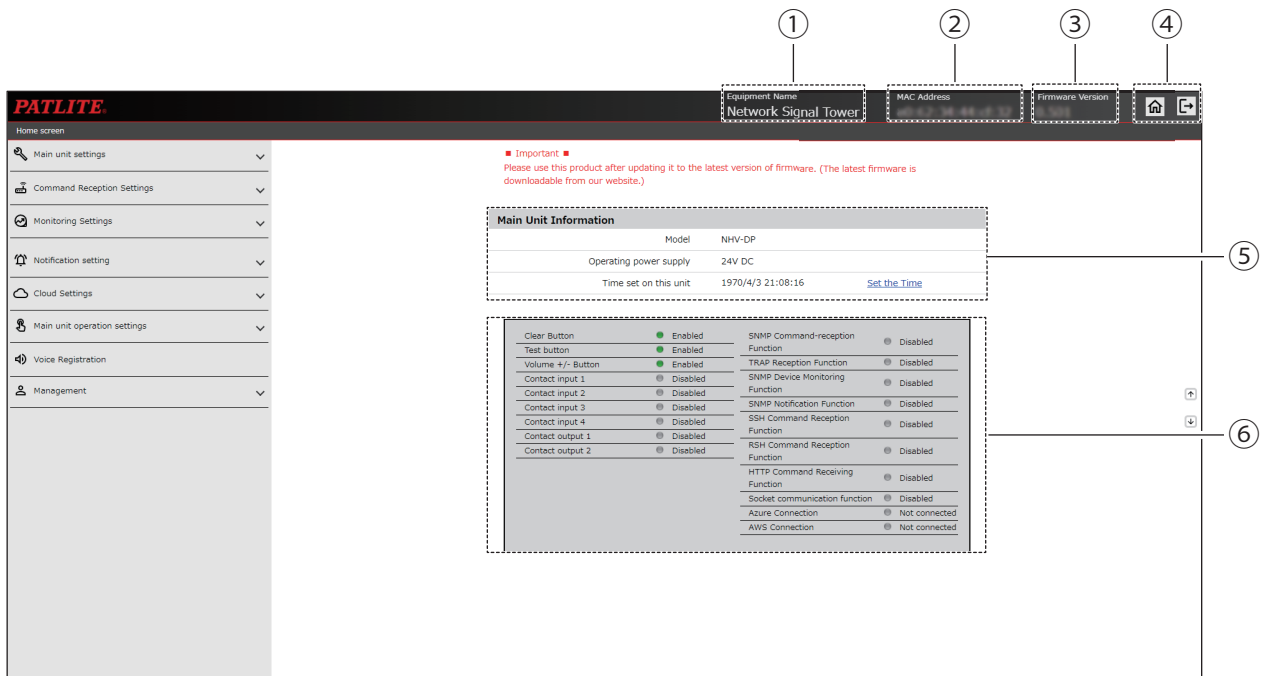

No.	Name	Description
①	Equipment Name	Indicate the equipment name registered in Basic Settings - Main unit settings.
②	MAC Address	Check the MAC Address on the product.
③	Firemware Version	Check the firmware version that the product is currently using.
④	Button	There are the home button and the logout button in the home screen.
⑤	Main Unit Information	Check the product model name, operating power supply, and clock.
⑥	Product Function List	Check the setup status of each function.

## 7.5. Setting Up Product Network Settings

- To use this product, the network settings must be configured.
- There are two ways to configure settings: When using in an IPv4 network and when using in an IPv6 network. Set according to how the product will be used.
- For information on each item, refer to "9.1.2. Network Settings" (👉 page 241).

### ⚠ CAUTION

- ⚠ When IP address configuration is set to [Automatic Settings], and access to the DHCP server is unavailable, the product starts up with the factory default network settings.
- ⚠ With the [Automatic Settings] option, the product restarts with the DHCP function enabled.
- ⚠ After changing the IP address, to reconnect to the product change the network settings on your computer as required.

**1** From the [Main unit settings] tab, click [Network settings] to enter the network settings screen.

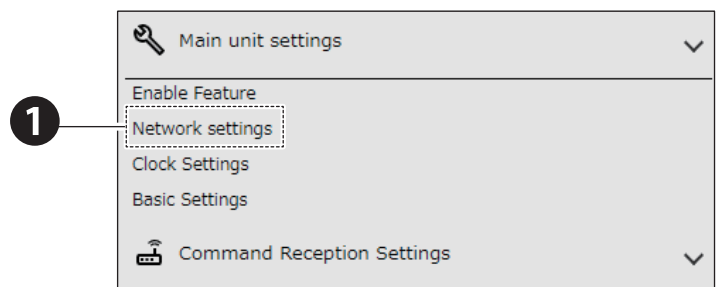

#### When Using in an IPv4 Network

**2** Select the [Setting Method].

- To specify a constant IP address, select [Manual Settings].
- To get an IP address automatically from the DHCP server, select [Automatic Settings].

**3** Enter the [IP Address], [Subnet Mask], and [Default gateway].

- Enter the settings in accordance with the network environment in which this product is used.
- \* If the [Setting Method] is [Automatic Settings], input is disabled.

**4** Enter the [DNS server address].

- If a DNS server is not used, enter "0.0.0.0".

**5** Enter the product's host name.

**5** Click [Set] to apply the defined settings.

- \* After the settings are applied, the product is automatically restarted.
- \* Restarting the product takes approximately 60 seconds.

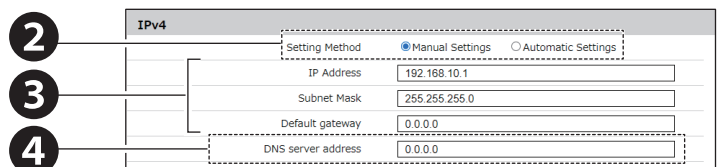

**When Using in an IPv6 Network**

**2** Select the [Setting Method].

To specify a constant IP address, select [Manual Settings].  
 To get an IP address automatically from the DHCP server, select [Automatic Settings].

**3** Enter the [IP Address], [Prefix length], and [Default gateway].

Enter the settings in accordance with the network environment in which this product is used.  
 \* If the [Setting Method] is [Automatic Settings], input is disabled.

**4** Enter the [DNS server address].

If a DNS server is not used, leave the [DNS server address] blank.

**5** Enter the product's host name.

**6** Click [Set] to apply the defined settings.

- \* After the settings are applied, the product is automatically restarted.
- \* Restarting the product takes approximately 60 seconds.

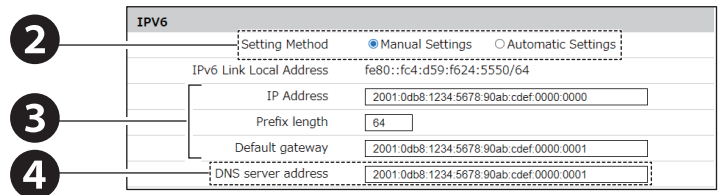

## 7.6. Setting Up the Clock

- Configure the clock on this product. There are two ways to set up the clock.
- For information on each item, refer to "9.1.3. Clock Settings" (👉 page 243).

### CAUTION

- ⊘ Regardless of the Time zone setting, do not use this product outside of supported countries and regions.
- ⚠ This product uses a capacitor to back up time information. If there is no power for about half a day, the defined time may shift or it may be reset depending on the charge on the capacitor.
- ⚠ If the backup expires and the clock is reset, it will show January 1, 1970.
- ⚠ When aligning the time with the PC clock, the time may be off by several seconds from the actual PC clock.
- ⚠ If you do not use a NTP server, periodically check and correct the time on the product.

#### Matching the Clock with the Computer You are Logged in to

**1** From the [Main unit settings] tab, click [Clock Settings] to display the [Clock Settings] screen.

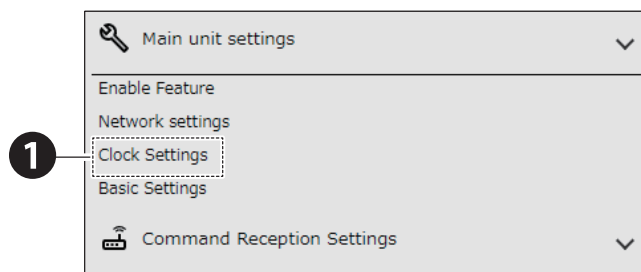

**2** Click the [Set] button.

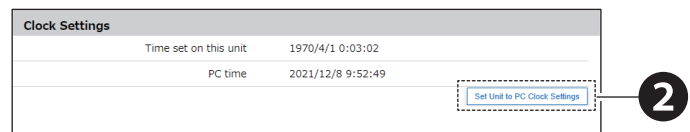

**Communicate with NTP Server and Adjust Automatically**

**1** From the [Main unit settings] tab, click [Clock Settings] to display the [Clock Settings] screen.

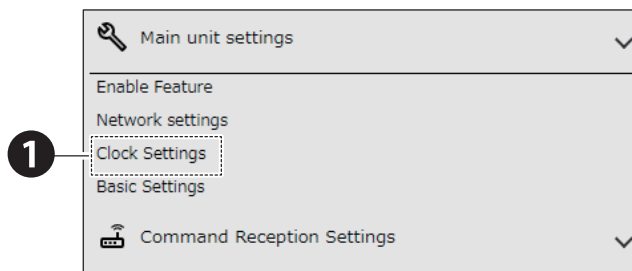

**2** In the [NTP Server Address] field, enter either the NTP server address or its host name.

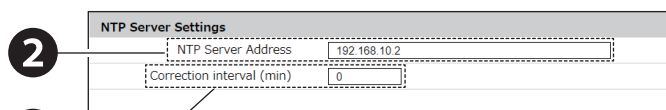

- To use a host name for the [NTP server address], set the DNS server address.
- To communicate with an NTP server on an external network, set a default gateway.

**3** In the [Correction interval (min)] field, enter the interval of NTP server communications.

**3**

**4** Set the [Time zone].

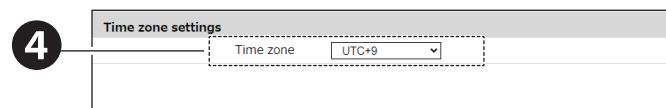

\* The relationship between the Time zone setting and representative cities is as follows. Refer to the table for settings.

Setting	Name of representative city
UTC-12	Baker Island
UTC-11	Midway Island
UTC-10	Honolulu
UTC-9	Anchorage
UTC-8	Los Angeles
UTC-7	Denver
UTC-6	Chicago / Mexico City
UTC-5	New York / Ottawa
UTC-3	Rio de Janeiro
UTC-2	Fernando de Noronha
UTC-1	Azores
UTC	London

Setting	Name of representative city
UTC+1	Paris / Berlin
UTC+2	Cairo
UTC+3	Jeddah
UTC+4	Dubai
UTC+5	Karachi
UTC+6	Dhaka
UTC+7	Bangkok / Jakarta / Hanoi
UTC+8	Beijing / Taipei / Singapore / Manila / Kuala Lumpur
UTC+9	Tokyo / Seoul
UTC+10	Sydney
UTC+11	Nouméa
UTC+12	Wellington

**5** Click [Set] to apply the defined settings.

## 7.7. Setting Up Security

- Set the Web Setup Screen communication protocol and amount of time before you are automatically logged out.
- For information on each item, refer to "9.8.7. Security Settings" (📖 page 313).

### CAUTION

 If you select https communication without registering certificate and private key, when you access the Web Setup Screen or display a pop-up, sometimes an error screen with a message such as "This site is not secure" or "This connection does not protect privacy" will appear.

In the browser, click the [Details] link then click [Go to Web page] to access the Web Setup Screen.  
(The displayed text differs depending on your browser and browser version.)

**1** From the [Management] tab, click [Security Settings] to display the [Security Settings] window.

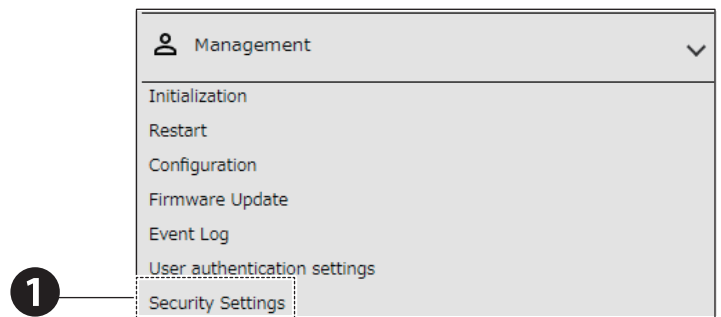

**2** Select the [Communication Protocols].

Communicate via HTTP

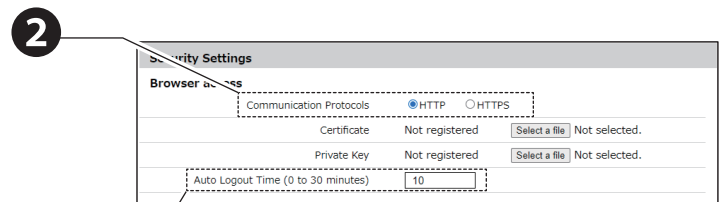

**3** Enter the [Auto Logout Time].

- \* When the time you entered has elapsed, you are automatically logged out.
- \* When "0" is specified, you are not automatically logged out.
- \* In units of a minute.

**3**

**4** Click [Set] to apply the defined settings.

**Communicate via HTTPS**

**3** Register [Certificate].

**4** Register [Certificate].

**5** Enter the [Auto Logout Time].

- \* When the time you entered has elapsed, you are automatically logged out.
- \* When "0" is specified, you are not automatically logged out.
- \* In units of a minute.

**4** Click [Set] to apply the defined settings.

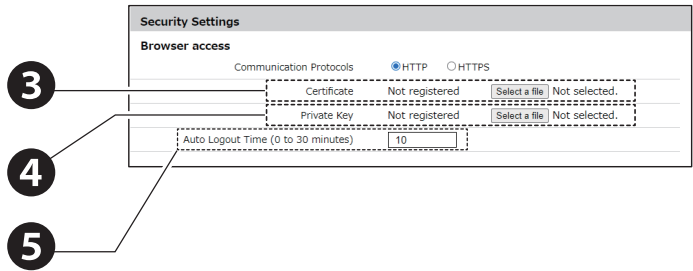

## 7.8. Setting Up the Product Name, Installation Location, and Contact

- Configure the naming information for this product.
- For information on each item, refer to "9.1.4. Basic Settings" (👉 page 244).

**1** From the [Main unit settings] tab, click [Basic Settings] to display the [Basic Settings] screen.

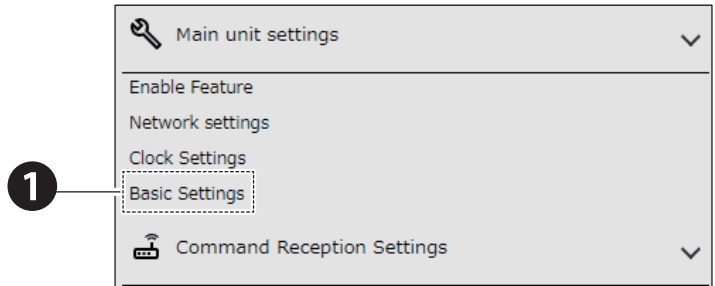

**2** Enter the [Product Name] and [Installation Location].

Enter and edit as required.

The following are the states for the factory default.

- Product Name "Network Signal Tower"
- Installation Location "(blank)"
- Contact "(blank)"

The [Product Name] is used in the email body text, or as device information when using the PNS Manager.

The [Installation Location] is used in the email body text.

The [Contact] is used in the email body text.

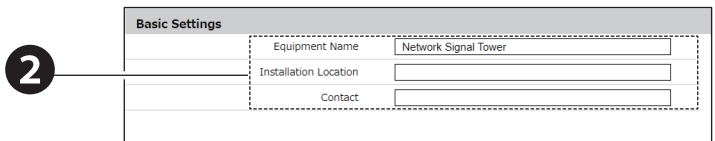

**3** Click [Set] to apply the defined settings.



## 7.9. Setting Up the Buzzer NHB Series

- Configure the buzzer setting on this product.
- For information on each item, refer to "9.1.4. Basic Settings" (👉 page 244).

**1** From the [Main unit settings] tab, click [Basic Settings] to display the [Basic Settings] screen.

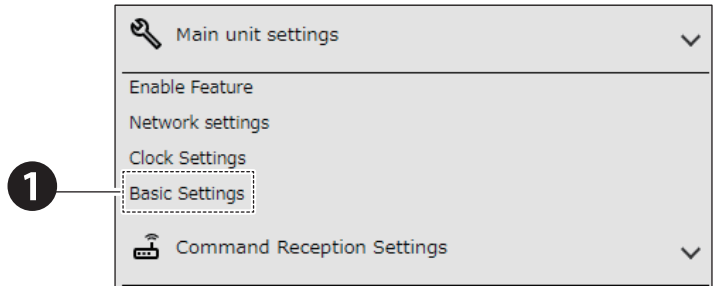

**2** Select the volume from pull-down menu of [Buzzer], and adjust the buzzer volume of this product.

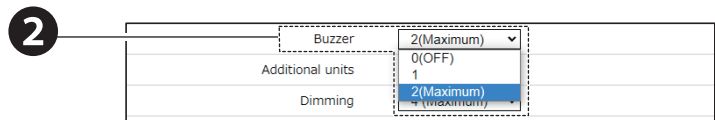

**3** Click [Set] to apply the defined settings.

## 7.10. Setting Up the Speaker Volume

- Configure the speaker volume setting on this product.
- For information on each item, refer to "9.1.4. Basic Settings" (👉 page 244).

**1** From the [Main unit settings] tab, click [Basic Settings] to display the [Basic Settings] screen.

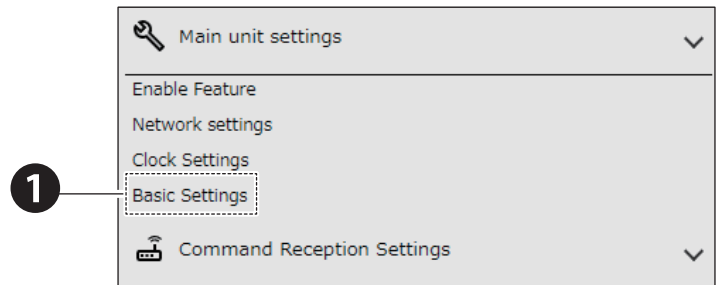

**2** On the [Speaker Volume] property, use the volume slide to adjust the volume of playback on the main unit's speaker.

- The volume decreases as you slide to the left, and increases as you slide to the right.

Note: The playback volume from the main unit's speaker is reduced in accordance with the [Speaker Volume] position, with the actual volume on the MP3 file as the maximum volume.

**3** Click [Set] to apply the defined settings.

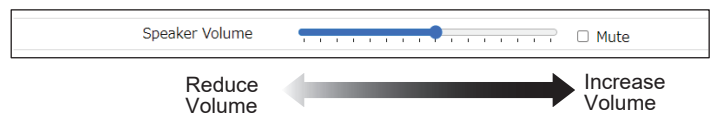

## 7.11. Setting Up the Line Out Volume NHV Series

- Configure the Line Out volume setting on this product.
- For information on each item, refer to "9.1.4. Basic Settings" (👉 page 244).

**1** From the [Main unit settings] tab, click [Basic Settings] to display the [Basic Settings] screen.

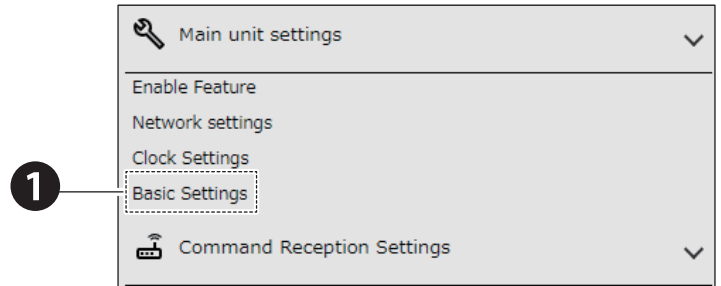

**2** On the [Line Out Volume] property, use the volume slide to adjust the audio output volume on line out.

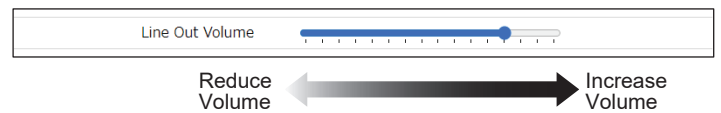

The volume decreases as you slide to the left, and increases as you slide to the right.

**3** Click [Set] to apply the defined settings.

## 7.12. Setting Up Audio Playback Mode NHV Series

- Configure the audio playback mode settings on this product.
- For information on each item, refer to "9.1.4. Basic Settings" (👉 page 244).

**1** From the [Main unit settings] tab, click [Basic Settings] to display the [Basic Settings] screen.

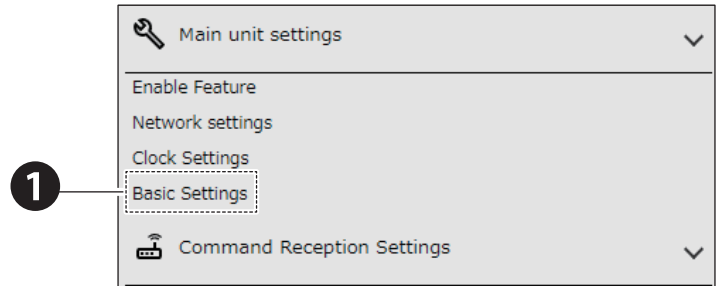

**2** Select [Audio Playback Mode].

- Post-priority Playback Mode: When a playback event occurs, the current audio is interrupted and the event audio is played.
- Memory playback mode: When a playback event occurs, it is registered in channel memory and the event audio is played after the current audio ends.

Note: Behavior differs depending on the audio playback mode. For information, refer to "5.3.2. Audio Playback Function" (👉 page 24).



**3** Click [Set] to apply the defined settings.

### 7.13. Setting Up LED Unit (Multi-color) and Transmitter Unit Settings

- Configure additional unit settings when installing the LED unit (multi-color) or transmitter unit.
- For information on each item, refer to "9.1.4. Basic Settings" (☞ page 244).

**1** From the [Main unit settings] tab, click [Basic Settings] to display the [Basic Settings] screen.

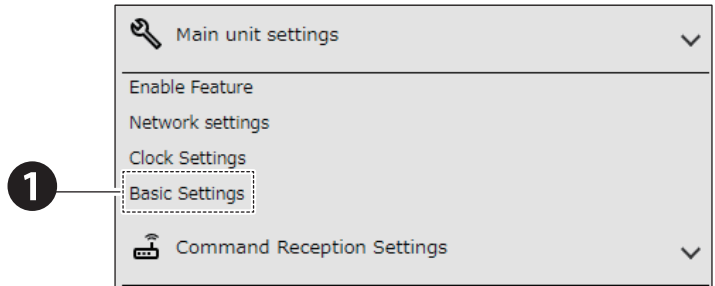

**2** Select [Additional units] from the pull-down menu and specify in accordance with its usage.

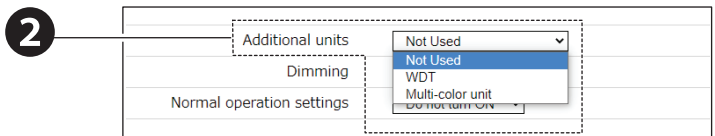

- If an LED unit (multi-color) is installed, specify [Multi-color unit].
- If a transmitter unit is installed, specify [WDT].
- If none of the above units are installed, specify [Not Used].

Note: If one of the units listed above is installed, make sure you specify the correct additional unit. Do not attach an LED unit (multi-color) together with a transmitter unit to this product.

**3** Click [Set] to apply the defined settings.

## 7.14. Setting Up LED Unit Brightness Adjustment

- Set a dimmer setting for a LED unit (colored lens, clear lens) that is installed.
- For information on each item, refer to "9.1.4. Basic Settings" (👉 page 244).

**1** From the [Main unit settings] tab, click [Basic Settings] to display the [Basic Settings] screen.

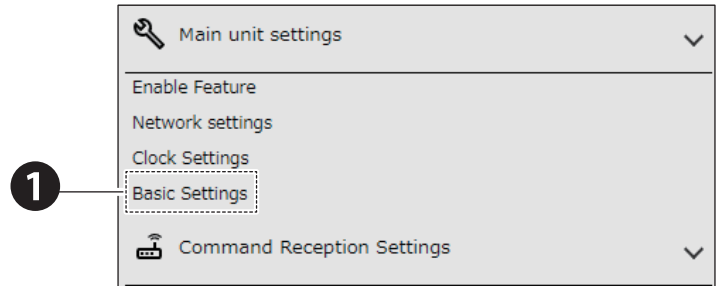

**2** Adjust the [Dimming] brightness level.

- 1 is the minimum brightness, and 4 is the maximum brightness.

Note: When LED Unit (Multi-color) or WDT is specified as the additional unit, the setting is fixed at level 4.

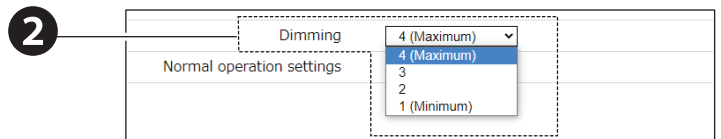

**3** Click [Set] to apply the defined settings.

## 7.15. Setting Up Normal Status

- Set the Signal Tower operation status for normal operation. If you execute the clear operation after setup is complete, the product runs in the set normal status.
- For information on each item, refer to "9.1.4. Basic Settings" (👉 page 244).

1

From the [Main unit settings] tab, click [Basic Settings] to display the [Basic Settings] screen.

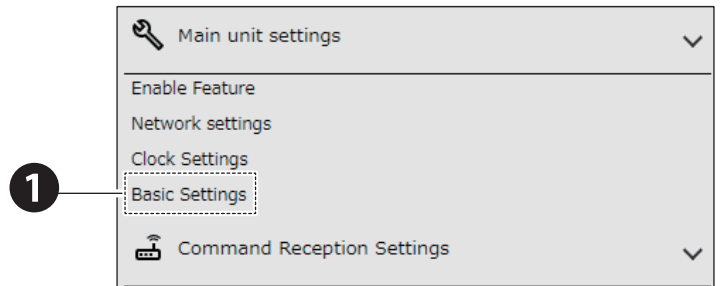

2

Specify the operation state for the [Normal operation settings].

- Any color other than the set light color is turned off.

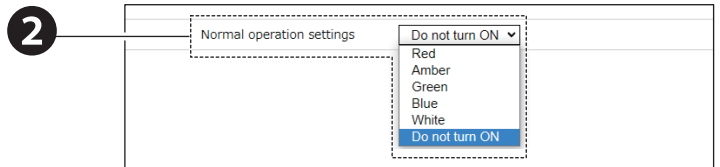

3

Click [Set] to apply the defined settings.

## 7.16. Setting Up Voice Registration NHV Series

- You can register audio that is played on this product.
- In addition to registering MP3 files, you can also use this product to create audio from text messages and register them.
- For information on each item, refer to "9.7. Voice Registration" (👉 page 305).

### ⚠ CAUTION

- ⚠ The total size of files you can register is 40 MB.
- ⚠ Playback may not be possible for MP3 files that are not encoded at a fixed bit rate.
- ⚠ When line out and Busy outputs are enabled, it operates in accordance with the audio preview settings. Confirm the device you are connecting to is in an environment where it is safe to operate before doing so.
- ⚠ Previewing the audio interrupts playback of the current channel.
- ⚠ In memory creation mode, if there is an event in the middle of a preview playback, playback by the event is executed after preview playback is complete.
- ⚠ If you leave the title blank and register as an MP3 file, the file name of the MP3 file is automatically set as the title.
- ⚠ In preset channels, you cannot register audio, change titles, or delete audio.
- ⚠ Preset channels cannot use the line out output.
- ⚠ Environment-dependent characters such as "©" and "♠" and some symbols such as "¥" and "~" may not be synthesized correctly.

### 7.16.1. Audio Registration

**1** Click [Voice Registration] to display the [Voice Registration] screen.

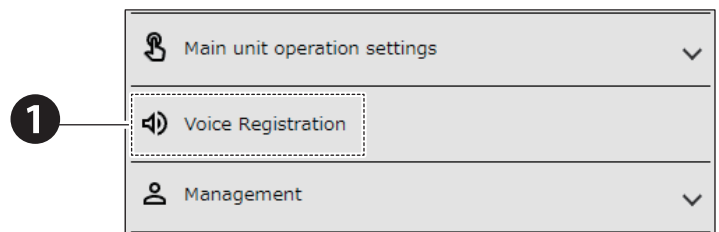

**2** Enter the registration channel to set.

**3** Enter the title of the audio to register.

**4** Select the audio to register from [Voice / MP3 Data].

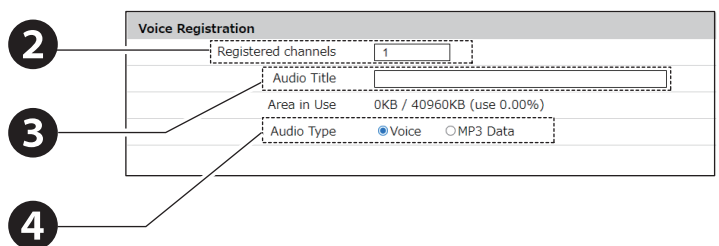



**When Registering Voice Data**

**5** In the [Text] field, enter the text that is read by the Voice.

**6** Set the [Language], [Speed], [Voice], and [Tone] values.

- With the [Language] setting, read aloud text in Japanese or English.
- With the [Voice] setting, read aloud text in a male or female voice.
- By increasing the [Tone] value, read aloud text in a clearer voice. By decreasing the value, read aloud text in a calmer voice.
- With the [Speed] setting, read aloud text faster by increasing the value. By decreasing the value, slow down the reading of text.

**7** Use [Audio Playback] to listen to audio with the specified settings.

- To adjust the audio, set the items in **6** and listen again.

**8** Press the [Add to Channel List] button to register the audio data to the channel.

- When there is no audio title, the text content is registered as the audio title in the channel.

**9** Click [Set] to apply the defined settings.

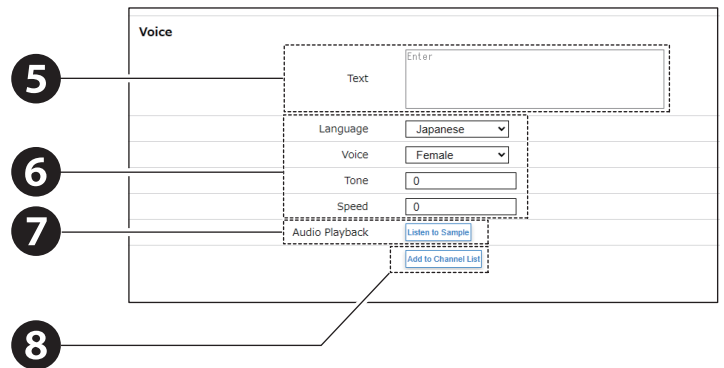

**When Registering MP3 Data**

**5** Click the [Reference] button and select the MP3 Data to register.

**Supported MP3 File Formats**

Format	MPEG1-Audio Layer III (MP3)
Bit Rate	Fixed Bit Rate (CBR only) 32 kbps, 64 kbps, or 128 kbps
Sampling Frequency	44.1KHz
Audio Channel Type	1 ch (mono)
File Size You Can Register	Total up to 40 MB

**6** Press the [Add to Channel List] button to register the audio data to the channel.

- When there is no audio title, the MP3 data name is registered as the audio title in the channel.

**7** Click [Set] to apply the defined settings.

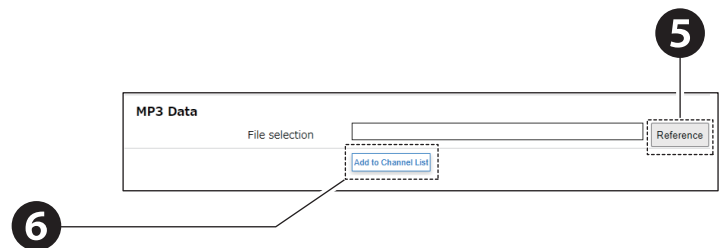

### 7.16.2. Changing the Audio Title

- 1** From [Channel] select [ch1 to ch60].
- 2** In the channel where you want to change the title, change to the desired title.
- 3** Click [Set] to apply the defined settings.

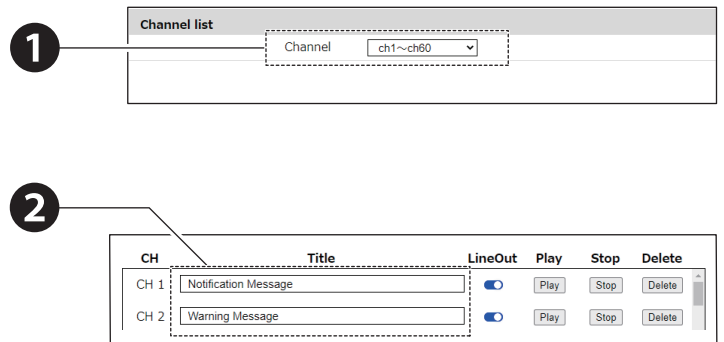

### 7.16.3. Audio Line Out Output

- 1** Select the channel for line out output.
- 2** For the line out of the channel to play, select [Enable/Disable].
- 3** Click [Set] to apply the defined settings.

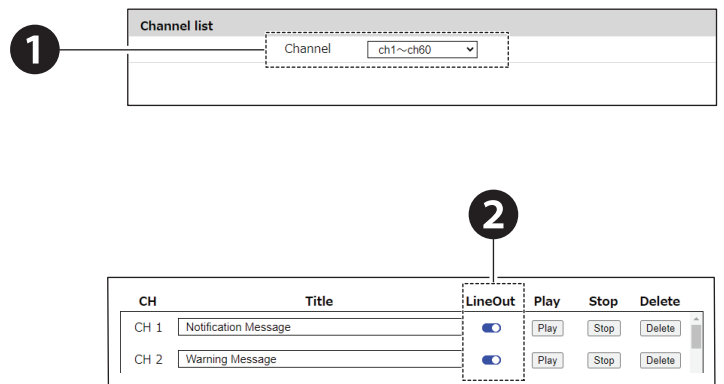

### 7.16.4. Playing and Stopping Audio Playback

- 1** Select the channel to play.
- 2** Click the [Play] button for the channel to play.
- 3** Click the [Stop] button to stop the playback of the channel.

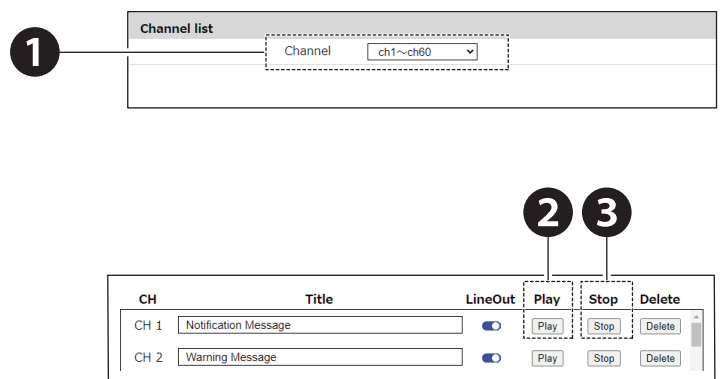

### 7.16.5. Deleting Audio

**1** From [Channel] select [ch1 to ch60].



**2** Click the [Delete] button for the channel to delete.

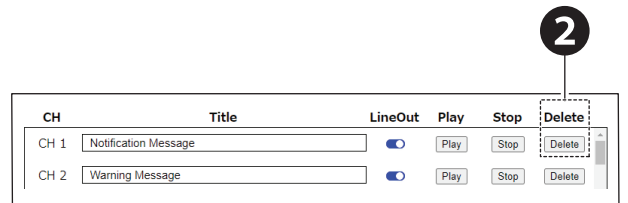

**3** From the pop-up dialog box that appears, click [OK].

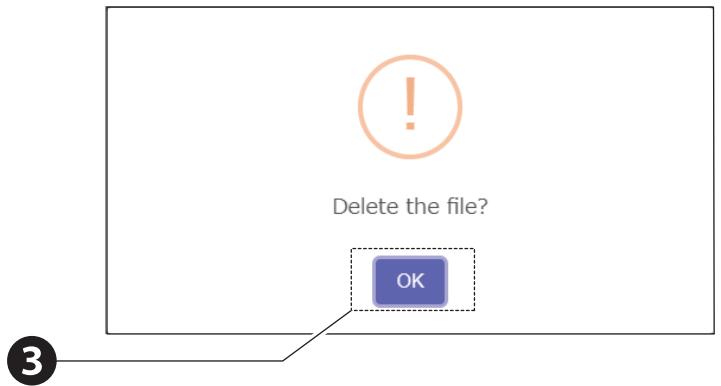

## 8. Operation

This section describes processes on how to set up and use this product. Reference in accordance with how you will use the product.

### 8.1. Notifying Equipment

#### 8.1.1. Setting Up SNMP (Trap Inform) Notification Settings

- Set to send a SNMP notification when an event occurs.
- Using SNMP you can set the community name used by SNMP SET/GET to reference items on the product, and set Send TRAP to notify external entities about events that occurred on this product.
- For information on each item, refer to "9.4.1. SNMP Notification Settings" (👉 page 284).

##### 8.1.1.1. Setup Procedure

###### ● Enable SNMP Notification Function

**1** From the [Notification setting] tab, click [SNMP Notification Settings] to enter the [Common Settings for SNMP Notifications] screen.

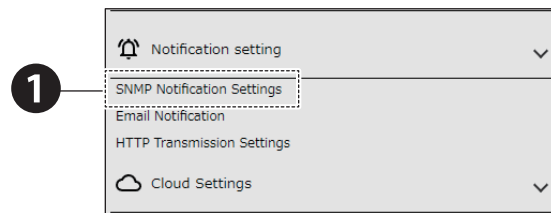

**2** Set the SNMP Notification function to [Enabled].

**3** Enter the number of transmissions.

**4** Enter the v1/v2c Common Transmission TRAP Community Name.

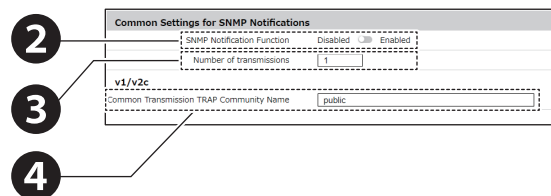

**5** For the SNMP notification recipient, specify the [Notification address] and [Type].

You can set up to 8 SNMP notification recipients.

**■ When Using [v3 - Trap] and [v3 - Inform]**

1	Set the [Username].
2	Select the security level, [NoAuthNoPriv], [AuthNoPriv], or [AuthPriv]. <ul style="list-style-type: none"> <li>NoAuthNoPriv: Communication authentication and encryption are not performed.</li> <li>AuthNoPriv: Performs communication authentication only.</li> <li>AuthPriv: Performs communication authentication and encryption.</li> </ul>
3	When either [AuthNoPriv] or [AuthPriv] is selected for the security level, set the [Authentication method] and [Authentication password]. <ul style="list-style-type: none"> <li>For the Authentication method, select either [MD5] or [SHA1]. Select to match settings on supported equipment.</li> </ul>
4	When you set the [Security Level] to [AuthPriv], set the [Encryption Method] and [Encrypted Password]. <ul style="list-style-type: none"> <li>For the Encryption Method, select either [DES] or [AES]. Select to match settings on supported equipment.</li> </ul>
5	Specify the Engine ID to connect.

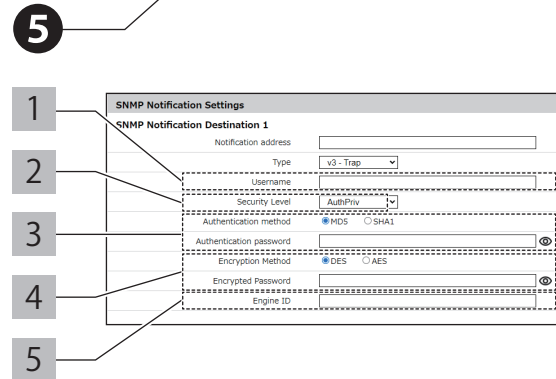
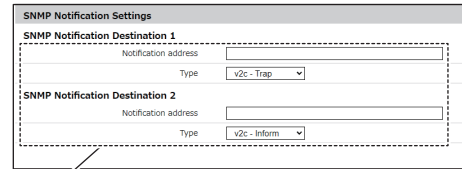

**6** Click [Set] to apply the defined settings.

**● Setting Triggers for SNMP Notifications**

**1** Set SNMP notification to [Enabled] in each setting screen such as Monitoring Settings and Main unit operation settings.

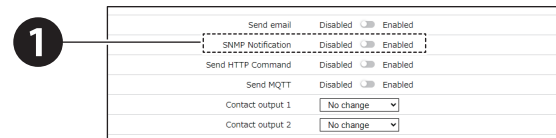

**2** Click [Set] to apply the defined settings.

## ● List of OID Notified by This Product

For information on OID, refer to "10. MIB List" (☞ page 314).

TRAP Number	variable-bindings	Description
OID / Item Name	OID / Item Name	
1.3.6.1.4.1.20440.4.1.6.1 trapPatliteAlarmAdded	1.3.6.1.4.1.20440.4.1.7.2 pingPatternNum	Indicates a problem with the monitoring target specified by the ping monitoring setting number (1 to 24).
1.3.6.1.4.1.20440.4.1.6.2 trapPatliteAlarmRemoved	1.3.6.1.4.1.20440.4.1.7.2 pingPatternNum	Indicates the monitoring target specified by the ping monitoring setting number (1 to 24) has recovered from the problem.
1.3.6.1.4.1.20440.4.1.6.3 trapPatliteTrapReceived	1.3.6.1.4.1.20440.4.1.7.3 trapReceivedPatternNum	Indicates the TRAP specified in the receive TRAP group (1 to 16) has been received.
1.3.6.1.4.1.20440.4.1.6.4 trapPatliteClearExecuted	-	Indicates the Clear button has been pressed.
1.3.6.1.4.1.20440.4.1.6.5 trapPatliteRshExecuted	-	Indicates the RSH/SSH Command has been received.
1.3.6.1.4.1.20440.4.1.6.8 trapPatliteTestSwExecuted	-	Indicates the Test button has been pressed.
1.3.6.1.4.1.20440.4.1.6.11 trapPatliteDiStateChangeOn	1.3.6.1.4.1.20440.4.1.4.4.1 diEntry1	Indicates digital input 1 has been turned on.
	1.3.6.1.4.1.20440.4.1.4.4.2 diEntry2	Indicates digital input 2 has been turned on.
	1.3.6.1.4.1.20440.4.1.4.4.3 diEntry3	Indicates digital input 3 has been turned on.
	1.3.6.1.4.1.20440.4.1.4.4.4 diEntry4	Indicates digital input 4 has been turned on.
1.3.6.1.4.1.20440.4.1.6.12 trapPatliteDiStateChangeOff	1.3.6.1.4.1.20440.4.1.4.4.1 diEntry1	Indicates digital input 1 has been turned off.
	1.3.6.1.4.1.20440.4.1.4.4.2 diEntry2	Indicates digital input 2 has been turned off.
	1.3.6.1.4.1.20440.4.1.4.4.3 diEntry3	Indicates digital input 3 has been turned off.
	1.3.6.1.4.1.20440.4.1.4.4.4 diEntry4	Indicates digital input 4 has been turned off.
1.3.6.1.4.1.20440.4.1.6.13 trapPatliteSNMPGetMatched	1.3.6.1.4.1.20440.4.1.7.4 snmpGetMatchPatternNum	Indicates the condition specified in the SNMP monitoring condition settings (1 to 20) has been met.
1.3.6.1.4.1.20440.4.1.6.14 trapPatliteSNMPGetReleased	1.3.6.1.4.1.20440.4.1.7.4 snmpGetMatchPatternNum	Indicates the condition specified in the SNMP monitoring condition settings (1 to 20) has been released.
1.3.6.1.4.1.20440.4.1.6.15.1 diConditionMatch1	-	Indicates the condition specified in Digital Input Condition Setting 1 has been met.
1.3.6.1.4.1.20440.4.1.6.15.2 diConditionMatch2	-	Indicates the condition specified in Digital Input Condition Setting 2 has been met.
1.3.6.1.4.1.20440.4.1.6.15.3 diConditionMatch3	-	Indicates the condition specified in Digital Input Condition Setting 3 has been met.
1.3.6.1.4.1.20440.4.1.6.15.4 diConditionMatch4	-	Indicates the condition specified in Digital Input Condition Setting 4 has been met.
1.3.6.1.4.1.20440.4.1.6.16 trapPatliteSNMPGetChange	1.3.6.1.4.1.20440.4.1.7.5 snmpGetChangePatternNum	Indicates the change specified in the SNMP monitoring condition settings (1 to 4) has been detected.
1.3.6.1.4.1.20440.4.1.6.17 trapPatliteGroupAlarmAdded	1.3.6.1.4.1.20440.4.1.7.6 pingGroupPatternNum	Indicates a problem with the monitoring target group (1 to 3) specified by the ping monitoring group setting number.
1.3.6.1.4.1.20440.4.1.6.18 trapPatliteGroupAlarmRemoved	1.3.6.1.4.1.20440.4.1.7.6 pingGroupPatternNum	Indicates the monitoring target group (1 to 3) specified by the ping monitoring setting number has recovered from the problem.

TRAP Number	variable-bindings	Description
OID / Item Name	OID / Item Name	
1.3.6.1.4.1.20440.4.1.6.19 trapPatliteMailFilterMatch	1.3.6.1.4.1.20440.4.1.7.7 mailFilterNum	Indicates that mail with the conditions specified by the filter rule setting number (1 to 20) has been detected.
1.3.6.1.6.3.1.1.5.1 coldStart	-	Indicates this product has been restarted.

### 8.1.2. Setting Up Email Notification Settings

- Set to send an email notification when an event occurs.
- For information on each item, refer to "9.4.2. Email Notification Settings" (👉 page 288).

#### 8.1.2.1. Setup Procedure

##### ● Set up the Mail Server and Transmission Content

**1** From the [Notification setting] tab, click [Email Notification] to enter the [Server Connection Settings] screen.

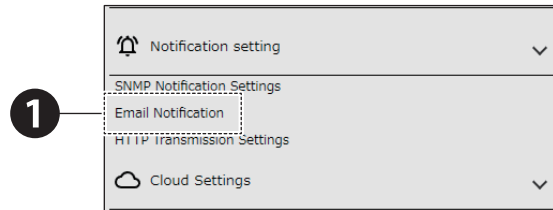

**2** Set the [SMTP Server Address], [SMTP Server Port], [How to Authenticate SMTP], [Authentication method], [Encryption Method], [SMTP Account Name], and [SMTP Password].

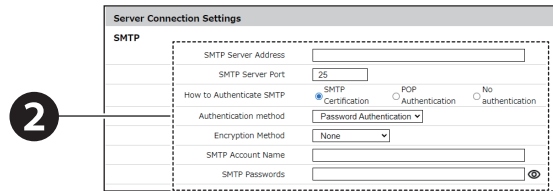

##### ■ When Using SMTP Certification

Select either [OAuth2] or [Password Authentication] for the Authentication method and set the [Encryption Method], [SMTP Account Name], and [SMTP Password]. Authentication methods [OAuth2] and [Password Authentication] are available only when the following address is specified as the SMTP Server Address. When any other server is specified, authentication is fixed as [Password Authentication].

- Gmail server: smtp.gmail.com
- Outlook server: smtp.office365.com

##### ■ When Connecting to Gmail\*1 \*2

Register the credential file in the [Credential] section. For information, refer to "● Preparation" (👉 page 124).

##### ■ When Connecting to Outlook\*1 \*2

Register the [Client ID], [Authorization Endpoint URL], and [Token Endpoint URL]. For information, refer to "● Preparation" (👉 page 124).

- \*1 As required, set [State] to [Enabled].
- \*2 Click the [Acquisition of authorization code] button, and from the authentication screen that pops up, get the authentication code. In the [Authorization code entry] field, enter the authentication code that you retrieved.

##### ■ When Using POP Authentication

Enter the [POP Server Address], [POP Server Port], [POP Account Name], and [POP Password].

##### ■ When Using No Authentication

Select [No authentication].

##### When Using SMTP Authentication

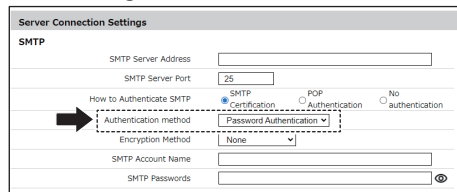

##### When Connecting to Gmail

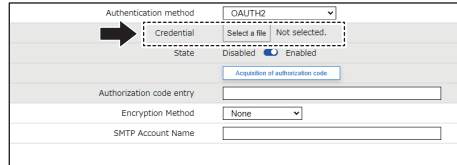

##### When Connecting to Outlook

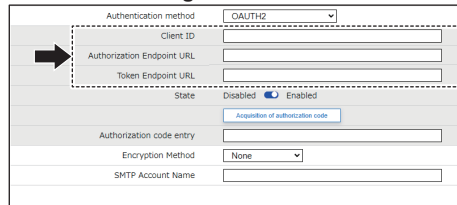

##### When Using POP Authentication

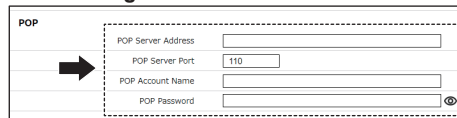

##### When Using No Authentication

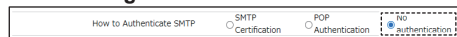



**3** In the [Transmission Settings] screen, register the [Sent-from e-mail address] and [Send-to address].

- Sent-from e-mail address: Sender email address
- Send-to address: Recipient email address

Transmission Settings	
Sent-from e-mail address	
1	
2	
3	
4	
5	
6	
7	
8	
Send-to address	
1	
2	
3	
4	
5	
6	
7	
8	

**4** In the [Email subject] screen, register the subject for the email.

- You can register up to 16 subjects.

Email subject	
1	
2	
3	
4	
5	
6	
7	
8	
9	
10	
11	
12	
13	
14	
15	
16	

**5** In the [Email body text settings], register the body text of the message.

- You can register up to 16 body text messages.

Email body text settings	
1	
2	
3	
4	
5	
6	
7	
8	
9	
10	
11	
12	
13	
14	
15	
16	

**6** Click [Set] to apply the defined settings.

### ● Setting Up Triggers for Email Notifications

**1** Set [Send email] to [Enabled] in each operation setting screen such as Monitoring Settings and Main unit operation settings.

Send email	Disabled	Enabled
SNMP Notification	Disabled	Enabled
Send HTTP Command	Disabled	Enabled
Send MQTT	Disabled	Enabled
Contact output 1	No change	
Contact output 2	No change	

**2** Click [Set] to apply the defined settings.

## ● Preparation

- To use OAuth2 as the Authentication method for sent email, some preparations need to be made.
- This product supports Gmail and Outlook OAuth2.

### Gmail

For setup instructions, refer to the documentation provided by Google.

**1**

Access the Google Cloud Platform.

**2**

Create a project for this product.

**3**

Activate the Gmail API in the project you created.

**4**

Set up the OAuth consent screen.

Specify the scope as [https://mail.google.com/ (Read, compose, send, and permanently delete all your email from Gmail)].

**5**

Create authentication information.

- For authentication information, create an [OAuth client ID].
- For application, create a [Desktop app].

**6**

Download the credentials file (JSON file).

### Outlook

For setup instructions, refer to the documentation provided by Microsoft.

**1**

From the [Microsoft Azure] website, access [Azure Active Directory].

**2**

Register the application on this product.

- For the redirect URI, set the application type to [Public client/native (mobile & desktop)] and the URL to https://login.microsoftonline.com/common/oauth2/nativeclient.

**3**

Add access permissions to the application you created.

For access permissions specify [IMAP.AccessAsUser.ALL], [POP.AccessAsUser.All], [SMTP.Send], and [offline\_access].

**4**

Refrain from using [Application (client) ID], [Authorization endpoint], and [Token endpoint on the registered application].

### 8.1.3. Setting Up HTTP Command Sending Settings

- Use this setting to send HTTP Commands when an event occurs.
- For information on each item, refer to "9.4.3. HTTP Transmission Settings" (☞ page 294).

#### 8.1.3.1. Setting Up Content of Send HTTP Command

**1** From the [Notification setting] tab, click [HTTP Transmission Settings] to enter the [HTTP Transmission Settings] screen.

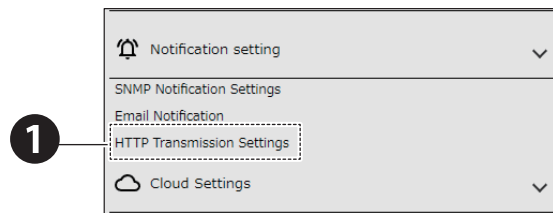

**2** In the [HTTP Command Destination] screen, register the HTTP name, command, and timeout you want to send in fields 1 to 8.

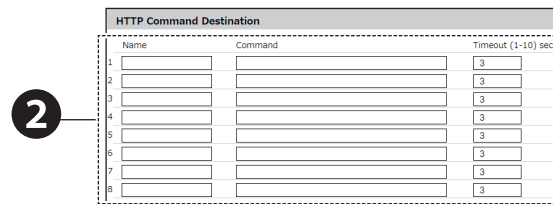

- Name: Name of HTTP Command
- Command: HTTP Command to send
- Timeout: Timeout period for the HTTP Command

**3** Click [Set] to apply the defined settings.

\* If you send the HTTP command to either NHB or NHV series, HTTP Command Receiving Function must be configured. Refer to "● Using HTTP Commands" (☞ page 159).

#### 8.1.3.2. Setting Up Triggers for Send HTTP Command

**1** Set [Send HTTP Command] to [Enabled] in each operation setting screen such as Monitoring Settings and Main unit operation settings.

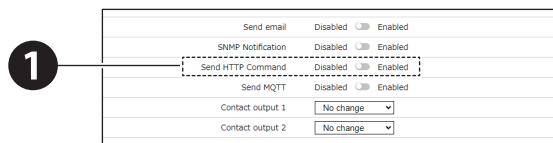

**2** Click [Set] to apply the defined settings.

### 8.1.3.3. Setting Up State Change Transmissions

Follow the steps below to set up transmissions on changes in state.

**1** From the [Main unit settings] tab, click [Enable Feature] to enter the [Main unit function settings] screen.

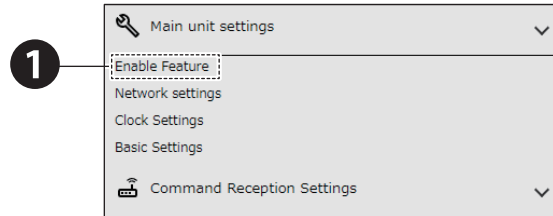

**2** In the [Main unit function settings] screen, set [Transmission of change information] to [Enabled].

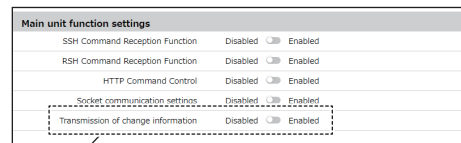

**3** Click [Set] to apply the defined settings.

**4** From the [Notification setting] tab, click [HTTP Transmission Settings] to enter the [HTTP Transmission Settings] screen.

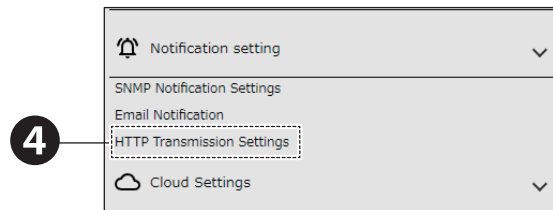

**5** In [Destination to send change information], register the name, destination address, and timeout where change information is sent.

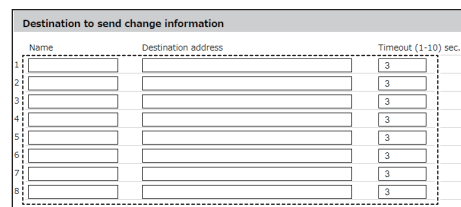

- Name: Name of destination
- Destination address: Address to send  
Specify the protocol such as "http://" or "https://" in Destination address.
- Timeout: Timeout period for the change information

**6** Click [Set] to apply the defined settings.

\* If you send the HTTP command to either NHB or NHV series, HTTP Command Receiving Function must be configured. Refer to "● Using HTTP Commands" (📄 page 159).

### 8.1.4. Setting Up Contact Output Settings

NHV Series (D model)

- Set to emit a contact output when an event occurs.
- For information on each item, refer to "9.6.3. Contact Output Setting" (page 301).

#### 8.1.4.1. Setting Up Contact Output

**1** From the [Main unit operation settings] tab, click [Contact output setting] to enter the [Contact output setting] screen.

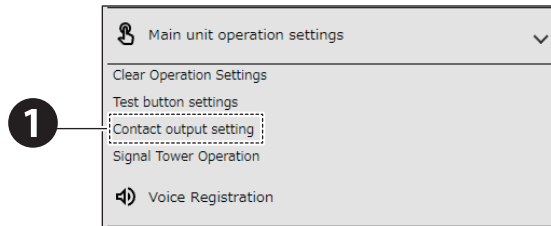

**2** In the [Contact output setting] screen, from [Port Selection] select the [Contact output].



**3** [Enabled] the selected contact output.

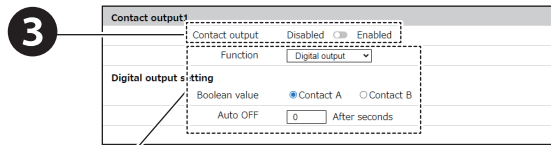

**4** In accordance with the environment in which the product will be used, set the [Function], [Boolean Value], and [Auto OFF] settings.



**5** Click [Set] to apply the defined settings.

#### 8.1.4.2. Setting Up Triggers for Contact Output

**1** Set contact output to [ON], [OFF], or [No change] in each operation setting screen such as Monitoring Settings and Main unit operation settings.

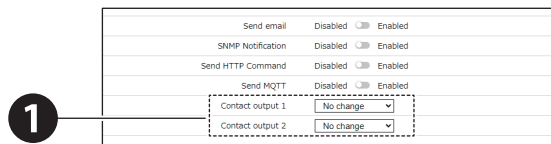

**2** Click [Set] to apply the defined settings.

## 8.2. Using the Cloud

- Use this setting when you want to connect the product to the cloud.
- For information on each item, refer to "9.5.1. Azure Connection Settings" (👉 page 295) and "9.5.2. AWS Connection Settings" (👉 page 297).

### 8.2.1. Using Microsoft Azure

To use Microsoft Azure, set the Microsoft Azure connection settings.

#### 8.2.1.1. Setting Up Azure

This product can connect to Azure IoT Central or Azure IoT Hub. To connect to one of these services, complete the procedure below.

##### ● Connecting to Azure IoT Central

For setup instructions, refer to the documentation provided by Microsoft.

- 1 From the Microsoft Azure website, access Azure IoT Central.
- 2 In Azure IoT Central, create an application.
- 3 In the management screen of the application created, get the [Scope ID], [Device ID], and [SAS Token (Primary Key)].

##### ● Connecting to Azure IoT Hub

For setup instructions, refer to the documentation provided by Microsoft.

- 1 From the Microsoft Azure website, access IoT Hub.
- 2 In IoT Hub, create an IoT Hub for connecting this product.
- 3 In the management screen of the IoT Hub created, create a device for this product.
- 4 From the management screen of the created device, get the connection string (primary connection string).

### 8.2.1.2. Setting Up Microsoft Azure Connection Settings

**1** In the Cloud Settings, click [Azure Connection Settings] to display the [Azure Connection Settings] screen.

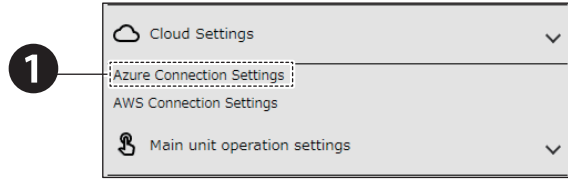

**2** Select the [Host], either [IoT Central] or [Azure IoT Hub].

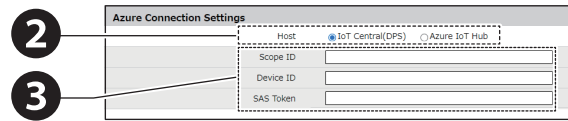

**3** Match the [Scope ID], [Device ID], [SAS Token], [Authentication method], [Connection String], [Host name], [Certificate], and [Client Private Key] with the connection destination.

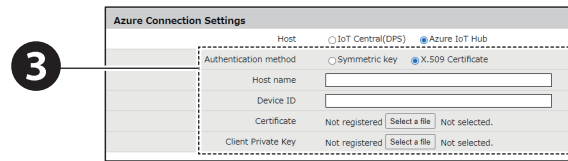
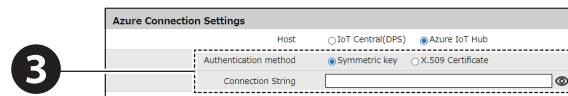

#### IoT Central

- |   |  |
|---|--|
| 1 | Enter the [Scope ID] and [Device ID].  |
| 2 | If the Authentication method is [Symmetric key], in [SAS Token] enter the Primary key.   |
| 3 | If the Authentication method is [X.509 Certificate], register the certificate. <ul style="list-style-type: none"> <li>• Provide your own X.509 certificate.</li> </ul> |

\* Get the [Scope ID], [Device ID], and [SAS Token (Primary Key)] values from the device connection on the Microsoft Azure IoT Central site.

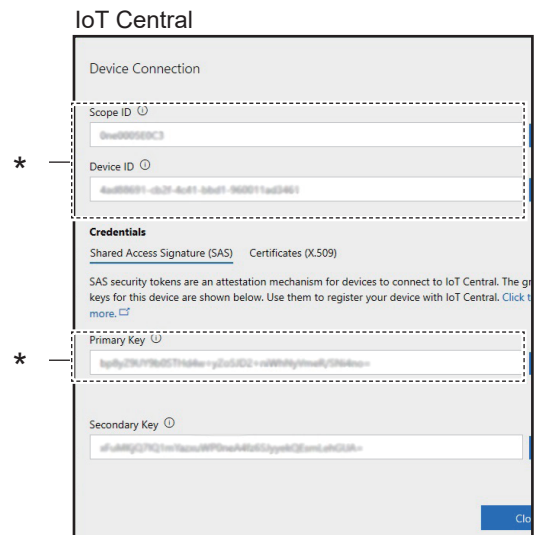

#### Azure IoT Hub

- |   |                              |
|---|------------------------------|
| 1 | Enter the connection string. |
|---|------------------------------|

\* Get the Device ID, Connection String, and Host name value from the Microsoft Azure IoT Hub site, Device ID, Primary Connection String, and Host name.

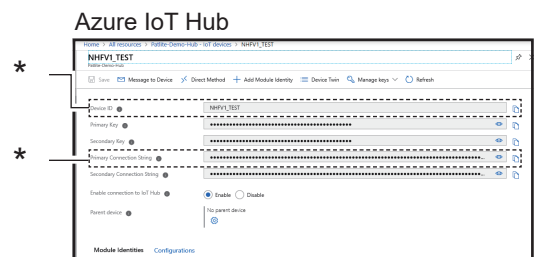

**4** Click [Set] to apply the defined settings.

### 8.2.1.3. Using Device Twin

- Using the Device Twin function, you can get the control and current status of this product. The information is shown in the table below.
- Do not control the buzzer output and audio channel playback at the same time.

Item	Field Name*				Setting ( ● : Yes –: No)				
	Azure IoT Hub		Azure IoT Central		NHB Series	NHV Series			
	Get Status	Control	Get Status	Control		(empty)	<input type="checkbox"/> Model	<input type="checkbox"/> Model	
LED Unit (Red)	led_red		led_red_c		●	●	●	●	
LED Unit (Amber)	led_yellow		led_yellow_c		●	●	●	●	
LED Unit (Green)	led_green		led_green_c		●	●	●	●	
LED Unit (Blue)	led_blue		led_blue_c		●	●	●	●	
LED Unit (White)	led_white		led_white_c		●	●	●	●	
Buzzer Output	buz_pattern		buz_pattern_c		●	●	●	●	
Audio Channel	sound_pattern		sound_pattern_c		–	●	●	●	
Digital Output 1	digital_output_1		digital_output_1_c		–	–	–	●	
Digital Output 2	digital_output_2		digital_output_2_c		–	–	–	●	
LED Unit (Multi color)	Colors	multi_led_color		multi_led_color_c		●	●	●	●
	Pattern	multi_led_pattern		multi_led_pattern_c		●	●	●	●

\* For information on the content of each field name, refer to " ● Device Twin Field Name List" ( ↗ page 131).

#### Example of Control

- Turn on the LED unit (Red) → {"led\_red":1}
- Turn off the LED unit (Red) and emit buzzer pattern 2 → {"led\_red":0, "buz\_pattern":2}



## ● Device Twin Field Name List

No.	Field Name*	Value		Description
1	led_red / led_red_c	0 / 1 / 2 / 3 / 4 / 5 / 9	[0]: Light off	Red LED Unit
2	led_yellow / led_yellow_c		[1]: Light on	Amber LED Unit
3	led_green / led_green_c		[2]: Flashing 1	Green LED Unit
4	led_blue / led_blue_c		[3]: Flashing 2	Blue LED Unit
5	led_white / led_white_c		[4]: Flashing 3	White LED Unit
			[5]: Flashing 4	
			[9]: No change	White LED Unit
6	multi_led_color / multi_led_color_c	1 / 2 / 3 / 4 / 5 / 6 / 7	[1]: Red [2]: Amber [3]: Green [4]: Blue [5]: White [6]: Purple [7]: Light blue	[Color] of Multi-color unit
7	multi_led_pattern / multi_led_pattern_c	0 / 1 / 2 / 3 / 4 / 5 / 9	[0]: Light off [1]: Light on [2]: Flashing 1 [3]: Flashing 2 [4]: Flashing 3 [5]: Flashing 4 [9]: No change	[Pattern] of Multi-color unit
8	buz_pattern / buz_pattern_c	0 / 1 / 2 / 3 / 4 / 5 / 9	[0]: Stop [1]: Pattern 1 [2]: Pattern 2 [3]: Pattern 3 [4]: Pattern 4 [5]: Pattern 5 [9]: No change	Buzzer Control
9	sound_pattern / sound_pattern_c	1 to 71	Channel 1 to 71	Audio Channel
10	digital_output_1 / digital_output_1_c	0 / 1	[0]: OFF	Digital Output 1
11	digital_output_2 / digital_output_2_c		[1]: ON	Digital Output 2

### Point

- Will not operate when invalid values are specified.

### 8.2.1.4. Using Direct Method

**⚠ CAUTION**

- ⊘ Do not specify alert, sound, and speech at the same time.
- ⚠ If the same instruction is executed multiple times, the instruction will not execute.
- ⚠ Environment-dependent characters such as "©" and "♠" and some symbols such as "¥" and "~" may not be synthesized correctly.

- You can control this product using the Direct Method.
- When performing control, enter method name "Method\_Control □" (□ : represents any character). Control instructions are shown in the table below.
- For multiple instructions, separate them with a comma ( , ). Instructions are executed in the order of priority (smallest value first), not in the order in which they are entered.
- To repeat, specify either "sound" or "speech" and "repeat".

Instruction	Field Name*	Priority	Setting (● : Yes - : No)			
			NHB Series	NHV Series		
				(empty)	<input type="checkbox"/> Model	<input type="checkbox"/> Model
Control LED unit and buzzer output	alert	1	●	●	●	●
Control LED unit	led	2	●	●	●	●
Control Multi-color unit	color	2	●	●	●	●
Control digital output	alert_do	2	-	-	-	●
Playback specified audio channel	sound	2	-	●	●	●
Play any text	speech	2	-	●	●	●
Repeat playback the specified number of times (Audio Channel)	repeat	3	-	●	●	●
Turn off all LED units, stop buzzer	clear	4	●	●	●	●

\* For information on the content of each field name, refer to "● Direct Method Field Name List" (👉 page 133).

**Example of Control 1**

- Control to turn on Red and Green LED units, to turn off Amber, Blue, and White LED units, and to emit buzzer pattern 2 → {"alert": "101002"}

**Example of Control 2**

- Endlessly play audio channel 1 → {"sound": "1", "repeat": "255"}

**Example of Control 3**

- Play voice "Problem identified" → {"speech": [{"text": "Problem identified", "lang": "jp", "voice": "female", "speed": "0", "tone": "0"}]}

## ● Direct Method Field Name List

No.	Field Name	Value	Description
1	alert	6 digits	<p>Controls Signal Tower lights and buzzer.</p> <ul style="list-style-type: none"> <li>Specify the pattern, in order of R (Red) → Y (Amber) → G (Green) → B (Blue) → C (White) → Z (buzzer).</li> <li>[RYGBC]: Light off [0], Light on [1], Flashing 1 [2], Flashing 2 [3], Flashing 3 [4], Flashing 4 [5], No change [9]</li> <li>[Z]: Mute [0], Buzzer pattern 1 [1], Buzzer pattern 2 [2], Buzzer pattern 3 [3], Buzzer pattern 4 [4], Buzzer pattern 5 [5], No change [9]</li> </ul>
2	led	5 digits	<p>Controls Signal Tower lights.</p> <ul style="list-style-type: none"> <li>Specify the pattern, in order of R (Red) → Y (Amber) → G (Green) → B (Blue) → C (White).</li> <li>[RYGBC]: Light off [0], Light on [1], Flashing 1 [2], Flashing 2 [3], Flashing 3 [4], Flashing 4 [5], No change [9]</li> </ul>
3	color	2 digits	<p>Controls Multi-color unit.</p> <ul style="list-style-type: none"> <li>Specify the pattern, in order of col (color) → pat (pattern).</li> <li>[col]: Red [1], Amber [2], Green [3], Blue [4], White [5], Purple [6], Light blue [7]</li> <li>[pat]: Light off [0], Light on [1], Flashing pattern 1 [2], Flashing pattern 2 [3], Flashing pattern 3 [4], Flashing pattern 4 [5], No change [9]</li> </ul>
4	alert_do	2 digits	<p>Controls digital output. Specify the pattern in order of digital output 1 → digital output 2.</p> <ul style="list-style-type: none"> <li>OFF [0]</li> <li>ON [1]</li> <li>No operation [9]</li> </ul>
5	sound	1 to 71	Plays the specified audio channel.
6	speech	–	<p>Plays back any text.</p> <p>By specifying additional parameters, you can adjust the audio that is played.</p> <ul style="list-style-type: none"> <li>text: Text to play, 0-50 characters</li> <li>lang: Japanese [jp] or English [en]</li> <li>voice: "male" or "female"</li> <li>speed: Voice speed, -5 to 5</li> <li>tone: Voice pitch, -5 to 5</li> </ul>
7	repeat*	0 to 255	Repeats playback of the audio channel specified in the sound command, the defined number of times.
8	clear	1	Turns off all the Signal Tower lights and stops playing the channel.

\* If the value is set to 255, playback is endless.

### Point

- Will not operate when invalid values are specified.

### 8.2.1.5. Using Device-to-cloud message

Use the device-to-cloud Message to notify changes in the state of this product.

No.	Field Name*	Description	Setting ( ● : Yes –: No)			
			NHB Series	NHV Series		
				(empty)	<input type="checkbox"/> Model	<input type="checkbox"/> Model
1	clear_button	Notification that clear button was pressed.	●	●	●	●
2	clear	Notification that clear operation was executed.	●	●	●	●
3	input_state_1	Notification that digital input 1 changed.	–	–	–	●
4	input_state_2	Notification that digital input 2 changed.	–	–	–	●
5	input_state_3	Notification that digital input 3 changed.	–	–	–	●
6	input_state_4	Notification that digital input 4 changed.	–	–	–	●
7	red_state	Notification that the Red LED changed.	●	●	●	●
8	yellow_state	Notification that the Amber LED changed.	●	●	●	●
9	green_state	Notification that the Green LED changed.	●	●	●	●
10	blue_state	Notification that the Blue LED changed.	●	●	●	●
11	white_state	Notification that the White LED changed.	●	●	●	●
12	multi_color_state	Notification that the multi-color has changed.	●	●	●	●
13	multi_pattern_state	Notification that the multi-color pattern changed.	●	●	●	●
14	buzzer_state	Notification that the buzzer changed.	●	●	●	●
15	sound_state	Notification that the audio channel changed.	–	●	●	●
16	output_state_1	Notification that digital output 1 changed.	–	–	–	●
17	output_state_2	Notification that digital output 2 changed.	–	–	–	●
18	alarm_Added	Notification that error is detected in ping monitoring.	●	●	●	●
19	alarm_Removed	Notification that recovery is detected in ping monitoring.	●	●	●	●
20	alarmgroup_Added	Notification that error is detected in ping group monitoring.	●	●	●	●
21	alarmgroup_Removed	Notification that recovery is detected in ping group monitoring.	●	●	●	●
22	trapreceive	Notification that TRAP is received.	●	●	●	●
23	snmpget_Added	Notification that condition is matched in SNMP device monitoring.	●	●	●	●
24	snmpget_Removed	Notification that condition is released in SNMP device monitoring.	●	●	●	●
25	snmpget_Change	Notification that condition is changed in SNMP device monitoring.	●	●	●	●

No.	Field Name*	Description	Setting (● : Yes - : No)			
			NHB Series	NHV Series		
				(empty)	<input type="checkbox"/> Model	<input type="checkbox"/> Model
26	input_cond_Change	Notification that condition is matched in digital input condition.	-	-	-	●
27	test	Notification that test button was pressed.	●	●	●	●
28	mail_Received	Notification that e-mail was received.	-	-	●	-

\* For information on the content of each field name, refer to "● Device-to-cloud message Field Name List" (page 136).

## ● Device-to-cloud message Field Name List

No.	Field Name*	Value	Description
1	clear_button	on	Notification that clear button was pressed.
2	clear	1	Notification that clear operation was executed.
3	input_state_1	on	Notification that digital input 1 turned ON.
		off	Notification that digital input 1 turned OFF.
4	input_state_2	on	Notification that digital input 2 turned ON.
		off	Notification that digital input 2 turned OFF.
5	input_state_3	on	Notification that digital input 3 turned ON.
		off	Notification that digital input 3 turned OFF.
6	input_state_4	on	Notification that digital input 4 turned ON.
		off	Notification that digital input 4 turned OFF.
7	red_state	0	Notification that the Red LED unit turned off.
		1	Notification that the Red LED unit turned on.
		2	Notification that the Red LED unit used flashing pattern 1.
		3	Notification that the Red LED unit used flashing pattern 2.
		4	Notification that the Red LED unit used flashing pattern 3.
		5	Notification that the Red LED unit used flashing pattern 4.
8	yellow_state	0, 1, 2, 3, 4, 5	Notification that the Amber LED unit changed. The value is the same as No.6 red_state.
9	green_state	0, 1, 2, 3, 4, 5	Notification that the Green LED unit changed. The value is the same as No.6 red_state.
10	blue_state	0, 1, 2, 3, 4, 5	Notification that the Blue LED unit changed. The value is the same as No.6 red_state.
11	white_state	0, 1, 2, 3, 4, 5	Notification that the White LED unit changed. The value is the same as No.6 red_state.
12	multi_color_state	0	Notification when the multi-color light turned off.
		1	Notification when Red on the multi-color light is in operation.
		2	Notification when Amber on the multi-color light is in operation.
		3	Notification when Green on the multi-color light is in operation.
		4	Notification when Blue on the multi-color light is in operation.
		5	Notification when White on the multi-color light is in operation.
		6	Notification when Purple on the multi-color light is in operation.
		7	Notification when Light blue on the multi-color light is in operation.

No.	Field Name*	Value	Description
13	multi_pattern_state	0	Notification when the multi-color light turned off.
		1	Notification when the multi-color light turned on.
		2	Notification when flashing pattern 1 on the multi-color light is in operation.
		3	Notification when flashing pattern 2 on the multi-color light is in operation.
		4	Notification when flashing pattern 3 on the multi-color light is in operation.
		5	Notification when flashing pattern 4 on the multi-color light is in operation.
14	buzzer_state	0	Notification that the buzzer stopped.
		1	Notification that buzzer used pattern 1.
		2	Notification that buzzer used pattern 2.
		3	Notification that buzzer used pattern 3.
		4	Notification that buzzer used pattern 4.
		5	Notification that the Red LED unit used flashing pattern 5.
15	sound_state	0 to 71	Notification that the audio channel changed.
16	output_state_1	on	Notification that digital output 1 turned ON.
		off	Notification that digital output 1 turned OFF.
17	output_state_2	on	Notification that digital output 2 turned ON.
		off	Notification that digital output 2 turned OFF.
18	alarm_Added	1 to 24	Notification that error is detected in ping monitoring.
19	alarm_Removed	1 to 24	Notification that recovery is detected in ping monitoring.
20	alarmgroup_Added	1 to 3	Notification that error is detected in ping group monitoring.
21	alarmgroup_Removed	1 to 3	Notification that recovery is detected in ping group monitoring.
22	trapreceive	1 to 16	Notification that TRAP is received.
23	snmpget_Added	1 to 20	Notification that condition is matched in SNMP device monitoring.
24	snmpget_Removed	1 to 20	Notification that condition is released in SNMP device monitoring.
25	snmpget_Change	1 to 5	Notification that condition is changed in SNMP device monitoring.
26	input_cond_Change	1 to 4	Notification that condition is matched in digital input condition.
27	test	1	Notification that test button was pressed.
28	mail_Received	1 to 20	Notification that e-mail was received.

### 8.2.1.6. Using Cloud-to-device message

- Using Cloud-to-device Message, you can control the product. Control instructions are shown in the table below.
- To repeat, specify both "sound" and "repeat" or both "text" and "repeat". When doing so, separate the commands with a comma ( , ).

Instruction	Field Name*	Setting ( ● : Yes –: No)			
		NHB Series	NHV Series		
			(empty)	<input type="checkbox"/> Model	<input type="checkbox"/> Model
Control LED unit and buzzer output	alert	●	●	●	●
Control LED unit	led	●	●	●	●
Control Multi-color unit	color	●	●	●	●
Control digital output	alert_do	–	–	–	●
Turn off all LED units, stop buzzer	clear	●	●	●	●
Playback specified audio channel	sound	–	●	●	●
Set text playing in the voice synthesizer	text	–	●	●	●
Specify language playing in voice synthesizer	lang	–	●	●	●
Specify voice playing in voice synthesizer	voice	–	●	●	●
Specify speed playing in voice synthesizer	speed	–	●	●	●
Specify tone playing in voice synthesizer	tone	–	●	●	●
Repeat playback the specified number of times (Audio Channel)	repeat	–	●	●	●

\* For information on the content of each field name, refer to "● Cloud-to-device message Field Name List" ( page 139).

#### Example of Control 1

- Control to turn Red LED unit on, to set Amber LED unit with flashing pattern 1, no change for Green, Blue, and White LED units, and to emit buzzer pattern 3 → alert=129993

#### Example of Control 2

- Play audio channel 2 twice → sound=2,repeat=1

#### Example of Control 3

- Play "Problem identified" in voice synthesizer → text=Problem identified,lang=jp,voice=female,speed=0,tone=0



## ● Cloud-to-device message Field Name List

No.	Field Name	Value	Description
1	alert	6 digits	Controls Signal Tower lights and buzzer. <ul style="list-style-type: none"> <li>Specify the pattern, in order of R (Red) → Y (Amber) → G (Green) → B (Blue) → C (White) → Z (buzzer).</li> <li>[RYGBC]: Light off [0], Light on [1], Flashing 1 [2], Flashing 2 [3], Flashing 3 [4], Flashing 4 [5], No change [9]</li> <li>[Z]: Mute [0], Buzzer pattern 1 [1], Buzzer pattern 2 [2], Buzzer pattern 3 [3], Buzzer pattern 4 [4], Buzzer pattern 5 [5], No change [9]</li> </ul>
2	led	5 digits	Controls Signal Tower lights. <ul style="list-style-type: none"> <li>Specify the pattern, in order of R (Red) → Y (Amber) → G (Green) → B (Blue) → C (White).</li> <li>[RYGBC]: Light off [0], Light on [1], Flashing 1 [2], Flashing 2 [3], Flashing 3 [4], Flashing 4 [5], No change [9]</li> </ul>
3	color	2 digits	Controls Multi-color unit. <ul style="list-style-type: none"> <li>Specify the pattern, in order of col (color) → pat (pattern).</li> <li>[col]: Red [1], Amber [2], Green [3], Blue [4], White [5], Purple [6], Light blue [7]</li> <li>[pat]: Light off [0], Light on [1], Flashing pattern 1 [2], Flashing pattern 2 [3], Flashing pattern 3 [4], Flashing pattern 4 [5], No change [9]</li> </ul>
4	alert_do	2 digits	Controls digital output. Specify the pattern in order of digital output 1 → digital output 2. <ul style="list-style-type: none"> <li>OFF [0], ON [1], No operation [9]</li> </ul>
5	clear	1	Turns off all the Signal Tower lights and stops playing the channel.
6	sound	1 to 71	Plays the specified audio channel.
7	text	-	Set text playing in the voice synthesizer. Text can be set 50 characters.
8	lang	jp,en	Specify language playing in voice synthesizer. This field is used as an additional field for the text field.
9	voice	male, female	Specify voice playing in voice synthesizer. This field is used as an additional field for the text field.
10	speed	-5 to 5	Specify speed playing in voice synthesizer. This field is used as an additional field for the text field.
11	tone	-5 to 5	Specify tone playing in voice synthesizer. This field is used as an additional field for the text field.
7	repeat*	0 to 255	Repeats playback of the audio channel specified in the sound command, the defined number of times.

\* If the value is set to 255, playback is endless.

### Point

- Will not operate when invalid values are specified.
- Environment-dependent characters such as "©" and "♠" and some symbols such as "¥" and "~" may not be synthesized correctly.

## 8.2.2. Using AWS

To use AWS, AWS settings and AWS connection settings must be configured.

### 8.2.2.1. Setting Up AWS

**⚠ CAUTION**

- !** Refer to the following document and set up an AWS account.  
<https://docs.aws.amazon.com/iot/latest/developerguide/setting-up.html>
- ⚠** This instruction manual assumes that the following are configured.
  - Sign up for an AWS account
  - Create a user and grant access permissions
  - Open the AWS IoT console

#### ● Create a Policy

Create a policy for NHB/NHV to connect to AWS IoT Core.

- 1** In the AWS IoT console, from the navigation panel click [Secure].
- 2** Click [Policies].
- 3** Click [Create a policy].
- 4** Click [Advanced mode].

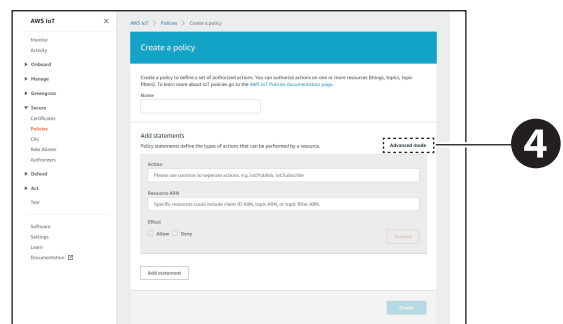
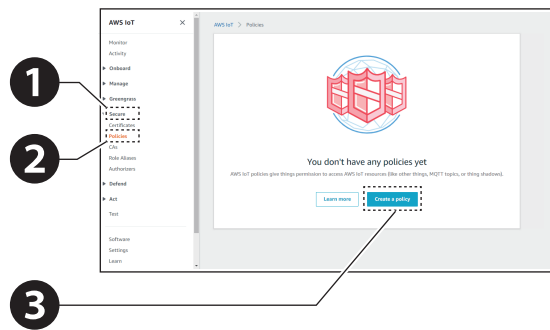

**5** Enter a name.

**6** Enter the policy.

**Example Policy Entry**

```
{
  "Version": "2012-10-17",
  "Statement": [
    {
      "Effect": "Allow",
      "Action": "iot:*",
      "Resource": "*"
    }
  ]
}
```

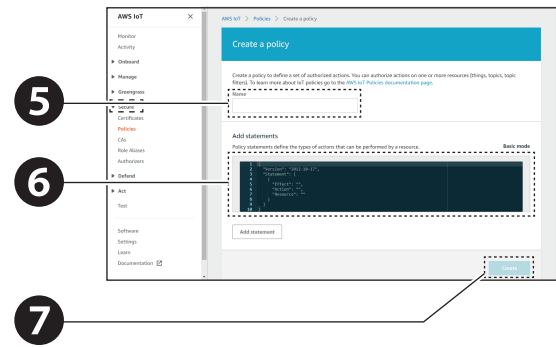

- All devices in the fleet must have credentials that allow them to authorize only intended actions. This includes AWS IoT MQTT actions such as publishing messages, subscribing to topics, and so on. As permission policies vary depending on your environment, create a policy that best fits your business and security requirements.

- <https://docs.aws.amazon.com/iot/latest/developerguide/example-iot-policies.html>
- <https://docs.aws.amazon.com/iot/latest/developerguide/security-bestpractices.html>

**7** Click [Create a policy].

### ● Create Things and Certificates

When creating a thing in the AWS IoT console, follow the steps below to save the [Device certificate], [Private key], and [Root CA certificate].

**1** In the AWS IoT console, from the navigation panel click [Manage].

**2** Click [Things].

**3** Click [Create things].

**4** From the [Create things] screen, click [Create single thing] - [Next].

**5** In the [Specify thing properties] screen, enter the thing's name and click [Next].

- \* The thing name entered here is used as the client ID. The client ID is used by the Device Shadow function.
- "9.5.2. AWS Connection Settings" (  page 297)
- When using Device Shadow, select the [Unnamed shadow].

**6** In the [Configure device certificate] screen, select [Auto-generate a new certificate] and click [Next].

**7** Select the policy to attach to the certificate.

**8** Click [Create thing].

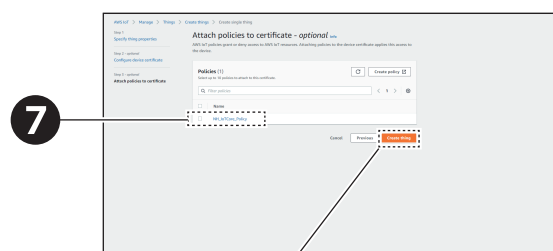
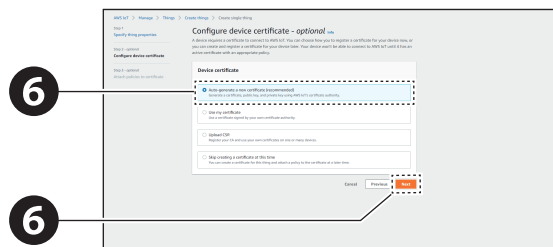
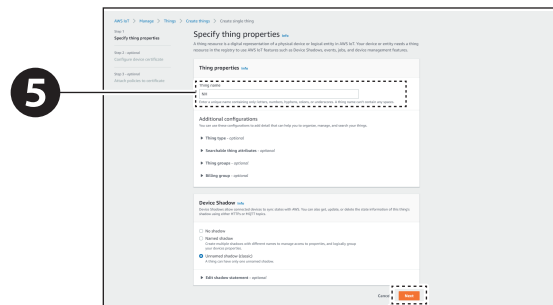
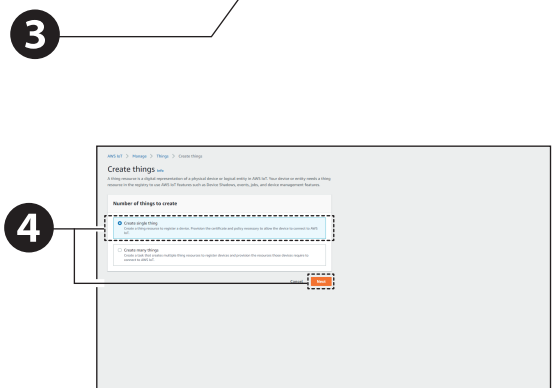
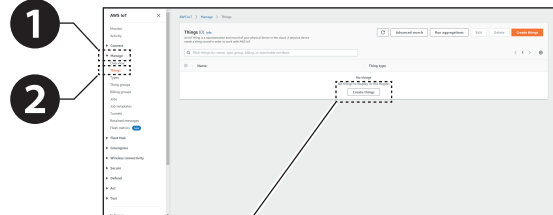

**9** For each item click [Download] to download a [Device certificate], [Public key], [Private key], and [Root CA certificate].

- For [Root CA certificate], download [RSA 2048-bit Key: Amazon Root CA 1].
- Save [Public key] if required.

**10** Click [Done].

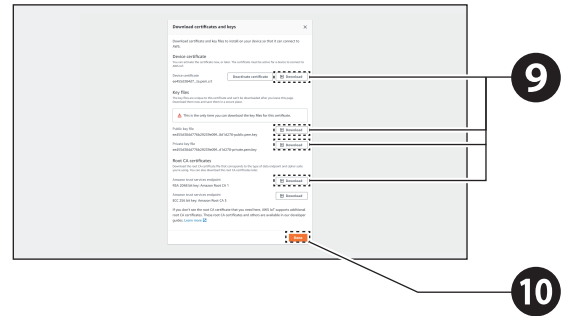

### 8.2.2.2. Setting Up the AWS Connection

**1** From [Cloud Settings], click [AWS Connection Settings] to display the [AWS Connection Settings] screen.

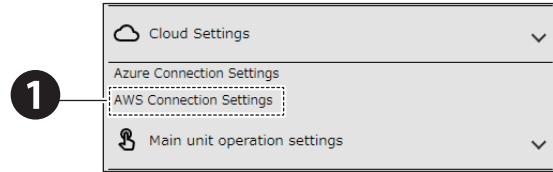

**2** Enter the [Host], [Port number], [Client ID], [Subscribe Topics], and [Publish Topics].

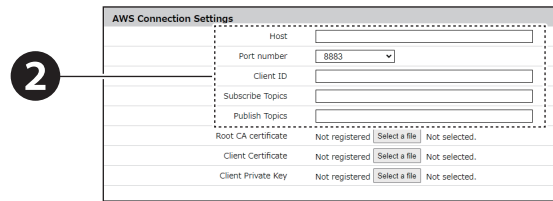

\* Enter values to each item as follows.

Item	Value to enter
Host	Device data endpoint value obtained from the AWS IoT Console
Client ID	"● Create Things and Certificates" (page 142) for instructions on creating thing name
Subscribe Topics	Topic subscribed by this product. For example, "NHV/SUBSCRIBE"
Publish Topics	Topic published by this product. For example, "NHV/PUBLISH"

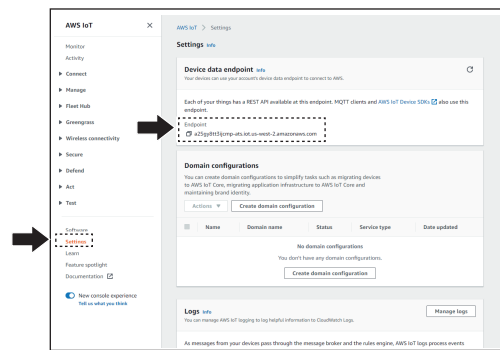

\* Access the AWS IoT console. In the [console.aws.amazon.com/iot](https://console.aws.amazon.com/iot) navigation panel, click [Settings]. In the [Host] field, enter the value of the [Endpoint] shown at the bottom of [Device data endpoint] area.

**3** Click [Select a file] and select the certificate to register.

\* Certificate that was downloaded in "8.2.2.1. Setting Up AWS" (page 140). For each of the following items, select and upload a certificate.

Item	Value to enter
Root CA certificate	Root CA certificate
Client Certificate	Device certificate
Client Private Key	Private Key

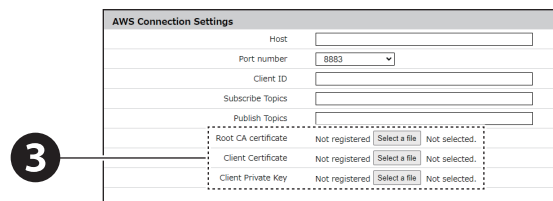

\* If the certificate has been uploaded, "Registration" is displayed in the field.

**4** Click [Set] to apply the defined settings.

### 8.2.2.3. Checking Connection with AWS IoT Core

Use the test function to verify NHV is connected to the AWS IoT Core. Follow the steps below to verify control on the LED unit.

**1** In the AWS IoT console's navigation panel, click [Test] - [MQTT test client].

**2** The [MQTT test client] screen is displayed.

**3** Enter the subscribe topic set in "8.2.2.2. Setting Up the AWS Connection" (👉 page 144).

**4** Enter control command.

```
Example Control Command Input
{
  "alert": "123094"
}
```

**5** Click [Publish] to publish the message.

**6** Check the status of the NHB/NHV.

If the above example control command is issued and the NHB/NHV status changes as shown below, the connection is successfully established.

**NHB/NHV Status**

- Red LED unit: Light on
- Amber LED unit: Flashing pattern 1
- Green LED unit: Flashing pattern 2
- Blue LED unit: Light off
- White LED unit: No change
- Buzzer: Buzzer pattern 4

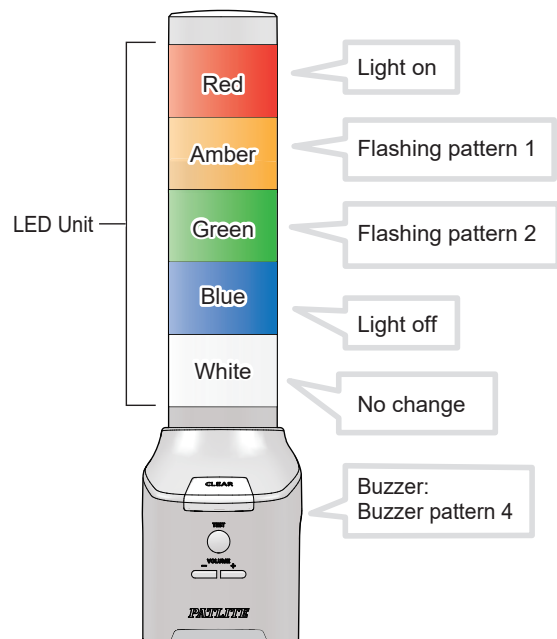
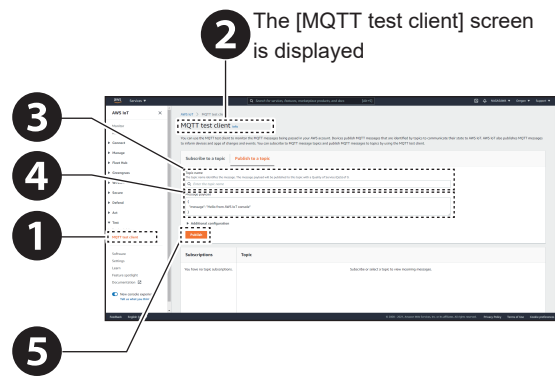

### 8.2.2.4. Using MQTT Subscribe Function

- You can control this product by issuing messages to topics subscribed (Subscribe topic) by the product. Information you can control is shown in the table below.
- For multiple instructions, separate them with a comma ( , ). Instructions are executed in the order of priority (smallest value first), not in the order in which they are entered.

**Input Example** Turn Red LED unit on and play audio channel 30 one time

```
{
  "led_red": "1",
  "sound_pattern": "30",
  "repeat": "1"
}
```

Item	Field Name*	Priority	Setting ( ● : Yes –: No)			
			NHB Series	NHV Series		
				(empty)	<input type="checkbox"/> Model	<input type="checkbox"/> Model
LED Unit and Buzzer	alert	1	●	●	●	●
LED Unit	led	2	●	●	●	●
LED Unit (Red)	led_red	2	●	●	●	●
LED Unit (Amber)	led_yellow	2	●	●	●	●
LED Unit (Green)	led_green	2	●	●	●	●
LED Unit (Blue)	led_blue	2	●	●	●	●
LED Unit (White)	led_white	2	●	●	●	●
Multi-color unit	color	2	●	●	●	●
Buzzer Output	buz_pattern	2	●	●	●	●
Audio Channel Playback	sound_pattern	2	–	●	●	●
Digital Output 1	digital_output1	2	–	–	–	●
Digital Output 2	digital_output2	2	–	–	–	●
Play any text	speech	2	–	●	●	●
Repeat	repeat	3	–	●	●	●
Clear	clear	4	●	●	●	●

\* For information on the content of each field, refer to " ● MQTT Subscribe Function - Field Name List" ( page 147).

**Point**

- To repeat, specify either the audio channel playback or play any text and specify repeat.
- Do not control the buzzer, speech, and audio channel playback at the same time.
- If the same instruction is executed multiple times, the instruction will not execute.
- Set the subscribe topic for this product, with "9.5.2. AWS Connection Settings" ( page 297) as a reference.
- When Subscribe topics are not set up, this function does not operate.



● MQTT Subscribe Function - Field Name List

No.	Field Name	Data Type	Value	Description
1	alert	string	Specify pattern in order R (Red) → Y (Amber) → G (Green) → B (Blue) → C (White) → Z (buzzer). <b>[RYGBC]</b> [0]: Light off, [1]: Light on, [2]: Flashing 1, [3]: Flashing 2, [4]: Flashing 3, [5]: Flashing 4, [9]: No change <b>[Z]</b> [0]: Mute, [1]: Buzzer pattern 1, [2]: Buzzer pattern 2, [3]: Buzzer pattern 3, [4]: Buzzer pattern 4, [5]: Buzzer pattern 5, [9]: No change	Controls Signal Tower lights and buzzer with a 6-digit string.  Example, "alert": "123094" Red LED unit on, Amber LED unit flashing pattern 1, Green LED unit flashing pattern 2, Blue LED unit off, White LED unit no change, Buzzer pattern 4
2	led		Specify the pattern, in order of R (Red) → Y (Amber) → G (Green) → B (Blue) → C (White). <b>[RYGBC]</b> [0]: Light off, [1]: Light on, [2]: Flashing 1, [3]: Flashing 2, [4]: Flashing 3, [5]: Flashing 4, [9]: No change	Signal Tower is controlled using a 5 character string.  Example, "led": "10013" Red LED unit on, Amber LED unit off, Green LED unit off, Blue LED unit on, White LED unit flashing pattern 2
3	led_red		[0]: Light off, [1]: Light on, [2]: Flashing 1, [3]: Flashing 2, [4]: Flashing 3, [5]: Flashing 4, [9]: No change	Controls the Red LED unit.
4	led_yellow			Controls the Amber LED unit.
5	led_green			Controls the Green LED unit.
6	led_blue			Controls the Blue LED unit.
7	led_white			Controls the White LED unit.
8	color		2 digits	Controls Multi-color unit. <ul style="list-style-type: none"> <li>Control the pattern, in order of col (color) → pat (pattern).</li> <li>[col]: Red [1], Amber [2], Green [3], Blue [4], White [5], Purple [6], Light blue [7]</li> <li>[pat]: Light off [0], Light on [1], Flashing pattern 1 [2], Flashing pattern 2 [3], Flashing pattern 3 [4], Flashing pattern 4 [5], No change [9]</li> </ul>
9	buz_pattern		[0]: Stop, [1]: Pattern 1, [2]: Pattern 2, [3]: Pattern 3, [4]: Pattern 4, [5]: Pattern 5, [9]: No change	Controls the buzzer.
10	sound_pattern		[0]: Stop [1] to [71]: Channel number	Plays the specified audio channel.
11	repeat*		[0] to [255]: Number of times to repeat	Specifies the number of times to repeat the audio.
12	digital_output1		[0]: OFF [1]: ON	Controls digital output 1.
13	digital_output2		[9]: No change	Controls digital output 2.
14	clear		[1]: Execute clear	Turns off all the Signal Tower lights and stops playing the channel.

No.	Field Name	Data Type	Value	Description
15	speech	array / string	-	Plays back any text. By specifying additional parameters, you can adjust the audio that is played. text: Text to play, 0 to 50 characters lang: Japanese [jp], English [en] voice: "male" or "female" speed: Voice speed, -5 to 5 tone: Voice pitch, -5 to 5

\* If the value is set to "255", playback is endless.

#### Point

- Will not operate when invalid values are specified.
- Do not control the buzzer, audio channel playback, and text playback (speech) at the same time.
- Environment-dependent characters such as "©" and "♠" and some symbols such as "¥" and "~" may not be synthesized correctly.

#### Input Example When the Red LED unit is on and the voice synthesizer plays "Problem identified"

```
{
  "led_red": "1",
  "speech": [
    {
      "text": "Problem identified",
      "lang": "en",
      "voice": "female",
      "speed": "0",
      "tone": "0"
    }
  ]
}
```

### 8.2.2.5. Using MQTT Publish Function

The change information for this product is sent to the defined topic (Publish topic).

The change information you can send is as shown in the table below.

Item	Field Name*	Setting (● : Yes –: No)			
		NHB Series	NHV Series		
			(empty)	<input type="checkbox"/> Model	<input type="checkbox"/> Model
LED Unit (Red)	led_red	●	●	●	●
LED Unit (Amber)	led_yellow	●	●	●	●
LED Unit (Green)	led_green	●	●	●	●
LED Unit (Blue)	led_blue	●	●	●	●
LED Unit (White)	led_white	●	●	●	●
Multi-color unit	multi_led_color	●	●	●	●
	multi_led_pattern	●	●	●	●
Buzzer Output	buz_pattern	●	●	●	●
Audio Channel Playback	sound_pattern	–	●	●	●
Digital Output	digital_output1 - 2	–	–	–	●
Pressing Clear Button / Executing Clear Operation	clear	●	●	●	●
Digital Input	digital_input1 - 4	–	–	–	●
Ping Monitoring Error	alarm_Added	●	●	●	●
Ping Monitoring Recovery	alarm_Removed	●	●	●	●
Ping Group Monitoring Error	alarmgroup_Added	●	●	●	●
Ping Group Monitoring Recovery	alarmgroup_Removed	●	●	●	●
TRAP Receiving	trapreceive	●	●	●	●
SNMP Device Monitoring - Match Detection	snmpget_Added	●	●	●	●
SNMP Device Monitoring - Release Detection	snmpget_Removed	●	●	●	●
SNMP Device Monitoring - Change Detection	snmpget_Change	●	●	●	●
Digital Input Condition	input_cond_Change	–	–	–	●
Pressing Test Button	test	●	●	●	●
E-mail Receiving	mail_Received	–	–	●	–

Item	Field Name*	Setting ( ● : Yes - : No)			
		NHB Series	NHV Series		
			(empty)	<input type="checkbox"/> Model	<input type="checkbox"/> Model
Client ID	client_id	●	●	●	●
Publish Topic	topic_name	●	●	●	●

\* For information on the content of each field, refer to " ● MQTT Publish Function - Field Name List" (  page 151).

**Point**

- Set the publish topic for this product, with "9.5.2. AWS Connection Settings" (  page 297) as a reference.
- When Publish topics are not set up, this function does not operate.
- Sends the current status of changed items only.

● MQTT Publish Function - Field Name List

No.	Field Name	Data Type	Value	Description
1	client_id*	string	Setup Value	<ul style="list-style-type: none"> <li>• Notification of client ID value.</li> <li>• Notification of the value as set in the Amazon Web Services (AWS) Connection Settings Screen.</li> </ul>
2	topic_name*		Setup Value	<ul style="list-style-type: none"> <li>• Notification of Publish topic value.</li> <li>• Notification of the value as set in the Amazon Web Services (AWS) Connection Settings Screen.</li> </ul>
3	led_red		[0]: Light off	Notification of the Red LED unit status.
4	led_yellow		[1]: Light on	Notification of the Amber LED unit status.
5	led_green		[2]: Flashing 1	Notification of the Green LED unit status.
6	led_blue		[3]: Flashing 2	Notification of the Blue LED unit status.
7	led_white		[4]: Flashing 3 [5]: Flashing 4	Notification of the White LED unit status.
8	multi_led_color		[1]: Red, [2]: Amber, [3]: Green, [4]: Blue, [5]: White, [6]: Purple, [7]: Light blue	Notification of the Multi-color unit's color state.
9	multi_led_pattern		[0]: Light off, [1]: Light on, [2]: Flashing pattern 1, [3]: Flashing pattern 2, [4]: Flashing pattern 3, [5]: Flashing pattern 4	Notification of the Multi-color unit's pattern state.
10	buz_pattern		[0]: Stop, [1]: Pattern 1, [2]: Pattern 2, [3]: Pattern 3 [4]: Pattern 4, [5]: Pattern 5	Notification of the buzzer status.
11	sound_pattern		[0]: Stop [1] to [71]: Channel number	Notification of the audio channel status.
12	digital_output1		[0]: OFF [1]: ON	Notification of the digital output 1 status.
13	digital_output2			Notification of the digital output 2 status.
14	digital_input1			Notification of the digital input status.
15	digital_input2			
16	digital_input3			
17	digital_input4			
18	clear		[1]: Press clear button / Execute clear operation	Notification that clear button was pressed or clear operation was executed.
19	alarm_Added		[1] to [24]: Ping monitoring setting number	Notification that error is detected in ping monitoring.
20	alarm_Removed			Notification that recovery is detected in ping monitoring.
21	alarmgroup_Added		[1] to [3]: Ping group monitoring setting number	Notification that error is detected in ping group monitoring.
22	alarmgroup_Removed			Notification that recovery is detected in ping group monitoring.

No.	Field Name	Data Type	Value	Description
23	trapreceive	string	[1] to [16]: TRAP receiving setting number	Notification that TRAP is received.
24	snmpget_Added		[1] to [20]: Match detection setting number of SNMP device monitoring	Notification that condition is matched in SNMP device monitoring.
25	snmpget_Removed		[1] to [20]: Match detection setting number of SNMP device monitoring	Notification that condition is released in SNMP device monitoring.
26	snmpget_Change		[1] to [5]: Change detection setting number of SNMP device monitoring	Notification that condition is changed in SNMP device monitoring.
27	input_cond_Change		[1] to [20]: Match detection setting number of Digital Input Condition	Notification that condition is matched in digital input condition.
28	test		[1]: Press test button	Notification that test button was pressed.
29	mail_Received		[1] to [20]: Mail detection setting number	Notification that e-mail was received.

\* "client\_id" and "topic\_name" are always included at the start of the message.

**Input Example** When turn on Amber LED unit, emit buzzer pattern 1

```
{
  "client_id": "NH",
  "topic_name": "NH/Publish",
  "led_yellow": "1",
  "buzzer_pattern": "1"
}
```

### 8.2.2.6. Using Device Shadow Function

Using the Device Shadow function, you can get the control and current status information for this product.

The control and status information you can get is shown in the table below.

Item	Field Name*	Setting ( ● : Yes –: No)			
		NHB Series	NHV Series		
			(empty)	<input type="checkbox"/> Model	<input type="checkbox"/> Model
LED Unit (Red)	led_red	●	●	●	●
LED Unit (Amber)	led_yellow	●	●	●	●
LED Unit (Green)	led_green	●	●	●	●
LED Unit (Blue)	led_blue	●	●	●	●
LED Unit (White)	led_white	●	●	●	●
Multi-color unit	multi_led_color	●	●	●	●
	multi_led_pattern	●	●	●	●
Buzzer Output	buz_pattern	●	●	●	●
Audio Channel Playback	sound_pattern	–	●	●	●
Digital Output	digital_output1 - 2	–	–	–	●

\* For information on the content of each field, refer to " ● Device Shadow Function - Field Name List" (  page 154).

#### Point

- Do not control the buzzer, audio channel playback, and voice synthesizer at the same time.
- If the same instruction is executed multiple times, the instruction will not execute.
- When client ID is not set up, this function does not operate.

● **Device Shadow Function - Field Name List**

No.	Field Name	Data Type	Value	Description
1	led_red	integer	[0]: Light off	Red LED Unit
2	led_yellow		[1]: Light on	Amber LED Unit
3	led_green		[2]: Flashing 1	Green LED Unit
4	led_blue		[3]: Flashing 2	Blue LED Unit
5	led_white		[4]: Flashing 3	White LED Unit
			[5]: Flashing 4	
			[9]: No change	
6	multi_led_color		[1]: Red, [2]: Amber, [3]: Green, [4]: Blue, [5]: White, [6]: Purple, [7]: Light blue	[Color] of Multi-color unit
7	multi_led_pattern		[0]: Light off, [1]: Light on, [2]: Flashing pattern 1, [3]: Flashing pattern 2, [4]: Flashing pattern 3, [5]: Flashing pattern 4	[Pattern] of Multi-color unit
8	buz_pattern		[0]: Stop, [1]: Pattern 1 [2]: Pattern 2, [3]: Pattern 3, [4]: Pattern 4, [5]: Pattern 5, [9]: No change	Buzzer Control
9	sound_pattern	[0]: Stop [1] to [71]: Channel number	Audio Channel	
10	digital_output1 - 2	[0]: OFF [1]: ON [9]: No change	Digital Output	

**Point**

- Will not operate when invalid values are specified.

**Input Example 1** When notifying Green LED unit is on and audio channel 50 is playing

```
"state": {
  "reported": {
    "led_red": 0,
    "led_yellow": 0,
    "led_green": 1,
    "led_blue": 0,
    "led_white": 0,
    "multi_led_color": 0,
    "multi_led_pattern": 0,
    "buz_pattern": 0,
    "sound_pattern": 50,
    "digital_output1": 0
    "digital_output2": 0
  }
}
```

**Input Example 2** When controlling audio channel to stop playing and digital output 1 to turn ON

```
"state": {
  "desired": {
    "sound_pattern": 0,
    "digital_output1": 1
  }
}
```



## 8.3. Checking and Controlling the Status of This Product

### 8.3.1. Checking and Controlling the Status of This Product with Commands

- You can check and control the status of this product using "RSH Command", "SSH Command", "SNMP Command", "HTTP Command", "PNS Command", and "PHN Command".
- [Command Function Enable Setting] and [Main Unit Operation Settings] must be set. Make sure you set these up before use.
- For information on each item, refer to "9.2.1. Socket Communication Settings" (page 246), "9.2.2. RSH/SSH Command Reception Settings" (page 247) and "9.2.3. SNMP Command Reception Settings" (page 251).

#### 8.3.1.1. Setting Up the Command Main Unit Operation Settings

##### ● Set up RSH Command

**1** From the [Command Reception Settings] tab, click [RSH/SSH Command Reception Settings] to display the [RSH/SSH Command Reception Settings] screen.

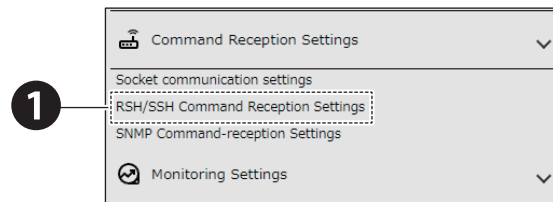

**2** Set the [RSH Command Reception Function] to [Enabled].

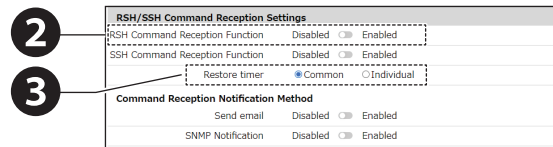

**3** From [Common] or [Individual], select [Restore timer].

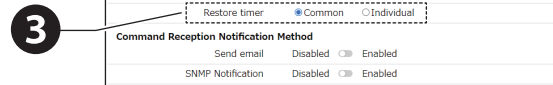

Common: Control each color of the Signal Tower and buzzer with a common timer.

Individual: Control each color of the Signal Tower and buzzer with individual timers.

**4** For receiving commands, from the Notification Method screen set [Send email] or [SNMP Notification].

When a command is received, notifications set to [Enabled] are executed.

Note: To execute notifications, notification settings must be configured beforehand based on the notification method.

"8.1. Notifying Equipment" (☞ page 118)

**Using Send Email**

To send email, setting up email notifications and email content is required.

Set up as required.

For information, refer to "8.1.2. Setting Up Email Notification Settings" (☞ page 122)

- |          |   |
|----------|---|
| <b>1</b> | Select the Subject and Body text.   |
| <b>2</b> | Select the email recipients. <ul style="list-style-type: none"> <li>You can select multiple recipients.</li> <li>If the recipient is not registered, it will not be sent even when selected.</li> </ul> |

**Using SNMP Notification**

- Before using SNMP notification, the SNMP Notification Function must be [Enabled]. For information, refer to "8.1.1. Setting Up SNMP (Trap Inform) Notification Settings" (☞ page 118)

**5** For the RSH Command Reception Settings, set [Sent-from address settings].

**To specify addresses, enable [Sent-from address settings], and set the [Source IP address] and [Login name].**

- When [Sent-from address settings] is enabled, restricted to receiving commands from IP address and login names registered in the [Source IP address] and [Login name] fields.
- Cannot use "root", "lp", and "nobody" as the login name.
- Enter the IP address in Ipv6 or Ipv4 format.

**To remove restrictions, disable [Sent-from address settings] and set a [Common Login Name].**

- Cannot use "root", "lp", and "nobody" as the login name.

**6** Click [Set] to apply the defined settings.

**Using Send Email**

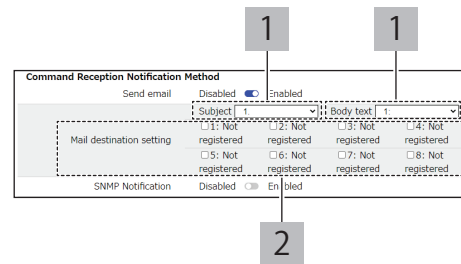

**Using SNMP Notification**

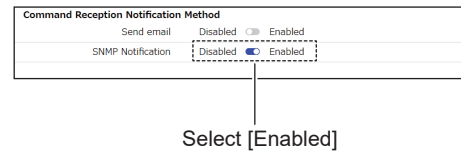

**Specifying an Address**

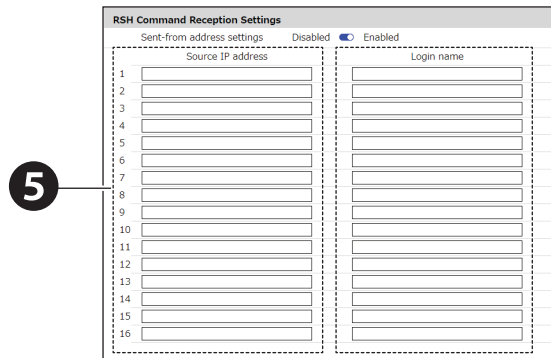

**No Restrictions**

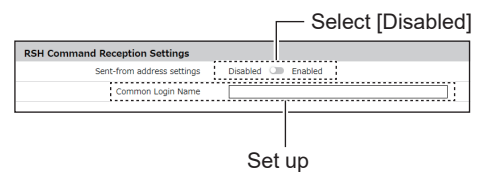

## ● Using SSH Commands

**1** From the [Command Reception Settings] tab, click [RSH/SSH Command Reception Settings] to display the [RSH/SSH Command Reception Settings] screen.

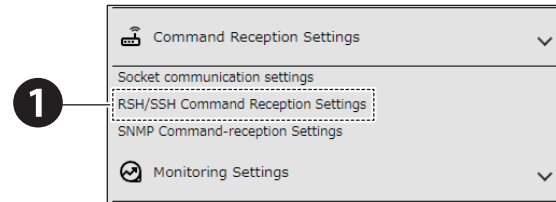

**2** Set the [SSH Command Reception Function] to [Enabled].

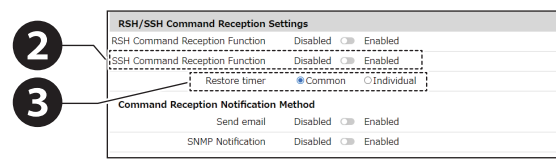

**3** From [Restore timer], select either [Common] or [Individual].

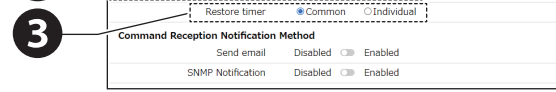

Common: Control each color of the Signal Tower and buzzer with a common timer.

Individual: Control each color of the Signal Tower and buzzer with individual timers.

**4** For receiving commands, from the Notification Method screen set [Send email] or [SNMP Notification].

When a command is received, notifications set to [Enabled] are executed.

Note: To execute notifications, notification settings must be configured beforehand based on the notification method.

"8.1. Notifying Equipment" (☞ page 118)

### ■ Using Send Email

To send email, setting up email notifications and email content is required.

For information, refer to "8.1.2. Setting Up Email Notification Settings" (☞ page 122)

- |          |   |
|----------|---|
| <b>1</b> | Select the Subject and Body text.   |
| <b>2</b> | Select the email recipients. <ul style="list-style-type: none"> <li>• You can select multiple recipients.</li> <li>• If the recipient is not registered, it will not be sent even when selected.</li> </ul> |

### Using Send Email

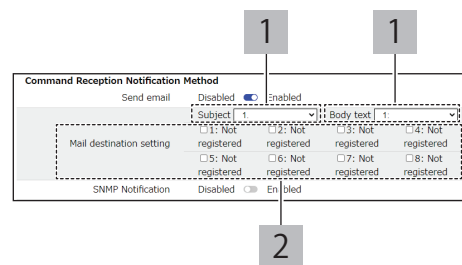

### ■ Using SNMP Notification

- Before using SNMP notification, the SNMP Notification Function must be [Enabled].

For information, refer to "8.1.1. Setting Up SNMP (Trap Inform) Notification Settings" (☞ page 118)

### Using SNMP Notification

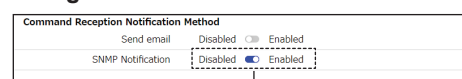

Select [Enabled]

**5** In the [SSH Command Reception Settings] screen, set the [Port number].

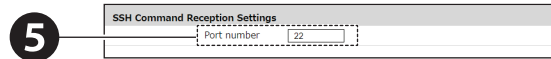

**6** In the [SSH Command Reception Settings] screen, for the [Authentication method] select either [Password Authentication] or [Key Authentication].

- You can register up to 16 receive settings.
- For the [Authentication Method], you cannot individually specify [Password Authentication] and [Key Authentication]. Select either one as a common setting.

**■ Using Password Authentication**

<b>1</b>	Set the [Source IP address]. • Enter the IP address in Ipv6 or Ipv4 format.
<b>2</b>	Set the [Login Name] and [Password]. • Cannot use "root", "lp", and "nobody" as the login name.
<b>3</b>	Configure for up to 16 instances, if necessary.

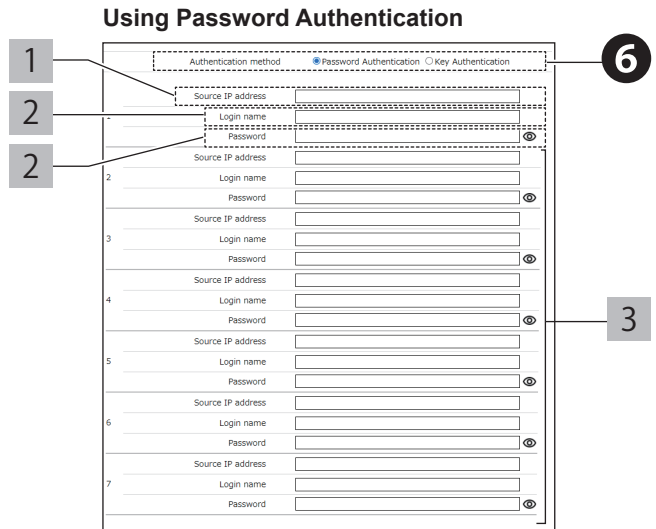

**■ Using Key Authentication**

<b>1</b>	Set the [Source IP address]. • Enter the IP address in Ipv6 or Ipv4 format.
<b>2</b>	Set the [Login Name]. • Cannot use "root", "lp", and "nobody" as the login name.
<b>3</b>	Click the [Select a file] button and register the key file. • You need to generate keys (private and public keys) on your computer. • Register on this product the public key that was created. • Execute the SSH Command with your private key and login name.
<b>4</b>	Configure for up to 16 instances, if necessary.

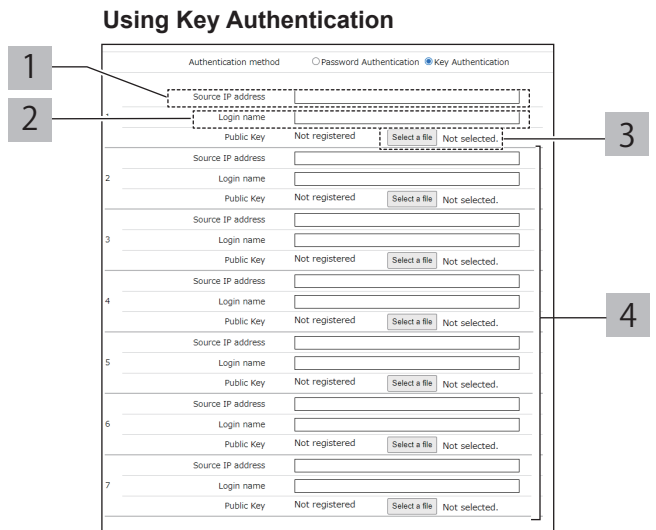

**7** Click [Set] to apply the defined settings.

● Using HTTP Commands

**1** From the [Main unit settings] tab, click [Enable Feature] to enter the [Main unit function settings] screen.

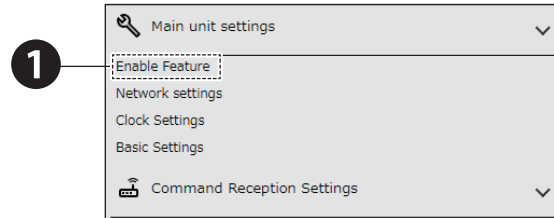

**2** In the [Main unit function settings] screen, set [HTTP Command Control] to [Enabled].

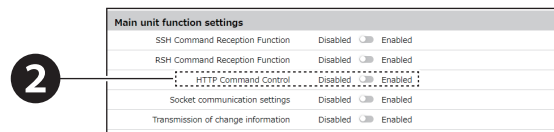

**3** Click [Set] to apply the defined settings.

To change the communication protocol, follow the steps below.

**4** From the [Management] tab, click [Security Settings] to enter the [Security Settings] screen.

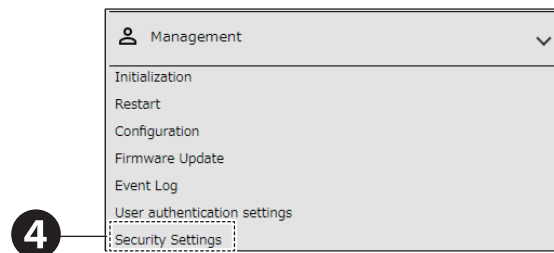

**5** Select the [Communication Protocols] as either [HTTP] or [HTTPS].

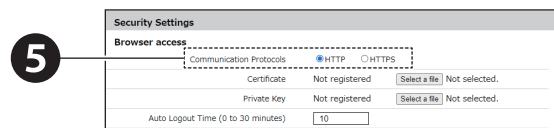

- As required, register the certificate and private key.

**6** Click [Set] to apply the defined settings.

● Using PNS and PHN Commands

**1** From the [Command Reception Settings] tab, click [Socket communication settings] to view the [Socket communication settings] screen.

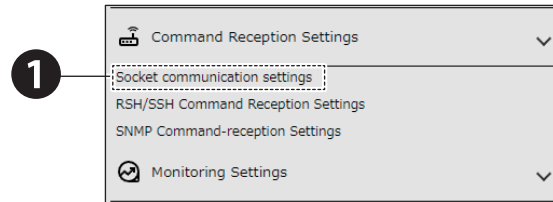

**2** In the [Socket communication settings] screen, set [Socket communication function] to [Enabled].

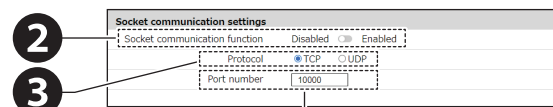

**3** For [Protocol], select [TCP] or [UDP].

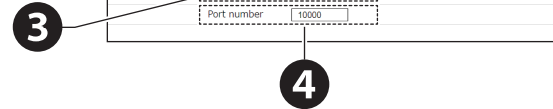

**4** Enter the Port number.



**5** Set [Sent-from address settings].

To specify addresses for communication, set [Enabled] and enter the permitted addresses in [Source address 1 to 8].

- When [Sent-from address settings] is enabled, commands from only IP addresses registered in the [Source address] field are received.
- Enter the IP address in Ipv6 or Ipv4 format.

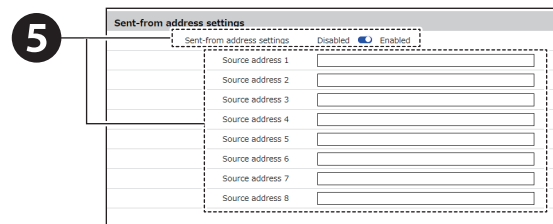

**6** Click [Set] to apply the defined settings.

● Using SNMP Commands

**1** From the [Command Reception Settings] tab, click [SNMP Command-reception Settings] to display the [SNMP Command-reception Settings] screen.

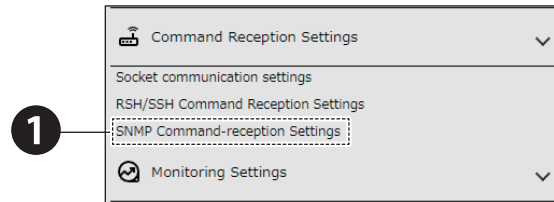

**2** In the [Receive SNMP] screen, set [SNMP Command-reception Function] to [Enabled].

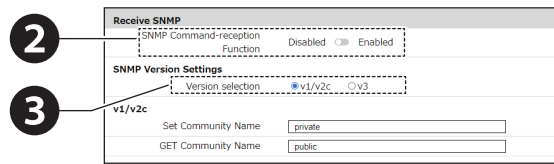

**3** In the [SNMP Version Settings], from [Version selection] select [v1/v2c] or [v3].

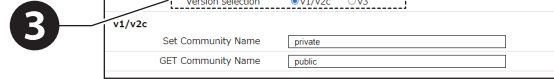

**4** In accordance with the SNMP version, set the [Receive SNMP] settings.

■ v1/v2c

- 1 Set up SET Community Name.
- 2 Set up GET Community Name.

v1/v2c

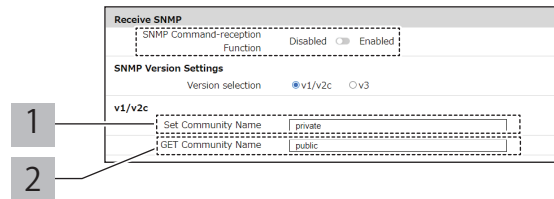

■ v3

- 1 Set an user name.
- 2 Select the security level, [NoAuthNoPriv], [AuthNoPriv], or [AuthPriv].
  - NoAuthNoPriv: Communication authentication and encryption are not performed.
  - AuthNoPriv: Performs communication authentication only.
  - AuthPriv: Performs communication authentication and encryption.
- 3 When either [AuthNoPriv] or [AuthPriv] is selected for the security level, set the Authentication method and authentication password.
  - For the Authentication method, select either [MD5] or [SHA]. Match settings on supported equipment.
- 4 When you set the [Security Level] to [AuthPriv], set the Encryption Method and Encrypted Password.
  - For the Encryption Method, select either [DES] or [AES]. Match settings on supported equipment.

v3

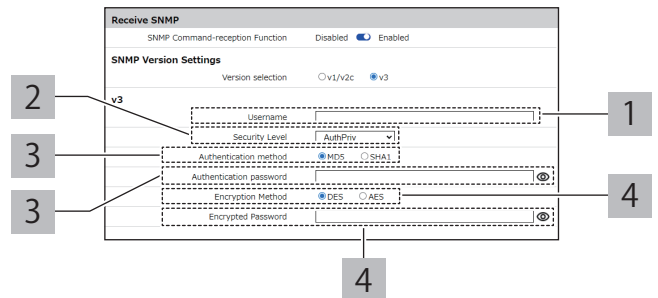

**5** Click [Set] to apply the defined settings.

### 8.3.1.2. Checking the Signal Tower State

- This section describes the procedure to use various commands to check the state of the Signal Tower.
- Before executing this operation, enable the command function and set the command main unit operation settings.
- "8.3.1.1. Setting Up the Command Main Unit Operation Settings" (☞ page 155)

#### ● Using RSH/SSH Commands

For information on RSH/SSH Commands, refer to "5.3.10. RSH/SSH Command Function" (☞ page 35).

##### Example 1

When getting the operation state of a main unit whose product IP address is "192.168.10.10", account is "patlite", state is Red flashing pattern 1, Green light on, channel 63 (buzzer pattern 3), digital inputs 1 and 4 are OFF, 2 and 3 are ON, digital output 1 is ON, and digital output 2 is OFF

- When "status" only, returns the states of the Signal Tower.

rsh\_192.168.10.10\_-l\_patlite\_status

Response: 201003

##### Example 2

When getting the operation state of a main unit whose product IP address is "192.168.10.10", account is "patlite", state is Amber flashing pattern 2, Blue light on, no channel playback, digital inputs 1 and 2 are OFF, 3 and 4 are ON, digital output 1 and 2 are OFF

- By adding the "-s" option, as there is no channel playing, 0 is returned.

rsh\_192.168.10.10\_-l\_patlite\_status\_-s

Response: 0

- By adding the "di" and "do" options, returns the state of the digital input terminal block and the digital output terminal block, respectively.

rsh\_192.168.10.10\_-l\_patlite\_status\_-di\_-do

Response: DI:0011

Response: DO:00

#### ● Using PNS Commands

For information on PNS Commands, refer to "5.3.11. PNS Command Function (product compatibility commands)" (☞ page 43).

##### Example

When Signal Tower's Red light is on, Amber is flashing pattern 1, Green is flashing pattern 2, Blue and White are off, and buzzer pattern is 4

Data Area: 6 bytes					
Signal Tower					Preset Channels
1	2	3	4	5	6
01H	02H	03H	00H	00H	04H



### ● Using PHN Commands

For information on PHN Commands, refer to "5.3.12. PHN Command Function (product compatibility commands)" (👉 page 52).

**Example 1** When Signal Tower's Green light is on and Amber is flashing pattern 1

R (52H) 8 bits								Response Data (44H) 8 bits							
0	1	0	1	0	0	1	0	0	1	0	0	0	1	0	0

**Example 2** When Signal Tower's Green light is flashing pattern 2 and buzzer pattern is neither 1 nor 2

R (52H) 8 bits								Response Data (9H) 8 bits							
0	1	0	1	0	0	1	0	1	0	0	1	1	1	0	0

**⚠ CAUTION**

⚠ Using PHN Commands, you cannot get the following operation states of the Signal Tower and channels on this product. To get these states, use other methods such as PNS or RSH Commands.

- The Signal Tower's Red, Amber, and Green lights on with flashing pattern 2, flashing pattern 3, and flashing pattern 4
- The Signal Tower's Blue and White lights on, with flashing pattern 1, flashing pattern 2, flashing pattern 3, and flashing pattern 4
- Buzzer pattern 3, buzzer pattern 4, or buzzer pattern 5
- Channels 1 to 60, and channels 63 to 71

### ● Using HTTP Commands

- For information on HTTP Commands, refer to "5.3.13. HTTP Command Reception Function" (👉 page 54). If required, in the security settings set the communication protocol beforehand. For information, refer to "7.7. Setting Up Security" (👉 page 104).
- The parameter in order to get the Signal Tower state is implemented in "status".

**Example** To turn on the Signal Tower's Red and Green lights, turn off Amber, Blue, and White, and play audio playback 5

<http://192.168.10.1/api/status?format=xml>

• Execution Result

```
<?xml version='1.0' encoding='utf-8'?>
<signaltower>
  <color>
    <color name="LED1" value="1"/>
    <color name="LED2" value="0"/>
    <color name="LED3" value="1"/>
    <color name="LED4" value="0"/>
    <color name="LED5" value="0"/>
    <color name="MULTI_COL" value="2"/>
    <color name="MULTI_PAT" value="1"/>
  </color>
  <sound>
    <sound name="SOUND" value="5"/>
  </sound>
  <port>
    <port name="DO-1" value="0"/>
    <port name="DO-2" value="0"/>
    <port name="DIN-1" value="0"/>
    <port name="DIN-2" value="0"/>
    <port name="DIN-3" value="0"/>
    <port name="DIN-4" value="0"/>
  </port>
</signaltower>
```

## ● Using SNMP Commands

- For information on SNMP Commands, refer to "5.3.14. SNMP Command Functions" (☞ page 60).
- For information on MIB, refer to "10. MIB List" (☞ page 314).
- You can get the state of the Signal Tower with the "SNMP GET Command".

### Example 1 Using GET Command when the Signal Tower's Red light is on

Object	Object ID	Get Value
controlLightCurrentState	1.3.6.1.4.1.20440.4.1.5.1.2.1.4.1	2

### Example 2 Using GET Command when the Signal Tower's Amber light is off

Object	Object ID	Get Value
controlLightCurrentState	1.3.6.1.4.1.20440.4.1.5.1.2.1.4.2	1

### 8.3.1.3. Controlling Signal Tower States

- This section describes the procedure to use various commands to control the state of the Signal Tower.
- Before executing this operation, enable the command function and set the command main unit operation settings.
- "8.3.1.1. Setting Up the Command Main Unit Operation Settings" (☞ page 155)

#### ● Using RSH/SSH Commands

- For information on RSH/SSH Commands, refer to "5.3.10. RSH/SSH Command Function" (☞ page 35).
- You can control the state of the Signal Tower with the "alert", "sound", and "color" commands.
- The following describes control with "alert" and "color" commands.

**Example 1** With product IP address of "192.168.10.10" and account "patlite", turn on Signal Tower's Red and Green lights, turn off others, and play channel 62 (buzzer pattern 2)

```
rsh_192.168.10.10_-l_patlite_alert_101002
```

Response: 101002

**Example 2** With product IP address of "192.168.10.10" and account "patlite", change Multi-color unit to White with flashing pattern 3 and emit buzzer pattern 4

```
rsh_192.168.10.10_-l_patlite_color_White_4_-b_4
```

Response: White 4 -b 4

#### ● Using PNS Commands

- For information on PNS Commands, refer to "5.3.11. PNS Command Function (product compatibility commands)" (☞ page 43).
- You can control the state of the Signal Tower with "Signal Tower / Buzzer Control Command".

**Example** When turning Red Signal Tower light on, Amber flashing pattern 1, Green flashing pattern 2, turning Blue and White lights off, and emitting buzzer pattern 4

- Setting

Product Category (XX)		ID (S)	(unused)	Data Size		Data Area: 6 bytes					
58H	58H	53H	00H	00H	06H	01H	02H	03H	00H	00H	04H

- Product Response

Normal response	Error response
ACK	NAK
06H	15H

### ● Using PHN Commands

For information on PHN Commands, refer to "5.3.12. PHN Command Function (product compatibility commands)" (👉 page 52).

**Example** When turning on the Signal Tower's Red and Amber lights, and emitting channel 62 (buzzer pattern 2)

• Setting

W (57H)							Response Data (13H)							
0	1	0	1	0	1	1	0	0	0	1	0	0	1	1

• Product Response

Normal response (output response)			Error response (output failed)		
A (41H)	C (43H)	K (4BH)	N (4EH)	A (41H)	K (4BH)
1 byte	1 byte	1 byte	1 byte	1 byte	1 byte

**⚠ CAUTION**

⚠ Using PHN Commands, you cannot control the following for Signal Tower and channels.  
To control these states, use other methods such as PNS or RSH Commands.

The Signal Tower's Red, Amber, and Green lights with flashing pattern 2, flashing pattern 3, or flashing pattern 4  
The Signal Tower's Blue and White lights on, with flashing pattern 1, flashing pattern 2, flashing pattern 3, or flashing pattern 4  
Buzzer pattern 3, buzzer pattern 4, or buzzer pattern 5  
Channels 1 to 60, or channels 63 to 71

⚠ Be cautious as channels 61 and 62 (Buzzer pattern 1, 2) are always played back in [Playback from latest input mode].  
For information, refer to "3.1.7. Playback Mode".

**Point**

● For operations you want performed, enter "1" for the operation bit, for operations you do not want performed, enter "0".

### ● Using HTTP Commands

- For information on HTTP Commands, refer to "5.3.13. HTTP Command Reception Function" (👉 page 54).
- You can control the state of the Signal Tower with the "alert", "led", and "color" parameters.
- The following procedure describes how to use the "alert" parameter.

**Example** To turn on the Signal Tower's Red and Green lights, turn off Amber, Blue, and White, and emit buzzer pattern 2

<http://192.168.10.1/api/control?alert=101002>

## ● Using SNMP Commands

- For information on SNMP Commands, refer to "5.3.14. SNMP Command Functions" (☞ page 60).
- For information on MIB, refer to "10. MIB List" (☞ page 314).
- You can control the state of the Signal Tower with the "SNMP SET Command".

### Example 1 To turn on the Signal Tower's Red light after 10 seconds

Object	Object ID	Value
controlLightControlState	1.3.6.1.4.1.20440.4.1.5.1.2.1.2.1	2
controlLightControlTimer	1.3.6.1.4.1.20440.4.1.5.1.2.1.3.1	10

### Example 2 To turn off the Signal Tower's Amber light

Object	Object ID	Value
controlLightControlState	1.3.6.1.4.1.20440.4.1.5.1.2.1.2.2	1
controlLightControlTimer	1.3.6.1.4.1.20440.4.1.5.1.2.1.3.2	0

### Example 3 To execute the Clear operation function

Object	Object ID	Value
controlLightSnmpClear	1.3.6.1.4.1.20440.4.1.5.1.3.0	1

### 8.3.1.4. Controlling Audio NHV Series

- This section describes procedures on how to use commands to control audio on this product.
- Before executing this operation, enable the command function and set the command main unit operation settings.
- "8.3.1.1. Setting Up the Command Main Unit Operation Settings" (👉 page 155)

#### ● Using RSH/SSH Commands

- For information on RSH/SSH Commands, refer to "5.3.10. RSH/SSH Command Function" (👉 page 35).
- Audio control commands are "alert", "sound", and "stop".
- The following describes control with "sound" and "stop" commands.

**Example 1** With product IP address of "192.168.10.10" and account "patlite", One-shot playback of channel 24

```
rsh 192.168.10.10 -l patlite sound 24
```



## CAUTION

⚠ Channels 61 to 64 and 71 (buzzer patterns 1 to 5) are always played using [Playback from latest input mode].  
For information, refer to "5.3.2. Audio Playback Function" (👉 page 24).

### Point

- The state of the Signal Tower can be set at the same time as audio playback.

**Example 2** Product IP address of "192.168.10.10" and account "patlite", playing channel 55

```
rsh 192.168.10.10 -l patlite stop
```

Response: 55

### ● Using PNS Commands

- For information on PNS Commands, refer to "5.3.11. PNS Command Function (product compatibility commands)" (☞ page 43).
- You can playback audio with the "MP3 Channel Control Command" and "Signal Tower/Channel Control Command".
- The following procedure describes how to use the "Write MP3 Channel Control Command".

**Example** To play channel 32, 15 times

- Setting

Product Category (XX)		ID (V)	(unused)	Data Size		Data Area: 4 bytes			
58H	58H	56H	00H	00H	04H	01H	0EH	00H	32H

- Product Response

Normal response	Error response
ACK	NAK
06H	15H

### ! CAUTION

⚠ Channels 61 to 64 and 71 (buzzer patterns 1 to 5) are always played using [Playback from latest input mode]. For information, refer to "5.3.2. Audio Playback Function" (☞ page 24).

### ● Using HTTP Commands

- For information on HTTP Commands, refer to "5.3.13. HTTP Command Reception Function" (☞ page 54).
- The parameter for playing audio is "sound".
- The following describes the control procedure for using "sound" and "stop" parameters.

**Example 1** To play channel 1 endlessly

<http://192.168.10.1/api/control?repeat=255&sound=1>

**Example 2** To stop playing the channel

**Example 3** To play the next channel in memory in Memory playback mode

<http://192.168.10.1/api/control?stop=1>

#### Point

- When HTTP Command Control Function is [Disabled], this function does not operate.
- Specify the "repeat" parameter at the same time as the "sound" parameter or "speech" parameter.
- The parameters that you can specify together are as follows.
  - "led" & "sound"
  - "sound" & "repeat"
  - "led" & "sound" & "repeat"
  - "led" & "speech"
  - "led" & "speech" & "repeat"

## ● Using SNMP Commands

- For information on SNMP Commands, refer to "5.3.14. SNMP Command Functions" (☞ page 60).
- For information on MIB, refer to "10. MIB List" (☞ page 314).
- You can control the state of the Signal Tower with the "SNMP Set Command".

**Example** Signal Tower's Green light flashing pattern 2, Repeat playback of channel 65 one time

Object	Object ID	Value
controlSoundLight	1.3.6.1.4.1.20440.4.1.5.2.2.0	993991001065

### 8.3.1.5. Play Any Text NHV Series

- This section describes procedures on how to use commands to playback text on this product.
- Before playing text on this product, enable the command function and set the command main unit operation settings.
- For information on each, refer to "8.3.1.1. Setting Up the Command Main Unit Operation Settings" (☞ page 155).

## ● Using HTTP Commands

- The parameter for playing any text is "speech".
- The following procedure describes how to play audio using the GET method's "speech" parameter.

**Example 1** To play "こんにちは" in Japanese

<http://192.168.10.1/api/control?speech=こんにちは&lang=jp>

**Example 2** To play "Hello" in English

<http://192.168.10.1/api/control?speech=Hello&lang=en>

- If you omit a parameter, play with the following settings. For information on each parameter refer to "5.3.13. HTTP Command Reception Function" (☞ page 54).

Parameter Name	Default
lang	jp
voice	male
speed	0
tone	0



### 8.3.1.6 Clearing the Status of This Product

- This section describes procedures on how to use commands to clear the status of this product.
- Before clearing the status of this product, enable the command function and set the command main unit operation settings.
- For information on each, refer to "8.3.1.1. Setting Up the Command Main Unit Operation Settings" (☞ page 155).

#### ● Using RSH/SSH Commands

- For information on RSH/SSH Commands, refer to "5.3.10. RSH/SSH Command Function" (☞ page 35).
- You can clear the status with the "clear" and "doclear" commands.
- The following procedure describes how to use the "clear" command.

**Example 1** Product IP address of "192.168.10.10", send-from address is set to disable, with common account "patlite"

```
rsh 192.168.10.10 -l patlite clear
```

**Example 2** When Account is Omitted

```
rsh 192.168.10.10 clear
```

**Example 3** Using ssh command to clear the product IP address "192.168.10.100", login name "patlite", and password "patlite", all except the Signal Tower

```
ssh 192.168.10.100 -l patlite clear -z (patlite's password:) patlite
```

#### ● Using PNS Commands

For information on PNS Commands, refer to "5.3.11. PNS Command Function (product compatibility commands)" (☞ page 43).

**Example** Return to normal operation status

- Setting

Product Category (XX)		ID (C)	(unused)	Data Size	
58H	58H	43H	00H	00H	00H

- Return Value

Normal response	Error response
ACK	NAK
06H	15H

#### ● Using HTTP Commands

- For information on HTTP Commands, refer to "5.3.13. HTTP Command Reception Function" (☞ page 54).
- Return to normal operation state with the "clear" parameter.

**Example** To execute the Clear operation

```
http://192.168.10.1/api/control?clear=1
```

## ● Using SNMP Commands

- For information on SNMP Commands, refer to "5.3.14. SNMP Command Functions" (☞ page 60).
- For information on MIB, refer to "10. MIB List" (☞ page 314).
- You can control the state of the Signal Tower with the "SNMP Set Command".

**Example** To execute the Clear operation function

Object	Object ID	Value
controlLightSnmpClear	1.3.6.1.4.1.20440.4.1.5.1.3.0	1

### 8.3.1.7. Checking the Contact Input/Output States

NHV Series (D model)

- This section describes the procedure to use commands to check the state of Contact Input/Output.
- Before executing this operation, enable the command function and set the command main unit operation settings.
- "8.3.1.1. Setting Up the Command Main Unit Operation Settings" (☞ page 155)

## ● Using RSH/SSH Commands

For information on RSH/SSH Commands, refer to "5.3.10. RSH/SSH Command Function" (☞ page 35).

**Example 1** Get the operation state of main unit whose product IP address is "192.168.10.10", account is "patlite", contact input 1 and 4 are OFF, and 2 and 3 are ON

```
rsh 192.168.10.10 -l patlite status di
```

Response: DI:0110

**Example 2** When product IP address is "192.168.10.10", account is "patlite", and contact output 1 is ON and 2 is OFF

```
rsh 192.168.10.10 -l patlite status do
```

Response: DO:10

## ● Using SNMP Commands

- For information on SNMP Commands, refer to "5.3.14. SNMP Command Functions" (☞ page 60).
- For information on MIB, refer to "10. MIB List" (☞ page 314).

**Example 1** Sending GET Command with digital input 3 ON

Object	Object ID	Value
diEntry3	1.3.6.1.4.1.20440.4.1.4.4.3.0	1

**Example 2** Sending GET Command with digital output 1 OFF

Object	Object ID	Value
doEntry1	1.3.6.1.4.1.20440.4.1.4.5.1.0	0

### 8.3.1.8. Controlling Contact Output NHV Series ( D model)

- This section describes procedures on how to use commands to control contact output on this product.
- Before controlling contact output on this product, enable the command function and set the command main unit operation settings.
- For information on each, refer to "8.3.1.1. Setting Up the Command Main Unit Operation Settings" (☞ page 155).

#### ● Using RSH/SSH Commands

For information on RSH/SSH Commands, refer to "5.3.10. RSH/SSH Command Function" (☞ page 35).

**Example** To turn digital output 1 OFF and digital output 2 ON when product IP address is "192.168.10.10" and account is "patlite"

```
rsh_192.168.10.10 -l_patlite_ alert_ do_01
```

Response: 01

**⚠ CAUTION**

⚠ When set to Busy output, during a Busy output operation you cannot use RSH/SSH Commands to operate digital output.

#### ● Using PNS Commands

For information on PNS Commands, refer to "5.3.11. PNS Command Function (product compatibility commands)" (☞ page 43).

**Example 1** To turn contact output 1 on and not to change contact output 2

- Command

Product Category (XX)		ID (D)	(unused)	Data Size		Data Area	
58H	58H	44H	00H	00H	02H	01H	09H

- Return Value

Normal response	Error response
ACK	NAK
06H	15H

**Example 2** To turn contact output 1 off and contact output 2 on



- Command

Product Category (XX)		ID (D)	(unused)	Data Size		Data Area	
58H	58H	44H	00H	00H	02H	00H	01H

- Return Value

Normal response	Error response
ACK	NAK
06H	15H

## CAUTION

 Digital output control commands enabled only when [Contact Output] is set to [Digital Output Mode].  
For information, refer to "5.3.5. External Contact Output Function" ( page 29).



### ● Using HTTP Commands

- For information on HTTP Commands, refer to "5.3.13. HTTP Command Reception Function" ( page 54).
- The parameter for controlling contact output is "output".

**Example** To turn contact output 1 on and contact output 2 off

<http://192.168.10.1/api/control?output=10>

### ● Using SNMP Commands

- For information on HTTP Commands, refer to "5.3.14. SNMP Command Functions" ( page 60).
- For information on MIB, refer to "10. MIB List" ( page 314).
- You can control the state of contact output with the "SNMP Set Command".

**Example** To turn on contact output 2

Object	Object ID	Value
doEntry2	1.3.6.1.4.1.20440.4.1.4.5.2.0	1

### 8.3.1.9. Performing the Self-test Operation

- This section describes the procedure to use commands to execute the self-test operation.
- Before executing this operation, enable the command function and set the command main unit operation settings.
- "8.3.1.1. Setting Up the Command Main Unit Operation Settings" (👉 page 155)

#### ● Using RSH/SSH Commands

- For information on RSH/SSH Commands, refer to "5.3.10. RSH/SSH Command Function" (👉 page 35).
- You can use the "test" or "dotest" command to execute the operation test.

**Example 1** Operation check with product IP address of "192.168.10.10", when send-from address is set to disable with common account "patlite"

```
rsh_192.168.10.10_-l_patlite_test
```

```
rsh_192.168.10.10_-l_patlite_dotest
```

Response: None

**Example 2** When account is omitted

```
rsh_192.168.10.10_test
```

```
rsh_192.168.10.10_dotest
```

Response: None



## CAUTION

- ⚠ When the test is run, the Signal Tower is in operation.  
If you want to do this at run time, check that running the operation will not cause any issues.
- ⚠ The monitoring function continues running during the test. Be cautious when you use the test function to check the operation of this product.
- ⚠ During or after the test is executed, PHN and PNS Commands return an error response.  
Additionally, the RSH/SSH Command returns a Busy response.
- ⚠ After the test is complete, Signal Tower operations executed with the monitoring function run normally.
- ⚠ For information on test operation stop methods, refer to "3.15. Clear Operation Function".
- ⚠ Executing a test operation clears channel memory.

### 8.3.2. Checking and Controlling the Signal Tower on the Web Setup Screen

You can check and control the state of the Signal Tower on the Web Setup Screen.

#### 8.3.2.1. Checking the Signal Tower States

**1** From the [Main unit operation settings] tab, click [Signal Tower Operation] to enter the [Signal Tower Operation] screen.

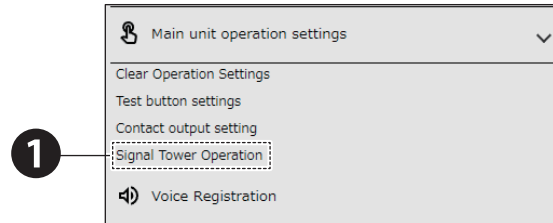

**2** From [Current Status], check the states of the listed Signal Tower.

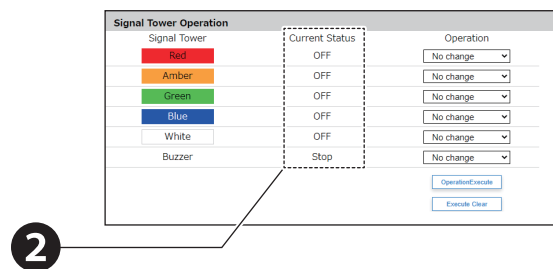

#### 8.3.2.2. Controlling Signal Tower States

**1** From the [Main unit operation settings] tab, click [Signal Tower Operation] to enter the [Signal Tower Operation] screen.

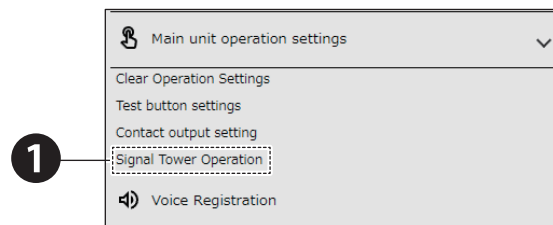

**2** Define the settings on the [Signal Tower Operation] screen.

##### ■ Normal LED Unit

**1** For each Signal Tower light ([Red], [Amber], [Green], [Blue], and [White]), select [OFF], [Continuous ON], [Flashing pattern 1], [Flashing pattern 2], [Flashing pattern 3], [Flashing pattern 4], or [No change].

##### Normal LED Unit

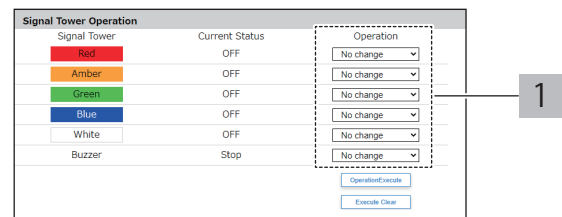

##### ■ Multi-color unit

- 1** In [Basic Settings], check that [Multi-color unit] is selected as an [Additional unit].
  - "9.1.4. Basic Settings" (page 244)
- 2** Select the color of the Signal Tower light, [Red], [Amber], [Green], [Blue], [White], [Purple], or [Light blue].
- 3** Select operation [OFF], [Continuous ON], [Flashing pattern 1], [Flashing pattern 2], [Flashing pattern 3], [Flashing pattern 4], or [No change].

##### Multi-color unit

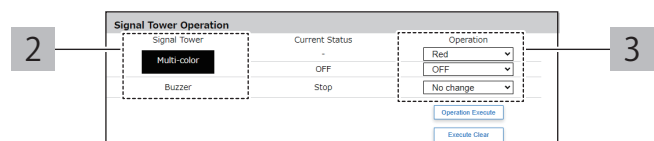

### 8.3.3. Operating the Product with the Clear Button

The Clear button clears the states on the product and notifies the user that it has been cleared. [Clear Button Settings] and [Clear Operation Settings] must be set. Make sure you set these up before use.

#### 8.3.3.1. Setting Up the Clear Operation Settings

**1** From the [Main unit operation settings] tab, click [Clear Operation Settings] to enter the [Clear Operation Settings] screen.

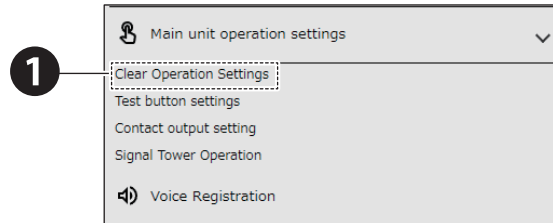

**2** In the [Clear Button Settings] screen, set [Clear Button] to [Enabled].



**3** When the Clear button is pressed, set [Send email], [SNMP Notification], [Send HTTP Command], and [Send MQTT].

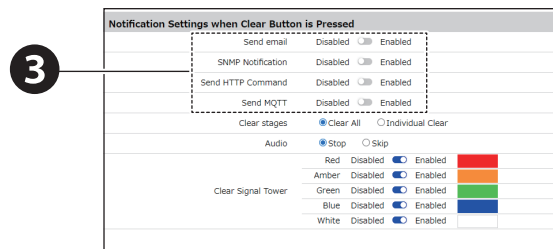

**4**

When the Clear button is pressed, notifications set to [Enabled] are executed.

Note: To execute notifications, notification settings must be configured beforehand based on the notification method.

"8.1. Notifying Equipment" (☞ page 118)

**Using Send Email**

To send email, setting up email notifications and email content beforehand is required.

"8.1.2. Setting Up Email Notification Settings" (☞ page 122)

- |   |   |
|---|---|
| 1 | Select the Subject and Body text.   |
| 2 | Select the email recipients. <ul style="list-style-type: none"> <li>You can select multiple recipients.</li> <li>If the recipient is not registered, it will not be sent even when selected.</li> </ul> |

**Using SNMP Notification**

Before using SNMP notification, [SNMP Notification] must be [Enabled].

"8.1.1. Setting Up SNMP (Trap Inform) Notification Settings" (☞ page 118)

**Using Send HTTP Command**

Before sending HTTP Commands, the HTTP Command must be registered.

"8.1.3. Setting Up HTTP Command Sending Settings" (☞ page 125)

- |   |   |
|---|---|
| 1 | Select the HTTP Command Destination. <ul style="list-style-type: none"> <li>You can select multiple recipients.</li> <li>If the recipient is not registered, it will not be sent even when selected.</li> </ul> |
|---|---|

**Using Send MQTT**

Before using Send MQTT, the Cloud function must be enabled.

"8.2. Using the Cloud" (☞ page 128)

**5**

For [Clear stages], select either [Clear All] or [Depress twice to Clear all].

**Using Clear All**

Simultaneously clear Signal Tower, digital output, and channels.

**Using Depress twice to Clear all**

- The first time the button is pressed, the buzzer, channel, and contact output are cleared.
- The second time the button is pressed, the Signal Tower is cleared.

**Using Send Email**

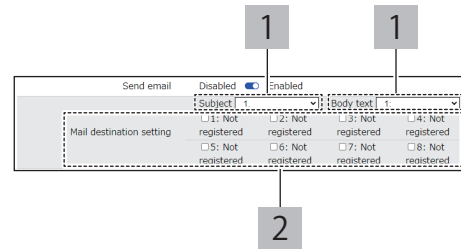

**Using SNMP Notification**

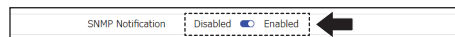

**Using Send HTTP Command**

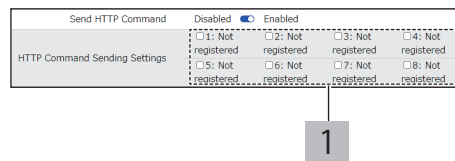

**Using Send MQTT**

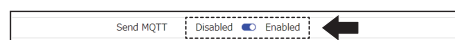

**5**





**6** Select [Audio] from [Stop] or [Skip].

Note: To use this function, the [Audio Playback Mode] must be set to [Memory playback mode].  
 "7.12. Setting Up Audio Playback Mode" (👉 page 110)

■ **When Stopped**

- Stops channel playback and stops Busy output.
- Channel memory is erased.

■ **Skip Track**

- Stops playback of a channel and then plays channels registered in channel memory.
- When channel memory is empty, channel playback stops.

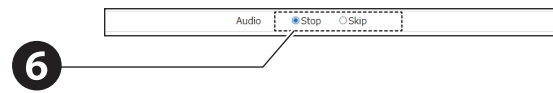

**7** Select the Signal Tower colors to clear.

- The operation state of color units set to [Enabled] becomes Clear or Normal. The states of color units set to [Disabled] do not change.
- In [Additional units], when [Multi-color unit] is selected, you can set just one target in the multi-color unit to clear.

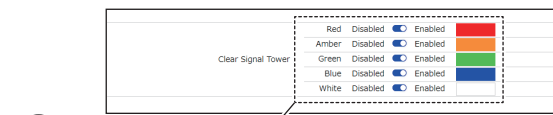

**8** Click [Set] to apply the defined settings.

**8.3.3.2. Using Clear Button to Execute Clear Operation**

**1** Press the Clear Button.

- When the Clear Button is pressed, the clear operation specified in the [Clear Operation Settings] is executed.

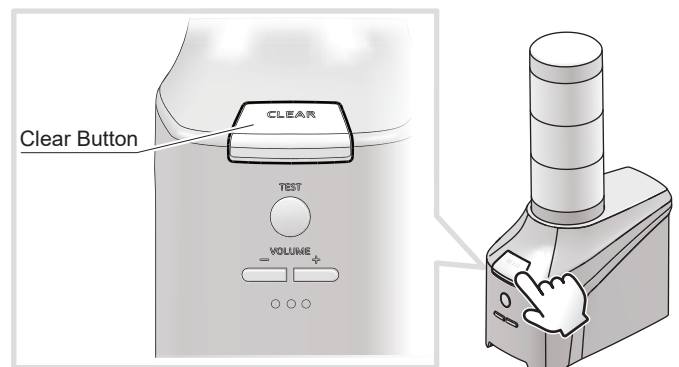

## 8.4. Monitoring

### 8.4.1. Ping Monitoring

- Set up to use ping monitoring.
- For information on each item, refer to "9.3.1. Ping Monitoring Settings" (👉 page 253).

#### 8.4.1.1. Setup Procedure

##### Individual Monitoring

**1** From the [Monitoring Settings] tab, click [Individual setting] to enter the [Ping Monitoring Settings] - [Individual setting] screen.

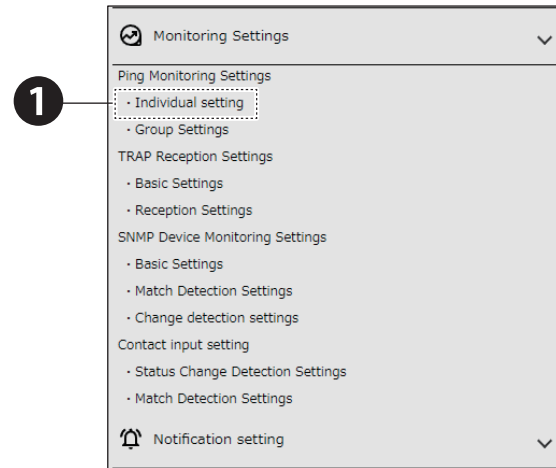

**2** Specify the [Ping Monitoring Settings] - [Setting Number].

For each setting number, you can set one monitoring target.  
Select from 1 to 24 for the [Setting Number].

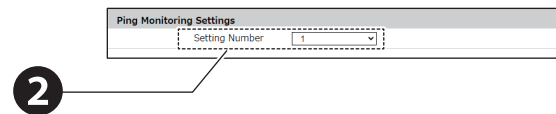

**3** Set the Monitored Equipment.

1	In [Monitored Equipment], register the Monitored Address of the equipment.
2	In [Unit name], register the name of the device to monitor. <ul style="list-style-type: none"> <li>The unit name is used to identify the device on which an event occurred for use in emails.</li> <li>This setting can be omitted.</li> </ul>
3	The group configured in [Ping Monitoring Settings] - [Group Settings]. <ul style="list-style-type: none"> <li>Use the Monitoring Group Setting for multiple monitored equipment.</li> </ul>
4	In [Number of transmissions] (0-30), set the number of Ping responses that are identified as errors.
5	In [PING Monitoring Cycle (1-600) sec.], set the frequency of Ping transmissions.
6	In [Number of transmissions] (1-3), set the number of Ping to send for each frequency.

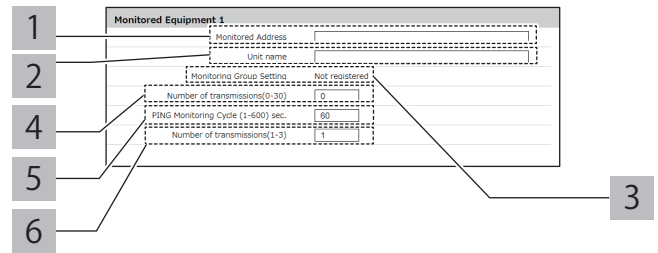

**4** Set operation settings for when an error occurs.

**Controlling Signal Tower Lights on This Product**

Depending on the selections in [Basic Settings] - [Additional units], setup items may differ.

In [Additional units], [Not Used] is selected

1	For each Signal Tower light ([Red], [Amber], [Green], [Blue], and [White]), select [OFF], [Continuous ON], [Flashing pattern 1], [Flashing pattern 2], [Flashing pattern 3], [Flashing pattern 4], or [No change].
---	--

In [Additional units], [Multi-color unit] is selected

1	Select the color, [Red], [Amber], [Green], [Blue], [White], [Purple], [Light blue], or [No change].
2	Select the pattern, [OFF], [Continuous ON], [Flashing pattern 1], [Flashing pattern 2], [Flashing pattern 3], [Flashing pattern 4], or [No change].

**Controlling Signal Tower Lights on This Product**

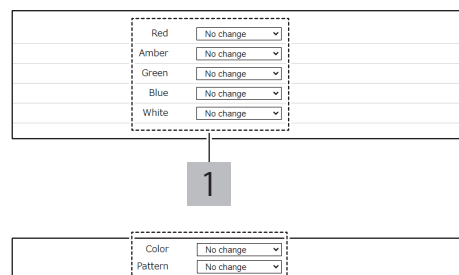

**Controlling Audio**

NHB	
1	Select the Buzzer, [Stop], [Buzzer pattern 1], [Buzzer pattern 2], [Buzzer pattern 3], [Buzzer pattern 4], [Buzzer pattern 5], or [No change].

NHV	
To play audio other than the presets, the audio needs to be registered. <a href="#">☞</a> Section 00, "Setting Up Voice Registration"	
1	Select the audio, [Stop], [One-shot playback], [Repeat playback], or [No change]. <ul style="list-style-type: none"> <li>When [Repeat playback] is selected, specify the number of times for it to play.</li> </ul>
2	From [Audio Channel], specify the audio channel to play.

**Using Send Email**

To send email, setting up email notifications and email content is required.

"8.1.2. Setting Up Email Notification Settings" ([☞](#) page 122)

1	Select the Subject and Body text.
2	Select the email recipients. <ul style="list-style-type: none"> <li>You can select multiple recipients.</li> <li>If the recipient is not registered, it will not be sent even when selected.</li> </ul>

**Using SNMP Notification**

Before using SNMP notification, the SNMP Notification Function must be [Enabled].

"8.1.1. Setting Up SNMP (Trap Inform) Notification Settings" ([☞](#) page 118)

**Using Send HTTP Command**

Before sending HTTP Commands, the HTTP Command must be registered.

"8.1.3. Setting Up HTTP Command Sending Settings" ([☞](#) page 125)

1	Select the HTTP Command Destination. <ul style="list-style-type: none"> <li>You can select multiple recipients.</li> <li>If the recipient is not registered, it will not be sent even when selected.</li> </ul>
---	---

**Using Send MQTT**

Before using Send MQTT, the Cloud function must be enabled.

"8.2. Using the Cloud" ([☞](#) page 128)

**Using Contact Output**

Before using contact output, the Contact Output Function must be [Enabled].

"8.1.4. Setting Up Contact Output Settings" ([☞](#) page 127)

**Controlling Audio**

● NHB

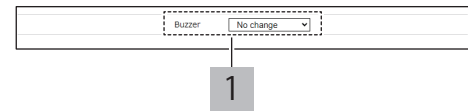

● NHV

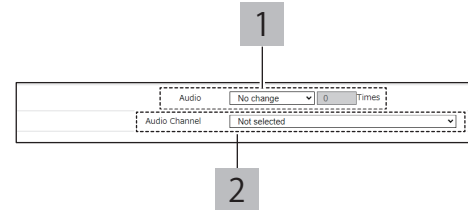

**Using Send Email**

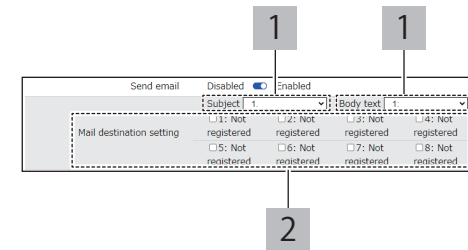

**Using SNMP Notification**



**Using Send HTTP Command**

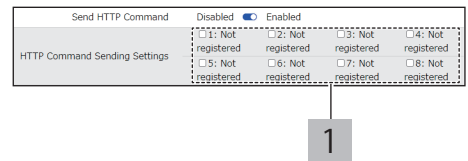

**Using Send MQTT**

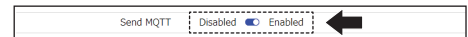

**Using Contact Output**

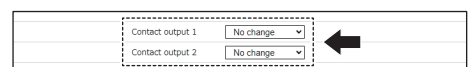

**5**

Sets operation setting for recovery from an error.

**Controlling Signal Tower Lights on This Product**

Depending on the selections in [Basic Settings] - [Additional units], setup items may differ.

In [Additional units], [Not Used] is selected

1	For each Signal Tower light ([Red], [Amber], [Green], [Blue], and [White]), select [OFF], [Continuous ON], [Flashing pattern 1], [Flashing pattern 2], [Flashing pattern 3], [Flashing pattern 4], or [No change].
---	--

In [Additional units], [Multi-color unit] is selected

1	Select the color, [Red], [Amber], [Green], [Blue], [White], [Purple], [Light blue], or [No change].
2	Select the pattern, [OFF], [Continuous ON], [Flashing pattern 1], [Flashing pattern 2], [Flashing pattern 3], [Flashing pattern 4], or [No change].

**Controlling Audio**

**NHB**

1	Select the buzzer, [Stop], [Buzzer pattern 1], [Buzzer pattern 2], [Buzzer pattern 3], [Buzzer pattern 4], [Buzzer pattern 5], or [No change].
---	--

**NHV**  
To play audio other than the presets, the audio needs to be registered."7.16. Setting Up Voice Registration" ( page 114)

1	Select the audio, [Stop], [One-shot playback], [Repeat playback], or [No change]. • When [Repeat playback] is selected, specify the number of times for it to play.
2	From [Audio Channel], specify the audio channel to play.

**Using Send Email**

To send email, setting up email notifications and email content is required.

"8.1.2. Setting Up Email Notification Settings" ( page 122)

1	Select the Subject and Body text.
2	Select the email recipients. • You can select multiple recipients. • If the recipient is not registered, it will not be sent even when selected.

**Using SNMP Notification**

Before using SNMP notification, the SNMP Notification Function must be [Enabled].

"8.1.1. Setting Up SNMP (Trap Inform) Notification Settings" ( page 118)

**Controlling Signal Tower Lights on This Product**

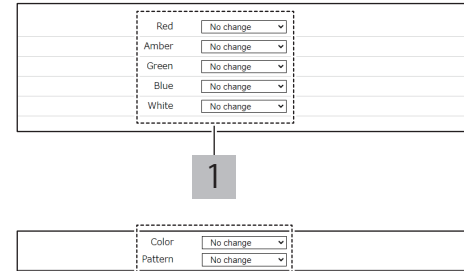

**Controlling Audio**

● NHB

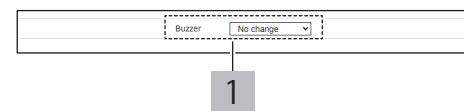

● NHV

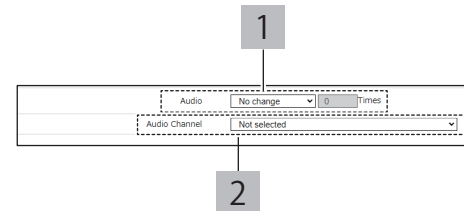

**Using Send Email**

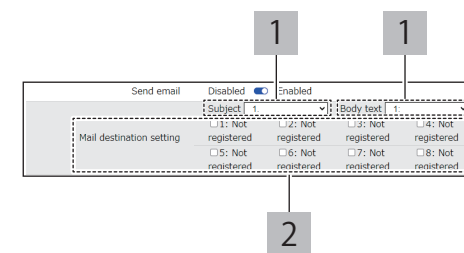

**Using SNMP Notification**



**Using Send HTTP Command**

Before sending HTTP Commands, the HTTP Command must be registered.

"8.1.3. Setting Up HTTP Command Sending Settings" (👉 page 125)

1 Select the HTTP Command Destination.

- You can select multiple recipients.
- If the recipient is not registered, it will not be sent even when selected.

**Using Send HTTP Command**

1

**Using Send MQTT**

Before using Send MQTT, the Cloud function must be enabled.

"8.2. Using the Cloud" (👉 page 128)

**Using Send MQTT**

**Using Contact Output**

Before using contact output, the Contact Output Function must be [Enabled].

"8.1.4. Setting Up Contact Output Settings" (👉 page 127)

**Using Contact Output**

6 Click [Set] to apply the defined settings.

- For each monitoring target setting, click the [Set] button to apply the defined settings to the product. Settings for multiple monitoring targets cannot be updated at one time.

7 Ping monitoring is started.

- Restart is unnecessary.

**Using the Group Monitoring Function**

Use the Monitoring Group Setting for multiple monitored equipment. If more than one monitored equipment in a group enters an error state, the product continues with error state operations until all the equipment in the group are restored.

**1** From the [Monitoring Settings] tab, click [Group Settings] to display the [Ping Monitoring Settings] - [Group Settings] screen.

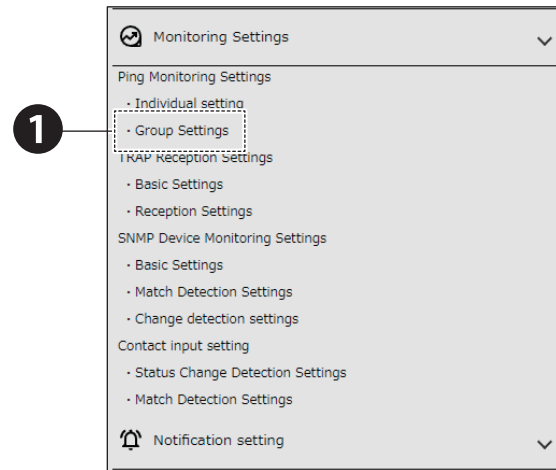

**2** Select the [Group] to configure.

- You can set up three groups (A, B, and C).

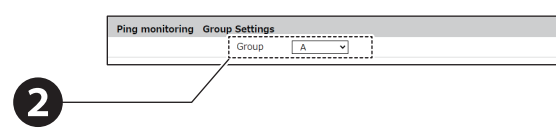

**3** Select the [Equipment] for the group.

- Devices specified in a group do not perform the operation defined in the individual setting, but perform the operation defined in the group setting.
- A device assigned to a group cannot also be assigned to another group.

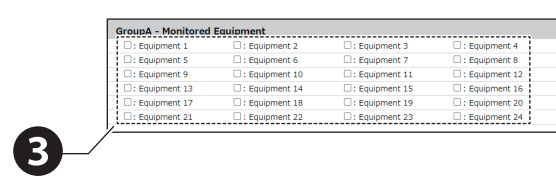

**4**

Set operation settings for when an error occurs.

**Controlling Signal Tower Lights on This Product**

Depending on the selections in [Basic Settings] - [Additional units], setup items may differ.

In [Additional units], [Not Used] is selected	
1	For each Signal Tower light ([Red], [Amber], [Green], [Blue], and [White]), select [OFF], [Continuous ON], [Flashing pattern 1], [Flashing pattern 2], [Flashing pattern 3], [Flashing pattern 4], or [No change].

In [Additional units], [Multi-color unit] is selected	
1	Select the color, [Red], [Amber], [Green], [Blue], [White], [Purple], [Light blue], or [No change].
2	Select the pattern, [OFF], [Continuous ON], [Flashing pattern 1], [Flashing pattern 2], [Flashing pattern 3], [Flashing pattern 4], or [No change].

**Controlling Audio**

NHB	
1	Select the buzzer, [Stop], [Buzzer pattern 1], [Buzzer pattern 2], [Buzzer pattern 3], [Buzzer pattern 4], [Buzzer pattern 5], or [No change].

NHV	
To play audio other than the presets, the audio needs to be registered."7.16. Setting Up Voice Registration" ( page 114)	
1	Select the audio, [Stop], [One-shot playback], [Repeat playback], or [No change]. • When [Repeat playback] is selected, specify the number of times for it to play.
2	From [Audio Channel], specify the audio channel to play.

**Using Send Email**

To send email, setting up email notifications and email content is required.

"8.1.2. Setting Up Email Notification Settings" ( page 122)

1	Select the Subject and Body text.
2	Select the email recipients. • You can select multiple recipients. • If the recipient is not registered, it will not be sent even when selected.

**Using SNMP Notification**

Before using SNMP notification, the SNMP Notification Function must be [Enabled].

"8.1.1. Setting Up SNMP (Trap Inform) Notification Settings" ( page 118)

**Controlling Signal Tower Lights on This Product**

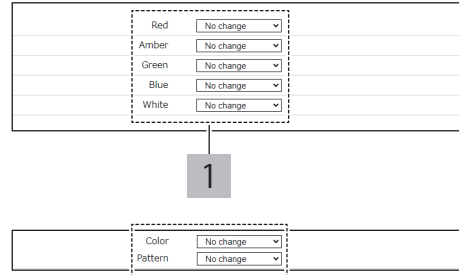

**Controlling Audio**

● NHB

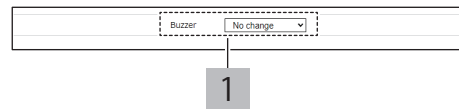

● NHV

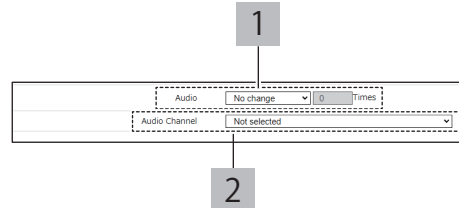

**Using Send Email**

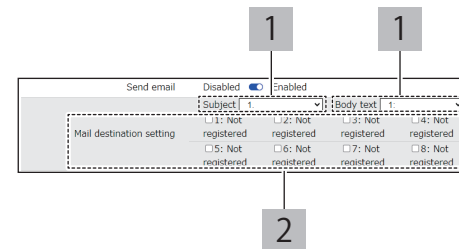

**Using SNMP Notification**

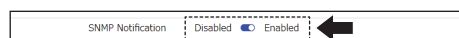



**Using Send HTTP Command**

Before sending HTTP Commands, the HTTP Command must be registered.

"8.1.3. Setting Up HTTP Command Sending Settings" (page 125)

1	Select the HTTP Command Destination. <ul style="list-style-type: none"> <li>You can select multiple recipients.</li> <li>If the recipient is not registered, it will not be sent even when selected.</li> </ul>
---	---

**Using Send MQTT**

Before using Send MQTT, the Cloud function must be enabled.

"8.2. Using the Cloud" (page 128)

**Using Contact Output**

Before using contact output, the Contact Output Function must be [Enabled].

"8.1.4. Setting Up Contact Output Settings" (page 127)

<b>5</b>	Set operation setting for recovery from an error.
----------	---

**Controlling Signal Tower Lights on This Product**

Depending on the selections in [Basic Settings] - [Additional units], setup items may differ.

In [Additional units], [Not Used] is selected	
1	For each Signal Tower light ([Red], [Amber], [Green], [Blue], and [White]), select [OFF], [Continuous ON], [Flashing pattern 1], [Flashing pattern 2], [Flashing pattern 3], [Flashing pattern 4], or [No change].

In [Additional units], [Multi-color unit] is selected	
1	Select the color, [Red], [Amber], [Green], [Blue], [White], [Purple], [Light blue], or [No change].
2	Select the pattern, [OFF], [Continuous ON], [Flashing pattern 1], [Flashing pattern 2], [Flashing pattern 3], [Flashing pattern 4], or [No change].

**Controlling Audio**

NHB	
1	Select the buzzer, [Stop], [Buzzer pattern 1], [Buzzer pattern 2], [Buzzer pattern 3], [Buzzer pattern 4], [Buzzer pattern 5], or [No change].

NHV	
To play audio other than the presets, the audio needs to be registered."7.16. Setting Up Voice Registration" (page 114)	
1	Select the audio, [Stop], [One-shot playback], [Repeat playback], or [No change]. <ul style="list-style-type: none"> <li>When [Repeat playback] is selected, specify the number of times for it to play.</li> </ul>
2	From [Audio Channel], specify the audio channel to play.

**Using Send HTTP Command**

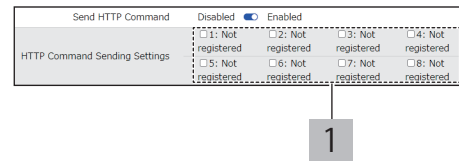

**Using Send MQTT**

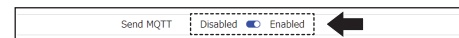

**Using Contact Output**

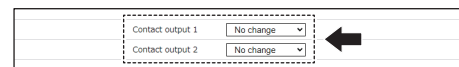

**Controlling Signal Tower Lights on This Product**

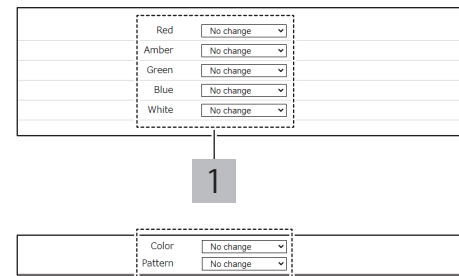

**Controlling Audio**

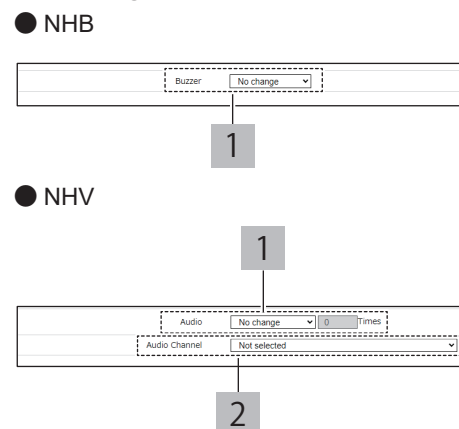

**Using Send Email**

To send email, setting up email notifications and email content is required.

"8.1.2. Setting Up Email Notification Settings" ( page 122)

- |   |   |
|---|---|
| 1 | Select the Subject and Body text.   |
| 2 | Select the email recipients. <ul style="list-style-type: none"> <li>You can select multiple recipients.</li> <li>If the recipient is not registered, it will not be sent even when selected.</li> </ul> |

**Using Send Email**

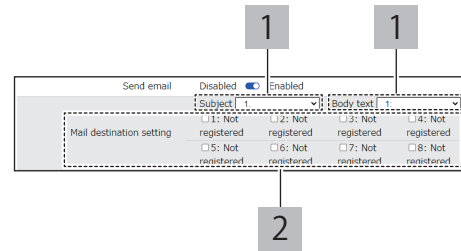

**Using SNMP Notification**

Before using SNMP notification, the SNMP Notification Function must be [Enabled].

"8.1.1. Setting Up SNMP (Trap Inform) Notification Settings" ( page 118)

**Using SNMP Notification**

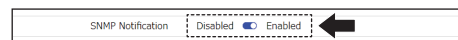

**Using Send HTTP Command**

Before sending HTTP Commands, the HTTP Command must be registered.

"8.1.3. Setting Up HTTP Command Sending Settings" ( page 125)

**Using Send HTTP Command**

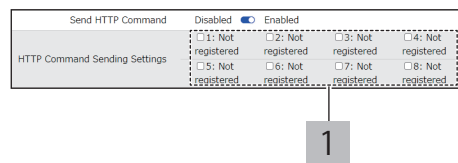

- |   |   |
|---|---|
| 1 | Select the HTTP Command Destination. <ul style="list-style-type: none"> <li>You can select multiple recipients.</li> <li>If the recipient is not registered, it will not be sent even when selected.</li> </ul> |
|---|---|

**Using Send MQTT**

Before using Send MQTT, the Cloud function must be enabled.

"8.2. Using the Cloud" ( page 128)

**Using Send MQTT**



**Using Contact Output**

Before using contact output, the Contact Output Function must be [Enabled].

"8.1.4. Setting Up Contact Output Settings" ( page 127)

**Using Contact Output**



**6** Click [Set] to apply the defined settings.

- For each monitoring target setting, click the [Set] button to apply the defined settings to the product. Settings for multiple monitoring targets cannot be updated at one time.

**7** Ping monitoring is started.

- Restart is unnecessary.

## 8.4.2. SNMP TRAP Monitoring

- Set up TRAP monitoring settings or TRAP receive settings.
- For information on each item, refer to "9.3.2. TRAP Reception Settings" (👉 page 259).

### 8.4.2.1. Setup Procedure

#### ● Enable SNMP Function

**1** From the [Monitoring Settings] tab, click [Basic Settings] to enter the [TRAP Reception Settings] - [Basic Settings] screen.

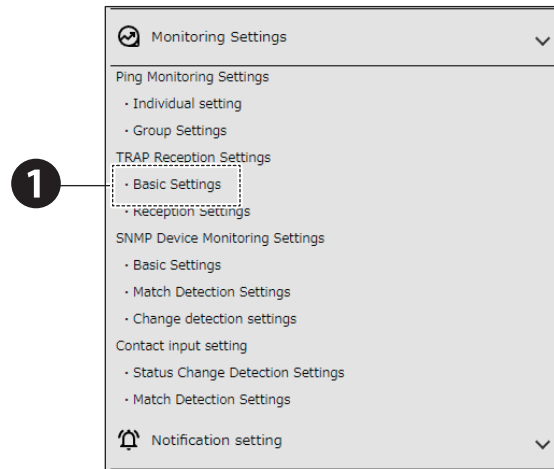

**2** Set the [TRAP Reception Function] to [Enabled].

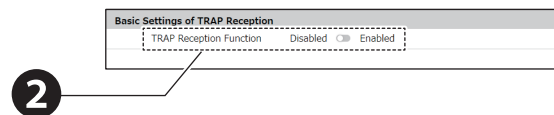

**3** From [Version selection], select [v1/v2c] or [v3].

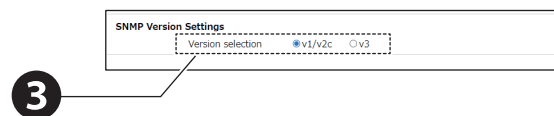

**4** Set up TRAP receive.

■ v1/v2c

- 1 Set up the TRAP Reception Community.

■ v3

- 1 Set an user name.
- 2 Select the security level, [noAuthNoPriv], [AuthNoPriv], or [AuthPriv].
  - noAuthNoPriv: Communication authentication and encryption are not performed.
  - AuthNoPriv: Performs communication authentication only.
  - AuthPriv: Performs communication authentication and encryption.
- 3 When either [AuthNoPriv] or [AuthPriv] is selected for the security level, set the Authentication method and authentication password.
  - For the Authentication method, select either [MD5] or [SHA]. Select to match settings on supported equipment.
- 4 When you set the [Security Level] to [AuthPriv], set the Encryption Method and Encrypted Password.
  - For the Encryption Method, select either [DES] or [AES]. Select to match settings on supported equipment.

v1/v2c

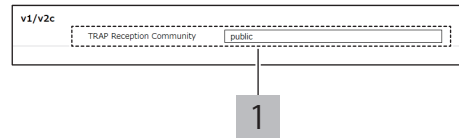

v3

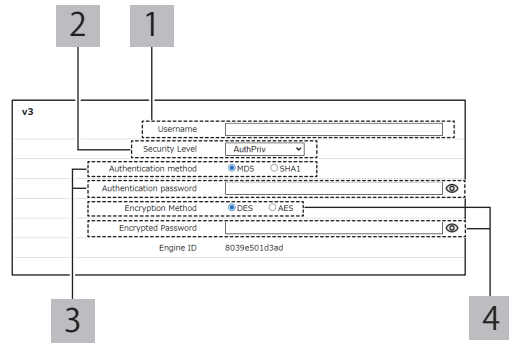

**5** Click [Set] to apply the defined settings.

● **Set up SNMP TRAP Monitoring**

**1** From the [Monitoring Settings] tab, click [Reception Settings] to enter the [TRAP Reception Settings] screen.

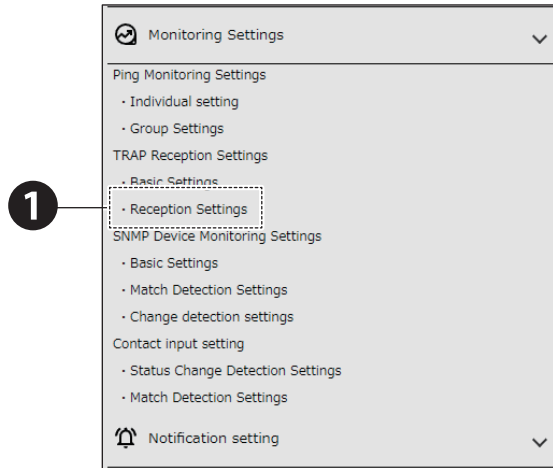

**2** Specify the [Group Settings] for TRAP Reception Settings.

- Select from 1 to 16 for the [Group Settings].

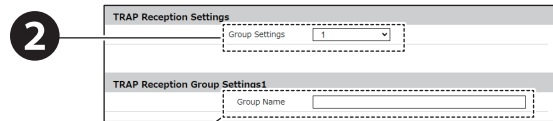

**3** In [Group Name], set the name for the selected number.



**4** Configure the TRAP Receive group settings.

- |   |   |
|---|---|
| 1 | Set the [SNMP Notification Source Address] and [TRAP Number].   |
| 2 | Set [variable-bindings (1-2)]. <ul style="list-style-type: none"> <li>• Of two registration items in [variable-bindings], it can be registered only with the first of these.</li> <li>• In [variable-bindings], you can use an asterisk ( * ) at the end.<br/>When an asterisk ( * ) is used, any integer value at the end is considered to match the condition.</li> <li>• With the Receive Function, the number of variable-bindings that can be identified is up to 64 per TRAP.<br/>When a TRAP is received with more than 65 variable-bindings, among variable-bindings OID, the 65th and subsequent OID will not work even if they are set up.</li> </ul> |

- When a SNMP notification source address item is entered, you can omit the [TRAP Number] and [variable-bindings] fields. If the [TRAP Number] and [variable-bindings] fields are omitted, all TRAP received from the address in the [SNMP Notification Source Address] field will be received.
- If the [SNMP Notification Source Address] is omitted, only the TRAP number is used.
- If both [SNMP Notification Source Address] and [TRAP Number] are omitted, after receipt no operation is performed.
- When duplicate TRAP numbers are registered in a group, group operations use the TRAP with the smallest number. Operation for the subsequent group number is not performed.
- If the [GenericTrap type] of the TRAP received is 6 (enterprisespecific), at the end of the received TRAP append the specific-trap value.

**5** Sets the operation when TRAP is received.

**Controlling Signal Tower Lights on This Product**

Depending on the selections in [Basic Settings] - [Additional units], setup items may differ.

In [Additional units], [Not Used] is selected

1	For each Signal Tower light ([Red], [Amber], [Green], [Blue], and [White]), select [OFF], [Continuous ON], [Flashing pattern 1], [Flashing pattern 2], [Flashing pattern 3], [Flashing pattern 4], or [No change].
---	--

In [Additional units], [Multi-color unit] is selected

1	Select the color, [Red], [Amber], [Green], [Blue], [White], [Purple], [Light blue], or [No change].
2	Select the pattern, [OFF], [Continuous ON], [Flashing pattern 1], [Flashing pattern 2], [Flashing pattern 3], [Flashing pattern 4], or [No change].

**Controlling Audio**

**NHB**

1	Select the buzzer, [Stop], [Buzzer pattern 1], [Buzzer pattern 2], [Buzzer pattern 3], [Buzzer pattern 4], [Buzzer pattern 5], or [No change].
---	--

**NHV**

To play audio other than the presets, the audio needs to be registered."7.16. Setting Up Voice Registration" ( page 114)

1	Select the audio, [Stop], [One-shot playback], [Repeat playback], or [No change]. • When [Repeat playback] is selected, specify the number of times for it to play.
2	From [Audio Channel], specify the audio channel to play.

**Using Send Email**

To send email, setting up email notifications and email content is required.

"8.1.2. Setting Up Email Notification Settings" ( page 122)

1	Select the Subject and Body text.
2	Select the email recipients. • You can select multiple recipients. • If the recipient is not registered, it will not be sent even when selected.

**Using SNMP Notification**

Before using SNMP notification, the SNMP Notification Function must be [Enabled].

"8.1.1. Setting Up SNMP (Trap Inform) Notification Settings" ( page 118)

**Controlling Signal Tower Lights on This Product**

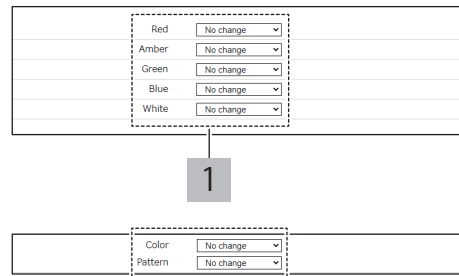

**Controlling Audio**

**NHB**

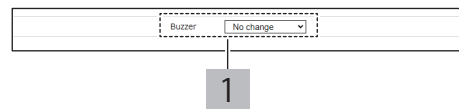

**NHV**

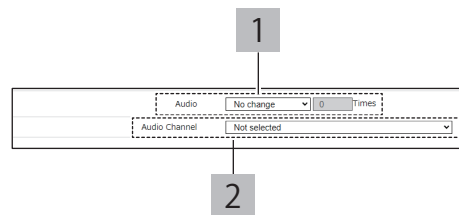

**Using Send Email**

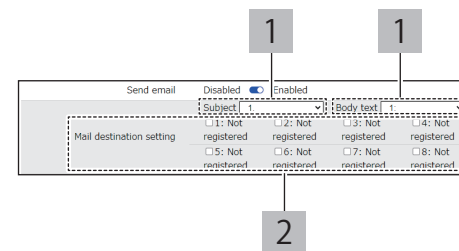

**Using SNMP Notification**



**Using Send HTTP Command**

Before sending HTTP Commands, the HTTP Command must be registered.

"8.1.3. Setting Up HTTP Command Sending Settings" (page 125)

1 Select the HTTP Command Destination.

- You can select multiple recipients.
- If the recipient is not registered, it will not be sent even when selected.

**Using Send MQTT**

Before using Send MQTT, the Cloud function must be enabled.

"8.2. Using the Cloud" (page 128)

**Using Contact Output**

Before using contact output, the Contact Output Function must be [Enabled].

"8.1.4. Setting Up Contact Output Settings" (page 127)

6 Click [Set] to apply the defined settings.

- For each TRAP Receive group setting, click the [Set] button to apply the defined settings to the product. Settings for multiple TRAP Receive groups cannot be updated at one time.

7 SNMP TRAP monitoring is started.

- Restart is unnecessary.

**Using Send HTTP Command**

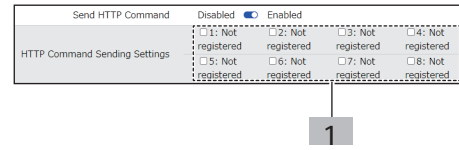

1

**Using Send MQTT**



**Using Contact Output**





### 8.4.3. SNMP Device Monitoring

- Set up to use SNMP Device Monitoring.
- For information on each item, refer to "9.3.3. SNMP Device Monitoring Settings" (👉 page 264).

#### 8.4.3.1. Setup Procedure

##### ● Enable SNMP Device Monitoring Function

**1** From the [Monitoring Settings] tab, click [Basic Settings] to enter the [SNMP Device Monitoring Settings] - [Basic Settings] screen.

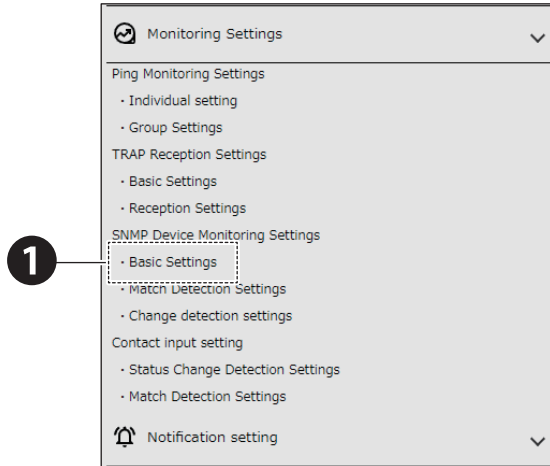

**2** In [SNMP Device Monitoring], set [SNMP Device Monitoring Function] to [Enabled].

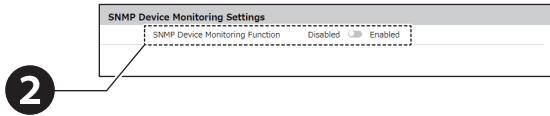

**3** When using SNMP v1 or v2c, in the [SNMP v1/v2c Settings] set [GET Community Name].

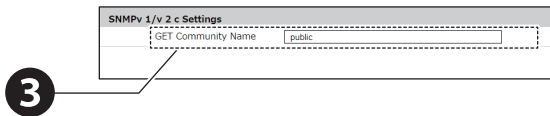

**4** When using SNMP v3, in [SNMPv3 Certification] select the [Connection Destination Number].

- You can register up to 20 connection destination numbers.

**5** Set the connection for the selected [Connection Destination Number].

1	Set an user name.
2	<p>Select the security level, [noAuthNoPriv], [AuthNoPriv], or [AuthPriv].</p> <ul style="list-style-type: none"> <li>• noAuthNoPriv: Communication authentication and encryption are not performed.</li> <li>• AuthNoPriv: Performs communication authentication only.</li> <li>• AuthPriv: Performs communication authentication and encryption.</li> </ul>
3	<p>When either [AuthNoPriv] or [AuthPriv] is selected for the security level, set the Authentication method and authentication password.</p> <ul style="list-style-type: none"> <li>• For the Authentication method, select either [MD5] or [SHA]. Match settings on supported equipment.</li> </ul> <p>When you set the [Security Level] to [AuthPriv], set the Encryption Method and Encrypted Password.</p> <ul style="list-style-type: none"> <li>• For the Encryption Method, select either [DES] or [AES]. Match settings on supported equipment.</li> </ul>

**6** Click [Set] to apply the defined settings.

- For each connection destination, click the [Set] button to apply the defined settings to the product. Settings for multiple connection destinations cannot be updated at one time.

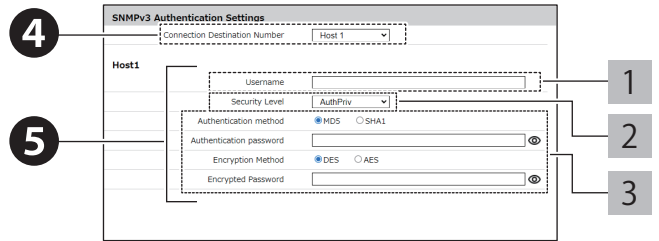

## ● Set up SNMP Device Monitoring

### Match Detection

**1** From the [Monitoring Settings] tab, click [Match Detection Settings] to enter the [SNMP Device Monitoring Settings] - [Match Detection Settings] screen.

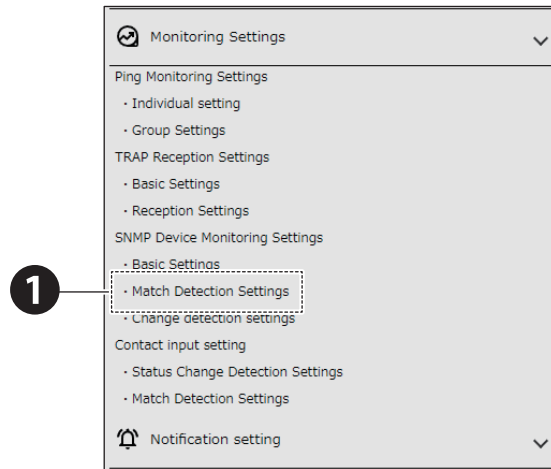

**2** Select a [Condition Settings Number].

- You can register up to 20 condition settings.

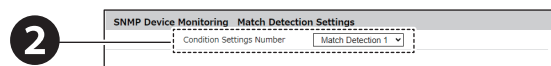

**3** Set the Match Detection for the selected [Condition Settings Number].

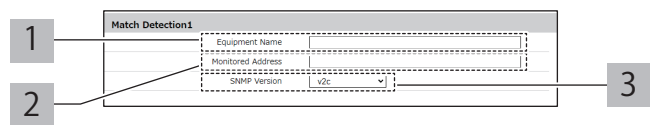

<b>1</b>	<p>Register the Equipment Name.</p> <ul style="list-style-type: none"> <li>The unit name is used to identify the device on which an event occurred for use in email.</li> <li>This setting can be omitted.</li> </ul>
<b>2</b>	<p>Set the Monitored Address.</p>
<b>3</b>	<p>Specify the SNMP Version.</p> <ul style="list-style-type: none"> <li>When v3 is selected, SNMPv3 Certification is displayed.</li> </ul> <p>Specify the connection destination number that was set in the [Basic Settings].</p>
<b>4</b>	<p>Set the Judgment condition.</p> <ul style="list-style-type: none"> <li>Select the OID detection method from [Specified OID only] and [All Specified OID Below].</li> <li>You can omit the value.</li> <li>Select from [Equal to], [More than], and [Less than].</li> <li>If both Judgment conditions are set, the operation is performed when both conditions are met.</li> </ul>
<b>5</b>	<p>Set the Monitoring Period from 0 to 60 seconds.</p>

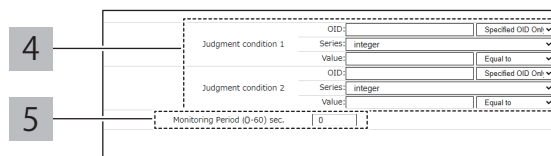

**4** Sets the [Operation during communication timeout].

To put this product in monitoring status when a communication timeout with the monitoring target occurs, set up the following.

- 1 Set [Release Conditions] to [Enabled].
- 2 Set the [Number of retries] from 0 to 10.

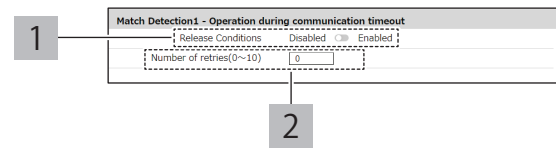

**5** Set the operation when the condition matches.

**Controlling Signal Tower Lights on This Product**

Depending on the selections in [Basic Settings] - [Additional units], setup items may differ.

- In [Additional units], [Not Used] is selected
- 1 For each Signal Tower light ([Red], [Amber], [Green], [Blue], and [White]), select [OFF], [Continuous ON], [Flashing pattern 1], [Flashing pattern 2], [Flashing pattern 3], [Flashing pattern 4], or [No change].

**Controlling Signal Tower Lights on This Product**

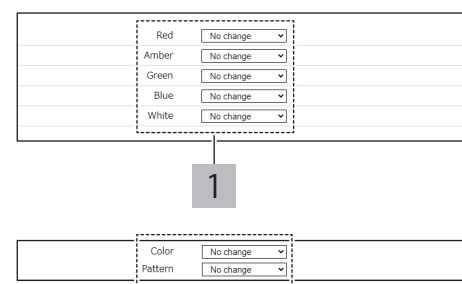

- In [Additional units], [Multi-color unit] is selected
- 1 Select the color, [Red], [Amber], [Green], [Blue], [White], [Purple], [Light blue], or [No change].
  - 2 Select the pattern, [OFF], [Continuous ON], [Flashing pattern 1], [Flashing pattern 2], [Flashing pattern 3], [Flashing pattern 4], or [No change].

**Controlling Audio**

- NHB**
- 1 Select the buzzer, [Stop], [Buzzer pattern 1], [Buzzer pattern 2], [Buzzer pattern 3], [Buzzer pattern 4], [Buzzer pattern 5], or [No change].

**Controlling Audio**

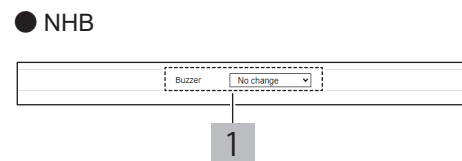

- NHV**
- To play audio other than the presets, the audio needs to be registered."7.16. Setting Up Voice Registration" ( page 114)
- 1 Select the audio, [Stop], [One-shot playback], [Repeat playback], or [No change].
    - When [Repeat playback] is selected, specify the number of times for it to play.
  - 2 From [Audio Channel], specify the audio channel to play.

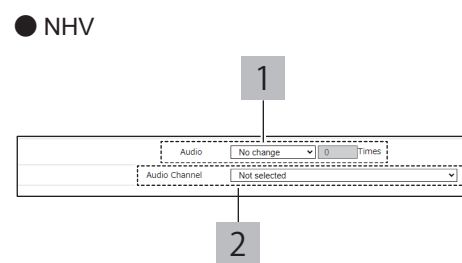

**Using Send Email**

To send email, setting up email notifications and email content is required.

"8.1.2. Setting Up Email Notification Settings" ( page 122)

- 1 Select the Subject and Body text.
- 2 Select the email recipients.
  - You can select multiple recipients.
  - If the recipient is not registered, it will not be sent even when selected.

**Using Send Email**

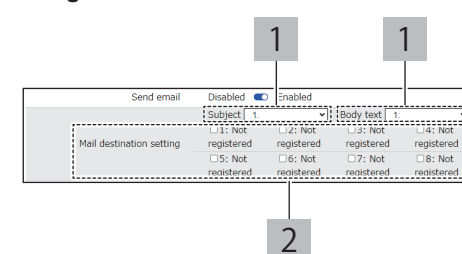

**■ Using SNMP Notification**

Before using SNMP Notification, the SNMP Notification Function must be [Enabled].

"8.1.1. Setting Up SNMP (Trap Inform) Notification Settings" (☞ page 118)

**■ Using Send HTTP Command**

Before sending HTTP Commands, the HTTP Command must be registered.

"8.1.3. Setting Up HTTP Command Sending Settings" (☞ page 125)

<b>1</b>	Select the HTTP Command Destination. <ul style="list-style-type: none"> <li>You can select multiple recipients.</li> <li>If the recipient is not registered, it will not be sent even when selected.</li> </ul>
----------	---

**■ Using Send MQTT**

Before using Send MQTT, the Cloud function must be enabled.

"8.2. Using the Cloud" (☞ page 128)

**■ Using Contact Output**

Before using contact output, the Contact Output Function must be [Enabled].

"8.1.4. Setting Up Contact Output Settings" (☞ page 127)

**6** Set the release condition operation.

**■ Controlling Signal Tower Lights on This Product**

Depending on the selections in [Basic Settings] - [Additional units], setup items may differ.

In [Additional units], [Not Used] is selected	
<b>1</b>	For each Signal Tower light ([Red], [Amber], [Green], [Blue], and [White]), select [OFF], [Continuous ON], [Flashing pattern 1], [Flashing pattern 2], [Flashing pattern 3], [Flashing pattern 4], or [No change].

In [Additional units], [Multi-color unit] is selected	
<b>1</b>	Select the color, [Red], [Amber], [Green], [Blue], [White], [Purple], [Light blue], or [No change].
<b>2</b>	Select the pattern, [OFF], [Continuous ON], [Flashing pattern 1], [Flashing pattern 2], [Flashing pattern 3], [Flashing pattern 4], or [No change].

**Using SNMP Notification**



**Using Send HTTP Command**

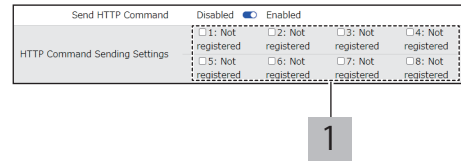

**Using Send MQTT**

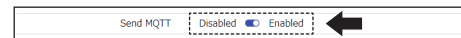

**Using Contact Output**



**Controlling Signal Tower Lights on This Product**

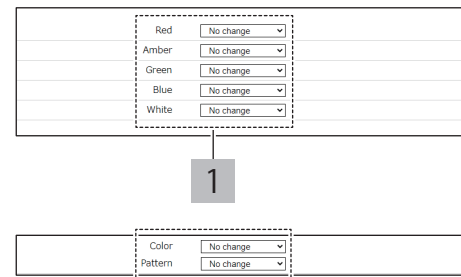

**Controlling Audio**

NHB	
1	Select the buzzer, [Stop], [Buzzer pattern 1], [Buzzer pattern 2], [Buzzer pattern 3], [Buzzer pattern 4], [Buzzer pattern 5], or [No change].

NHV	
To play audio other than the presets, the audio needs to be registered."7.16. Setting Up Voice Registration" ( page 114)	
1	Select the audio, [Stop], [One-shot playback], [Repeat playback], or [No change]. <ul style="list-style-type: none"> <li>When [Repeat playback] is selected, specify the number of times for it to play.</li> </ul>
2	From [Audio Channel], specify the audio channel to play.

**Using Send Email**

To send email, setting up email notifications and email content is required.

"8.1.2. Setting Up Email Notification Settings" ( page 122)

1	Select the Subject and Body text.
2	Select the email recipients. <ul style="list-style-type: none"> <li>You can select multiple recipients.</li> <li>If the recipient is not registered, it will not be sent even when selected.</li> </ul>

**Using SNMP Notification**

Before using SNMP notification, the SNMP Notification Function must be [Enabled].

"8.1.1. Setting Up SNMP (Trap Inform) Notification Settings" ( page 118)

**Using Send HTTP Command**

Before sending HTTP Commands, the HTTP Command must be registered.

"8.1.3. Setting Up HTTP Command Sending Settings" ( page 125)

1	Select the HTTP Command Destination. <ul style="list-style-type: none"> <li>You can select multiple recipients.</li> <li>If the recipient is not registered, it will not be sent even when selected.</li> </ul>
---	---

**Using Send MQTT**

Before using Send MQTT, the Cloud function must be enabled.

"8.2. Using the Cloud" ( page 128)

**Using Contact Output**

Before using contact output, the Contact Output Function must be [Enabled].

"8.1.4. Setting Up Contact Output Settings" ( page 127)

**When Re-evaluation of Match is Selected**

This setting can be omitted. Set this product setting so you can re-evaluate specific equipment.

**Controlling Audio**

**NHB**

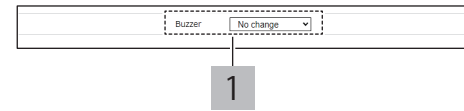

**NHV**

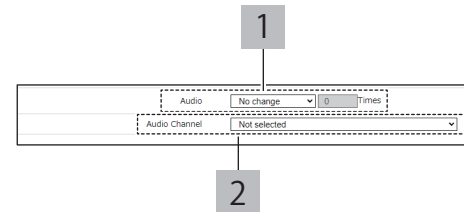

**Using Send Email**

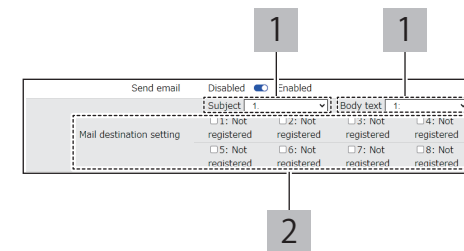

**Using SNMP Notification**



**Using Send HTTP Command**

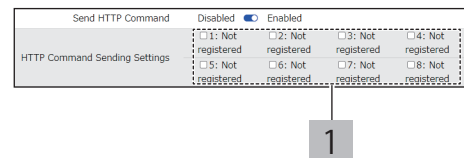

**Using Send MQTT**



**Using Contact Output**

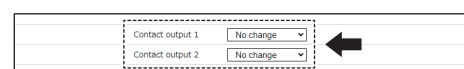

**When Re-evaluation of Match is Selected**

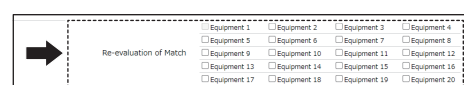

**7**

Click [Set] to apply the defined settings.

- For each condition setting, click the [Set] button to apply the defined settings to the product. Settings for multiple conditions cannot be updated at one time.

**8**

SNMP Device Monitoring is started.

- Restart is unnecessary.

**Detect Change**

**1** From the [Monitoring Settings] tab, click [Change detection settings] to enter the [SNMP Device Monitoring Settings] - [Change detection settings] screen.

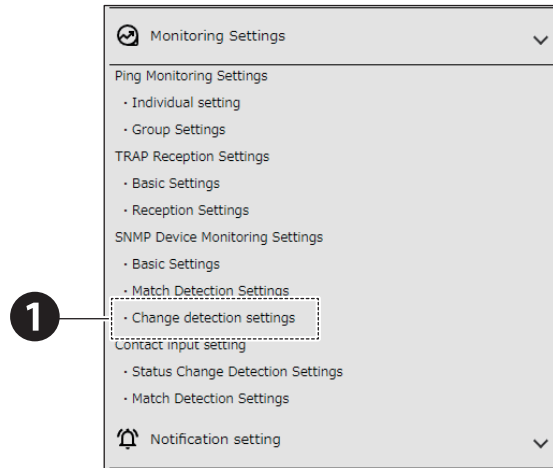

**2** Select a [Condition Settings Number].

- Select from [Change detection 1] to [Change detection 5].

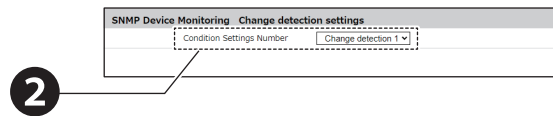

**3** Set the Change detection.

1	<p>Register the Equipment Name.</p> <ul style="list-style-type: none"> <li>• The equipment name is used to identify the device on which an event occurred for use in emails.</li> <li>• This setting can be omitted.</li> </ul>
2	Set the Monitored Address.
3	<p>Specify the SNMP Version.</p> <ul style="list-style-type: none"> <li>• When v3 is selected, SNMPv3 Certification is displayed.</li> </ul> <p>Specify the connection destination number that was previously set.</p>
4	Set the Monitored OID.
5	Set the Monitoring Period from 0 to 60 seconds.

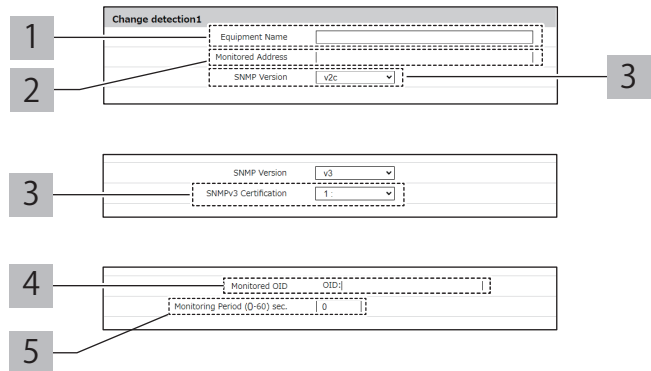



**4** Set the operation for when a change is detected.

**Controlling Signal Tower Lights on This Product**

Depending on the selections in [Basic Settings] - [Additional units], setup items may differ.

In [Additional units], [Not Used] is selected	
1	For each Signal Tower light ([Red], [Amber], [Green], [Blue], and [White]), select [OFF], [Continuous ON], [Flashing pattern 1], [Flashing pattern 2], [Flashing pattern 3], [Flashing pattern 4], or [No change].

In [Additional units], [Multi-color unit] is selected	
1	Select the color, [Red], [Amber], [Green], [Blue], [White], [Purple], [Light blue], or [No change].
2	Select the pattern, [OFF], [Continuous ON], [Flashing pattern 1], [Flashing pattern 2], [Flashing pattern 3], [Flashing pattern 4], or [No change].

**Controlling Audio**

NHB	
1	Select the buzzer, [Stop], [Buzzer pattern 1], [Buzzer pattern 2], [Buzzer pattern 3], [Buzzer pattern 4], [Buzzer pattern 5], or [No change].

NHV	
To play audio other than the presets, the audio needs to be registered."7.16. Setting Up Voice Registration" ( page 114)	
1	Select the audio, [Stop], [One-shot playback], [Repeat playback], or [No change]. • When [Repeat playback] is selected, specify the number of times for it to play.
2	From [Audio Channel], specify the audio channel to play.

**Using Send Email**

To send email, setting up email notifications and email content is required.

"8.1.2. Setting Up Email Notification Settings" ( page 122)

1	Select the Subject and Body text.
2	Select the email recipients. • You can select multiple recipients. • If the recipient is not registered, it will not be sent even when selected.

**Using SNMP Notification**

Before using SNMP notification, the SNMP Notification Function must be [Enabled].

"8.1.1. Setting Up SNMP (Trap Inform) Notification Settings" ( page 118)

**Controlling Signal Tower Lights on This Product**

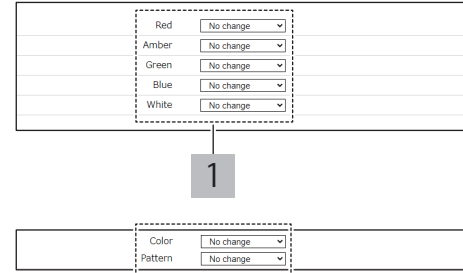

**Controlling Audio**

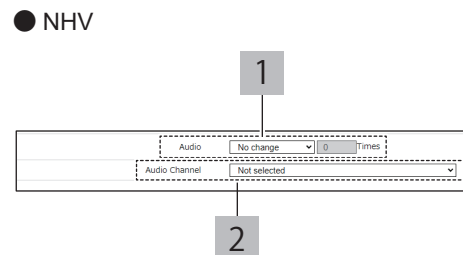
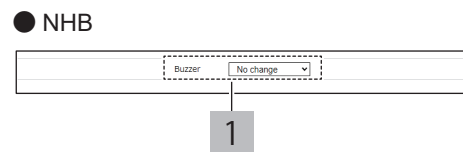

**Using Send Email**

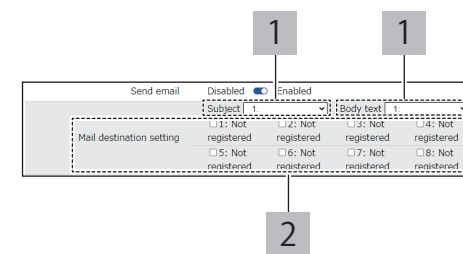

**Using SNMP Notification**



**Using Send HTTP Command**

Before sending HTTP Commands, the HTTP Command must be registered.

"8.1.3. Setting Up HTTP Command Sending Settings" ( page 125)

1 Select the HTTP Command Destination.

- You can select multiple recipients.
- If the recipient is not registered, it will not be sent even when selected.

**Using Send MQTT**

Before using Send MQTT, the Cloud function must be enabled.

"8.2. Using the Cloud" ( page 128)

**Using Contact Output**

Before using contact output, the Contact Output Function must be [Enabled].

"8.1.4. Setting Up Contact Output Settings" ( page 127)

**5** Click [Set] to apply the defined settings.

- For each condition setting, click the [Set] button to apply the defined settings to the product. Settings for multiple conditions cannot be updated at one time.

**6** SNMP Device Monitoring is started.

- Restart is unnecessary.

**Using Send HTTP Command**

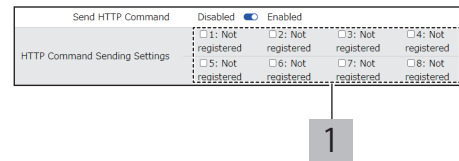

**Using Send MQTT**



**Using Contact Output**

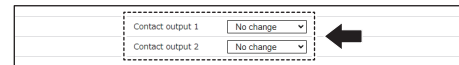

### 8.4.4. Contact Input Status Monitoring NHV Series (D model)

- This setting is used when monitoring the status of contact input.
- For information on each item, refer to "9.3.4. Contact Input Setting" (👉 page 272).

#### 8.4.4.1. Setting Up Contact Input Function

**1** From the [Monitoring Settings] tab, click [Status Change Detection Settings] to enter the [Contact input setting] - [Status Change Detection Settings] screen.

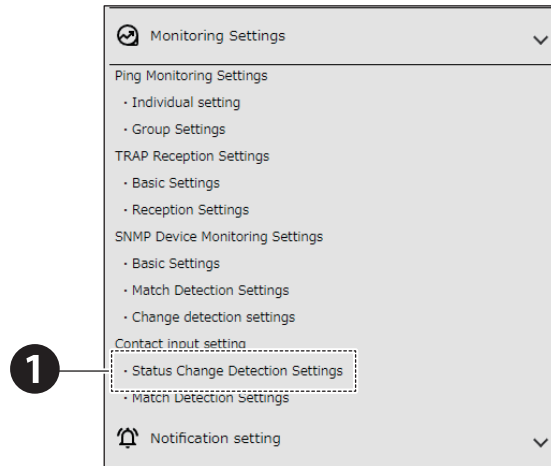

**2** From [Port Selection], select the Contact input to set up.

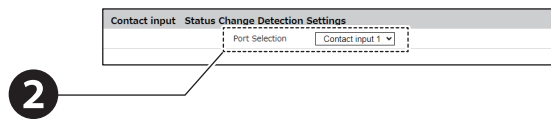

**3** Set [Contact Input] to [Enabled].

**4** Select the [Boolean Value] as either [Contact A] or [Contact B].

**5** Select the Signal Definition, [ON Status Change], [OFF Status Change], and [Status change].

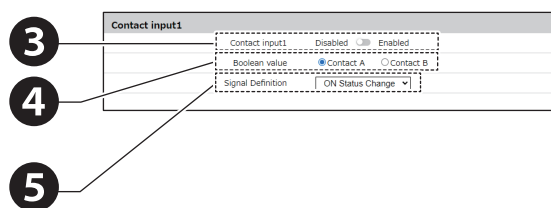

**6**

Set operation settings for ON Status Change.

**Controlling Signal Tower Lights on This Product**

Depending on the selections in [Basic Settings] - [Additional units], setup items may differ.

In [Additional units], [Not Used] is selected	
1	For each Signal Tower light ([Red], [Amber], [Green], [Blue], and [White]), select [OFF], [Continuous ON], [Flashing pattern 1], [Flashing pattern 2], [Flashing pattern 3], [Flashing pattern 4], or [No change].

In [Additional units], [Multi-color unit] is selected	
1	Select the color, [Red], [Amber], [Green], [Blue], [White], [Purple], [Light blue], or [No change].
2	Select the pattern, [OFF], [Continuous ON], [Flashing pattern 1], [Flashing pattern 2], [Flashing pattern 3], [Flashing pattern 4], or [No change].

**Controlling Audio**

To play audio other than the presets, the audio needs to be registered."7.16. Setting Up Voice Registration" (👉 page 114)	
1	Select the audio, [Stop], [One-shot playback], [Repeat playback], or [No change]. • When [Repeat playback] is selected, specify the number of times for it to play.
2	From [Audio Channel], specify the audio channel to play.

**Using Send Email**

To send email, setting up email notifications and email content is required.

"8.1.2. Setting Up Email Notification Settings" (👉 page 122)

1	Select the Subject and Body text.
2	Select the email recipients. • You can select multiple recipients. • If the recipient is not registered, it will not be sent even when selected.

**Using SNMP Notification**

Before using SNMP notification, the SNMP Notification Function must be [Enabled].

"8.1.1. Setting Up SNMP (Trap Inform) Notification Settings" (👉 page 118)

**Controlling Signal Tower Lights on This Product**

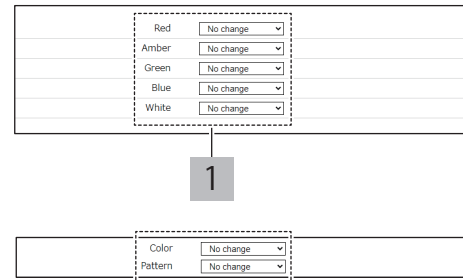

**Controlling Audio**

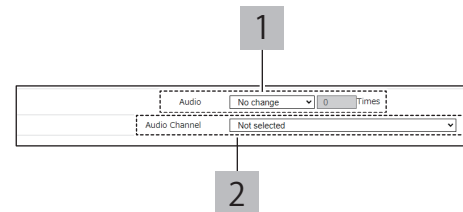

**Using Send Email**

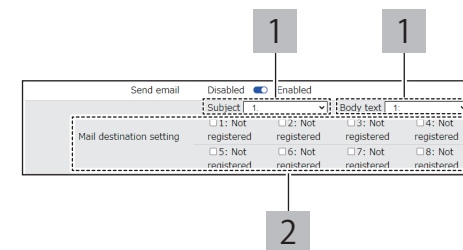

**Using Send HTTP Command**

Before sending HTTP Commands, the HTTP Command must be registered.

"8.1.3. Setting Up HTTP Command Sending Settings" (☞ page 125)

1	Select the HTTP Command Destination. <ul style="list-style-type: none"> <li>You can select multiple recipients.</li> <li>If the recipient is not registered, it will not be sent even when selected.</li> </ul>
---	---

**Using Send MQTT**

Before using Send MQTT, the Cloud function must be enabled.

"8.2. Using the Cloud" (☞ page 128)

**Using Contact Output**

Before using contact output, the Contact Output Function must be [Enabled].

"8.1.4. Setting Up Contact Output Settings" (☞ page 127)

**Configuring Clear Conditions**

- Before clearing conditions, match detection settings must be set up.  
"8.4.5. Contact Input Condition Monitoring" (☞ page 210)
- By setting this item, when the contact changes state OFF → ON, as per the condition specified in the [Match Detection Settings], the input time is reset.  
"5.3.19. Contact Input Match Detection" (☞ page 68)

<b>7</b>	Set operation settings for OFF Status Change.
----------	---

**Controlling Signal Tower Lights on This Product**

Depending on the selections in [Basic Settings] - [Additional units], setup items may differ.

In [Additional units], [Not Used] is selected

1	For each Signal Tower light ([Red], [Amber], [Green], [Blue], and [White]), select [OFF], [Continuous ON], [Flashing pattern 1], [Flashing pattern 2], [Flashing pattern 3], [Flashing pattern 4], or [No change].
---	--

In [Additional units], [Multi-color unit] is selected

1	Select the color, [Red], [Amber], [Green], [Blue], [White], [Purple], [Light blue], or [No change].
2	Select the pattern, [OFF], [Continuous ON], [Flashing pattern 1], [Flashing pattern 2], [Flashing pattern 3], [Flashing pattern 4], or [No change].

**Using SNMP Notification**



**Using Send HTTP Command**

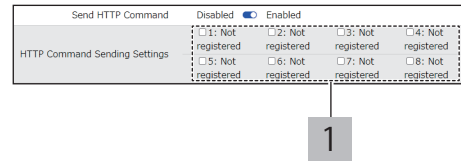

**Using Send MQTT**

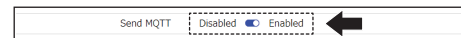

**Using Contact Output**

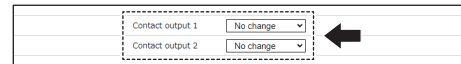

**Configuring Clear Conditions**



**Controlling Signal Tower Lights on This Product**

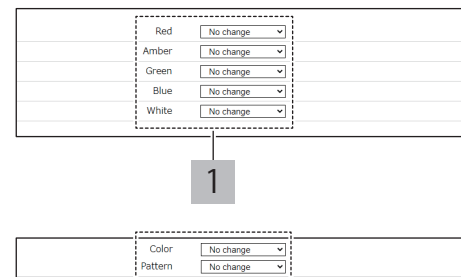

**Controlling Audio**

To play audio other than the presets, the audio needs to be registered."7.16. Setting Up Voice Registration" (☞ page 114)	
1	Select the audio, [Stop], [One-shot playback], [Repeat playback], or [No change]. <ul style="list-style-type: none"> <li>When [Repeat playback] is selected, specify the number of times for it to play.</li> </ul>
2	From [Audio Channel], specify the audio channel to play.

**Controlling Audio**

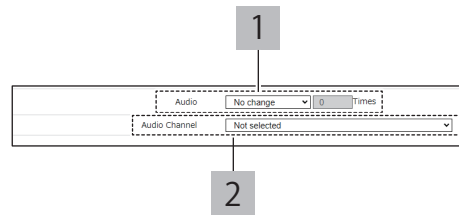

**Using Send Email**

To send email, setting up email notifications and email content is required.  
 "8.1.2. Setting Up Email Notification Settings" (☞ page 122)

1	Select the Subject and Body text.
2	Select the email recipients. <ul style="list-style-type: none"> <li>You can select multiple recipients.</li> <li>If the recipient is not registered, it will not be sent even when selected.</li> </ul>

**Using Send Email**

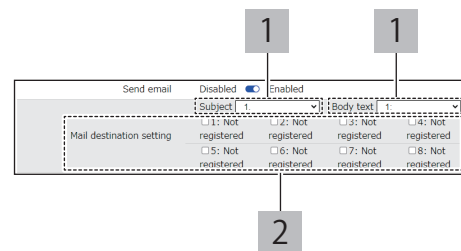

**Using SNMP Notification**

Before using SNMP notification, the SNMP Notification Function must be [Enabled].  
 "8.1.1. Setting Up SNMP (Trap Inform) Notification Settings" (☞ page 118)

**Using SNMP Notification**



**Using Send HTTP Command**

Before sending HTTP Commands, the HTTP Command must be registered.  
 "8.1.3. Setting Up HTTP Command Sending Settings" (☞ page 125)

**Using Send HTTP Command**

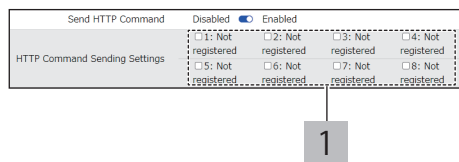

1	Select the HTTP Command Destination. <ul style="list-style-type: none"> <li>You can select multiple recipients.</li> <li>If the recipient is not registered, it will not be sent even when selected.</li> </ul>
---	---

**Using Send MQTT**

Before using Send MQTT, the Cloud function must be enabled.  
 "8.2. Using the Cloud" (☞ page 128)

**Using Send MQTT**



**Using Contact Output**

Before using contact output, the Contact Output Function must be [Enabled].  
 "8.1.4. Setting Up Contact Output Settings" (☞ page 127)

**Using Contact Output**

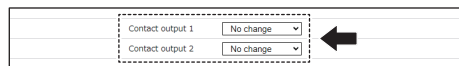

**Configuring Clear Conditions**

- Before clearing conditions, match detection settings must be set up.  
 "8.4.5. Contact Input Condition Monitoring" (☞ page 210)
- By setting this item, when the contact changes state ON → OFF, as per the condition specified in the [Match Detection Settings], the input time is reset.  
 "5.3.19. Contact Input Match Detection" (☞ page 68)

**Configuring Clear Conditions**



**8**

Click [Set] to apply the defined settings.

- For each port setting, click the [Set] button to apply the defined settings to the product. Settings for multiple ports cannot be updated at one time.

**9**

Contact input status monitoring is started.

- Restart is unnecessary.

### 8.4.5. Contact Input Condition Monitoring NHV Series (D model)

- This setting is used when monitoring the condition of contact inputs.
- For information on each item, refer to "9.3.4.2. Match Detection Settings" (👉 page 275).

#### 8.4.5.1. Setting Up Contact Input Condition

**1** From the [Monitoring Settings] tab, click [Match Detection Settings] to enter the [Contact input setting] - [Match Detection Settings] screen.

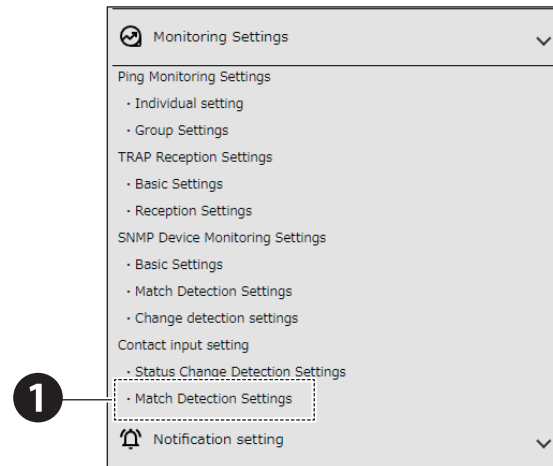

**2** Set the Condition Settings Number in the [Contact input setting] - [Match Detection Settings] screen.

- You can register up to 4 condition settings.

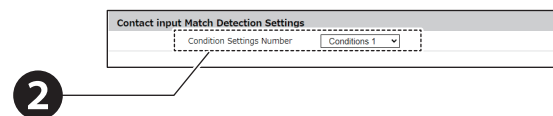

**3** Select a port number for the Conditions.

- You can register up to 4 port numbers.

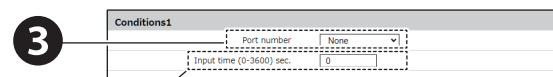

**4** Select the length of input time for the Conditions.

- If 0 is set, detection is disabled.



**5** Select [Enabled] or [Disabled] for the operation when Clear button pressed.

- By setting this item, when the Clear button is pressed, the condition's input time is reset. "5.3.19. Contact Input Match Detection" (👉 page 68)

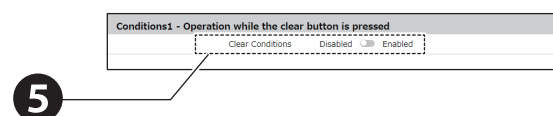



6

Select [Enabled] or [Disabled] for the [Action when there is a match].

- Enabled: Even after the first detect condition match, operation is executed every time a detect condition match occurs.
- Disabled: Operation is executed only the first time a detect condition match occurs, and not after even if other detect condition matches occur.
- When set to [None], perform the following operations to detect match again.

1	Run the Clear operation . • "5.3.21. Clear Operation Function" (☞ page 70)
2	Enable clear condition, and press the Clear button. • "8.3.3. Operating the Product with the Clear Button" (☞ page 177)
3	In [Contact input setting] - [Status Change Detection Settings], from [Clear Conditions], select the condition that you want to detect match again, and then change the state of contact input. • "8.4.5. Contact Input Condition Monitoring" (☞ page 210)

6

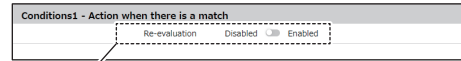

7

Set the operation when the condition matches.

**■ Controlling Signal Tower Lights on This Product**

Depending on the selections in [Basic Settings] - [Additional units], setup items may differ.

In [Additional units], [Not Used] is selected	
1	For each Signal Tower light ([Red], [Amber], [Green], [Blue], and [White]), select [OFF], [Continuous ON], [Flashing pattern 1], [Flashing pattern 2], [Flashing pattern 3], [Flashing pattern 4], or [No change].

In [Additional units], [Multi-color unit] is selected	
1	Select the color, [Red], [Amber], [Green], [Blue], [White], [Purple], [Light blue], or [No change].
2	Select the pattern, [OFF], [Continuous ON], [Flashing pattern 1], [Flashing pattern 2], [Flashing pattern 3], [Flashing pattern 4], or [No change].

**Controlling Signal Tower Lights on This Product**

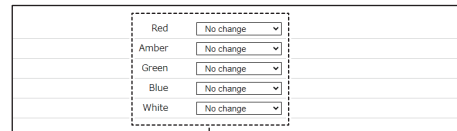

1

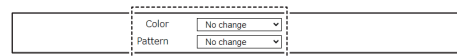

**Controlling Audio**

To play audio other than the presets, the audio needs to be registered."7.16. Setting Up Voice Registration" (📄 page 114)	
1	Select the audio, [Stop], [One-shot playback], [Repeat playback], or [No change]. <ul style="list-style-type: none"> <li>When [Repeat playback] is selected, specify the number of times for it to play.</li> </ul>
2	From [Audio Channel], specify the audio channel to play.

**Using Send Email**

To send email, setting up email notifications and email content is required.  
 "8.1.2. Setting Up Email Notification Settings" (📄 page 122)

1	Select the Subject and Body text.
2	Select the email recipients. <ul style="list-style-type: none"> <li>You can select multiple recipients.</li> <li>If the recipient is not registered, it will not be sent even when selected.</li> </ul>

**Using SNMP Notification**

Before using SNMP notification, the SNMP Notification Function must be [Enabled].  
 "8.1.1. Setting Up SNMP (Trap Inform) Notification Settings" (📄 page 118)

**Using Send HTTP Command**

Before sending HTTP Commands, the HTTP Command must be registered.  
 "8.1.3. Setting Up HTTP Command Sending Settings" (📄 page 125)

1	Select the HTTP Command Destination. <ul style="list-style-type: none"> <li>You can select multiple recipients.</li> <li>If the recipient is not registered, it will not be sent even when selected.</li> </ul>
---	---

**Using Send MQTT**

Before using Send MQTT, the Cloud function must be enabled.  
 "8.2. Using the Cloud" (📄 page 128)

**Using Contact Output**

Before using contact output, the Contact Output Function must be [Enabled].  
 "8.1.4. Setting Up Contact Output Settings" (📄 page 127)

**Controlling Audio**

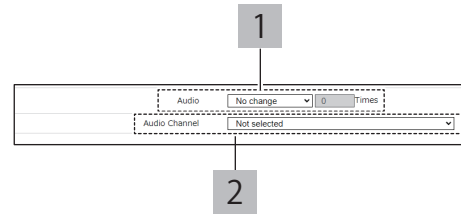

**Using Send Email**

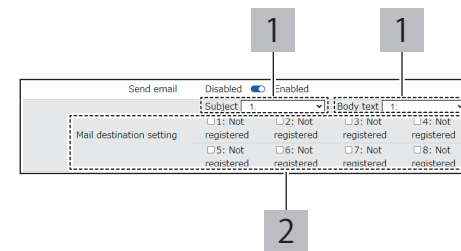

**Using SNMP Notification**



**Using Send HTTP Command**

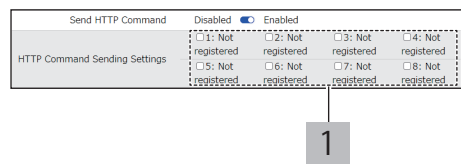

**Using Send MQTT**



**Using Contact Output**

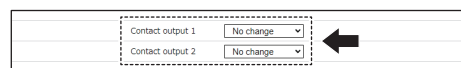

**8**

Click [Set] to apply the defined settings.

- For each condition setting, click the [Set] button to apply the defined settings to the product. Multiple condition settings cannot be updated at one time.

**9**

Contact input condition monitoring is started.

- Restart is unnecessary.

### 8.4.6. Detecting Email NHV Series (M model)

- Set up to use the detect email function.
- For information on each item, refer to "9.3.5. Mail Detection Setting Screen" (page 278).

#### 8.4.6.1. Setup Procedure

##### ● Set the Mail Server to Monitor

**1** From the [Mail detection setting] tab, click [Mail server settings] to enter the [Mail server settings] screen.

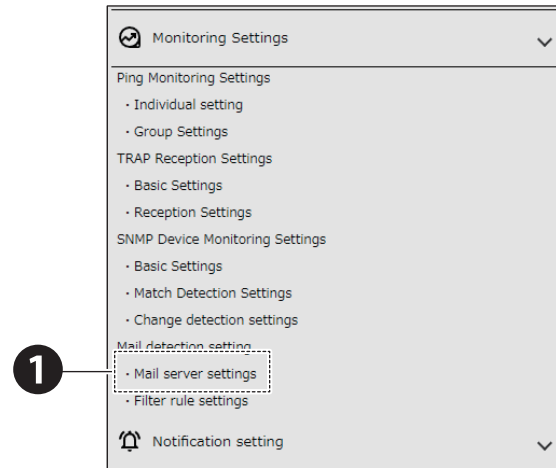

**2** In the [Mail server settings], set the [Incoming mail server], [Protocol], [Mail server port number], [Authentication method], [Encryption Method], [Username], [Password], [Mail check interval], [Authentication method], and [Mail check interval (10-3600) sec.].

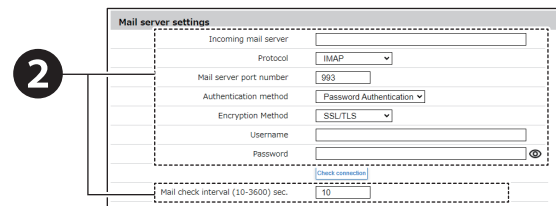

- For the Authentication method, you can select [OAuth2] or [Password Authentication] when one of the following addresses is specified as the [Incoming mail server]. When any other server is specified, authentication is fixed as [Password Authentication].
  - Gmail server: imap.gmail.com  
pop.gmail.com
  - Outlook server: outlook.office365.com

##### When Connecting to Gmail

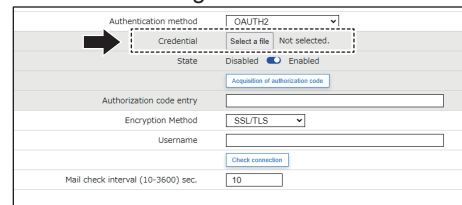

##### When Connecting to Outlook

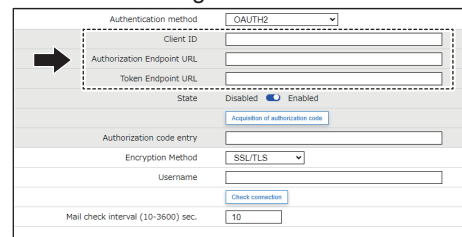

##### ■ Connecting to Gmail\*1 \*2

Register the credential file in the [Credential] section.

##### ■ Connecting to Outlook\*1 \*2

Register the [Client ID], [Authorization Endpoint URL] and [Token Endpoint URL].

\*1 Set the [State] to [Enabled].

\*2 Click the [Acquisition of authorization code] button, and from the authentication screen that pops up, get the authentication code. In the [Authentication code entry] field, enter the authentication code that you retrieved.

**[POP] is Selected in [Protocol]**

- When [POP] is selected in [Protocol], [Delete the mail in the server after receiving] is set.
- By enabling this function, email detected as having been received by this product are deleted from the mail server. Do not enable this function if you handle important emails.

**3**

Press the [Check connection] button to confirm you can connect to the mail server with the defined settings.

- When [OAUTH2] is specified in [Authentication method], get the authentication code, and enter the authentication code that you retrieved in the [Authentication code entry] field again.

**3****4**

Click [Set] to apply the defined settings.

## ● Set Filter Rules

**1** From the [Mail detection setting] tab, click [Filter rule settings] to enter the [Filter rule settings] screen.

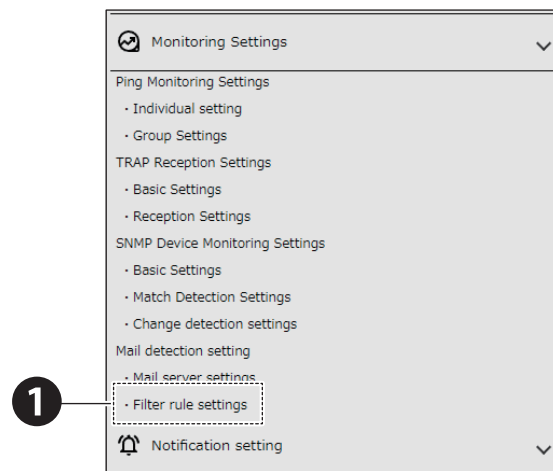

**2** Select a condition.

- You can register to detect from 1 to 20 conditions.
- For a single condition, you can register up to 5 rules.
- By registering multiple rules, you can fine tune the detection range.

**3** Select the range of conditions, [Meets all of the following], [Meets one of the following], and [None].

**4** Select what to detect, from [Sender], [Subject], and [Body text].

**5** Enter a string in the [Keyword] field, and select the Judgment condition from [Matches with], [Beginning with], [Include], and [Be free of].

**6** To set more conditions, register a second or subsequent rules.

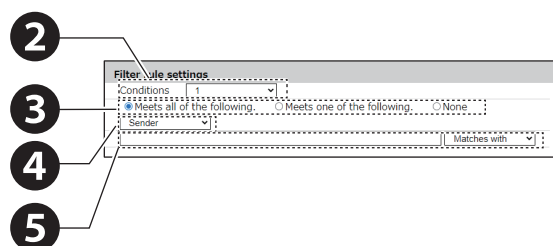

**7**

Set the operation when the condition matches.

**Controlling Signal Tower Lights on This Product**

Depending on the selections in [Basic Settings] - [Additional units], setup items may differ.

In [Additional units], [Not Used] is selected	
1	For each Signal Tower light ([Red], [Amber], [Green], [Blue], and [White]), select [OFF], [Continuous ON], [Flashing pattern 1], [Flashing pattern 2], [Flashing pattern 3], [Flashing pattern 4], or [No change].

In [Additional units], [Multi-color unit] is selected	
1	Select the color, [Red], [Amber], [Green], [Blue], [White], [Purple], [Light blue], or [No change].
2	Select the pattern, [OFF], [Continuous ON], [Flashing pattern 1], [Flashing pattern 2], [Flashing pattern 3], [Flashing pattern 4], or [No change].

**Controlling Audio**

To play audio other than the presets, the audio needs to be registered."7.16. Setting Up Voice Registration" (☞ page 114)

1	Select the audio, [Stop], [One-shot playback], [Repeat playback], or [No change]. <ul style="list-style-type: none"> <li>When [Repeat playback] is selected, specify the number of times for it to play.</li> </ul>
2	From [Audio Channel], specify the audio channel to play.

**Using Send Email**

To send email, setting up email notifications and email content is required.

"8.1.2. Setting Up Email Notification Settings" (☞ page 122)

1	Select the Subject and Body text.
2	Select the email recipients. <ul style="list-style-type: none"> <li>You can select multiple recipients.</li> <li>If the recipient is not registered, it will not be sent even when selected.</li> </ul>

**Using SNMP Notification**

Before using SNMP notification, the SNMP Notification Function must be [Enabled].

"8.1.1. Setting Up SNMP (Trap Inform) Notification Settings" (☞ page 118)

**Using Send HTTP Command**

Before sending HTTP Commands, the HTTP Command must be registered.

"8.1.3. Setting Up HTTP Command Sending Settings" (☞ page 125)

**Controlling Signal Tower Lights on This Product**

1

**Controlling Audio**

2

**Using Send Email**

2

**Using SNMP Notification**

**Using Send HTTP Command**

1

1

Select the HTTP Command Destination.

- You can select multiple recipients.
- If the recipient is not registered, it will not be sent even when selected.

### ■ Using Send MQTT

Before using Send MQTT, the Cloud function must be enabled.

"8.2. Using the Cloud" (👉 page 128)

### Using Send MQTT



8

Click [Set] to apply the defined settings.

- For each condition, click the [Set] button to apply the defined settings to the product. Multiple conditions cannot be updated at one time.



## 8.5. Doing Maintenance

### 8.5.1. Checking the Product Settings

- You can check the product settings and product status from the home screen and status LED on the main unit.
- On the home screen, you can check the main unit information and list of current settings.
- This section describes how to display the home screen.

#### 8.5.1.1. Screen Display Procedure

##### ● Go to the Setup Screen

Before Logging in to the Web Setup Screen

- 1 From a Web browser, enter the IP address of this product.
  - If this product is being used for the first time, or if the product is initialized, refer to "7. Before Use" (page 91).

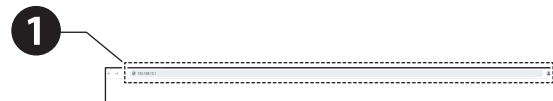

- 2 On the login screen, enter the user name and password, and click the [Login] button.

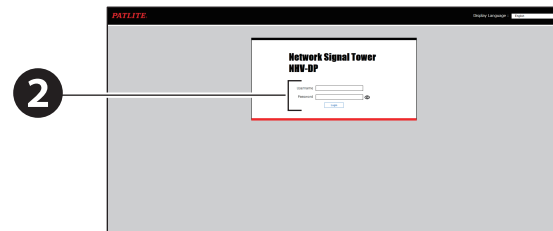

- 3 The Home screen appears.

Home Screen

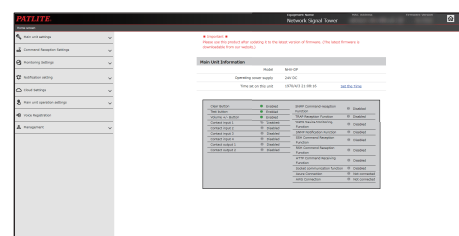

**When Logged in to the Web Setup Screen**

**1** In the upper right corner of the current Web Setup Screen, press the  button .

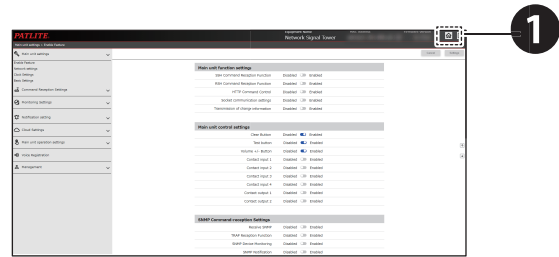

**2** The Home screen appears.

**Home Screen**

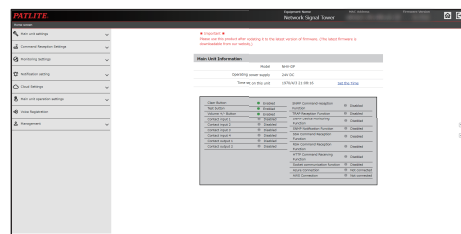

**How to Read the Home Screen**

No.	Name	Description
①	Equipment Name	Indicate the equipment name registered in Basic Settings - Main unit settings.
②	MAC Address	Check the MAC Address on the product.
③	Firmware Version	Check the firmware version that the product is currently using.
④	Button	There are the home button and the logout button in the home screen.
⑤	Main Unit Information	Check the product model name, operating power supply, and clock.
⑥	Product Function List	Check the setup status of each function.

### 8.5.1.2. Using Status LED to Check the Status of this Product

You can check the product status by checking the status LED on the main unit.

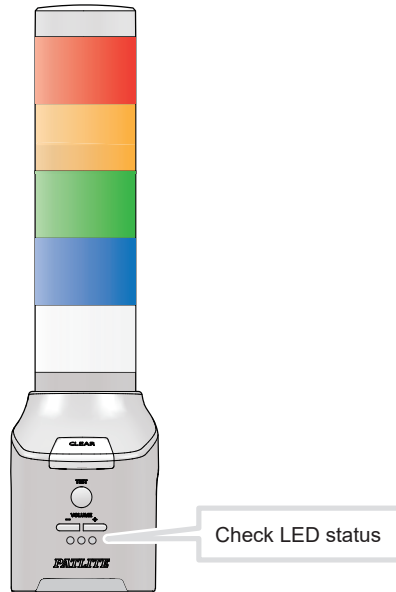

LED Status	Description
Blue light	Product is operating.
Green light	Product is starting up.
Flashing Red	Product is in an error state.
Magenta light	Product initialization is complete.
Amber light	Product changed to DHCP mode.

**Point**

- For information on DIP Switches operation processes, refer to the following.
  - "7.1. Enabling DHCP Function" (☞ page 92)
  - "8.5.2.2. Initialization with DIP Switches" (☞ page 223)

## 8.5.2. Initializing This Product

- From the Web Setup Screen, you can initialize the settings of the product.  
For information on setup items, refer to "9.8.1. Settings Initialization" (☞ page 307).
- Using DIP switches, you can perform operations such as initialize network settings only, or resetting to the factory default state.

### 8.5.2.1. Initialization on the Web Setup Screen

**1** From the [Management] tab click [Initialization], to enter the [Initialization] screen.

- If the current setting information is required, extract the configuration data beforehand.  
"8.5.7.1. Extracting the Configuration" (☞ page 231)
- If the log is required, download the Event Log beforehand.  
"8.5.9.2. Downloading the Log" (☞ page 234)

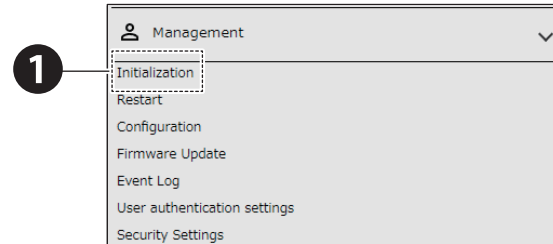

**2** Select the required initialization items.

#### ■ Initialize Including Network Settings

- Select the [Initialize network] check box.
- [Network Settings] refer to items in the [Network Settings] screen, such as [IP Address], [Subnet Mask], [Prefix length], [Default Gateway], [DNS Server Address], and [Host Name].
- When network settings are also initialized, as the IP address is reset to the factory default, network settings have to be set up again.

#### ■ Initializing Audio Registered in [Voice Registration] Screen

- Select the [Initialize Audio Data] check box.
- Audio data registered from the Web Setup Screen is erased when initialization is executed.

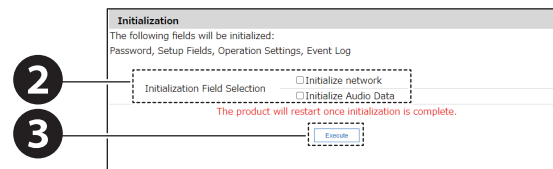

**3** Click the [Execute] button.

**4** Settings are initialized.

- After settings are initialized, the product is automatically restarted.

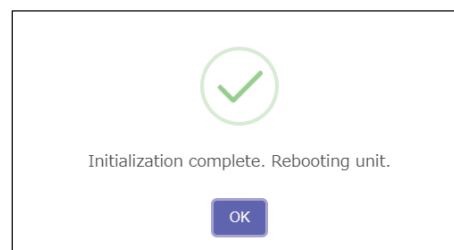

### 8.5.2.2. Initialization with DIP Switches

## ! WARNING

**!** Before any work is done, disconnect the power.

## ! CAUTION

- ⊘ Do not use excessive force on this product. Failure to follow this instruction could result in deformed frame and product damage.
- ⊘ Do not use sharp tipped objects with this product. Operation may become impossible as scratches develop on switches and switch contacts are interfered with.
- ⊘ Do not set the DIP switch ON if it is not required.

**1** Turn off the power on the product.

**2** Set DIP switches ON in accordance with how much to initialize.

Switch Number	Initialize only Network Settings	Initialize and Return to Factory Default Settings
1	ON	ON
2	ON	ON
3	OFF	ON
4	OFF	ON

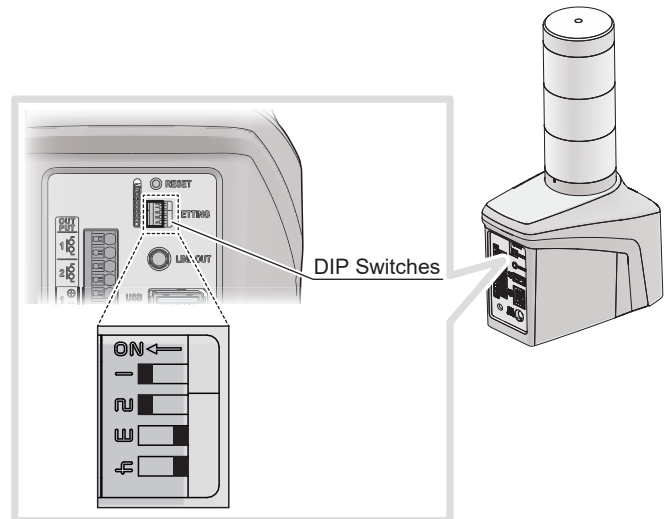

**3** Power up the product.

**4** Settings are initialized.

- When initialization is complete, the status LED changes from Green to Magenta.
- In NHV Series, following messages are played at the initializing.
  - Initializing only Network settings  
"The network setup was initialized. Return the setting switch and reoot the main unit."
  - Initializing and Returning to Factory Default Settings  
"The setting has been initialized. Return the setting switch and restart the main unit."

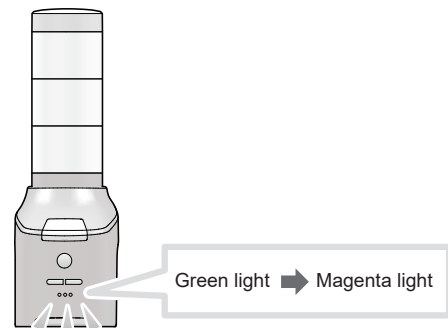

**5** After initialization is complete, turn the power off.

**6** Reset all the DIP switches OFF.

- As required, start up and set up the product.

### 8.5.3. Restarting this Product

- You can restart this product from the Web Setup Screen. For information on setup items, refer to "9.8.2. Restart" (page 308).
- You can also restart this product with the Reset button.
- To prevent accidental operation, the Reset button is located on the back of the product, inside a hole.

#### 8.5.3.1. Restarting from the Web Setup Screen

**1** From the [Management] tab click [Restart] to enter the [Restart] screen.

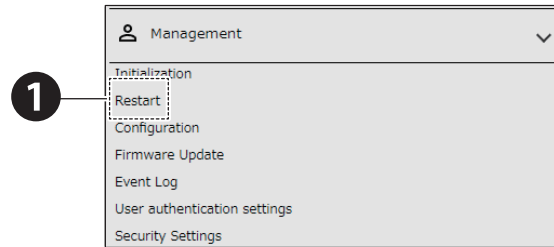

**2** Click the [Restart] button.



**3** Restarting begins.

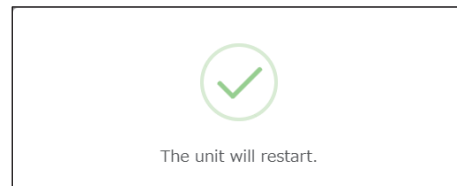

### 8.5.3.2. Restarting with the Reset Button

**1**

On the back of the main unit, press the Reset Button with a wire about 1 mm in diameter (such as a straightened paper clip).

- Do not press too hard. Failure to follow this instruction could result in equipment damage.
- Pressing the Reset button restarts the system, however, all output terminal blocks are open during this time.  
Be cautious when pressing the Reset button while the system is in operation.
- Do not use excessive force on this product. Failure to follow this instruction could result in deformed frame and product damage.
- Do not use sharp tipped objects with this product. Operation may become impossible as scratches develop on switches and switch contacts are interfered with.

**2**

Restarting begins.

- For action in restarting, refer to "6.6.3. Checking at Startup" (☞ page 90).

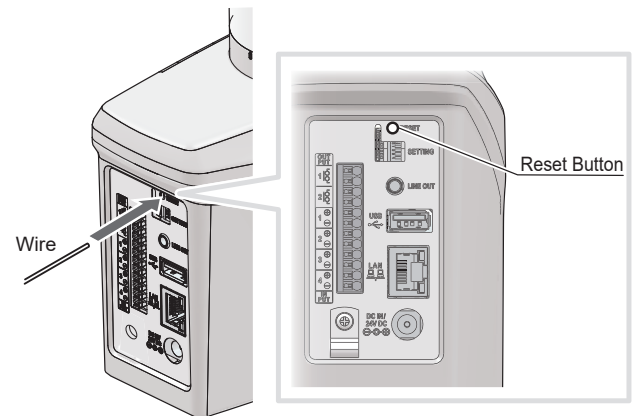

### 8.5.4. Changing the Sound Volume

- From the Web Setup Screen, change the volume all at once of all channels played by all playback events on this product.
- Change the volume separately for the speaker and line out.
- For information on setup items, refer to "9.1.4. Basic Settings" (page 244).
- For buzzer and speaker volume, change the volume using the volume buttons on the front of the speaker.
- On the NHB, adjust the speaker volume from three levels.
- On the NHV, adjust the volume on both speaker and line out from 16 levels.

**CAUTION**

❗ If audio is distorted or cracked, turn down the volume.  
Failure to follow this instruction could result in speaker damage.

#### 8.5.4.1. Adjusting the Volume on the Web Setup Screen

**1** From the [Main unit settings] tab, click [Basic Settings] to enter the [Basic Settings] screen.

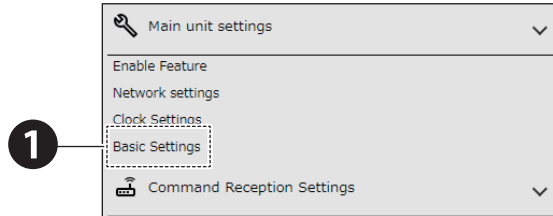

**2** In the [Basic Settings] screen, use the slider to adjust the speaker volume.

**Changing the Buzzer Volume** NHB Series

- In the [Main Unit Information] screen, use the pull-down to adjust the line out volume.

**Changing the Speaker Volume** NHV Series

- In the [Main Unit Information] screen, use the slider to adjust the speaker volume.
- To mute the volume, select the [Mute] check box to the right of the slider.  
Turning off the power or restarting disables mute.

**Changing the Line Out Volume** NHV Series

- In the [Main Unit Information] screen, use the slider to adjust the line out volume.

#### Changing the Buzzer Volume

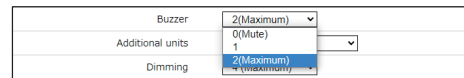

#### Changing the Speaker Volume



#### Changing the Line Out Volume

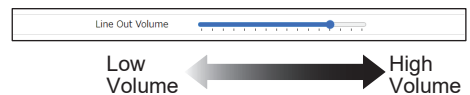

**3** Click [Set] to apply the defined settings.



### 8.5.4.2. Adjusting the Volume with + / - Volume Control Buttons

**1** Log in to the Web Setup Screen.

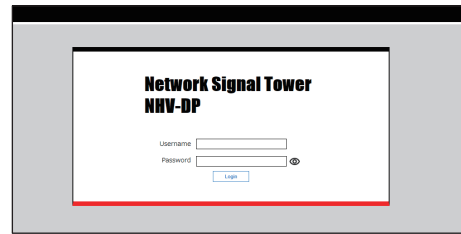

**2** From the [Main unit settings] tab, click [Enable Feature] to enter the [Main unit control settings] screen.

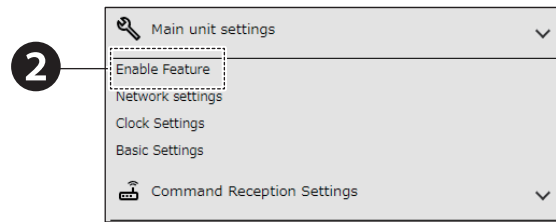

**3** In the [Main unit control settings] set [Volume +/- Button] to [Enabled].

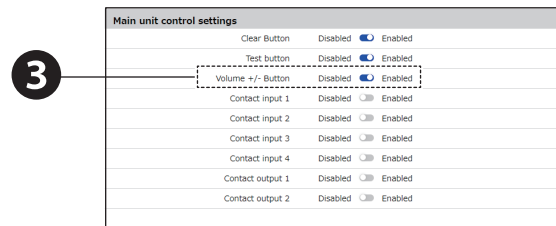

**4** Click [Set] to apply the defined settings.

**5** Press the +Volume and -Volume buttons on the main unit to adjust the volume.

- Press the +Volume button to increase the volume by 1.
- Press the -Volume button to decrease the volume by 1.
- Each press of the button changes the volume one time.
- When adjusting the volume, the following sound is emitted .

	Adjusting (min.)	Adjusting	Adjusting (max.)
NHV Series	None	"Pop"	Double "Pop"
NHB Series	None	"Beep"	

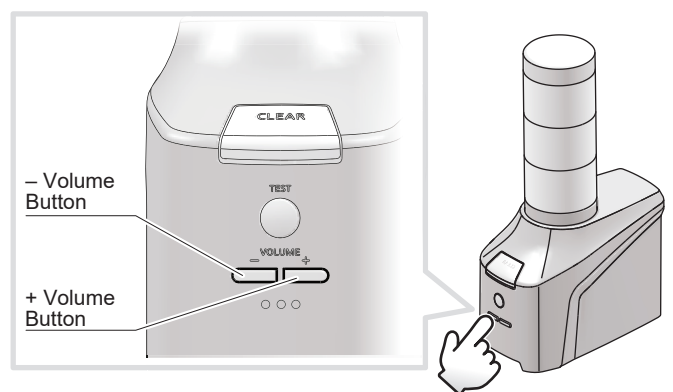

### 8.5.4.3. Muting the Volume NHV Series

**1** Log in to the Web Setup Screen.

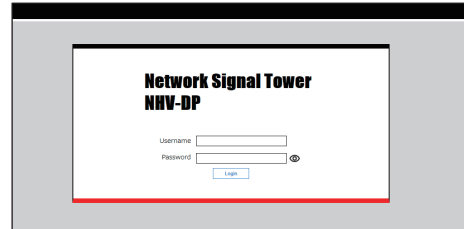

**2** From the [Main unit settings] tab, click [Enable Feature] to enter the [Main unit control settings] screen.

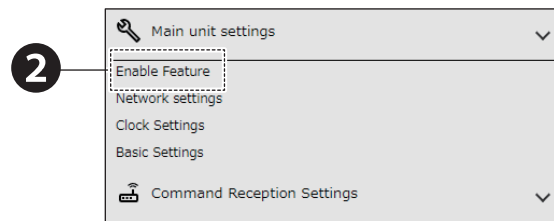

**3** In the [Main unit control settings] set [Volume +/- Button] to [Enabled].

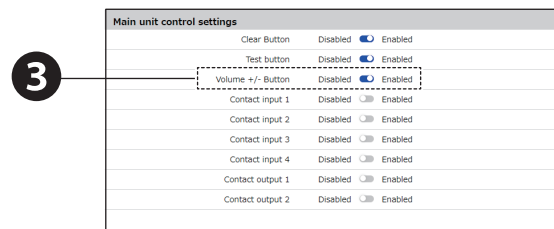

**4** Click [Set] to apply the defined settings.

**5** Press and hold the -Volume button on the main unit for at least two seconds to mute the volume.

- When muted, the status LED flashes blue three times.
- Press the +Volume button to disable mute.
- Turning off the power or restarting disables mute.

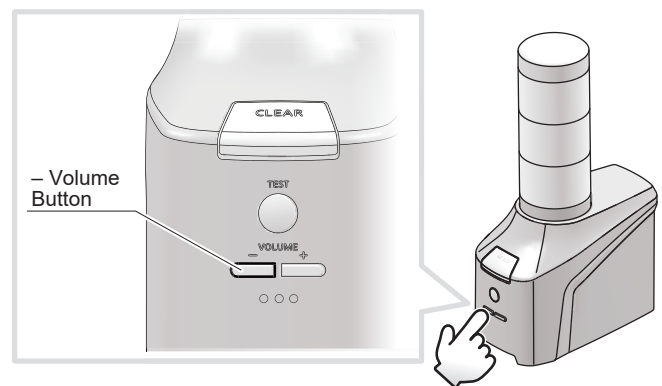

Press for 2 seconds or longer

### 8.5.5. Verifying the Self-test Operation

- You can set the operation for when the Test button is pressed from the Web Setup Screen.
- For information on setup items, refer to "9.6.2. Test Button Setting" (☞ page 300).

#### 8.5.5.1. Enabling the Test Button Function

**1** From the [Main unit operation settings] tab, open [Test button settings].

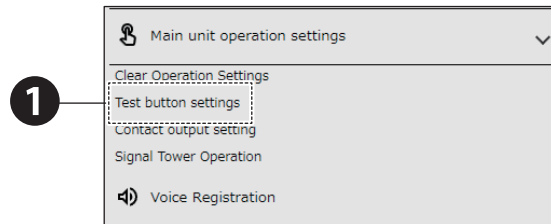

**2** Set a notification for when the Test button is pressed.

##### ■ Using Send Email

To send email, setting up email notifications and email content is required.

"8.1.2. Setting Up Email Notification Settings" (☞ page 122)

<b>1</b>	Select the Subject and Body text.
<b>2</b>	Select the email recipients. <ul style="list-style-type: none"> <li>• You can select multiple recipients.</li> <li>• If the recipient is not registered, it will not be sent even when selected.</li> </ul>

##### Using Send Email

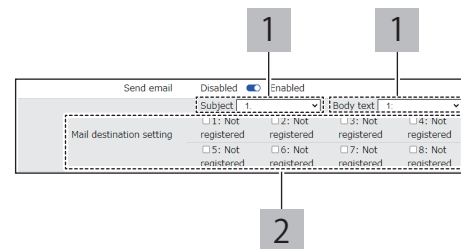

##### ■ Using SNMP Notification

Before using SNMP notification, the SNMP Notification Function must be [Enabled].

"8.1.1. Setting Up SNMP (Trap Inform) Notification Settings" (☞ page 118)

##### Using SNMP Notification

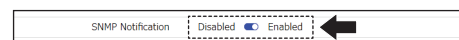

##### ■ Using Send HTTP Command

Before sending HTTP Commands, the HTTP Command must be registered.

"8.1.3. Setting Up HTTP Command Sending Settings" (☞ page 125)

<b>1</b>	Select the HTTP Command Destination. <ul style="list-style-type: none"> <li>• You can select multiple recipients.</li> <li>• If the recipient is not registered, it will not be sent even when selected.</li> </ul>
----------	---

##### Using Send HTTP Command

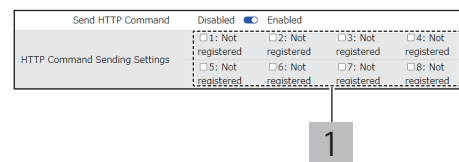

##### ■ Using Send MQTT

Before using Send MQTT, the Cloud function must be enabled.

"8.2. Using the Cloud" (☞ page 128)

##### Using Send MQTT

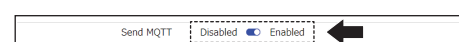

**3** Click [Set] to apply the defined settings.

**4** Press the Test button.

The test operation is started.  
 • After test operation, press the clear button to return to normal operation.

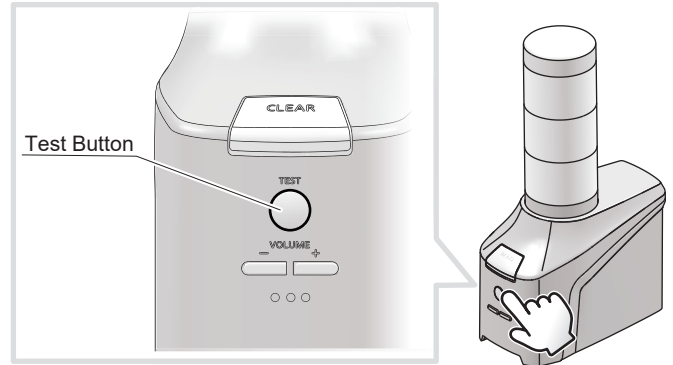

### 8.5.6. Changing User Authentication Settings

- You can edit passwords for logging in to this product.
- After completing setup, you can use the passwords from the next login.
- For information on setup items, refer to "9.8.6. User Authentication Settings" (👉 page 312).

#### 8.5.6.1. User Authentication Settings

**1** From the [Management] tab, click [User authentication settings] to enter the [Changing user credentials] screen.

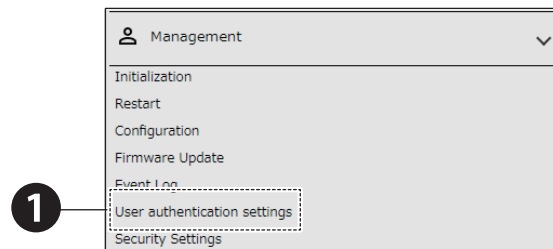

**2** In [New Username], set a new user name.

**3** In [New password], set a new password.

**4** In [Verify Password], enter the set password.

**5** Click [Set] to apply the defined settings.

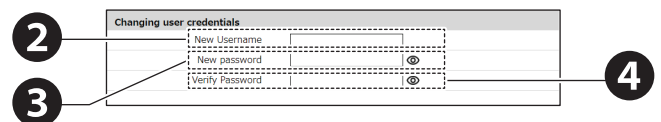

### 8.5.7. Exporting and Importing Product Settings (Configuration)

- You can extract the product settings and save them to your computer as configuration data.
- There are two files of config data that can be extracted: operation setting information (config.ini) and audio data (sound\_cfg.json, NHV series only).
- Select configuration data extracted from the product for writing.
- For information on setup items, refer to "9.8.3. Configuration" (👉 page 309).

#### 8.5.7.1. Extracting the Configuration

**1** From the [Management] tab click [Configuration] to enter the [Reading Configuration Data] screen.

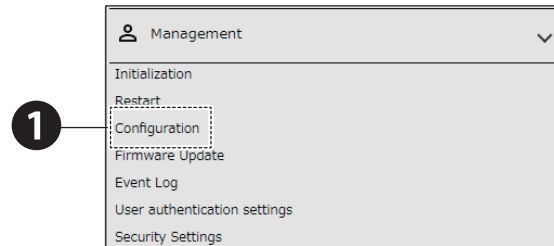

**2** From [Reading Configuration Data], click [Read] to save the configuration data to your computer.

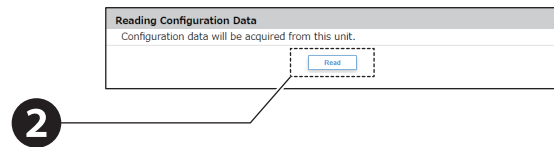

- The configuration data consists of operation settings registered in the main unit. The following content is not included in configuration data.
  - Network Settings
  - Cloud Settings
  - Security Settings
- If the multiple file download confirmation dialog is displayed, select "Allow".

### 8.5.7.2. Writing to Configuration

**1** From the [Management] tab click [Configuration] to enter the [Writing Configuration Data] screen.

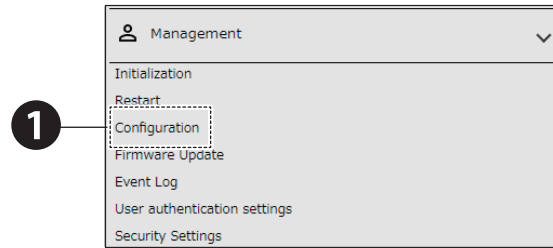

**2** From [Writing Configuration Data], click [Select a file] to select the configuration data to write to the product.

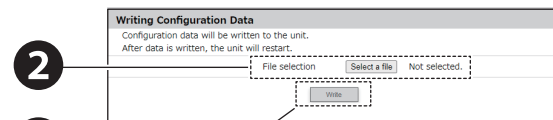

- You can carry forward not only NHB and NHV series settings, but also NH-FB and NH-FV series settings.

Note: Do not register configuration data from products other than those listed above. Failure to follow this instruction could result in product damage.

Write the config data one file at a time.

**3** From [Writing Configuration Data], click the [Write] button to begin the write operation.

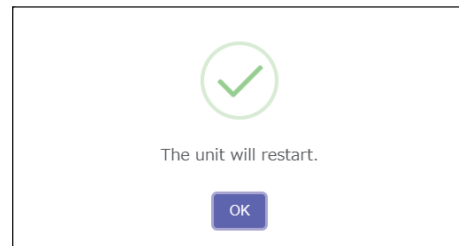

- After the write is complete, the product restarts automatically.

**4** When voice data is written, click [Voice Registration] to enter the [Voice Registration] screen.

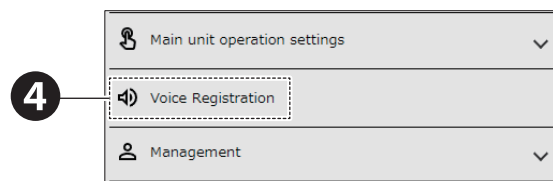

**5** Select the channel you want to register the voice and click the [Add to Channel List] button.

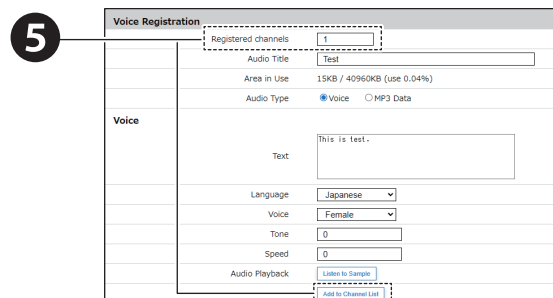

**6** Click [Set] to apply the defined settings.

### 8.5.8. Updating Firmware

- You can update the product firmware by selecting the firmware saved to your computer or other location.
- For information on setup items, refer to "9.8.4. Updating Firmware" (👉 page 310).

**⚠ CAUTION**

- ⊘ • While updating, do not disconnect the power or LAN cables.  
Failure to follow this instruction could result in product failure.
- ❗ • Before updating, check the version and models supported by the firmware.  
Updating with unsupported firmware could result in equipment damage.

#### 8.5.8.1. Updating Firmware

**1** From the [Management] tab, click [Firmware Update] to enter the [Firmware Update] screen.

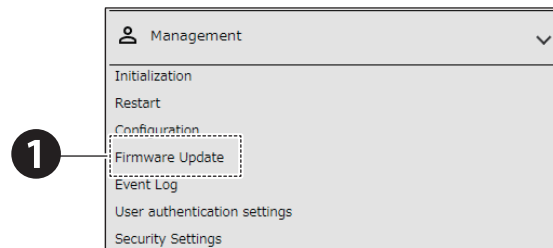

**2** In the [Firmware Update] screen, click [Select a file] and select the firmware to write to this product.

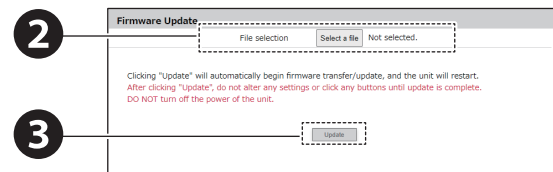

**3** Click [Execute] to start updating.

- After the update is complete, the product restarts automatically.

### 8.5.9. Checking the Event Log

- Displays the product’s event log.
- You can display the latest 100 logged events.
- You can click [Download Event Log] to download the event log file.
- The event log can have up to 1000 events.
- For information on setup items, refer to "9.8.5. Event Log" (👉 page 311).

**⚠ CAUTION**

⚠ The event log is cleared when the following operation is performed.

- From the [Initialization] screen, execute initialization
- Initialize and Return to Factory Default Settings in DIP Switches

#### 8.5.9.1. Displaying the Event Log

**1** From the [Management] tab click [Event Log] to enter the [Event Log] screen.

- The [Event Log] screen is displayed.

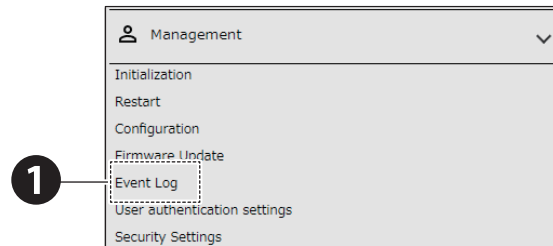

#### 8.5.9.2. Downloading the Log

**1** From the [Management] tab click [Event Log] to enter the [Event Log] screen.

- The [Event Log] screen is displayed.

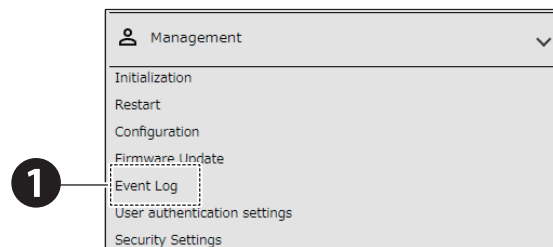

**2** Click the [Download] button to download the event log file.

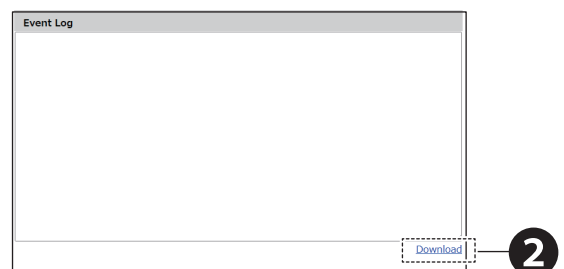



### 8.5.9.3. Event Log contents

Displayed Event Name	coldStart	Displayed Event Contents	No Display
Event Details	Records from the start up time.		

Displayed Event Name	ACCESS	Displayed Event Contents	No Display
Event Details	Records at the moment of authentication failure. • At the moment of a Web login failure		

Displayed Event Name	MAIL	Displayed Event Contents	"send mail" "Mail sending failure" "SMTP authentication mail sending failure" "POP authentication mail sending failure"
Event Details	"send mail": It records at the moment of an E-mail transmission. "Mail sending failure" : It records at the moment of an E-mail transmission failure. "SMTP authentication mail sending failure" : It records at the moment of the SMTP authentication mail failure. "POP authentication mail sending failure": It records at the moment of the POP authentication mail failure.		

Displayed Event Name	TRAP	Displayed Event Contents	"received"
Event Details	"received" : It records when the registered Trap is received.		

Displayed Event Name	PING	Displayed Event Contents	"error occurred", the IP address, the registered number, and the group "error recovered", the IP address, the registered number, and the group *
Event Details	It records when the Ping monitor status changes. "error occurred" : It records with the target IP address and the target group when an abnormality event in the Ping monitor occurs. "error recovered" : It records with the target IP address and the target group when an abnormality in the Ping monitor is restored. * "non" is displayed when the target is not belong to the group.		

Displayed Event Name	CLEAR	Displayed Event Contents	""CLEAR" Button" "SNMP" "RSH/SSH" and designated sender IP address "PNS Command" "Web Setup Tool" "HTTP Command" "Azure" "AWS"
Event Details	The Signal Tower is returned to its normal operating status during operation. ""CLEAR" Button" : It records when the clear button to this product is pushed. "SNMP" : It records when a "CLEAR" has been executed by the SNMP Command (controlLightSnmClear). "RSH/SSH" : It records when a "CLEAR" has been executed by the RSH Command, and displays the designated sender IP address. "PNS Command" : It records when a "CLEAR" has been executed by the PNS Command. "Web Setup Tool" : It records when a "Clear" has been executed from the Web Setup Screen. "HTTP Command" : It records when a "clear" has been executed by the HTTP Command. "Azure" : It records when a "clear" has been executed from the Azure. "AWS" : It records when a "clear" has been executed from the AWS.		

Displayed Event Name	RSH/SSH	Displayed Event Contents	"alert", command argument, and the designated sender IP address "status" "test" "sound", audio playback channel, and the designated sender IP address "stop" and the designated sender IP address "color" *
Event Details	<p>It records when the RSH/SSH Command is executed. (The "Clear" execution is not included)</p> <p>"alert" : When the "alert" command is executed, it records the argument and designated sender IP address.</p> <p>"status" : The "status" command is recorded at the time of execution.</p> <p>"test" : The "test" command records at the time of execution.</p> <p>"sound" : When the "sound" command is executed, it records the audio playback channel and designated sender IP address.</p> <p>"stop" : When the "stop" command is executed, it records the designated sender IP address.</p> <p>"color" : The "color" command records at the time of execution.</p> <p>*In RSH command, an IP address is not written in cases where the designated sender address is inactivated.</p>		

Displayed Event Name	SNMP	Displayed Event Contents	"Sound controlled" and audio playback channel "Sound stop controlled" "Signal controlled" and the index number of OID "Get status" "Digital out" "Signal/Sound controlled" and command argument
Event Details	<p>"Sound controlled" : It records when audio playback is played by SET command of SNMP.</p> <p>"Sound stop controlled" : It records when playing audio playback is stopped by SET command of SNMP.</p> <p>"Signal controlled" : It records when Signal Tower is operated by SET command of SNMP.</p> <p>"Get status" : It records when GET command of SNMP is received.</p> <p>"Digital out" : It records when digital outputs are operated SET command of SNMP.</p> <p>"Signal/Sound controlled" : It records when Signal Tower and audio playback are operated by SET command of SNMP.</p>		

Displayed Event Name	SOCKET	Displayed Event Contents	"RECV" "RECV PHN" "SEND" "SEND PHN" "ERROR"
Event Details	<p>"RECV" : When the PNS command is executed and this product is operated, it records the ID.</p> <p>"RECV PHN" : When the PHN command is executed and this product is operated, it records the Request Command.</p> <p>"SEND" : When the PNS/PHN command is executed and this product responds, it records "ACK" or "NAK". When the Get status in PNS command is executed and this product responds, it records the Response Command "G".</p> <p>"SEND PHN" : When the PHN command is executed and this product responds, it records the Response Command "R".</p> <p>"ERROR" : It records when the PNS/PHN command is executed and the error occurs.</p>		

Displayed Event Name	SNMPGET	Displayed Event Contents	"SNMP matched the condition" "SNMP release the condition" "SNMP detected the change"
Event Details	<p>It will record, depending on the Supported equipment SNMP Monitor Operation.</p> <p>"SNMP matched the condition" : It records, depending on the condition agreement operation.</p> <p>"SNMP release the condition" : It records, when the condition is canceled.</p> <p>"SNMP detected the change" : It records, when it operates by a Change Detection.</p>		

Displayed Event Name	DIN	Displayed Event Contents	The "digital input operation" port number and status "digital input state change ON" and port number "digital input state change OFF" and port number
Event Details	"digital input state change ON" : When it changes to ON for the digital input set up signal definition, it is recorded. "digital input state change OFF" : When it changes to OFF for the digital input set up signal definition, it is recorded.		
Displayed Event Name	COND	Displayed Event Contents	"matched the condition setting" and condition number
Event Details	"matched the condition setting" : It records, depending on the digital input condition agreement.		
Displayed Event Name	DOUT	Displayed Event Contents	"Digital Output", port number, and status "Digital Output Busy" and status
Event Details	"Digital Output" : When it changes to ON or OFF for the digital output set up signal definition, it is recorded. "Digital Output Busy" : When it changes to ON or OFF for the busy output set up signal definition, it is recorded.		
Displayed Event Name	HTTP	Displayed Event Contents	"CONTROL"
Event Details	It records when the HTTP Command is executed. (The "clear" execution is not included)		
Displayed Event Name	HTTPSEND	Displayed Event Contents	Command name and "HTTP send command" Command name and "HTTP command failure"
Event Details	"HTTP send command" : It records when HTTP command is send. "HTTP command failure" : It records when sending HTTP command fails.		
Displayed Event Name	AZURE	Displayed Event Contents	"CONNECTED" "DISCONNECTED" "CONTROLLED"
Event Details	"CONNECTED" : It records when connecting to Azure. "DISCONNECTED" : It records when closing the connection to Azure. "CONTROLLED" : It records when Azure operation is run.		
Displayed Event Name	AWS	Displayed Event Contents	"CONNECTED" "CONNECTION_FAILED" "DISCONNECTED" "CONTROLLED"
Event Details	"CONNECTED" : It records when connecting to AWS. "CONNECTION_FAILED" : It records when AWS connection fails. "DISCONNECTED" : It records when closing the connection to AWS. "CONTROLLED" : It records when AWS operation is run.		
Displayed Event Name	MAILDETECT	Displayed Event Contents	"Filter matched" and the matched filter number "Failed to receive email"
Event Details	"Filter matched" : It records when receiving the mail that is matched the set filter. "Failed to receive email" : It records when receiving emails fails.		

\* Displayed events within the double quotes are not recognized in the log.

## 9. Web Setup Screen Descriptions

- This section describes the settings for using the various functions.
- To implementing the various settings, click the item you want to set. The selected set up screen is displayed.
- If you want to move from one of the various setting screens to another setting screen, click the item you want to set.

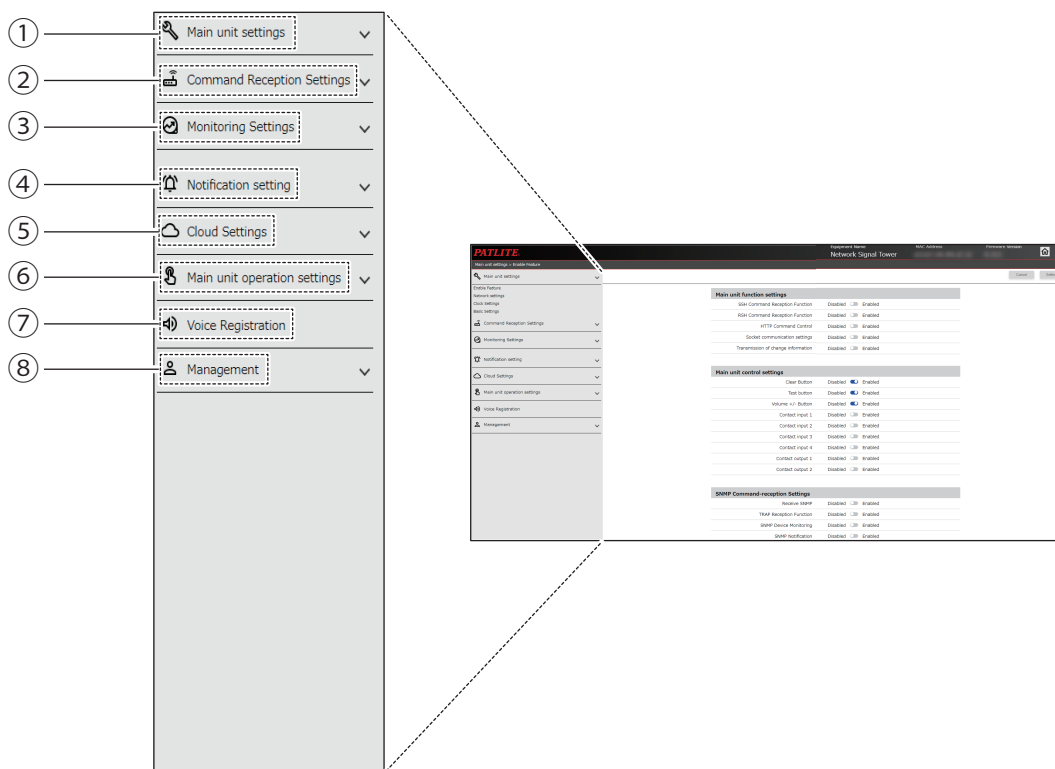

No.	Item	Description
①	Main unit settings	You can configure [Enable Feature], [Network settings], [Clock Settings], and [Basic Settings].
②	Command Reception Settings	You can configure [Socket communication settings], [RSH/SSH Command Reception Settings], and [SNMP Command-reception Settings].
③	Monitoring Settings	You can configure [Ping Monitoring Settings], [Individual setting], [Group Settings], and [TRAP Reception Settings], [Basic Settings], [Reception Settings], and [SNMP Device Monitoring Settings], [Basic Setup], [Match Detection Settings], [Change detection settings], and [Contact input setting], [Status Change Detection Settings], [Match Detection Settings], and [Mail detection setting], [Mail server settings], [Filter rule settings].
④	Notification settings	You can configure [SNMP Notification Settings], [Email Notification], and [HTTP Transmission Settings].
⑤	Cloud Settings	You can configure [Azure Connection Settings] and [AWS Connection Settings].
⑥	Main unit operation settings	You can configure [Clear Operation Settings], [Test Button Settings], [Contact output setting], and [Signal Tower Operation].
⑦	Voice Registration	You can configure [Voice Registraton] settings.
⑧	Management	You can run operations for [Initialization], [Restart], [Configuration], [Firmware Update], [Event Log], [User authentication settings], and [Security Settings].

## 9.1. Main Unit Settings

### 9.1.1. Function Activation

You can select to [Enabled] or [Disabled] product functions.

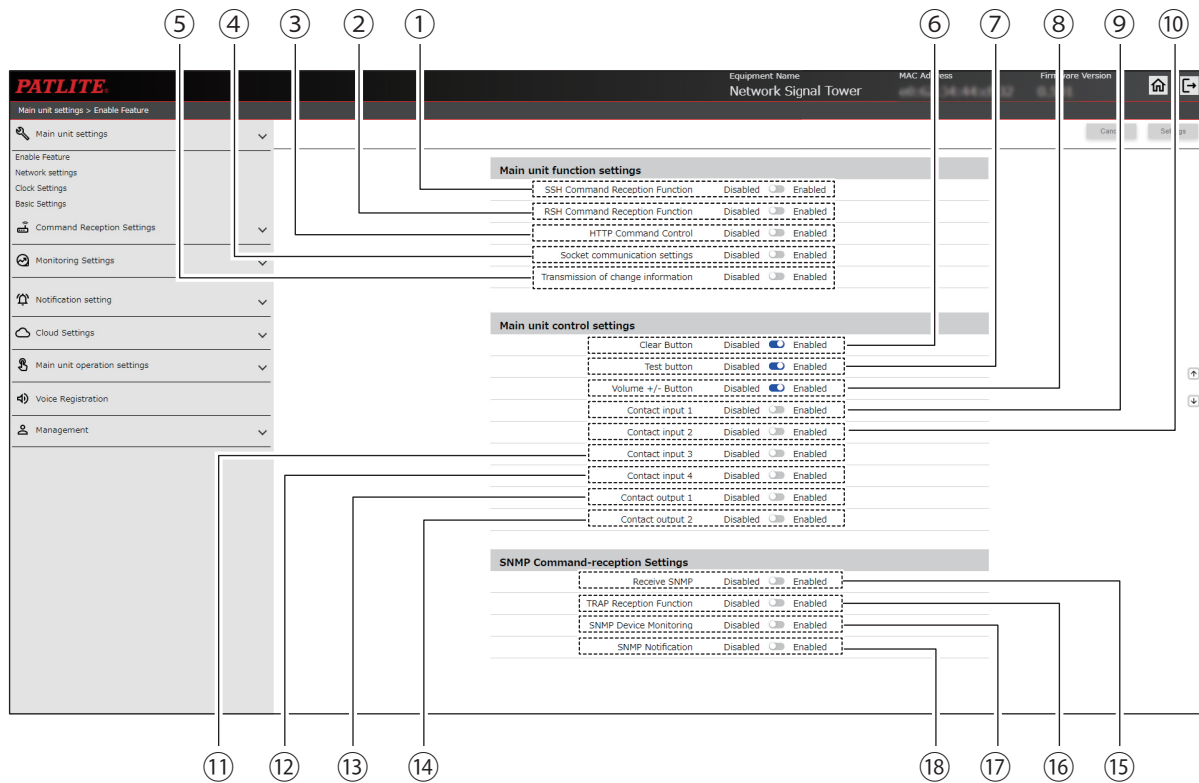

No.	Item	Default Value	Input Range	Description	Setting ( ● : Yes –: No)			
					NHB Series	NHV Series		
						(empty)	M Model	D Model
①	SSH Command Reception Function	Disabled	Enabled / Disabled	You can select to [Enabled] or [Disabled] the SSH Command Reception Function.	●	●	●	●
②	RSH Command Reception Function	Disabled	Enabled / Disabled	You can select to [Enabled] or [Disabled] the RSH Command Reception Function.	●	●	●	●
③	HTTP Command Control	Disabled	Enabled / Disabled	You can select to [Enabled] or [Disabled] the HTTP Command Control function.	●	●	●	●
④	Socket communication settings	Disabled	Enabled / Disabled	You can select to [Enabled] or [Disabled] the Socket Communication settings function.	●	●	●	●
⑤	Transmission of change information	Disabled	Enabled / Disabled	You can select to [Enabled] or [Disabled] the Transmission of change information function.	●	●	●	●
⑥	Clear Button	Enabled	Enabled / Disabled	You can select to [Enabled] or [Disabled] the Clear Button operation.	●	●	●	●
⑦	Test button	Enabled	Enabled / Disabled	You can select to [Enabled] or [Disabled] the Test Button operation.	●	●	●	●
⑧	Volume +/- Button	Enabled	Enabled / Disabled	You can select to [Enabled] or [Disabled] the Volume +/- Button.	●	●	●	●
⑨	Contact input 1	Disabled	Enabled / Disabled	You can select to [Enabled] or [Disabled] Contact input 1.	–	–	–	●

No.	Item	Default Value	Input Range	Description	Setting ( ● : Yes --: No)			
					NHB Series	NHV Series		
						(empty)	<input type="checkbox"/> Model	<input type="checkbox"/> Model
⑩	Contact input 2	Disabled	Enabled / Disabled	You can select to [Enabled] or [Disabled] Contact input 2.	--	--	--	●
⑪	Contact input 3	Disabled	Enabled / Disabled	You can select to [Enabled] or [Disabled] Contact input 3.	--	--	--	●
⑫	Contact input 4	Disabled	Enabled / Disabled	You can select to [Enabled] or [Disabled] Contact input 4.	--	--	--	●
⑬	Contact output 1	Disabled	Enabled / Disabled	You can select to [Enabled] or [Disabled] Contact output 1.	--	--	--	●
⑭	Contact output 2	Disabled	Enabled / Disabled	You can select to [Enabled] or [Disabled] Contact output 2.	--	--	--	●
⑮	Receive SNMP	Disabled	Enabled / Disabled	You can select to [Enabled] or [Disabled] the SNMP Command-reception Function.	●	●	●	●
⑯	TRAP Reception Function	Disabled	Enabled / Disabled	You can select to [Enabled] or [Disabled] the TRAP Reception Function.	●	●	●	●
⑰	SNMP Device Monitoring	Disabled	Enabled / Disabled	You can select to [Enabled] or [Disabled] the SNMP Device Monitoring Function.	●	●	●	●
⑱	SNMP Notification	Disabled	Enabled / Disabled	You can select to [Enabled] or [Disabled] the SNMP Notification Function.	●	●	●	●

### 9.1.2. Network Settings

You can change the network settings on this product.

**CAUTION**

- After changing network settings, click [Set] to apply the defined settings.
- Click [Set] to automatically restart the network.

Screen when [Manual Settings] is selected in ① and ⑥

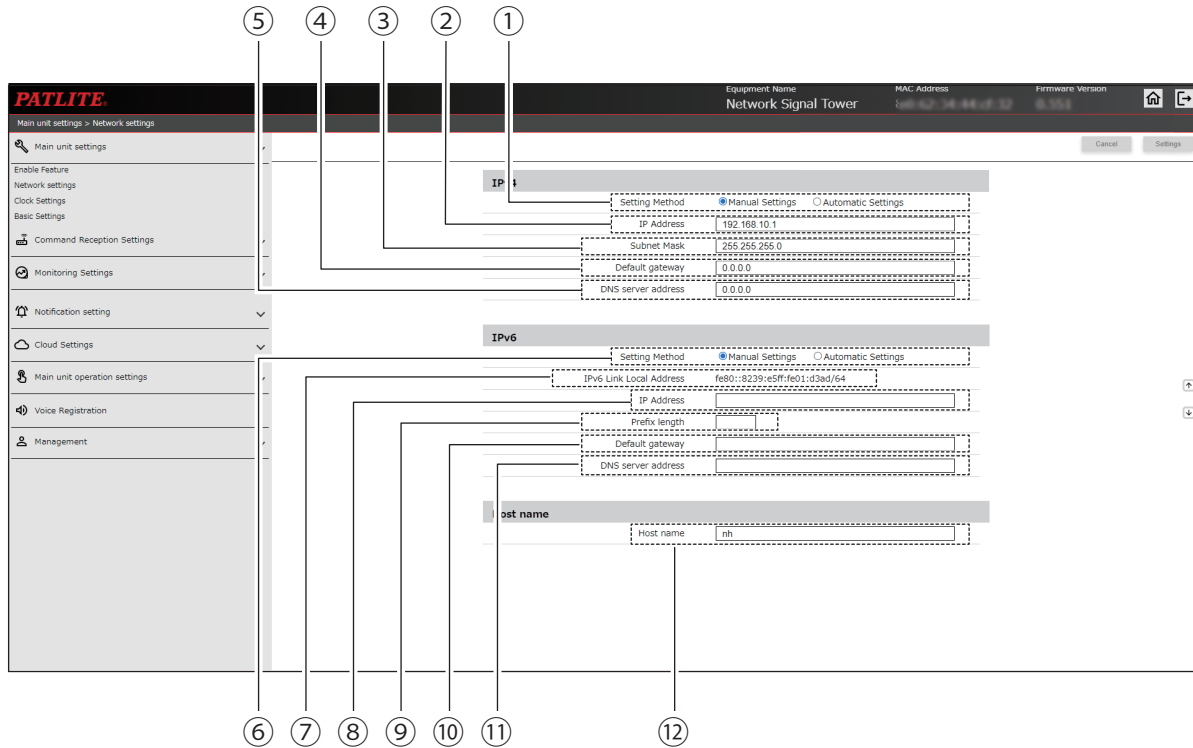

Screen when [Auto Settings] is selected in ① and ⑥

Refer to the above

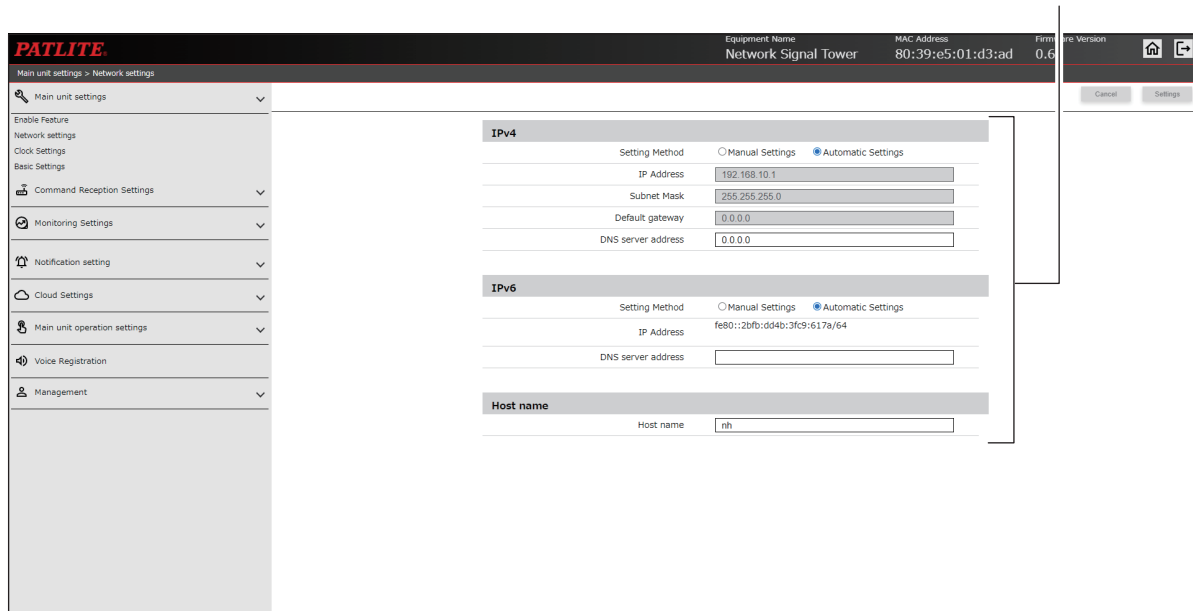

No.	Item	Default Value	Input Range	Description	Setting ( ● : Yes –: No)			
					NHB Series	NHV Series		
						(empty)	[M] Model	[D] Model
①	Setting Method	Manual Settings	Set up manually / Set up automatically	Select how to configure the IPv4 address for this product.	●	●	●	●
②	IP Address* <sup>1</sup>	192.168.10.1	IPv4 Address Format	Enter the IPv4 address of this product.	●	●	●	●
③	Subnet Mask* <sup>1</sup>	255.255.255.0		Enter the subnet mask of this product.	●	●	●	●
④	Default gateway* <sup>1</sup>	0.0.0.0		Enter the default gateway of this product.	●	●	●	●
⑤	DNS server address	0.0.0.0		Enter the DNS server address.	●	●	●	●
⑥	Setting Method	Manual Settings	Set up manually / Set up automatically	Select how to configure the IPv6 address for this product.	●	●	●	●
⑦	IPv6 Link Local Address* <sup>2</sup>	–	–	Displays the link local address of this product.	●	●	●	●
⑧	IP Address* <sup>3</sup>	(Blank)	IPv6 Address Format	Enter the IPv6 address of this product.	●	●	●	●
⑨	Prefix length* <sup>2</sup>	(Blank)	1 to 128	Enter the Prefix length of this product.	●	●	●	●
⑩	Default gateway* <sup>2</sup>	(Blank)	IPv6 Address Format	Enter the default gateway of this product.	●	●	●	●
⑪	DNS server address	(Blank)	IPv6 Address Format	Enter the DNS server address.	●	●	●	●
⑫	Host name	nh	63 single-byte alphanumeric characters	Enter the host name.	●	●	●	●

\*1 When [Automatic Settings] is selected, input is disabled.

\*2 When [Automatic Settings] is selected, setup items do not display.

\*3 When [Automatic Settings] is selected, up to three IPv6 addresses acquired by this product are displayed.



### 9.1.3. Clock Settings

Set the clock on this product. There are two ways to set the clock on the product.

For information, refer to "7.6. Setting Up the Clock" (👉 page 102)

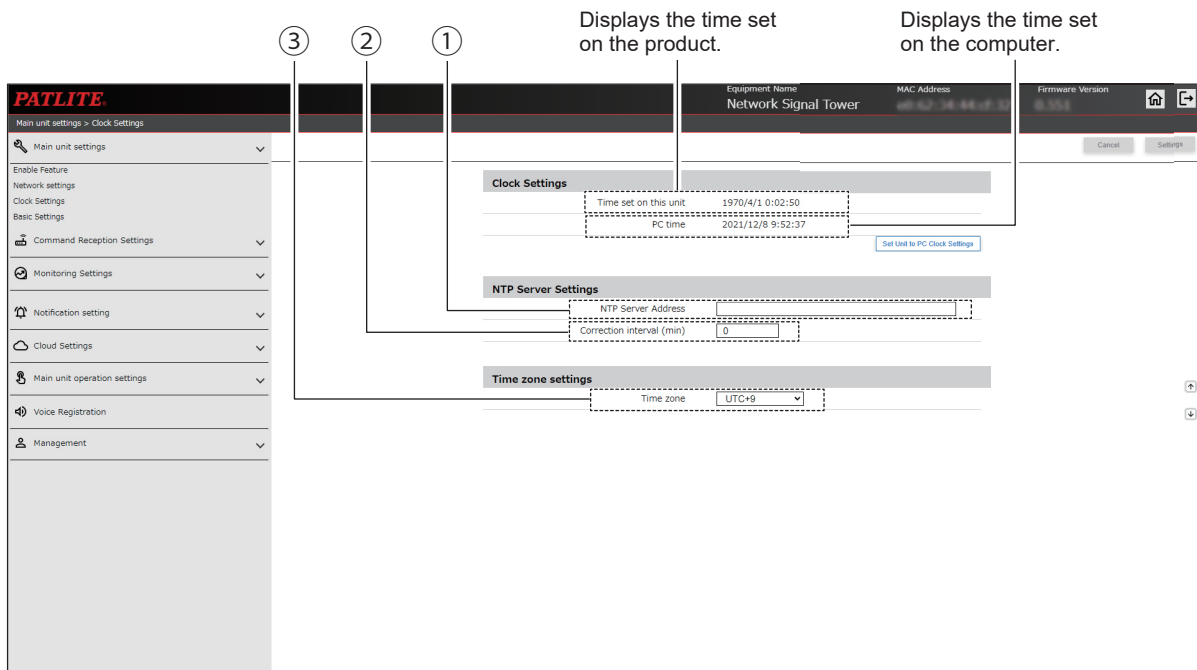

No.	Item	Default Value	Input Range	Description	Setting ( ● : Yes –: No)			
					NHB Series	NHV Series		
						(empty)	M Model	D Model
①	NTP Server Address	(Blank)	IP Address Format (v4/v6) or host name (63 characters)	Set the NTP Server address.*	●	●	●	●
②	Correction interval (min)	0	0 to 1440	Set the interval for NTP server communication.	●	●	●	●
③	Time zone	UTC+9	UTC-12 to +12	Set the Time zone.	●	●	●	●

\* When you do not use a NTP server, either leave the NTP Server address blank or set to "0.0.0.0".

### 9.1.4. Basic Settings

Set basic operations on this product.

NHV

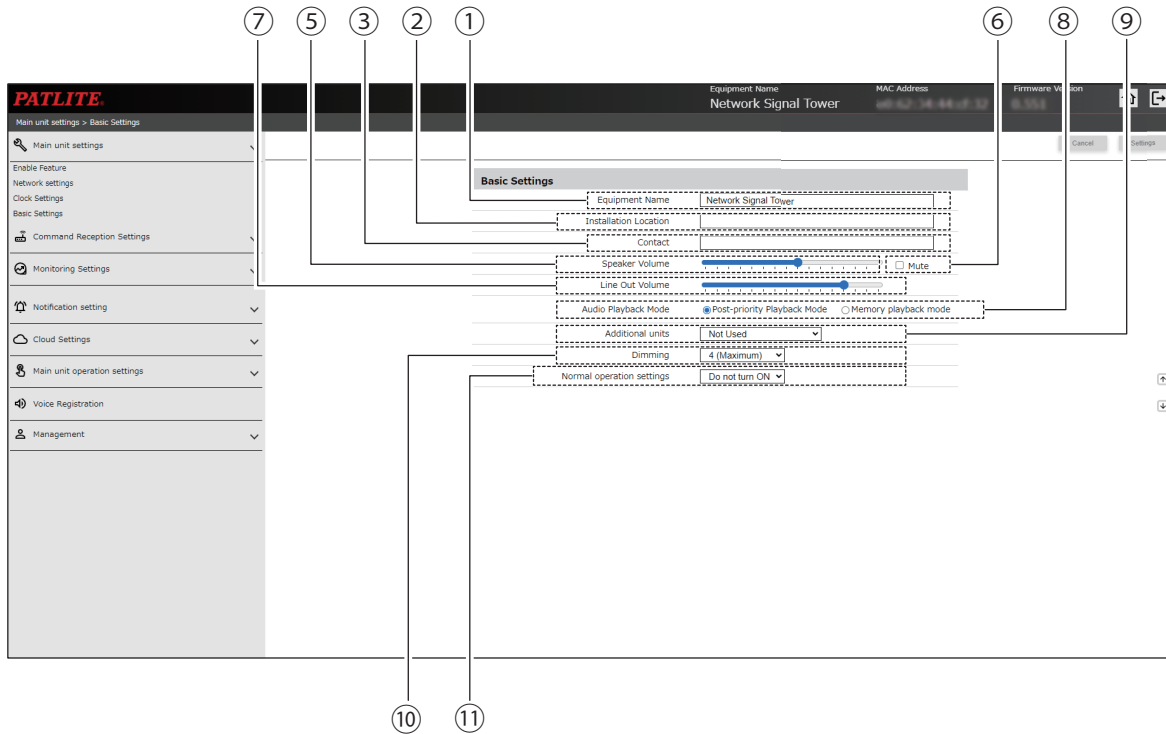

NHB

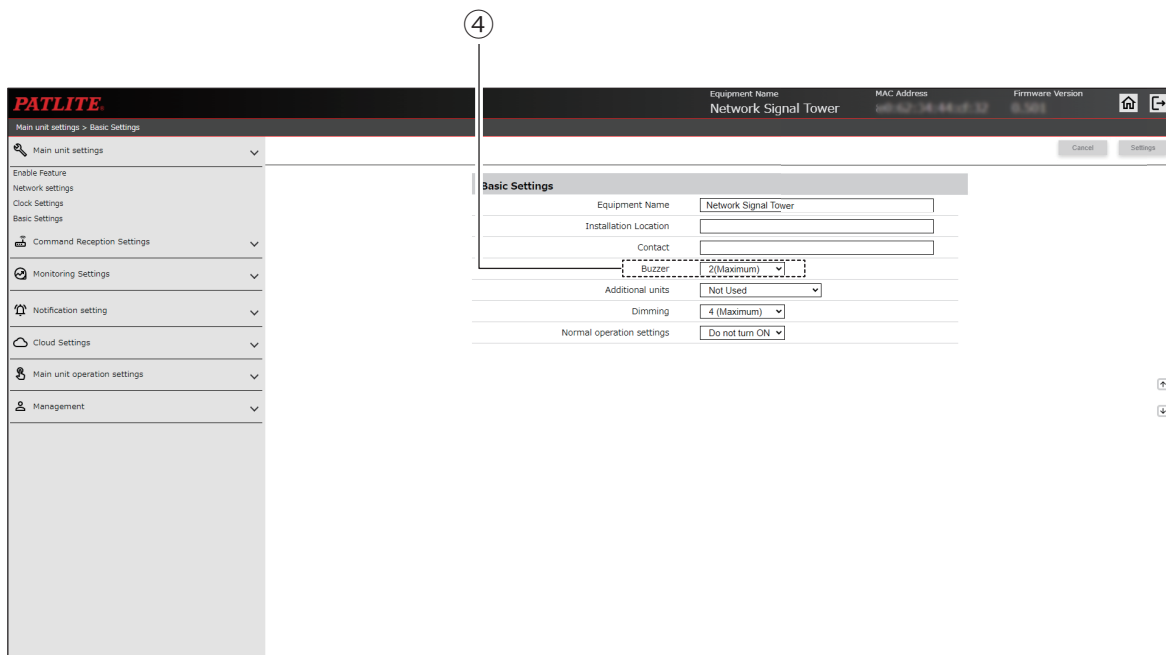

No.	Item	Default Value	Input Range	Description	Setting ( ● : Yes, –: No)			
					NHB Series	NHV Series		
						(empty)	[M] Model	[D] Model
①	Product Name	Network Signal Tower	31 single-byte or double-byte characters	Enter the product name for this product.	●	●	●	●
②	Installation Location	(Blank)	31 single-byte alphanumeric and underscore ( _ )	Enter the installation location of this product.	●	●	●	●
③	Contact	(Blank)	Email address format (maximum 63 characters)	Enter the contact information.	●	●	●	●
④	Buzzer	2 (Maximum)	2 / 1 / 0 (Maximum) (OFF)	Configure the buzzer volume on this product.	●	–	–	–
⑤	Speaker Volume	8	0 to 15	Configure the speaker volume on this product.	–	●	●	●
⑥	Mute*1	(Not selected)	–	Set whether to mute the volume on this product. Select the check box to erase sound on the product.	–	●	●	●
⑦	Line Out Volume	12	0 to 15	Configure the line out volume on this product.	–	●	●	●
⑧	Audio Playback Mode	Post-priority Playback Mode	Post-priority Playback Mode / Memory playback mode	Select either [Post-priority Playback Mode] or [Memory playback mode] for audio playback.	–	●	●	●
⑨	Additional units*2 *3	Not Used	Not Used/ WDT / Multi-color unit	Select the unit from [Not Used], [WDT], or [Multi-color unit].	●	●	●	●
⑩	Dimming	4 (maximum)	4 / 3 / 2 / 1 (maximum) (minimum)	Set the brightness of the Signal Tower when on or flashing.	●	●	●	●
⑪	Normal operation settings*4	Do not turn ON	Red / Amber / Green / Blue / White / Do not turn ON	Set the Signal Tower light during normal operation.	●	●	●	●

\*1 Mute is automatically disabled when the product is turned off or restarted.

\*2 [WDT] and [Multi-color unit] cannot be selected at the same time.

\*3 When [WDT] or [Multi-color unit] is selected, the dimmer is fixed at [Maximum].

\*4 If you execute the clear operation after setup is complete, the product starts up in the set normal operation.  
Colors other than the set Signal Tower color are turned off during normal operation.

## 9.2. Command Reception Settings

### 9.2.1. Socket Communication Settings

Set socket communication used by PNS and PHN Commands.

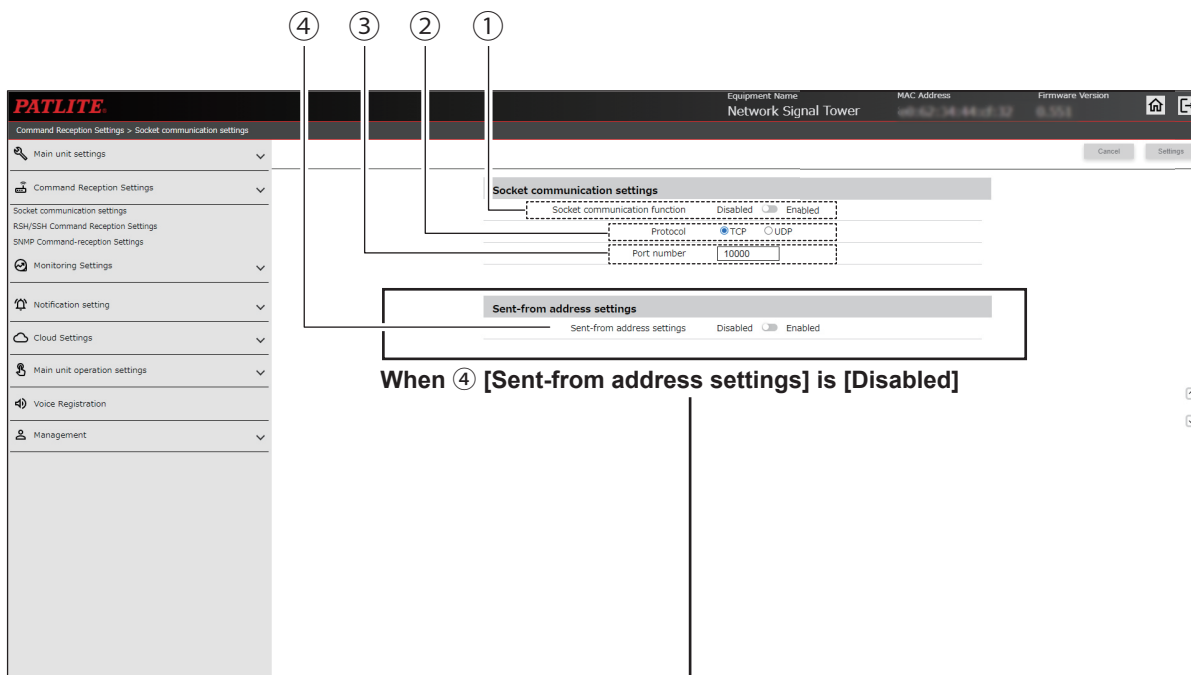

When ④ [Sent-from address settings] is [Disabled]

When ④ [Sent-from address settings] is [Enabled]

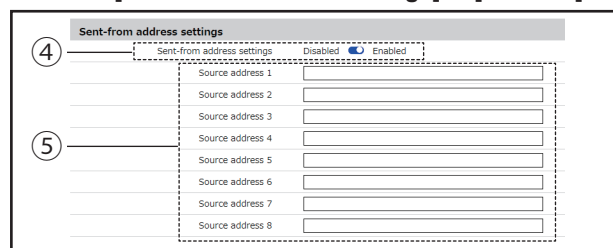

No.	Item	Default Value	Input Range	Description	Setting ( ● : Yes –: No)			
					NHB Series	NHV Series		
						(empty)	M Model	D Model
①	Socket communication function	Disabled	Enabled / Disabled	You can select to [Enabled] or [Disabled] the Socket Communication function.	●	●	●	●
②	Protocol	TCP	TCP / UDP	Select either [TCP] or [UDP].	●	●	●	●
③	Port number	10000	5000 to 65535	Enter the port number for receiving data.	●	●	●	●
④	Sent-from address settings	Disabled	Enabled / Disabled	You can choose whether or not to limit addresses that can transmit commands by selecting either [Enabled] or [Disabled].	●	●	●	●
⑤	Source address 1 to 8	(Blank)	IP Address Format (v4/v6)	Enter the IP addresses that are allowed to execute commands.	●	●	●	●

### 9.2.2. RSH/SSH Command Reception Settings

Define the settings for receiving RSH or SSH Commands.

Screen when [Disabled] is selected in ⑨, or screen when [Key Authentication] is selected in ⑰

The screenshot displays the 'RSH/SSH Command Reception Settings' page in the PATLITE web interface. The interface includes a sidebar menu on the left with categories like 'Main unit settings', 'Command Reception Settings', 'Socket communication settings', 'Monitoring Settings', 'Notification setting', 'Cloud Settings', 'Main unit operation settings', 'Voice Registration', and 'Management'. The main content area is divided into several sections:

- RSH/SSH Command Reception Settings:** Contains 'RSH Command Reception Function' (Disabled), 'SSH Command Reception Function' (Disabled), and 'Resume timer' (Common).
- Command Reception Notification Method:** Includes 'Send email' (Disabled), 'Subject' (1), 'Body text' (1), and 'Mail destination setting' (1-4).
- RSH Command Reception Settings:** Includes 'Sent-from address settings' (Disabled) and 'Common Login Name'.
- SSH Command Reception Settings:** Includes 'Port number' (22), 'Authentication method' (Password Authentication, Key Authentication), and a list of 16 entries (1-16) for source IP addresses and login names. Each entry has a 'Public Key' field with 'Not registered' and 'Select a file' options.

Numbered callouts (1-17) are placed throughout the interface to highlight specific elements:

- ①-⑤: Point to the top navigation bar and sidebar menu.
- ⑥-⑧: Point to the 'RSH/SSH Command Reception Settings' section.
- ⑨: Points to the 'Send email' option.
- ⑩-⑫: Point to the 'Mail destination setting' options.
- ⑬: Points to the 'Authentication method' dropdown.
- ⑭-⑮: Point to the 'Source IP address' and 'Login name' fields in the first entry.
- ⑯-⑰: Point to the 'Public Key' field and 'Key Authentication' option.

Screen when [Enabled] is selected in ⑨, or screen when [Password Authentication] is selected in ⑰

The screenshot displays the 'RSH/SSH Command Reception Settings' page. The left sidebar contains navigation items: Main unit settings, Command Reception Settings, Socket Communication settings, RSH/SSH Command Reception Settings, SNMP Command-reception Settings, Monitoring Settings, Notification setting, Cloud Settings, Main unit operation settings, Voice Registration, and Management. The top header shows 'Equipment Name: Network Signal Tower' and 'Firmware Version'. The main content area is divided into several sections:

- RSH/SSH Command Reception Settings:** Includes 'RSH Command Reception Function' (Disabled/Enabled), 'SSH Command Reception Function' (Disabled/Enabled), and 'Restore timer' (Common/Individual).
- Command Reception Notification Method:** Includes 'Send email' (Disabled/Enabled) and 'Mail destination setting' (1-8: Not registered).
- RSH Command Reception Settings:** Includes 'Sent-from address settings' (Disabled/Enabled) and a table for 16 entries with 'Source IP address' and 'Login name' fields.
- SSH Command Reception Settings:** Includes 'Port number' (22), 'Authentication method' (Password Authentication/Key Authentication), and a table for 11 entries with 'Source IP address', 'Login name', and 'Password' fields.

Callouts 1-17 indicate the following elements:

- ①: RSH Command Reception Function
- ②: SSH Command Reception Function
- ③: Restore timer
- ④: Send email
- ⑤: Mail destination setting
- ⑥: RSH Command Reception Settings header
- ⑦: SSH Command Reception Settings header
- ⑧: Mail destination setting
- ⑨: Send email
- ⑩: RSH Command Reception Settings table
- ⑪: Login name field in RSH table
- ⑫: Port number
- ⑬: Authentication method
- ⑭: Source IP address field in SSH table
- ⑮: Password field in SSH table
- ⑯: Password Authentication radio button
- ⑰: Key Authentication radio button

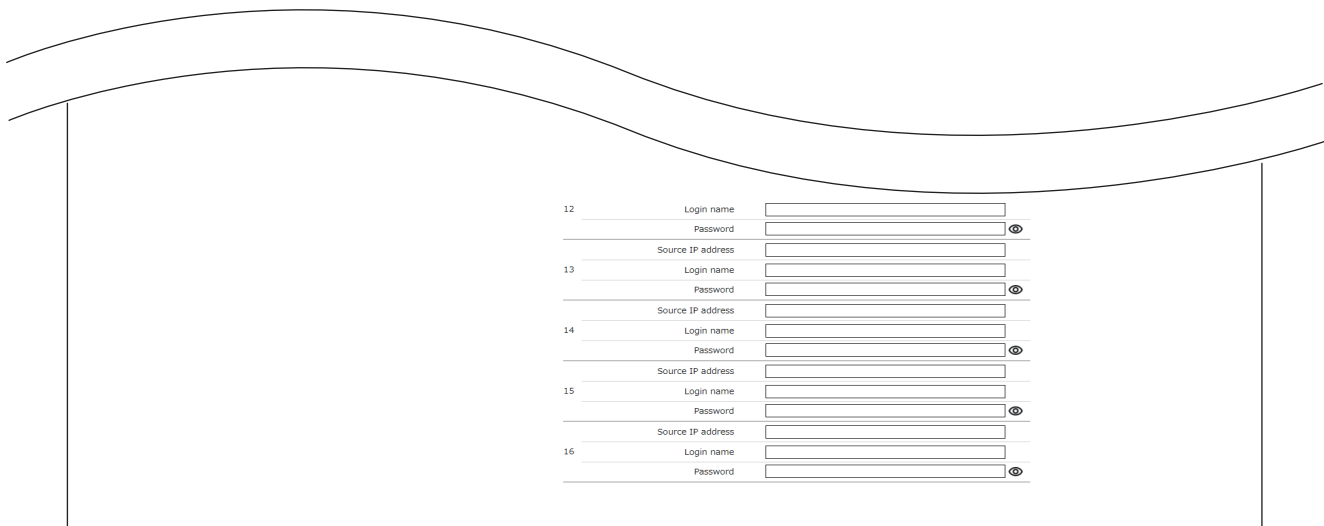

No.	Item	Default Value	Input Range	Description	Setting ( ● : Yes –: No)			
					NHB Series	NHV Series		
						(empty)	<input type="checkbox"/> Model	<input type="checkbox"/> Model
①	RSH Command Reception Function	Disabled	Enabled / Disabled	You can select to [Enabled] or [Disabled] the RSH Command Reception function.	●	●	●	●
②	SSH Command Reception Function	Disabled	Enabled / Disabled	You can select to [Enabled] or [Disabled] the SSH Command Reception function.	●	●	●	●
③	Restore timer	Common	Common / Individual	Set [Common] or [Individual] for the timer function so you can set the operating time of each color and buzzer of the Signal Tower.	●	●	●	●
④	Send email	Disabled	Enabled / Disabled	For when a command is received, set [Enabled] or [Disabled] for Send email.	●	●	●	●
⑤	Subject	1	1 to 17	Select the subject of the email to send.	●	●	●	●
⑥	Body text	1	1 to 17	Select the body text of the email to be sent.	●	●	●	●
⑦	Mail destination setting	(Not selected)	–	Select the email recipient.	●	●	●	●
⑧	SNMP Notification	Disabled	Enabled / Disabled	Set to [Enabled] or [Disabled] SNMP Notification.	●	●	●	●
⑨	Sent-from address settings	Disabled	Enabled / Disabled	You can choose whether or not to limit addresses that can transmit RSH Commands by selecting either [Enabled] or [Disabled].	●	●	●	●
⑩	Source IP address	(Blank)	IP Address Format (v4/v6)	Enter the IP addresses that are allowed to execute RSH Commands.	●	●	●	●

No.	Item	Default Value	Input Range	Description	Setting ( ● : Yes –: No)			
					NHB Series	NHV Series		
						(empty)	<input type="checkbox"/> Model	<input type="checkbox"/> Model
⑪	Login name	(Blank)	16 single-byte alphanumeric characters, period ( . ), and hyphen ( - )	Enter the login names that are allowed to execute RSH Commands.	●	●	●	●
⑫	Common Login Name	(Blank)	16 alphanumeric or symbol characters	Enter the login name for when the RSH Command's [Sent-from address settings] is [Disabled].	●	●	●	●
⑬	Port number	22	1 to 65535	Set the port for receiving SSH Commands.	●	●	●	●
⑭	Source IP address	(Blank)	IP Address Format (v4/v6)	Enter the IP addresses that are allowed to execute SSH Commands.	●	●	●	●
⑮	Login name	(Blank)	16 single-byte alphanumeric characters, period ( . ), and hyphen ( - )	Enter the login names that are allowed to execute SSH Commands.	●	●	●	●
⑯	Password	(Blank)	32 alphanumeric or symbol characters	Enter the password for Password Authentication.	●	●	●	●
⑰	Authentication method	Key Authentication	Password Authentication / Key Authentication	For the [Authentication method], select either [Password Authentication] or [Key Authentication].	●	●	●	●



### 9.2.3. SNMP Command Reception Settings

Set the [Community Name], [Security Level], [Authentication method], and so on, used with SNMP to reference and set each these items for this product.

When [Version selection] is set to [v1/v2c] in ②

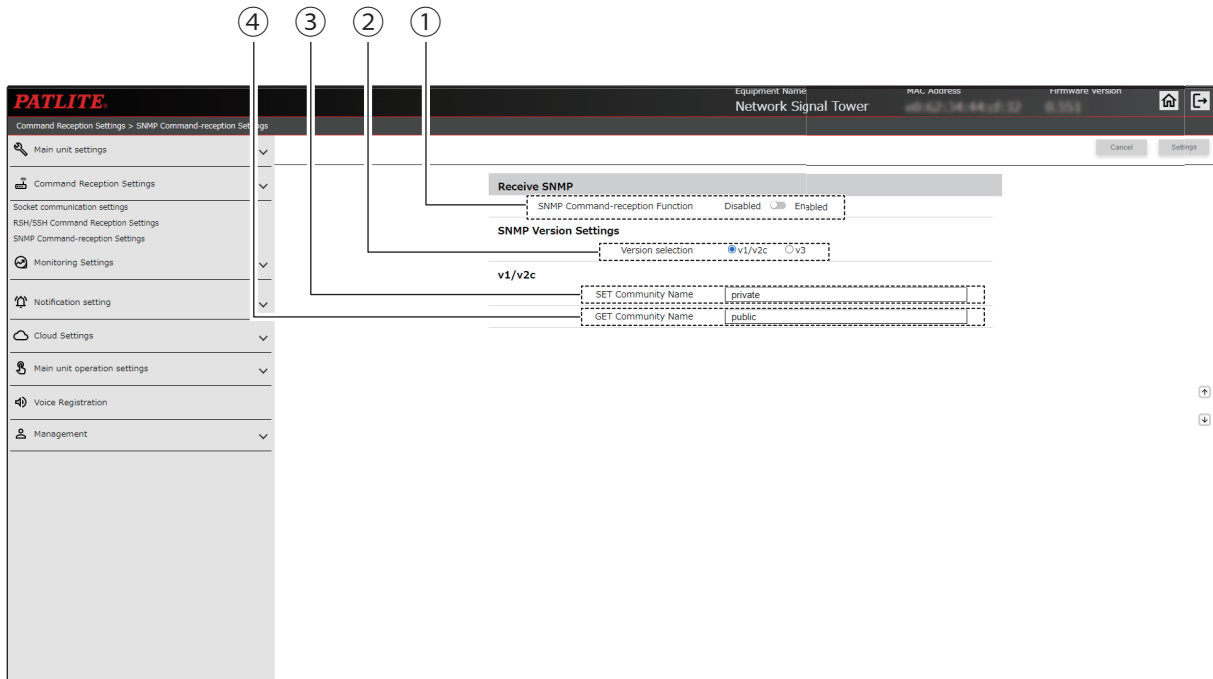

When [Version selection] is set to [v3] in ②

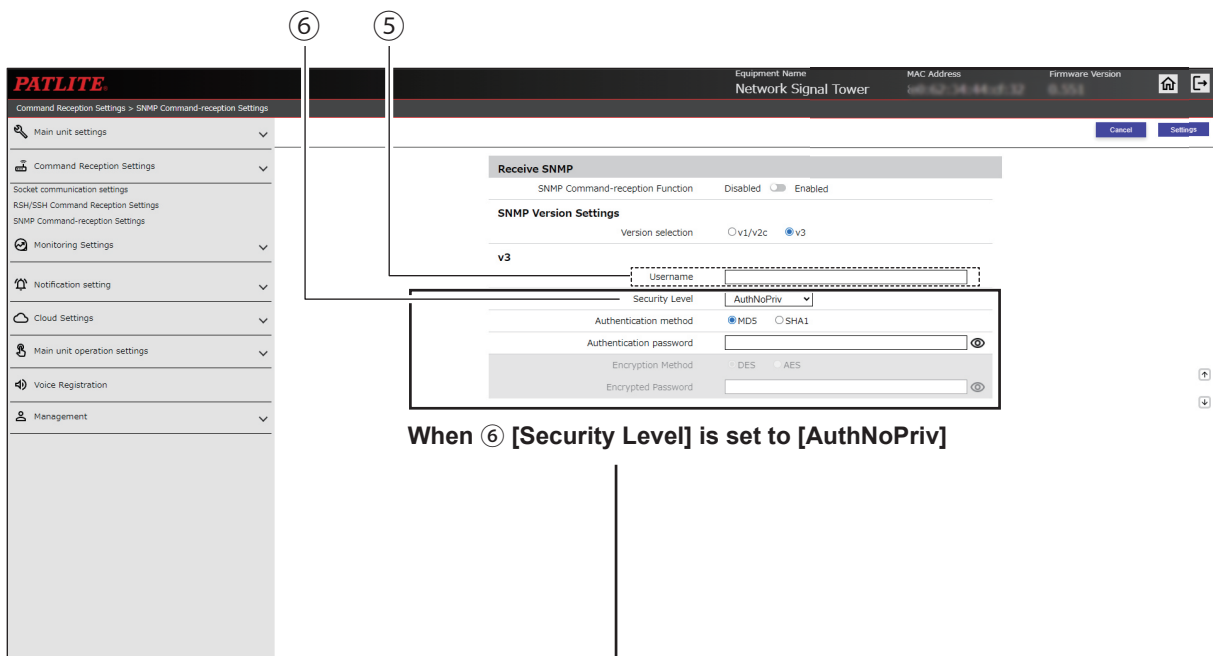

When ⑥ [Security Level] is set to [AuthNoPriv]

When ⑥ [Security Level] is set to [AuthPriv]

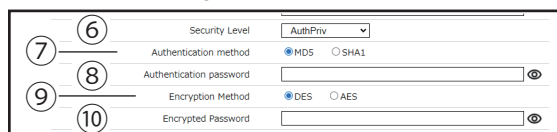

When ⑥ [Security Level] is set to [noAuthNoPriv]

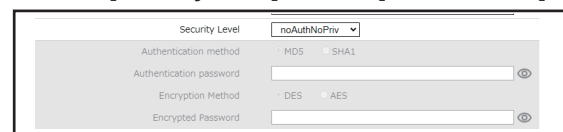

No.	Item	Default Value	Input Range	Description	Setting ( ● : Yes –: No)			
					NHB Series	NHV Series		
						(empty)	M Model	D Model
①	SNMP Command-reception Function	Disabled	Enabled / Disabled	You can select to [Enabled] or [Disabled] the SNMP Command-reception Function.	●	●	●	●
②	Version selection	v1/v2c	v1/v2c / v3	Select the SNMP version to use for Receive SNMP.	●	●	●	●
③	SET Community Name* <sup>1</sup>	private	32 single-byte alphanumeric characters and underscore ( _ )	Enter the name for reading and writing settings with SNMP v1/v2c.	●	●	●	●
④	GET Community Name* <sup>1</sup>	public	32 single-byte alphanumeric characters and underscore ( _ )	Enter the name for reading settings with SNMP v1/v2c.	●	●	●	●
⑤	Username* <sup>2</sup>	(Blank)	32 single-byte alphanumeric characters	Set the user name used for authentication in SNMP v3.	●	●	●	●
⑥	Security Level* <sup>2</sup>	AuthPriv	noAuthNoPriv / AuthNoPriv / AuthPriv	Select the security level for authentication in SNMP v3.	●	●	●	●
⑦	Authentication method* <sup>2</sup> * <sup>3</sup>	MD5	MD5 / SHA1	Select the Authentication method for authentication in SNMP v3.	●	●	●	●
⑧	Authentication password* <sup>2</sup> * <sup>3</sup>	(Blank)	8 to 64 single-byte alphanumeric characters	Register the Authentication password.	●	●	●	●
⑨	Encryption Method* <sup>2</sup> * <sup>4</sup>	DES	DES / AES	Select the Encryption Method for authentication in SNMP v3.	●	●	●	●
⑩	Encryption Password* <sup>2</sup> * <sup>4</sup>	(Blank)	8 to 64 single-byte alphanumeric characters	Register the Encrypted Password.	●	●	●	●

\*1 Displays when [v1/v2c] is selected for [Version selection].

\*2 Displays when [v3] is selected for [Version selection].

\*3 If you select [noAuthNoPriv] for the [Security Level], you cannot configure this setup item.

\*4 If you select [noAuthNoPriv] or [AuthNoPriv] for the [Security Level], you cannot configure this setup item.

## 9.3. Monitor Settings

### 9.3.1. Ping Monitoring Settings

#### 9.3.1.1. Individual Settings

- Set up ping monitoring.
- When the monitoring result is identified as an error, the operation for when there is a monitoring error is performed. After a monitoring error occurs, if there is a response to the ping request, it is determined to have recovered from the error state and the operation for when there is a recovery is performed.

NHB

In [Additional units], [Multi-color unit] is specified

No.	Item	Default Value	Input Range	Description	Setting ( ● : Yes –: No)			
					NHB Series	NHV Series		
						(empty)	M Model	D Model
①	Setting Number	1	1 to 24	Select the setting number for Ping Monitoring Settings.	●	●	●	●
②	Monitored Address	(Blank)	IP Address Format (v4/v6) or host name (63 characters)	Enter the address to monitor.	●	●	●	●
③	Unit name	(Blank)	32 single-byte or double-byte characters	Enter the name of equipment to monitor.	●	●	●	●
④	Monitoring Group Setting*1	-	-	Displays the monitoring group in which the monitored equipment is set.	●	●	●	●
⑤	Number of transmissions (0-30)	0	0 to 30	Select the number of transmissions until an error is detected.	●	●	●	●
⑥	PING Monitoring Cycle (1-600) sec.	60	1 to 600	Select the frequency of ping transmissions.	●	●	●	●
⑦	Number of transmissions (1-3)	1	1 to 3	Select the number of ping to send at a time.	●	●	●	●
⑧	Red, Amber, Green, Blue, White	No change	Continuous ON / Flashing pattern 1 / Flashing pattern 2 / Flashing pattern 3 / Flashing pattern 4 / OFF / No change	Select each color of the Signal Tower.	●	●	●	●
⑨	Color	No change	Red / Amber / Green / Blue / White / Purple / Light blue / No change	Specify the color of the Multi-color unit.	●	●	●	●
⑩	Pattern	No change	Continuous ON / Flashing pattern 1 / Flashing pattern 2 / Flashing pattern 3 / Flashing pattern 4 / OFF / No change	Specify the lighting pattern of the Multi-color unit.	●	●	●	●
⑪	Buzzer	No change	Stop / Buzzer pattern 1 / Buzzer pattern 2 / Buzzer pattern 3 / Buzzer pattern 4 / Buzzer pattern 5 / No change	Select the buzzer sound pattern.	●	–	–	–
⑫	Audio	No change	Stop / One-shot playback/ Repeat playback / No change	Select the audio playback pattern.	–	●	●	●
⑬	Audio (when [Repeat playback] is selected)	0	0 to 255	Set the number of times to repeat. In addition to normal audio playback, the audio is repeated the specified number of times. If the number of times to repeat is set to 255, playback is endless.	–	●	●	●
⑭	Audio Channel*2	Not selected	Not selected / 1 to 71	Select a registered channel.	–	●	●	●
⑮	Send email	Disabled	Enabled / Disabled	Set to [Enabled] or [Disabled] Send email.	●	●	●	●

No.	Item	Default Value	Input Range	Description	Setting ( ● : Yes –: No)			
					NHB Series	NHV Series		
						(empty)	M Model	D Model
⑰	Subject	1	1 to 17	Select a subject for the email.	●	●	●	●
⑰	Body text	1	1 to 17	Select the body text of the email.	●	●	●	●
⑱	Mail destination setting	(Not selected)	–	Select the email recipient.	●	●	●	●
⑲	SNMP Notification	Disabled	Enabled / Disabled	Set to [Enabled] or [Disabled] SNMP Notification.	●	●	●	●
⑳	Send HTTP Command	Disabled	Enabled / Disabled	Set to [Enabled] or [Disabled] Send HTTP Command.	●	●	●	●
㉑	HTTP Command Sending Settings	(Not selected)	–	Select the recipient of the HTTP Command.	●	●	●	●
㉒	Send MQTT	Disabled	Enabled / Disabled	Set to [Enabled] or [Disabled] Send MQTT.	●	●	●	●
㉓	Contact output 1*3	No change	ON / OFF / No change	Specify operation of contact output 1.	–	–	–	●
㉔	Contact output 2	No change	ON / OFF / No change	Specify operation of contact output 2.	–	–	–	●

\*1 Set up monitoring group settings in [Ping Monitoring Settings] - [Group Settings].

\*2 For the audio channel, you can select the following channels.

- In the [Voice Registration] screen, channel with registered audio
- Preset channel

\*3 When [Busy output] is specified in [Function] in [Contact output setting], this function is not operated.

### 9.3.1.2. Group Settings

#### NHB

#### In [Additional units], [Multi-color unit] is specified

No.	Item	Default Value	Input Range	Description	Setting ( ● : Yes – : No)			
					NHB Series	NHV Series		
						(empty)	<input type="checkbox"/> Model	<input type="checkbox"/> Model
①	Group	A	A / B / C	Select the group for the Ping Monitoring Settings.	●	●	●	●
②	Monitored Equipment	(Not selected)	–	Select the equipment to specify for the group.	●	●	●	●
③	Red, Amber, Green, Blue, White	No change	Continuous ON / Flashing pattern 1 / Flashing pattern 2 / Flashing pattern 3 / Flashing pattern 4 / OFF / No change	Select each color of the Signal Tower.	●	●	●	●
④	Color	No change	Red / Amber / Green/ Blue / White/ Purple / Light blue / No change	Specify the color of the Multi-color unit.	●	●	●	●
⑤	Pattern	No change	Continuous ON / Flashing pattern 1 / Flashing pattern 2 / Flashing pattern 3 / Flashing pattern 4 / OFF / No change	Specify the lighting pattern of the Multi-color unit.	●	●	●	●
⑥	Buzzer	No change	Stop / Buzzer pattern 1 / Buzzer pattern 2 / Buzzer pattern 3 / Buzzer pattern 4 / Buzzer pattern 5 / No change	Select the buzzer sound pattern.	●	–	–	–
⑦	Audio	No change	Stop / One-shot playback / Repeat playback / No Change	Select the audio playback pattern.	–	●	●	●
⑧	Audio (when [Repeat playback] is selected)	0	0 to 255	Set the number of times to repeat. In addition to normal audio playback, the audio is repeated the specified number of times. If the number of times to repeat is set to 255, playback is endless.	–	●	●	●
⑨	Audio Channel*1	Not selected	Not selected / 1 to 71	Select a registered channel.	–	●	●	●
⑩	Send email	Disabled	Enabled / Disabled	Set to [Enabled] or [Disabled] Send email.	●	●	●	●
⑪	Subject	1	1 to 17	Select a subject for the email.	●	●	●	●
⑫	Body text	1	1 to 17	Select the body text of the email.	●	●	●	●
⑬	Mail destination setting	(Not selected)	–	Select the email recipient.	●	●	●	●
⑭	SNMP Notification	Disabled	Enabled / Disabled	Set to [Enabled] or [Disabled] SNMP Notification.	●	●	●	●
⑮	Send HTTP Command	Disabled	Enabled / Disabled	Set to [Enabled] or [Disabled] Send HTTP Command.	●	●	●	●

No.	Item	Default Value	Input Range	Description	Setting ( ● : Yes – : No)			
					NHB Series	NHV Series		
						(empty)	[M] Model	[D] Model
⑩⑥	HTTP Command Sending Settings	(Not selected)	–	Select the recipient of the HTTP Command.	●	●	●	●
⑩⑦	Send MQTT	Disabled	Enabled / Disabled	Set to [Enabled] or [Disabled] Send MQTT.	●	●	●	●
⑩⑧	Contact output 1*2	No change	OFF / ON / No change	Specify operation of contact output 1.	–	–	–	●
⑩⑨	Contact output 2	No change	OFF / ON / No change	Specify operation of contact output 2.	–	–	–	●

\*1 For the audio channel, you can select the following channels.

- In the [Voice Registration] screen, channel with registered audio
- Preset channel

\*2 When [Busy output] is specified in [Function] in [Contact output setting], this function is not operated.



### 9.3.2. TRAP Reception Settings

#### 9.3.2.1. Basic Settings

You can set which TRAP are allowed to be received.

When [Version selection] is set to [v1/v2c]

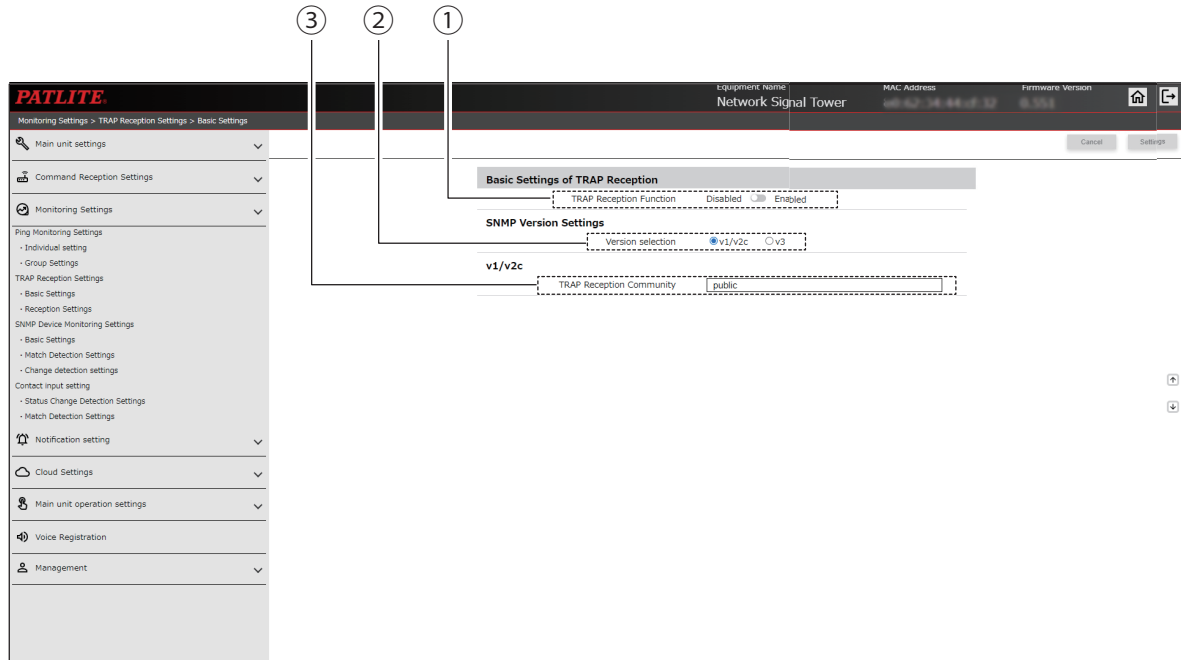

When [Version selection] is set to [v3]

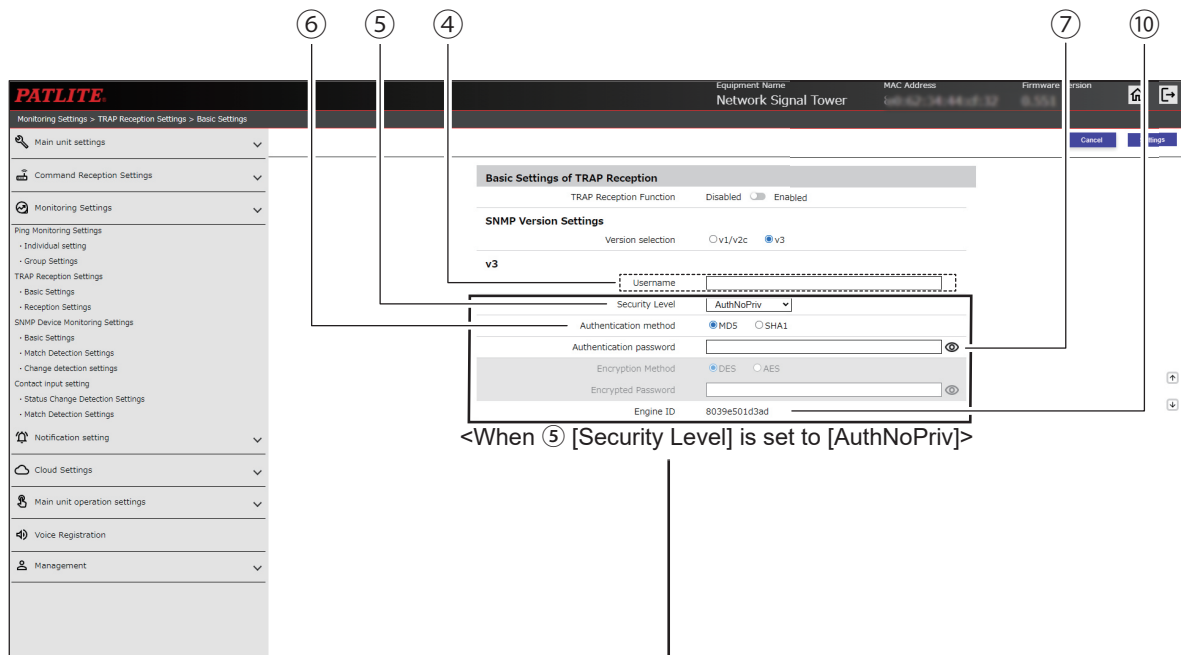

<When ⑤ [Security Level] is set to [AuthNoPriv]>

When ⑤ [Security Level] is set to [AuthPriv]

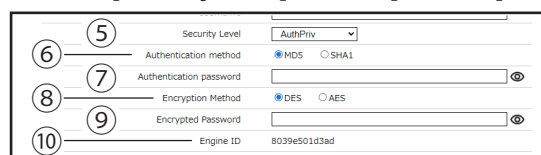

When ⑤ [Security Level] is set to [noAuthNoPriv]

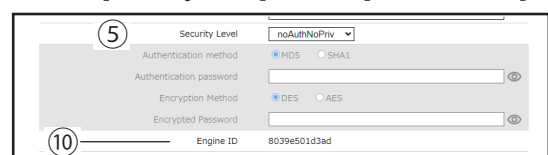

No.	Item	Default Value	Input Range	Description	Setting ( ● : Yes – : No)			
					NHB Series	NHV Series		
						(empty)	[M] Model	[D] Model
①	TRAP Reception Function	Disabled	Enabled / Disabled	You can select to [Enabled] or [Disabled] the TRAP Reception Function.	●	●	●	●
②	Version selection	v1/v2c	v1/v2c / v3	Select the SNMP version to use for receiving TRAP.	●	●	●	●
③	TRAP Reception Community* <sup>1</sup>	public	32 single-byte alphanumeric characters and underscore ( _ )	Enter the name for receiving settings with SNMP v1/v2c.	●	●	●	●
④	Username* <sup>2</sup>	(Blank)	32 single-byte alphanumeric characters	Set the user name used for authentication in SNMP v3.	●	●	●	●
⑤	Security Level* <sup>2</sup>	AuthPriv	noAuthNoPriv / AuthNoPriv / AuthPriv	Select the security level for authentication in SNMP v3.	●	●	●	●
⑥	Authentication method* <sup>2</sup> * <sup>3</sup>	MD5	MD5 / SHA1	Select the Authentication method for authentication in SNMP v3.	●	●	●	●
⑦	Authentication password* <sup>2</sup> * <sup>3</sup>	(Blank)	8 to 64 single-byte alphanumeric characters	Register the authentication password.	●	●	●	●
⑧	Encryption Method* <sup>2</sup> * <sup>4</sup>	DES	DES / AES	Select the Encryption Method for authentication in SNMP v3.	●	●	●	●
⑨	Encryption Password* <sup>2</sup> * <sup>4</sup>	(Blank)	8 to 64 single-byte alphanumeric characters	Register the Encrypted Password.	●	●	●	●
⑩	Engine ID* <sup>2</sup>	–	–	Displays this product's engine ID.	●	●	●	●

\*1 Displays when [v1/v2c] is selected for [Version selection].

\*2 Displays when [v3] is selected for the [Version selection].

\*3 If you select [noAuthNoPriv] for the [Security Level], you cannot configure this setup item.

\*4 If you select [noAuthNoPriv] or [AuthNoPriv] for the [Security Level], you cannot configure this setup item.

### 9.3.2.2. Receive Settings

You can set which TRAP are allowed to be received, and the operation to run after receiving TRAP.

The screenshot displays the 'TRAP Reception Settings' page in the PATLITE web interface. The left sidebar contains navigation menus for 'Main unit settings', 'Command Reception Settings', 'Monitoring Settings', 'Ping Monitoring Settings', 'TRAP Reception Settings', 'SNMP Device Monitoring Settings', 'Contact input setting', 'Notification setting', 'Cloud Settings', 'Main unit operation settings', 'Voice Registration', and 'Management'. The main content area is titled 'TRAP Reception Settings' and includes sections for 'TRAP Reception Group Settings1' (with sub-sections 1-1 to 1-4) and 'Group1 - TRAP Reception Operation Settings'. The operation settings section includes options for color (Red, Amber, Green, Blue, White), audio (Audio Channel, Send email), mail destination setting, SNMP Notification, HTTP Command Sending Settings, and contact outputs (Contact output 1, Contact output 2). Numbered callouts (1-23) identify specific fields and sections across the interface.

#### NHB

This screenshot shows the 'Monitored Equipment - Operation Settings when an Error Occurs' for NHB. The settings include:
 

- Color: Red, Amber, Green, Blue, White (all set to 'No change')
- Buzzer: No change
- Send email: Disabled
- Subject: 1, Body text: 1
- Mail destination setting: 1: Not registered, 2: Not registered, 3: Not registered, 4: Not registered, 5: Not registered, 6: Not registered, 7: Not registered, 8: Not registered
- SNMP Notification: Disabled
- Send HTTP Command: Disabled

 Callout 11 points to the 'Buzzer' setting.

#### In [Additional units], [Multi-color unit] is specified

This screenshot shows the 'Monitored Equipment - Operation Settings when an Error Occurs' for multi-color units. The settings include:
 

- Color: [Multi-color unit specified]
- Pattern: [Multi-color unit specified]
- Audio: No change
- Audio Channel: Not selected
- Send email: Enabled
- Subject: 1, Body text: 1
- Mail destination setting: 1: Not registered, 2: Not registered, 3: Not registered, 4: Not registered, 5: Not registered, 6: Not registered, 7: Not registered, 8: Not registered
- SNMP Notification: Enabled
- Send HTTP Command: Enabled

 Callouts 9 and 10 point to the 'Color' and 'Pattern' settings respectively.

No.	Item	Default Value	Input Range	Description	Setting ( ● : Yes – : No)			
					NHB Series	NHV Series		
						(empty)	M Model	D Model
①	Group Settings	1	1 to 16	Select the group number from 1 to 16.	●	●	●	●
②	Group Name	(Blank)	32 single-byte or double-byte characters	Enter the name of the group.	●	●	●	●
③	SNMP Notification Source Address	(Blank)	IP Address Format (v4/v6)	Enter the SNMP Notification Source Address from which to receive.	●	●	●	●
④	TRAP Number	(Blank)	OID format	Enter the TRAP OID to receive.	●	●	●	●
⑤	OID	(Blank)	OID format	Enter the variable-bindings OID to receive.	●	●	●	●
⑥	Series	Integer	Integer / OCTET STRING (String)/ OCTET STRING (Binary)	For the variable-bindings OID to receive, select the type from [integer], [OCTET STRING (String)], or [OCTET STRING (Binary)].	●	●	●	●
⑦	Value	(Blank)	0 to 2147483647 / 63 single-byte characters / 16 bytes (including comma as 1Byte)	Enter the value of variable-bindings to receive.	●	●	●	●
⑧	Red, Amber, Green, Blue, White	No change	Continuous ON / Flashing pattern 1 / Flashing pattern 2 / Flashing pattern 3 / Flashing pattern 4 / OFF / No change	Select each color of the Signal Tower.	●	●	●	●
⑨	Color	No change	Red / Amber / Green / Blue / White / Purple / Light blue / No change	Specify the color of the Multi-color unit.	●	●	●	●
⑩	Pattern	No change	Continuous ON / Flashing pattern 1 / Flashing pattern 2 / Flashing pattern 3 / Flashing pattern 4 / OFF / No change	Specify the lighting pattern of the Multi-color unit.	●	●	●	●
⑪	Buzzer	No change	Stop / Buzzer pattern 1 / Buzzer pattern 2 / Buzzer pattern 3 / Buzzer pattern 4 / Buzzer pattern 5 / No change	Select the buzzer sound pattern.	●	–	–	–
⑫	Audio	No change	Stop / One-shot playback / Repeat playback / No Change	Select the audio playback pattern.	–	●	●	●
⑬	Audio (when [Repeat playback] is selected)	0	0 to 255	Set the number of times to repeat. In addition to normal audio playback, the audio is repeated the specified number of times. If the number of times to repeat is set to 255, playback is endless.	–	●	●	●
⑭	Audio Channel*1	Not selected	Not selected / 1 to 71	Select a registered channel.	–	●	●	●

No.	Item	Default Value	Input Range	Description	Setting ( ● : Yes – : No)			
					NHB Series	NHV Series		
						(empty)	<input type="checkbox"/> Model	<input type="checkbox"/> Model
⑮	Send email	Disabled	Enabled / Disabled	Set to [Enabled] or [Disabled] Sending email.	●	●	●	●
⑯	Subject	1	1 to 17	Select a subject for the email.	●	●	●	●
⑰	Body text	1	1 to 17	Select the body text of the email.	●	●	●	●
⑱	Mail destination setting	(Not selected)	–	Select the email recipient.	●	●	●	●
⑲	SNMP Notification	Disabled	Enabled / Disabled	Set to [Enabled] or [Disabled] SNMP Notification.	●	●	●	●
⑳	Send HTTP Command	Disabled	Enabled / Disabled	Set to [Enabled] or [Disabled] Send HTTP Command.	●	●	●	●
㉑	HTTP Command Sending Settings	(Not selected)	–	Select the recipient of the HTTP Command.	●	●	●	●
㉒	Send MQTT	Disabled	Enabled / Disabled	Set to [Enabled] or [Disabled] Send MQTT.	●	●	●	●
㉓	Contact output 1*2	No change	ON / OFF / No change	Specify operation of contact output 1.	–	–	–	●
㉔	Contact output 2	No change	ON / OFF / No change	Specify operation of contact output 2.	–	–	–	●

\*1 For the audio channel, you can select the following channels.

- In the [Voice Registration] screen, channel with registered audio
- Preset channel

\*2 When [Busy output] is specified in [Function] in [Contact output setting], this function is not operated.

### 9.3.3. SNMP Device Monitoring Settings

#### 9.3.3.1. Basic Settings

You can perform the SNMP Device Monitoring Function's authentication settings.

When ⑤ [Security Level] is set to [AuthNoPriv]

When ⑤ [Security Level] is set to [AuthPriv]

When ⑤ [Security Level] is set to [noAuthNoPriv]

No.	Item	Default Value	Input Range	Description	Setting ( ● : Yes – : No)			
					NHB Series	NHV Series		
						(empty)	<input type="checkbox"/> Model	<input type="checkbox"/> Model
①	SNMP Device Monitoring Function	Disabled	Enabled / Disabled	You can select to [Enabled] or [Disabled] the SNMP Device Monitoring Function.	●	●	●	●
②	GET Community Name	public	32 single-byte alphanumeric characters and underscore ( _ )	Enter the name for setting SNMP v1/v2c.	●	●	●	●
③	Connection Destination Number	Host 1	Host 1 to 20	Select the setting number of the monitoring target to connect with via SNMP v3.	●	●	●	●
④	Username	(Blank)	32 single-byte alphanumeric characters	Set the user name used for authentication in SNMP v3.	●	●	●	●
⑤	Security Level	AuthPriv	noAuthNoPriv / AuthNoPriv / AuthPriv	Select the security level for authentication in SNMP v3.	●	●	●	●
⑥	Authentication method	MD5	MD5 / SHA1	Select the Authentication method for authentication in SNMP v3.	●	●	●	●
⑦	Authentication password	(Blank)	8 to 64 single-byte alphanumeric characters	Register the authentication password.	●	●	●	●
⑧	Encryption Method	DES	DES / AES	Select the Encryption Method for authentication in SNMP v3.	●	●	●	●
⑨	Encryption Password	(Blank)	8 to 64 single-byte alphanumeric characters	Register the Encrypted Password.	●	●	●	●

### 9.3.3.2. Match Detection Settings

You can perform the SNMP Device Monitoring Function's Match Detection settings.

The screenshot displays the 'Match Detection Settings' for 'SNMP Device Monitoring'. The interface is divided into several sections:

- Match Detection1:** Includes fields for 'Condition Settings Number', 'Match Detection', 'Equipment Name', 'Monitored Address', 'SNMP Version', and 'SNMPv3 Certification'. It also features 'Judgment condition 1' and 'Judgment condition 2' with dropdowns for 'Series' and 'Value', and a 'Monitoring Period (0-60) sec.' field.
- Match Detection1 - Operation during communication timeout:** Includes 'Release Conditions' (Disabled/Enabled) and 'Number of retries(0-10)'.
- Match Detection1 - Operation when there is a match:** Contains color selection (Red, Amber, Green, Blue, White), 'Audio' settings, 'Send email' (Disabled/Enabled), 'Mail destination setting' (Subject and Body text), 'SNMP Notification', 'Send HTTP Command', 'HTTP Command Sending Settings', 'Send MQTT', and 'Contact output 1/2'.
- Match Detection1 - Operation when Condition is Released:** Similar to the match section, but for when the condition is no longer active.
- Re-evaluation of Match:** A grid of checkboxes for 'Equipment 1' through 'Equipment 20'.

**NHB**

Monitored Equipment - Operation Settings when an Error Occurs

Red: No change  
 Amber: No change  
 Green: No change  
 Blue: No change  
 White: No change  
 Bluzzer: No change

Send email: Disabled  Enabled  
 Subject: 1 Body text: 1  
 Mail destination setting: 1: Not registered 2: Not registered 3: Not registered 4: Not registered 5: Not registered 6: Not registered 7: Not registered 8: Not registered

**In [Additional units], [Multi-color unit] is specified**

Monitored Equipment - Operation Settings when an Error Occurs

Color: No change  
 Pattern: No change  
 Audio: No change Times  
 Audio Channel: Not selected  
 Send email: Disabled  Enabled  
 Subject: 1 Body text: 1  
 Mail destination setting: 1: Not registered 2: Not registered 3: Not registered 4: Not registered 5: Not registered 6: Not registered 7: Not registered 8: Not registered  
 SNMP Notification: Disabled  Enabled  
 Send HTTP Command: Disabled  Enabled



No.	Item	Default Value	Input Range	Description	Setting ( ● : Yes – : No)			
					NHB Series	NHV Series		
						(empty)	M Model	D Model
①	Condition Settings Number	Match Detection 1	Match Detection 1 to 20	Select the condition settings number to set.	●	●	●	●
②	Equipment Name	(Blank)	32 single-byte or double-byte characters	Register the name of the monitored equipment.	●	●	●	●
③	Monitored Address	(Blank)	IP Address Format (v4/v6) or host name (63 characters)	Register the monitored address.	●	●	●	●
④	SNMP Version	v2c	v1 / v2c / v3	Set the SNMP version to use.	●	●	●	●
⑤	SNMPv3 Certification (when SNMP version v3 is selected)	1	1 to 20	As set in [Basic Settings], specify the [Connection Destination Number].	●	●	●	●
⑥	OID	(Blank)	127 numeric characters and oeriod ( . )	Register the OID of the monitoring target. Also, select either [Specified OID Only], or [All Specified OID Below].	●	●	●	●
⑦	Series	Integer	Integer / OCTET STRING (String) / OCTET STRING (Binary)	Select the type of the variable-bindings OID to receive.	●	●	●	●
⑧	Value	(Blank)	0 to 2147483647 / 63 single-byte characters / 16 bytes (including comma as 1Byte)	Enter the value of variable-bindings to receive.	●	●	●	●
⑨	Monitoring Period (0-60) sec.	0	0 to 60	Select the monitoring frequency of the target equipment.	●	●	●	●
⑩	Release Conditions	Disabled	Enabled / Disabled	Select either [Enabled] or [Disabled] for the release condition on a communication timeout.	●	●	●	●
⑪	Number of retries (0 ~ 10)	0	0 to 10	Select the number of SNMP Command transmissions until a communication timeout is identified.	●	●	●	●
⑫	Red, Amber, Green, Blue, White	No change	Continuous ON / Flashing pattern 1 / Flashing pattern 2 / Flashing pattern 3 / Flashing pattern 4 / OFF / No change	Select each color of the Signal Tower.	●	●	●	●
⑬	Color	No change	Red / Amber / Green / Blue / White / Purple / Light blue / No change	Specify the color of the Multi-color unit.	●	●	●	●
⑭	Pattern	No change	Continuous ON / Flashing pattern 1 / Flashing pattern 2 / Flashing pattern 3 / Flashing pattern 4 / OFF / No change	Specify the lighting pattern of the Multi-color unit.	●	●	●	●

No.	Item	Default Value	Input Range	Description	Setting ( ● : Yes – : No)			
					NHB Series	NHV Series		
						(empty)	M Model	D Model
⑮	Buzzer	No change	Stop / Buzzer pattern 1 / Buzzer pattern 2 / Buzzer pattern 3 / Buzzer pattern 4 / Buzzer pattern 5 / No change	Select the buzzer sound pattern.	●	–	–	–
⑯	Audio	No change	Stop / One-shot playback / Repeat playback / No Change	Select the audio playback pattern.	–	●	●	●
⑰	Audio (when [Repeat playback] is selected)	0	0 to 255	Set the number of times to repeat. In addition to normal audio playback, the audio is repeated the specified number of times. If the number of times to repeat is set to 255, playback is endless.	–	●	●	●
⑱	Audio Channel*1	Not selected	Not selected / 1 to 71	Select a registered channel.	–	●	●	●
⑲	Send email	Disabled	Enabled / Disabled	Set to [Enabled] or [Disabled] Send email.	●	●	●	●
⑳	Subject	1	1 to 17	Select a subject for the email.	●	●	●	●
㉑	Body text	1	1 to 17	Select the body text of the email.	●	●	●	●
㉒	Mail destination setting	(Not selected)	–	Select the email recipient.	●	●	●	●
㉓	SNMP Notification	Disabled	Enabled / Disabled	Set to [Enabled] or [Disabled] SNMP Notification.	●	●	●	●
㉔	Send HTTP Command	Disabled	Enabled / Disabled	Set to [Enabled] or [Disabled] Send HTTP Command.	●	●	●	●
㉕	HTTP Command Sending Settings	(Not selected)	–	Select the recipient of the HTTP Command.	●	●	●	●
㉖	Send MQTT	Disabled	Enabled / Disabled	Set to [Enabled] or [Disabled] Send MQTT.	●	●	●	●
㉗	Contact output 1*2	No change	OFF / ON / No change	Specify operation of contact output 1.	–	–	–	●
㉘	Contact output 2	No change	OFF / ON / No change	Specify operation of contact output 2.	–	–	–	●
㉙	Re-evaluation of Match	(Not selected)	–	For the release condition operation, select the condition settings number that is returned to monitoring status.	●	●	●	●

\*1 For audio, you can select the following channels.

- In the [Voice Registration] screen, channel with registered audio
- Preset channel

\*2 When [Busy output] is specified in [Function] in [Contact output setting], this function is not operated.

### 9.3.3.3. Change Detection Settings

You can perform SNMP Device Monitoring Function's Detect Change settings.

The screenshot shows the 'SNMP Device Monitoring Change detection settings' page. The interface includes a left sidebar with navigation options like 'Main unit settings', 'Command Reception Settings', and 'Monitoring Settings'. The main content area is titled 'SNMP Device Monitoring Change detection settings' and contains the following sections:

- Change detection1**: Fields for 'Monitored Address', 'SNMP Version' (set to v3), 'SNMPv3 Certification' (set to 1), 'Monitored OID', and 'Monitoring Period (0-60) sec'.
- Change detection1 - Operation when change is detected**: A table of color settings:
 

Red	No change
Amber	No change
Green	No change
Blue	No change
White	No change
- Audio**: 'No change' and 'Times'.
- Audio Channel**: 'Not selected'.
- Send email**: 'Disabled' / 'Enabled' (checked).
- Mail destination setting**: A grid of checkboxes for destinations 1-8, with '1: Not registered' selected.
- SNMP Notification**: 'Disabled' / 'Enabled' (checked).
- Send HTTP Command**: 'Disabled' / 'Enabled' (checked).
- HTTP Command Sending Settings**: A grid of checkboxes for destinations 1-8, with '1: Not registered' selected.
- Send MQTT**: 'Disabled' / 'Enabled' (checked).
- Contact output 1**: 'No change'.
- Contact output 2**: 'No change'.

#### NHB

This screenshot shows the 'Monitored Equipment - Operation Settings when an Error Occurs' for NHB units. It includes settings for color (Red, Amber, Green, Blue, White), 'Buzzer' (set to 'No change'), 'Send email' (Enabled), 'Subject', 'Body text', 'Mail destination setting', 'SNMP Notification' (Enabled), and 'Send HTTP Command' (Enabled).

#### In [Additional units], [Multi-color unit] is specified

This screenshot shows the 'Monitored Equipment - Operation Settings when an Error Occurs' for multi-color units. It includes settings for 'Color' (set to 'No change'), 'Pattern' (set to 'No change'), 'Audio', 'Audio Channel', 'Send email', 'Subject', 'Body text', 'Mail destination setting', 'SNMP Notification' (Enabled), and 'Send HTTP Command' (Enabled).

No.	Item	Default Value	Input Range	Description	Setting ( ● : Yes – : No)			
					NHB Series	NHV Series		
						(empty)	M Model	D Model
①	Condition Settings Number	Change detection 1	Change detection 1 to 5	Select the condition settings number to set.	●	●	●	●
②	Equipment Name	(Blank)	32 single-byte or double-byte characters	Register the name of the monitored equipment.	●	●	●	●
③	Monitored Address	(Blank)	IP Address Format (v4/v6) or host name (63 characters)	Register the monitored address.	●	●	●	●
④	SNMP Version	v1	v1 / v2c / v3	Set the SNMP version to use.	●	●	●	●
⑤	SNMPv3 Certification (when SNMP version v3 is selected)	1	1 to 20	As set in [Basic Settings], specify the [Connection Destination Number].	●	●	●	●
⑥	Monitored OID	(Blank)	127 numeric characters and oeriod ( . )	Register the OID of the monitoring target.	●	●	●	●
⑦	Monitoring Period (0-60) sec.	0	0 to 60	Select the monitoring frequency of the target equipment.	●	●	●	●
⑧	Red, Amber, Green, Blue, White	No change	Continuous ON / Flashing pattern 1 / Flashing pattern 2 / Flashing pattern 3 / Flashing pattern 4 / OFF / No change	Select each color of the Signal Tower.	●	●	●	●
⑨	Color	No change	Red / Amber / Green/ Blue / White / Purple/ Light blue / No change	Specify the color of the Multi-color unit.	●	●	●	●
⑩	Pattern	No change	Continuous ON / Flashing pattern 1 / Flashing pattern 2 / Flashing pattern 3 / Flashing pattern 4 / OFF / No change	Specify the lighting pattern of the Multi-color unit.	●	●	●	●
⑪	Buzzer	No change	Stop / Buzzer pattern 1 / Buzzer pattern 2 / Buzzer pattern 3 / Buzzer pattern 4 / Buzzer pattern 5 / No change	Select the buzzer sound pattern.	●	–	–	–
⑫	Audio	No change	Stop / One-shot playback / Repeat playback / No Change	Select the audio playback pattern.	–	●	●	●
⑬	Audio (when [Repeat playback] is selected)	0	0 to 255	Set the number of times to repeat. In addition to normal audio playback, the audio is repeated the specified number of times. If the number of times to repeat is set to 255, playback is endless.	–	●	●	●

No.	Item	Default Value	Input Range	Description	Setting ( ● : Yes – : No)			
					NHB Series	NHV Series		
						(empty)	<input type="checkbox"/> Model	<input type="checkbox"/> Model
⑭	Audio Channel* <sup>1</sup>	Not selected	Not selected / 1 to 71	Select a registered channel.	–	●	●	●
⑮	Send email	Disabled	Enabled / Disabled	Set to [Enabled] or [Disabled] Send email.	●	●	●	●
⑯	Subject	1	1 to 17	Select a subject for the email.	●	●	●	●
⑰	Body text	1	1 to 17	Select the body text of the email.	●	●	●	●
⑱	Mail destination setting	(Not selected)	–	Select the email recipient.	●	●	●	●
⑲	SNMP Notification	Disabled	Enabled / Disabled	Set to [Enabled] or [Disabled] SNMP Notification.	●	●	●	●
⑳	Send HTTP Command	Disabled	Enabled / Disabled	Set to [Enabled] or [Disabled] Send HTTP Command.	●	●	●	●
㉑	HTTP Command Sending Settings	(Not selected)	–	Select the recipient of the HTTP Command.	●	●	●	●
㉒	Send MQTT	Disabled	Enabled / Disabled	Set to [Enabled] or [Disabled] Send MQTT.	●	●	●	●
㉓	Contact output 1* <sup>2</sup>	No change	OFF / ON / No change	Specify operation of contact output 1.	–	–	–	●
㉔	Contact output 2	No change	OFF / ON / No change	Specify operation of contact output 2.	–	–	–	●

\*1 For the audio channel, you can select the following channels.

- In the [Voice Registration] screen, channel with registered audio
- Preset channel

\*2 When [Busy output] is specified in [Function] in [Contact output setting], this function is not operated.

### 9.3.4. Contact Input Setting

#### 9.3.4.1. Status Change Detection Settings NHV Series (D model)

Set the operation to run when there is a state change in contact input.

The screenshot displays the 'Contact input Status Change Detection Settings' page. It features a left-hand navigation menu and a main content area. The main area is divided into two sections: 'Contact input1 - Operation Settings During ON Status Change' and 'Contact input1 - Operation Settings During OFF Status Change'. Each section contains a grid of settings for different colors (Red, Amber, Green, Blue, White) and various notification methods (Audio, Send email, Mail destination setting, SNMP Notification, Send HTTP Command, Send MQTT, Contact output 1, Contact output 2, and Clear Conditions). Numbered callouts (1-21) identify specific UI elements across both sections.

In [Additional units], [Multi-color unit] is specified

This is a detailed view of the 'Monitored Equipment - Operation Settings when an Error Occurs' section. It shows a grid of settings for different colors (Red, Amber, Green, Blue, White) and various notification methods. Callouts 6 and 7 point to the 'Color' and 'Pattern' settings respectively.

No.	Item	Default Value	Input Range	Description	Setting (● : Yes – : No)			
					NHB Series	NHV Series		
						(empty)	[M] Model	[D] Model
①	Port Selection	Contact input 1	Contact input 1 to 4	Select the contact input number to set.	–	–	–	●
②	Contact input ■*1	Disabled	Enabled / Disabled	You can select to [Enabled] or [Disabled] the specified contact input.	–	–	–	●
③	Boolean value	Contact A	Contact A / Contact B	Select the [Boolean Value] as either [Contact A] or [Contact B].	–	–	–	●
④	Signal Definition	OFF Status Change	ON Status Change / OFF Status Change / Status change	Select the signal definition as [ON Status Change], [OFF Status Change], or [Status change].	–	–	–	●
⑤	Red, Amber, Green, Blue, White	No change	Continuous ON / Flashing pattern 1 / Flashing pattern 2 / Flashing pattern 3 / Flashing pattern 4 / OFF / No change	Select each color of the Signal Tower.	–	–	–	●
⑥	Color	No change	Red / Amber / Green / Blue / White / Purple / Light blue / No change	Specify the color of the Multi-color unit.	–	–	–	●
⑦	Pattern	No change	Continuous ON / Flashing pattern 1 / Flashing pattern 2 / Flashing pattern 3 / Flashing pattern 4 / OFF / No change	Specify the lighting pattern of the Multi-color unit.	–	–	–	●
⑧	Audio	No change	Stop / One-shot playback / Repeat playback / No change	Select the audio playback pattern.	–	–	–	●
⑨	Audio (when [Repeat playback] is selected)	0	0 to 255	Set the number of times to repeat. In addition to normal audio playback, the audio is repeated the specified number of times. If the number of times to repeat is set to 255, playback is endless.	–	–	–	●
⑩	Audio Channel*2	Not selected	Not selected / 1 to 71	Select a registered channel.	–	–	–	●
⑪	Send email	Disabled	Enabled / Disabled	Set to [Enabled] or [Disabled] Send email.	–	–	–	●
⑫	Subject	1	1 to 17	Select a subject for the email.	–	–	–	●
⑬	Body text	1	1 to 17	Select the body text of the email.	–	–	–	●
⑭	Mail destination setting	(Not selected)	–	Select the email recipient.	–	–	–	●
⑮	SNMP Notification	Disabled	Enabled / Disabled	Set to [Enabled] or [Disabled] SNMP Notification.	–	–	–	●
⑯	Send HTTP Command	Disabled	Enabled / Disabled	Set to [Enabled] or [Disabled] Send HTTP Command.	–	–	–	●

No.	Item	Default Value	Input Range	Description	Setting (● : Yes –: No)			
					NHB Series	NHV Series		
						(empty)	[M] Model	[D] Model
⑰	HTTP Command Sending Settings	(Not selected)	–	Select the recipient of the HTTP Command.	–	–	–	●
⑱	Send MQTT	Disabled	Enabled / Disabled	Set to [Enabled] or [Disabled] Send MQTT.	–	–	–	●
⑲	Contact output 1*3	No change	OFF / ON / No change	Specify operation of contact output 1.	–	–	–	●
⑳	Contact output 2	No change	OFF / ON / No change	Specify operation of contact output 2.	–	–	–	●
㉑	Clear conditions	(Not selected)	–	Select the condition to reset the measurement time of the Match Detection Settings.	–	–	–	●

\*1 ■ is a contact input number.

\*2 For the audio channel, you can select the following channels.

- In the [Voice Registration] screen, channel with registered audio
- Preset channel

\*3 When [Busy output] is specified in [Function] in [Contact output setting], this function is not operated.



### 9.3.4.2. Match Detection Settings NHV Series (D model)

Set the operation to run when there is a condition match in contact input.

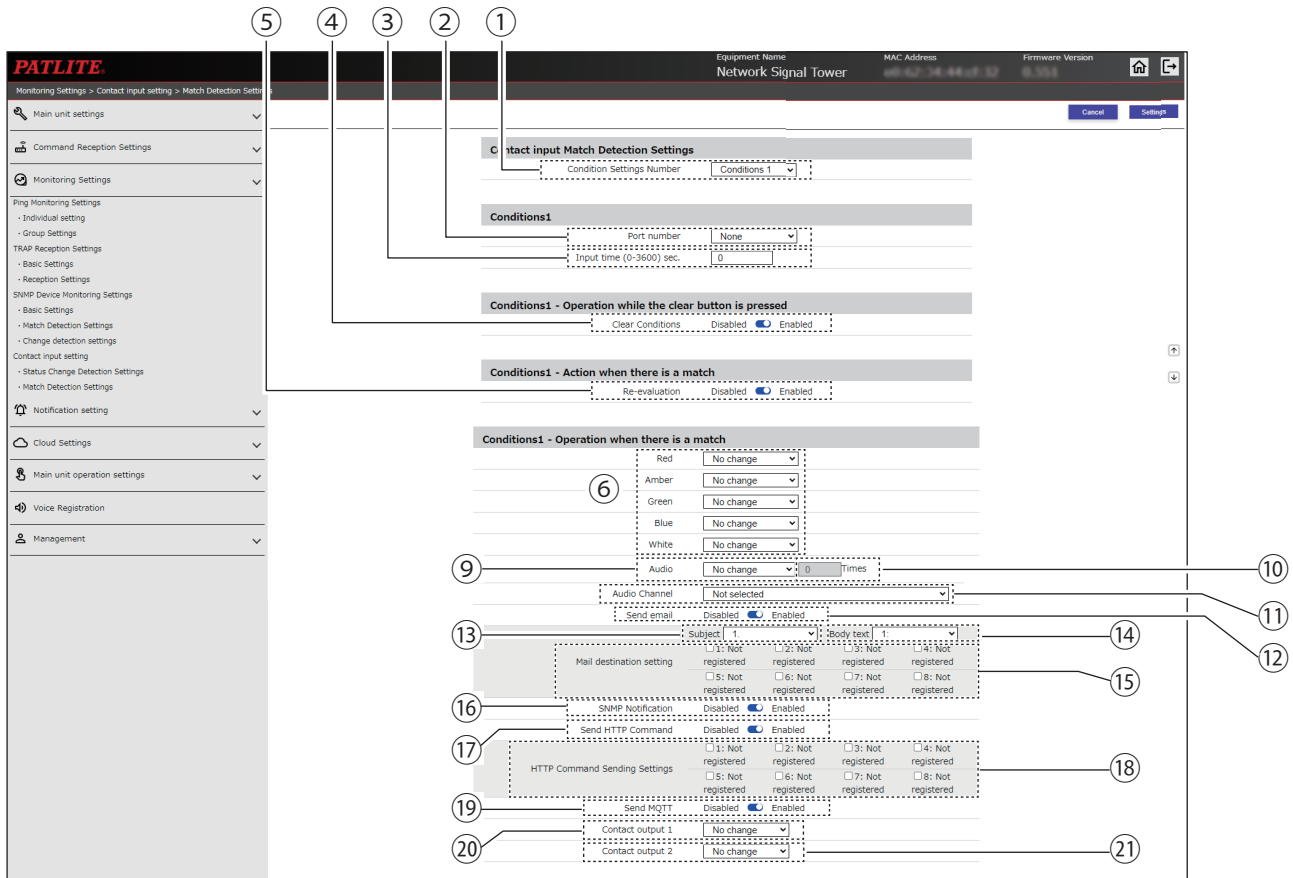

In [Additional units], [Multi-color unit] is specified

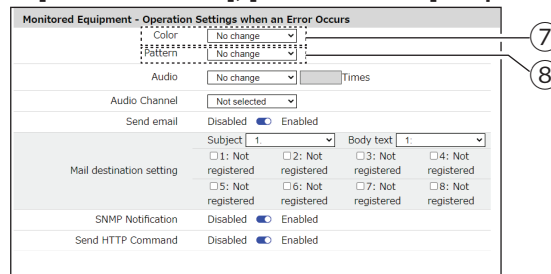

No.	Item	Default Value	Input Range	Description	Setting ( ● : Yes – : No)			
					NHV Series	NHV Series		
						(empty)	M Model	D Model
①	Condition Settings Number	Condition 1	Condition 1 to 4	Select the condition settings number to set.	–	–	–	●
②	Port number	None	None / Contact input 1 to 4	Select the contact input number for performing the condition setting.	–	–	–	●
③	Input time (0-3600) sec.	0	0 to 3600	Set the input time.	–	–	–	●
④	Clear Conditions	Disabled	Enabled / Disabled	You can select to [Enabled] or [Disabled] the clear function for when the Clear button is pressed.	–	–	–	●

No.	Item	Default Value	Input Range	Description	Setting ( ● : Yes – : No)			
					NHB Series	NHV Series		
						(empty)	M Model	D Model
⑤	Re-evaluation	Disabled	Enabled / Disabled	After the conditions match, you can select to [Enabled] or [Disabled] re-evaluating the same condition.	–	–	–	●
⑥	Red, Amber, Green, Blue, White	No change	Continuous ON / Flashing pattern 1 / Flashing pattern 2 / Flashing pattern 3 / Flashing pattern 4 / OFF / No change	Select each color of the Signal Tower.	–	–	–	●
⑦	Color	No change	Red / Amber / Green / Blue / White / Purple / Light blue / No change	Specify the color of the Multi-color unit.	–	–	–	●
⑧	Pattern	No change	Continuous ON / Flashing pattern 1 / Flashing pattern 2 / Flashing pattern 3 / Flashing pattern 4 / OFF / No change	Specify the lighting pattern of the Multi-color unit.	–	–	–	●
⑨	Audio	No change	Stop / One-shot playback / Repeat playback / No Change	Select the audio playback pattern.	–	–	–	●
⑩	Audio (when [Repeat playback] is selected)	0	0 to 255	Set the number of times to repeat. In addition to normal audio playback, the audio is repeated the specified number of times. If the number of times to repeat is set to 255, playback is endless.	–	–	–	●
⑪	Audio Channel*1	Not selected	Not selected / 1 to 71	Select a registered channel.	–	–	–	●
⑫	Send email	Disabled	Enabled / Disabled	Set to [Enabled] or [Disabled] Send email.	–	–	–	●
⑬	Subject	1	1 to 17	Select a subject for the email.	–	–	–	●
⑭	Body text	1	1 to 17	Select the body text of the email.	–	–	–	●
⑮	Mail destination setting	(Not selected)	–	Select the email recipient.	–	–	–	●
⑯	SNMP Notification	Disabled	Enabled / Disabled	Set to [Enabled] or [Disabled] SNMP Notification.	–	–	–	●
⑰	Send HTTP Command	Disabled	Enabled / Disabled	Set to [Enabled] or [Disabled] Send HTTP Command.	–	–	–	●

No.	Item	Default Value	Input Range	Description	Setting ( ● : Yes –: No)			
					NHB Series	NHV Series		
						(empty)	<input type="checkbox"/> Model	<input type="checkbox"/> Model
⑱	HTTP Command Sending Settings	(Not selected)	–	Select the recipient of the HTTP Command.	–	–	–	●
⑲	Send MQTT	Disabled	Enabled / Disabled	Set to [Enabled] or [Disabled] Send MQTT.	–	–	–	●
⑳	Contact output 1*2	No change	OFF / ON / No change	Specify operation of contact output 1.	–	–	–	●
㉑	Contact output 2	No change	OFF / ON / No change	Specify operation of contact output 2.	–	–	–	●

\*1 For the audio channel, you can select the following channels.

- In the [Voice Registration] screen, channel with registered audio
- Preset channel

\*2 When [Busy output] is specified in [Function] in [Contact output setting], this function is not operated.

### 9.3.5. Mail Detection Setting Screen NHV Series (M model)

Configure the setting for detecting emails and the operation to perform when emails are detected.

#### 9.3.5.1. Mail Server Settings

Mail server is undefined

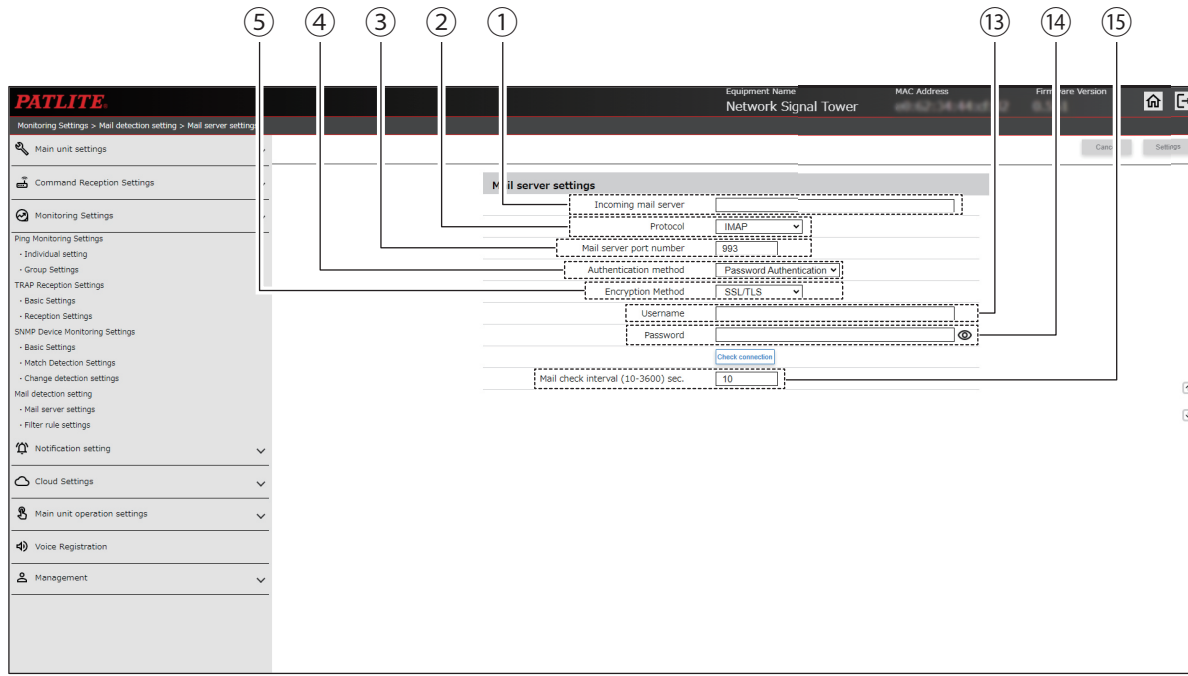

Gmail server is specified and OAUTH2 is selected

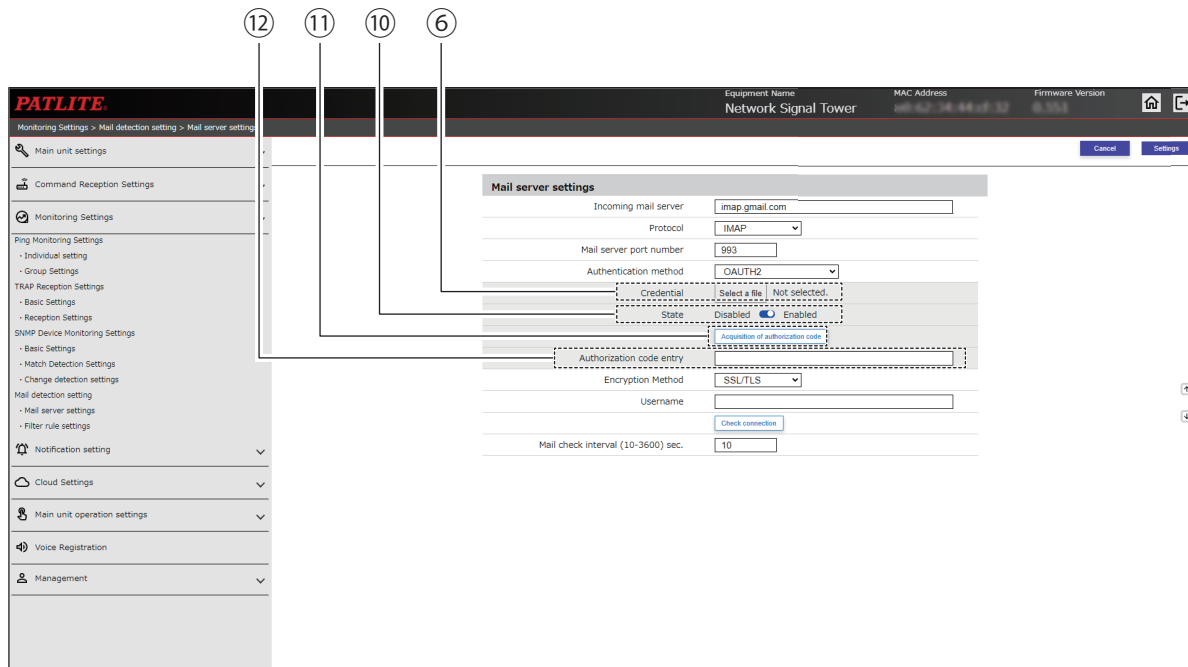

### Outlook server is specified and OAUTH2 is selected

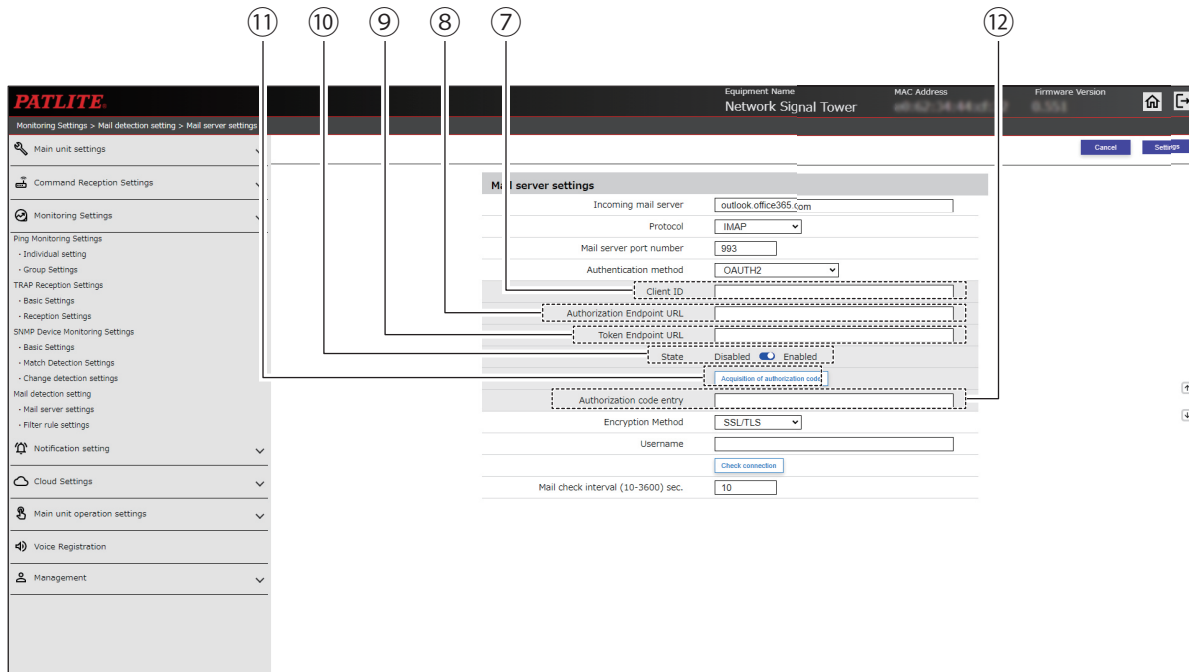

### POP is specified

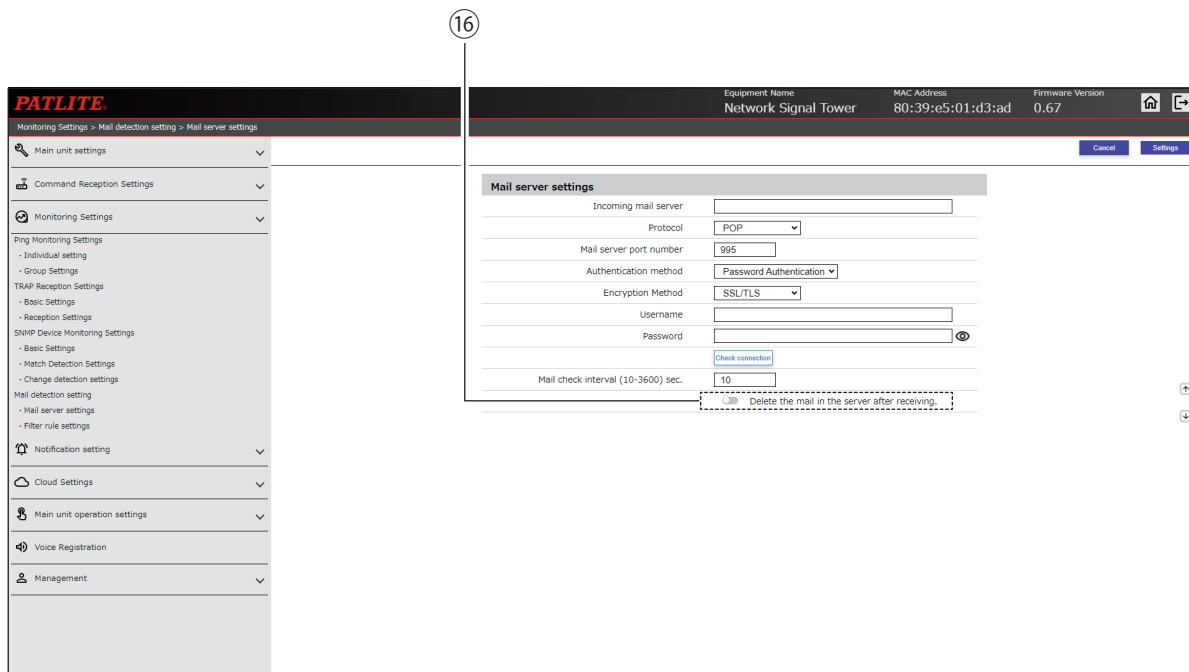

No.	Item	Default Value	Input Range	Description	Setting ( ● : Yes – : No)			
					NHB Series	NHV Series		
						(empty)	M Model	D Model
①	Incoming mail server	(Blank)	IP Address Format (v4/v6) or host name (63 characters)	Enter the mail server address.	–	–	●	–
②	Protocol	IMAP	IMAP / POP	Select the protocol for the mail server.	–	–	●	–
③	Mail server port number	993	1 to 65535	Enter the mail server port number. The default port for each protocol is entered when the protocol is selected.	–	–	●	–
④	Authentication method	Password Authentication	Password Authentication / OAUTH2*1	Select either [Password Authentication] or [OAuth2].	–	–	●	–
⑤	Encryption Method	SSL/TLS	SSL/TLS / STARTTLS / None	Select [SSL/TLS], [STARTTLS], or [None].	–	–	●	–
⑥	Credential	–	–	Upload the Credential file.	–	–	●	–
⑦	Client ID	(Blank)	127 single-byte alphanumeric and symbol characters	Enter the client ID.	–	–	●	–
⑧	Authorization Endpoint URL	(Blank)	511 single-byte alphanumeric and symbol characters	Enter the authorization endpoint URL.	–	–	●	–
⑨	Token Endpoint URL	(Blank)	511 single-byte alphanumeric and symbol characters	Enter the Token Endpoint URL.	–	–	●	–
⑩	State	Enabled	Enabled / Disabled	Select either [Enabled] or [Disabled] for the State.	–	–	●	–
⑪	Acquisition of authorization code	–	–	For an OAuth2 connection, get an authorization code.	–	–	●	–
⑫	Authorization code entry	(Blank)	–	Enter the authorization code you retrieved.	–	–	●	–
⑬	Username	(Blank)	63 single-byte alphanumeric and symbol characters	Enter a user name for Password Authentication.	–	–	●	–
⑭	Password	(Blank)	32 single-byte alphanumeric and symbol characters	Enter the password for Password Authentication.	–	–	●	–
⑮	Mail check interval (10-3600) sec.	10	10 to 3600	Specify the interval for checking the mail server.	–	–	●	–
⑯	Delete the mail in the server after receiving.*2	Disabled	Enabled / Disabled	Specify the interval for checking the mail server.	–	–	●	–

\*1 You can select [OAUTH2] when one of the following addresses is specified as the [Incoming mail server].

• Gmail server: imap.gmail.com pop.gmail.com

• Outlook server: outlook.office365.com

\*2 Setting is available only when [POP] is selected.

### 9.3.5.2. Filter Rule Settings

The screenshot displays the 'Filter rule settings' configuration page. At the top, it shows the equipment name 'Network Signal Tower' and other system information. The left sidebar contains a navigation menu with categories like 'Monitoring Settings', 'Notification setting', and 'Management'. The main area is divided into several functional sections:

- Filter rule settings:** Includes a dropdown for 'Conditions' (set to 1) and radio buttons for 'Meets all of the following.', 'Meets one of the following.', and 'None'. Below are five rows, each with a 'Sender' dropdown and a 'Matches with' dropdown.
- Conditions 1 - Operation when there is a match:** Features color selection (Red, Amber, Green, Blue, White) with 'No change' dropdowns, and an 'Audio' dropdown set to 'No change' with a 'Times' input field.
- Send email:** Includes a 'Send email' toggle (set to 'Enabled'), a 'Subject' dropdown (set to '1'), and a 'Body text' dropdown (set to '1').
- Mail destination setting:** A grid of checkboxes for destinations 1-8, each with 'Not registered' and 'registered' options.
- SNMP Notification:** A toggle set to 'Enabled'.
- Send HTTP Command:** A toggle set to 'Enabled'.
- HTTP Command Sending Settings:** A grid of checkboxes for destinations 1-8, each with 'Not registered' and 'registered' options.
- Send MQTT:** A toggle set to 'Enabled'.

Numbered callouts (1-14) are placed around the interface to highlight specific components: 1 points to the 'Filter rule settings' title; 2 points to the color selection; 3 points to the 'Send email' toggle; 4 points to the 'Subject' dropdown; 5 points to the 'Body text' dropdown; 6 points to the 'Mail destination setting' grid; 7 points to the 'SNMP Notification' toggle; 8 points to the 'Send HTTP Command' toggle; 9 points to the 'HTTP Command Sending Settings' grid; 10 points to the 'Send MQTT' toggle; 11 points to the 'Send email' subject dropdown; 12 points to the 'Send email' body text dropdown; 13 points to the 'Send MQTT' toggle; 14 points to the 'Send email' toggle.

In [Additional units], [Multi-color unit] is specified

This screenshot shows the 'Monitored Equipment - Operation Settings when an Error Occurs' configuration page. The settings are as follows:

- Color:** Dropdown menu (callout 3).
- Pattern:** Dropdown menu.
- Audio:** Dropdown menu and 'Times' input field.
- Audio Channel:** Dropdown menu (set to 'Not selected').
- Send email:** Toggle set to 'Enabled'.
- Mail destination setting:** Grid of checkboxes for destinations 1-8, each with 'Not registered' and 'registered' options.
- SNMP Notification:** Toggle set to 'Enabled'.
- Send HTTP Command:** Toggle set to 'Enabled'.
- HTTP Command Sending Settings:** Grid of checkboxes for destinations 1-8, each with 'Not registered' and 'registered' options.

No.	Item	Default Value	Input Range	Description	Setting ( ● : Yes – : No)			
					NHB Series	NHV Series		
						(empty)	<input type="checkbox"/> Model	<input type="checkbox"/> Model
①	Conditions	1	1 to 20	Select the condition number to set in a filter rule.	–	–	●	–
		Meets all of the following.	Meets all of the following. / Meets one of the following. / None	Specify the match condition for when multiple filter rules are set.	–	–	●	–
		Sender	Sender / Subject / Body text	Select the content to detect.	–	–	●	–
		(Blank)	63 characters	Enter the text to detect.	–	–	●	–
		Matches with	Matches with / Beginning with / Include / Be free of	Select the match condition.	–	–	●	–
②	Red, Amber, Green, Blue, White	No change	Continuous ON / Flashing pattern 1 / Flashing pattern 2 / Flashing pattern 3 / Flashing pattern 4 / OFF / No change	Select each color of the Signal Tower.	–	–	●	–
③	Color	No change	Red / Amber / Green/ Blue / White / Purple/ Light blue / No change	Specify the color of the Multi-color unit.	–	–	●	–
	Pattern	No change	Continuous ON / Flashing pattern 1 / Flashing pattern 2 / Flashing pattern 3 / Flashing pattern 4 / OFF / No change	Specify the lighting pattern of the Multi-color unit.	–	–	●	–
④	Audio	No change	Stop / One-shot playback / Repeat playback / No Change	Select the audio playback pattern.	–	–	●	–
⑤	Audio (when [Repeat playback] is selected)	0	0 to 255	Set the number of times to repeat. In addition to normal audio playback, the audio is repeated the specified number of times. If the number of times to repeat is set to 255, playback is endless.	–	–	●	–
⑥	Audio Channel	Not selected	Not selected / 1 to 71*	Select a registered channel.	–	–	●	–
⑦	Send email	Disabled	Enabled / Disabled	Set to [Enabled] or [Disabled] Send email.	–	–	●	–
⑧	Subject	1	1 to 17	Select a subject for the email.	–	–	●	–
⑨	Body text	1	1 to 17	Select the body text of the email.	–	–	●	–
⑩	Mail destination setting	(Not selected)	-	Select the email recipient.	–	–	●	–
⑪	SNMP Notification	Disabled	Enabled / Disabled	Set to [Enabled] or [Disabled] SNMP Notification.	–	–	●	–



No.	Item	Default Value	Input Range	Description	Setting ( ● : Yes –: No)			
					NHB Series	NHV Series		
						(empty)	<input type="checkbox"/> Model	<input type="checkbox"/> Model
⑫	Send HTTP Command	Disabled	Enabled / Disabled	Set to [Enabled] or [Disabled] Send HTTP Command.	–	–	●	–
⑬	HTTP Command Sending Settings	(Not selected)	-	Select the recipient of the HTTP Command.	–	–	●	–
⑭	Send MQTT	Disabled	Enabled / Disabled	Set to [Enabled] or [Disabled] Send MQTT.	–	–	●	–

- \* For the audio channel, you can select the following channels.
- In the [Voice Registration] screen, channel with registered audio
  - Preset channel

## 9.4. Notification Settings

### 9.4.1. SNMP Notification Settings

Set TRAP transmission settings for external notification of events that occur on this product.

Screen when [v1 - Trap] or [ v2c - Trap/Inform] is selected in ⑤

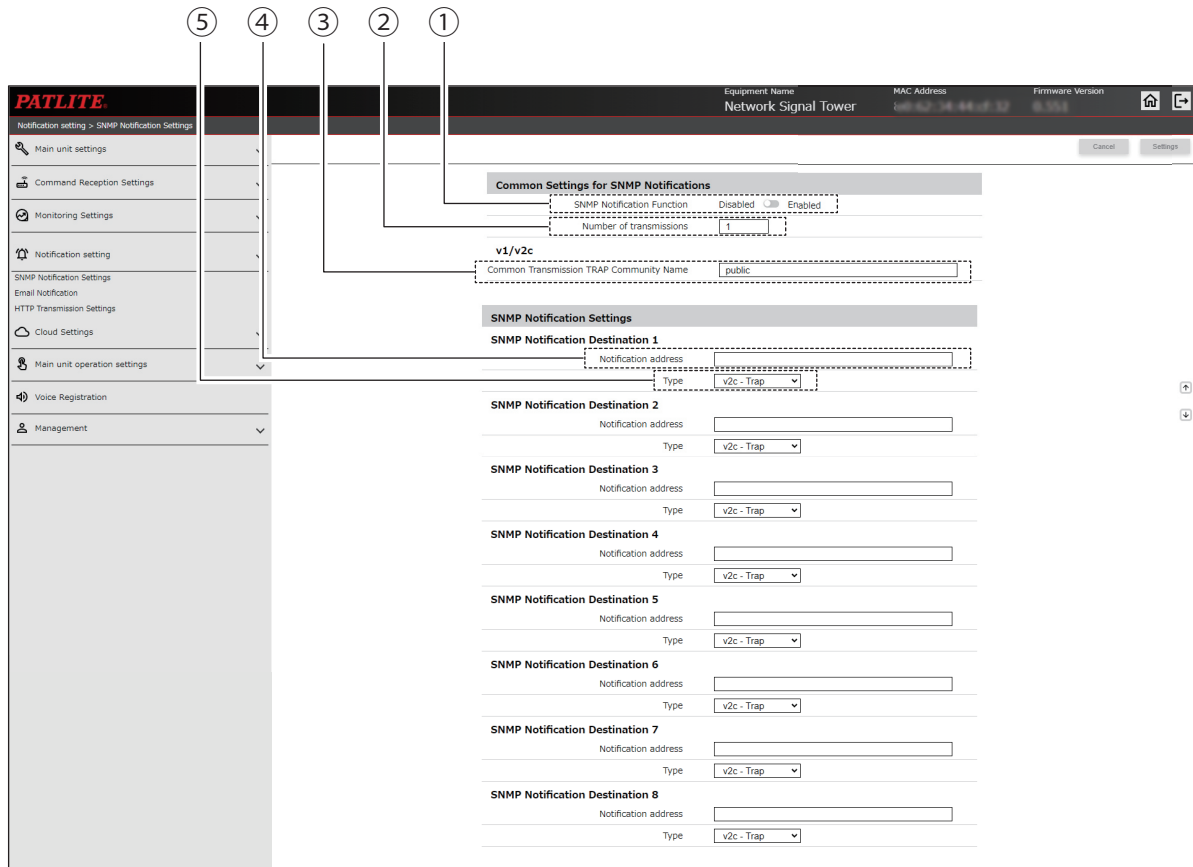

Screen when [v3 - Trap/Inform] is selected in ⑤

The screenshot displays the 'SNMP Notification Settings' page in the PATLITE web interface. The left sidebar contains navigation menus such as 'Main unit settings', 'Command Reception Settings', 'Monitoring Settings', 'Notification setting', 'SNMP Notification Settings', 'Email Notification', 'HTTP Transmission Settings', 'Cloud Settings', 'Main unit operation settings', 'Voice Registration', and 'Management'. The top status bar shows 'Network Signal Tower' with fields for 'Equipment Name', 'MAC Address', 'Firmware', and 'Version'. The main content area is divided into two main sections:

- Common Settings for SNMP Notifications:**
  - SNMP Notification Function: Disabled (radio button) / Enabled (radio button)
  - Number of transmissions: 1
  - v1/v2c: Common Transmission TRAP Community Name: public
- SNMP Notification Settings:**
  - SNMP Notification Destination 1:**
    - Notification address: [Field]
    - Type: v3 - Trap (dropdown)
    - Username: [Field]
    - Security Level: AuthPriv (dropdown)
    - Authentication method: MDS5 (radio button) / SHA1 (radio button)
    - Authentication password: [Field]
    - Encryption Method: DES (radio button) / AES (radio button)
    - Encrypted Password: [Field]
    - Engine ID: [Field]
  - SNMP Notification Destination 2:**
    - Notification address: [Field]
    - Type: v3 - Trap (dropdown)
    - Username: [Field]
    - Security Level: AuthPriv (dropdown)
    - Authentication method: MDS5 (radio button) / SHA1 (radio button)
    - Authentication password: [Field]
    - Encryption Method: DES (radio button) / AES (radio button)
    - Encrypted Password: [Field]
    - Engine ID: [Field]
  - SNMP Notification Destination 3:**
    - Notification address: [Field]
    - Type: v3 - Trap (dropdown)
    - Username: [Field]
    - Security Level: AuthPriv (dropdown)
    - Authentication method: MDS5 (radio button) / SHA1 (radio button)
    - Authentication password: [Field]
    - Encryption Method: DES (radio button) / AES (radio button)
    - Encrypted Password: [Field]
    - Engine ID: [Field]
  - SNMP Notification Destination 4:**
    - Notification address: [Field]
    - Type: v3 - Trap (dropdown)
    - Username: [Field]
    - Security Level: AuthPriv (dropdown)
    - Authentication method: MDS5 (radio button) / SHA1 (radio button)
    - Authentication password: [Field]
    - Encryption Method: DES (radio button) / AES (radio button)
    - Encrypted Password: [Field]
    - Engine ID: [Field]
  - SNMP Notification Destination 5:**
    - Notification address: [Field]
    - Type: v3 - Trap (dropdown)
    - Username: [Field]
    - Security Level: AuthPriv (dropdown)
    - Authentication method: MDS5 (radio button) / SHA1 (radio button)
    - Authentication password: [Field]
    - Encryption Method: DES (radio button) / AES (radio button)
    - Encrypted Password: [Field]
    - Engine ID: [Field]
  - SNMP Notification Destination 6:**
    - Notification address: [Field]
    - Type: v3 - Trap (dropdown)
    - Username: [Field]
    - Security Level: AuthPriv (dropdown)
    - Authentication method: MDS5 (radio button) / SHA1 (radio button)
    - Authentication password: [Field]
    - Encryption Method: DES (radio button) / AES (radio button)
    - Encrypted Password: [Field]
    - Engine ID: [Field]

Numbered callouts (1-12) indicate specific UI elements: 1 points to the 'SNMP Notification Function' section; 2 points to the 'v1/v2c' section; 3 points to the 'Common Transmission TRAP Community Name' field; 4 points to the 'SNMP Notification Destination 1' section; 5 points to the 'SNMP Notification Function' dropdown; 6 points to the 'SNMP Notification Destination 1' 'Type' dropdown; 7 points to the 'SNMP Notification Destination 1' 'Security Level' dropdown; 8 points to the 'SNMP Notification Destination 1' 'Authentication method' radio buttons; 9 points to the 'SNMP Notification Destination 1' 'Authentication password' field; 10 points to the 'SNMP Notification Destination 1' 'Encryption Method' radio buttons; 11 points to the 'SNMP Notification Destination 1' 'Encrypted Password' field; 12 points to the 'SNMP Notification Destination 1' 'Engine ID' field.

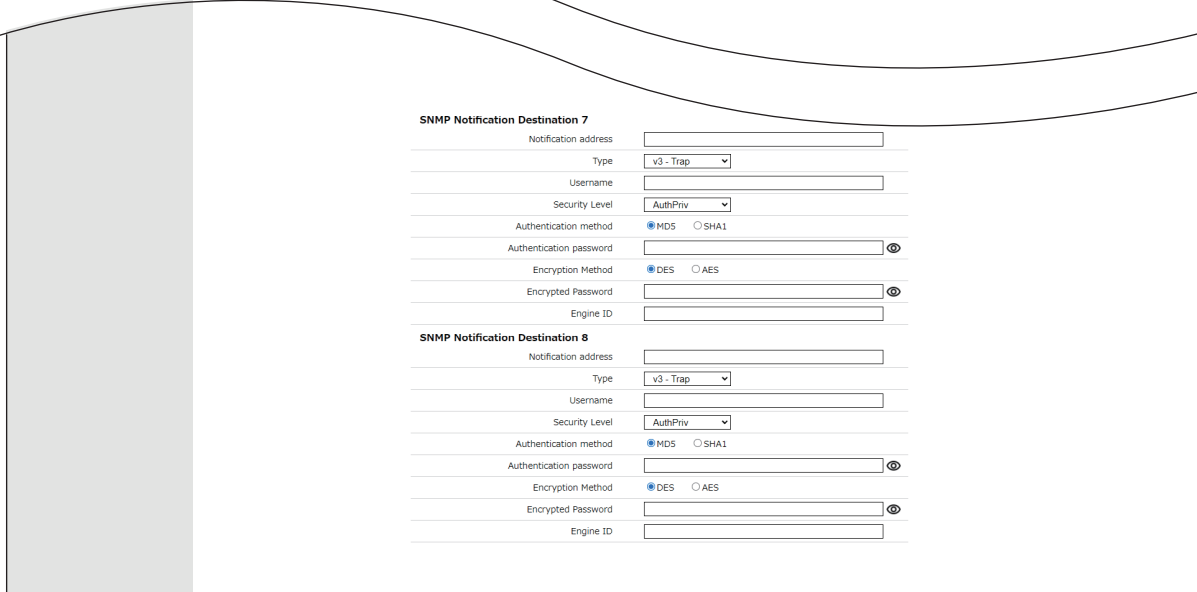

No.	Item	Default Value	Input Range	Description	Setting ( ● : Yes, –: No)			
					NHB Series	NHV Series		
						(empty)	[M] Model	[D] Model
①	SNMP Notification Function	Disabled	Enabled / Disabled	You can select to [Enabled] or [Disabled] the SNMP Notification Function.	●	●	●	●
②	Number of transmissions	1	0 to 10	For SNMP notification, enter the number of times the same TRAP is transmitted.	●	●	●	●
③	Common Transmission TRAP Community Name	public	32 single-byte alphanumeric characters and underscore ( _ )	When [v1/v2c] is selected, enter the community name to transmit.	●	●	●	●
④	Notification address	(Blank)	IP Address Format (v4/v6) or host name (63 characters)	Set the target address to which SNMP notifications are sent.	●	●	●	●
⑤	Type	v2c - Trap	v1 - Trap / v2c - Trapv2c - Inform / v3 - Trap / v3 - Inform	Select the SNMP version and notification method.	●	●	●	●
⑥	Username*1	(Blank)	32 single-byte alphanumeric characters	Set the user name used for authentication in SNMP v3.	●	●	●	●
⑦	Security Level*1	AuthPriv	noAuthNoPriv / AuthNoPriv / AuthPriv	Select the security level for authentication in SNMP v3.	●	●	●	●
⑧	Authentication method*1 *2	MD5	MD5 / SHA1	Select the Authentication method for authentication in SNMP v3.	●	●	●	●
⑨	Authentication password*1 *2	(Blank)	8 to 64 single-byte alphanumeric characters	Enter the authentication password of equipment that is notified.	●	●	●	●

No.	Item	Default Value	Input Range	Description	Setting ( ● : Yes, –: No)			
					NHB Series	NHV Series		
						(empty)	[M] Model	[D] Model
⑩	Encryption Method* <sup>1</sup> * <sup>3</sup>	DES	DES / AES	Select the Encryption Method for authentication in SNMP v3.	●	●	●	●
⑪	Encryption Password* <sup>1</sup> * <sup>3</sup>	(Blank)	8 to 64 single-byte alphanumeric characters	Enter the Encrypted Password of equipment that is notified.	●	●	●	●
⑫	Engine ID* <sup>1</sup>	(Blank)	64 hexadecimal characters	Displays the engine ID of equipment that is notified.	●	●	●	●

\*1 Displays when the [SNMP Version] is either [v3 - Trap] or [v3 - Inform].

\*2 If you select [noAuthNoPriv] for the [Security Level], you cannot configure this setup item.

\*3 If you select [noAuthNoPriv] or [AuthNoPriv] for the [Security Level], you cannot configure this setup item.

### 9.4.2. Email Notification Settings

Set the send email settings for this product, as well as the subject and body of email that is sent. When you send email, you can select from the subject and body content registered here.

Screen when [SMTP Certification] is selected in ③

The screenshot displays the 'Email Notification' settings page for a Network Signal Tower. The interface is divided into several sections:

- Server Connection Settings:** Contains fields for SMTP Server Address (12), SMTP Server Port (4, 3), and Authentication options (1). The 'How to Authenticate SMTP' section has radio buttons for 'Certification' (selected) and 'No Authentication'. Below this is the 'Encryption Method' dropdown (set to 'None') and the 'SMTP Account Name' and 'SMTP Passwords' fields (13, 14, 19).
- Transmission Settings:** Includes a 'Sent-from e-mail address' field and a table for 'Send-to address' with 8 rows (20).
- Email subject:** A table with 16 rows for defining email subject lines (21).
- Email body text settings:** A table with 16 rows for defining email body text (22).

The left sidebar contains the following menu items: Main unit settings, Command Reception Settings, Monitoring Settings, Notification setting (selected), SNMP Notification Settings, Email Notification, HTTP Transmission Settings, Cloud Settings, Main unit operation settings, Voice Registration, and Management.

**[Incoming Mail Server] is specified as [Gmail Server], and [Authentication Method] is [OAUTH2]**

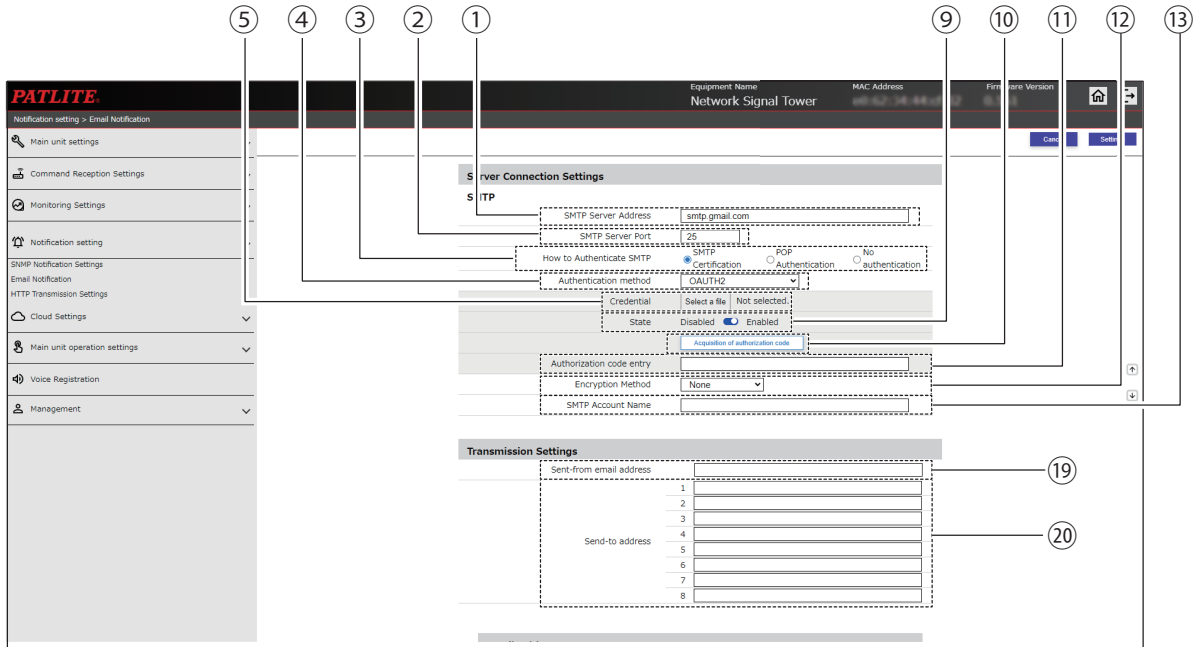

**[Incoming Mail Server] is specified as [Outlook Server], and [Authentication Method] is [OAUTH2]**

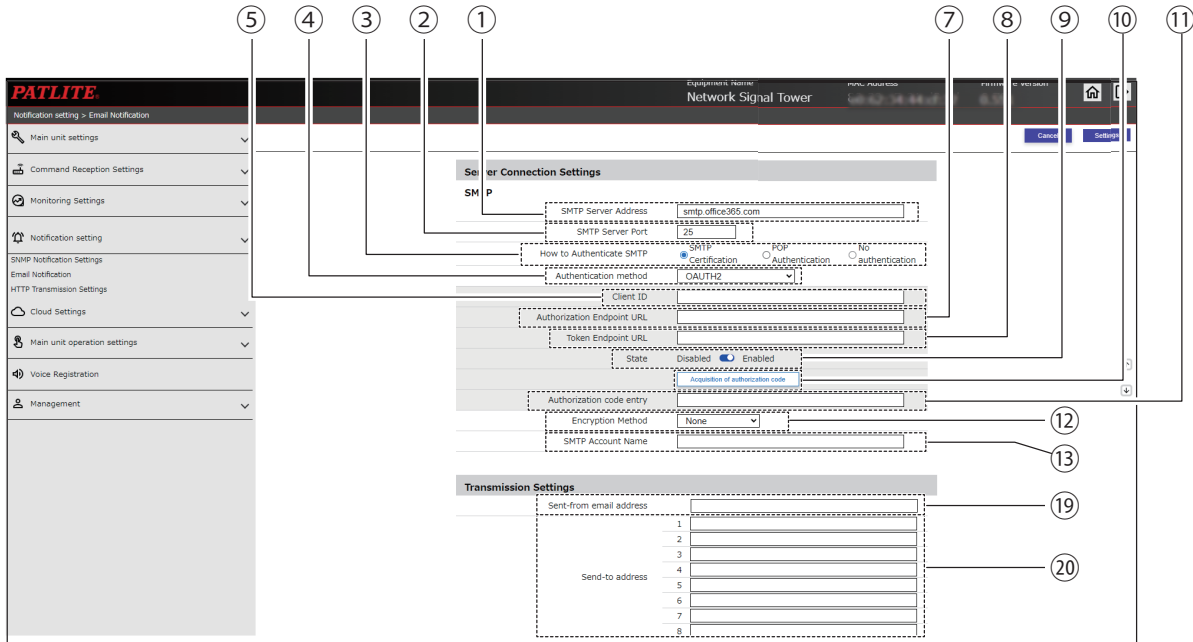

Screen when [POP Authentication] is selected in ③

The screenshot displays the 'Email Notification' configuration page for a 'Network Signal Tower'. The left sidebar contains the following menu items: Main unit settings, Command Reception Settings, Monitoring Settings, Notification setting, SNMP Notification Settings, Email Notification, HTTP Transmission Settings, Cloud Settings, Main unit operation settings, Voice Registration, and Management. The main content area is divided into several sections:

- Header:** Equipment Name: Network Signal Tower, MAC Address: [redacted], Firmware Ver: [redacted].
- Server Connection Settings:**
  - SMTP: SMTP Server Address, SMTP Server Port (25), How to Authenticate SMTP (Certification, Authentication, authentication).
  - POP: POP Server Address, POP Server Port (110), POP Account Name, POP Password.
- Transmission Settings:**
  - Sent from e-mail address: 1-8.
  - Send-to address: 1-8.
- Email subject:** 1-16.
- Email body text settings:** 1-16.

Numbered callouts indicate the following elements:

- ③: POP Authentication radio button.
- ⑤: POP Server Port field.
- ⑥: POP Account Name field.
- ⑦: POP Password field.
- ⑧: Send-to address list.
- ⑨: Email subject list.
- ⑩: Email body text settings list.
- ⑪: Main unit settings menu.
- ⑫: Command Reception Settings menu.
- ⑬: Monitoring Settings menu.
- ⑭: Notification setting menu.
- ⑮: SMTP Server Port field.
- ⑯: POP Server Port field.
- ⑰: POP Account Name field.
- ⑱: POP Password field.
- ⑲: Send-to address list.
- ⑳: Email subject list.
- ㉑: Email body text settings list.



### Screen when [No authenticate] is selected in ③

The screenshot displays the 'Email Notification' configuration page. On the left is a navigation menu with categories like 'Main unit settings', 'Monitoring Settings', and 'Notification setting'. The main content area is titled 'Server Connection Settings' and includes an 'SMTP' section with fields for 'SMTP Server Address' and 'SMTP Server Port' (set to 25). Under 'How to Authenticate SMTP', the 'No authentication' radio button is selected. Below this is the 'Transmission Settings' section, which contains a table for 'Send-to address' with 8 rows. Further down are 'Email subject' and 'Email body text settings', each with a 16-row table. Callout 3 points to the 'No authentication' radio button. Callout 19 points to the 'SMTP' radio button. Callout 20 points to the 'Send-to address' table. Callout 21 points to the 'Email subject' table. Callout 22 points to the 'Email body text settings' table. The top right of the screen shows 'Equipment Name: Network Signal Tower', 'MAC Address', and 'Firmware Version'.

No.	Item	Default Value	Input Range	Description	Setting ( ● : Yes –: No)			
					NHB Series	NHV Series		
						(empty)	M Model	D Model
①	SMTP Server Address	(Blank)	IP Address Format (v4/v6) or host name (63 characters)	Enter the SMTP Server Address.	●	●	●	●
②	SMTP Server Port	25	0 to 65535	Enter the SMTP Server port number.	●	●	●	●
③	How to Authenticate SMTP	No authentication	SMTP Certification / POP Authentication / No authentication	Select [SMTP Authentication], [POP Authentication], or [No authentication].	●	●	●	●
④	Authentication method	Password Authentication	Password Authentication / OAUTH2*1	Select either [Password Authentication] or [OAUTH2].	●	●	●	●
⑤	Credential	–	–	Upload the Credential file.	●	●	●	●
⑥	Client ID	(Blank)	127 single-byte alphanumeric and symbol characters	Enter the client ID.	●	●	●	●
⑦	Authorization Endpoint URL	(Blank)	511 single-byte alphanumeric and symbol characters	Enter the authorization endpoint URL.	●	●	●	●
⑧	Token Endpoint URL	(Blank)	511 single-byte alphanumeric and symbol characters	Enter the Token Endpoint URL.	●	●	●	●
⑨	State	Enabled	Enabled / Disabled	Select either [Enabled] or [Disabled] for the State.	●	●	●	●
⑩	Acquisition of authorization code	–	–	For an OAuth2 connection, get an authorization code.	●	●	●	●
⑪	Authorization code entry	–	–	Enter the authorization code you retrieved.	●	●	●	●
⑫	Encryption Method	None	SSL/TLS / STARTTLS / None	Select [SSL / TLS], [STARTTLS], or [None].	●	●	●	●
⑬	SMTP Account Name	(Blank)	32 single-byte alphanumeric and symbol characters	Enter an account name for SMTP authentication.	●	●	●	●
⑭	SMTP Passwords	(Blank)	32 single-byte alphanumeric and symbol characters	Enter the password for SMTP authentication.	●	●	●	●
⑮	POP Server Address	(Blank)	IP Address Format (v4/v6) or host name (63 characters)	Enter the POP3 Server Address.	●	●	●	●
⑯	POP Server Port	110	1 to 65535	Enter the POP3 Server port number.	●	●	●	●
⑰	POP Account Name	(Blank)	32 single-byte alphanumeric and symbol characters	Register an account name for POP authentication.	●	●	●	●
⑱	POP Password	(Blank)	32 single-byte alphanumeric and symbol characters	Register a password for POP authentication.	●	●	●	●

No.	Item	Default Value	Input Range	Description	Setting ( ● : Yes – : No)			
					NHB Series	NHV Series		
						(empty)	M Model	D Model
⑰	Sent-from e-mail address	(Blank)	Email address format 63 single-byte alphanumeric and symbol characters	Enter the source address of email.	●	●	●	●
⑱	Send-to address	(Blank)	Email address format 63 single-byte alphanumeric and symbol characters	Enter the email address of the recipient.	●	●	●	●
㉑	Email subject 1 to 16	(Blank)	32 single-byte or double-byte characters	Enter subject 1 to 16.	●	●	●	●
㉒	Email body text Settings 1 to 16	(Blank)	63 single-byte or double-byte characters	Enter body 1 to 16.	●	●	●	●

- \*1 You can select [OAUTH2] when one of the following addresses is specified as the [SMTP Server Address].
- Gmail server: smtp.gmail.com
  - Outlook server: smtp.office365.com

### 9.4.3. HTTP Transmission Settings

Set the HTTP Transmission Settings on this product.

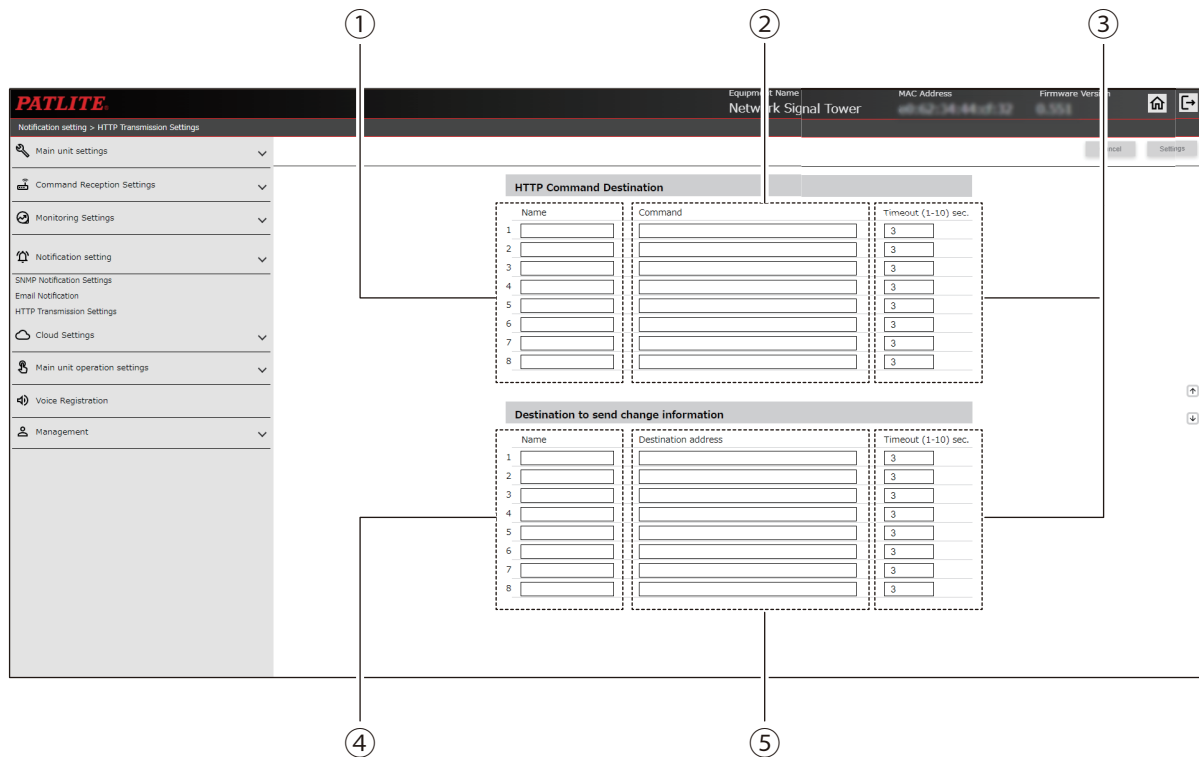

No.	Item	Default Value	Input Range	Description	Setting ( ● : Yes –: No)			
					NHB Series	NHV Series		
						(empty)	M Model	D Model
①	Name	(Blank)	64 single-byte or double-byte characters	Register the name of the command.	●	●	●	●
②	Command*	(Blank)	128 single-byte alphanumeric and symbol characters	Register the command.	●	●	●	●
③	Timeout (1-10) sec.	3	1 to 10	Register the timeout time.	●	●	●	●
④	Name	(Blank)	64 single-byte or double-byte characters	Register the name of the connection target.	●	●	●	●
⑤	Destination address	(Blank)	IP Address Format (v4/v6) or host name (128 characters) including "http / https"	Register the connection target address.	●	●	●	●

\* You can enter the following symbols in locations that accept symbols.  
 " - (Hyphen)", " . (Period)", " # (Sharp)", " % (Percent)", " , (Comma)", " \* (Asterisk)", " + (Plus)", " \_ (Underscore)"  
 Some symbols (" - (Hyphen)", " . (Period)", and " # (Sharp)") cannot use as the first character.

## 9.5. Cloud Settings

### 9.5.1. Azure Connection Settings

Configure settings to connect to IoT Central (DPS) or Azure IoT Hub.

[Host] is specified as [IoT Central(DPS)]

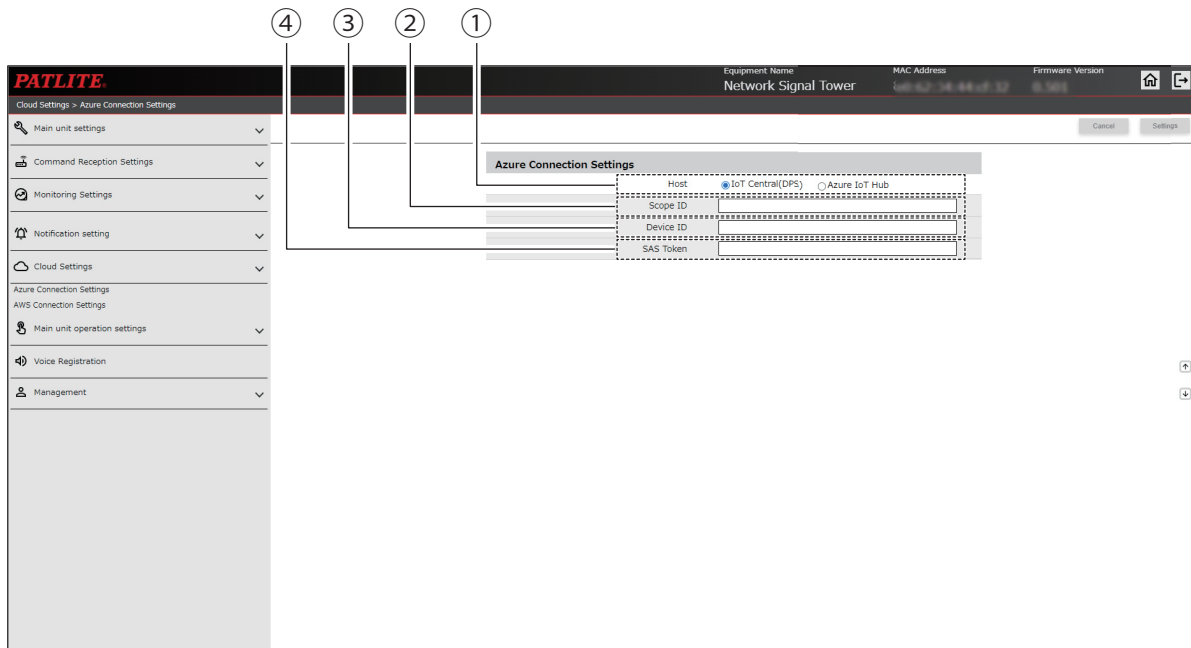

[Host] is specified as [Azure IoT Hub], and [Authentication] is specified as [Symmetric key]

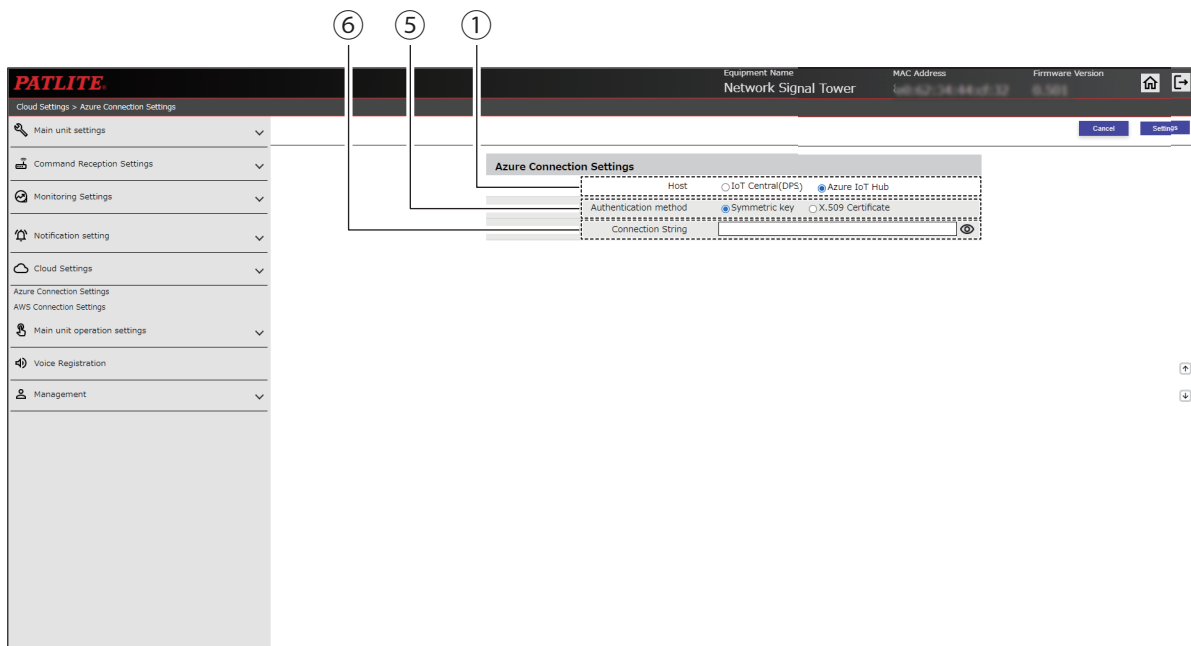

[Host] is specified as [Azure IoT Hub], and [Authentication] is specified as [X.509 Certificate]

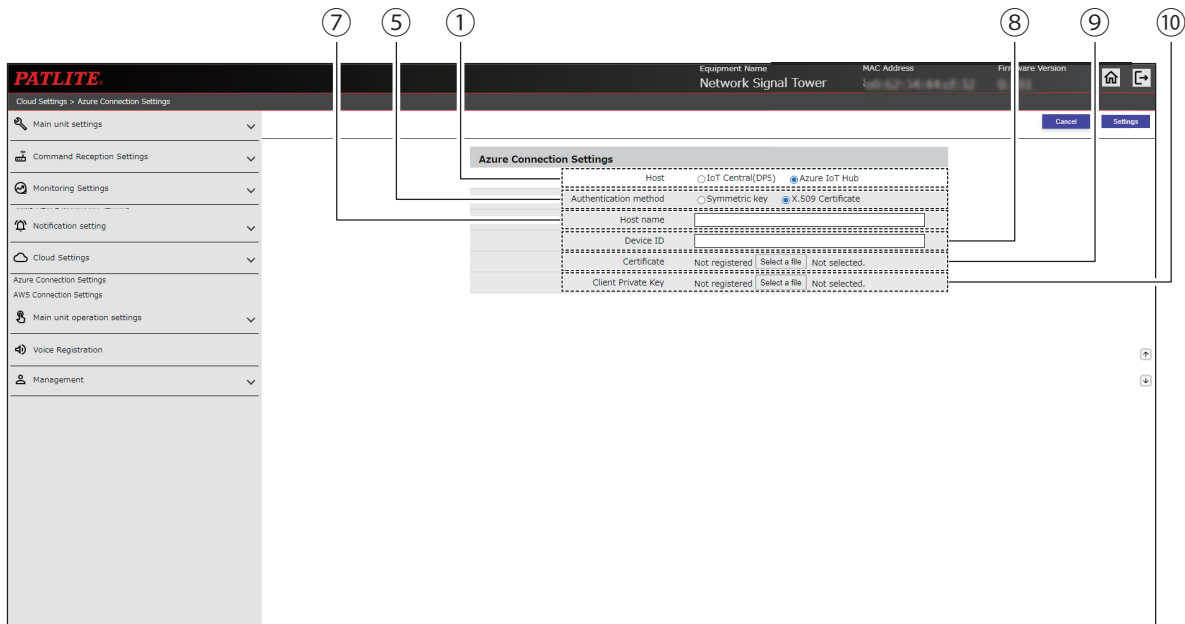

No.	Item	Default Value	Input Range	Description	Setting ( ● : Yes – : No)			
					NHB Series	NHV Series		
						(empty)	M Model	D Model
①	Host	IoT Central (DPS)	IoT Central (DPS) / Azure IoT Hub	Select [IoT Central (DPS)] or [Azure IoT Hub].	●	●	●	●
②	Scope ID	(Blank)	127 single-byte characters	Enter the scope ID to connect to [IoT Central (DPS)].	●	●	●	●
③	Device ID	(Blank)	127 single-byte characters	Enter the device ID to connect to [IoT Central (DPS)].	●	●	●	●
④	SAS Token	(Blank)	127 single-byte characters	Enter the SAS token to connect to [IoT Central (DPS)].	●	●	●	●
⑤	Authentication method	Symmetric key	Symmetric key / X.509 Certificate	Select either [Symmetric key] or [X.509 Certificate].	●	●	●	●
⑥	Connection String	(Blank)	511 single-byte characters	Enter the connection string to connect to [Azure IoT Hub].	●	●	●	●
⑦	Host name	(Blank)	255 single-byte characters	Enter the host name of [Azure IoT Hub].	●	●	●	●
⑧	Device ID	(Blank)	127 single-byte characters	Enter the device ID to connect to [Azure IoT Hub].	●	●	●	●
⑨	Certificate	–	–	Upload the X.509 certificate.	●	●	●	●
⑩	Client Private Key	–	–	Upload the client private key	●	●	●	●

### 9.5.2. AWS Connection Settings

Configure settings to connect to Amazon Web Services.

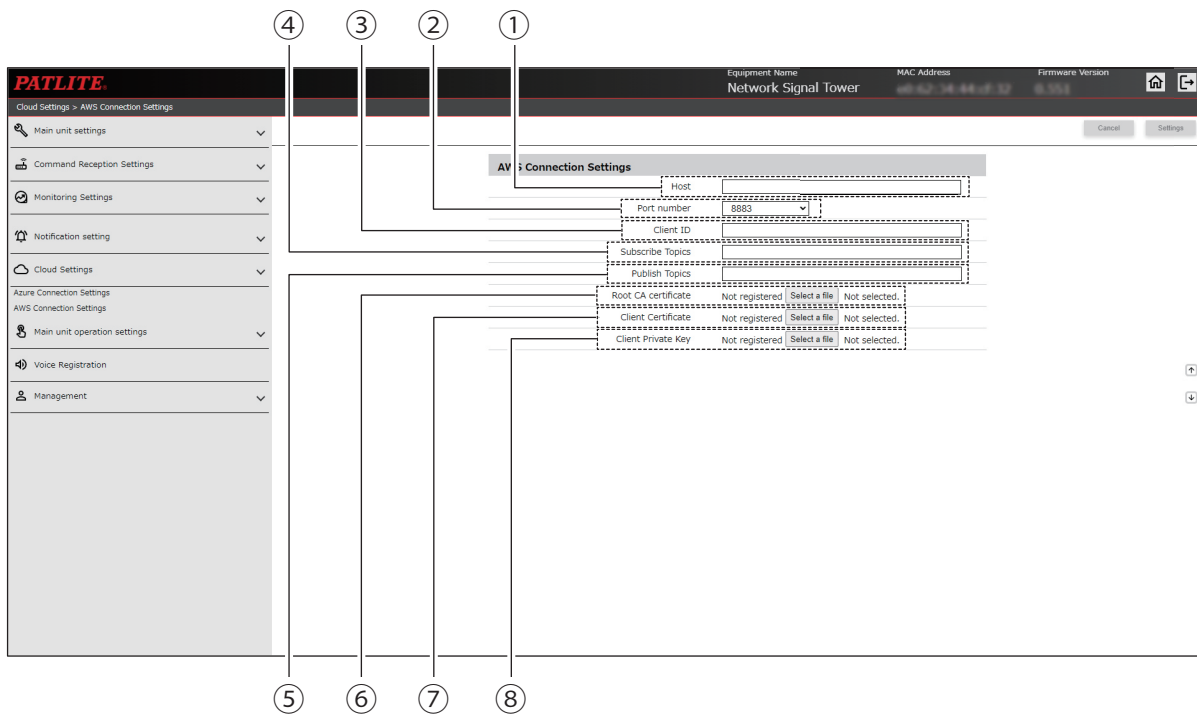

No.	Item	Default Value	Input Range	Description	Setting (● : Yes – : No)			
					NHB Series	NHV Series		
						(empty)	M Model	D Model
①	Host	(Blank)	511 single-byte characters	Enter the AWS IoT Core Device data endpoint.	●	●	●	●
②	Port number	8883	443 / 8883	Select the port number used to communicate with AWS IoT Core.	●	●	●	●
③	Client ID	(Blank)	127 single-byte characters	Register the ID name (the name of the thing).	●	●	●	●
④	Subscribe Topics	(Blank)	255 single-byte characters	Register topics to Subscribe for this product.	●	●	●	●
⑤	Publish Topics	(Blank)	255 single-byte characters	Topic is registered when you run Publish on this product.	●	●	●	●
⑥	Root CA certificate	–	–	Uploads the Root CA certificate.	●	●	●	●
⑦	Client Certificate	–	–	Uploads the Client Certificate.	●	●	●	●
⑧	Client Private Key	–	–	Uploads the Client Private Key.	●	●	●	●

## 9.6. Main Unit Operation Settings

### 9.6.1. Clear Operation Settings

Configure email, TRAP, or HTTP Commands transmitted when the Clear button is pressed, or when a SNMP or RSH Command executes a clear operation.

The screenshot displays the 'Clear Operation Settings' page in the PATLITE web interface. The left sidebar contains a navigation menu with items like 'Main unit settings', 'Command Reception Settings', 'Monitoring Settings', 'Notification setting', 'Cloud Settings', 'Main unit operation settings', 'Clear Operation Settings', 'Test button settings', 'Contact output setting', 'Signal Tower Operation', 'Voice Registration', and 'Management'. The main content area is titled 'Main unit operation settings > Clear Operation Settings' and shows the following sections:

- Equipment Information:** Network Signal Tower, MAC, address, Firmware, Version.
- Clear Button Settings:** Clear button status (Disabled/Enabled).
- Notification Settings when Clear Button is Pressed:** Includes 'Send email', 'SNMP Notification', 'Send HTTP Command', and 'Send MQTT' settings. It also features a 'Mail destination setting' table with 8 slots (1-8) for email recipients.
- HTTP Command Sending Settings:** Similar to the notification settings, with 8 slots for command destinations.
- Clear stages:** Options for 'Clear All' and 'Depress twice to clear all'.
- Audio:** Options for 'Stop' and 'Skip'.
- Clear Signal Tower:** A multi-color selection table with 8 slots (1-8) for different colors (Red, Amber, Green, Blue, White).
- Notification Setting when SNMP is Cleared:** Similar structure to the 'Clear Button' notification settings.
- Notification Settings when RSH/SSH is Cleared:** Similar structure to the 'Clear Button' notification settings.

Numbered callouts (1-12) point to specific elements: 1-6 point to the top navigation and equipment info; 7-12 point to the 'Clear Button' and 'SNMP Cleared' notification settings sections.

In Basic Setup Screen, from [Additional units] the [Multi-color unit] option is selected

This close-up shows the 'Clear Signal Tower' section of the settings. It features a table with 8 columns and 5 rows of color options. The 'Multi-color unit' option is selected, indicated by a blue dot in the first column of the first row.

<input checked="" type="radio"/>	<input type="radio"/>	<input type="radio"/>	<input type="radio"/>	<input type="radio"/>	<input type="radio"/>	<input type="radio"/>	<input type="radio"/>
Red	Amber	Green	Blue	White			
Disabled	Disabled	Disabled	Disabled	Disabled	Disabled	Disabled	Disabled
Enabled	Enabled	Enabled	Enabled	Enabled	Enabled	Enabled	Enabled
Enabled	Enabled	Enabled	Enabled	Enabled	Enabled	Enabled	Enabled

Callout 13 points to the selected 'Multi-color unit' option.



No.	Item	Default Value	Input Range	Description	Setting ( ● : Yes –: No)			
					NHB Series	NHV Series		
						(empty)	[M] Model	[D] Model
①	Clear Button	Enabled	Enabled / Disabled	Select either [Enabled] or [Disabled] for the Clear button.	●	●	●	●
②	Send email	Disabled	Enabled / Disabled	Set to [Enabled] or [Disabled] Send email.	●	●	●	●
③	Subject	1	1 to 17	Select a subject for the email.	●	●	●	●
④	Body text	1	1 to 17	Select the body text of the email.	●	●	●	●
⑤	Mail destination setting	(Not selected)	–	Select the email recipient.	●	●	●	●
⑥	SNMP Notification	Disabled	Enabled / Disabled	Set to [Enabled] or [Disabled] SNMP notification.	●	●	●	●
⑦	Send HTTP Command	Disabled	Enabled / Disabled	Set to [Enabled] or [Disabled] Send HTTP Command.	●	●	●	●
⑧	HTTP Command Sending Settings	(Not selected)	–	Select a HTTP Command.	●	●	●	●
⑨	Send MQTT	Disabled	Enabled / Disabled	Set to [Enabled] or [Disabled] Send MQTT.	●	●	●	●
⑩	Clear stages	Clear all	Clear all / Depress twice to clear all	Select the Clear button operation, [Clear all] or [Depress twice to clear all]	●	●	●	●
⑪	Audio (in [Basic Settings], when [Audio Playback Mode] is set to [Memory playback mode])	Stop	Stop / Skip	Select the clear operation ([Stop] or [Skip]) for the channel that is playing.	–	●	●	●
⑫	Clear Signal Tower (Red, Amber, Green, Blue, White)	Enabled	Enabled / Disabled	For when the Clear button is pressed, select either [Enabled] or [Disabled] for the Signal Tower's normal operation setting.	●	●	●	●
⑬	Clear Signal Tower	Enabled	Enabled / Disabled	For when the Clear button is pressed, select either [Enabled] or [Disabled] for the Signal Tower's normal operation setting.	●	●	●	●

### 9.6.2. Test Button Setting

You can set the operation for when the Test button is pressed.

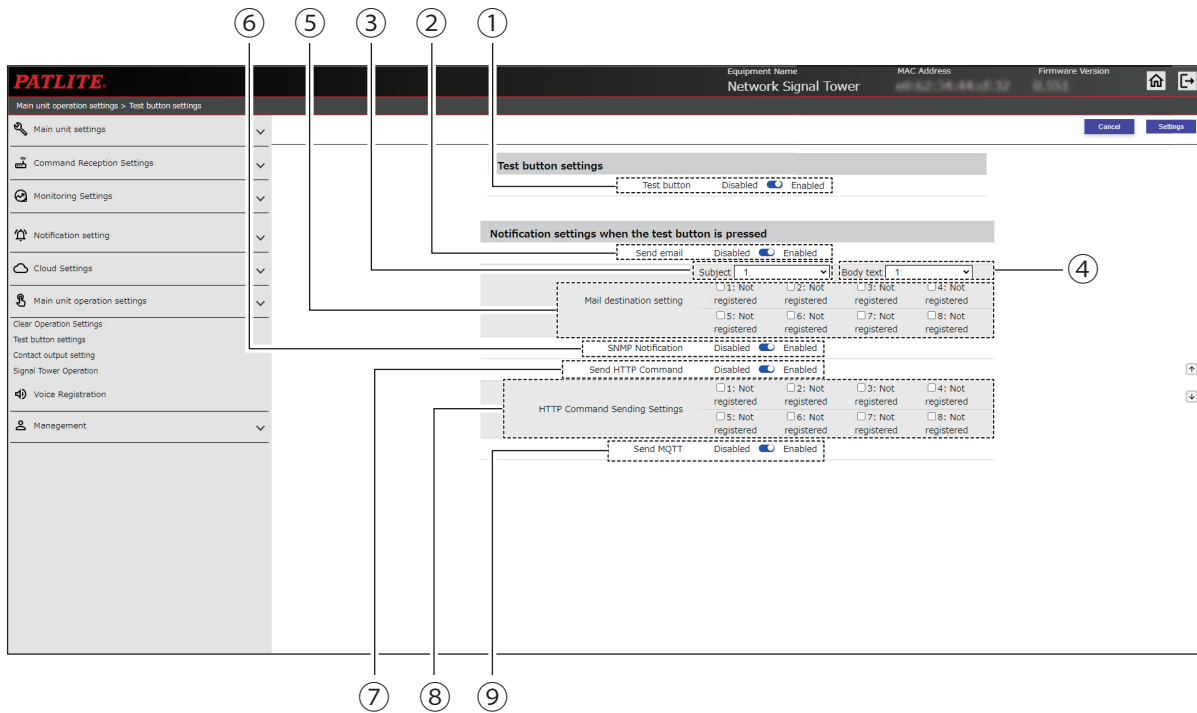

No.	Item	Default Value	Input Range	Description	Setting ( ● : Yes –: No)			
					NHB Series	NHV Series		
						(empty)	M Model	D Model
①	Test button	Enabled	Enabled / Disabled	Select either [Enabled] or [Disabled] for the Test button.	●	●	●	●
②	Send email	Disabled	Enabled / Disabled	Set to [Enabled] or [Disabled] Send email.	●	●	●	●
③	Subject	1	1 to 17	Select a subject for the email.	●	●	●	●
④	Body text	1	1 to 17	Select the body text of the email.	●	●	●	●
⑤	Mail destination setting	(Not selected)	–	Select the email recipient.	●	●	●	●
⑥	SNMP Notification	Disabled	Enabled / Disabled	Set to [Enabled] or [Disabled] SNMP notification.	●	●	●	●
⑦	Send HTTP Command	Disabled	Enabled / Disabled	Set to [Enabled] or [Disabled] Send HTTP Command.	●	●	●	●
⑧	HTTP Command Sending Settings	(Not selected)	–	Select a HTTP Command.	●	●	●	●
⑨	Send MQTT	Disabled	Enabled / Disabled	Set to [Enabled] or [Disabled] Send MQTT.	●	●	●	●

### 9.6.3. Contact Output Setting NHV Series (D model)

Set output settings for the contact output. Using this screen, you can set up and switch between [Digital output] and [Busy output].

! CAUTION

⚠ When changing the contact from [Digital output] to [Busy output], or from [Busy output] to [Digital output], the state of the contact is maintained.

The contact output operation starts by either using contact output or executing the clear operation.

Screen when [Digital output] is selected in ③

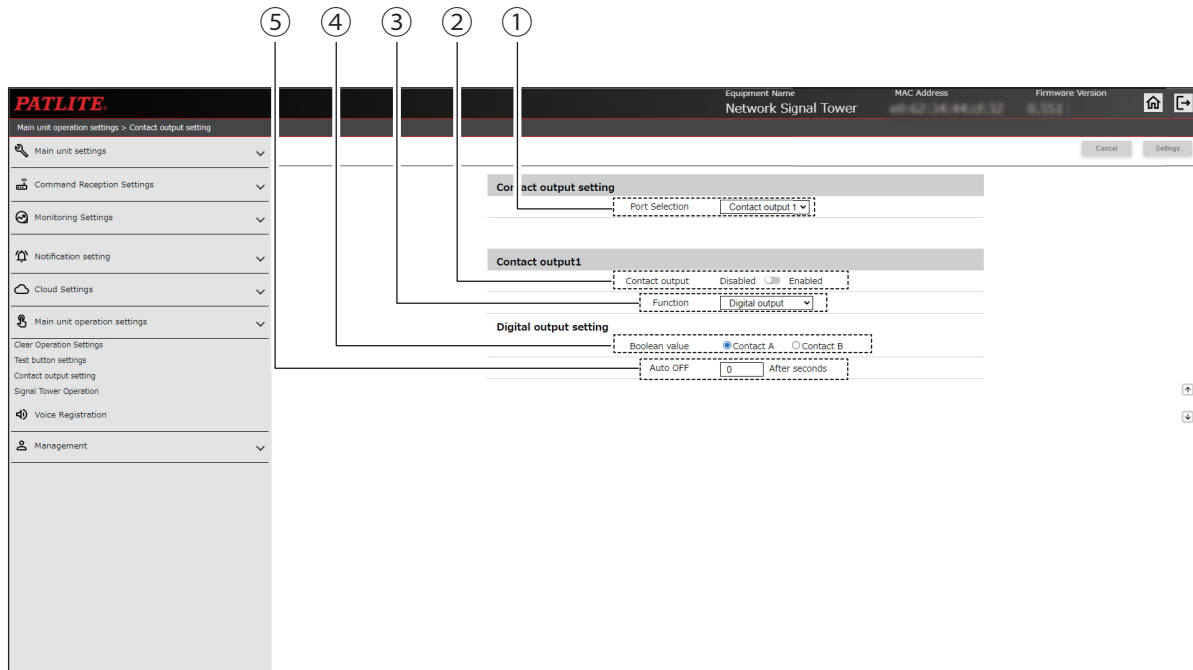

Screen when [Busy output] is selected in ③

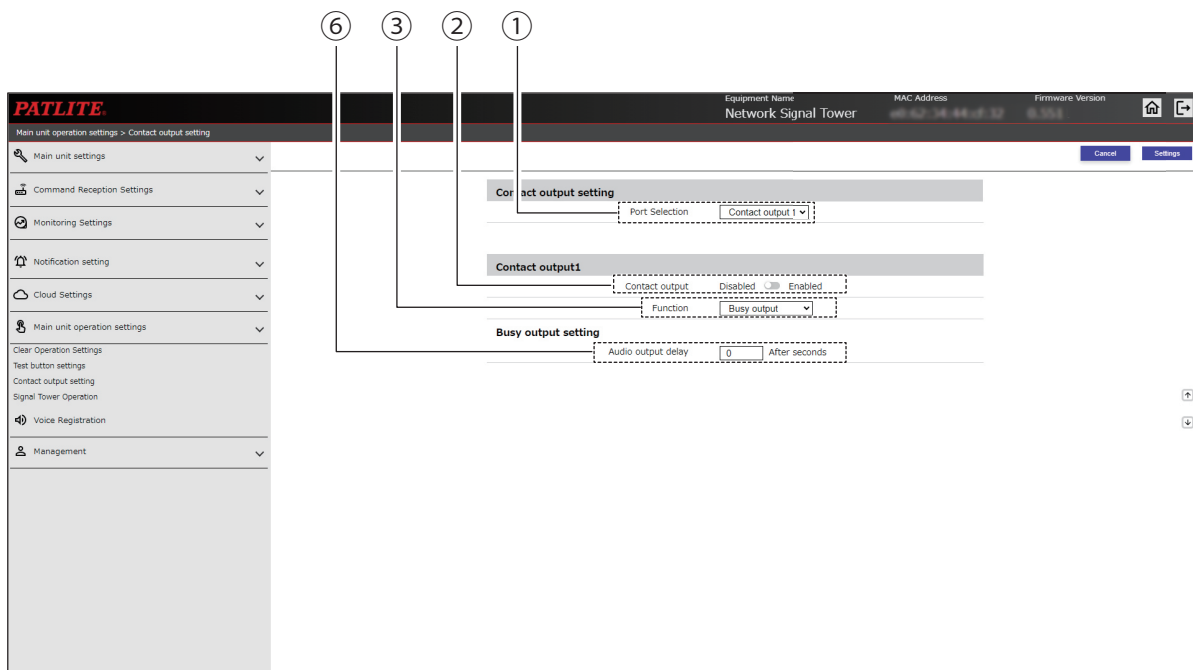

No.	Item	Default Value	Input Range	Description	Setting ( ● : Yes – : No)			
					NHB Series	NHV Series		
						(empty)	<input type="checkbox"/> Model	<input type="checkbox"/> Model
①	Port Selection	Contact output 1	Contact output 1 / Contact output 2	Select the contact output to set.	–	–	–	●
②	Contact output	Disabled	Enabled / Disabled	Select to either [Enabled] or [Disabled] the contact output.	–	–	–	●
③	Function	Digital output	Digital output / Busy output	Select either [Digital output] or [Busy output] for the contact output function. In [Port Selection], when [Contact output 2] is specified, this is fixed to [Digital output].	–	–	–	●
④	Boolean value	Contact A	Contact A / Contact B	Select the [Boolean value] as either [Contact A] or [Contact B].	–	–	–	●
⑤	Auto OFF	0	0 to 600	Enter the time for the [Auto OFF] function.	–	–	–	●
⑥	Audio output delay	0	0 to 10	Enter the delay time for Busy output.	–	–	–	●

### 9.6.4. Signal Tower Operation

You can operate the Signal Tower lights from the Web Setup Screen.

In Basic Setup Screen, from [Additional units] the [Not use] option is selected

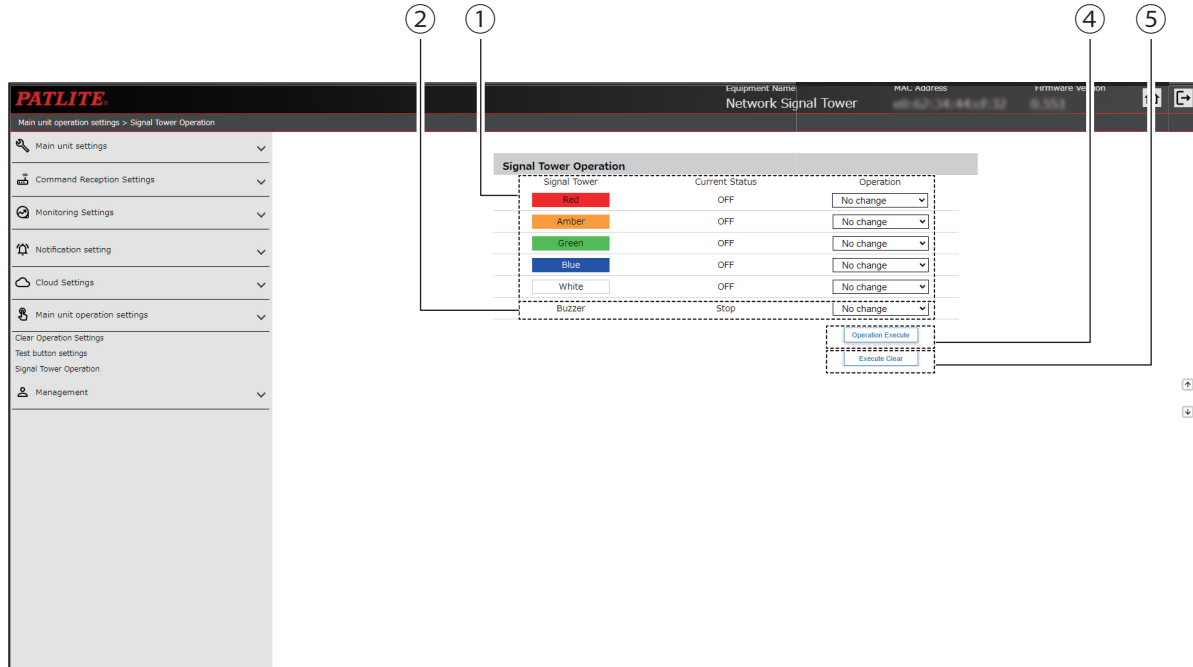

In Basic Setup Screen, from [Additional units] the [Multi-color unit] option is selected

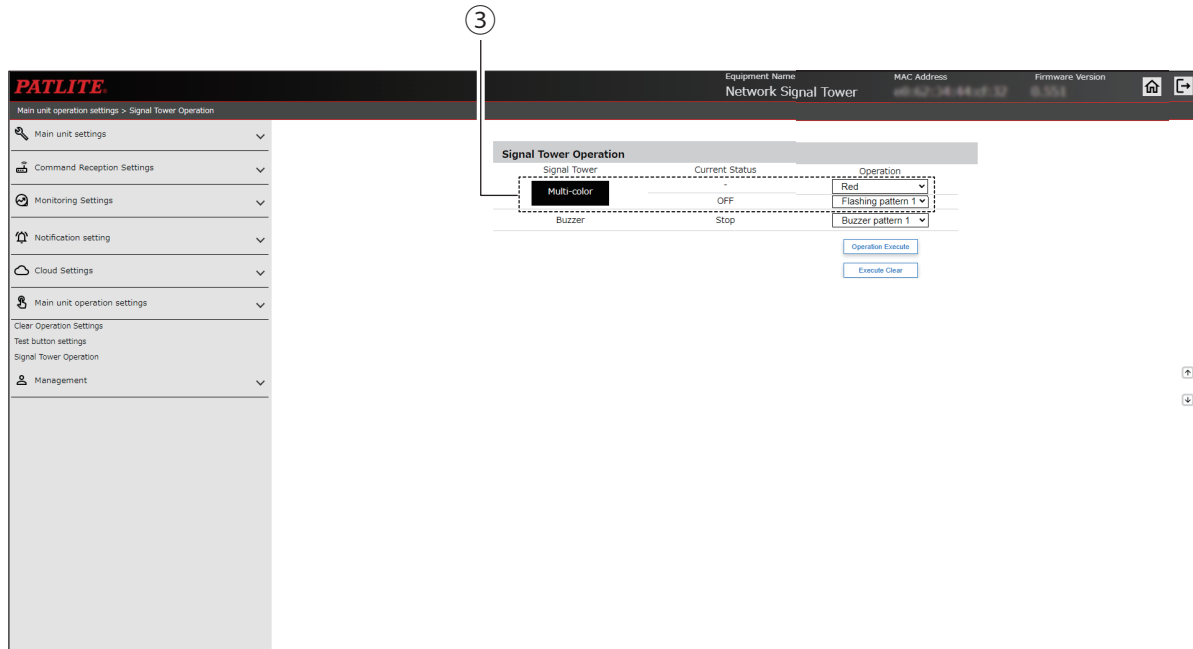

No.	Item	Default Value	Input Range	Description	Setting ( ● : Yes –: No)			
					NHB Series	NHV Series		
						(empty)	<input type="checkbox"/> Model	<input type="checkbox"/> Model
①	Red, Amber, Green, Blue, White	No change	OFF / Continuous ON / Flashing pattern 1 / Flashing pattern 2 / Flashing pattern 3 / Flashing pattern 4 / No change	Specifies the lighting pattern of LED units.	●	●	●	●
②	Buzzer	No change	Stop / Buzzer pattern 1 / Buzzer pattern 2 / Buzzer pattern 3 / Buzzer pattern 4 / Buzzer pattern 5 / No change	Specifies the buzzer pattern.	●	–	–	–
③	Multi color	Red	Red / Amber / Green / Blue / White / Purple / Light blue	Specifies the colors of the multi-color unit.	●	●	●	●
		OFF	OFF / Continuous ON / Flashing pattern 1 / Flashing pattern 2 / Flashing pattern 3 / Flashing pattern 4	Specifies the lighting pattern of the multi-color unit.	●	●	●	●
④	Operation Execute	–	–	Signal Tower lights up using the specified color and pattern.	●	●	●	●
⑤	Execute Clear	–	–	Signal Tower enters normal operating state.	●	●	●	●

## 9.7. Voice Registration NHV Series

- You can register MP3 files and titles to channels played by this product.
- You can use the voice synthesizer function to register audio to a channel. For confirmation, you can playback registered audio on this screen.

### Screen when [Voice] is selected in ④

⑥ ⑤ ④ ③ ② ① ⑦ ⑧ ⑨ ⑩ ⑪

**PATLITE** Network Signal Tower

Equipment Name: Network Signal Tower

MAC Address: [REDACTED]

Voice Registration

Registered channels: 1

Audio Title: [REDACTED]

Area in Use: 0KB / 40960KB (use 0.00%)

Audio Type:  Voice  MP3 Data

Text: Enter

Language: Japanese

Voice: Female

Tone: 0

Speed: 0

Audio Playback: [Listen to Sample] [Add to Channel List]

Channel list

Channel: CH 1 ~ CH 60

CH	Title	LineOut	Play	Stop	Delete
CH 1		<input checked="" type="checkbox"/>	-	-	-
CH 2		<input checked="" type="checkbox"/>	-	-	-
CH 3		<input checked="" type="checkbox"/>	-	-	-
CH 4		<input checked="" type="checkbox"/>	-	-	-
CH 5		<input checked="" type="checkbox"/>	-	-	-
CH 6		<input checked="" type="checkbox"/>	-	-	-
CH 7		<input checked="" type="checkbox"/>	-	-	-

⑬ ⑭ ⑮ ⑯ ⑰ ⑱

### Screen when [MP3 Data] is selected in ④

④ ③ ② ①

**PATLITE** Network Signal Tower

Equipment Name: Network Signal Tower

MAC Address: [REDACTED]

MP3 Data

File selection: [REDACTED] Reference

Channel list

Channel: Preset

CH	Title	LineOut	Play	Stop	Delete
CH 61	Buzzer pattern 1	<input type="checkbox"/>	Play	Stop	-
CH 62	Buzzer pattern 2	<input type="checkbox"/>	Play	Stop	-
CH 63	Buzzer pattern 3	<input type="checkbox"/>	Play	Stop	-
CH 64	Buzzer pattern 4	<input type="checkbox"/>	Play	Stop	-
CH 65	Chime 1	<input type="checkbox"/>	Play	Stop	-
CH 66	Chime 2	<input type="checkbox"/>	Play	Stop	-
CH 67	Chime 3	<input type="checkbox"/>	Play	Stop	-

Refer to the above

No.	Item	Default Value	Input Range	Description	Setting ( ● : Yes – : No)			
					NHB Series	NHV Series		
						(empty)	<input type="checkbox"/> M Model	<input type="checkbox"/> D Model
①	Registered channels	1	1 to 60	Select the channel to set.	–	●	●	●
②	Audio Title	(Blank)	128 single-byte or double-byte characters	Enter a title for the channel.	–	●	●	●
③	Area in Use	–	–	Displays the total capacity and percentage used by registered audio data.	–	●	●	●
④	Audio Type	Voice	Voice / MP3 Data	Select either [Voice] or [MP3 Data] for registered audio.	–	●	●	●
⑤	Text	(Blank)	200 single-byte or double-byte characters	Enter the text to convert to audio data.	–	●	●	●
⑥	Language	Japanese	Japanese / English	Select either [Japanese] or [English] for the playback language.	–	●	●	●
⑦	Voice	Female	Male / Female	Select either [Male] or [Female] for the voice used in playback.	–	●	●	●
⑧	Tone	0	-5 to 5	Set the tone of the audio playback.	–	●	●	●
⑨	Speed	0	-5 to 5	Set the speed of the audio playback.	–	●	●	●
⑩	Audio Playback*1	–	–	Play audio with the current settings.	–	●	●	●
⑪	Add to Channel List	–	–	Using the current settings, generates audio data and adds it to the channel list.	–	●	●	●
⑫	Channel	ch1~ch60	ch1~ch60 / Preset	Select the channels to display, either [ch1~ch60] or [Preset].	–	●	●	●
⑬	CH	–	–	Displays the channel number.	–	●	●	●
⑭	Title	(Blank)	128 characters	Displays the audio title of registered audio data. You can change the title of registered audio data.	–	●	●	●
⑮	LineOut	Disabled	Enabled / Disabled	Select to either [Enabled] or [Disabled] output to LineOut of registered audio.	–	●	●	●
⑯	Play*2 *3 *4 *5	–	–	Plays registered audio data.	–	●	●	●
⑰	Stop*2	–	–	Stops playing the registered audio data.	–	●	●	●
⑱	Delete*2	–	–	Deletes the registered audio data.	–	●	●	●

\*1 If there is no text, audio does not play.

\*2 If there is no audio data registered to the channel, the buttons do not display.

\*3 During audio playback, when LineOut and Busy output are enabled, they operate as per their settings. Even if connected devices are operating, check that there are no problems.

\*4 Running audio playback interrupts playback of the current channel.

\*5 When [Audio Playback Mode] is set to [Memory playback mode], if there is an event while audio from this screen is playing, only after audio playback is complete will audio for the event be played.



## 9.8. Management

### 9.8.1. Settings Initialization

You can initialize settings on this product.

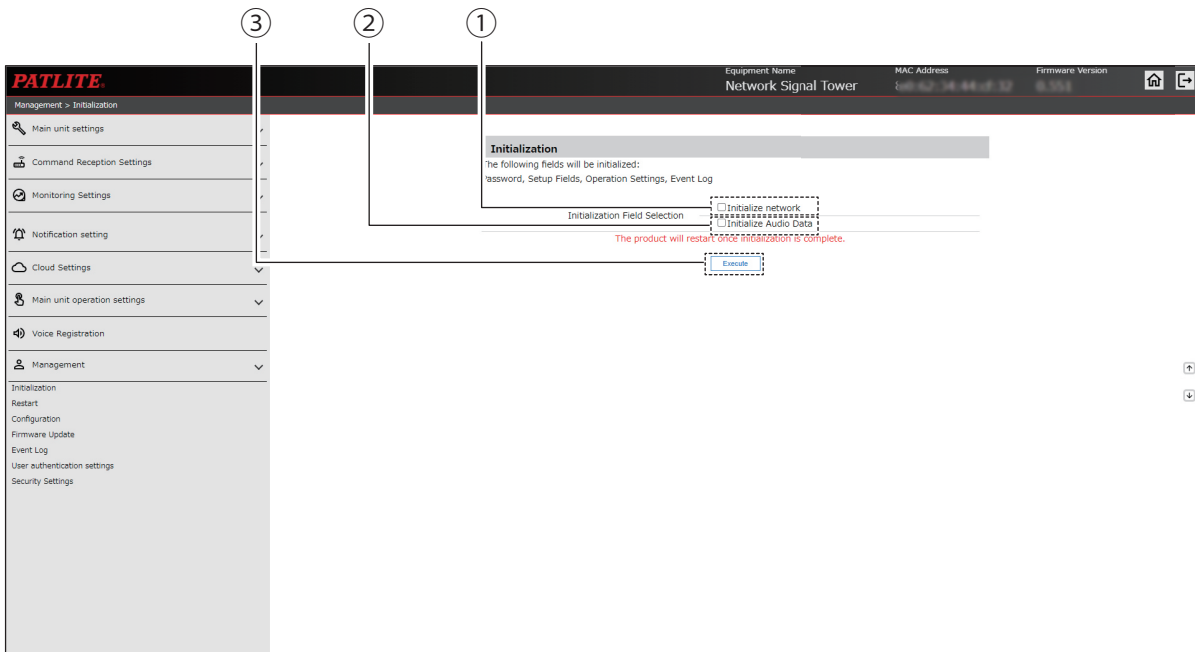

No.	Item	Default Value	Input Range	Description	Setting ( ● : Yes – : No)			
					NHB Series	NHV Series		
						(empty)	M Model	D Model
①	Initialize network*2	–	–	When initialization is performed, also initializes network settings*1.	●	●	●	●
②	Initialize Audio Data*3	–	–	When initialization is performed, also initializes audio data.	–	●	●	●
③	Execute	–	–	Executes initialization.	●	●	●	●

\*1 [Network settings] refer to items in the network settings screen, such as [IP address], [Subnet mask], [Prefix length], [Default gateway], [DNS server address], and [Host name].

\*2 When [Initialize network] is selected, the IP address is reset to the factory default. To use it again, you need to reconfigure the network.

\*3 Even if [Initialize Audio Data] is selected, the preset channels are not deleted.

### 9.8.2. Restart

You can restart this product.

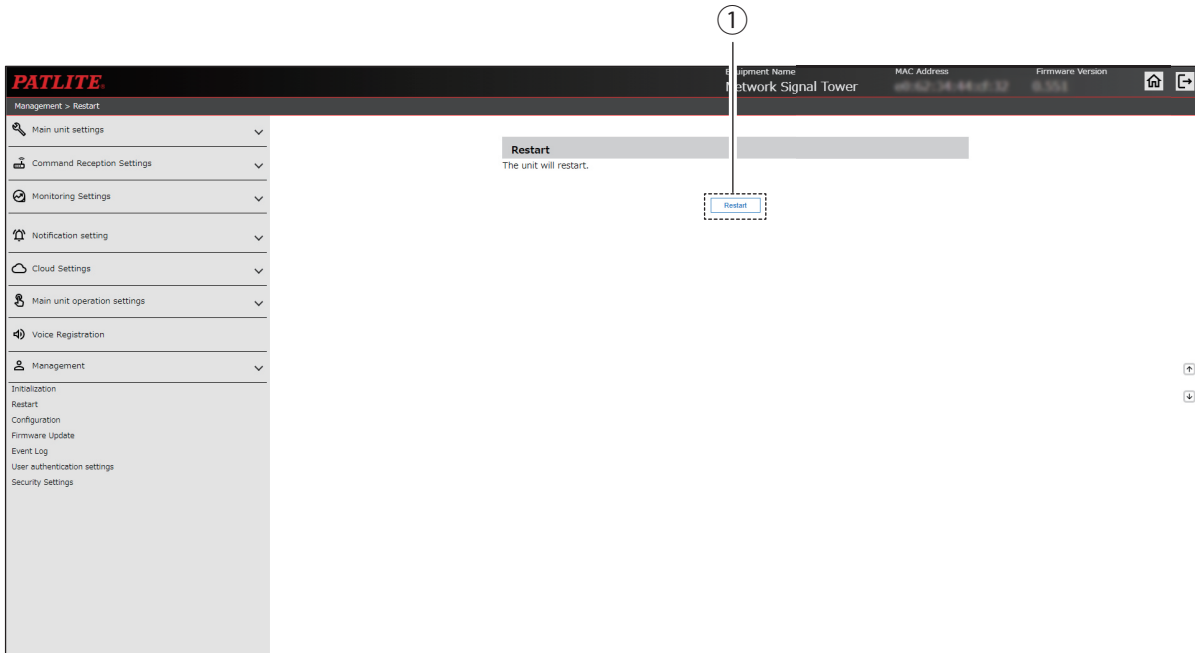

No.	Item	Default Value	Input Range	Description	Setting ( ● : Yes – : No)			
					NHB Series	NHV Series		
						(empty)	M Model	D Model
①	Restart	–	–	Restarts this product.	●	●	●	●

### 9.8.3. Configuration

- You can extract the product settings and save them to your computer as configuration data.
- Select configuration data extracted from the product for writing.

**⚠ CAUTION**

⚠ The configuration data consists of operation settings registered in the main unit.

⚠ The configuration data does not include network settings or authentication passwords.

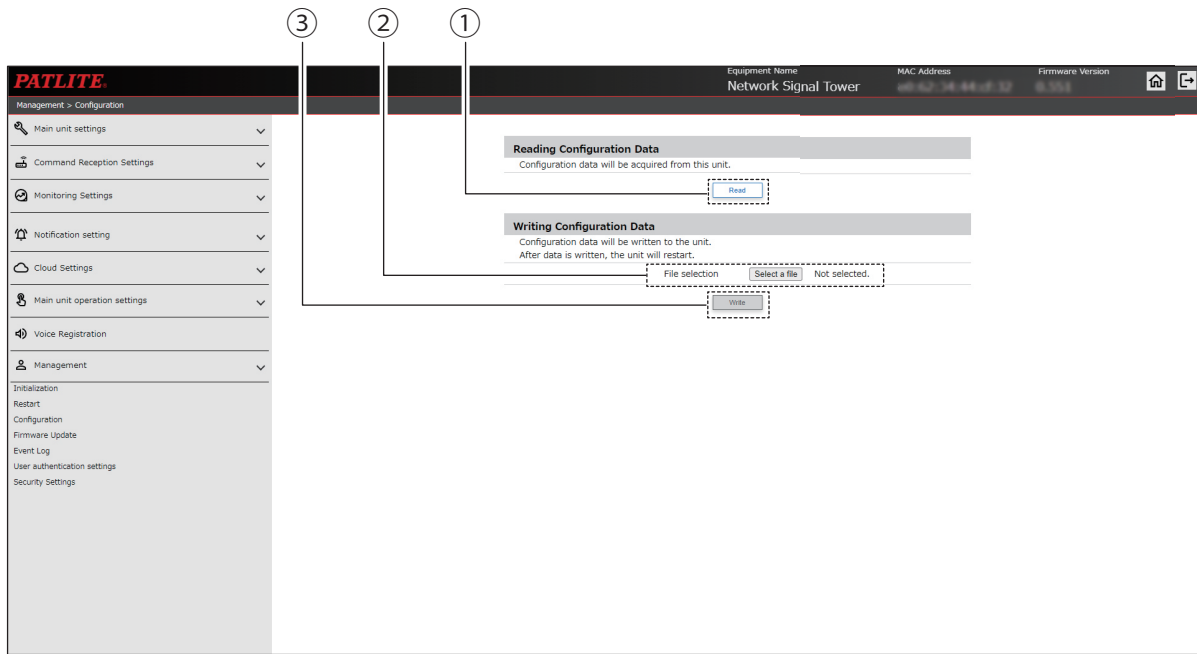

No.	Item	Default Value	Input Range	Description	Setting ( ● : Yes –: No)			
					NHB Series	NHV Series		
						(empty)	M Model	D Model
①	Read	–	–	Read out configuration data from the product.	●	●	●	●
②	File selection	–	–	Select the configuration data stored on the computer.	●	●	●	●
③	Write	–	–	Write contents of the selected configuration data to the product.	●	●	●	●

### 9.8.4. Updating Firmware

You can update the firmware on this product.

**CAUTION**

- ⊘ While updating, do not disconnect the power or LAN cables. Failure to follow this instruction could result in product damage.
- ❗ Before updating, check the version and models supported by the firmware.  
Performing an update when an unsupported firmware is selected could result in equipment damage.

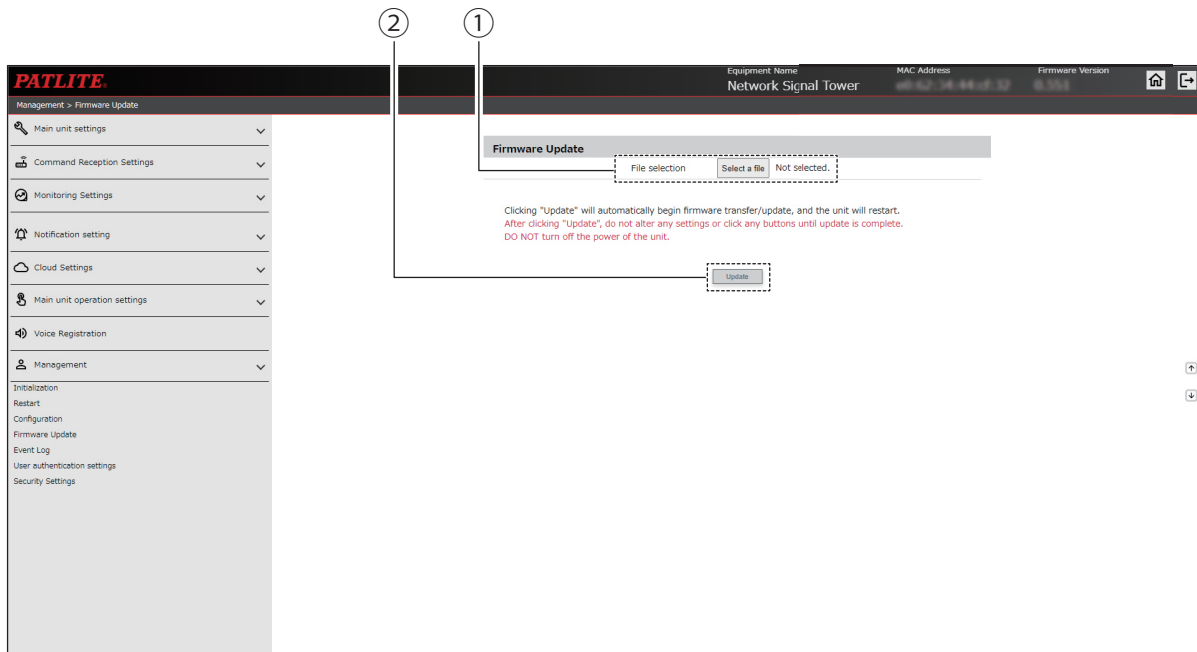

No.	Item	Default Value	Input Range	Description	Setting ( ● : Yes – : No)			
					NHB Series	NHV Series		
						(empty)	M Model	D Model
①	File selection	–	Select File	Select the firmware to write to this product.	●	●	●	●
②	Execute	–	Button	Execute update.	●	●	●	●

### 9.8.5. Event Log

- Displays the product’s event log.
- The event log displays the most recent 100 events.
- You can click [Download] to download the event log file.
- You can download up to 1000 events from the event log.

## ⚠ CAUTION

⚠ The event log is erased when initialization is executed from the [Initialization] screen.

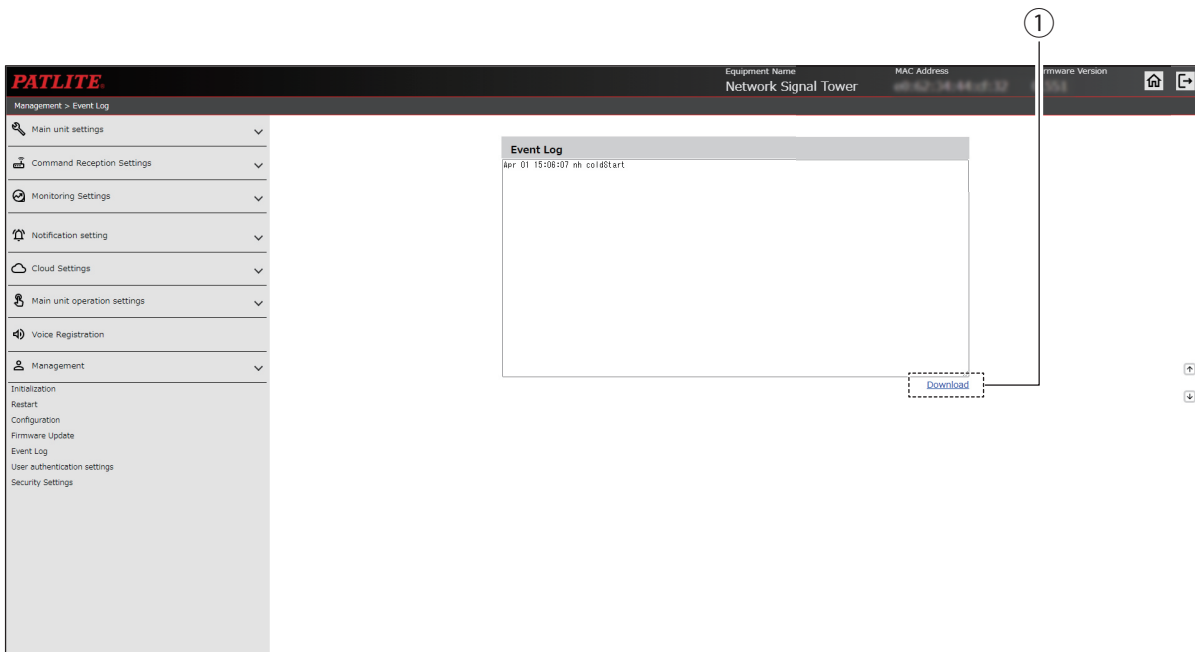

No.	Item	Default Value	Input Range	Description	Setting ( ● : Yes – : No)			
					NHB Series	NHV Series		
						(empty)	M Model	D Model
①	Download	–	–	Download the event log.	●	●	●	●

### 9.8.6. User Authentication Settings

- You can set the User Name and Password required for logging in to this product.
- The set password is enabled the next time you log in.

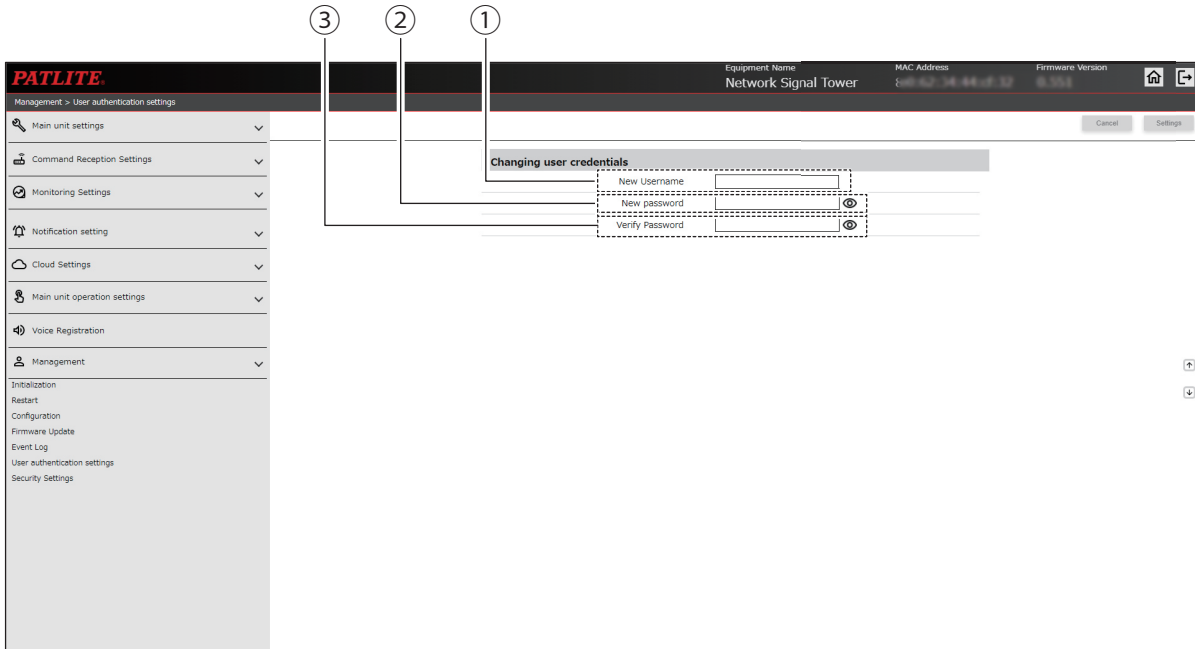

No.	Item	Default Value	Input Range	Description	Setting ( ● : Yes –: No)			
					NHB Series	NHV Series		
						(empty)	M Model	D Model
①	New Username	(Blank)	16 characters	Set the new user name.	●	●	●	●
②	New password	(Blank)	16 characters	Set a new password.	●	●	●	●
③	Verify Password	(Blank)	16 characters	Set the new password (for confirmation).	●	●	●	●

### 9.8.7. Security Settings

- You can select the protocol used for communication with the product’s Web Setup Screen.
- You can set the amount of time before you are automatically logged out when there is no operation.

**⚠ CAUTION**

⚠ If you select https communication, when you access the Web Setup Screen or display a pop-up, sometimes an error screen with a message such as "This site is not secure" or "This connection does not protect privacy" will appear. When the error screen is displayed, in the browser click the [Details] link, then click [Go to Web page] to access the Web Setup Screen. (The displayed text differs depending on your browser and browser version.)

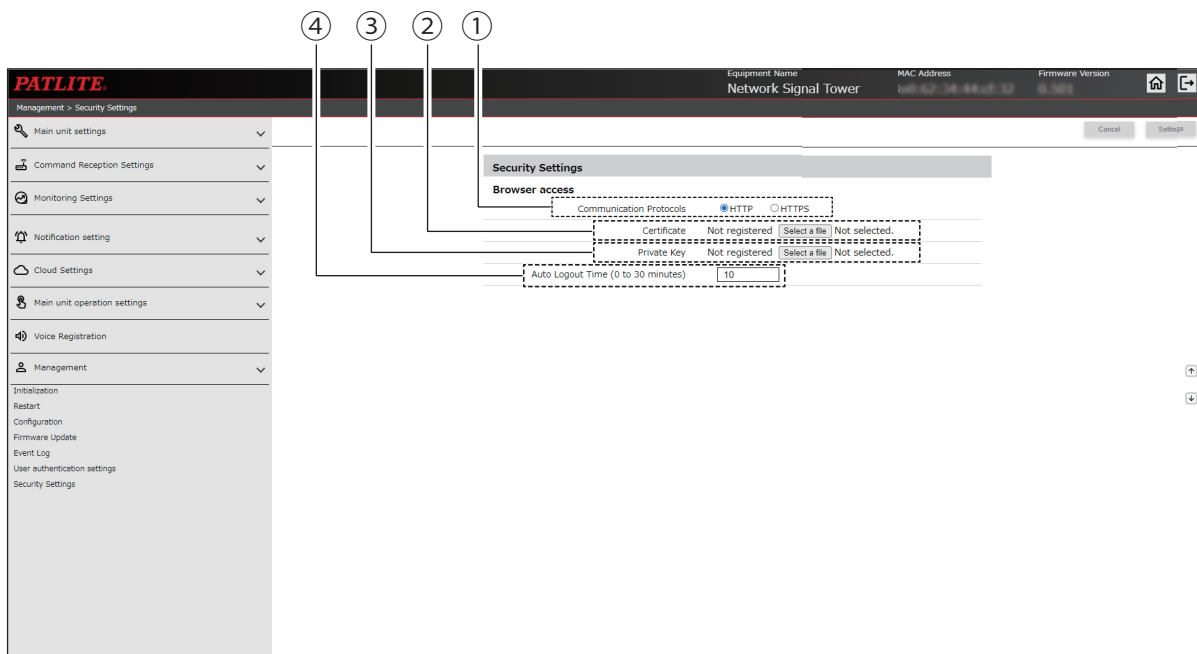

No.	Item	Default Value	Input Range	Description	Setting ( ● : Yes –: No)			
					NHB Series	NHV Series		
						(empty)	M Model	D Model
①	Communication Protocols	HTTP	HTTP / HTTPS	Select either [HTTP] or [HTTPS] for the communication protocol.	●	●	●	●
②	Certificate	–	–	Uploads the certificate which is used in communicating via HTTPS.	●	●	●	●
③	Private Key	–	–	Uploads the private key which is used in communicating via HTTPS.	●	●	●	●
④	Auto Logout Time	10	0 to 30	Set the time before you are automatically logged out. When "0" is specified, you are not automatically logged out.	●	●	●	●

# 10. MIB List

- This product has a dedicated MIB.
- This product is compatible with the NH series MIB, so you can use this product without changing existing designs.

## 10.1. NHB Series

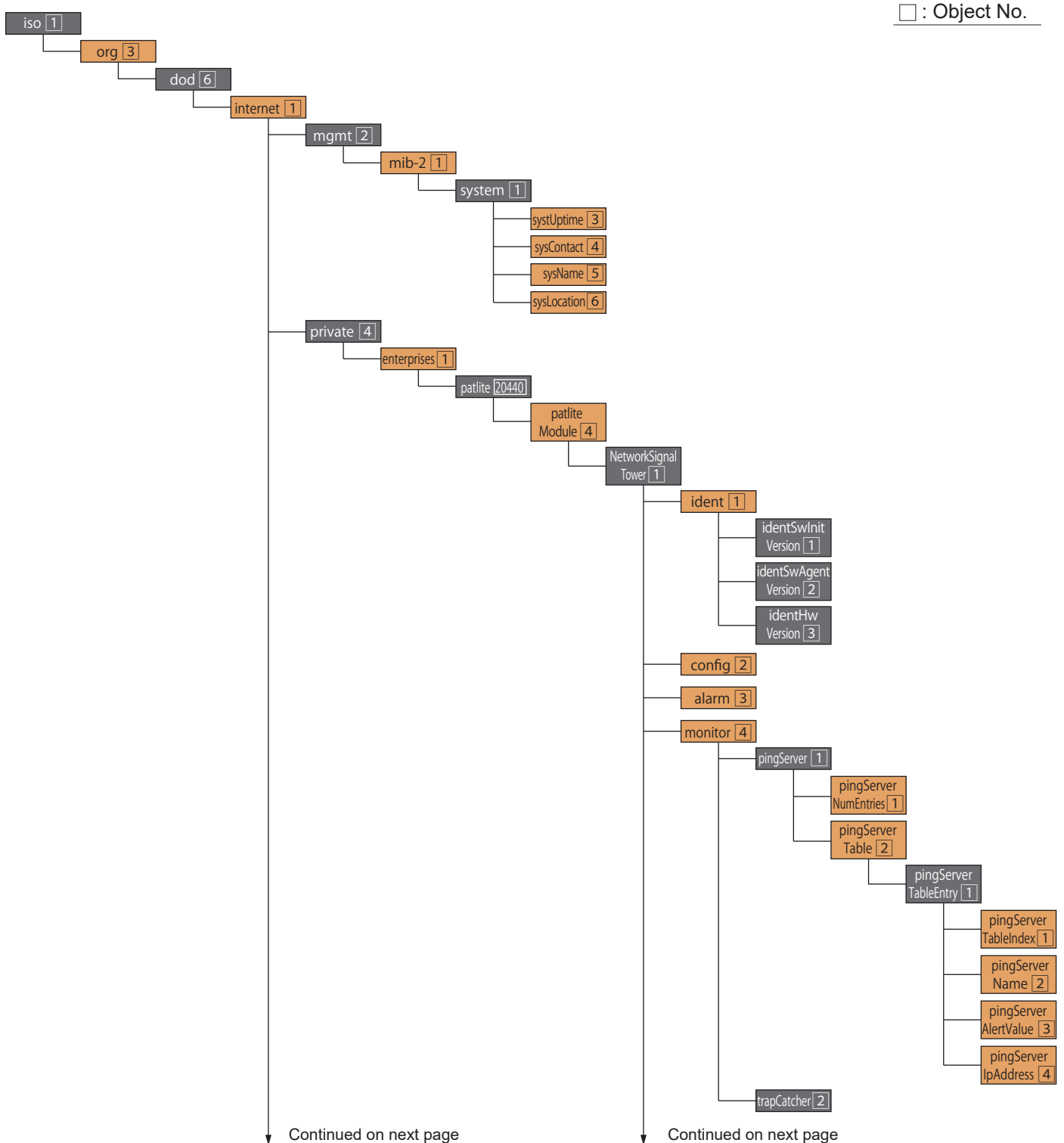



□ : Object No.

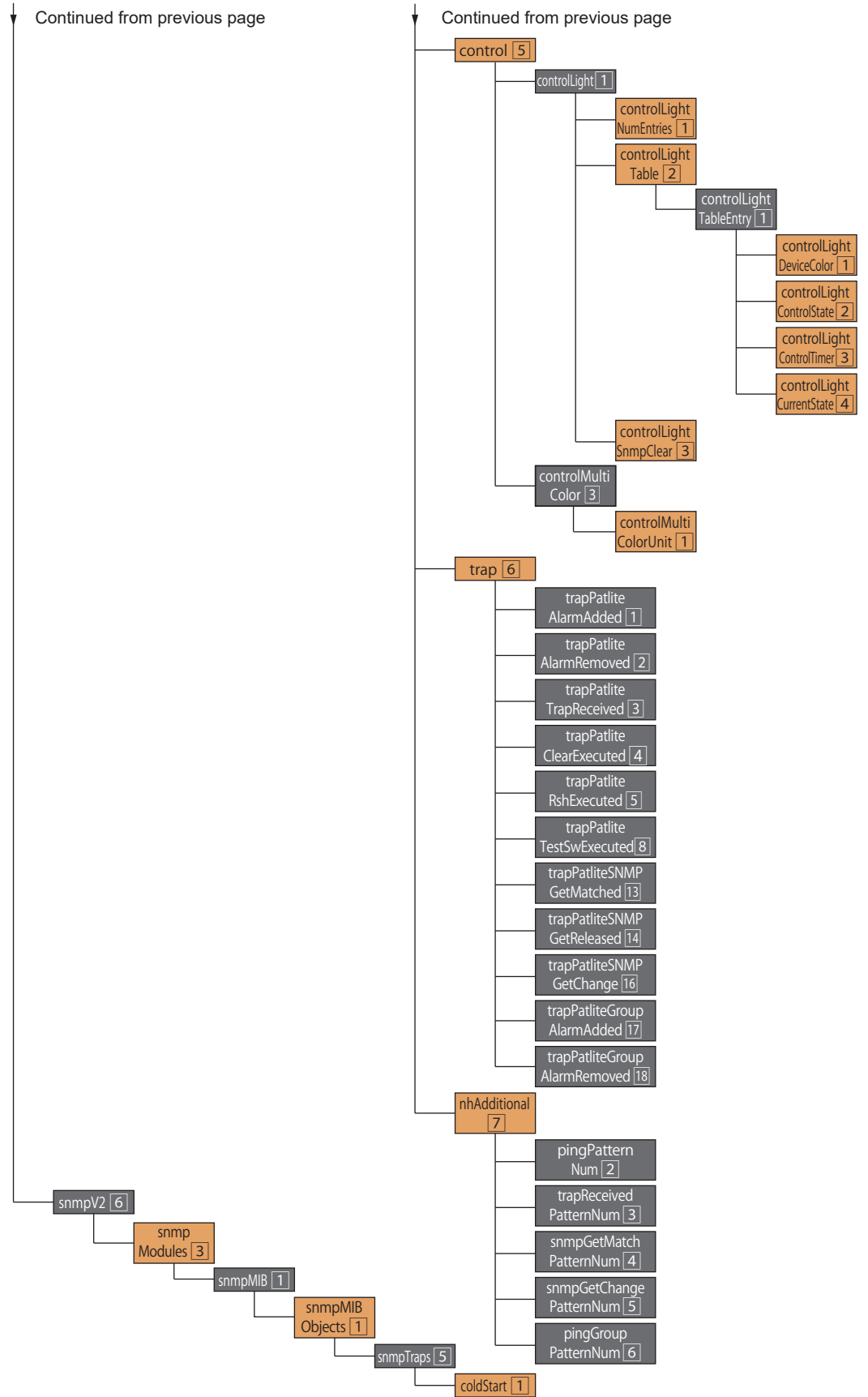

## 10.2. NHV Series

□ : Object No.

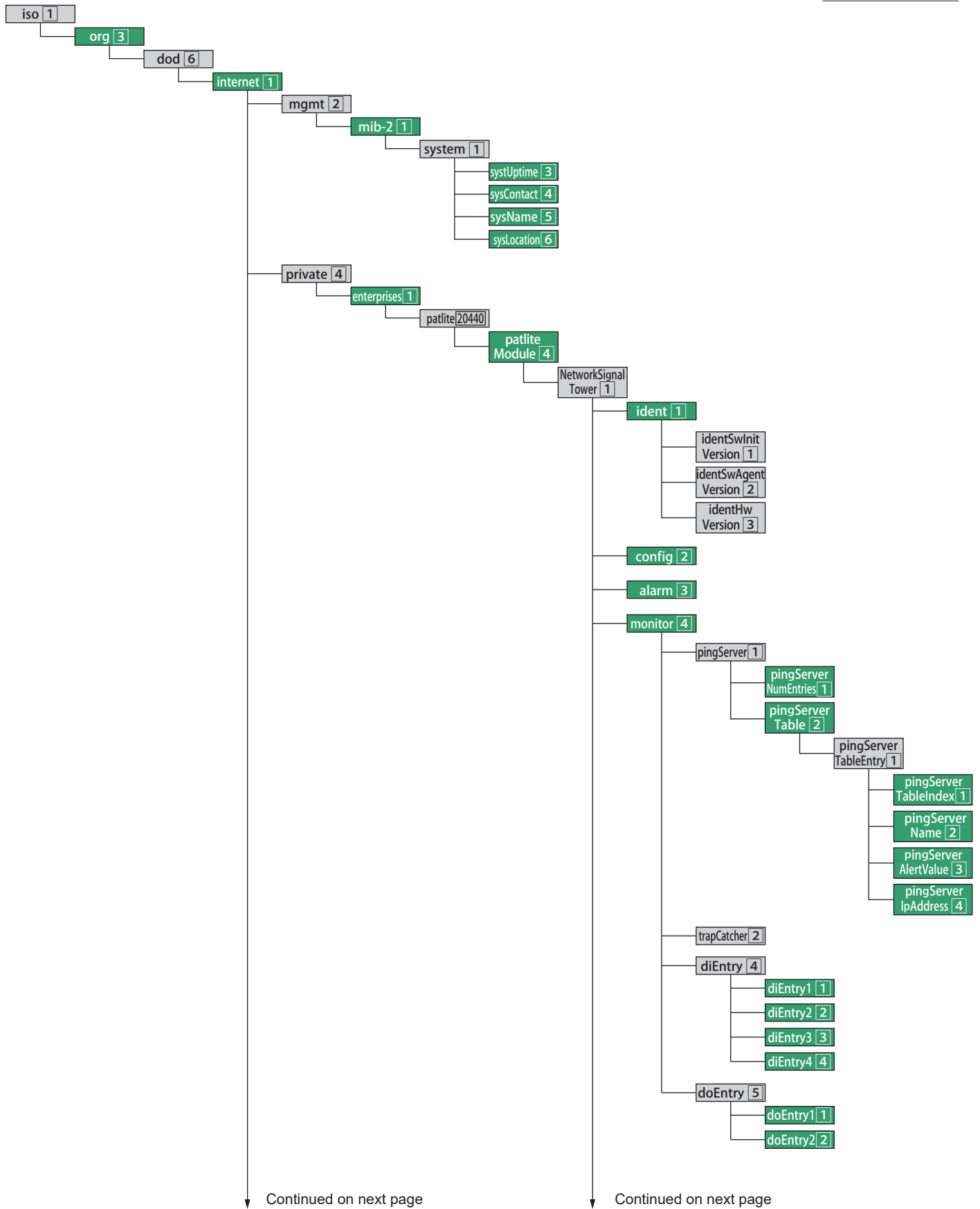

□ : Object No.

Continued from previous page

Continued from previous page

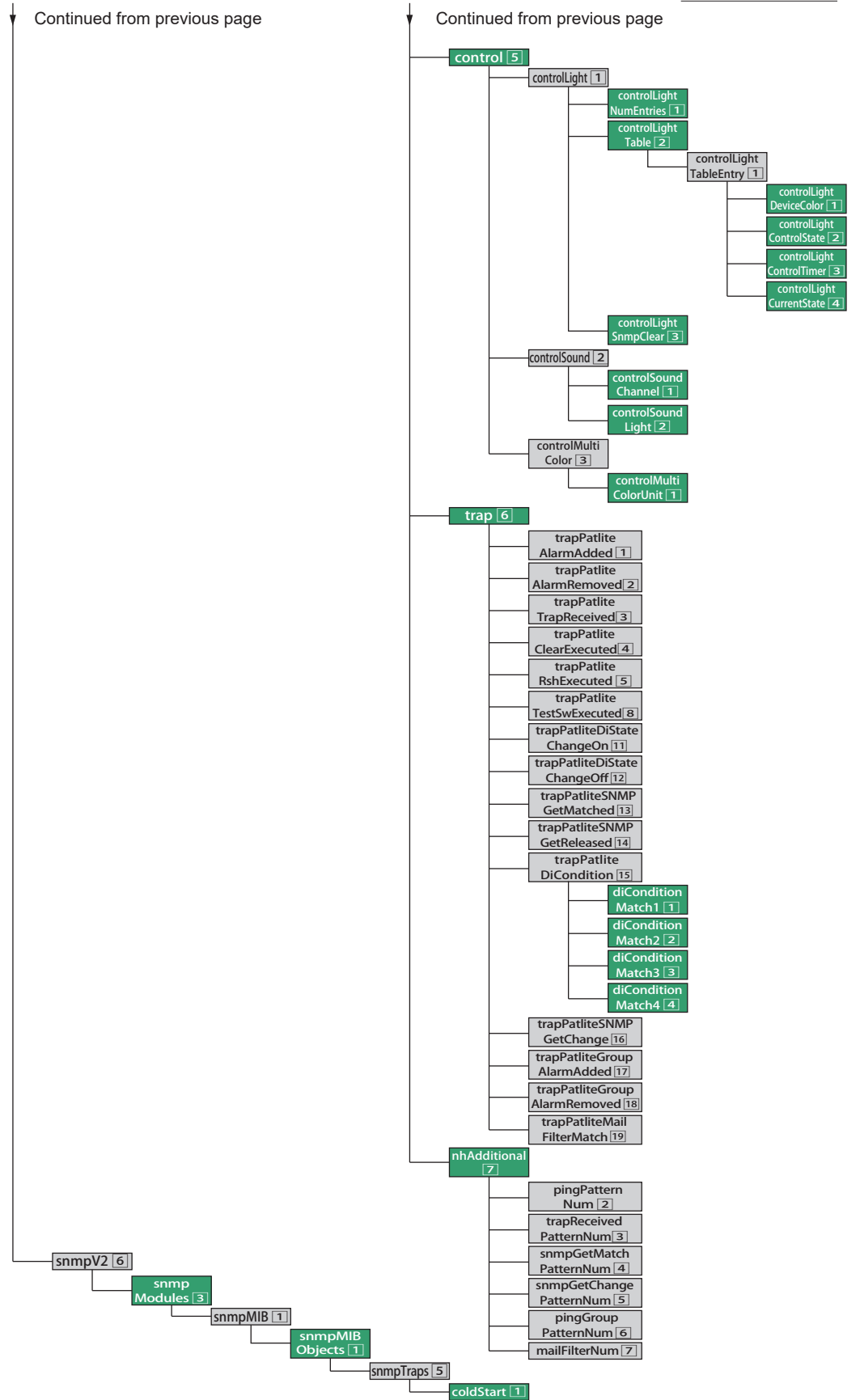

## 10.3. MIB Description

Item No.	OID	Item Name	Type	MAX-ACCESS	Description
1	1.3.6.1.2.1.1.3	sysUptime	TimeTicks	read-only	Time that has elapsed (in hundredths of a second) since the SNMP management system was restarted
2	1.3.6.1.2.1.1.4	sysContact	DisplayString (SIZE (0..255))	read-only	Main unit settings - Basic Settings Contact Information
3	1.3.6.1.2.1.1.5	sysName	DisplayString (SIZE (0..255))	read-only	Main unit settings - Network Settings Host Name Information
4	1.3.6.1.2.1.1.6	sysLocation	DisplayString (SIZE (0..255))	read-only	Main unit settings - Basic Settings Installation Location Information
5	1.3.6.1.4.1.20440.4.1.1.1	identSwInitVersion	OCTET-STRING(2)	read-only	Operating System Version Information
6	1.3.6.1.4.1.20440.4.1.1.2	identSwAgentVersion	OCTET-STRING(3)	read-only	Application Version Information
7	1.3.6.1.4.1.20440.4.1.1.3	identHwVersion	OCTET-STRING(3)	read-only	Hardware Version Information
8	1.3.6.1.4.1.20440.4.1.4.1.1	pingServerNumEntries	INTEGER{0..24}	read-only	Number of Ping Monitoring
9	1.3.6.1.4.1.20440.4.1.4.1.2.1.1	pingServerTableIndex	INTEGER{0..24}	read-only	Setting Number for Ping Monitoring
10	1.3.6.1.4.1.20440.4.1.4.1.2.1.2	pingServerName	OCTET-STRING(31)	read-only	Unit name for Ping Monitoring
11	1.3.6.1.4.1.20440.4.1.4.1.2.1.3	pingServerAlertValue	INTEGER{normal(1), occurred(2)}	read-only	State of Ping Monitoring: Normal (1) / Ping Monitoring Error (2)
12	1.3.6.1.4.1.20440.4.1.4.1.2.1.4	pingServerIpAddress	OCTET-STRING(63)	read-only	IP Address for Ping Monitoring
13	1.3.6.1.4.1.20440.4.1.4.4.1	diEntry1	INTEGER {off(0),on(1)}	read-only	State of Digital Input 1: OFF (0) / ON (1)
14	1.3.6.1.4.1.20440.4.1.4.4.2	diEntry2	INTEGER {off(0),on(1)}	read-only	State of Digital Input 2: OFF (0) / ON (1)
15	1.3.6.1.4.1.20440.4.1.4.4.3	diEntry3	INTEGER {off(0),on(1)}	read-only	State of Digital Input 3: OFF (0) / ON (1)
16	1.3.6.1.4.1.20440.4.1.4.4.4	diEntry4	INTEGER {off(0),on(1)}	read-only	State of Digital Input 4: OFF (0) / ON (1)
17	1.3.6.1.4.1.20440.4.1.4.5.1	doEntry1	INTEGER {off(0),on(1)}	read-write	State of Digital output1: OFF (0) / ON (1)
18	1.3.6.1.4.1.20440.4.1.4.5.2	doEntry2	INTEGER {off(0),on(1)}	read-write	State of Digital output2: OFF (0) / ON (1)
19	1.3.6.1.4.1.20440.4.1.5.1.1	controlLightNumEntries	INTEGER {6}	read-only	Number of Signal Tower to Control
20	1.3.6.1.4.1.20440.4.1.5.1.2.1.1	controlLightDeviceColor	INTEGER{red(1), amber(2), green(3), blue(4), white(5), buzzer(6)}	read-only	Values of Signal Tower Color Information: Red (1) / Amber (2) / Green (3) / Blue (4) / White (5) / Buzzer (6)
21	1.3.6.1.4.1.20440.4.1.5.1.2.1.2 (.index)*	controlLightControlState	INTEGER{1..7}	read-write	State of Signal Tower Lights to Control: <ul style="list-style-type: none"> <li>• Color State: Light off (1) / Light on (2) / Flashing 1 (3) / No change (4) / Flashing 2 (5) / Flashing 3 (6) / Flashing 4 (7) /</li> <li>• Buzzer: Buzzer stop (1) / Buzzer pattern 1 (2) / Buzzer pattern 2 (3) / No change (4) / Buzzer pattern 3 (5) / Buzzer pattern 4 (6) / Buzzer pattern 5 (7)</li> <li>• Audio Playback: Stop Playback (1) / Channel 61 Playback (2) / Channel 62 Playback (3) / No change (4) / Channel 63 Playback (5) / Channel 64 Playback (6) / Channel 71 Playback (7)</li> </ul>

Item No	OID	Item Name	Type	MAX-ACCESS	Description
22	1.3.6.1.4.1.20440.4.1.5.1.2.1.3 (.index)*	controlLightControlTimer	INTEGER {-1..99}	read-write	Number of seconds until control state is reflected: Disable control reflect (-1) / Time until control is reflected (0 to 99 seconds)
23	1.3.6.1.4.1.20440.4.1.5.1.2.1.4 (.index)*	controlLightCurrentState	INTEGER{1..6}	read-only	Current State of Signal Tower Lights: <ul style="list-style-type: none"> <li>• Color State: Light off (1) / Light on (2) / Flashing 1 (3) / Flashing 2 (4) / Flashing 3 (5) / Flashing 4 (6) /</li> <li>• Buzzer: Buzzer stop (1) / Buzzer pattern 1 (2) / Buzzer pattern 2 (3) / Buzzer pattern 3 (4) / Buzzer pattern 4 (5) / Buzzer pattern 5 (6)</li> <li>• Audio Playback: Stop Playback (1) / Channel 61 Playback (2) / Channel 62 Playback (3) / Channel 63 Playback (4) / Channel 64 Playback (5) / Channel 71 Playback (6)</li> </ul>
24	1.3.6.1.4.1.20440.4.1.5.1.3	controlLightSnmpClear	INTEGER {nop(0),execute(1)}	read-write	Clear Control Status: Do Not Clear (0) / Execute Clear (1)
25	1.3.6.1.4.1.20440.4.1.5.2.1	controlSoundChannel	INTEGER{0..71}	read-write	Control Audio Channel, Current Status: Playback Stopped (0) / Playback Channel Number (1 to 71)
26	1.3.6.1.4.1.20440.4.1.5.2.2	controlSoundLight	OCTET-STRING (SIZE (12))	read-write	Control state of Signal Tower lights with 12-digit numbers: <ul style="list-style-type: none"> <li>• Color state: 1st to 5th digits - Light off (0) / Light on (1) / Flashing 1 (2) / Flashing 2 (3) / Flashing 3 (4) / Flashing 4 (5) / No change (9)</li> <li>• Audio Playback: 6th digit - Stop (0) / Playback (1)</li> <li>• Number of times to repeat audio: 7th to 9th digits - One-shot playback (000) / Number of Times to Repeat (001 to 254) / Endless Playback (255)</li> <li>• Audio Playback Channel: 10th to 12th digits - Playback Channel (001 to 071)</li> </ul>
27	1.3.6.1.4.1.20440.4.1.5.3.1	controlMultiColorUnit	OCTET-STRING (SIZE(2))	read-write	Control state of Multi-color unit with 2-digit numbers: <ul style="list-style-type: none"> <li>• Color: 1st digit - Red (1) / Amber (2) / Green (3) / Blue (4) / White (5) / Purple (6) / Light blue (7)</li> <li>• Lighting pattern: 2nd digit - Light off (0) / Light on (1) / Flashing 1 (2) / Flashing 2 (3) / Flashing 3 (4) / Flashing 4 (5)</li> </ul>
28	1.3.6.1.4.1.20440.4.1.6.1	trapPatliteAlarmAdded	OBJECT-IDENTIFIER	not-accessible	Indicates an error in the monitoring target that was specified in the Ping Monitoring Settings.
29	1.3.6.1.4.1.20440.4.1.6.2	trapPatliteAlarmRemoved	OBJECT-IDENTIFIER	not-accessible	Indicates the monitoring target specified by the Ping Monitoring Settings has recovered from the problem.
30	1.3.6.1.4.1.20440.4.1.6.3	trapPatliteTrapReceived	OBJECT-IDENTIFIER	not-accessible	Indicates that the TRAP specified in the TRAP Reception Settings has been received.
31	1.3.6.1.4.1.20440.4.1.6.4	trapPatliteClearExecuted	OBJECT-IDENTIFIER	not-accessible	Indicates the Clear button has been pressed.
32	1.3.6.1.4.1.20440.4.1.6.5	trapPatliteRshExecuted	OBJECT-IDENTIFIER	not-accessible	Indicates the RSH/SSH Command has been received.
33	1.3.6.1.4.1.20440.4.1.6.8	trapPatliteTestSwExecuted	OBJECT-IDENTIFIER	not-accessible	Indicates the Test button has been pressed.
34	1.3.6.1.4.1.20440.4.1.6.11	trapPatliteDiStateChangeOn	OBJECT-IDENTIFIER	not-accessible	Indicates digital input has been turned on.

Item No	OID	Item Name	Type	MAX-ACCESS	Description
35	1.3.6.1.4.1.20440.4.1.6.12	trapPatliteDiStateChangeOff	OBJECT-IDENTIFIER	not-accessible	Indicates digital input has been turned off.
36	1.3.6.1.4.1.20440.4.1.6.13	trapPatliteSNMPGetMatched	OBJECT-IDENTIFIER	not-accessible	Indicates the SNMP monitoring condition has been met.
37	1.3.6.1.4.1.20440.4.1.6.14	trapPatliteSNMPGetReleased	OBJECT-IDENTIFIER	not-accessible	Indicates the SNMP monitoring condition has been released.
38	1.3.6.1.4.1.20440.4.1.6.15.1	diConditionMatch1	OBJECT-IDENTIFIER	not-accessible	Indicates the condition specified in Digital Input Condition Setting 1 has been met.
39	1.3.6.1.4.1.20440.4.1.6.15.2	diConditionMatch2	OBJECT-IDENTIFIER	not-accessible	Indicates the condition specified in Digital Input Condition Setting 2 has been met.
40	1.3.6.1.4.1.20440.4.1.6.15.3	diConditionMatch3	OBJECT-IDENTIFIER	not-accessible	Indicates the condition specified in Digital Input Condition Setting 3 has been met.
41	1.3.6.1.4.1.20440.4.1.6.15.4	diConditionMatch4	OBJECT-IDENTIFIER	not-accessible	Indicates the condition specified in Digital Input Condition Setting 4 has been met.
42	1.3.6.1.4.1.20440.4.1.6.16	trapPatliteSNMPGetChange	OBJECT-IDENTIFIER	not-accessible	Indicates SNMP monitoring has detected a change.
43	1.3.6.1.4.1.20440.4.1.6.17	trapPatliteGroupAlarmAdded	OBJECT-IDENTIFIER	not-accessible	Indicates an error in the monitoring target group that was specified in the Ping Monitoring Settings - Group setting.
44	1.3.6.1.4.1.20440.4.1.6.18	trapPatliteGroupAlarmRemoved	OBJECT-IDENTIFIER	not-accessible	Indicates the monitoring target group specified by the Ping Monitoring Settings - Group setting has recovered from the problem.
45	1.3.6.1.4.1.20440.4.1.6.19	rapPatliteMailFilterMatch	OBJECT-IDENTIFIER	not-accessible	Indicates email has been detected.
46	1.3.6.1.4.1.20440.4.1.7.2	pingPatternNum	INTEGER{1..24}	not-accessible	Indicates the ping monitoring target number. (1 to 24)
47	1.3.6.1.4.1.20440.4.1.7.3	trapReceivedPatternNum	INTEGER{1..16}	not-accessible	Indicates the TRAP Reception Setting number of the TRAP that was received. (1 to 16)
48	1.3.6.1.4.1.20440.4.1.7.4	snmpGetMatchPatternNum	INTEGER{1..20}	not-accessible	Indicates the SNMP monitoring (match detection) target's monitoring setting number. (1 to 20)
49	1.3.6.1.4.1.20440.4.1.7.5	snmpGetChangePatternNum	INTEGER{1..5}	not-accessible	Indicates the SNMP monitoring (change detection) target's monitoring setting number. (1 to 5)
50	1.3.6.1.4.1.20440.4.1.7.6	pingGroupPatternNum	INTEGER{1..3}	not-accessible	Indicates the ping group monitoring target number. (1 to 3)
51	1.3.6.1.4.1.20440.4.1.7.7	mailFilterNum	INTEGER{1..20}	not-accessible	Indicates the email detection number.
52	1.3.6.1.6.3.1.1.5.1	coldStart	OBJECT-IDENTIFIER	not-accessible	Starts up this product.

\* The value to operate the Signal Tower or buzzer is entered into the (index).

Red (1) / Yellow (2) / Green (3) / Blue (4) / White (5) / Buzzer (6)

# 11. Specifications

## 11.1. NHB Series

Model		5 tier	4 tier	3 tier	2 tier	1 tier	0 tier
		NHB □ -5 □	NHB □ -4 □	NHB □ -3 □	NHB □ -2 □	NHB □ -1 □	NHB □ -0 □
Rated Voltage	DC Power Jack	24 VDC					
	AC Adapter accessory* <sup>1</sup>	Input: 100 to 240 VAC (50Hz/60Hz), Output: 24 VDC					
Operating Voltage Range	DC Power Jack	21.6 to 26.4 VDC					
	AC Adapter accessory* <sup>1</sup>	90 to 264 VAC					
Rated Current Consumption	Main Unit* <sup>2</sup>	Standby: 110mA Maximum: 155mA (24VDC input)					
	Signal Tower	40mA (per Unit)					
Rated Power Consumption	Main Unit* <sup>2</sup>	Standby: 3.2W Maximum: 4.4W (with AC Adaptor, 100VAC input)					
	Signal Tower	1.0W (per Unit, with AC Adaptor, 100VAC input)					
Ambient Operating Temperature		0°C to 40°C (No Dew or Condensation)					
Ambient Operating Humidity		20% RH to 80% RH (No Dew or Condensation)					
Storage Ambient Temperature		-10°C - 60°C (No Dew or Condensation)					
Storage Ambient Humidity		20% RH to 80% RH (No Dew or Condensation)					
Mounting Location		Indoor Only					
Mounting Direction		Upright					
Protection Rating		IP20					
Insulation Resistance		More than 10Mohm at 500VDC between live part and non-current carrying metallic part					
Withstand Voltage		1500VAC applied for 1min (10mA or less) between live part and non-current carrying metallic part without breaking insulation					
Sound Pressure Level (Buzzer)		80 dB or more (at 25 °C)					
		Environmental Conditions	Front direction from the center, at 1m, Maximum volume setting				
Mass (Tolerance: ± 10%)	NHB6	645g + (60g) x Signal Tower Tiers (AC Adaptor not included)					
	NHB4	635g + (35g) x Signal Tower Tiers (AC Adaptor not included)					
Network Communication Format		Ethernet (IEEE 802.3 compliant) 10BASE-T / 100BASE-TX / 1000BASE-T (Auto MDI/MDI-X compatible)					
		IP Network	IPv4/IPv6 dual stack				
Interface	USB	USB2.0/1.1 Type-A 1ch					

Accessories		AC Adapter*1, Adhesive Sheet	
Compatible Unit (Optional)	NHB6	LED Unit	LR6-E-RZ, RY, RG, RB, C LR6-E-R, Y, G, B, MZ
		Wireless Data Acquisition System Transmitter	WDT-6LR-Z2
	NHB4	LED Unit	LR4-E-RZ, RY, RG, RB, C LR4-E-R, Y, G, B
		Wireless Data Acquisition System Transmitter	WDT-4LR-Z2
Optional Parts		Wall Mounting Bracket	NH-001
		Partition Mounting Bracket	NH-002
		AC Adapter	ADP-001
Remarks		*1 Except <input type="checkbox"/> N model *2 Excluding USB current consumption *3 <input type="checkbox"/> N model only	



## 11.2. NHV Series

Model		5 tier	4 tier	3 tier	2 tier	1 tier	0 tier
		NHV □ -5 □□□	NHV □ -4 □□□	NHV □ -3 □□□	NHV □ -2 □□□	NHV □ -1 □□□	NHV □ -0 □□□
Rated Voltage	DC Power Jack	24 VDC					
	PoE Power Supply*1	48VDC Conforms to IEEE802.3at (PoE+)*2					
	AC Adapter Accessory*3	Input: 100 to 240 VAC (50Hz/60Hz), Output: 24 VDC					
Voltage Operating Range	DC Power Jack	21.6 to 26.4 VDC					
	PoE Power Supply*1	42.5 to 57 VDC					
	AC Adapter Accessory*3	90 to 264 VAC					
Rating Current Consumption	Main Unit*4	Standby: 120mA Maximum: 210mA (24VDC input)					
	Signal Tower	Standby: 115mA Maximum: 175mA (PoE 48VDC input) 40mA (per Unit, 24VDC input) , 25mA (per Unit, PoE 48VDC input)					
Rating Power Consumption	Main Unit*4	Standby: 3.5W Maximum: 6W (AC Adaptor, 100VAC input)					
	Signal Tower	1.0W (per Unit, AC Adaptor, 100VAC input)					
Ambient Operating Temperature		0°C to 40°C (No Dew or Condensation)					
Ambient Operating Humidity		20% RH to 80% RH (No Dew or Condensation)					
Storage Ambient Temperature		-10 °C to 60 °C (No Dew or Condensation)					
Storage Ambient Humidity		20% RH to 80% RH (No Dew or Condensation)					
Mounting Location		Indoor Only					
Mounting Direction		Upright					
Protection Rating		IP20					
Insulation Resistance		More than 10Mohm at 500VDC between live part and non-current carrying metallic part					
Withstand Voltage		1500VAC applied for 1min (10mA or less) between live part and non-current carrying metallic part without breaking insulation					
Sound Pressure Level		88dB or more					
Environmental Conditions		Front direction from the center, at 1m, 1.8kHz sine wave played back at -6dB MP3 data of the content and use of the environment, the sound pressure level will change.					
Audio Line Output		600 Ω 0dBV (Unbalanced, Monaural Mini-Jack)					

Mass (Tolerance: ± 10%)	NHV6	760g + (60g) x Signal Tower Tiers (AC Adaptor not included)	
	NHV4	750g + (35g) x Signal Tower Tiers (AC Adaptor not included)	
	NHV6-D	805g + (60g) x Signal Tower Tiers (AC Adaptor not included)	
	NHV4-D	795g + (35g) x Signal Tower Tiers (AC Adaptor not included)	
	NHV6-DP	850g + (60g) x Signal Tower Tiers	
	NHV4-DP	840g + (35g) x Signal Tower Tiers	
External Contact Output ( <input type="checkbox"/> D model only)		Non-Voltage Contact Relay	
		Number of Contacts	2
		Contact Rating	(30VDC@3A) inrush current 5A or less (5VDC@1mA, Minimum, Reference)
		Supported Wire Diameter	Solid Wire / Stranded Wire: $\varphi$ 0.41 - 0.81mm (AWG26 - 20)
		Wiring Method	Screwless Terminal Block
External Contact Input ( <input type="checkbox"/> D model only)		Non-voltage contact input NPN Transistor	
		Number of Contacts	4
		Contact Rating	"ON" output current @ 6mA or less per channel Terminal OFF condition Voltage: 24VDC
		Supported Wire Diameter	Solid Wire / Stranded Wire: $\varphi$ 0.41 - 0.81mm (AWG26 - 20)
		Wiring Method	Screwless Terminal Block
Network Communication Format		Ethernet (IEEE 802.3 compliant) 10BASE-T / 100BASE-TX / 1000BASE-T (Auto MDI/MDI-X compatible)	
IP Network		IPv4/IPv6 dual stack	
Interface	USB	USB2.0/1.1 Type-A 1ch	
Accessories		AC Adapter* <sup>3</sup> , Adhesive Sheet	
Compatible Unit (Optional)	NHV6	LED Unit	LR6-E-RZ, RY, RG, RB, C LR6-E-R, Y, G, B, MZ
		Wireless Data Acquisition System Transmitter	WDT-6LR-Z2
	NHV4	LED Unit	LR4-E-RZ, RY, RG, RB, C LR4-E-R, Y, G, B
		Wireless Data Acquisition System Transmitter	WDT-4LR-Z2
Optional Parts		Wall Mounting Bracket	NH-001
		Partition Mounting Bracket	NH-002
		AC Adaptor	NH-003

Remarks	*1 <input type="checkbox"/> P model only *2 PoE+ power supply HUB compliant with IEEE802.3at is required. *3 Except for <input type="checkbox"/> N and <input type="checkbox"/> P models *4 Excluding USB current consumption *5 <input type="checkbox"/> N and <input type="checkbox"/> P models only
---------	--

## 12. Troubleshooting

### 12.1. Troubleshooting

#### 12.1.1. Common to NHB and NHV Series

NHB Series

NHV Series

Issue	Check content	Reference
Power does not turn on	Is the power supply applied at the correct voltage? Check that the power supply is applied at the rated voltage.	"6.6. Power Supply Method" (☞ page 89)
	Is the AC adapter connected correctly? Connect the AC adapter properly.	
The adhesive strength of the adhesive sheet has been weakened	Is there dirt or oil on the adhesive sheet? Use a soft cloth, dampened with water and wrung tightly, to wash off the dirt, then dry thoroughly before use.	—
The status LED is flashing Red	Turn off the power on this product then turn the power back on. If this does not solve the problem, please contact the technical support center listed on the website as there may be some sort of failure.	—
Signal Tower lights are bright (blinding)	From [Basic Settings] - [Dimming], adjust the brightness of the Signal Tower.	"7.14. Setting Up LED Unit Brightness Adjustment" (☞ page 112)
Cannot automatically get IP address, does not start in DHCP mode	At startup, if access to the DHCP server is unavailable, this product uses its default value 192.168.10.1 in the network settings. Check if the environment supports connecting to the DHCP server.	—
	Is allocation of IP addresses set to [Manual Settings]? Change the setup method to [Automatic Settings].	"7.1. Enabling DHCP Function" (☞ page 92) "7.5. Setting Up Product Network Settings" (☞ page 100)

Issue	Check content	Reference
The Web Setup Screen does not display or does not display correctly	Is the LAN cable connected? Check that the cable is connected properly.	"6.5. LAN Cable Wiring Method" (☞ page 88)
	Is the IP address for the product correct? Check the IP address of the product.	"7.4. Displaying the Web Setup Screen" (☞ page 97)
	Is the IP address for the product duplicated on other equipment? Check the IP address of the product.	
	Are you accessing the correct the IP address? Check the IP address of the product.	
	Is the IP address on the personal computer correct? Check the personal computer settings.	"7.2. Setting Up Network Settings on the PC" (☞ page 93)
	Check the browser you are using. Use either Google Chrome or Microsoft Edge.	-
	In the browser security settings, is JavaScript disabled? Enable running JavaScript in the browser.	-
	Check operation after deleting the browser history.	-
The event log is not recording	The event log is erased when initialization is run from the Web Setup Screen and when using DIP switches to reset the product to its factory default.	-
Socket communication is not possible	Is the socket communication setting correct? Check if the [Socket Communication Function] is enabled, and check the [Port number] setting.	"8.3.1.1. Setting Up the Command Main Unit Operation Settings" (☞ page 155)
	Is the communication command protocol correct? Check the communication command protocol you are using.	"5.3.11. PNS Command Function (product compatibility commands)" (☞ page 43) "5.3.12. PHN Command Function (product compatibility commands)" (☞ page 52)
	Are you sending to the product address? Check the IP address of the product.	"7.2. Setting Up Network Settings on the PC" (☞ page 93)
	Check the settings of the source equipment and of communication equipment on the transmission route to confirm communication is not blocked by a firewall, filtering, port blocking function, and so on.	-
	When [Sent-from address settings] is enabled, is the specified IP address registered correctly? Register IP addresses of equipment that will transmit commands.	"8.3.1.1. Setting Up the Command Main Unit Operation Settings" (☞ page 155)
Even though I press the Clear button, Signal Tower lights do not turn off	Is the normal operation setting set with any option other than [Light off]? When the lighting color is specified, pressing the Clear button lights up the LED unit in the specified color.	"7.15. Setting Up Normal Status" (☞ page 113)
	In the [Clear Operation Settings], confirm [Clear Signal Tower] is not set to [Disabled].	"8.3.3. Operating the Product with the Clear Button" (☞ page 177)

Issue	Check content	Reference
Unable to control using RSH/SSH Commands	<ul style="list-style-type: none"> <li>• Are the [RSH/SSH Command Reception Settings] correct?</li> <li>• Confirm the [RSH Command Reception Function] or [SSH Command Reception Function] is set to [Enabled].</li> <li>• If key authentication is selected for SSH, confirm the [Source IP address] and [Login name] are set correctly.</li> </ul>	"8.3.1.1. Setting Up the Command Main Unit Operation Settings" (☞ page 155)
	When you send commands without an account, confirm the correct account is registered.	
	Check the settings of the source equipment and of communication equipment on the transmission route to confirm communication is not blocked by a firewall, filtering, port blocking function, and so on.	-
Email notification is not executed	On the mail server, check the authentication method and its settings.	-
	If you use a host name, confirm the [DNS server address] is set.	"7.5. Setting Up Product Network Settings" (☞ page 100)
	<ul style="list-style-type: none"> <li>• Are the operation settings of the function for which you want to send an email notification correct?</li> <li>• Confirm the [Send email] is set to [Enabled].</li> <li>• Confirm the email destination is selected.</li> </ul>	-
Unable to control using HTTP Commands	<ul style="list-style-type: none"> <li>• Confirm the [HTTP Command Control Function] is set to [Enabled].</li> <li>• Are you transmitting using the protocol (HTTP/HTTPS) specified in the security settings?</li> </ul>	"8.3.1.1. Setting Up the Command Main Unit Operation Settings" (☞ page 155)
Unable to SET / GET using SNMP Commands	<ul style="list-style-type: none"> <li>• Are the [SNMP Command-reception Settings] correct?</li> <li>• Check if [SNMP Command-reception Function] is set to [Enabled].</li> <li>• Check if an incorrect SNMP version is specified.</li> <li>• Check if the various settings for the SNMP version are correctly set.</li> </ul>	"8.3.1.1. Setting Up the Command Main Unit Operation Settings" (☞ page 155)
SNMP Device Monitoring does not run	<ul style="list-style-type: none"> <li>• Is the SNMP Device Monitoring Settings correct?</li> <li>• Check if [SNMP Device Monitoring Function] is set to [Enabled].</li> <li>• Check if an incorrect SNMP version is specified.</li> <li>• Check if the various settings for the SNMP version are correctly set.</li> </ul>	"8.3.1.1. Setting Up the Command Main Unit Operation Settings" (☞ page 155)
	Confirm the target monitored address and Judgment conditions are correctly specified.	
	Confirm the monitoring cycle of condition settings that are not executed is not set to 0 seconds.	
Even though power is turned, the status LED does not turn Blue	Confirm the DIP switches are set to normal startup mode (all OFF).	"8.5.1.2. Using Status LED to Check the Status of this Product" (☞ page 221)
Volume buttons do not adjust the volume	In the Web Setup Screen, if [Volume Button] operation is set to [Disabled], the volume does not change even when using volume buttons.	"8.5.4.2. Adjusting the Volume with + / - Volume Control Buttons" (☞ page 227)

Issue	Check content	Reference
Turning on the power does not turn on Signal Tower	Confirm the LED unit is installed properly.	"6.1. Attaching and Detaching Additional Units" (👁 page 76)
LED unit does not work properly with the Cloud function	Check that the cloud connection settings are set correctly.	"8.2. Using the Cloud" (👁 page 128)
	Check if the [Field Name] and [Value] are set correctly.	
	For AWS connections, confirm the client ID is not duplicated with other equipment.	
Cannot connect to [Azure IoT Central]	In the Cloud Connection Settings, verify the [Scope ID], [Device ID], and [SAS Token] are set correctly.	
	Confirm the clock on this product is set correctly.	
Cannot connect to [Azure IoT Hub]	In the Cloud Connection Settings, verify values are not defined for the [Scope ID], [Device ID], and [SAS Token]. All fields must be blank.	
	Check if the connection string for the Cloud Connection Settings is set correctly.	
	Confirm the clock on this product is set correctly.	
Cannot connect to [AWS IoT Core]	Confirm the connection and client ID are set up correctly in the Amazon Web Services Setup Screen.	
	Confirm the Amazon Web Services Setup Screen's Root CA certificate, client certificate, and client private key are uploaded properly.	
	Confirm the certificate and policy are attached to the thing created in the AWS IoT console.	
	Confirm the clock on this product is set correctly.	
Certificate cannot be uploaded	Certificate file name may be too long. Shorten the file name and try uploading again.	

### 12.1.2. NHB Series

**NHB Series**

Issue	Check content	Reference
There is no buzzer sound	Is the [Buzzer] set to [0(OFF)]? Disable [OFF] on the device, or adjust the volume using the speaker volume or the +/- volume buttons on the product.	"7.9. Setting Up the Buzzer" (☞ page 107) "8.5.4. Changing the Sound Volume" (☞ page 226)
The buzzer volume is low	Is the [Buzzer] volume low? Adjust the volume using the speaker volume or the +/- volume buttons on the product.	"7.9. Setting Up the Buzzer" (☞ page 107) "8.5.4. Changing the Sound Volume" (☞ page 226)

### 12.1.3. NHV Series

**NHV Series**

Issue	Check content	Reference
Audio does not play	Is the [Speaker Volume] set to [Mute] or [Minimum]? Disable [Mute] on the device, or adjust the volume using the speaker volume or the +/- volume buttons on the product.	"7.10. Setting Up the Speaker Volume" on page 108 "8.5.4. Changing the Sound Volume" (☞ page 226)
	Confirm the audio is registered to the associated channel in the channel list.	—
The audio volume is low	Is the [Speaker Volume] low? Adjust the volume using the speaker volume or the +/- volume buttons on the product.	"7.10. Setting Up the Speaker Volume" on page 108 "8.5.4. Changing the Sound Volume" (☞ page 226)
Audio playback does not output to Line Out	Check if the MP3 file sound is monaural. When the file is stereo, the R channel of the MP3 file registered to the channel is output.	—
	Confirm Line Out in the channel list is set to [Enabled].	"7.16. Setting Up Voice Registration" (☞ page 114)
Line Out outputs sound on one side only	Line Out is a mono channel, so if you connect a stereo mini-plug, it plays on the L channel of line out.	—
Even though an event occurs, does not change from buzzer pattern 1 to 5 (in Memory playback mode)	Playback mode for the following channels is fixed to Repeat playback (endless): Channels 61 to 64 (buzzer patterns 1 to 4) and Channel 71 (buzzer pattern 5). To change to another channel, use a command or switch operation to stop the audio playback, and then specify a channel to play or skip a track.	—
Failed to upload MP3 file	The MP3 file was created in an unsupported format. The following formats are supported by this product. MPEG1 AudioLayer3 CBR 32, 64, 128 kbps	—



**12.1.4. NHV-DP Series****NHV Series (D model)****NHV Series (P model)**

Issue	Check content	Reference
Power does not turn on	Is the product connected to the PoE power supply? Connect the product to the PoE power supply.	—
Digital output and various transmissions do not run under the condition set in the digital input condition.	Check if there is a conflict in conditions. [Digital Input Condition Settings] are processed in order, starting from setting 1, and operations for settings processed later have priority.	—
	Set as the condition, is digital input set to [Disabled]? Set the digital input to [Enabled].	"8.4.4. Contact Input Status Monitoring" (☞ page 205)
Even though the Clear button is pressed, the relay contact output does not turn off	When the [Relay Contact Output] setting is set to [Busy output], while the channel is playing the relay contact output remains ON. When channel playback stops, the relay contact output turns OFF. You cannot turn it off using any variety of commands.	—
Digital output function does not operate as controlled by the relay contact	In the contact output setting, check if the contact output is set to [Enabled], or if the target port is set to the digital output.	"8.1.4. Setting Up Contact Output Settings" (☞ page 127)
	Check if there is a state change in a short period of time (within 100 ms). The output terminal block reflects the digital output state in 100 ms cycles. The state of digital output is updated as required in the order of received control elements (priority given to the last received control element). As a result, if the digital output state changes within 100 ms, only a part of the state change is reflected in the output terminal block. * The various command and email transmissions are reflected in the control content order.	—
	If a large amount of processing occurs in other functions, or if processing takes a long time, output terminal block operations may be delayed.	—
	Check if Digital Output Setting is set to [Auto OFF].	"8.1.4. Setting Up Contact Output Settings" (☞ page 127)
	There may be a problem with the contact. Contact the distributor from whom you purchased this product, or the technical support center listed on the website. Check that the rated current and inrush current of equipment connected to the terminal block do not exceed the ratings of the output terminal block.	—
Digital input does not work	Is the contact input setting correct? Check if [Contact Input] is set to [Enabled].	"8.4.4. Contact Input Status Monitoring" (☞ page 205)
	Check the input terminal block for cut or disconnected wires, short circuit, and so on.	—
	Check if the input signal is being transmitted properly to the input terminal block. The input signal must have a duration of 110 ms or longer.	—

Issue	Check content	Reference
Device-to-cloud Message does not notify there are changes to digital input.	Check the signal definition in the digital input settings. Notification is sent for changes to the defined content.	"8.2. Using the Cloud" (👉 page 128)
MQTT Publish function does not notify changes in digital input	Check the signal definition in the digital input settings. Notification is sent for changes to the defined content.	

## 13. Replacement and Optional Parts

### 13.1. Replacement Parts



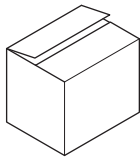
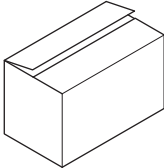
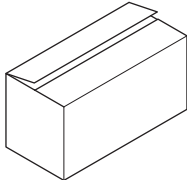

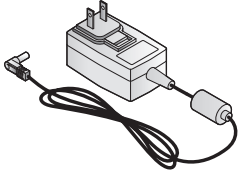
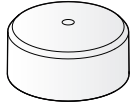
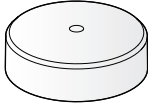
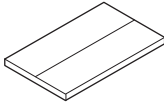

Various parts are available to the customer for exchange or replacement.

Individual Box		
Tier 0, 1 Signal Tower	Tier 2, 3 Signal Tower	Tier 4, 5 Signal Tower
		

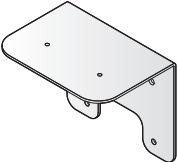
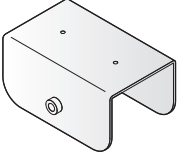
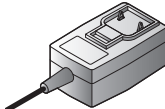
AC Adapter	Head Cover		Adhesive Sheet
	φ 40, off-White	φ 60, off-White	
			

### 13.2. Optional Parts

The following options are available for this product.

Wall Mounting Bracket	Partition Mounting Bracket	Global AC adapter					
NH-001	NH-002	ADP-001					
							
			UL	CCC	VDE	KC	UK

## 14. Free Software License Agreement

This chapter clarifies the license for the free software used with NHB and NHV Series.

### 14.1. GNU GENERAL PUBLIC LICENSE

#### 14.1.1. Version 1.0

#### **GNU GENERAL PUBLIC LICENSE Version 1, February 1989**

Copyright (C) 1989 Free Software Foundation, Inc.  
51 Franklin St, Fifth Floor, Boston, MA 02110-1301 USA

Everyone is permitted to copy and distribute verbatim copies of this license document, but changing it is not allowed.

#### **Preamble**

The license agreements of most software companies try to keep users at the mercy of those companies. By contrast, our General Public License is intended to guarantee your freedom to share and change free software--to make sure the software is free for all its users. The General Public License applies to the Free Software Foundation's software and to any other program whose authors commit to using it. You can use it for your programs, too.

When we speak of free software, we are referring to freedom, not price. Specifically, the General Public License is designed to make sure that you have the freedom to give away or sell copies of free software, that you receive source code or can get it if you want it, that you can change the software or use pieces of it in new free programs; and that you know you can do these things.

To protect your rights, we need to make restrictions that forbid anyone to deny you these rights or to ask you to surrender the rights. These restrictions translate to certain responsibilities for you if you distribute copies of the software, or if you modify it.

For example, if you distribute copies of a such a program, whether gratis or for a fee, you must give the recipients all the rights that you have. You must make sure that they, too, receive or can get the source code. And you must tell them their rights.

We protect your rights with two steps: (1) copyright the software, and (2) offer you this license which gives you legal permission to copy, distribute and/or modify the software.

Also, for each author's protection and ours, we want to make certain that everyone understands that there is no warranty for this free software. If the software is modified by someone else and passed on, we want its recipients to know that what they have is not the original, so that any problems introduced by others will not reflect on the original authors' reputations.

The precise terms and conditions for copying, distribution and modification follow.

## **GNU GENERAL PUBLIC LICENSE TERMS AND CONDITIONS FOR COPYING, DISTRIBUTION AND MODIFICATION**

0. This License Agreement applies to any program or other work which contains a notice placed by the copyright holder saying it may be distributed under the terms of this General Public License. The "Program", below, refers to any such program or work, and a "work based on the Program" means either the Program or any work containing the Program or a portion of it, either verbatim or with modifications. Each licensee is addressed as "you".
1. You may copy and distribute verbatim copies of the Program's source code as you receive it, in any medium, provided that you conspicuously and appropriately publish on each copy an appropriate copyright notice and disclaimer of warranty; keep intact all the notices that refer to this General Public License and to the absence of any warranty; and give any other recipients of the Program a copy of this General Public License along with the Program. You may charge a fee for the physical act of transferring a copy.
2. You may modify your copy or copies of the Program or any portion of it, and copy and distribute such modifications under the terms of Paragraph 1 above, provided that you also do the following:
  - a) cause the modified files to carry prominent notices stating that you changed the files and the date of any change; and
  - b) cause the whole of any work that you distribute or publish, that in whole or in part contains the Program or any part thereof, either with or without modifications, to be licensed at no charge to all third parties under the terms of this General Public License (except that you may choose to grant warranty protection to some or all third parties, at your option).
  - c) If the modified program normally reads commands interactively when run, you must cause it, when started running for such interactive use in the simplest and most usual way, to print or display an announcement including an appropriate copyright notice and a notice that there is no warranty (or else, saying that you provide a warranty) and that users may redistribute the program under these conditions, and telling the user how to view a copy of this General Public License.
  - d) You may charge a fee for the physical act of transferring a copy, and you may at your option offer warranty protection in exchange for a fee.

Mere aggregation of another independent work with the Program (or its derivative) on a volume of a storage or distribution medium does not bring the other work under the scope of these terms.

3. You may copy and distribute the Program (or a portion or derivative of it, under Paragraph 2) in object code or executable form under the terms of Paragraphs 1 and 2 above provided that you also do one of the following:
  - a) accompany it with the complete corresponding machine-readable source code, which must be distributed under the terms of Paragraphs 1 and 2 above; or,
  - b) accompany it with a written offer, valid for at least three years, to give any third party free (except for a nominal charge for the cost of distribution) a complete machine-readable copy of the corresponding source code, to be distributed under the terms of Paragraphs 1 and 2 above; or,
  - c) accompany it with the information you received as to where the corresponding source code may be obtained. (This alternative is allowed only for noncommercial distribution and only if you received the program in object code or executable form alone.)

Source code for a work means the preferred form of the work for making modifications to it. For an executable file, complete source code means all the source code for all modules it contains; but, as a special exception, it need not include source code for modules which are standard libraries that accompany the operating system on which the executable file runs, or for standard header files or definitions files that accompany that operating system.

4. You may not copy, modify, sublicense, distribute or transfer the Program except as expressly provided under this General Public License. Any attempt otherwise to copy, modify, sublicense, distribute or transfer the Program is void, and will automatically terminate your rights to use the Program under this License. However, parties who have received copies, or rights to use copies, from you under this General Public License will not have their licenses terminated so long as such parties remain in full compliance.
5. By copying, distributing or modifying the Program (or any work based on the Program) you indicate your acceptance of this license to do so, and all its terms and conditions.
6. Each time you redistribute the Program (or any work based on the Program), the recipient automatically receives a license from the original licensor to copy, distribute or modify the Program subject to these terms and conditions. You may not impose any further restrictions on the recipients' exercise of the rights granted herein.
7. The Free Software Foundation may publish revised and/or new versions of the General Public License from time to time. Such new versions will be similar in spirit to the present version, but may differ in detail to address new problems or concerns.

Each version is given a distinguishing version number. If the Program specifies a version number of the license which applies to it and "any later version", you have the option of following the terms and conditions either of that version or of any later version published by the Free Software Foundation. If the Program does not specify a version number of the license, you may choose any version ever published by the Free Software Foundation.

8. If you wish to incorporate parts of the Program into other free programs whose distribution conditions are different, write to the author to ask for permission. For software which is copyrighted by the Free Software Foundation, write to the Free Software Foundation; we sometimes make exceptions for this. Our decision will be guided by the two goals of preserving the free status of all derivatives of our free software and of promoting the sharing and reuse of software generally.

### **NO WARRANTY**

9. BECAUSE THE PROGRAM IS LICENSED FREE OF CHARGE, THERE IS NO WARRANTY FOR THE PROGRAM, TO THE EXTENT PERMITTED BY APPLICABLE LAW. EXCEPT WHEN OTHERWISE STATED IN WRITING THE COPYRIGHT HOLDERS AND/OR OTHER PARTIES PROVIDE THE PROGRAM "AS IS" WITHOUT WARRANTY OF ANY KIND, EITHER EXPRESSED OR IMPLIED, INCLUDING, BUT NOT LIMITED TO, THE IMPLIED WARRANTIES OF MERCHANTABILITY AND FITNESS FOR A PARTICULAR PURPOSE. THE ENTIRE RISK AS TO THE QUALITY AND PERFORMANCE OF THE PROGRAM IS WITH YOU. SHOULD THE PROGRAM PROVE DEFECTIVE, YOU ASSUME THE COST OF ALL NECESSARY SERVICING, REPAIR OR CORRECTION.
10. IN NO EVENT UNLESS REQUIRED BY APPLICABLE LAW OR AGREED TO IN WRITING WILL ANY COPYRIGHT HOLDER, OR ANY OTHER PARTY WHO MAY MODIFY AND/OR REDISTRIBUTE THE PROGRAM AS PERMITTED ABOVE, BE LIABLE TO YOU FOR DAMAGES, INCLUDING ANY GENERAL, SPECIAL, INCIDENTAL OR CONSEQUENTIAL DAMAGES ARISING OUT OF THE USE OR INABILITY TO USE THE PROGRAM (INCLUDING BUT NOT LIMITED TO LOSS OF DATA OR DATA BEING RENDERED INACCURATE OR LOSSES SUSTAINED BY YOU OR THIRD PARTIES OR A FAILURE OF THE PROGRAM TO OPERATE WITH ANY OTHER PROGRAMS), EVEN IF SUCH HOLDER OR OTHER PARTY HAS BEEN ADVISED OF THE POSSIBILITY OF SUCH DAMAGES.

## END OF TERMS AND CONDITIONS

### Appendix: How to Apply These Terms to Your New Programs

If you develop a new program, and you want it to be of the greatest possible use to humanity, the best way to achieve this is to make it free software which everyone can redistribute and change under these terms.

To do so, attach the following notices to the program. It is safest to attach them to the start of each source file to most effectively convey the exclusion of warranty; and each file should have at least the "copyright" line and a pointer to where the full notice is found.

```
<one line to give the program's name and a brief idea of what it does.>  
Copyright (C) 19yy <name of author>
```

This program is free software; you can redistribute it and/or modify it under the terms of the GNU General Public License as published by the Free Software Foundation; either version 1, or (at your option) any later version.

This program is distributed in the hope that it will be useful, but WITHOUT ANY WARRANTY; without even the implied warranty of MERCHANTABILITY or FITNESS FOR A PARTICULAR PURPOSE. See the GNU General Public License for more details.

You should have received a copy of the GNU General Public License along with this program; if not, write to the Free Software Foundation, Inc., 51 Franklin Street, Fifth Floor, Boston MA 02110-1301 USA

Also add information on how to contact you by electronic and paper mail.

If the program is interactive, make it output a short notice like this when it starts in an interactive mode:

```
Gnomovision version 69, Copyright (C) 19xx name of author  
Gnomovision comes with ABSOLUTELY NO WARRANTY; for details type `show w'.  
This is free software, and you are welcome to redistribute it under certain conditions;  
type `show c' for details.
```

The hypothetical commands `show w' and `show c' should show the appropriate parts of the General Public License. Of course, the commands you use may be called something other than `show w' and `show c'; they could even be mouse-clicks or menu items--whatever suits your program.

You should also get your employer (if you work as a programmer) or your school, if any, to sign a "copyright disclaimer" for the program, if necessary. Here a sample; alter the names:

```
Yoyodyne, Inc., hereby disclaims all copyright interest in the program `Gnomovision' (a  
program to direct compilers to make passes at assemblers) written by James Hacker.
```

```
<signature of Ty Coon>, 1 April 1989  
Ty Coon, President of Vice
```

That's all there is to it!



## 14.1.2.Version 2.0

### **GNU GENERAL PUBLIC LICENSE Version 2, June 1991**

Copyright (C) 1989, 1991 Free Software Foundation, Inc., 51 Franklin Street, Fifth Floor, Boston, MA 02110-1301 USA

Everyone is permitted to copy and distribute verbatim copies of this license document, but changing it is not allowed.

#### **Preamble**

The licenses for most software are designed to take away your freedom to share and change it. By contrast, the GNU General Public License is intended to guarantee your freedom to share and change free software--to make sure the software is free for all its users. This General Public License applies to most of the Free Software Foundation's software and to any other program whose authors commit to using it. (Some other Free Software Foundation software is covered by the GNU Lesser General Public License instead.) You can apply it to your programs, too.

When we speak of free software, we are referring to freedom, not price. Our General Public Licenses are designed to make sure that you have the freedom to distribute copies of free software (and charge for this service if you wish), that you receive source code or can get it if you want it, that you can change the software or use pieces of it in new free programs; and that you know you can do these things.

To protect your rights, we need to make restrictions that forbid anyone to deny you these rights or to ask you to surrender the rights. These restrictions translate to certain responsibilities for you if you distribute copies of the software, or if you modify it.

For example, if you distribute copies of such a program, whether gratis or for a fee, you must give the recipients all the rights that you have. You must make sure that they, too, receive or can get the source code. And you must show them these terms so they know their rights.

We protect your rights with two steps: (1) copyright the software, and (2) offer you this license which gives you legal permission to copy, distribute and/or modify the software.

Also, for each author's protection and ours, we want to make certain that everyone understands that there is no warranty for this free software. If the software is modified by someone else and passed on, we want its recipients to know that what they have is not the original, so that any problems introduced by others will not reflect on the original authors' reputations.

Finally, any free program is threatened constantly by software patents. We wish to avoid the danger that redistributors of a free program will individually obtain patent licenses, in effect making the program proprietary. To prevent this, we have made it clear that any patent must be licensed for everyone's free use or not licensed at all.

The precise terms and conditions for copying, distribution and modification follow.



## **GNU GENERAL PUBLIC LICENSE TERMS AND CONDITIONS FOR COPYING, DISTRIBUTION AND MODIFICATION**

0. This License applies to any program or other work which contains a notice placed by the copyright holder saying it may be distributed under the terms of this General Public License. The "Program", below, refers to any such program or work, and a "work based on the Program" means either the Program or any derivative work under copyright law: that is to say, a work containing the Program or a portion of it, either verbatim or with modifications and/or translated into another language. (Hereinafter, translation is included without limitation in the term "modification".) Each licensee is addressed as "you".

Activities other than copying, distribution and modification are not covered by this License; they are outside its scope. The act of running the Program is not restricted, and the output from the Program is covered only if its contents constitute a work based on the Program (independent of having been made by running the Program). Whether that is true depends on what the Program does.

1. You may copy and distribute verbatim copies of the Program's source code as you receive it, in any medium, provided that you conspicuously and appropriately publish on each copy an appropriate copyright notice and disclaimer of warranty; keep intact all the notices that refer to this License and to the absence of any warranty; and give any other recipients of the Program a copy of this License along with the Program.

You may charge a fee for the physical act of transferring a copy, and you may at your option offer warranty protection in exchange for a fee.

2. You may modify your copy or copies of the Program or any portion of it, thus forming a work based on the Program, and copy and distribute such modifications or work under the terms of Section 1 above, provided that you also meet all of these conditions:

- a) You must cause the modified files to carry prominent notices stating that you changed the files and the date of any change.
- b) You must cause any work that you distribute or publish, that in whole or in part contains or is derived from the Program or any part thereof, to be licensed as a whole at no charge to all third parties under the terms of this License.
- c) If the modified program normally reads commands interactively when run, you must cause it, when started running for such interactive use in the most ordinary way, to print or display an announcement including an appropriate copyright notice and a notice that there is no warranty (or else, saying that you provide a warranty) and that users may redistribute the program under these conditions, and telling the user how to view a copy of this License. (Exception: if the Program itself is interactive but does not normally print such an announcement, your work based on the Program is not required to print an announcement.)

These requirements apply to the modified work as a whole. If identifiable sections of that work are not derived from the Program, and can be reasonably considered independent and separate works in themselves, then this License, and its terms, do not apply to those sections when you distribute them as separate works. But when you distribute the same sections as part of a whole which is a work based on the Program, the distribution of the whole must be on the terms of this License, whose permissions for other licensees extend to the entire whole, and thus to each and every part regardless of who wrote it.

Thus, it is not the intent of this section to claim rights or contest your rights to work written entirely by you; rather, the intent is to exercise the right to control the distribution of derivative or collective works based on the Program.

In addition, mere aggregation of another work not based on the Program with the Program (or with a work based on the Program) on a volume of a storage or distribution medium does not bring the other work under the scope of this License.

3. You may copy and distribute the Program (or a work based on it, under Section 2) in object code or executable form under the terms of Sections 1 and 2 above provided that you also do one of the following:
  - a) Accompany it with the complete corresponding machine-readable source code, which must be distributed under the terms of Sections 1 and 2 above on a medium customarily used for software interchange; or,
  - b) Accompany it with a written offer, valid for at least three years, to give any third party, for a charge no more than your cost of physically performing source distribution, a complete machine-readable copy of the corresponding source code, to be distributed under the terms of Sections 1 and 2 above on a medium customarily used for software interchange; or,
  - c) Accompany it with the information you received as to the offer to distribute corresponding source code. (This alternative is allowed only for noncommercial distribution and only if you received the program in object code or executable form with such an offer, in accord with Subsection b above.)

The source code for a work means the preferred form of the work for making modifications to it. For an executable work, complete source code means all the source code for all modules it contains, plus any associated interface definition files, plus the scripts used to control compilation and installation of the executable. However, as a special exception, the source code distributed need not include anything that is normally distributed (in either source or binary form) with the major components (compiler, kernel, and so on) of the operating system on which the executable runs, unless that component itself accompanies the executable.

If distribution of executable or object code is made by offering access to copy from a designated place, then offering equivalent access to copy the source code from the same place counts as distribution of the source code, even though third parties are not compelled to copy the source along with the object code.

4. You may not copy, modify, sublicense, or distribute the Program except as expressly provided under this License. Any attempt otherwise to copy, modify, sublicense or distribute the Program is void, and will automatically terminate your rights under this License. However, parties who have received copies, or rights, from you under this License will not have their licenses terminated so long as such parties remain in full compliance.
5. You are not required to accept this License, since you have not signed it. However, nothing else grants you permission to modify or distribute the Program or its derivative works. These actions are prohibited by law if you do not accept this License. Therefore, by modifying or distributing the Program (or any work based on the Program), you indicate your acceptance of this License to do so, and all its terms and conditions for copying, distributing or modifying the Program or works based on it.
6. Each time you redistribute the Program (or any work based on the Program), the recipient automatically receives a license from the original licensor to copy, distribute or modify the Program subject to these terms and conditions. You may not impose any further restrictions on the recipients' exercise of the rights granted herein. You are not responsible for enforcing compliance by third parties to this License.

7. If, as a consequence of a court judgment or allegation of patent infringement or for any other reason (not limited to patent issues), conditions are imposed on you (whether by court order, agreement or otherwise) that contradict the conditions of this License, they do not excuse you from the conditions of this License. If you cannot distribute so as to satisfy simultaneously your obligations under this License and any other pertinent obligations, then as a consequence you may not distribute the Program at all. For example, if a patent license would not permit royalty-free redistribution of the Program by all those who receive copies directly or indirectly through you, then the only way you could satisfy both it and this License would be to refrain entirely from distribution of the Program.

If any portion of this section is held invalid or unenforceable under any particular circumstance, the balance of the section is intended to apply and the section as a whole is intended to apply in other circumstances.

It is not the purpose of this section to induce you to infringe any patents or other property right claims or to contest validity of any such claims; this section has the sole purpose of protecting the integrity of the free software distribution system, which is implemented by public license practices. Many people have made generous contributions to the wide range of software distributed through that system in reliance on consistent application of that system; it is up to the author/donor to decide if he or she is willing to distribute software through any other system and a licensee cannot impose that choice.

This section is intended to make thoroughly clear what is believed to be a consequence of the rest of this License.

8. If the distribution and/or use of the Program is restricted in certain countries either by patents or by copyrighted interfaces, the original copyright holder who places the Program under this License may add an explicit geographical distribution limitation excluding those countries, so that distribution is permitted only in or among countries not thus excluded. In such case, this License incorporates the limitation as if written in the body of this License.
9. The Free Software Foundation may publish revised and/or new versions of the General Public License from time to time. Such new versions will be similar in spirit to the present version, but may differ in detail to address new problems or concerns.

Each version is given a distinguishing version number. If the Program specifies a version number of this License which applies to it and "any later version", you have the option of following the terms and conditions either of that version or of any later version published by the Free Software Foundation. If the Program does not specify a version number of this License, you may choose any version ever published by the Free Software Foundation.

10. If you wish to incorporate parts of the Program into other free programs whose distribution conditions are different, write to the author to ask for permission. For software which is copyrighted by the Free Software Foundation, write to the Free Software Foundation; we sometimes make exceptions for this. Our decision will be guided by the two goals of preserving the free status of all derivatives of our free software and of promoting the sharing and reuse of software generally.

### **NO WARRANTY**

11. BECAUSE THE PROGRAM IS LICENSED FREE OF CHARGE, THERE IS NO WARRANTY FOR THE PROGRAM, TO THE EXTENT PERMITTED BY APPLICABLE LAW. EXCEPT WHEN OTHERWISE STATED IN WRITING THE COPYRIGHT HOLDERS AND/OR OTHER PARTIES PROVIDE THE PROGRAM "AS IS" WITHOUT WARRANTY OF ANY KIND, EITHER EXPRESSED OR IMPLIED, INCLUDING, BUT NOT LIMITED TO, THE IMPLIED WARRANTIES OF MERCHANTABILITY AND FITNESS FOR A PARTICULAR PURPOSE. THE ENTIRE RISK AS TO THE QUALITY AND PERFORMANCE OF THE PROGRAM IS WITH YOU. SHOULD THE PROGRAM PROVE DEFECTIVE, YOU ASSUME THE COST OF ALL NECESSARY SERVICING, REPAIR OR CORRECTION.

12. IN NO EVENT UNLESS REQUIRED BY APPLICABLE LAW OR AGREED TO IN WRITING WILL ANY COPYRIGHT HOLDER, OR ANY OTHER PARTY WHO MAY MODIFY AND/OR REDISTRIBUTE THE PROGRAM AS PERMITTED ABOVE, BE LIABLE TO YOU FOR DAMAGES, INCLUDING ANY GENERAL, SPECIAL, INCIDENTAL OR CONSEQUENTIAL DAMAGES ARISING OUT OF THE USE OR INABILITY TO USE THE PROGRAM (INCLUDING BUT NOT LIMITED TO LOSS OF DATA OR DATA BEING RENDERED INACCURATE OR LOSSES SUSTAINED BY YOU OR THIRD PARTIES OR A FAILURE OF THE PROGRAM TO OPERATE WITH ANY OTHER PROGRAMS), EVEN IF SUCH HOLDER OR OTHER PARTY HAS BEEN ADVISED OF THE POSSIBILITY OF SUCH DAMAGES.

## END OF TERMS AND CONDITIONS

### How to Apply These Terms to Your New Programs

If you develop a new program, and you want it to be of the greatest possible use to the public, the best way to achieve this is to make it free software which everyone can redistribute and change under these terms.

To do so, attach the following notices to the program. It is safest to attach them to the start of each source file to most effectively convey the exclusion of warranty; and each file should have at least the "copyright" line and a pointer to where the full notice is found.

one line to give the program's name and a brief idea of what it does.>  
Copyright (C) <year> <name of author>

This program is free software; you can redistribute it and/or modify it under the terms of the GNU General Public License as published by the Free Software Foundation; either version 2 of the License, or (at your option) any later version.

This program is distributed in the hope that it will be useful, but WITHOUT ANY WARRANTY; without even the implied warranty of MERCHANTABILITY or FITNESS FOR A PARTICULAR PURPOSE. See the GNU General Public License for more details.

You should have received a copy of the GNU General Public License along with this program; if not, write to the Free Software Foundation, Inc., 51 Franklin Street, Fifth Floor, Boston, MA 02110-1301 USA.

Also add information on how to contact you by electronic and paper mail.

If the program is interactive, make it output a short notice like this when it starts in an interactive mode:

Gnomovision version 69, Copyright (C) year name of author Gnomovision comes with ABSOLUTELY NO WARRANTY; for details type `show w'. This is free software, and you are welcome to redistribute it under certain conditions; type `show c' for details.

The hypothetical commands `show w' and `show c' should show the appropriate parts of the General Public License. Of course, the commands you use may be called something other than `show w' and `show c'; they could even be mouse-clicks or menu items--whatever suits your program.

You should also get your employer (if you work as a programmer) or your school, if any, to sign a "copyright disclaimer" for the program, if necessary. Here is a sample; alter the names:

Yoyodyne, Inc., hereby disclaims all copyright interest in the program `Gnomovision' (which makes passes at compilers) written by James Hacker.

<signature of Ty Coon>, 1 April 1989  
Ty Coon, President of Vice

This General Public License does not permit incorporating your program into proprietary programs. If your program is a subroutine library, you may consider it more useful to permit linking proprietary applications with the library. If this is what you want to do, use the GNU Lesser General Public License instead of this License.

### 14.1.3.Version 3.0

## GNU GENERAL PUBLIC LICENSE Version 3, 29 June 2007

Copyright (C) 2007 Free Software Foundation, Inc. <<https://fsf.org/>>  
Everyone is permitted to copy and distribute verbatim copies of this license document, but changing it is not allowed.

### Preamble

The GNU General Public License is a free, copyleft license for software and other kinds of works.

The licenses for most software and other practical works are designed to take away your freedom to share and change the works. By contrast, the GNU General Public License is intended to guarantee your freedom to share and change all versions of a program--to make sure it remains free software for all its users. We, the Free Software Foundation, use the GNU General Public License for most of our software; it applies also to any other work released this way by its authors. You can apply it to your programs, too.

When we speak of free software, we are referring to freedom, not price. Our General Public Licenses are designed to make sure that you have the freedom to distribute copies of free software (and charge for them if you wish), that you receive source code or can get it if you want it, that you can change the software or use pieces of it in new free programs, and that you know you can do these things.

To protect your rights, we need to prevent others from denying you these rights or asking you to surrender the rights. Therefore, you have certain responsibilities if you distribute copies of the software, or if you modify it: responsibilities to respect the freedom of others.

For example, if you distribute copies of such a program, whether gratis or for a fee, you must pass on to the recipients the same freedoms that you received. You must make sure that they, too, receive or can get the source code. And you must show them these terms so they know their rights.

Developers that use the GNU GPL protect your rights with two steps: (1) assert copyright on the software, and (2) offer you this License giving you legal permission to copy, distribute and/or modify it.

For the developers' and authors' protection, the GPL clearly explains that there is no warranty for this free software. For both users' and authors' sake, the GPL requires that modified versions be marked as changed, so that their problems will not be attributed erroneously to authors of previous versions.

Some devices are designed to deny users access to install or run modified versions of the software inside them, although the manufacturer can do so. This is fundamentally incompatible with the aim of protecting users' freedom to change the software. The systematic pattern of such abuse occurs in the area of products for individuals to use, which is precisely where it is most unacceptable. Therefore, we have designed this version of the GPL to prohibit the practice for those products. If such problems arise substantially in other domains, we stand ready to extend this provision to those domains in future versions of the GPL, as needed to protect the freedom of users.



Finally, every program is threatened constantly by software patents. States should not allow patents to restrict development and use of software on general-purpose computers, but in those that do, we wish to avoid the special danger that patents applied to a free program could make it effectively proprietary. To prevent this, the GPL assures that patents cannot be used to render the program non-free.

The precise terms and conditions for copying, distribution and modification follow.

## TERMS AND CONDITIONS

### 0. Definitions.

This License refers to version 3 of the GNU General Public License.

Copyright also means copyright-like laws that apply to other kinds of works, such as semiconductor masks.

The Program refers to any copyrightable work licensed under this License. Each licensee is addressed as "you". "Licensees" and "recipients" may be individuals or organizations.

To "modify" a work means to copy from or adapt all or part of the work in a fashion requiring copyright permission, other than the making of an exact copy. The resulting work is called a modified version of the earlier work or a work "based on" the earlier work.

A "covered work" means either the unmodified Program or a work based on the Program.

To "propagate" a work means to do anything with it that, without permission, would make you directly or secondarily liable for infringement under applicable copyright law, except executing it on a computer or modifying a private copy. Propagation includes copying, distribution (with or without modification), making available to the public, and in some countries other activities as well.

To "convey" a work means any kind of propagation that enables other parties to make or receive copies. Mere interaction with a user through a computer network, with no transfer of a copy, is not conveying.

An interactive user interface displays "Appropriate Legal Notices" to the extent that it includes a convenient and prominently visible feature that (1) displays an appropriate copyright notice, and (2) tells the user that there is no warranty for the work (except to the extent that warranties are provided), that licensees may convey the work under this License, and how to view a copy of this License. If the interface presents a list of user commands or options, such as a menu, a prominent item in the list meets this criterion.

### 1. Source Code.

The "source code" for a work means the preferred form of the work for making modifications to it. "Object code" means any non-source form of a work.

A "Standard Interface" means an interface that either is an official standard defined by a recognized standards body, or, in the case of interfaces specified for a particular programming language, one that is widely used among developers working in that language.

The "System Libraries" of an executable work include anything, other than the work as a whole, that (a) is included in the normal form of packaging a Major Component, but which is not part of that Major Component, and (b) serves only to enable use of the work with that Major Component, or to implement a Standard Interface for which an implementation is available to the public in source code form. A "Major Component", in this context, means a major essential component (kernel, window system, and so on) of the specific operating system (if any) on which the executable work runs, or a compiler used to produce the work, or an object code interpreter used to run it.

The "Corresponding Source" for a work in object code form means all the source code needed to generate, install, and (for an executable work) run the object code and to modify the work, including scripts to control those activities. However, it does not include the work's System Libraries, or general-purpose tools or generally available free programs which are used unmodified in performing those activities but which are not part of the work. For example, Corresponding Source includes interface definition files associated with source files for the work, and the source code for shared libraries and dynamically linked subprograms that the work is specifically designed to require, such as by intimate data communication or control flow between those subprograms and other parts of the work.

The Corresponding Source need not include anything that users can regenerate automatically from other parts of the Corresponding Source.

The Corresponding Source for a work in source code form is that same work.

## 2. Basic Permissions.

All rights granted under this License are granted for the term of copyright on the Program, and are irrevocable provided the stated conditions are met. This License explicitly affirms your unlimited permission to run the unmodified Program. The output from running a covered work is covered by this License only if the output, given its content, constitutes a covered work. This License acknowledges your rights of fair use or other equivalent, as provided by copyright law.

You may make, run and propagate covered works that you do not convey, without conditions so long as your license otherwise remains in force. You may convey covered works to others for the sole purpose of having them make modifications exclusively for you, or provide you with facilities for running those works, provided that you comply with the terms of this License in conveying all material for which you do not control copyright. Those thus making or running the covered works for you must do so exclusively on your behalf, under your direction and control, on terms that prohibit them from making any copies of your copyrighted material outside their relationship with you.

Conveying under any other circumstances is permitted solely under the conditions stated below. Sublicensing is not allowed; section 10 makes it unnecessary.

## 3. Protecting Users' Legal Rights From Anti-Circumvention Law.

No covered work shall be deemed part of an effective technological measure under any applicable law fulfilling obligations under article 11 of the WIPO copyright treaty adopted on 20 December 1996, or similar laws prohibiting or restricting circumvention of such measures.

When you convey a covered work, you waive any legal power to forbid circumvention of technological measures to the extent such circumvention is effected by exercising rights under this License with respect to the covered work, and you disclaim any intention to limit operation or modification of the work as a means of enforcing, against the work's users, your or third parties' legal rights to forbid circumvention of technological measures.

#### 4. Conveying Verbatim Copies.

You may convey verbatim copies of the Program's source code as you receive it, in any medium, provided that you conspicuously and appropriately publish on each copy an appropriate copyright notice; keep intact all notices stating that this License and any nonpermissive terms added in accord with section 7 apply to the code; keep intact all notices of the absence of any warranty; and give all recipients a copy of this License along with the Program.

You may charge any price or no price for each copy that you convey, and you may offer support or warranty protection for a fee.

#### 5. Conveying Modified Source Versions.

You may convey a work based on the Program, or the modifications to produce it from the Program, in the form of source code under the terms of section 4, provided that you also meet all of these conditions:

- a) The work must carry prominent notices stating that you modified it, and giving a relevant date.
- b) The work must carry prominent notices stating that it is released under this License and any conditions added under section 7. This requirement modifies the requirement in section 4 to keep intact all notices.
- c) You must license the entire work, as a whole, under this License to anyone who comes into possession of a copy. This License will therefore apply, along with any applicable section 7 additional terms, to the whole of the work, and all its parts, regardless of how they are packaged. This License gives no permission to license the work in any other way, but it does not invalidate such permission if you have separately received it.
- d) If the work has interactive user interfaces, each must display Appropriate Legal Notices; however, if the Program has interactive interfaces that do not display Appropriate Legal Notices, your work need not make them do so.

A compilation of a covered work with other separate and independent works, which are not by their nature extensions of the covered work, and which are not combined with it such as to form a larger program, in or on a volume of a storage or distribution medium, is called an aggregate if the compilation and its resulting copyright are not used to limit the access or legal rights of the compilation's users beyond what the individual works permit. Inclusion of a covered work in an aggregate does not cause this License to apply to the other parts of the aggregate.

#### 6. Conveying Non-Source Forms.

You may convey a covered work in object code form under the terms of sections 4 and 5, provided that you also convey the machine-readable Corresponding Source under the terms of this License, in one of these ways:

- a) Convey the object code in, or embodied in, a physical product (including a physical distribution medium), accompanied by the Corresponding Source fixed on a durable physical medium customarily used for software interchange.
- b) Convey the object code in, or embodied in, a physical product (including a physical distribution medium), accompanied by a written offer, valid for at least three years and valid for as long as you offer spare parts or customer support for that product model, to give anyone who possesses the object code either (1) a copy of the Corresponding Source for all the software in the product that is covered by this License, on a durable physical medium customarily used for software interchange, for a price no more than your reasonable cost of physically performing this conveying of source, or (2) access to copy the Corresponding Source from a network server at no charge.



- c) Convey individual copies of the object code with a copy of the written offer to provide the Corresponding Source. This alternative is allowed only occasionally and noncommercially, and only if you received the object code with such an offer, in accord with subsection 6b.
- d) Convey the object code by offering access from a designated place (gratis or for a charge), and offer equivalent access to the Corresponding Source in the same way through the same place at no further charge. You need not require recipients to copy the Corresponding Source along with the object code. If the place to copy the object code is a network server, the Corresponding Source may be on a different server (operated by you or a third party) that supports equivalent copying facilities, provided you maintain clear directions next to the object code saying where to find the Corresponding Source. Regardless of what server hosts the Corresponding Source, you remain obligated to ensure that it is available for as long as needed to satisfy these requirements.
- e) Convey the object code using peer-to-peer transmission, provided you inform other peers where the object code and Corresponding Source of the work are being offered to the general public at no charge under subsection 6d.

A separable portion of the object code, whose source code is excluded from the Corresponding Source as a System Library, need not be included in conveying the object code work.

A "User Product" is either (1) a "consumer product", which means any tangible personal property which is normally used for personal, family, or household purposes, or (2) anything designed or sold for incorporation into a dwelling. In determining whether a product is a consumer product, doubtful cases shall be resolved in favor of coverage. For a particular product received by a particular user, "normally used" refers to a typical or common use of that class of product, regardless of the status of the particular user or of the way in which the particular user actually uses, or expects or is expected to use, the product. A product is a consumer product regardless of whether the product has substantial commercial, industrial or non-consumer uses, unless such uses represent the only significant mode of use of the product.

Installation Information for a User Product means any methods, procedures, authorization keys, or other information required to install and execute modified versions of a covered work in that User Product from a modified version of its Corresponding Source. The information must suffice to ensure that the continued functioning of the modified object code is in no case prevented or interfered with solely because modification has been made.

If you convey an object code work under this section in, or with, or specifically for use in, a User Product, and the conveying occurs as part of a transaction in which the right of possession and use of the User Product is transferred to the recipient in perpetuity or for a fixed term (regardless of how the transaction is characterized), the Corresponding Source conveyed under this section must be accompanied by the Installation Information. But this requirement does not apply if neither you nor any third party retains the ability to install modified object code on the User Product (for example, the work has been installed in ROM).

The requirement to provide Installation Information does not include a requirement to continue to provide support service, warranty, or updates for a work that has been modified or installed by the recipient, or for the User Product in which it has been modified or installed. Access to a network may be denied when the modification itself materially and adversely affects the operation of the network or violates the rules and protocols for communication across the network.

Corresponding Source conveyed, and Installation Information provided, in accord with this section must be in a format that is publicly documented (and with an implementation available to the public in source code form), and must require no special password or key for unpacking, reading or copying.

## 7. Additional Terms.

Additional permissions are terms that supplement the terms of this License by making exceptions from one or more of its conditions. Additional permissions that are applicable to the entire Program shall be treated as though they were included in this License, to the extent that they are valid under applicable law. If additional permissions apply only to part of the Program, that part may be used separately under those permissions, but the entire Program remains governed by this License without regard to the additional permissions.

When you convey a copy of a covered work, you may at your option remove any additional permissions from that copy, or from any part of it. (Additional permissions may be written to require their own removal in certain cases when you modify the work.) You may place additional permissions on material, added by you to a covered work, for which you have or can give appropriate copyright permission.

Notwithstanding any other provision of this License, for material you add to a covered work, you may (if authorized by the copyright holders of that material) supplement the terms of this License with terms:

- a) Disclaiming warranty or limiting liability differently from the terms of sections 15 and 16 of this License; or
- b) Requiring preservation of specified reasonable legal notices or author attributions in that material or in the Appropriate Legal Notices displayed by works containing it; or
- c) Prohibiting misrepresentation of the origin of that material, or requiring that modified versions of such material be marked in reasonable ways as different from the original version; or
- d) Limiting the use for publicity purposes of names of licensors or authors of the material; or
- e) Declining to grant rights under trademark law for use of some trade names, trademarks, or service marks; or
- f) Requiring indemnification of licensors and authors of that material by anyone who conveys the material (or modified versions of it) with contractual assumptions of liability to the recipient, for any liability that these contractual assumptions directly impose on those licensors and authors.

All other non-permissive additional terms are considered "further restrictions" within the meaning of section 10. If the Program as you received it, or any part of it, contains a notice stating that it is governed by this License along with a term that is a further restriction, you may remove that term. If a license document contains a further restriction but permits relicensing or conveying under this License, you may add to a covered work material governed by the terms of that license document, provided that the further restriction does not survive such relicensing or conveying.

If you add terms to a covered work in accord with this section, you must place, in the relevant source files, a statement of the additional terms that apply to those files, or a notice indicating where to find the applicable terms.

Additional terms, permissive or non-permissive, may be stated in the form of a separately written license, or stated as exceptions; the above requirements apply either way.

## 8. Termination.

You may not propagate or modify a covered work except as expressly provided under this License. Any attempt otherwise to propagate or modify it is void, and will automatically terminate your rights under this License (including any patent licenses granted under the third paragraph of section 11).

However, if you cease all violation of this License, then your license from a particular copyright holder is reinstated (a) provisionally, unless and until the copyright holder explicitly and finally terminates your license, and (b) permanently, if the copyright holder fails to notify you of the violation by some reasonable means prior to 60 days after the cessation.

Moreover, your license from a particular copyright holder is reinstated permanently if the copyright holder notifies you of the violation by some reasonable means, this is the first time you have received notice of violation of this License (for any work) from that copyright holder, and you cure the violation prior to 30 days after your receipt of the notice.

Termination of your rights under this section does not terminate the licenses of parties who have received copies or rights from you under this License. If your rights have been terminated and not permanently reinstated, you do not qualify to receive new licenses for the same material under section 10.

#### 9. Acceptance Not Required for Having Copies.

You are not required to accept this License in order to receive or run a copy of the Program. Ancillary propagation of a covered work occurring solely as a consequence of using peer-to-peer transmission to receive a copy likewise does not require acceptance. However, nothing other than this License grants you permission to propagate or modify any covered work. These actions infringe copyright if you do not accept this License. Therefore, by modifying or propagating a covered work, you indicate your acceptance of this License to do so.

#### 10. Automatic Licensing of Downstream Recipients.

Each time you convey a covered work, the recipient automatically receives a license from the original licensors, to run, modify and propagate that work, subject to this License. You are not responsible for enforcing compliance by third parties with this License.

An "entity transaction" is a transaction transferring control of an organization, or substantially all assets of one, or subdividing an organization, or merging organizations. If propagation of a covered work results from an entity transaction, each party to that transaction who receives a copy of the work also receives whatever licenses to the work the party's predecessor in interest had or could give under the previous paragraph, plus a right to possession of the Corresponding Source of the work from the predecessor in interest, if the predecessor has it or can get it with reasonable efforts.

You may not impose any further restrictions on the exercise of the rights granted or affirmed under this License. For example, you may not impose a license fee, royalty, or other charge for exercise of rights granted under this License, and you may not initiate litigation (including cross-claim or counterclaim in a lawsuit) alleging that any patent claim is infringed by making, using, selling, offering for sale, or importing the Program or any portion of it.

#### 11. Patents.

A "contributor" is a copyright holder who authorizes use under this License of the Program or a work on which the Program is based. The work thus licensed is called the contributor's contributor version.

A contributor's "essential patent claims" are all patent claims owned or controlled by the contributor, whether already acquired or hereafter acquired, that would be infringed by some manner, permitted by this License, of making, using, or selling its contributor version, but do not include claims that would be infringed only as a consequence of further modification of the contributor version. For purposes of this definition, "control" includes the right to grant patent sublicenses in a manner consistent with the requirements of this License.

Each contributor grants you a non-exclusive, worldwide, royalty-free patent license under the contributor's essential patent claims, to make, use, sell, offer for sale, import and otherwise run, modify and propagate the contents of its contributor version.

In the following three paragraphs, a "patent license" is any express agreement or commitment, however denominated, not to enforce a patent (such as an express permission to practice a patent or covenant not to sue for patent infringement). To "grant" such a patent license to a party means to make such an agreement or commitment not to enforce a patent against the party.

If you convey a covered work, knowingly relying on a patent license, and the Corresponding Source of the work is not available for anyone to copy, free of charge and under the terms of this License, through a publicly available network server or other readily accessible means, then you must either (1) cause the Corresponding Source to be so available, or (2) arrange to deprive yourself of the benefit of the patent license for this particular work, or (3) arrange, in a manner consistent with the requirements of this License, to extend the patent license to downstream recipients. "Knowingly relying" means you have actual knowledge that, but for the patent license, your conveying the covered work in a country, or your recipient's use of the covered work in a country, would infringe one or more identifiable patents in that country that you have reason to believe are valid.

If, pursuant to or in connection with a single transaction or arrangement, you convey, or propagate by procuring conveyance of, a covered work, and grant a patent license to some of the parties receiving the covered work authorizing them to use, propagate, modify or convey a specific copy of the covered work, then the patent license you grant is automatically extended to all recipients of the covered work and works based on it.

A patent license is "discriminatory" if it does not include within the scope of its coverage, prohibits the exercise of, or is conditioned on the non-exercise of one or more of the rights that are specifically granted under this License. You may not convey a covered work if you are a party to an arrangement with a third party that is in the business of distributing software, under which you make payment to the third party based on the extent of your activity of conveying the work, and under which the third party grants, to any of the parties who would receive the covered work from you, a discriminatory patent license (a) in connection with copies of the covered work conveyed by you (or copies made from those copies), or (b) primarily for and in connection with specific products or compilations that contain the covered work, unless you entered into that arrangement, or that patent license was granted, prior to 28 March 2007.

Nothing in this License shall be construed as excluding or limiting any implied license or other defenses to infringement that may otherwise be available to you under applicable patent law.

## 12. No Surrender of Others' Freedom.

If conditions are imposed on you (whether by court order, agreement or otherwise) that contradict the conditions of this License, they do not excuse you from the conditions of this License. If you cannot convey a covered work so as to satisfy simultaneously your obligation under this License and any other pertinent obligations, then as a consequence you may not convey it at all. For example, if you agree to terms that obligate you to collect a royalty for further conveying from those to whom you convey the Program, the only way you could satisfy both those terms and this License would be to refrain entirely from conveying the Program.

## 13. Use with the GNU Affero General Public License.

Notwithstanding any other provision of this License, you have permission to link or combine any covered work with a work licensed under version 3 of the GNU Affero General Public License into a single combined work, and to convey the resulting work. The terms of this License will continue to apply to the part which is the covered work, but the special requirements of the GNU Affero General Public License, section 13, concerning interaction through a network will apply to the combination as such.

#### 14. Revised Versions of this License.

The Free Software Foundation may publish revised and/or new versions of the GNU General Public License from time to time. Such new versions will be similar in spirit to the present version, but may differ in detail to address new problems or concerns.

Each version is given a distinguishing version number. If the Program specifies that a certain numbered version of the GNU General Public License "or any later version" applies to it, you have the option of following the terms and conditions either of that numbered version or of any later version published by the Free Software Foundation. If the Program does not specify a version number of the GNU General Public License, you may choose any version ever published by the Free Software Foundation.

If the Program specifies that a proxy can decide which future versions of the GNU General Public License can be used, that proxy's public statement of acceptance of a version permanently authorizes you to choose that version for the Program.

Later license versions may give you additional or different permissions. However, no additional obligations are imposed on any author or copyright holder as a result of your choosing to follow a later version.

#### 15. Disclaimer of Warranty.

THERE IS NO WARRANTY FOR THE PROGRAM, TO THE EXTENT PERMITTED BY APPLICABLE LAW. EXCEPT WHEN OTHERWISE STATED IN WRITING THE COPYRIGHT HOLDERS AND/OR OTHER PARTIES PROVIDE THE PROGRAM "AS IS" WITHOUT WARRANTY OF ANY KIND, EITHER EXPRESSED OR IMPLIED, INCLUDING, BUT NOT LIMITED TO, THE IMPLIED WARRANTIES OF MERCHANTABILITY AND FITNESS FOR A PARTICULAR PURPOSE. THE ENTIRE RISK AS TO THE QUALITY AND PERFORMANCE OF THE PROGRAM IS WITH YOU. SHOULD THE PROGRAM PROVE DEFECTIVE, YOU ASSUME THE COST OF ALL NECESSARY SERVICING, REPAIR OR CORRECTION.

#### 16. Limitation of Liability.

IN NO EVENT UNLESS REQUIRED BY APPLICABLE LAW OR AGREED TO IN WRITING WILL ANY COPYRIGHT HOLDER, OR ANY OTHER PARTY WHO MODIFIES AND/OR CONVEYS THE PROGRAM AS PERMITTED ABOVE, BE LIABLE TO YOU FOR DAMAGES, INCLUDING ANY GENERAL, SPECIAL, INCIDENTAL OR CONSEQUENTIAL DAMAGES ARISING OUT OF THE USE OR INABILITY TO USE THE PROGRAM (INCLUDING BUT NOT LIMITED TO LOSS OF DATA OR DATA BEING RENDERED INACCURATE OR LOSSES SUSTAINED BY YOU OR THIRD PARTIES OR A FAILURE OF THE PROGRAM TO OPERATE WITH ANY OTHER PROGRAMS), EVEN IF SUCH HOLDER OR OTHER PARTY HAS BEEN ADVISED OF THE POSSIBILITY OF SUCH DAMAGES.

#### 17. Interpretation of Sections 15 and 16.

If the disclaimer of warranty and limitation of liability provided above cannot be given local legal effect according to their terms, reviewing courts shall apply local law that most closely approximates an absolute waiver of all civil liability in connection with the Program, unless a warranty or assumption of liability accompanies a copy of the Program in return for a fee.



## END OF TERMS AND CONDITIONS

### How to Apply These Terms to Your New Programs

If you develop a new program, and you want it to be of the greatest possible use to the public, the best way to achieve this is to make it free software which everyone can redistribute and change under these terms.

To do so, attach the following notices to the program. It is safest to attach them to the start of each source file to most effectively state the exclusion of warranty; and each file should have at least the "copyright" line and a pointer to where the full notice is found.

```
<one line to give the program's name and a brief idea of what it does.>
Copyright (C) <year> <name of author>
```

This program is free software: you can redistribute it and/or modify it under the terms of the GNU General Public License as published by the Free Software Foundation, either version 3 of the License, or (at your option) any later version.

This program is distributed in the hope that it will be useful, but WITHOUT ANY WARRANTY; without even the implied warranty of MERCHANTABILITY or FITNESS FOR A PARTICULAR PURPOSE. See the GNU General Public License for more details.

You should have received a copy of the GNU General Public License along with this program. If not, see <https://www.gnu.org/licenses/>.

Also add information on how to contact you by electronic and paper mail.

If the program does terminal interaction, make it output a short notice like this when it starts in an interactive mode:

```
<program> Copyright (C) <year> <name of author>
This program comes with ABSOLUTELY NO WARRANTY; for details type `show w'. This is
free software, and you are welcome to redistribute it under certain conditions; type `show c'
for details.
```

The hypothetical commands `show w' and `show c' should show the appropriate parts of the General Public License. Of course, your program's commands might be different; for a GUI interface, you would use an "about box".

You should also get your employer (if you work as a programmer) or school, if any, to sign a copyright disclaimer for the program, if necessary. For more information on this, and how to apply and follow the GNU GPL, see <https://www.gnu.org/licenses/>.

The GNU General Public License does not permit incorporating your program into proprietary programs. If your program is a subroutine library, you may consider it more useful to permit linking proprietary applications with the library. If this is what you want to do, use the GNU Lesser General Public License instead of this License. But first, please read <https://www.gnu.org/licenses/why-not-lgpl.html>.

## 14.2. GNU LIBRARY GENERAL PUBLIC LICENSE

### 14.2.1. Version 2.1

#### **GNU LESSER GENERAL PUBLIC LICENSE Version 2.1, February 1999**

Copyright (C) 1991, 1999 Free Software Foundation, Inc.  
51 Franklin Street, Fifth Floor, Boston, MA 02110-1301 USA  
Everyone is permitted to copy and distribute verbatim copies of this license document, but changing it is not allowed.

[This is the first released version of the Lesser GPL. It also counts as the successor of the GNU Library Public License, version 2, hence the version number 2.1.]

#### **Preamble**

The licenses for most software are designed to take away your freedom to share and change it. By contrast, the GNU General Public Licenses are intended to guarantee your freedom to share and change free software--to make sure the software is free for all its users.

This license, the Lesser General Public License, applies to some specially designated software packages--typically libraries--of the Free Software Foundation and other authors who decide to use it. You can use it too, but we suggest you first think carefully about whether this license or the ordinary General Public License is the better strategy to use in any particular case, based on the explanations below.

When we speak of free software, we are referring to freedom of use, not price. Our General Public Licenses are designed to make sure that you have the freedom to distribute copies of free software (and charge for this service if you wish); that you receive source code or can get it if you want it; that you can change the software and use pieces of it in new free programs; and that you are informed that you can do these things.

To protect your rights, we need to make restrictions that forbid distributors to deny you these rights or to ask you to surrender these rights. These restrictions translate to certain responsibilities for you if you distribute copies of the library or if you modify it.

For example, if you distribute copies of the library, whether gratis or for a fee, you must give the recipients all the rights that we gave you. You must make sure that they, too, receive or can get the source code. If you link other code with the library, you must provide complete object files to the recipients, so that they can relink them with the library after making changes to the library and recompiling it. And you must show them these terms so they know their rights.

We protect your rights with a two-step method: (1) we copyright the library, and (2) we offer you this license, which gives you legal permission to copy, distribute and/or modify the library.

To protect each distributor, we want to make it very clear that there is no warranty for the free library. Also, if the library is modified by someone else and passed on, the recipients should know that what they have is not the original version, so that the original author's reputation will not be affected by problems that might be introduced by others.

Finally, software patents pose a constant threat to the existence of any free program. We wish to make sure that a company cannot effectively restrict the users of a free program by obtaining a restrictive license from a patent holder. Therefore, we insist that any patent license obtained for a version of the library must be consistent with the full freedom of use specified in this license.

Most GNU software, including some libraries, is covered by the ordinary GNU General Public License. This license, the GNU Lesser General Public License, applies to certain designated libraries, and is quite different from the ordinary General Public License. We use this license for certain libraries in order to permit linking those libraries into non-free programs.

When a program is linked with a library, whether statically or using a shared library, the combination of the two is legally speaking a combined work, a derivative of the original library. The ordinary General Public License therefore permits such linking only if the entire combination fits its criteria of freedom. The Lesser General Public License permits more lax criteria for linking other code with the library.

We call this license the "Lesser" General Public License because it does Less to protect the user's freedom than the ordinary General Public License. It also provides other free software developers Less of an advantage over competing non-free programs. These disadvantages are the reason we use the ordinary General Public License for many libraries. However, the Lesser license provides advantages in certain special circumstances.

For example, on rare occasions, there may be a special need to encourage the widest possible use of a certain library, so that it becomes a de-facto standard. To achieve this, non-free programs must be allowed to use the library. A more frequent case is that a free library does the same job as widely used non-free libraries. In this case, there is little to gain by limiting the free library to free software only, so we use the Lesser General Public License.

In other cases, permission to use a particular library in non-free programs enables a greater number of people to use a large body of free software. For example, permission to use the GNU C Library in non-free programs enables many more people to use the whole GNU operating system, as well as its variant, the GNU/Linux operating system.

Although the Lesser General Public License is Less protective of the users' freedom, it does ensure that the user of a program that is linked with the Library has the freedom and the wherewithal to run that program using a modified version of the Library.

The precise terms and conditions for copying, distribution and modification follow. Pay close attention to the difference between a "work based on the library" and a "work that uses the library". The former contains code derived from the library, whereas the latter must be combined with the library in order to run.

## **GNU LESSER GENERAL PUBLIC LICENSE TERMS AND CONDITIONS FOR COPYING, DISTRIBUTION AND MODIFICATION**

0. This License Agreement applies to any software library or other program which contains a notice placed by the copyright holder or other authorized party saying it may be distributed under the terms of this Lesser General Public License (also called "this License"). Each licensee is addressed as "you".

A "library" means a collection of software functions and/or data prepared so as to be conveniently linked with application programs (which use some of those functions and data) to form executables.

The "Library", below, refers to any such software library or work which has been distributed under these terms. A "work based on the Library" means either the Library or any derivative work under copyright law: that is to say, a work containing the Library or a portion of it, either verbatim or with modifications and/or translated straightforwardly into another language. (Hereinafter, translation is included without limitation in the term "modification".)

Source code for a work means the preferred form of the work for making modifications to it. For a library, complete source code means all the source code for all modules it contains, plus any associated interface definition files, plus the scripts used to control compilation and installation of the library.



Activities other than copying, distribution and modification are not covered by this License; they are outside its scope. The act of running a program using the Library is not restricted, and output from such a program is covered only if its contents constitute a work based on the Library (independent of the use of the Library in a tool for writing it). Whether that is true depends on what the Library does and what the program that uses the Library does.

1. You may copy and distribute verbatim copies of the Library's complete source code as you receive it, in any medium, provided that you conspicuously and appropriately publish on each copy an appropriate copyright notice and disclaimer of warranty; keep intact all the notices that refer to this License and to the absence of any warranty; and distribute a copy of this License along with the Library.

You may charge a fee for the physical act of transferring a copy, and you may at your option offer warranty protection in exchange for a fee.

2. You may modify your copy or copies of the Library or any portion of it, thus forming a work based on the Library, and copy and distribute such modifications or work under the terms of Section 1 above, provided that you also meet all of these conditions:
  - a) The modified work must itself be a software library.
  - b) You must cause the files modified to carry prominent notices stating that you changed the files and the date of any change.
  - c) You must cause the whole of the work to be licensed at no charge to all third parties under the terms of this License.
  - d) If a facility in the modified Library refers to a function or a table of data to be supplied by an application program that uses the facility, other than as an argument passed when the facility is invoked, then you must make a good faith effort to ensure that, in the event an application does not supply such function or table, the facility still operates, and performs whatever part of its purpose remains meaningful. (For example, a function in a library to compute square roots has a purpose that is entirely well-defined independent of the application. Therefore, Subsection 2d requires that any application-supplied function or table used by this function must be optional: if the application does not supply it, the square root function must still compute square roots.)

These requirements apply to the modified work as a whole. If identifiable sections of that work are not derived from the Library, and can be reasonably considered independent and separate works in themselves, then this License, and its terms, do not apply to those sections when you distribute them as separate works. But when you distribute the same sections as part of a whole which is a work based on the Library, the distribution of the whole must be on the terms of this License, whose permissions for other licensees extend to the entire whole, and thus to each and every part regardless of who wrote it.

Thus, it is not the intent of this section to claim rights or contest your rights to work written entirely by you; rather, the intent is to exercise the right to control the distribution of derivative or collective works based on the Library.

In addition, mere aggregation of another work not based on the Library with the Library (or with a work based on the Library) on a volume of a storage or distribution medium does not bring the other work under the scope of this License.

3. You may opt to apply the terms of the ordinary GNU General Public License instead of this License to a given copy of the Library. To do this, you must alter all the notices that refer to this License, so that they refer to the ordinary GNU General Public License, version 2, instead of to this License. (If a newer version than version 2 of the ordinary GNU General Public License has appeared, then you can specify that version instead if you wish.) Do not make any other change in these notices.

Once this change is made in a given copy, it is irreversible for that copy, so the ordinary GNU General Public License applies to all subsequent copies and derivative works made from that copy.

This option is useful when you wish to copy part of the code of the Library into a program that is not a library.

4. You may copy and distribute the Library (or a portion or derivative of it, under Section 2) in object code or executable form under the terms of Sections 1 and 2 above provided that you accompany it with the complete corresponding machine-readable source code, which must be distributed under the terms of Sections 1 and 2 above on a medium customarily used for software interchange.

If distribution of object code is made by offering access to copy from a designated place, then offering equivalent access to copy the source code from the same place satisfies the requirement to distribute the source code, even though third parties are not compelled to copy the source along with the object code.

5. A program that contains no derivative of any portion of the Library, but is designed to work with the Library by being compiled or linked with it, is called a "work that uses the Library". Such a work, in isolation, is not a derivative work of the Library, and therefore falls outside the scope of this License.

However, linking a "work that uses the Library" with the Library creates an executable that is a derivative of the Library (because it contains portions of the Library), rather than a "work that uses the library". The executable is therefore covered by this License. Section 6 states terms for distribution of such executables.

When a "work that uses the Library" uses material from a header file that is part of the Library, the object code for the work may be a derivative work of the Library even though the source code is not. Whether this is true is especially significant if the work can be linked without the Library, or if the work is itself a library. The threshold for this to be true is not precisely defined by law.

If such an object file uses only numerical parameters, data structure layouts and accessors, and small macros and small inline functions (ten lines or less in length), then the use of the object file is unrestricted, regardless of whether it is legally a derivative work. (Executables containing this object code plus portions of the Library will still fall under Section 6.)

Otherwise, if the work is a derivative of the Library, you may distribute the object code for the work under the terms of Section 6. Any executables containing that work also fall under Section 6, whether or not they are linked directly with the Library itself.

6. As an exception to the Sections above, you may also combine or link a "work that uses the Library" with the Library to produce a work containing portions of the Library, and distribute that work under terms of your choice, provided that the terms permit modification of the work for the customer's own use and reverse engineering for debugging such modifications.

You must give prominent notice with each copy of the work that the Library is used in it and that the Library and its use are covered by this License. You must supply a copy of this License. If the work during execution displays copyright notices, you must include the copyright notice for the Library among them, as well as a reference directing the user to the copy of this License. Also, you must do one of these things:

- a) Accompany the work with the complete corresponding machine-readable source code for the Library including whatever changes were used in the work (which must be distributed under Sections 1 and 2 above); and, if the work is an executable linked with the Library, with the complete machine-readable "work that uses the Library", as object code and/or source code, so that the user can modify the Library and then relink to produce a modified executable containing the modified Library. (It is understood that the user who changes the contents of definitions files in the Library will not necessarily be able to recompile the application to use the modified definitions.)
- b) Use a suitable shared library mechanism for linking with the Library. A suitable mechanism is one that (1) uses at run time a copy of the library already present on the user's computer system, rather than copying library functions into the executable, and (2) will operate properly with a modified version of the library, if the user installs one, as long as the modified version is interface-compatible with the version that the work was made with.
- c) Accompany the work with a written offer, valid for at least three years, to give the same user the materials specified in Subsection 6a, above, for a charge no more than the cost of performing this distribution.
- d) If distribution of the work is made by offering access to copy from a designated place, offer equivalent access to copy the above specified materials from the same place.
- e) Verify that the user has already received a copy of these materials or that you have already sent this user a copy.

For an executable, the required form of the "work that uses the Library" must include any data and utility programs needed for reproducing the executable from it. However, as a special exception, the materials to be distributed need not include anything that is normally distributed (in either source or binary form) with the major components (compiler, kernel, and so on) of the operating system on which the executable runs, unless that component itself accompanies the executable.

It may happen that this requirement contradicts the license restrictions of other proprietary libraries that do not normally accompany the operating system. Such a contradiction means you cannot use both them and the Library together in an executable that you distribute.

7. You may place library facilities that are a work based on the Library side-by-side in a single library together with other library facilities not covered by this License, and distribute such a combined library, provided that the separate distribution of the work based on the Library and of the other library facilities is otherwise permitted, and provided that you do these two things:
  - a) Accompany the combined library with a copy of the same work based on the Library, uncombined with any other library facilities. This must be distributed under the terms of the Sections above.
  - b) Give prominent notice with the combined library of the fact that part of it is a work based on the Library, and explaining where to find the accompanying uncombined form of the same work.
8. You may not copy, modify, sublicense, link with, or distribute the Library except as expressly provided under this License. Any attempt otherwise to copy, modify, sublicense, link with, or distribute the Library is void, and will automatically terminate your rights under this License. However, parties who have received copies, or rights, from you under this License will not have their licenses terminated so long as such parties remain in full compliance.

9. You are not required to accept this License, since you have not signed it. However, nothing else grants you permission to modify or distribute the Library or its derivative works. The sections are prohibited by law if you do not accept this License. Therefore, by modifying or distributing the Library (or any work based on the Library), you indicate your acceptance of this License to do so, and all its terms and conditions for copying, distributing or modifying the Library or works based on it.
10. Each time you redistribute the Library (or any work based on the Library), the recipient automatically receives a license from the original licensor to copy, distribute, link with or modify the Library subject to these terms and conditions. You may not impose any further restrictions on the recipients' exercise of the rights granted herein. You are not responsible for enforcing compliance by third parties with this License.
11. If, as a consequence of a court judgment or allegation of patent infringement or for any other reason (not limited to patent issues), conditions are imposed on you (whether by court order, agreement or otherwise) that contradict the conditions of this License, they do not excuse you from the conditions of this License. If you cannot distribute so as to satisfy simultaneously your obligations under this License and any other pertinent obligations, then as a consequence you may not distribute the Library at all. For example, if a patent license would not permit royalty-free redistribution of the Library by all those who receive copies directly or indirectly through you, then the only way you could satisfy both it and this License would be to refrain entirely from distribution of the Library.

If any portion of this section is held invalid or unenforceable under any particular circumstance, the balance of the section is intended to apply, and the section as a whole is intended to apply in other circumstances.

It is not the purpose of this section to induce you to infringe any patents or other property right claims or to contest validity of any such claims; this section has the sole purpose of protecting the integrity of the free software distribution system which is implemented by public license practices. Many people have made generous contributions to the wide range of software distributed through that system in reliance on consistent application of that system; it is up to the author/donor to decide if he or she is willing to distribute software through any other system and a licensee cannot impose that choice.

This section is intended to make thoroughly clear what is believed to be a consequence of the rest of this License.

12. If the distribution and/or use of the Library is restricted in certain countries either by patents or by copyrighted interfaces, the original copyright holder who places the Library under this License may add an explicit geographical distribution limitation excluding those countries, so that distribution is permitted only in or among countries not thus excluded. In such case, this License incorporates the limitation as if written in the body of this License.
13. The Free Software Foundation may publish revised and/or new versions of the Lesser General Public License from time to time. Such new versions will be similar in spirit to the present version, but may differ in detail to address new problems or concerns.

Each version is given a distinguishing version number. If the Library specifies a version number of this License which applies to it and "any later version", you have the option of following the terms and conditions either of that version or of any later version published by the Free Software Foundation. If the Library does not specify a license version number, you may choose any version ever published by the Free Software Foundation.

14. If you wish to incorporate parts of the Library into other free programs whose distribution conditions are incompatible with these, write to the author to ask for permission. For software which is copyrighted by the Free Software Foundation, write to the Free Software Foundation; we sometimes make exceptions for this. Our decision will be guided by the two goals of preserving the free status of all derivatives of our free software and of promoting the sharing and reuse of software generally.

## NO WARRANTY

15. BECAUSE THE LIBRARY IS LICENSED FREE OF CHARGE, THERE IS NO WARRANTY FOR THE LIBRARY, TO THE EXTENT PERMITTED BY APPLICABLE LAW. EXCEPT WHEN OTHERWISE STATED IN WRITING THE COPYRIGHT HOLDERS AND/OR OTHER PARTIES PROVIDE THE LIBRARY "AS IS" WITHOUT WARRANTY OF ANY KIND, EITHER EXPRESSED OR IMPLIED, INCLUDING, BUT NOT LIMITED TO, THE IMPLIED WARRANTIES OF MERCHANTABILITY AND FITNESS FOR A PARTICULAR PURPOSE. THE ENTIRE RISK AS TO THE QUALITY AND PERFORMANCE OF THE LIBRARY IS WITH YOU. SHOULD THE LIBRARY PROVE DEFECTIVE, YOU ASSUME THE COST OF ALL NECESSARY SERVICING, REPAIR OR CORRECTION.

16. IN NO EVENT UNLESS REQUIRED BY APPLICABLE LAW OR AGREED TO IN WRITING WILL ANY COPYRIGHT HOLDER, OR ANY OTHER PARTY WHO MAY MODIFY AND / OR REDISTRIBUTE THE LIBRARY AS PERMITTED ABOVE, BE LIABLE TO YOU FOR DAMAGES, INCLUDING ANY GENERAL, SPECIAL, INCIDENTAL OR CONSEQUENTIAL DAMAGES ARISING OUT OF THE USE OR INABILITY TO USE THE LIBRARY (INCLUDING BUT NOT LIMITED TO LOSS OF DATA OR DATA BEING RENDERED INACCURATE OR LOSSES SUSTAINED BY YOU OR THIRD PARTIES OR A FAILURE OF THE LIBRARY TO OPERATE WITH ANY OTHER SOFTWARE), EVEN IF SUCH HOLDER OR OTHER PARTY HAS BEEN ADVISED OF THE POSSIBILITY OF SUCH DAMAGES.

## END OF TERMS AND CONDITIONS

### How to Apply These Terms to Your New Libraries

If you develop a new library, and you want it to be of the greatest possible use to the public, we recommend making it free software that everyone can redistribute and change. You can do so by permitting redistribution under these terms (or, alternatively, under the terms of the ordinary General Public License).

To apply these terms, attach the following notices to the library. It is safest to attach them to the start of each source file to most effectively convey the exclusion of warranty; and each file should have at least the "copyright" line and a pointer to where the full notice is found.

<one line to give the library's name and a brief idea of what it does.>  
Copyright (C) <year> <name of author>

This library is free software; you can redistribute it and/or modify it under the terms of the GNU Lesser General Public License as published by the Free Software Foundation; either version 2.1 of the License, or (at your option) any later version.

This library is distributed in the hope that it will be useful, but WITHOUT ANY WARRANTY; without even the implied warranty of MERCHANTABILITY or FITNESS FOR A PARTICULAR PURPOSE. See the GNU Lesser General Public License for more details.

You should have received a copy of the GNU Lesser General Public License along with this library; if not, write to the Free Software Foundation, Inc., 51 Franklin Street, Fifth Floor, Boston, MA 02110-1301 USA

Also add information on how to contact you by electronic and paper mail.

You should also get your employer (if you work as a programmer) or your school, if any, to sign a "copyright disclaimer" for the library, if necessary. Here is a sample; alter the names:

Yoyodyne, Inc., hereby disclaims all copyright interest in the library `Frob' (a library for tweaking knobs) written by James Random Hacker.

<signature of Ty Coon>, 1 April 1990  
Ty Coon, President of Vice

That's all there is to it!



## 14.2.2. Version 3.0

### GNU LESSER GENERAL PUBLIC LICENSE Version 3, 29 June 2007

Copyright (C) 2007 Free Software Foundation, Inc. <<https://fsf.org/>>

Everyone is permitted to copy and distribute verbatim copies of this license document, but changing it is not allowed.

This version of the GNU Lesser General Public License incorporates the terms and conditions of version 3 of the GNU General Public License, supplemented by the additional permissions listed below.

#### 0. Additional Definitions.

As used herein, "this License" refers to version 3 of the GNU Lesser General Public License, and the "GNU GPL" refers to version 3 of the GNU General Public License.

The Library refers to a covered work governed by this License, other than an Application or a Combined Work as defined below.

An "Application" is any work that makes use of an interface provided by the Library, but which is not otherwise based on the Library. Defining a subclass of a class defined by the Library is deemed a mode of using an interface provided by the Library.

A "Combined Work" is a work produced by combining or linking an Application with the Library. The particular version of the Library with which the Combined Work was made is also called the Linked Version.

The "Minimal Corresponding Source" for a Combined Work means the Corresponding Source for the Combined Work, excluding any source code for portions of the Combined Work that, considered in isolation, are based on the Application, and not on the Linked Version.

The "Corresponding Application Code" for a Combined Work means the object code and/or source code for the Application, including any data and utility programs needed for reproducing the Combined Work from the Application, but excluding the System Libraries of the Combined Work.

#### 1. Exception to Section 3 of the GNU GPL.

You may convey a covered work under sections 3 and 4 of this License without being bound by section 3 of the GNU GPL.

#### 2. Conveying Modified Versions.

If you modify a copy of the Library, and, in your modifications, a facility refers to a function or data to be supplied by an Application that uses the facility (other than as an argument passed when the facility is invoked), then you may convey a copy of the modified version:

- a) under this License, provided that you make a good faith effort to ensure that, in the event an Application does not supply the function or data, the facility still operates, and performs whatever part of its purpose remains meaningful, or
- b) under the GNU GPL, with none of the additional permissions of this License applicable to that copy.

#### 3. Object Code Incorporating Material from Library Header Files.

The object code form of an Application may incorporate material from a header file that is part of the Library. You may convey such object code under terms of your choice, provided that, if the incorporated material is not limited to numerical parameters, data structure layouts and accessors, or small macros, inline functions and templates (ten or fewer lines in length), you do both of the following:

- a) Give prominent notice with each copy of the object code that the Library is used in it and that the Library and its use are covered by this License.
- b) Accompany the object code with a copy of the GNU GPL and this license document.

#### 4. Combined Works.

You may convey a Combined Work under terms of your choice that, taken together, effectively do not restrict modification of the portions of the Library contained in the Combined Work and reverse engineering for debugging such modifications, if you also do each of the following:

- a) Give prominent notice with each copy of the Combined Work that the Library is used in it and that the Library and its use are covered by this License.
- b) Accompany the Combined Work with a copy of the GNU GPL and this license document.
- c) For a Combined Work that displays copyright notices during execution, include the copyright notice for the Library among these notices, as well as a reference directing the user to the copies of the GNU GPL and this license document.
- d) Do one of the following:
  - 0) Convey the Minimal Corresponding Source under the terms of this License, and the Corresponding Application Code in a form suitable for, and under terms that permit, the user to recombine or relink the Application with a modified version of the Linked Version to produce a modified Combined Work, in the manner specified by section 6 of the GNU GPL for conveying Corresponding Source.
  - 1) Use a suitable shared library mechanism for linking with the Library. A suitable mechanism is one that (a) uses at run time a copy of the Library already present on the user's computer system, and (b) will operate properly with a modified version of the Library that is interface-compatible with the Linked Version.
- e) Provide Installation Information, but only if you would otherwise be required to provide such information under section 6 of the GNU GPL, and only to the extent that such information is necessary to install and execute a modified version of the Combined Work produced by recombining or relinking the Application with a modified version of the Linked Version. (If you use option 4d0, the Installation Information must accompany the Minimal Corresponding Source and Corresponding Application Code. If you use option 4d1, you must provide the Installation Information in the manner specified by section 6 of the GNU GPL for conveying Corresponding Source.)

#### 5. Combined Libraries.

You may place library facilities that are a work based on the Library side by side in a single library together with other library facilities that are not Applications and are not covered by this License, and convey such a combined library under terms of your choice, if you do both of the following:

- a) Accompany the combined library with a copy of the same work based on the Library, uncombined with any other library facilities, conveyed under the terms of this License.

- b) Give prominent notice with the combined library that part of it is a work based on the Library, and explaining where to find the accompanying uncombined form of the same work.

#### 6. Revised Versions of the GNU Lesser General Public License.

The Free Software Foundation may publish revised and/or new versions of the GNU Lesser General Public License from time to time. Such new versions will be similar in spirit to the present version, but may differ in detail to address new problems or concerns.

Each version is given a distinguishing version number. If the Library as you received it specifies that a certain numbered version of the GNU Lesser General Public License "or any later version" applies to it, you have the option of following the terms and conditions either of that published version or of any later version published by the Free Software Foundation. If the Library as you received it does not specify a version number of the GNU Lesser General Public License, you may choose any version of the GNU Lesser General Public License ever published by the Free Software Foundation.

If the Library as you received it specifies that a proxy can decide whether future versions of the GNU Lesser General Public License shall apply, that proxy's public statement of acceptance of any version is permanent authorization for you to choose that version for the Library.



## 14.3. BSD License

### 14.3.1. 2 -Clause

Redistribution and use in source and binary forms, with or without modification, are permitted provided that the following conditions are met:

1. Redistributions of source code must retain the above copyright notice, this list of conditions and the following disclaimer.
2. Redistributions in binary form must reproduce the above copyright notice, this list of conditions and the following disclaimer in the documentation and/or other materials provided with the distribution.

THIS SOFTWARE IS PROVIDED BY THE COPYRIGHT HOLDERS AND CONTRIBUTORS AS IS AND ANY EXPRESS OR IMPLIED WARRANTIES, INCLUDING, BUT NOT LIMITED TO, THE IMPLIED WARRANTIES OF MERCHANTABILITY AND FITNESS FOR A PARTICULAR PURPOSE ARE DISCLAIMED. IN NO EVENT SHALL THE COPYRIGHT HOLDER OR CONTRIBUTORS BE LIABLE FOR ANY DIRECT, INDIRECT, INCIDENTAL, SPECIAL, EXEMPLARY, OR CONSEQUENTIAL DAMAGES (INCLUDING, BUT NOT LIMITED TO, PROCUREMENT OF SUBSTITUTE GOODS OR SERVICES; LOSS OF USE, DATA, OR PROFITS; OR BUSINESS INTERRUPTION) HOWEVER CAUSED AND ON ANY THEORY OF LIABILITY, WHETHER IN CONTRACT, STRICT LIABILITY, OR TORT (INCLUDING NEGLIGENCE OR OTHERWISE) ARISING IN ANY WAY OUT OF THE USE OF THIS SOFTWARE, EVEN IF ADVISED OF THE POSSIBILITY OF SUCH DAMAGE.

### 14.3.2. 3 -Clause

Redistribution and use in source and binary forms, with or without modification, are permitted provided that the following conditions are met:

1. Redistributions of source code must retain the above copyright notice, this list of conditions and the following disclaimer.
2. Redistributions in binary form must reproduce the above copyright notice, this list of conditions and the following disclaimer in the documentation and/or other materials provided with the distribution.
3. Neither the name of the copyright holder nor the names of its contributors may be used to endorse or promote products derived from this software without specific prior written permission.

THIS SOFTWARE IS PROVIDED BY THE COPYRIGHT HOLDERS AND CONTRIBUTORS AS IS AND ANY EXPRESS OR IMPLIED WARRANTIES, INCLUDING, BUT NOT LIMITED TO, THE IMPLIED WARRANTIES OF MERCHANTABILITY AND FITNESS FOR A PARTICULAR PURPOSE ARE DISCLAIMED. IN NO EVENT SHALL THE COPYRIGHT HOLDER OR CONTRIBUTORS BE LIABLE FOR ANY DIRECT, INDIRECT, INCIDENTAL, SPECIAL, EXEMPLARY, OR CONSEQUENTIAL DAMAGES (INCLUDING, BUT NOT LIMITED TO, PROCUREMENT OF SUBSTITUTE GOODS OR SERVICES; LOSS OF USE, DATA, OR PROFITS; OR BUSINESS INTERRUPTION) HOWEVER CAUSED AND ON ANY THEORY OF LIABILITY, WHETHER IN CONTRACT, STRICT LIABILITY, OR TORT (INCLUDING NEGLIGENCE OR OTHERWISE) ARISING IN ANY WAY OUT OF THE USE OF THIS SOFTWARE, EVEN IF ADVISED OF THE POSSIBILITY OF SUCH DAMAGE.

#### 14.3.3.4 -Clause

Redistribution and use in source and binary forms, with or without modification, are permitted provided that the following conditions are met:

1. Redistributions of source code must retain the above copyright notice, this list of conditions and the following disclaimer.
2. Redistributions in binary form must reproduce the above copyright notice, this list of conditions and the following disclaimer in the documentation and/or other materials provided with the distribution.
3. All advertising materials mentioning features or use of this software must display the following acknowledgement:  
This product includes software developed by the <organization>.
4. Neither the name of the <organization> nor the names of its contributors may be used to endorse or promote products derived from this software without specific prior written permission.

THIS SOFTWARE IS PROVIDED BY <COPYRIGHT HOLDER> "AS IS" AND ANY EXPRESS OR IMPLIED WARRANTIES, INCLUDING, BUT NOT LIMITED TO, THE IMPLIED WARRANTIES OF MERCHANTABILITY AND FITNESS FOR A PARTICULAR PURPOSE ARE DISCLAIMED. IN NO EVENT SHALL <COPYRIGHT HOLDER> BE LIABLE FOR ANY DIRECT, INDIRECT, INCIDENTAL, SPECIAL, EXEMPLARY, OR CONSEQUENTIAL DAMAGES (INCLUDING, BUT NOT LIMITED TO, PROCUREMENT OF SUBSTITUTE GOODS OR SERVICES; LOSS OF USE, DATA, OR PROFITS; OR BUSINESS INTERRUPTION) HOWEVER CAUSED AND ON ANY THEORY OF LIABILITY, WHETHER IN CONTRACT, STRICT LIABILITY, OR TORT (INCLUDING NEGLIGENCE OR OTHERWISE) ARISING IN ANY WAY OUT OF THE USE OF THIS SOFTWARE, EVEN IF ADVISED OF THE POSSIBILITY OF SUCH DAMAGE.

## 14.4. Python Software Foundation License

### A. HISTORY OF THE SOFTWARE

Python was created in the early 1990s by Guido van Rossum at Stichting Mathematisch Centrum (CWI, see <http://www.cwi.nl>) in the Netherlands as a successor of a language called ABC. Guido remains Python's principal author, although it includes many contributions from others.

In 1995, Guido continued his work on Python at the Corporation for National Research Initiatives (CNRI, see <http://www.cnri.reston.va.us>) in Reston, Virginia where he released several versions of the software.

In May 2000, Guido and the Python core development team moved to BeOpen.com to form the BeOpen PythonLabs team. In October of the same year, the PythonLabs team moved to Digital Creations, which became Zope Corporation. In 2001, the Python Software Foundation (PSF, see <https://www.python.org/psf/>) was formed, a non-profit organization created specifically to own Python-related Intellectual Property. Zope Corporation was a sponsoring member of the PSF.

All Python releases are Open Source (see <http://www.opensource.org> for the Open Source Definition). Historically, most, but not all, Python releases have also been GPL-compatible; the table below summarizes the various releases.

Release	Derived from	Year	Owner	GPL-compatible? (1)
0.9.0 thru 1.2		1991-1995	CWI	yes
1.3 thru 1.5.2	1.2	1995-1999	CNRI	yes
1.6	1.5.2	2000	CNRI	no
2.0	1.6	2000	BeOpen.com	no
1.6.1	1.6	2001	CNRI	yes (2)
2.1	2.0+1.6.1	2001	PSF	no
2.0.1	2.0+1.6.1	2001	PSF	yes
2.1.1	2.1+2.0.1	2001	PSF	yes
2.1.2	2.1.1	2002	PSF	yes
2.1.3	2.1.2	2002	PSF	yes
2.2 and above	2.1.1	2001-now	PSF	yes

Footnotes:

- (1) GPL-compatible doesn't mean that we're distributing Python under the GPL. All Python licenses, unlike the GPL, let you distribute a modified version without making your changes open source. The GPL-compatible licenses make it possible to combine Python with other software that is released under the GPL; the others don't.
- (2) According to Richard Stallman, 1.6.1 is not GPL-compatible, because its license has a choice of law clause. According to CNRI, however, Stallman's lawyer has told CNRI's lawyer that 1.6.1 is "not incompatible" with the GPL.

Thanks to the many outside volunteers who have worked under Guido's direction to make these releases possible.

## B. TERMS AND CONDITIONS FOR ACCESSING OR OTHERWISE USING PYTHON

### PYTHON SOFTWARE FOUNDATION LICENSE VERSION 2

1. This LICENSE AGREEMENT is between the Python Software Foundation ("PSF"), and the Individual or Organization ("Licensee") accessing and otherwise using this software ("Python") in source or binary form and its associated documentation.
2. Subject to the terms and conditions of this License Agreement, PSF hereby grants Licensee a nonexclusive, royalty-free, world-wide license to reproduce, analyze, test, perform and/or display publicly, prepare derivative works, distribute, and otherwise use Python alone or in any derivative version, provided, however, that PSF's License Agreement and PSF's notice of copyright, i.e., "Copyright (c) 2001, 2002, 2003, 2004, 2005, 2006, 2007, 2008, 2009, 2010, 2011, 2012, 2013, 2014, 2015, 2016, 2017 Python Software Foundation; All Rights Reserved" are retained in Python alone or in any derivative version prepared by Licensee.
3. In the event Licensee prepares a derivative work that is based on or incorporates Python or any part thereof, and wants to make the derivative work available to others as provided herein, then Licensee hereby agrees to include in any such work a brief summary of the changes made to Python.
4. PSF is making Python available to Licensee on an "AS IS" basis. PSF MAKES NO REPRESENTATIONS OR WARRANTIES, EXPRESS OR IMPLIED. BY WAY OF EXAMPLE, BUT NOT LIMITATION, PSF MAKES NO AND DISCLAIMS ANY REPRESENTATION OR WARRANTY OF MERCHANTABILITY OR FITNESS FOR ANY PARTICULAR PURPOSE OR THAT THE USE OF PYTHON WILL NOT INFRINGE ANY THIRD PARTY RIGHTS.
5. PSF SHALL NOT BE LIABLE TO LICENSEE OR ANY OTHER USERS OF PYTHON FOR ANY INCIDENTAL, SPECIAL, OR CONSEQUENTIAL DAMAGES OR LOSS AS A RESULT OF MODIFYING, DISTRIBUTING, OR OTHERWISE USING PYTHON, OR ANY DERIVATIVE THEREOF, EVEN IF ADVISED OF THE POSSIBILITY THEREOF.
6. This License Agreement will automatically terminate upon a material breach of its terms and conditions.
7. Nothing in this License Agreement shall be deemed to create any relationship of agency, partnership, or joint venture between PSF and Licensee. This License Agreement does not grant permission to use PSF trademarks or trade name in a trademark sense to endorse or promote products or services of Licensee, or any third party.
8. By copying, installing or otherwise using Python, Licensee agrees to be bound by the terms and conditions of this License Agreement.

### BEOPEN.COM LICENSE AGREEMENT FOR PYTHON 2.0

#### BEOPEN PYTHON OPEN SOURCE LICENSE AGREEMENT VERSION 1

1. This LICENSE AGREEMENT is between BeOpen.com ("BeOpen"), having an office at 160 Saratoga Avenue, Santa Clara, CA 95051, and the Individual or Organization ("Licensee") accessing and otherwise using this software in source or binary form and its associated documentation ("the Software").
2. Subject to the terms and conditions of this BeOpen Python License Agreement, BeOpen hereby grants Licensee a non-exclusive, royalty-free, world-wide license to reproduce, analyze, test, perform and/or display publicly, prepare derivative works, distribute, and otherwise use the Software alone or in any derivative version, provided, however, that the BeOpen Python License is retained in the Software, alone or in any derivative version Python Software Foundation License prepared by Licensee.

3. BeOpen is making the Software available to Licensee on an "AS IS" basis. BEOPEN MAKES NO REPRESENTATIONS OR WARRANTIES, EXPRESS OR IMPLIED. BY WAY OF EXAMPLE, BUT NOT LIMITATION, BEOPEN MAKES NO AND DISCLAIMS ANY REPRESENTATION OR WARRANTY OF MERCHANTABILITY OR FITNESS FOR ANY PARTICULAR PURPOSE OR THAT THE USE OF THE SOFTWARE WILL NOT INFRINGE ANY THIRD PARTY RIGHTS.
4. BEOPEN SHALL NOT BE LIABLE TO LICENSEE OR ANY OTHER USERS OF THE SOFTWARE FOR ANY INCIDENTAL, SPECIAL, OR CONSEQUENTIAL DAMAGES OR LOSS AS A RESULT OF USING, MODIFYING OR DISTRIBUTING THE SOFTWARE, OR ANY DERIVATIVE THEREOF, EVEN IF ADVISED OF THE POSSIBILITY THEREOF.
5. This License Agreement will automatically terminate upon a material breach of its terms and conditions.
6. This License Agreement shall be governed by and interpreted in all respects by the law of the State of California, excluding conflict of law provisions. Nothing in this License Agreement shall be deemed to create any relationship of agency, partnership, or joint venture between BeOpen and Licensee. This License Agreement does not grant permission to use BeOpen trademarks or trade names in a trademark sense to endorse or promote products or services of Licensee, or any third party. As an exception, the "BeOpen Python" logos available at <http://www.pythonlabs.com/logos.html> may be used according to the permissions granted on that web page.
7. By copying, installing or otherwise using the software, Licensee agrees to be bound by the terms and conditions of this License Agreement.

#### CNRI LICENSE AGREEMENT FOR PYTHON 1.6.1

1. This LICENSE AGREEMENT is between the Corporation for National Research Initiatives, having an office at 1895 Preston White Drive, Reston, VA 20191 ("CNRI"), and the Individual or Organization ("Licensee") accessing and otherwise using Python 1.6.1 software in source or binary form and its associated documentation.
2. Subject to the terms and conditions of this License Agreement, CNRI hereby grants Licensee a nonexclusive, royalty-free, world-wide license to reproduce, analyze, test, perform and/or display publicly, prepare derivative works, distribute, and otherwise use Python 1.6.1 alone or in any derivative version, provided, however, that CNRI's License Agreement and CNRI's notice of copyright, i.e., "Copyright (c) 1995-2001 Corporation for National Research Initiatives; All Rights Reserved" are retained in Python 1.6.1 alone or in any derivative version prepared by Licensee. Alternately, in lieu of CNRI's License Agreement, Licensee may substitute the following text (omitting the quotes): "Python 1.6.1 is made available subject to the terms and conditions in CNRI's License Agreement. This Agreement together with Python 1.6.1 may be located on the Internet using the following unique, persistent identifier (known as a handle): 1895.22/1013. This Agreement may also be obtained from a proxy server on the Internet using the following URL: <http://hdl.handle.net/1895.22/1013>".
3. In the event Licensee prepares a derivative work that is based on or incorporates Python 1.6.1 or any part thereof, and wants to make the derivative work available to others as provided herein, then Licensee hereby agrees to include in any such work a brief summary of the changes made to Python 1.6.1.
4. CNRI is making Python 1.6.1 available to Licensee on an "AS IS" basis. CNRI MAKES NO REPRESENTATIONS OR WARRANTIES, EXPRESS OR IMPLIED. BY WAY OF EXAMPLE, BUT NOT LIMITATION, CNRI MAKES NO AND DISCLAIMS ANY REPRESENTATION OR WARRANTY OF MERCHANTABILITY OR FITNESS FOR ANY PARTICULAR PURPOSE OR THAT THE USE OF PYTHON 1.6.1 WILL NOT INFRINGE ANY THIRD PARTY RIGHTS.

5. CNRI SHALL NOT BE LIABLE TO LICENSEE OR ANY OTHER USERS OF PYTHON 1.6.1 FOR ANY INCIDENTAL, SPECIAL, OR CONSEQUENTIAL DAMAGES OR LOSS AS A RESULT OF MODIFYING, DISTRIBUTING, OR OTHERWISE USING PYTHON 1.6.1, OR ANY DERIVATIVE THEREOF, EVEN IF ADVISED OF THE POSSIBILITY THEREOF.
6. This License Agreement will automatically terminate upon a material breach of its terms and conditions.
7. This License Agreement shall be governed by the federal intellectual property law of the United States, including without limitation the federal copyright law, and, to the extent such U.S. federal law does not apply, by the law of the Commonwealth of Virginia, excluding Virginia's conflict of law provisions. Notwithstanding the foregoing, with regard to derivative works based on Python 1.6.1 that incorporate non-separable material that was previously distributed under the GNU General Public License (GPL), the law of the Commonwealth of Virginia shall govern this License Agreement only as to issues arising under or with respect to Paragraphs 4, 5, and 7 of this License Agreement. Nothing in this License Agreement shall be deemed to create any relationship of agency, partnership, or joint venture between CNRI and Licensee. This License Agreement does not grant permission to use CNRI trademarks or trade name in a trademark sense to endorse or promote products or services of Licensee, or any third party.
8. By clicking on the "ACCEPT" button where indicated, or by copying, installing or otherwise using Python 1.6.1, Licensee agrees to be bound by the terms and conditions of this License Agreement.

### **ACCEPT**

#### CWI LICENSE AGREEMENT FOR PYTHON 0.9.0 THROUGH 1.2

Copyright (c) 1991 - 1995, Stichting Mathematisch Centrum Amsterdam, The Netherlands. All rights reserved.

Permission to use, copy, modify, and distribute this software and its documentation for any purpose and without fee is hereby granted, provided that the above copyright notice appear in all copies and that both that copyright notice and this permission notice appear in supporting documentation, and that the name of Stichting Mathematisch Centrum or CWI not be used in advertising or publicity pertaining to distribution of the software without specific, written prior permission.

STICHTING MATHEMATISCH CENTRUM DISCLAIMS ALL WARRANTIES WITH REGARD TO THIS SOFTWARE, INCLUDING ALL IMPLIED WARRANTIES OF MERCHANTABILITY AND FITNESS, IN NO EVENT SHALL STICHTING MATHEMATISCH CENTRUM BE LIABLE FOR ANY SPECIAL, INDIRECT OR CONSEQUENTIAL DAMAGES OR ANY DAMAGES WHATSOEVER RESULTING FROM LOSS OF USE, DATA OR PROFITS, WHETHER IN AN ACTION OF CONTRACT, NEGLIGENCE OR OTHER TORTIOUS ACTION, ARISING OUT OF OR IN CONNECTION WITH THE USE OR PERFORMANCE OF THIS SOFTWARE.



## 14.5. OpenSSL License

### LICENSE ISSUES

The OpenSSL toolkit stays under a double license, i.e. both the conditions of the OpenSSL License and the original SSLeay license apply to the toolkit. See below for the actual license texts. Actually both licenses are BSD-style Open Source licenses. In case of any license issues related to OpenSSL please contact [openssl-core@openssl.org](mailto:openssl-core@openssl.org).

### OpenSSL License

---

---

Copyright (c) 1998-2018 The OpenSSL Project. All rights reserved.

Redistribution and use in source and binary forms, with or without modification, are permitted provided that the following conditions are met:

1. Redistributions of source code must retain the above copyright notice, this list of conditions and the following disclaimer.
2. Redistributions in binary form must reproduce the above copyright notice, this list of conditions and the following disclaimer in the documentation and/or other materials provided with the distribution.
3. All advertising materials mentioning features or use of this software must display the following acknowledgment: "This product includes software developed by the OpenSSL Project for use in the OpenSSL Toolkit. (<http://www.openssl.org/>)"
4. The names "OpenSSL Toolkit" and "OpenSSL Project" must not be used to endorse or promote products derived from this software without prior written permission. For written permission, please contact [openssl-core@openssl.org](mailto:openssl-core@openssl.org).
5. Products derived from this software may not be called "OpenSSL" nor may "OpenSSL" appear in their names without prior written permission of the OpenSSL Project.
6. Redistributions of any form whatsoever must retain the following acknowledgment:  
This product includes software developed by the OpenSSL Project for use in the OpenSSL Toolkit (<http://www.openssl.org/>)

THIS SOFTWARE IS PROVIDED BY THE OpenSSL PROJECT ``AS IS" AND ANY EXPRESSED OR IMPLIED WARRANTIES, INCLUDING, BUT NOT LIMITED TO, THE IMPLIED WARRANTIES OF MERCHANTABILITY AND FITNESS FOR A PARTICULAR PURPOSE ARE DISCLAIMED. IN NO EVENT SHALL THE OpenSSL PROJECT OR ITS CONTRIBUTORS BE LIABLE FOR ANY DIRECT, INDIRECT, INCIDENTAL, SPECIAL, EXEMPLARY, OR CONSEQUENTIAL DAMAGES (INCLUDING, BUT NOT LIMITED TO, PROCUREMENT OF SUBSTITUTE GOODS OR SERVICES; LOSS OF USE, DATA, OR PROFITS; OR BUSINESS INTERRUPTION) HOWEVER CAUSED AND ON ANY THEORY OF LIABILITY, WHETHER IN CONTRACT, STRICT LIABILITY, OR TORT (INCLUDING NEGLIGENCE OR OTHERWISE) ARISING IN ANY WAY OUT OF THE USE OF THIS SOFTWARE, EVEN IF ADVISED OF THE POSSIBILITY OF SUCH DAMAGE.

---

---

This product includes cryptographic software written by Eric Young ([eyay@cryptsoft.com](mailto:eyay@cryptsoft.com)). This product includes software written by Tim Hudson ([tjh@cryptsoft.com](mailto:tjh@cryptsoft.com)).

## Original SSLeay License

Copyright (C) 1995-1998 Eric Young (eay@cryptsoft.com) All rights reserved.

This package is an SSL implementation written by Eric Young (eay@cryptsoft.com). The implementation was written so as to conform with Netscapes SSL.

This library is free for commercial and non-commercial use as long as the following conditions are aheared to. The following conditions apply to all code found in this distribution, be it the RC4, RSA, lhash, DES, etc., code; not just the SSL code. The SSL documentation included with this distribution is covered by the same copyright terms except that the holder is Tim Hudson (tjh@cryptsoft.com).

Copyright remains Eric Young's, and as such any Copyright notices in the code are not to be removed. If this package is used in a product, Eric Young should be given attribution as the author of the parts of the library used. This can be in the form of a textual message at program startup or in documentation (online or textual) provided with the package.

Redistribution and use in source and binary forms, with or without modification, are permitted provided that the following conditions are met:

1. Redistributions of source code must retain the copyright notice, this list of conditions and the following disclaimer.
2. Redistributions in binary form must reproduce the above copyright notice, this list of conditions and the following disclaimer in the documentation and/or other materials provided with the distribution.
3. All advertising materials mentioning features or use of this software must display the following acknowledgement: "This product includes cryptographic software written by Eric Young (eay@cryptsoft.com)" The word 'cryptographic' can be left out if the rouines from the library being used are not cryptographic related :-).
4. If you include any Windows specific code (or a derivative thereof) from the apps directory (application code) you must include an acknowledgement: "This product includes software written by Tim Hudson (tjh@cryptsoft.com)"

THIS SOFTWARE IS PROVIDED BY ERIC YOUNG ``AS IS" AND ANY EXPRESS OR IMPLIED WARRANTIES, INCLUDING, BUT NOT LIMITED TO, THE IMPLIED WARRANTIES OF MERCHANTABILITY AND FITNESS FOR A PARTICULAR PURPOSE ARE DISCLAIMED. IN NO EVENT SHALL THE AUTHOR OR CONTRIBUTORS BE LIABLE FOR ANY DIRECT, INDIRECT, INCIDENTAL, SPECIAL, EXEMPLARY, OR CONSEQUENTIAL DAMAGES (INCLUDING, BUT NOT LIMITED TO, PROCUREMENT OF SUBSTITUTE GOODS OR SERVICES; LOSS OF USE, DATA, OR PROFITS; OR BUSINESS INTERRUPTION) HOWEVER CAUSED AND ON ANY THEORY OF LIABILITY, WHETHER IN CONTRACT, STRICT LIABILITY, OR TORT (INCLUDING NEGLIGENCE OR OTHERWISE) ARISING IN ANY WAY OUT OF THE USE OF THIS SOFTWARE, EVEN IF ADVISED OF THE POSSIBILITY OF SUCH DAMAGE.

The licence and distribution terms for any publically available version or derivative of this code cannot be changed. i.e. this code cannot simply be copied and put under another distribution licence [including the GNU Public Licence.]



## 14.6. Open Software Licence 3.0

### Open Software License ("OSL") v. 3.0

This Open Software License (the "License") applies to any original work of authorship (the Original Work) whose owner (the "Licensor") has placed the following licensing notice adjacent to the copyright notice for the Original Work:

Licensed under the Open Software License version 3.0

- 1) Grant of Copyright License. Licensor grants You a worldwide, royalty-free, non-exclusive, sublicensable license, for the duration of the copyright, to do the following:
  - a) to reproduce the Original Work in copies, either alone or as part of a collective work;
  - b) to translate, adapt, alter, transform, modify, or arrange the Original Work, thereby creating derivative works ("Derivative Works") based upon the Original Work;
  - c) to distribute or communicate copies of the Original Work and Derivative Works to the public, with the proviso that copies of Original Work or Derivative Works that You distribute or communicate shall be licensed under this Open Software License;
  - d) to perform the Original Work publicly; and
  - e) to display the Original Work publicly.
- 2) Grant of Patent License. Licensor grants You a worldwide, royalty-free, non-exclusive, sublicensable license, under patent claims owned or controlled by the Licensor that are embodied in the Original Work as furnished by the Licensor, for the duration of the patents, to make, use, sell, offer for sale, have made, and import the Original Work and Derivative Works.
- 3) Grant of Source Code License. The term "Source Code" means the preferred form of the Original Work for making modifications to it and all available documentation describing how to modify the Original Work. Licensor agrees to provide a machine-readable copy of the Source Code of the Original Work along with each copy of the Original Work that Licensor distributes. Licensor reserves the right to satisfy this obligation by placing a machine-readable copy of the Source Code in an information repository reasonably calculated to permit inexpensive and convenient access by You for as long as Licensor continues to distribute the Original Work.
- 4) Exclusions From License Grant. Neither the names of Licensor, nor the names of any contributors to the Original Work, nor any of their trademarks or service marks, may be used to endorse or promote products derived from this Original Work without express prior permission of the Licensor. Except as expressly stated herein, nothing in this License grants any license to Licensor's trademarks, copyrights, patents, trade secrets or any other intellectual property. No patent license is granted to make, use, sell, offer for sale, have made, or import embodiments of any patent claims other than the licensed claims defined in Section 2. No license is granted to the trademarks of Licensor even if such marks are included in the Original Work. Nothing in this License shall be interpreted to prohibit Licensor from licensing under terms different from this License any Original Work that Licensor otherwise would have a right to license.

- 5) External Deployment. The term "External Deployment" means the use, distribution, or communication of the Original Work or Derivative Works in any way such that the Original Work or Derivative Works may be used by anyone other than You, whether those works are distributed or communicated to those persons or made available as an application intended for use over a network. As an express condition for the grants of license hereunder, You must treat any External Deployment by You of the Original Work or a Derivative Work as a distribution under section 1(c).
- 6) Attribution Rights. You must retain, in the Source Code of any Derivative Works that You create, all copyright, patent, or trademark notices from the Source Code of the Original Work, as well as any notices of licensing and any descriptive text identified therein as an Attribution Notice. You must cause the Source Code for any Derivative Works that You create to carry a prominent Attribution Notice reasonably calculated to inform recipients that You have modified the Original Work.
- 7) Warranty of Provenance and Disclaimer of Warranty. Licensor warrants that the copyright in and to the Original Work and the patent rights granted herein by Licensor are owned by the Licensor or are sublicensed to You under the terms of this License with the permission of the contributor(s) of those copyrights and patent rights. Except as expressly stated in the immediately preceding sentence, the Original Work is provided under this License on an AS IS BASIS and WITHOUT WARRANTY, either express or implied, including, without limitation, the warranties of non-infringement, merchantability or fitness for a particular purpose. THE ENTIRE RISK AS TO THE QUALITY OF THE ORIGINAL WORK IS WITH YOU. This DISCLAIMER OF WARRANTY constitutes an essential part of this License. No license to the Original Work is granted by this License except under this disclaimer.
- 8) Limitation of Liability. Under no circumstances and under no legal theory, whether in tort (including negligence), contract, or otherwise, shall the Licensor be liable to anyone for any indirect, special, incidental, or consequential damages of any character arising as a result of this License or the use of the Original Work including, without limitation, damages for loss of goodwill, work stoppage, computer failure or malfunction, or any and all other commercial damages or losses. This limitation of liability shall not apply to the extent applicable law prohibits such limitation.
- 9) Acceptance and Termination. If, at any time, You expressly assented to this License, that assent indicates your clear and irrevocable acceptance of this License and all of its terms and conditions. If You distribute or communicate copies of the Original Work or a Derivative Work, You must make a reasonable effort under the circumstances to obtain the express assent of recipients to the terms of this License. This License conditions your rights to undertake the activities listed in Section 1, including your right to create Derivative Works based upon the Original Work, and doing so without honoring these terms and conditions is prohibited by copyright law and international treaty. Nothing in this License is intended to affect copyright exceptions and limitations (including "fair use" or "fair dealing"). This License shall terminate immediately and You may no longer exercise any of the rights granted to You by this License upon your failure to honor the conditions in Section 1(c).
- 10) Termination for Patent Action. This License shall terminate automatically and You may no longer exercise any of the rights granted to You by this License as of the date You commence an action, including a cross-claim or counterclaim, against Licensor or any licensee alleging that the Original Work infringes a patent. This termination provision shall not apply for an action alleging patent infringement by combinations of the Original Work with other software or hardware.

- 11) Jurisdiction, Venue and Governing Law. Any action or suit relating to this License may be brought only in the courts of a jurisdiction wherein the Licensor resides or in which Licensor conducts its primary business, and under the laws of that jurisdiction excluding its conflict-of-law provisions. The application of the United Nations Convention on Contracts for the International Sale of Goods is expressly excluded. Any use of the Original Work outside the scope of this License or after its termination shall be subject to the requirements and penalties of copyright or patent law in the appropriate jurisdiction. This section shall survive the termination of this License.
- 12) Attorneys' Fees. In any action to enforce the terms of this License or seeking damages relating thereto, the prevailing party shall be entitled to recover its costs and expenses, including, without limitation, reasonable attorneys' fees and costs incurred in connection with such action, including any appeal of such action. This section shall survive the termination of this License.
- 13) Miscellaneous. If any provision of this License is held to be unenforceable, such provision shall be reformed only to the extent necessary to make it enforceable.
- 14) Definition of "You" in This License. "You" throughout this License, whether in upper or lower case, means an individual or a legal entity exercising rights under, and complying with all of the terms of, this License. For legal entities, "You" includes any entity that controls, is controlled by, or is under common control with you. For purposes of this definition, "control" means (i) the power, direct or indirect, to cause the direction or management of such entity, whether by contract or otherwise, or (ii) ownership of fifty percent (50%) or more of the outstanding shares, or (iii) beneficial ownership of such entity.
- 15) Right to Use. You may use the Original Work in all ways not otherwise restricted or conditioned by this License or by law, and Licensor promises not to interfere with or be responsible for such uses by You.
- 16) Modification of This License. This License is Copyright (c) 2005 Lawrence Rosen. Permission is granted to copy, distribute, or communicate this License without modification. Nothing in this License permits You to modify this License as applied to the Original Work or to Derivative Works. However, You may modify the text of this License and copy, distribute or communicate your modified version (the "Modified License") and apply it to other original works of authorship subject to the following conditions: (i) You may not indicate in any way that your Modified License is the "Open Software License" or "OSL" and you may not use those names in the name of your Modified License; (ii) You must replace the notice specified in the first paragraph above with the notice "Licensed under <insert your license name here>" or with a notice of your own that is not confusingly similar to the notice in this License; and (iii) You may not claim that your original works are open source software unless your Modified License has been approved by Open Source Initiative (OSI) and You comply with its license review and certification process.

## 14.7. MIT License

Permission is hereby granted, free of charge, to any person obtaining a copy of this software and associated documentation files (the "Software"), to deal in the Software without restriction, including without limitation the rights to use, copy, modify, merge, publish, distribute, sublicense, and/or sell copies of the Software, and to permit persons to whom the Software is furnished to do so, subject to the following conditions:

The above copyright notice and this permission notice shall be included in all copies or substantial portions of the Software.

THE SOFTWARE IS PROVIDED "AS IS", WITHOUT WARRANTY OF ANY KIND, EXPRESS OR IMPLIED, INCLUDING BUT NOT LIMITED TO THE WARRANTIES OF MERCHANTABILITY, FITNESS FOR A PARTICULAR PURPOSE AND NONINFRINGEMENT. IN NO EVENT SHALL THE AUTHORS OR COPYRIGHT HOLDERS BE LIABLE FOR ANY CLAIM, DAMAGES OR OTHER LIABILITY, WHETHER IN AN ACTION OF CONTRACT, TORT OR OTHERWISE, ARISING FROM, OUT OF OR IN CONNECTION WITH THE SOFTWARE OR THE USE OR OTHER DEALINGS IN THE SOFTWARE.

## 14.8. Apache License

### Apache License

**Version 2.0, January 2004**  
<http://www.apache.org/licenses/>

#### TERMS AND CONDITIONS FOR USE, REPRODUCTION, AND DISTRIBUTION

##### 1. Definitions.

"License" shall mean the terms and conditions for use, reproduction, and distribution as defined by Sections 1 through 9 of this document.

"Licensor" shall mean the copyright owner or entity authorized by the copyright owner that is granting the License.

"Legal Entity" shall mean the union of the acting entity and all other entities that control, are controlled by, or are under common control with that entity. For the purposes of this definition, "control" means (i) the power, direct or indirect, to cause the direction or management of such entity, whether by contract or otherwise, or (ii) ownership of fifty percent (50%) or more of the outstanding shares, or (iii) beneficial ownership of such entity.

"You" (or "Your") shall mean an individual or Legal Entity exercising permissions granted by this License.

"Source" form shall mean the preferred form for making modifications, including but not limited to software source code, documentation source, and configuration files.

"Object" form shall mean any form resulting from mechanical transformation or translation of a Source form, including but not limited to compiled object code, generated documentation, and conversions to other media types.

"Work" shall mean the work of authorship, whether in Source or Object form, made available under the License, as indicated by a copyright notice that is included in or attached to the work (an example is provided in the Appendix below).

"Derivative Works" shall mean any work, whether in Source or Object form, that is based on (or derived from) the Work and for which the editorial revisions, annotations, elaborations, or other modifications represent, as a whole, an original work of authorship. For the purposes of this License, Derivative Works shall not include works that remain separable from, or merely link (or bind by name) to the interfaces of, the Work and Derivative Works thereof.

"Contribution" shall mean any work of authorship, including the original version of the Work and any modifications or additions to that Work or Derivative Works thereof, that is intentionally submitted to Licensor for inclusion in the Work by the copyright owner or by an individual or Legal Entity authorized to submit on behalf of the copyright owner. For the purposes of this definition, "submitted" means any form of electronic, verbal, or written communication sent to the Licensor or its representatives, including but not limited to communication on electronic mailing lists, source code control systems, and issue tracking systems that are managed by, or on behalf of, the Licensor for the purpose of discussing and improving the Work, but excluding communication that is conspicuously marked or otherwise designated in writing by the copyright owner as "Not a Contribution."

"Contributor" shall mean Licensor and any individual or Legal Entity on behalf of whom a Contribution has been received by Licensor and subsequently incorporated within the Work.

2. Grant of Copyright License. Subject to the terms and conditions of this License, each Contributor hereby grants to You a perpetual, worldwide, non-exclusive, no-charge, royalty-free, irrevocable copyright license to reproduce, prepare Derivative Works of, publicly display, publicly perform, sublicense, and distribute the Work and such Derivative Works in Source or Object form.
3. Grant of Patent License. Subject to the terms and conditions of this License, each Contributor hereby grants to You a perpetual, worldwide, non-exclusive, no-charge, royalty-free, irrevocable (except as stated in this section) patent license to make, have made, use, offer to sell, sell, import, and otherwise transfer the Work, where such license applies only to those patent claims licensable by such Contributor that are necessarily infringed by their Contribution(s) alone or by combination of their Contribution(s) with the Work to which such Contribution(s) was submitted. If You institute patent litigation against any entity (including a cross-claim or counterclaim in a lawsuit) alleging that the Work or a Contribution incorporated within the Work constitutes direct or contributory patent infringement, then any patent licenses Apache License granted to You under this License for that Work shall terminate as of the date such litigation is filed.
4. Redistribution. You may reproduce and distribute copies of the Work or Derivative Works thereof in any medium, with or without modifications, and in Source or Object form, provided that You meet the following conditions
  - a) You must give any other recipients of the Work or Derivative Works a copy of this License; and
  - b) You must cause any modified files to carry prominent notices stating that You changed the files; and
  - c) You must retain, in the Source form of any Derivative Works that You distribute, all copyright, patent, trademark, and attribution notices from the Source form of the Work, excluding those notices that do not pertain to any part of the Derivative Works; and
  - d) If the Work includes a "NOTICE" text file as part of its distribution, then any Derivative Works that You distribute must include a readable copy of the attribution notices contained within such NOTICE file, excluding those notices that do not pertain to any part of the Derivative Works, in at least one of the following places: within a NOTICE text file distributed as part of the Derivative Works; within the Source form or documentation, if provided along with the Derivative Works; or, within a display generated by the Derivative Works, if and wherever such third-party notices normally appear. The contents of the NOTICE file are for informational purposes only and do not modify the License. You may add Your own attribution notices within Derivative Works that You distribute, alongside or as an addendum to the NOTICE text from the Work, provided that such additional attribution notices cannot be construed as modifying the License.

You may add Your own copyright statement to Your modifications and may provide additional or different license terms and conditions for use, reproduction, or distribution of Your modifications, or for any such Derivative Works as a whole, provided Your use, reproduction, and distribution of the Work otherwise complies with the conditions stated in this License.

5. Submission of Contributions. Unless You explicitly state otherwise, any Contribution intentionally submitted for inclusion in the Work by You to the Licensor shall be under the terms and conditions of this License, without any additional terms or conditions. Notwithstanding the above, nothing herein shall supersede or modify the terms of any separate license agreement you may have executed with Licensor regarding such Contributions.



6. Trademarks. This License does not grant permission to use the trade names, trademarks, service marks, or product names of the Licensor, except as required for reasonable and customary use in describing the origin of the Work and reproducing the content of the NOTICE file.
7. Disclaimer of Warranty. Unless required by applicable law or agreed to in writing, Licensor provides the Work (and each Contributor provides its Contributions) on an "AS IS" BASIS, WITHOUT WARRANTIES OR CONDITIONS OF ANY KIND, either express or implied, including, without limitation, any warranties or conditions of TITLE, NON-INFRINGEMENT, MERCHANTABILITY, or FITNESS FOR A PARTICULAR PURPOSE. You are solely responsible for determining the appropriateness of using or redistributing the Work and assume any risks associated with Your exercise of permissions under this License.
8. Limitation of Liability. In no event and under no legal theory, whether in tort (including negligence), contract, or otherwise, unless required by applicable law (such as deliberate and grossly negligent acts) or agreed to in writing, shall any Contributor be liable to You for damages, including any direct, indirect, special, incidental, or consequential damages of any character arising as a result of this License or out of the use or inability to use the Work (including but not limited to damages for loss of goodwill, work stoppage, computer failure or malfunction, or any and all other commercial damages or losses), even if such Contributor has been advised of the possibility of such damages.
9. Accepting Warranty or Additional Liability. While redistributing the Work or Derivative Works thereof, You may choose to offer, and charge a fee for, acceptance of support, warranty, indemnity, or other liability obligations and/or rights consistent with this License. However, in accepting such obligations, You may act only on Your own behalf and on Your sole responsibility, not on behalf of any other Contributor, and only if You agree to indemnify, defend, and hold each Contributor harmless for any liability incurred by, or claims asserted against, such Contributor by reason of your accepting any such warranty or additional liability.

## END OF TERMS AND CONDITIONS

APPENDIX: How to apply the Apache License to your work.

To apply the Apache License to your work, attach the following boilerplate notice, with the fields enclosed by brackets "[]" replaced with your own identifying information. (Don't include the brackets!) The text should be enclosed in the appropriate comment syntax for the file format. We also recommend that a file or class name and description of purpose be included on the same "printed page" as the copyright notice for easier identification within third-party archives.

Copyright [yyyy] [name of copyright owner]

Licensed under the Apache License, Version 2.0 (the "License");  
you may not use this file except in compliance with the License.  
You may obtain a copy of the License at <http://www.apache.org/licenses/LICENSE-2.0>

Unless required by applicable law or agreed to in writing, software distributed under the License is distributed on an "AS IS" BASIS, WITHOUT WARRANTIES OR CONDITIONS OF ANY KIND, either express or implied. See the License for the specific language governing permissions and limitations under the License.

## 14.9. Academic Free License

### The Academic Free License v. 2.1

This Academic Free License (the "License") applies to any original work of authorship (the "Original Work") whose owner (the "Licensor") has placed the following notice immediately following the copyright notice for the Original Work:

Licensed under the Academic Free License version 2.1

- 1) Grant of Copyright License. Licensor hereby grants You a world-wide, royalty-free, non-exclusive, perpetual, sublicenseable license to do the following:
  - a) to reproduce the Original Work in copies;
  - b) to prepare derivative works ("Derivative Works") based upon the Original Work;
  - c) to distribute copies of the Original Work and Derivative Works to the public;
  - d) to perform the Original Work publicly; and
  - e) to display the Original Work publicly.
- 2) Grant of Patent License. Licensor hereby grants You a world-wide, royalty-free, non-exclusive, perpetual, sublicenseable license, under patent claims owned or controlled by the Licensor that are embodied in the Original Work as furnished by the Licensor, to make, use, sell and offer for sale the Original Work and Derivative Works.
- 3) Grant of Source Code License. The term "Source Code" means the preferred form of the Original Work for making modifications to it and all available documentation describing how to modify the Original Work. Licensor hereby agrees to provide a machine-readable copy of the Source Code of the Original Work along with each copy of the Original Work that Licensor distributes. Licensor reserves the right to satisfy this obligation by placing a machine-readable copy of the Source Code in an information repository reasonably calculated to permit inexpensive and convenient access by You for as long as Licensor continues to distribute the Original Work, and by publishing the address of that information repository in a notice immediately following the copyright notice that applies to the Original Work.
- 4) Exclusions From License Grant. Neither the names of Licensor, nor the names of any contributors to the Original Work, nor any of their trademarks or service marks, may be used to endorse or promote products derived from this Original Work without express prior written permission of the Licensor. Nothing in this License shall be deemed to grant any rights to trademarks, copyrights, patents, trade secrets or any other intellectual property of Licensor except as expressly stated herein. No patent license is granted to make, use, sell or offer to sell embodiments of any patent claims other than the licensed claims defined in Section 2. No right is granted to the trademarks of Licensor even if such marks are included in the Original Work. Nothing in this License shall be interpreted to prohibit Licensor from licensing under different terms from this License any Original Work that Licensor otherwise would have a right to license.



- 5) This section intentionally omitted.
- 6) Attribution Rights. You must retain, in the Source Code of any Derivative Works that You create, all copyright, patent or trademark notices from the Source Code of the Original Work, as well as any notices of licensing and any descriptive text identified therein as an Attribution Notice. You must cause the Source Code for any Derivative Works that You create to carry a prominent Attribution Notice reasonably calculated to inform recipients that You have modified the Original Work.
- 7) Warranty of Provenance and Disclaimer of Warranty. Licensor warrants that the copyright in and to the Original Work and the patent rights granted herein by Licensor are owned by the Licensor or are sublicensed to You under the terms of this License with the permission of the contributor(s) of those copyrights and patent rights. Except as expressly stated in the immediately preceding sentence, the Original Work is provided under this License on an "AS IS" BASIS and WITHOUT WARRANTY, either express or implied, including, without limitation, the warranties of NON-INFRINGEMENT, MERCHANTABILITY or FITNESS FOR A PARTICULAR PURPOSE. THE ENTIRE RISK AS TO THE QUALITY OF THE ORIGINAL WORK IS WITH YOU. This DISCLAIMER OF WARRANTY constitutes an essential part of this License. No license to Original Work is granted hereunder except under this disclaimer.
- 8) Limitation of Liability. Under no circumstances and under no legal theory, whether in tort (including negligence), contract, or otherwise, shall the Licensor be liable to any person for any direct, indirect, special, incidental, or consequential damages of any character arising as a result of this License or the use of the Original Work including, without limitation, damages for loss of goodwill, work stoppage, computer failure or malfunction, or any and all other commercial damages or losses. This limitation of liability shall not apply to liability for death or personal injury resulting from Licensor's negligence to the extent applicable law prohibits such limitation. Some jurisdictions do not allow the exclusion or limitation of incidental or consequential damages, so this exclusion and limitation may not apply to You.
- 9) Acceptance and Termination. If You distribute copies of the Original Work or a Derivative Work, You must make a reasonable effort under the circumstances to obtain the express assent of recipients to the terms of this License. Nothing else but this License (or another written agreement between Licensor and You) grants You permission to create Derivative Works based upon the Original Work or to exercise any of the rights granted in Section 1 herein, and any attempt to do so except under the terms of this License (or another written agreement between Licensor and You) is expressly prohibited by U.S. copyright law, the equivalent laws of other countries, and by international treaty. Therefore, by exercising any of the rights granted to You in Section 1 herein, You indicate Your acceptance of this License and all of its terms and conditions.
- 10) Termination for Patent Action. This License shall terminate automatically and You may no longer exercise any of the rights granted to You by this License as of the date You commence an action, including a cross-claim or counterclaim, against Licensor or any licensee alleging that the Original Work infringes a patent. This termination provision shall not apply for an action alleging patent infringement by combinations of the Original Work with other software or hardware.
- 11) Jurisdiction, Venue and Governing Law. Any action or suit relating to this License may be brought only in the courts of a jurisdiction wherein the Licensor resides or in which Licensor conducts its primary business, and under the laws of that jurisdiction excluding its conflict-of-law provisions. The application of the United Nations Convention on Contracts for the International Sale of Goods is expressly excluded. Any use of the Original Work outside the scope of this License or after its termination shall be subject to the Academic Free License requirements and penalties of the U.S. Copyright Act, 17 U.S.C. Â§ 101 et seq., the equivalent laws of other countries, and international treaty. This section shall survive the termination of this License.

- 12)Attorneys Fees. In any action to enforce the terms of this License or seeking damages relating thereto, the prevailing party shall be entitled to recover its costs and expenses, including, without limitation, reasonable attorneys' fees and costs incurred in connection with such action, including any appeal of such action. This section shall survive the termination of this License.
- 13)Miscellaneous. This License represents the complete agreement concerning the subject matter hereof. If any provision of this License is held to be unenforceable, such provision shall be reformed only to the extent necessary to make it enforceable.
- 14)Definition of "You" in This License. "You" throughout this License, whether in upper or lower case, means an individual or a legal entity exercising rights under, and complying with all of the terms of, this License. For legal entities, "You" includes any entity that controls, is controlled by, or is under common control with you. For purposes of this definition, "control" means (i) the power, direct or indirect, to cause the direction or management of such entity, whether by contract or otherwise, or (ii) ownership of fifty percent (50%) or more of the outstanding shares, or (iii) beneficial ownership of such entity.
- 15)Right to Use. You may use the Original Work in all ways not otherwise restricted or conditioned by this License or by law, and Licensor promises not to interfere with or be responsible for such uses by You.

This license is Copyright (C) 2003-2004 Lawrence E. Rosen. All rights reserved. Permission is hereby granted to copy and distribute this license without modification. This license may not be modified without the express written permission of its copyright owner.

---

END OF ACADEMIC FREE LICENSE. The following is intended to describe the essential differences between the Academic Free License (AFL) version 1.0 and other open source licenses:

The Academic Free License is similar to the BSD, MIT, UoI/NCSA and Apache licenses in many respects but it is intended to solve a few problems with those licenses.

- \* The AFL is written so as to make it clear what software is being licensed (by the inclusion of a statement following the copyright notice in the software). This way, the license functions better than a template license. The BSD, MIT and UoI/NCSA licenses apply to unidentified software.
- \* The AFL contains a complete copyright grant to the software. The BSD and Apache licenses are vague and incomplete in that respect.
- \* The AFL contains a complete patent grant to the software. The BSD, MIT, UoI/NCSA and Apache licenses rely on an implied patent license and contain no explicit patent grant.
- \* The AFL makes it clear that no trademark rights are granted to the licensor's trademarks. The Apache license contains such a provision, but the BSD, MIT and UoI/NCSA licenses do not.
- \* The AFL includes the warranty by the licensor that it either owns the copyright or that it is distributing the software under a license. None of the other licenses contain that warranty. All other warranties are disclaimed, as is the case for the other licenses.
- \* The AFL is itself copyrighted (with the right granted to copy and distribute without modification). This ensures that the owner of the copyright to the license will control changes. The Apache license contains a copyright notice, but the BSD, MIT and UoI/NCSA licenses do not.

## 14.10. Texas Instruments Incorporated Technology and Software Publicly

### Version 2, June 1991

Copyright (C) 1989, 1991 Free Software Foundation, Inc.  
51 Franklin Street, Fifth Floor, Boston, MA 02110-1301 USA  
Everyone is permitted to copy and distribute verbatim copies  
of this license document, but changing it is not allowed.

#### Preamble

The licenses for most software are designed to take away your freedom to share and change it. By contrast, the GNU General Public License is intended to guarantee your freedom to share and change free software--to make sure the software is free for all its users. This General Public License applies to most of the Free Software Foundation's software and to any other program whose authors commit to using it. (Some other Free Software Foundation software is covered by the GNU Library General Public License instead.) You can apply it to your programs, too.

When we speak of free software, we are referring to freedom, not price. Our General Public Licenses are designed to make sure that you have the freedom to distribute copies of free software (and charge for this service if you wish), that you receive source code or can get it if you want it, that you can change the software or use pieces of it in new free programs; and that you know you can do these things.

To protect your rights, we need to make restrictions that forbid anyone to deny you these rights or to ask you to surrender the rights. These restrictions translate to certain responsibilities for you if you distribute copies of the software, or if you modify it.

For example, if you distribute copies of such a program, whether gratis or for a fee, you must give the recipients all the rights that you have. You must make sure that they, too, receive or can get the source code. And you must show them these terms so they know their rights.

We protect your rights with two steps: (1) copyright the software, and (2) offer you this license which gives you legal permission to copy, distribute and/or modify the software.

Also, for each author's protection and ours, we want to make certain that everyone understands that there is no warranty for this free software. If the software is modified by someone else and passed on, we want its recipients to know that what they have is not the original, so that any problems introduced by others will not reflect on the original authors' reputations.

Finally, any free program is threatened constantly by software patents. We wish to avoid the danger that redistributors of a free program will individually obtain patent licenses, in effect making the program proprietary. To prevent this, we have made it clear that any patent must be licensed for everyone's free use or not licensed at all.

The precise terms and conditions for copying, distribution and modification follow.

## **GNU GENERAL PUBLIC LICENSE TERMS AND CONDITIONS FOR COPYING, DISTRIBUTION AND MODIFICATION**

0. This License applies to any program or other work which contains a notice placed by the copyright holder saying it may be distributed under the terms of this General Public License. The "Program", below, refers to any such program or work, and a "work based on the Program" means either the Program or any derivative work under copyright law: that is to say, a work containing the Program or a portion of it, either verbatim or with modifications and/or translated into another language. (Hereinafter, translation is included without limitation in the term "modification".) Each licensee is addressed as "you".

Activities other than copying, distribution and modification are not covered by this License; they are outside its scope. The act of running the Program is not restricted, and the output from the Program is covered only if its contents constitute a work based on the Program (independent of having been made by running the Program).

Whether that is true depends on what the Program does.

1. You may copy and distribute verbatim copies of the Program's source code as you receive it, in any medium, provided that you conspicuously and appropriately publish on each copy an appropriate copyright notice and disclaimer of warranty; keep intact all the notices that refer to this License and to the absence of any warranty; and give any other recipients of the Program a copy of this License along with the Program.

You may charge a fee for the physical act of transferring a copy, and you may at your option offer warranty protection in exchange for a fee.

2. You may modify your copy or copies of the Program or any portion of it, thus forming a work based on the Program, and copy and distribute such modifications or work under the terms of Section 1 above, provided that you also meet all of these conditions:

- a) You must cause the modified files to carry prominent notices stating that you changed the files and the date of any change.
- b) You must cause any work that you distribute or publish, that in whole or in part contains or is derived from the Program or any part thereof, to be licensed as a whole at no charge to all third parties under the terms of this License.
- c) If the modified program normally reads commands interactively when run, you must cause it, when started running for such interactive use in the most ordinary way, to print or display an announcement including an appropriate copyright notice and a notice that there is no warranty (or else, saying that you provide a warranty) and that users may redistribute the program under these conditions, and telling the user how to view a copy of this License. (Exception: if the Program itself is interactive but does not normally print such an announcement, your work based on the Program is not required to print an announcement.)

These requirements apply to the modified work as a whole. If identifiable sections of that work are not derived from the Program, and can be reasonably considered independent and separate works in themselves, then this License, and its terms, do not apply to those sections when you distribute them as separate works. But when you distribute the same sections as part of a whole which is a work based on the Program, the distribution of the whole must be on the terms of this License, whose permissions for other licensees extend to the entire whole, and thus to each and every part regardless of who wrote it.

Thus, it is not the intent of this section to claim rights or contest your rights to work written entirely by you; rather, the intent is to exercise the right to control the distribution of derivative or collective works based on the Program.

In addition, mere aggregation of another work not based on the Program with the Program (or with a work based on the Program) on a volume of a storage or distribution medium does not bring the other work under the scope of this License.

3. You may copy and distribute the Program (or a work based on it, under Section 2) in object code or executable form under the terms of Sections 1 and 2 above provided that you also do one of the following:
  - a) Accompany it with the complete corresponding machine-readable source code, which must be distributed under the terms of Sections 1 and 2 above on a medium customarily used for software interchange; or,
  - b) Accompany it with a written offer, valid for at least three years, to give any third party, for a charge no more than your cost of physically performing source distribution, a complete machine-readable copy of the corresponding source code, to be distributed under the terms of Sections 1 and 2 above on a medium customarily used for software interchange; or,
  - c) Accompany it with the information you received as to the offer to distribute corresponding source code. (This alternative is allowed only for noncommercial distribution and only if you received the program in object code or executable form with such an offer, in accord with Subsection b above.)

The source code for a work means the preferred form of the work for making modifications to it. For an executable work, complete source code means all the source code for all modules it contains, plus any associated interface definition files, plus the scripts used to control compilation and installation of the executable. However, as a special exception, the source code distributed need not include anything that is normally distributed (in either source or binary form) with the major components (compiler, kernel, and so on) of the operating system on which the executable runs, unless that component itself accompanies the executable.

If distribution of executable or object code is made by offering access to copy from a designated place, then offering equivalent access to copy the source code from the same place counts as distribution of the source code, even though third parties are not compelled to copy the source along with the object code.

4. You may not copy, modify, sublicense, or distribute the Program except as expressly provided under this License. Any attempt otherwise to copy, modify, sublicense or distribute the Program is void, and will automatically terminate your rights under this License.

However, parties who have received copies, or rights, from you under this License will not have their licenses terminated so long as such parties remain in full compliance.

5. You are not required to accept this License, since you have not signed it. However, nothing else grants you permission to modify or distribute the Program or its derivative works. These actions are prohibited by law if you do not accept this License. Therefore, by modifying or distributing the Program (or any work based on the Program), you indicate your acceptance of this License to do so, and all its terms and conditions for copying, distributing or modifying the Program or works based on it.



6. Each time you redistribute the Program (or any work based on the Program), the recipient automatically receives a license from the original licensor to copy, distribute or modify the Program subject to these terms and conditions. You may not impose any further restrictions on the recipients' exercise of the rights granted herein.

You are not responsible for enforcing compliance by third parties to this License.

7. If, as a consequence of a court judgment or allegation of patent infringement or for any other reason (not limited to patent issues), conditions are imposed on you (whether by court order, agreement or otherwise) that contradict the conditions of this License, they do not excuse you from the conditions of this License. If you cannot distribute so as to satisfy simultaneously your obligations under this License and any other pertinent obligations, then as a consequence you may not distribute the Program at all. For example, if a patent license would not permit royalty-free redistribution of the Program by all those who receive copies directly or indirectly through you, then the only way you could satisfy both it and this License would be to refrain entirely from distribution of the Program.

If any portion of this section is held invalid or unenforceable under any particular circumstance, the balance of the section is intended to apply and the section as a whole is intended to apply in other circumstances.

It is not the purpose of this section to induce you to infringe any patents or other property right claims or to contest validity of any such claims; this section has the sole purpose of protecting the integrity of the free software distribution system, which is implemented by public license practices. Many people have made generous contributions to the wide range of software distributed through that system in reliance on consistent application of that system; it is up to the author/donor to decide if he or she is willing to distribute software through any other system and a licensee cannot impose that choice.

This section is intended to make thoroughly clear what is believed to be a consequence of the rest of this License.

8. If the distribution and/or use of the Program is restricted in certain countries either by patents or by copyrighted interfaces, the original copyright holder who places the Program under this License may add an explicit geographical distribution limitation excluding those countries, so that distribution is permitted only in or among countries not thus excluded. In such case, this License incorporates the limitation as if written in the body of this License.
9. The Free Software Foundation may publish revised and/or new versions of the General Public License from time to time. Such new versions will be similar in spirit to the present version, but may differ in detail to address new problems or concerns.

Each version is given a distinguishing version number. If the Program specifies a version number of this License which applies to it and "any later version", you have the option of following the terms and conditions either of that version or of any later version published by the Free Software Foundation. If the Program does not specify a version number of this License, you may choose any version ever published by the Free Software Foundation.

10. If you wish to incorporate parts of the Program into other free programs whose distribution conditions are different, write to the author to ask for permission. For software which is copyrighted by the Free Software Foundation, write to the Free Software Foundation; we sometimes make exceptions for this. Our decision will be guided by the two goals of preserving the free status of all derivatives of our free software and of promoting the sharing and reuse of software generally.

## NO WARRANTY

11. BECAUSE THE PROGRAM IS LICENSED FREE OF CHARGE, THERE IS NO WARRANTY FOR THE PROGRAM, TO THE EXTENT PERMITTED BY APPLICABLE LAW. EXCEPT WHEN OTHERWISE STATED IN WRITING THE COPYRIGHT HOLDERS AND/OR OTHER PARTIES PROVIDE THE PROGRAM "AS IS" WITHOUT WARRANTY OF ANY KIND, EITHER EXPRESSED OR IMPLIED, INCLUDING, BUT NOT LIMITED TO, THE IMPLIED WARRANTIES OF MERCHANTABILITY AND FITNESS FOR A PARTICULAR PURPOSE. THE ENTIRE RISK AS TO THE QUALITY AND PERFORMANCE OF THE PROGRAM IS WITH YOU. SHOULD THE PROGRAM PROVE DEFECTIVE, YOU ASSUME THE COST OF ALL NECESSARY SERVICING, REPAIR OR CORRECTION.
12. IN NO EVENT UNLESS REQUIRED BY APPLICABLE LAW OR AGREED TO IN WRITING WILL ANY COPYRIGHT HOLDER, OR ANY OTHER PARTY WHO MAY MODIFY AND/OR REDISTRIBUTE THE PROGRAM AS PERMITTED ABOVE, BE LIABLE TO YOU FOR DAMAGES, INCLUDING ANY GENERAL, SPECIAL, INCIDENTAL OR CONSEQUENTIAL DAMAGES ARISING OUT OF THE USE OR INABILITY TO USE THE PROGRAM (INCLUDING BUT NOT LIMITED TO LOSS OF DATA OR DATA BEING RENDERED INACCURATE OR LOSSES SUSTAINED BY YOU OR THIRD PARTIES OR A FAILURE OF THE PROGRAM TO OPERATE WITH ANY OTHER PROGRAMS), EVEN IF SUCH HOLDER OR OTHER PARTY HAS BEEN ADVISED OF THE POSSIBILITY OF SUCH DAMAGES.

## END OF TERMS AND CONDITIONS

### How to Apply These Terms to Your New Programs

If you develop a new program, and you want it to be of the greatest possible use to the public, the best way to achieve this is to make it free software which everyone can redistribute and change under these terms.

To do so, attach the following notices to the program. It is safest to attach them to the start of each source file to most effectively convey the exclusion of warranty; and each file should have at least the "copyright" line and a pointer to where the full notice is found.

<one line to give the program's name and a brief idea of what it does.>  
Copyright (C) <year> <name of author>

This program is free software; you can redistribute it and/or modify it under the terms of the GNU General Public License as published by the Free Software Foundation; either version 2 of the License, or (at your option) any later version.

This program is distributed in the hope that it will be useful, but WITHOUT ANY WARRANTY; without even the implied warranty of MERCHANTABILITY or FITNESS FOR A PARTICULAR PURPOSE. See the GNU General Public License for more details.

You should have received a copy of the GNU General Public License along with this program; if not, write to the Free Software Foundation, Inc., 51 Franklin Street, Fifth Floor, Boston, MA 02110-1301 USA

Also add information on how to contact you by electronic and paper mail.

If the program is interactive, make it output a short notice like this when it starts in an interactive mode:

```
Gnomovision version 69, Copyright (C) year name of author Gnomovision comes with  
ABSOLUTELY NO WARRANTY; for details type `show w'.
```

```
This is free software, and you are welcome to redistribute it under certain conditions; type  
`show c' for details.
```

The hypothetical commands ``show w'` and ``show c'` should show the appropriate parts of the General Public License. Of course, the commands you use may be called something other than ``show w'` and ``show c'`; they could even be mouse-clicks or menu items--whatever suits your program.

You should also get your employer (if you work as a programmer) or your school, if any, to sign a "copyright disclaimer" for the program, if necessary. Here is a sample; alter the names:

```
Yoyodyne, Inc., hereby disclaims all copyright interest in the program `Gnomovision' (which  
makes passes at compilers) written by James Hacker.
```

```
<signature of Ty Coon>, 1 April 1989  
Ty Coon, President of Vice
```

This General Public License does not permit incorporating your program into proprietary programs. If your program is a subroutine library, you may consider it more useful to permit linking proprietary applications with the library. If this is what you want to do, use the GNU Library General Public License instead of this License.



Texas Instruments Incorporated  
Technology and Software Publicly Available  
Software License Agreement

IMPORTANT – PLEASE READ THE FOLLOWING LICENSE AGREEMENT CAREFULLY. THIS IS A LEGALLY BINDING AGREEMENT. DO NOT DOWNLOAD THE LICENSED MATERIALS UNLESS: (1) YOU ARE AUTHORIZED TO ACCEPT AND AGREE TO THE TERMS OF THIS LICENSE AGREEMENT AND (2) YOU INTEND TO ENTER INTO AND TO BE BOUND BY THE TERMS OF THIS AGREEMENT.

This Software License Agreement ("Agreement") is a legal agreement between you (either an individual or entity) and Texas Instruments Incorporated ("TI"), 12500 TI Boulevard, Dallas, Texas 75243. The "Licensed Materials" subject to this Agreement include, in whole or in part, the software programs that accompany this Agreement and any "on-line" or electronic documentation associated with these programs. By installing, copying or otherwise using the Licensed Materials you agree to abide by the terms of this Agreement. If you choose not to accept or agree with these terms, do not download or install the Licensed Materials.

NOTE: The Licensed Materials may be bundled with open source software. By accepting this Agreement, you may gain access to software identified as being licensed under open source licenses, which software and corresponding open source licenses will be listed in the applicable software manifest (in whole or in part, the "Open Source Materials"). Your use of the Open Source Materials is subject to the separate licensing terms applicable to such Open Source Materials as specified in the applicable software manifest. For clarification, this Agreement does not limit your rights under, or grant you rights that supersede, the license terms of any applicable Open Source Materials license agreement. If any of the Open Source Materials have been provided to you in object code, the source code versions of such Open Source Materials may be provided to you by notifying TI at Texas Instruments Incorporated, 12500 TI Boulevard, Mail Station 8638, Dallas, Texas 75243, Attention: Contracts Manager. You may terminate this Agreement in the event you choose not to accept or agree with the terms in any applicable Open Source Materials license agreement, provided that such termination occurs within five (5) days of acceptance of this Agreement and you abide by all applicable license terms in this Agreement until such termination.

1. License.

- a) Source Code License. For the Licensed Materials provided in source code format, TI hereby grants to you a limited, non-exclusive license to reproduce, use, and create modified or derivative works of the Licensed Materials provided to you in source code format and to distribute an unlimited number of copies of such source code Licensed Materials, or any derivatives thereof, in any format.
- b) Object Code License. For the Licensed Materials provided in object code format, TI hereby grants to you a limited, non-exclusive license to reproduce and use the Licensed Materials provided to you in object code format and to distribute an unlimited number of object or executable copies of such object code Licensed Materials.

2. Termination. This license is effective until terminated. Without prejudice to any other rights, TI may terminate your right to use the Licensed Materials under this Agreement if you fail to comply with the terms of this Agreement. In such event, you shall destroy all copies of the Licensed Materials, including all portions and derivatives thereof.

### 3. Intellectual Property Rights.

- a) The Licensed Materials being provided to you hereunder are being made publicly available by TI, even though they contain copyrighted material of TI and its licensors, if applicable. In no event may you alter, remove or destroy any copyright notice included in the Licensed Materials. To the extent that any of the Licensed Materials are provided in binary or object code only, you may not unlock, decompile, reverse engineer, disassemble or otherwise translate such binary or object code to human-perceivable form. The source code of such reverse engineered code may contain TI trade secret and other proprietary information. TI reserves all rights not specifically granted under this Agreement.
- b) Certain Licensed Materials may (i) require patent licenses from third parties claiming patent rights covering implementation of the Licensed Materials or (ii) be based on industry recognized standards or software programs published by industry recognized standards bodies and certain third parties may claim to own patents or copyrights that cover implementation of those standards. You acknowledge and agree that this Agreement does not convey a license to any such third party patents and copyrights.
- c) YOU ACKNOWLEDGE AND AGREE THAT TI SHALL NOT BE LIABLE FOR AND SHALL NOT DEFEND OR INDEMNIFY YOU AGAINST ANY THIRD PARTY INFRINGEMENT CLAIM THAT RELATES Texas Instruments Incorporated Technology and Software Publicly TO OR IS BASED ON YOUR MANUFACTURE, USE, OR DISTRIBUTION OF THE LICENSED MATERIALS OR YOUR MANUFACTURE, USE, OFFER FOR SALE, SALE, IMPORTATION OR DISTRIBUTION OF YOUR PRODUCTS THAT INCLUDE OR INCORPORATE THE LICENSED MATERIALS.
- d) You acknowledge and agree that you are responsible for any fees or royalties that may be payable to any third party based on such third party's interests in the Licensed Materials described in Section 3(b) above (the "Third Party Payment Obligations"). You agree to indemnify TI against any Third Party Payment Obligations and will defend any claim, suit or proceeding brought against TI insofar as such claim, suit or proceeding is based on your failure to pay any Third Party Payment Obligations.

### 4. Warranties and Limitations.

THE LICENSED MATERIALS ARE PROVIDED "AS IS". TI AND ITS LICENSORS MAKE NO WARRANTY OR REPRESENTATION, EXPRESS, IMPLIED OR STATUTORY, INCLUDING ANY IMPLIED WARRANTIES OF MERCHANTABILITY, FITNESS FOR A PARTICULAR PURPOSE, LACK OF VIRUSES, ACCURACY OR COMPLETENESS OF RESPONSES, RESULTS AND LACK OF NEGLIGENCE. TI DISCLAIMS ANY WARRANTY OF TITLE, QUIET ENJOYMENT, QUIET POSSESSION, AND NON-INFRINGEMENT OF ANY THIRD PARTY INTELLECTUAL PROPERTY RIGHTS WITH REGARD TO THE LICENSED MATERIALS OR USE OF THOSE MATERIALS.

YOU ACKNOWLEDGE AND AGREE THAT THE LICENSED MATERIALS MAY NOT BE INTENDED FOR PRODUCTION APPLICATIONS AND MAY CONTAIN IRREGULARITIES AND DEFECTS NOT FOUND IN PRODUCTION SOFTWARE. FURTHERMORE, YOU ACKNOWLEDGE AND AGREE THAT THE LICENSED MATERIALS HAVE NOT BEEN TESTED OR CERTIFIED BY ANY GOVERNMENT AGENCY OR INDUSTRY REGULATORY ORGANIZATION OR ANY OTHER THIRD PARTY ORGANIZATION. YOU AGREE THAT PRIOR TO USING, INCORPORATING OR DISTRIBUTING THE LICENSED MATERIALS IN OR WITH ANY COMMERCIAL PRODUCT THAT YOU WILL THOROUGHLY TEST THE PRODUCT AND THE FUNCTIONALITY OF THE LICENSED MATERIALS IN OR WITH THAT PRODUCT AND BE SOLELY RESPONSIBLE FOR ANY PROBLEMS OR FAILURES.

IN NO EVENT SHALL TI OR ITS LICENSORS BE LIABLE FOR ANY SPECIAL, INDIRECT, INCIDENTAL, PUNITIVE OR CONSEQUENTIAL DAMAGES, HOWEVER CAUSED ON ANY THEORY OF LIABILITY, ARISING IN ANY WAY OUT OF THIS AGREEMENT, OR YOUR USE OF THE LICENSED MATERIALS, WHETHER OR NOT TI HAS BEEN ADVISED OF THE POSSIBILITY OF SUCH DAMAGES. EXCLUDED DAMAGES INCLUDE, BUT ARE NOT LIMITED TO, COST OF REMOVAL OR REINSTALLATION, OUTSIDE COMPUTER TIME, LABOR COSTS, LOSS OR CORRUPTION OF DATA, LOSS OF GOODWILL, LOSS OF PROFITS, LOSS OF SAVINGS, OR LOSS OF USE OR INTERRUPTION OF BUSINESS OR ANY OTHER ECONOMIC LOSS. IN NO EVENT WILL TI'S AGGREGATE LIABILITY UNDER THIS AGREEMENT OR ARISING OUT OF YOUR USE OF THE LICENSED MATERIALS EXCEED FIVE HUNDRED U.S. DOLLARS (US\$500).

Because some jurisdictions do not allow the exclusion or limitation of incidental or consequential damages or limitation on how long an implied warranty lasts, the above limitations or exclusions may not apply to you.

5. **Export Control.** The software programs and any "on-line" documentation as well as any updates or upgrades to such software programs or documentation may be subject to the export or import regulations of certain countries. You agree to comply with all such regulations and acknowledge that you have the responsibility to obtain any licenses or other authorizations that may be required to export, re-export or import the Licensed Materials.
6. **Governing Law, Jurisdiction and Severability.** This Agreement will be governed by and interpreted in accordance with the laws of the State of Texas, without reference to that state's conflict of laws principles. This Agreement shall not be governed by the United Nations Convention on Contracts for the International Sale of Goods, nor shall it be governed by the Uniform Computer Information Transactions Act (UCITA). Any dispute arising out of or related to this Agreement will be brought in, and each party consents to the exclusive jurisdiction and venue in the state and federal courts sitting in Dallas County, Texas. Each party waives all defenses of lack of personal jurisdiction and forum non-conveniens and agrees that process may be served on either party in a manner authorized by applicable law or court rule. If for any reason a court of competent jurisdiction finds any provision of the Agreement to be unenforceable, that provision will be enforced to the maximum extent possible to effectuate the intent of the parties and the remainder of the Agreement shall continue in full force and effect.
7. **PRC Provisions.** If you are located in the People's Republic of China ("PRC") or if the Licensed Materials will be sent to the PRC, the following provisions shall apply and shall supersede any other provisions in this Agreement concerning the same subject matter as the following provisions:
  - a) **Registration Requirements.** You shall be solely responsible for performing all acts and obtaining all approvals that may be required in connection with this Agreement by the government of the PRC, including but not limited to registering pursuant to, and otherwise complying with, the PRC Measures on the Administration of Software Products, Management Regulations on Technology Import-Export, and Technology Import and Export Contract Registration Management Rules. Upon receipt of such approvals from the government authorities, you shall forward evidence of all such approvals to TI for its records. In the event that you fail to obtain any such approval or registration, you shall be solely responsible for any and all losses, damages or costs resulting therefrom, and shall indemnify TI for all such losses, damages or costs.
  - b) **Governing Language.** This Agreement is written and executed in the English language. If a translation of this Agreement is required for any purpose, including but not limited to registration of the Agreement pursuant to any governmental laws, regulations or rules, you shall be solely responsible for creating such translation. Any translation of this Agreement into a language other than English is intended solely in order to comply with such laws or for reference purposes, and the English language version shall be authoritative and controlling.

8. Entire Agreement. This is the entire Agreement between you and TI and supersedes any prior agreement between the parties related to the subject matter of this Agreement. No amendment or modification of this Agreement will be effective unless in writing and signed by a duly authorized representative of TI. You hereby warrant and represent that you have obtained all authorizations and other applicable consents required empowering you to enter into this Agreement.

Version: 221850v2

**PATLITE Corporation** G2J

<b>PATLITE Corporation</b> ※Head office	■ <a href="http://www.patlite.com/">www.patlite.com/</a>
<b>PATLITE (U.S.A.) Corporation</b>	■ <a href="http://www.patlite.com/">www.patlite.com/</a>
<b>PATLITE Europe GmbH</b> ※Germany	■ <a href="http://www.patlite.eu/">www.patlite.eu/</a>
<b>PATLITE (SINGAPORE) PTE LTD</b>	■ <a href="http://www.patlite-ap.com/">www.patlite-ap.com/</a>
<b>PATLITE (CHINA) Corporation</b>	■ <a href="http://www.patlite.cn/">www.patlite.cn/</a>
<b>PATLITE KOREA CO., LTD.</b>	■ <a href="http://www.patlite.co.kr/">www.patlite.co.kr/</a>
<b>PATLITE TAIWAN CO., LTD.</b>	■ <a href="http://www.patlite.tw/">www.patlite.tw/</a>
<b>PATLITE (THAILAND) CO., LTD.</b>	■ <a href="http://www.patlite.co.th/">www.patlite.co.th/</a>
<b>PATLITE MEXICO S.A. de C.V.</b>	■ <a href="http://www.patlite.com.mx/">www.patlite.com.mx/</a>