



Inverter

i510 protec frequency inverter

0.37 kW ... 5.5 kW

0.5 hp ... 7.5 hp

Contents

About this document	7
Document description	7
Further documents.....	7
Notations and conventions	8
Product information	9
Product description	9
Load characteristics.....	9
Features.....	10
Connections and interfaces	10
Topologies / network.....	10
Functions.....	11
Overview.....	11
Motor control types	12
Motor functions	12
Motor setting range	12
Identification of the products.....	14
Ways of commissioning.....	16
Information on project planning	17
Project planning process.....	17
Dimensioning	17
Operation in motor and generator mode.....	19
Overcurrent operation.....	20
Safety instructions	21
Basic safety instructions	21
Application as directed.....	22
Foreseeable misuse.....	22
Handling.....	23
Residual hazards.....	25
Decentralized topologies.....	26
Cables	26
Information on mechanical installation	27
Important notes.....	27
Preparation.....	27

Contents

Information on electrical installation	28
Important notes.....	28
Preparation.....	30
EMC-compliant installation.....	31
Connection according to UL.....	33
Important notes	33
Fusing data.....	34
Branch Circuit Protection (BCP).....	34
Mains connection	35
1-phase mains connection 120 V.....	36
1-phase mains connection 230/240 V.....	37
3-phase mains connection 230/240 V.....	38
3-phase mains connection 400 V.....	39
3-phase mains connection 480 V.....	40
Motor connection.....	40
Control connections.....	41
Networks.....	42
CANopen.....	42
Modbus RTU	43

Technical data	44
Standards and operating conditions.....	44
Conformities and approvals.....	44
Protection of persons and device protection.....	44
EMC data.....	44
Motor connection.....	45
Environmental conditions.....	45
Electrical supply conditions.....	45
1-phase mains connection 120 V.....	46
Rated data.....	47
Fusing data.....	49
Terminal data.....	49
1-phase mains connection 230/240 V.....	50
Rated data.....	51
Fusing data.....	54
Terminal data.....	54
1-phase mains connection 230/240 V "Light Duty".....	55
Rated data.....	56
Fusing data.....	58
Terminal data.....	58
3-phase mains connection 230/240 V.....	59
Rated data.....	60
Fusing data.....	63
Terminal data.....	64
3-phase mains connection 230/240 V "Light Duty".....	65
Rated data.....	66
Fusing data.....	68
Terminal data.....	68
3-phase mains connection 400 V.....	69
Rated data.....	69
Fusing data.....	72
Terminal data.....	73
3-phase mains connection 400 V "Light Duty".....	74
Rated data.....	74
Fusing data.....	76
Terminal data.....	76
3-phase mains connection 480 V.....	77
Rated data.....	77
Fusing data.....	80
Terminal data.....	81
3-phase mains connection 480 V "Light Duty".....	82
Rated data.....	82
Fusing data.....	84
Terminal data.....	84
Dimensions.....	84

Contents

Product extensions	89
Overview	89
I/O extensions.....	90
Standard I/O.....	90
Data of control connections.....	91
Further control connections.....	94
Relay output.....	94
Networks.....	95
CANopen.....	95
Modbus RTU	96
Accessories	97
Operation and diagnostics	97
Keypad	97
USB module.....	97
WLAN module.....	98
Memory modules	99
Memory module copier	99
Purchase order	100
Notes on ordering.....	100
Order code.....	101
Environmental notes and recycling	103
Appendix	104
Good to know.....	104
Approvals and directives.....	104
Operating modes of the motor.....	105
Motor control types	106
Switching frequencies.....	108
Enclosures.....	109
Glossary.....	109



About this document

Document description

This document is intended for all persons who want to configure inverters with the products described.

This document assists you with the configuration and selection of your product. It contains information on mechanical and electrical installation, on product expansions, and on accessories.

Further documents

For certain tasks, information is available in further documents.

Document	Contents/topics
Commissioning document	Setting and parameterising the inverters
Mounting and switch-on instructions	Basic information on mounting and initial switch-on of the product <ul style="list-style-type: none">• Is supplied with each component.

More information

For certain tasks, information is available in other media.

Medium	Contents/topics
Engineering Tools	For commissioning
AKB articles	Additional technical information for users in the Application Knowledge Base
CAD data	Download in different formats from the EASY Product Finder
EPLAN macros	Project planning, documentation and management of projects for EPLAN P8.
Device descriptions	Standardized files for network configuration



Information and tools with regard to the Lenze products can be found on the Internet:

www.Lenze.com → Downloads





About this document

Notations and conventions



Notations and conventions

Conventions are used in this document to distinguish between different types of information.

Numeric notation		
Decimal separator	Point	Generally shown as a decimal point. Example: 1 234.56
Warnings		
UL Warnings	UL	Are used in English and French.
UR warnings	UR	
Text		
Engineering Tools	" "	Software Example: "Engineer", "EASY Starter"
Icons		
Page reference		Reference to another page with additional information. Example:  16 = see page 16
Documentation reference		Reference to other documentation with additional information. Example:  EDKxxx = see documentation EDKxxx

Layout of the safety instructions

DANGER!

Indicates an extremely hazardous situation. Failure to comply with this instruction will result in severe irreparable injury and even death.

WARNING!

Indicates an extremely hazardous situation. Failure to comply with this instruction may result in severe irreparable injury and even death.

CAUTION!

Indicates a hazardous situation. Failure to comply with this instruction may result in slight to medium injury.

NOTICE

Indicates a material hazard. Failure to comply with this instruction may result in material damage.



Product information

Product description

The frequency inverters from the i500 protec series use the same tried-and-tested technology used in control cabinet inverters and only differ functionally in terms of a higher degree of housing protection with an adapted design. If your machine requires a lot of space, has a modular design, or the space in the control cabinet is limited, we recommend a decentralized installation close to the motor. The latest connection systems are available as accessories and offer a great deal of flexibility during installation, while maintaining compliance with the degree of protection. The inverters comply with the future EN 50598-2 standard.

Highlights

- 0.37 ... 5.5 kW with NEMA protection 1 (IP20)
- Versions with keypad, USB module or WLAN module for easy commissioning
- Industry standard fieldbus network options: [▶ Topologies / network](#) 10
- The "Light Duty" load characteristic enables a higher output current
- High internal functional range: [▶ Overview](#) 11

Application ranges

- Pumps and fans
- Conveying and travelling drives
- Forming and tool drives

Load characteristics

The inverters have two different load characteristics: "Light Duty" and "Heavy Duty".

The "Light Duty" load characteristic allows for a higher output current with restrictions regarding overload capacity, ambient temperature and switching frequency. This allows the motor required for the application to be driven by a less powerful inverter. Select the load characteristic according to the application.

	Heavy Duty	Light Duty
Characteristic	High dynamic requirements	Low dynamic requirements
Typical applications	Main tool drives, travelling drives, hoist drives, winders, forming drives and conveyors	Pumps, fans, general horizontal materials handling technology and line drives
Overload capacity	3 s/200 %, 60 s/150 % See technical data	Restricted See technical data

Product information

Features
Connections and interfaces



Features

Connections and interfaces

The following figure gives an overview of the elements and connections on the devices. Position, size and appearance of elements and connections may vary depending on the performance and size of the equipment.

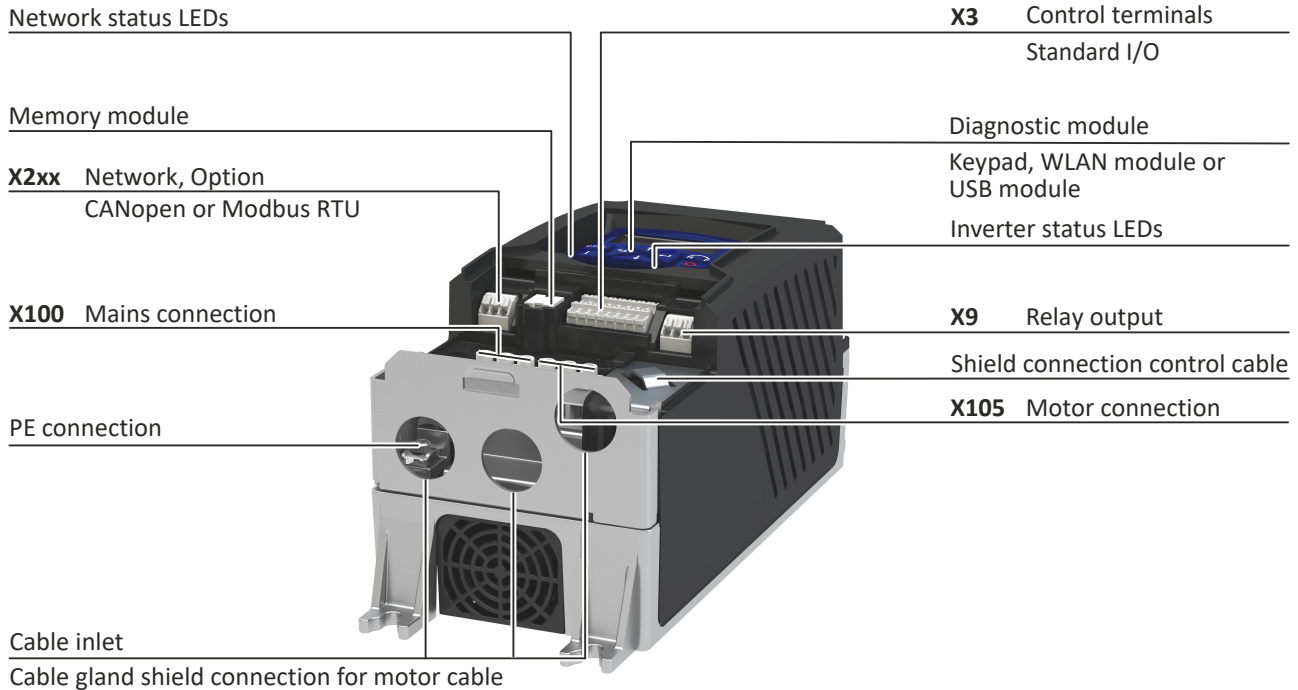

The i510 protec frequency inverters have these interfaces:



- Standard I/O:
 - 5x digital input
 - 1x digital output
 - 2x analog input
 - 1x analog output
 - PNP/NPN logic
 - Cycle time: 1 ms
- Frequency input: 0 ... 100 kHz
- 1x NO/NC relay (DC 24 V max. 2 A; AC 240 V max. 3 A)
- External 24 V supply and internal 24 V power supply unit
- Spring terminals
- Diagnostic interface (USB module or WLAN module required)

Topologies / network

The inverters can be equipped with different fieldbus networks.

The topologies and protocols typical for the prevailing networks are supported.

Currently available networks:

	CANopen® is a communication protocol based on CAN. CANopen® is a registered community trademark of the CAN user organisation CiA® (CAN in Automation e. V.). Device descriptions for the download: EDS files for Lenze devices
	The Modbus protocol is an open communication protocol based on a client/server architecture and developed for the communication with programmable logic controllers. Further development is carried out by the international user organisation Modbus Organization, USA.



Functions

Overview

The functions of the frequency inverters i510 protec are adapted to extensive applications.

Functions	
Motor control	Monitoring
V/f characteristic control linear/square-law (VFC plus)	Short circuit
V/f characteristic control (VFC closed loop)	Earth fault
Energy-saving function (VFC-Eco)	Device overload (ixt)
Sensorless vector control (SLVC)	Motor overload (i ² xt)
Sensorless control for synchronous motors (SL-PSM/SLSM-PSM)	Mains phase failure
Servo control for asynchronous motors (SC-ASM)	Stall protection
Motor functions	Motor current limit
Flying restart circuit	Maximum torque
Slip compensation	Ultimate motor current
DC braking	Motor speed
Oscillation damping	Load loss detection
Skip frequencies	Motor temperature
Automatic identification of the motor data	Diagnostics
Brake energy management	Error history buffer
Holding brake control	Logbook
"Voltage add" function	LED status displays
Rational Energy Ride Through (RERT)	Keypad language selection German, English
Speed feedback (HTL encoder)	Network
Brake resistor control (brake chopper integrated)	CANopen
Frequency setpoint	Modbus RTU
DC-bus connection (400V devices)	IO-Link
Application functions	EtherCAT
Process controller	EtherNet/IP
Access protection	Modbus TCP
Process controller - sleep mode and rinse function	PROFINET
Freely assignable favorite menu	Safety functions
Parameter change-over	Basic Safety - STO
S-shaped ramps for smooth acceleration	
Motor potentiometer	
Flexible I/O configuration	
Automatic restart	
OEM parameter set	
Complete control with 8-key keypad	
UPS operation	
Frequency output via digital output DO1	
Cascade function for pumps and fans	
"Light Duty" load characteristic can be adjusted for selected inverters.	

Product information

Functions
Motor control types



Motor control types

The following table contains the possible control types with Lenze motors.

Motors	V/f characteristic control VFCplus	Sensorless vector control SLVC	ASM servo control SC ASM
Three-phase AC motors			
MD	•	•	•
MF	•	•	•
mH	•	•	•
m500	•	•	•

Lenze synchronous servo motors are not suitable for use with inverters, e.g. the types MCS, MCM or m850.

Motor functions

Motor setting range

Rated point 120 Hz



Only possible with Lenze MF motors.

The rated motor torque is available up to 120 Hz.

Compared to the 50-Hz operation, the setting range increases by 2.5 times.

Thus, a smaller motor can be selected at the same rated power.

V/f at 120 Hz

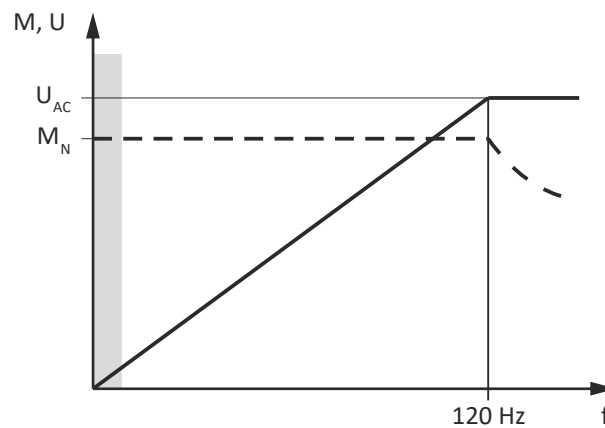

V Voltage
M Torque
f Frequency

U_{AC} Mains voltage
 M_N Rated torque



Rated point 87 Hz

The rated motor torque is available up to 87 Hz.

Compared to the 50-Hz operation, the setting range increases by 1.74 times.

For this purpose, a motor with 230/400 V in a triangle is driven by a 400 V inverter.

The inverter must be dimensioned for a rated motor current of 230 V.

V/f at 87 Hz

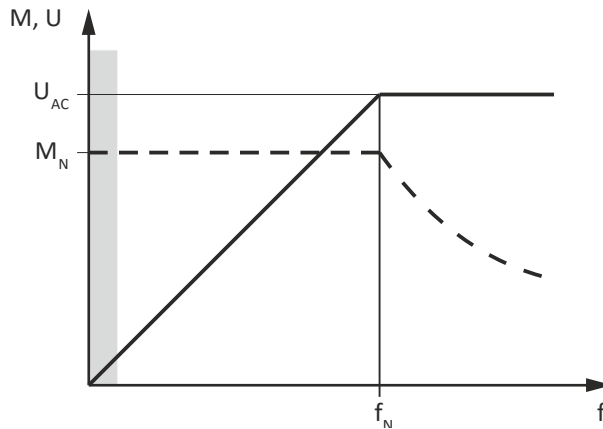

V Voltage
M Torque
f Frequency

U_{AC} Mains voltage
 M_{rated} Rated torque
 f_{rated} Rated frequency

Rated point 50 Hz

The rated motor torque is available up to 50 Hz.

V/f at 50 Hz

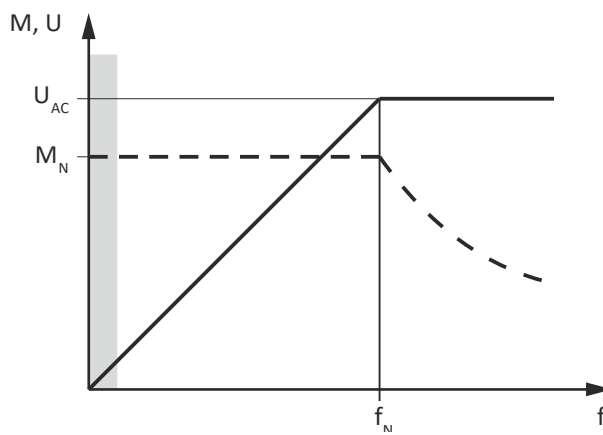

V Voltage
M Torque
f Frequency

U_{AC} Mains voltage
 M_{rated} Rated torque
 f_{rated} Rated frequency

Product information

Identification of the products



Identification of the products

Product name

The product name is used when listing the technical data of the various product variants and for the assignment of accessories. You can find the assignment of product names to order codes in chapter [Purchase order](#) 100.

The product name contains:

- the designation of the product range – e.g. i5xx
- the type – "P" for "protec" = inverter for decentralized mounting locations
- its power rating – in kW for the load characteristic "Heavy Duty"
- the mains voltage class – e.g. 120 V, 230 V or 400 V
- the number of mains phases – the 1/3-phase inverters are labelled with "-2".

Device series	Type	Rated power		Rated mains voltage	No. of phases	Inverter	Protection class
		Light Duty	Heavy Duty				
		kW	kW				
i510	P	-	0.37	120	1	i510-P0.37/120-1	IP20 NEMA 1
			0.75			i510-P0.75/120-1	

Device series	Type	Rated power		Rated mains voltage	No. of phases	Inverter	Protection class
		Light Duty	Heavy Duty				
		kW	kW				
i510	P	0.55	0.37	230	1/3	i510-P0.37/230-2	IP20 NEMA 1
		1.1	0.75			i510-P0.75/230-2	
		1.5	1.1			i510-P1.1/230-2	
		2.2	1.5			i510-P1.5/230-2	
		3	2.2			i510-P2.2/230-2	

Device series	Type	Rated power		Rated mains voltage	No. of phases	Inverter	Protection class
		Light Duty	Heavy Duty				
		kW	kW				
i510	P	0.55	0.37	240	1/3	i510-P0.37/230-2	IP20 NEMA 1
		1.1	0.75			i510-P0.75/230-2	
		1.5	1.1			i510-P1.1/230-2	
		2.2	1.5			i510-P1.5/230-2	
		3	2.2			i510-P2.2/230-2	
		4	3			i510-P3.0/230-3	
		5.5	4	i510-P4.0/230-3			
					3		

Device series	Type	Rated power		Rated mains voltage	No. of phases	Inverter	Protection class
		Light Duty	Heavy Duty				
		kW	kW				
i510	P	1.1	0.75	400	3	i510-P0.75/400-3	IP20 NEMA 1
		1.5	1.1			i510-P1.1/400-3	
		2.2	1.5			i510-P1.5/400-3	
		3	2.2			i510-P2.2/400-3	
		4	3			i510-P3/400-3	
		5.5	4			i510-P4/400-3	
		7.5	5.5			i510-P5.5/400-3	



Product information

Identification of the products

Device series	Type	Rated power		Rated mains voltage	No. of phases	Inverter	Protection class
		Light Duty	Heavy Duty				
		kW	kW	V			
i510	P	1.1	0.75	480	3	i510-P0.75/400-3	IP20 NEMA 1
		1.5	1.1			i510-P1.1/400-3	
		2.2	1.5			i510-P1.5/400-3	
		3	2.2			i510-P2.2/400-3	
		4	3			i510-P3/400-3	
		5.5	4			i510-P4/400-3	
		7.5	5.5			i510-P5.5/400-3	

Product code

		I	5	1	A	P	□□□	□	□	□	□	□	□	□	□	□	□	□
Product type	Inverter	I																
Product family	i500		5															
Product	i510			1														
Product generation	Generation 1				A													
Mounting type	Wall mounting					P												
Rated power (Examples)	0.37 kW						137											
	0.75 kW						175											
	2.2 kW						222											
Mains voltage and connection type	1/N/PE AC 120 V								A									
	3/PE AC 230/240 V								C									
	1/N/PE AC 230/240 V									D								
	3/PE AC 230/240 V																	
	3/PE AC 400 V									F								
Product variant	Standard																	
Integrated functional safety	Without safety function																	
Degree of protection	NEMA 1 (IP20), uncoated																	
Interference suppression	Without																	
Application area	Default parameter setting: Region EU (50-Hz networks)																	0
	Default parameter setting: Region US (60-Hz networks)																	1
Product extension	Standard I/O: ...																	0
	Keypad- module with Standard I/O ...																	K
	WLAN module with Standard I/O ...																	W
	... without network																	00S
	... with CANopen																	02S
... with Modbus RTU																	03S	

Product information

Ways of commissioning



Ways of commissioning

There are three ways to commission the inverter quickly and easily.

Thanks to Lenze's engineering philosophy, the high functionality is still easy to grasp. Parameterization and commissioning are a breeze thanks to clear structure and simple dialogs, leading to the desired outcome quickly and reliably.

Keypad

If it's only a matter of setting a few key parameters such as acceleration and deceleration time, this can be done quickly on the keypad.



»EASY Starter«

If functions such as the holding brake control or sequencer need to be set, it's best to use the »EASY Starter« engineering tool.



SMART Keypad App

The Lenze SMART Keypad App for Android or iOS allows you to diagnose and parameterize an inverter. A WLAN module on the inverter is required for communication.

- Ideal for the parameterization of simple applications such as a conveyor belt.
- Ideal for the diagnostics of the inverter.

The app can be found in the Google Play Store or in the Apple App Store.

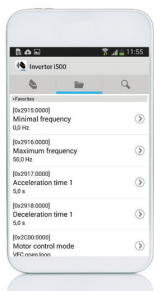

Android



iOS



Information on project planning

Project planning process

Dimensioning

3 methods for dimensioning

Fast: Selection of the inverter based on the motor data of a 4-pole asynchronous motor.

Detailed: In order to optimize the selection of the inverter and all drive components, it is worthwhile to execute the detailed system dimensioning based on the physical requirements of the application. For this purpose, Lenze provides the Drive Solution Designer (DSD) design program.

Manual: The following chapter guides you step by step through the selection of a drive system.

Workflow of a configuration process

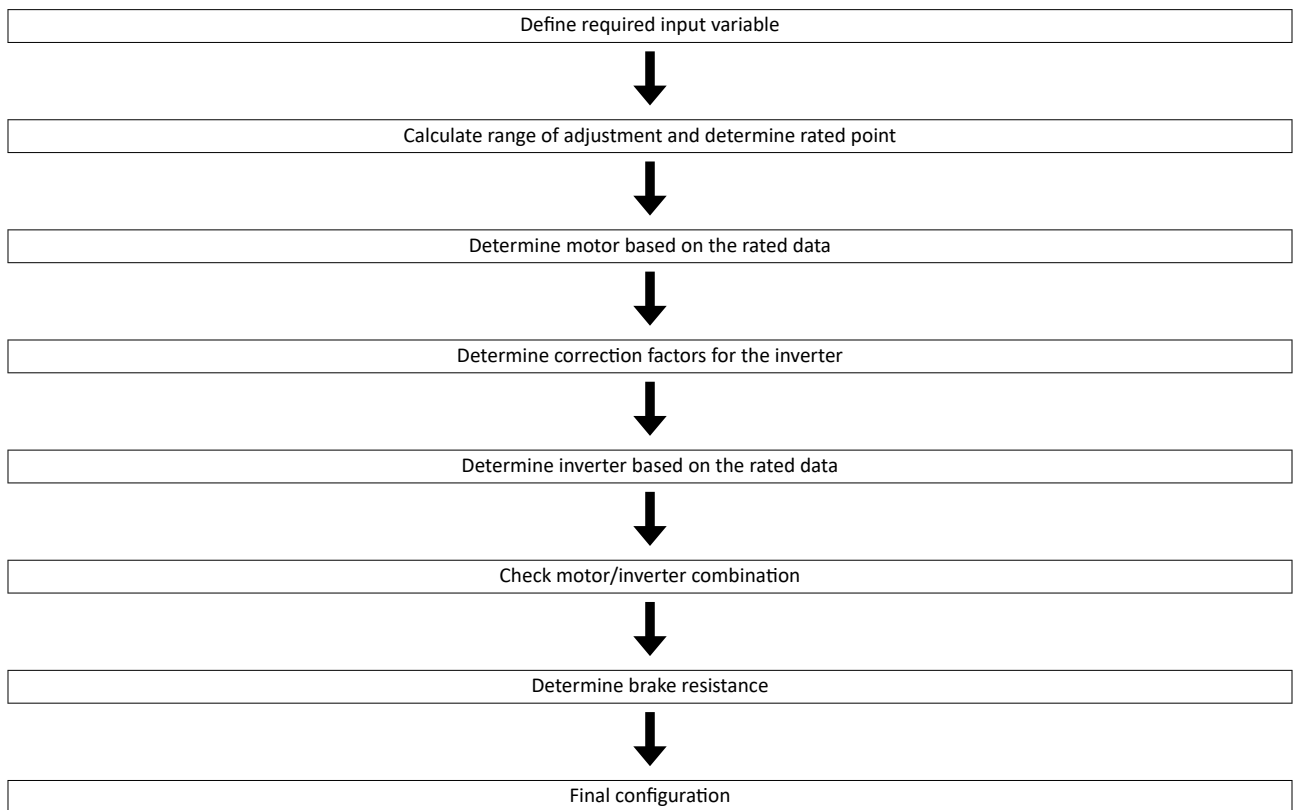

Define required input variables

Operating mode			S1 or S6
Max. load torque	$M_{L,max}$	Nm	
Max. load speed	$n_{L,max}$	rpm	
Min. load speed	$n_{L,min}$	rpm	
Site altitude	H	m	
Ambient temperature (inverter)	T_U	°C	

Information on project planning

Project planning process
Dimensioning



Calculate range of adjustment and determine rated point

	Calculation	
Setting range	$V = \frac{n_{L,max}}{n_{L,min}}$	
	Setting range	Rated point
Motor with integral fan	≤ 2.50 (20 - 50 Hz) ≤ 4.35 (20 - 87Hz) ≤ 6 (20 - 120Hz)	50 Hz 87 Hz 120 Hz
Motor with blower	≤ 10.0 (5 - 50 Hz)	50 Hz
Motor with integral fan (reduced torque)	≤ 17.4 (5 - 87Hz) ≤ 24 (5 - 120Hz)	87 Hz 120 Hz

Determine motor based on the rated data

			Check
Rated torque			
Operating mode S1	M_{rated}	Nm	$M_N \geq \frac{M_{L,max}}{T_{H,Mot} \times T_{U,Mot}}$
Operating mode S6	M_{rated}	Nm	$M_N \geq \frac{M_{L,max}}{2 \times T_{H,Mot} \times T_{U,Mot}}$
Rated speed	n_{rated}	rpm	$n_{rated} \geq n_{L,max}$ $\frac{n_n}{V} \leq n_{L,min}$

			Note
Rated torque	M_{rated}	Nm	→ Rated motor data
Rated speed	n_{rated}	rpm	
Rated point at		Hz	→ setting range
Power factor	$\cos \varphi$		→ Rated motor data
Rated current	$I_{N,MOT}$	A	
Rated power	P_{rated}	kW	
Correction factor - site altitude	$T_{H,MOT}$		→ Technical motor data
Correction factor - ambient temperature	$T_{U,MOT}$		
Select motor			

Correction factors for the inverter

Site altitude Amsl	H				
[m]	≤ 1000	≤ 2000	≤ 3000	≤ 4000	
$k_{H,INV}$	1.00	0.95	0.90	0.85	
Temperature in the control cabinet	T_U				
[°C]	≤ 40	≤ 45	≤ 50	≤ 55	
Switching frequency					
2 or 4 kHz	$k_{TU,INV}$	1.00	1.00	0.875	0.750
8 or 16 kHz		1.00	0.875	0.750	0.625
Switching frequency with the "Light Duty" load characteristic					
2 or 4 kHz	$k_{TU,INV}$	1.00	0.875	0.750	-
8 or 16 kHz		-	-	-	-

Determine the inverter based on the rated data

			Check
Output current			
Continuous operation	I_{out}	A	$I_{out} \geq I_{N,Mot} / (k_{H,INV} \times k_{TU,INV})$
Overcurrent operation cycle 15 s	I_{out}	A	$I_{out} \geq I_{N,Mot} \times 2 / (k_{H,INV} \times k_{TU,INV})$
Overcurrent operation cycle 180 s	I_{out}	A	$I_{out} \geq I_{N,Mot} \times 1.5 / (k_{H,INV} \times k_{TU,INV})$



Determine the inverter based on the rated data for the "Light Duty" load characteristic

			Check
Output current			
Continuous operation	I_{out}	A	$I_{out} \geq I_{N,Mot} / (k_{H,INV} \times k_{TU,INV})$
Overcurrent operation cycle 15 s	I_{out}	A	$I_{out} \geq I_{N,Mot} \times 1.65 / (k_{H,INV} \times k_{TU,INV})$
Overcurrent operation cycle 180 s	I_{out}	A	$I_{out} \geq I_{N,Mot} \times 1.25 / (k_{H,INV} \times k_{TU,INV})$

Check motor/inverter combination

			Calculation
Motor torque	M	Nm	$M = \sqrt{\left(\frac{I_{out,INV}}{I_{N,MOT}}\right)^2 - (1 - \cos^2\varphi)} \times \frac{M_N}{\cos\varphi}$

			Check
Inverter overload capacity			$\frac{M_{L,max}}{M} \leq 1.5$

Braking operation without additional measures

To decelerate small masses, the "DC injection brake DCB" function can be parameterised. DC-injection braking enables a quick deceleration of the drive to standstill without the need for an external brake resistor.

- A code can be used to select the braking current.
- The maximum braking torque to be realised by the DC braking current amounts to approx. 20 ... 30 % of the rated motor torque. It is lower compared to braking action in generator mode with external brake resistor.
- Automatic DC-injection braking (Auto-DCB) improves the starting performance of the motor when the operation mode without speed feedback is used.

Final configuration

Product extensions and accessories can be found here:

▶ [Product extensions](#) 89

▶ [Accessories](#) 97

Operation in motor and generator mode

The energy analysis differs between operation in motor mode and generator mode.

During operation in motor mode, the energy flows from the supplying mains via the inverter to the motor which converts electrical energy into mechanical energy (e. g. for lifting a load).

During operation in generator mode, the energy flows back from the motor to the inverter. The motor converts the mechanical energy into electrical energy - it acts as a generator (e. g. when lowering a load).

The drive brakes the load in a controlled manner.

The energy recovery causes a rise in the DC-bus voltage. If this voltage exceeds an upper limit, the output stage of the inverter will be blocked to prevent the device from being destroyed.

The drive coasts until the DC-bus voltage reaches the permissible value range again.

Information on project planning

Project planning process
Overcurrent operation



Overcurrent operation

The inverters can be driven at higher amperages beyond the rated current if the duration of this overcurrent operation is time limited.

Two utilisation cycles of 15 s and 180 s are defined. Within these utilisation cycles, an overcurrent is possible for a certain time if afterwards an accordingly long recovery phase takes place.

Cycle 15 s

During this operation, the inverter may be loaded for 3 s with up to 200 % of the rated current if afterwards a recovery time of 12 s with max. 75 % of the rated current is observed. A cycle corresponds to 15 s.

Cycle 180 s

During this operation, the inverter may be loaded for 60 s with up to 150 % of the rated current if afterwards a recovery time of 120 s with max. 75 % of the rated current is observed. A cycle corresponds to 180 s.

The monitoring of the device utilization (I_{xt}) triggers an error if the utilization value exceeds a threshold of 100 %.



The maximum output currents correspond to the switching frequencies and the overload behaviour of the inverters are given in the rated data.

In case of rotating frequencies < 10 Hz, the time-related overload behaviour may be reduced.

The graphics shows a cycle. The basic conditions given in the table (graphics field highlighted in grey) have to be complied with in order that the inverter will not be overloaded. Both cycles can be combined with each other.

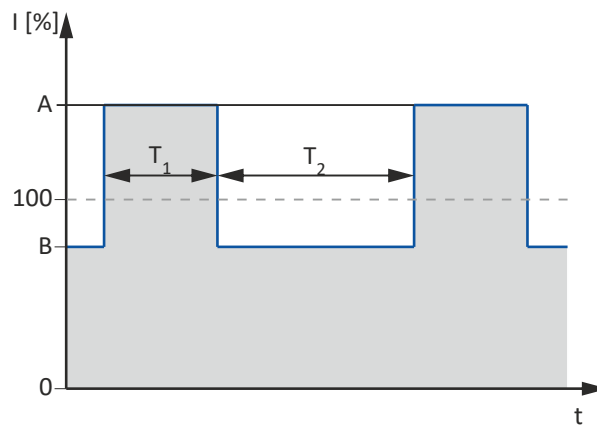

Cycle	Max. output current	Max. overload time	Max. output current during the Recovery time	Min. recovery time
	A	T_1	B	T_2
s	%	s	%	s
15	200	3	75	12
180	150	60	75	120



Safety instructions

Disregarding the following basic safety measures and safety information may lead to severe personal injury and damage to property!

Observe all specifications of the corresponding documentation supplied. This is the precondition for safe and trouble-free operation and for obtaining the product features specified.

Please observe the specific safety information in the other sections!

Basic safety instructions

DANGER!

Dangerous electrical voltage

Possible consequences: Death or severe injuries from electric shock

- ▶ Any work on the device must only be carried out in a deenergized state.
- ▶ After switching off the mains voltage, observe the signs on the product.

Product

- The product must only be used as directed.
- Never commission the product in the event of visible damage.
- The product must never be technically modified.
- Never commission the product before assembly has been completed.
- The product must never be operated without required covers.
- Connect/disconnect all pluggable terminals only in de-energized condition.
- Only remove the product from the installation in the de-energized state.

Personnel

Only qualified and skilled personnel are allowed to work with the product. IEC 60364 and/or CENELEC HD 384 define the qualifications of these persons as follows:

- They are familiar with the installation, mounting, commissioning, and operation of the product.
- They possess the appropriate qualifications for their tasks.
- They are familiar with all regulations for the prevention of accidents, directives, and laws applicable at the location and are able to apply them.

Process engineering

The procedural notes and circuit details described are only proposals. It is up to the user to check whether they can be adapted to the particular applications. Lenze does not take any responsibility for the suitability of the procedures and circuit proposals described.

Device protection

- The maximum test voltage for insulation tests between a control potential of 24 V and PE must not exceed 110 V DC (EN 61800-5-1).

Information on project planning

Safety instructions
Application as directed



Application as directed

- The product serves as a component for the control of three-phase AC motors and servo motors.
- The product must only be actuated with motors that are suitable for the operation with inverters.
- The product is not a household appliance, but is only designed as electrical equipment for commercial or professional use in terms of EN 61000-3-2.
- The product can be mounted in control cabinets or outside, depending on the protection class.
- The product must only be operated under the operating conditions prescribed in this documentation.
- The product meets the protection requirements of 2014/35/EU: Low-Voltage Directive.
- The product is not a machine in terms of 2006/42/EU: Machinery Directive.
- Commissioning or starting the operation as directed of a machine with the product is not permitted until it has been ensured that the machine meets the regulations of the EC Directive 2006/42/EU: Machinery Directive; observe EN 60204-1.
- Commissioning or starting operation as directed is only permissible if the EMC Directive 2014/30/EU is complied with.
- As the product may cause EMC interferences in residential areas, the operator is responsible for taking interference suppression measures.

Additional information for the intended use in North America:

The cables must be installed in accordance with US National Electrical Code NFPA 70 or Canadian Electrical Code C22.1.

Use of explosion-protected motors

Explosion-protected motors that are not designed for use with an inverter lose their approval if they are used for variable speed applications. Due to the many areas of liability that may arise when handling these applications, the following policy statement applies:



Lenze inverters are sold without warranty of suitability for use with explosion-protected motors. Lenze assumes no responsibility for direct, incidental or consequential damages, costs or losses that may result from the use of AC inverters with explosion-protected motors. Buyer expressly agrees to assume any risk of loss, expense or damage that may result from such application.

Foreseeable misuse

Inverters are not to be operated with DC motors.



Handling

Transport, storage

Observe the notes regarding transport, storage and correct handling. Ensure proper handling and avoid mechanical stress. Do not bend any components and do not change any insulation distances during transport or handling. Do not touch any electronic components and contacts. Inverters contain electrostatically sensitive components which can easily be damaged by inappropriate handling. Do not damage or destroy any electrical components since thereby your health could be endangered!

Installation

The technical data and supply conditions can be obtained from the nameplate and the documentation. They must be strictly observed.

The inverters must be installed and cooled according to the instructions given in the corresponding documentation. Observe the climatic conditions according to the technical data. The ambient air must not exceed the degree of pollution 2 according to EN 61800-5-1.

Electrical connection

When working on energized inverters, comply with the applicable national accident prevention regulations.

The electrical installation must be carried out according to the appropriate regulations (e. g. cable cross-sections, fuses, PE connection). Additional information can be obtained from the documentation.

The documentation contains information about installation according to EMC regulations (shielding, grounding, filters and cable routing). Please also observe this information for CE-marked inverters. The manufacturer of the system or machine is responsible for adherence to the limit values required in connection with EMC legislation. The inverters must be installed in housings (e. g. control cabinets) to meet the limit values for radio interferences valid at the site of installation. The housings must enable an EMC-compliant installation. Observe in particular that e. the control cabinet doors should have a circumferential metal connection to the housing. Reduce housing openings and cutouts to a minimum.

Protection in the event of short circuit or earth fault

To ensure protection in accordance with IEC 61800-5-1 in the event of an electrical short circuit or earth fault (protection against electric shock, thermal hazards and fire), the following must be taken into account in the installation:

- Use fuses according to the technical data.
- The installation must comply with the requirements of the IEC/HD 60364 (DIN VDE 0100; VDE 0100).
- The continuity of all associated protective conductors and equipotential bonding conductors including all connection points must be ensured.
- If the maximum permissible switch-off time according to IEC 60364-4-41 is exceeded with a high system impedance (especially with TT mains) or a high loop impedance with the prescribed fuses, a residual current device (RCD) can be used. Alternatively, other protective measures can be used, e. g. isolation from the environment by means of double or reinforced insulation, or isolation from the supply system by using a transformer.
- If a residual current device (RCD) is connected upstream of the inverter for protection in the event of an earth fault, only type B/B+ is permitted for 3-phase devices.

Operation

If necessary, systems including inverters must be equipped with additional monitoring and protection devices. Also comply with the safety regulations and provisions valid at the installation site.

After the inverter has been disconnected from the supply voltage, all live components and power terminals must not be touched immediately because capacitors can still be charged. Please observe the corresponding stickers on the inverter.

All protection covers and doors must be shut during operation.

Information on project planning

Safety instructions
Handling



You may adapt the inverters to your application by parameter setting within the limits available. For this, observe the notes in the documentation.

Maintenance and servicing

The inverters do not require any maintenance if the prescribed operating conditions are observed.

Disposal

In accordance with the current provisions, Lenze products and accessories have to be disposed of by means of professional recycling. Lenze products contain recyclable raw material such as metal, plastics and electronic components.



Residual hazards

Even if notes given are taken into consideration and protective measures are implemented, the occurrence of residual risks cannot be fully prevented.

The user must take the residual hazards mentioned into consideration in the risk assessment for his/her machine/system.

If the above is disregarded, this can lead to severe injuries to persons and damage to property!

Product

Observe the warning labels on the product!



Dangerous electrical voltage:

Before working on the product, make sure there is no voltage applied to the power terminals!

After mains disconnection, the power terminals will still carry the hazardous electrical voltage for the time given next to the symbol!



Electrostatic sensitive devices:

Before working on the product, the staff must ensure to be free of electrostatic charge!



High leakage current:

Carry out fixed installation and PE connection in compliance with:
EN 61800-5-1 / EN 60204-1



Hot surface:

Use personal protective equipment or wait until the device has cooled down!

Degree of protection - protection of persons and device protection

- Information applies to the mounted and ready-for-use state.

Protection of persons

Before working on the inverter, check if no voltage is applied to the power terminals.

- Depending on the device, the power terminals X105 remain live for up to 3 ... 20 minutes.
- The power terminals X100 and X105 remain live even when the motor is stopped.

Motor protection

With some settings of the inverter, the connected motor can be overheated.

- E. g. by longer operation of self-ventilated motors at low speed.
- E. g. by longer operation of DC-injection braking.

Protection of the machine/system

Drives can reach dangerous overspeeds.

- E. g. by setting high output frequencies in connection with motors and machines not suitable for this purpose.
- The inverters do not provide protection against such operating conditions. For this purpose, use additional components.

Switch contactors in the motor cable only if the controller is inhibited.

- Switching while the inverter is enabled is only permissible if no monitoring functions are activated.

Motor

If there is a short circuit of two power transistors, a residual movement of up to $180^\circ/\text{number of pole pairs}$ can occur at the motor! (e. g. 4-pole motor: residual movement max. $180^\circ/2 = 90^\circ$).

Information on project planning

Decentralized topologies
Cables



Decentralized topologies

The i510 protec frequency inverters support decentralized concepts for machines and electrical installation in particular.

Advantages

- Saves installation costs
 - Less expensive shielded motor cables, no EMC collective filters
 - Fewer circuit breakers, protection devices and mains cables
 - Fewer I/O gateways and cabling thanks to decentralized I/Os
 - Smaller control cabinet
- New solutions when less space is available
- Combination of functionally independent machine modules
- Less cooling units, higher efficiency

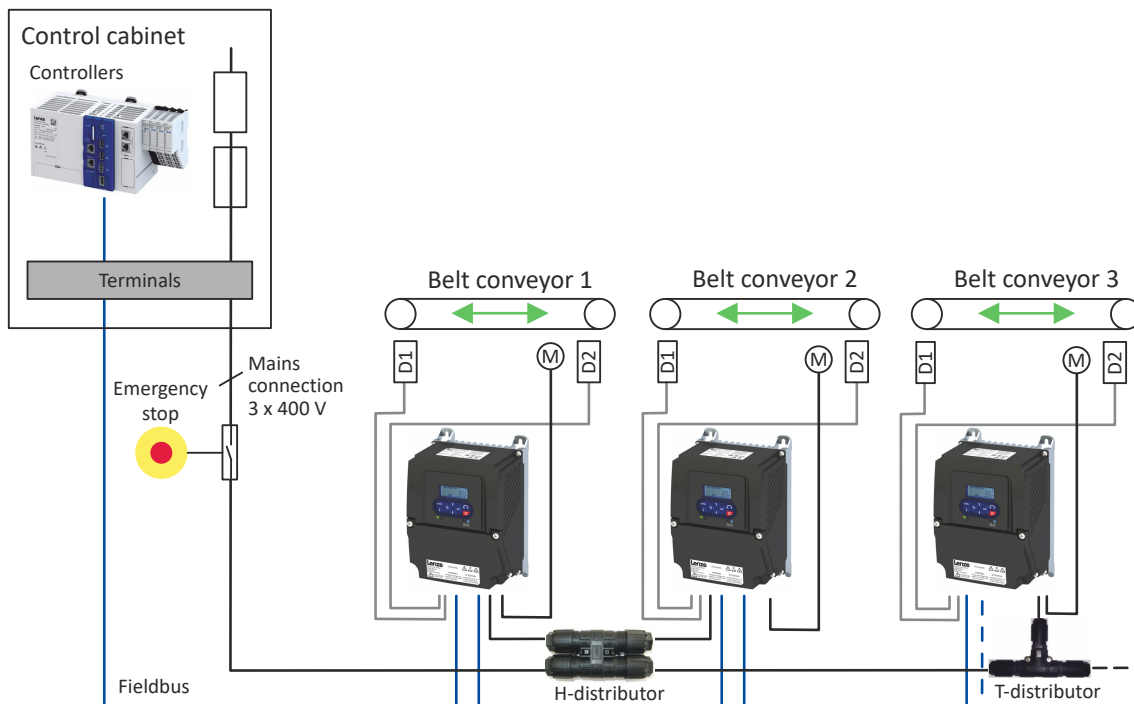

Fig. 1: Sample configuration

Cables

Requirements

- The cables used must correspond to the requirements at the location (e. g. EN 60204-1, UL).
- The cable cross-section must be dimensioned for the assigned fusing. Observe national and regional regulations.
- You must observe the regulations for minimum cross-sections of PE conductors. The cross-section of the PE conductor must be at least as large as the cross-section of the power connections.



Information on mechanical installation

Important notes

Measures for cooling during operation

- Ensure unimpeded ventilation of cooling air and outlet of exhaust air.

Preparation



Mounting instructions are included in the scope of supply of the inverter. They describe technical data and information on mechanical and electrical installation.

Mounting position

- Vertical alignment - do not interfere with free airflow from bottom to top of heatsink fins.
Other mounting positions require a reduction of the rated output values by approx. 1/3.
Your Lenze contact will help you with a precise assessment.

Free spaces

- Maintain the specified free spaces above and below to the other installations.
- A distance of 10 mm to the next device must be maintained at the sides.

Mechanical fastening

- The mounting location and material must ensure a durable mechanical connection.
- Do not mount onto DIN rails!
- In case of continuous vibrations or shocks use vibration dampers.

How to mount the inverters at a mounting location.

Required:

- Tool for drilling and thread cutting
- Screwdriver
- Screw and washer assemblies or hexagon socket screws with washers.

1. Prepare mounting area with corresponding threaded holes.
2. Fit screws and washers (if applicable).
3. Do not yet tighten the screws.
4. Mount the inverter on the prepared mounting area via keyhole suspension.
5. Only tighten the screws hand-tight.
6. Pre-assemble other devices if necessary.
 - a) Adjust the devices.
 - b) Screw the devices onto the mounting area.

The inverters are mounted on the mounting area. You can begin with the wiring.

Screw and washer assemblies or hexagon socket screws with washers are recommended..

M5 x \geq 10 mm

Further data and information

- ▶ [Decentralized topologies](#) 26
- ▶ [Dimensions](#) 84

Information on electrical installation

Important notes



Information on electrical installation

Important notes

DANGER!

Electrical voltage

Possible consequences: Death or severe injuries

- ▶ Any work on the inverter must only be carried out in the de-energized state.
- ▶ After switching off the mains voltage, wait for at least 3 min before you start working.

DANGER!

Dangerous electrical voltage

The leakage current against earth (PE) is > 3.5 mA AC or > 10 mA DC.

Possible consequences: Death or severe injuries when touching the device in the event of an error.

- ▶ Implement the measures requested in EN 61800-5-1 or EN 60204-1. Especially:
- ▶ Fixed installation
- ▶ The PE connection must comply with the standards (PE conductor diameter ≥ 10 mm² or use a double PE conductor)

WARNING!

Dangerous electrical voltage

Device error causes an overvoltage in the system.

- ▶ For a voltage supply with DC 24 V (± 20 %), use only a safely separated power supply unit according to the valid SELV/PELV requirements.

NOTICE

No protection against excessively high mains voltage

The mains input is not fused internally.

Possible consequences: Destruction of the product in the event of excessively high mains voltage.

- ▶ Take note of the maximum permissible mains voltage.
- ▶ On the mains supply side, use fuses to adequately protect the product against mains fluctuations and voltage peaks.

NOTICE

Overvoltage at devices with 230-V mains connection

An impermissible overvoltage may occur if the central supply of the N conductor is interrupted if the devices are connected to a TN three-phase system.

Possible consequences: Destruction of the device

- ▶ Provide for the use of isolating transformers.



NOTICE

Mounting not according to protection class

Possible consequences: Material damage due to penetrating humidity and foreign bodies.

- ▶ All cable glands and mounting parts must at least correspond to the protection class of the inverter.
 - ▶ All openings in the housing must be closed according to the protection class.
 - ▶ The cover must be screwed on with the specified tightening torque.
-

NOTICE

The product contains electrostatic sensitive devices.

Possible consequences: Destruction of the device

- ▶ Before working in the connection area, the personnel must be free of electrostatic charge.
-



When implementing machines and systems for the use in the UL/CSA scope, you have to observe the relevant special notes.

These notes are marked with "UL marking".

Information on electrical installation

Preparation



Preparation



Mounting instructions are included in the scope of supply of the inverter. They describe technical data and information on mechanical and electrical installation.

Remove housing cover and remount



For wiring, the housing cover must be removed and then remounted.

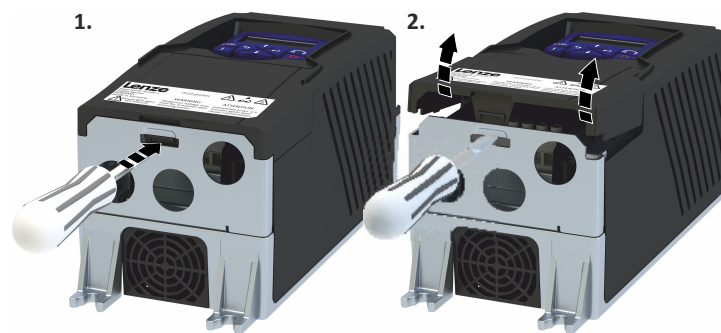

Remove housing cover

1. Press a screwdriver into the housing slot on the bottom of the device.
2. Remove housing cover

The terminals are exposed for wiring.

Mount housing cover

1. Carefully press on the housing cover until it clicks into place.
- The housing cover is mounted.

Cable glands and connection area

Bore holes are provided for mounting the cable glands for the mains cable and motor cable.

The cable gland of the motor cable must be EMC-compatible. The housing wall for the cable gland is reinforced and well conductive to avoid EMC interference.

Bore holes for cable glands

Power range	i510 protec
0.75 ... 11 kW	3 x ½" Conduit hub / 3 x M20

Further data and information

- ▶ [EMC-compliant installation](#) 31
- ▶ [Standards and operating conditions](#) 44



EMC-compliant installation

The drive system (inverter and drive) only complies with the EMC Directive 2014/30/EU if it is installed according to the guidelines for CE-typical drive systems.

These guidelines should also be followed in installations requiring FCC Part 15 or ICES 001 compliance.

NOTICE

Electromagnetic interferences

Product and peripheral devices may be affected during operation.

- ▶ Use integrated conductive shield connections for control lines and motor lines.
- ▶ Use central earthing points.



These inverters do not have an integrated RFI filter in the AC mains supply.

In order to meet the EMC requirements according to EN 61800-3, an external EMC filter according to IEC EN 60939 must be used.

The user must verify that the conformity with EN 61800-3 is fulfilled.

The example below shows the effective wiring:

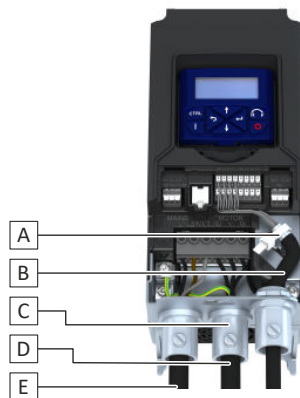

A Shield connection for control connections
B Control cable

C EMC cable gland / Conduit hub
D Motor cable with low capacity
E Mains cable

EMC-compliant installation must be carried out with shielded low-capacitance motor cables.

Capacitance per unit length:

- C-core-core/C-core-shield: $<75/150 \text{ pF/m} \leq 2.5 \text{ mm}^2$ ($\geq \text{AWG } 14$);
- C-core-core/C-core-shield: $<150/300 \text{ pF/m} \leq 4 \text{ mm}^2$ ($\geq \text{AWG } 12$);

When using electrically conductive conduits, unshielded motor cables or single cores can also be used.

Information on electrical installation

EMC-compliant installation



Example 1: Application without network

	$\leq 2.2 \text{ kW}$	
	$\geq 3 \text{ kW}$	

① ½" Conduit hub Mains cable at X100	② ½" Conduit hub Motor cable at X105	③ ½" Conduit hub Shielded control cable at X3 and X9
--	--	--

Example 2: Application with three-wire network

	$\leq 2.2 \text{ kW}$	
	$\geq 3 \text{ kW}$	

① ½" Conduit hub Mains cable at X100	② ½" Conduit hub Motor cable at X105	③ ½" Conduit hub Fieldbus cable at X2xx (The figure on the left shows two fieldbus cables to the previous/next device).
--	--	--



Connection according to UL

Important notes

⚠ WARNING!

- ▶ **UL marking**
- ▶ The integral solid state short circuit protection included in the inverter does not provide branch circuit protection. Branch circuit protection must be provided in accordance with the National Electrical Code / Canadian Electrical Code and any additional local codes.
- ▶ **Marquage UL**
- ▶ La protection statique intégrée contre les courts-circuits n'offre pas la même protection que le dispositif de protection du circuit de dérivation. Un tel dispositif doit être fourni, conformément au National Electrical Code / Canadian Electrical Code et aux autres dispositions applicables au niveau local.

⚠ WARNING!

- ▶ **UL marking**
- ▶ Use 75 °C copper wire only, except for control circuits.
- ▶ **Marquage UL**
- ▶ Utiliser exclusivement des conducteurs en cuivre 75 °C, sauf pour la partie commande.

⚠ WARNING!

- ▶ **UL marking**
- ▶ Suitable for motor group installation or use on a circuit capable of delivering not more than the RMS symmetrical amperes (SCCR) of the drive at its rated voltage.
- ▶ Approved fusing is specified in SCCR tables below.
- ▶ **Marquage UL**
- ▶ Convient pour l'utilisation sur une installation avec un groupe de moteurs ou sur un circuit capable de fournir au maximum une valeur de courant efficace symétrique en ampères à la tension assignée de l'appareil.
- ▶ Les dispositifs de protection adaptés sont spécifiés dans les SCCR tableaux suivants.

NOTICE

- ▶ **UL marking**
- ▶ The opening of the Branch Circuit Protective Device may be an indication that a fault has been interrupted. To reduce the risk of fire or electric shock, current carrying parts and other components of the controller should be examined and replaced if damaged. If burnout of the current element of an overload relay occurs, the complete overload relay must be replaced.
- ▶ **Marquage UL**
- ▶ Le déclenchement du dispositif de protection du circuit de dérivation peut être dû à une coupure qui résulte d'un courant de défaut. Pour limiter le risque d'incendie ou de choc électrique, examiner les pièces porteuses de courant et les autres éléments du contrôleur et les remplacer s'ils sont endommagés. En cas de grillage de l'élément traversé par le courant dans un relais de surcharge, le relais tout entier doit être remplacé.

Information on electrical installation

Connection according to UL
Fusing data



NOTICE

- ▶ **UL marking**
- ▶ Internal overload protection rated for 125 % of the rated FLA.
- ▶ **Marquage UL**
- ▶ Protection contre les surcharges conçue pour se déclencher à 125 % de l'intensité assignée à pleine charge.

Fusing data

Branch Circuit Protection (BCP)

Short Circuit Current Ratings (SCCR) with Standard Fuses and Circuit Breaker

(Tested per UL61800-5-1, reference UL file E132659)

These devices are suitable for motor group installation when used with Standard Fuses or Circuit Breaker. For single motor installation, if the fuse value indicated is higher than 400 % of the motor current (FLA), the fuse value has to be calculated. If the value of the fuse is below two standard ratings, the nearest standard ratings less than the calculated value shall apply.

Inverter			Standard Fuses (UL248)			Circuit Breaker (UL489)	
Mains	Rated power		Max. SCCR	Max. rated current	Class	Max. SCCR	Max. rated current
	kW	hp	kA	A		kA	A
120 V, 1-ph	0.37	0.5	5	30	CC, CF, J, T	5	30
120 V, 1-ph	0.75	1	5	30	CC, CF, J, T	5	30
230 V, 1/3-ph	0.37	0.5	42	25	CC, CF, J, T	5	
230 V, 1/3-ph	0.75	1	42	25	CF, J, T	5	
230 V, 1/3-ph	1.1	1.5	42	25	CF, J, T	5	
230 V, 1/3-ph	1.5	2	42	25	CF, J, T	5	
230 V, 1/3-ph	2.2	3	42	50	CF, J, T	5	30
230 V, 3-ph	3	4	42	60	CF, J, T	5	30
230 V, 3-ph	4	5	42	60	CF, J, T	5	30
480 V, 3-ph	0.75	1	65	50	CF, J, T	5	30
480 V, 3-ph	1.1	1.5	65	50	CF, J, T	5	30
480 V, 3-ph	1.5	2	65	50	CF, J, T	5	30
480 V, 3-ph	2.2	3	65	50	CF, J, T	5	30
480 V, 3-ph	3	4	5	40	CF, J, T	5	30
480 V, 3-ph	4	5	5	40	CF, J, T	5	30
480 V, 3-ph	5.5	7.5	5	40	CF, J, T	5	30



Mains connection

Single inverters are connected directly to the **AC system** or via upstream filters. RFI filters are already integrated in many inverters. Depending on the requirements, mains chokes or mains filters can be used.

Information on electrical installation

Mains connection
1-phase mains connection 120 V



1-phase mains connection 120 V

The connection plan is valid for the inverters i510-Pxxx/120-1.



Inverter i510-Pxxx/120-1 do not have an integrated RFI filter in the AC mains supply.

In order to meet the EMC requirements according to EN 61800-3, an external EMC filter according to IEC EN 60939 must be used.

The user must verify that the conformity with EN 61800-3 is fulfilled.

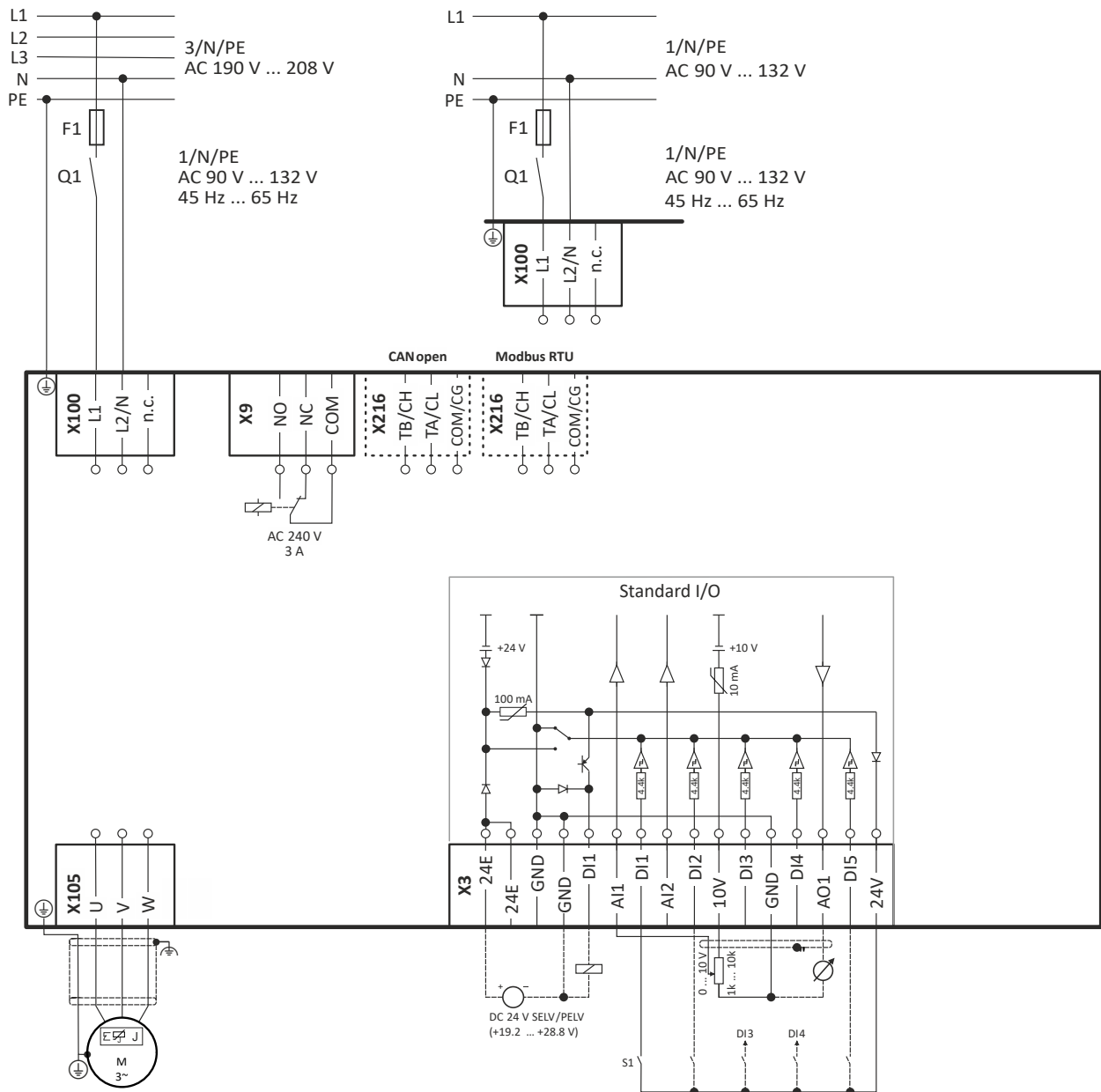

Fig. 2: Wiring example

S1 Start/Stop
Fx Fuses

Q1 Mains contactor
--- Dashed line = options



Information on electrical installation

Mains connection
1-phase mains connection 230/240 V

1-phase mains connection 230/240 V

The connection plan is valid for the inverters i510-Pxxx/230-2.

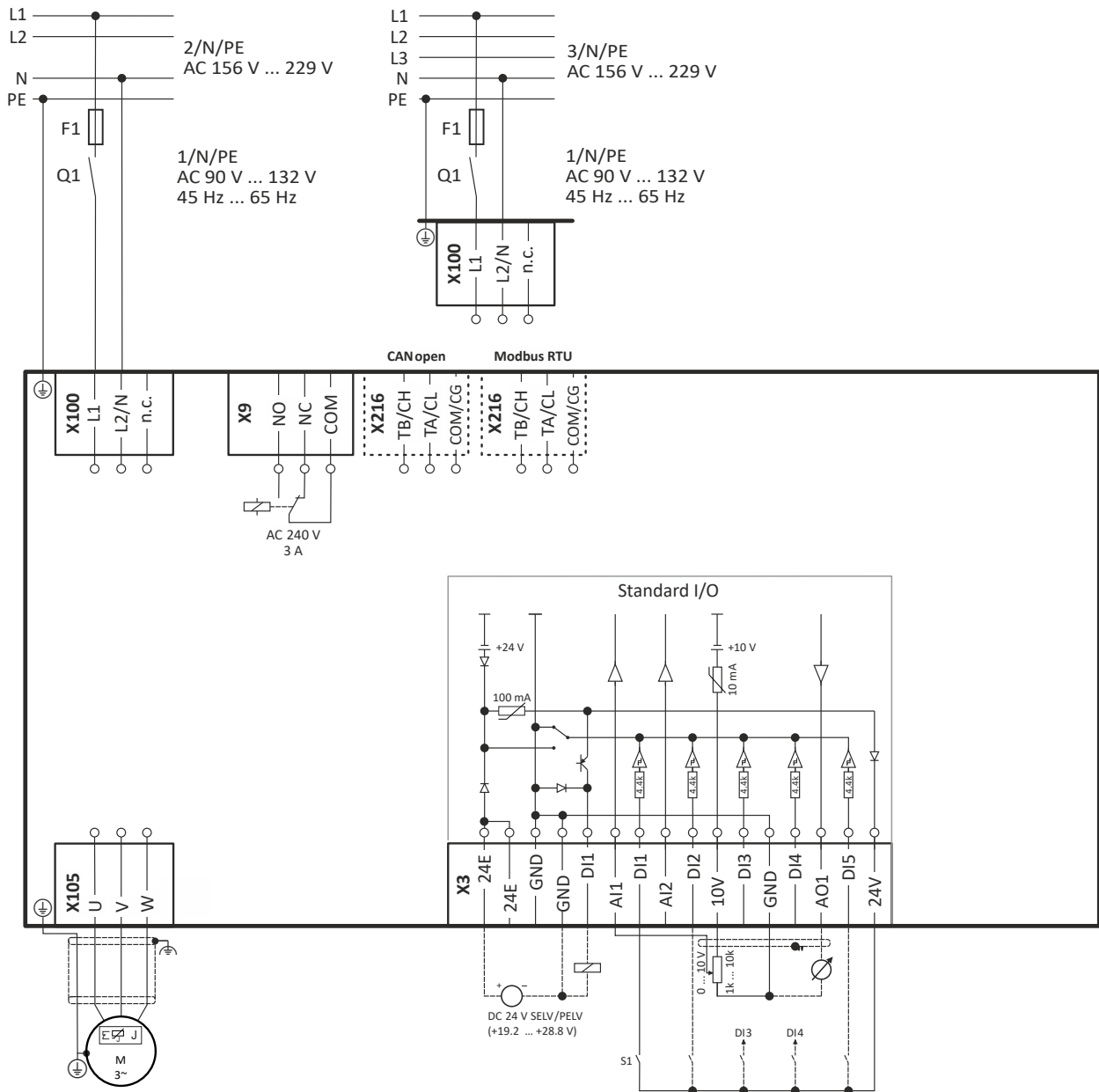

Fig. 3: Wiring example

S1 Start/Stop
Fx Fuses

Q1 Mains contactor
--- Dashed line = options

Information on electrical installation

Mains connection
3-phase mains connection 230/240 V



3-phase mains connection 230/240 V

The connection plan is valid for the inverters i510-Pxxx/230-3 and i510-Pxxx/230-2.



Inverter i510-Pxxx/230-3 and i510-Pxxx/230-2 do not have an integrated RFI filter in the AC mains supply.

In order to meet the EMC requirements according to EN 61800-3, an external EMC filter according to IEC EN 60939 must be used.

The user must verify that the conformity with EN 61800-3 is fulfilled.

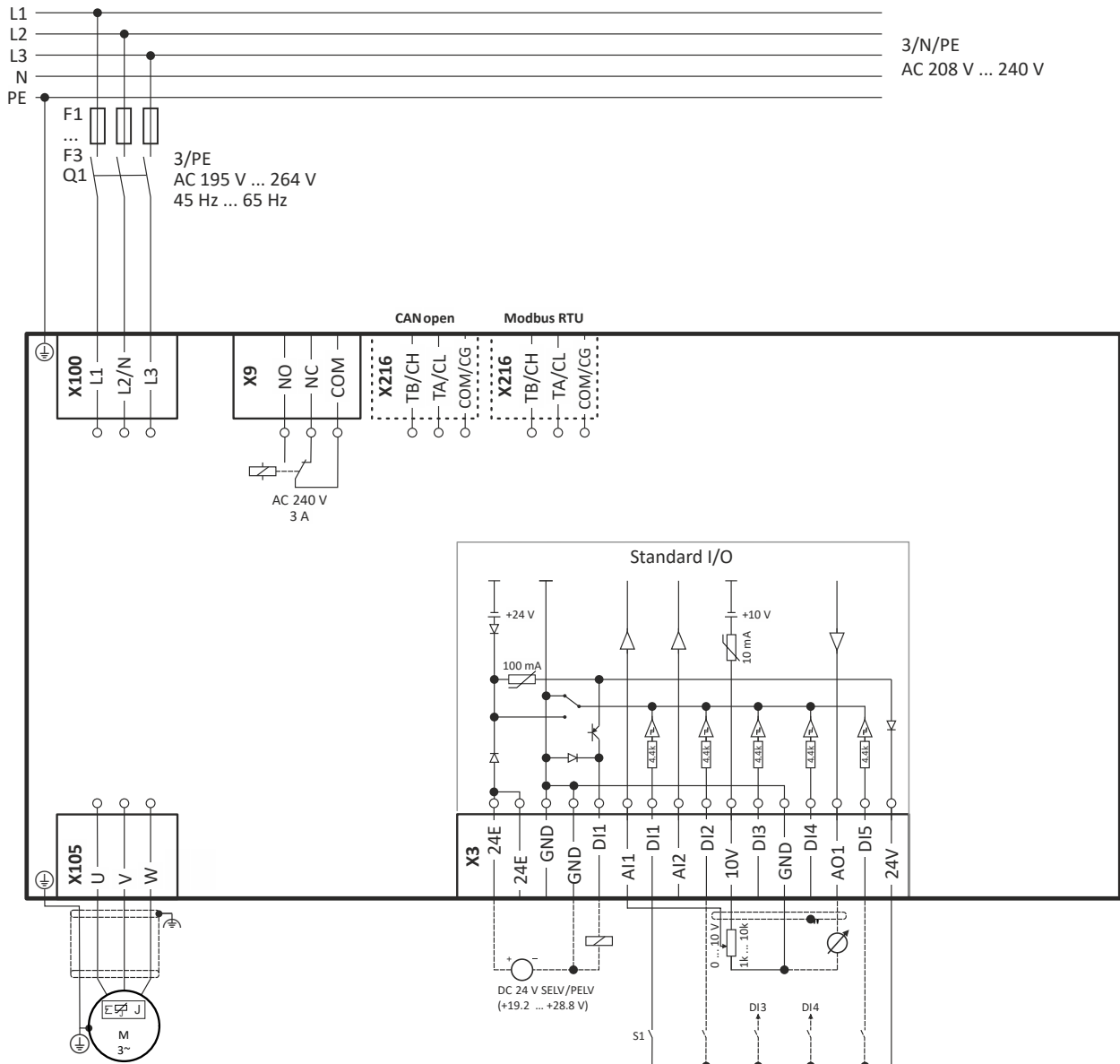

Fig. 4: Wiring example

S1 Start/Stop
Fx Fuses

Q1 Mains contactor
--- Dashed line = options



Information on electrical installation

Mains connection
3-phase mains connection 400 V

3-phase mains connection 400 V

The connection plan is valid for the inverters i510-Pxxx/400-3.

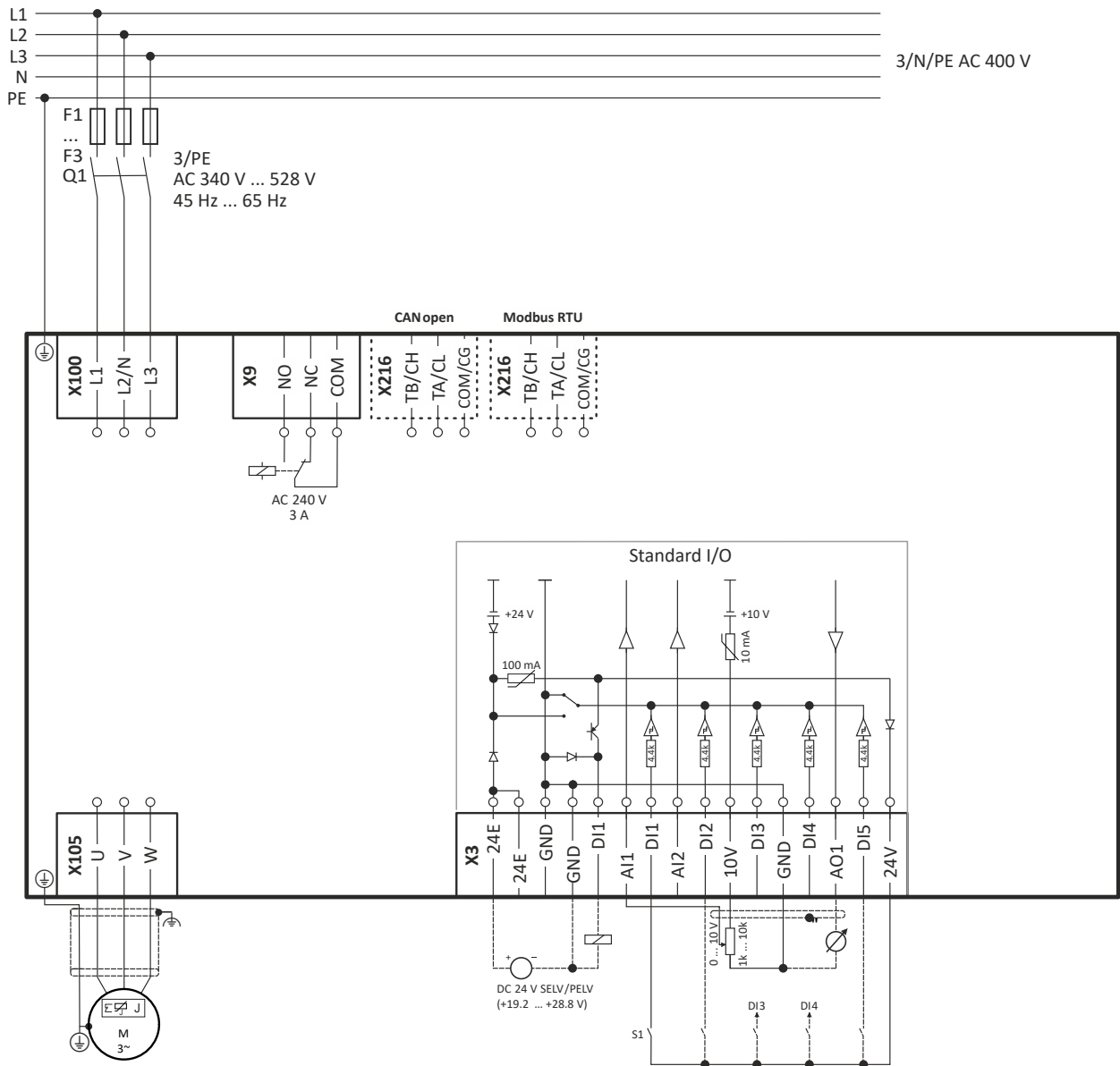

Fig. 5: Wiring example

S1 Start/Stop
Fx Fuses

Q1 Mains contactor
--- Dashed line = options

Information on electrical installation

Motor connection
3-phase mains connection 480 V



3-phase mains connection 480 V

The connection plan is valid for the inverters i510-Pxxx/400-3.

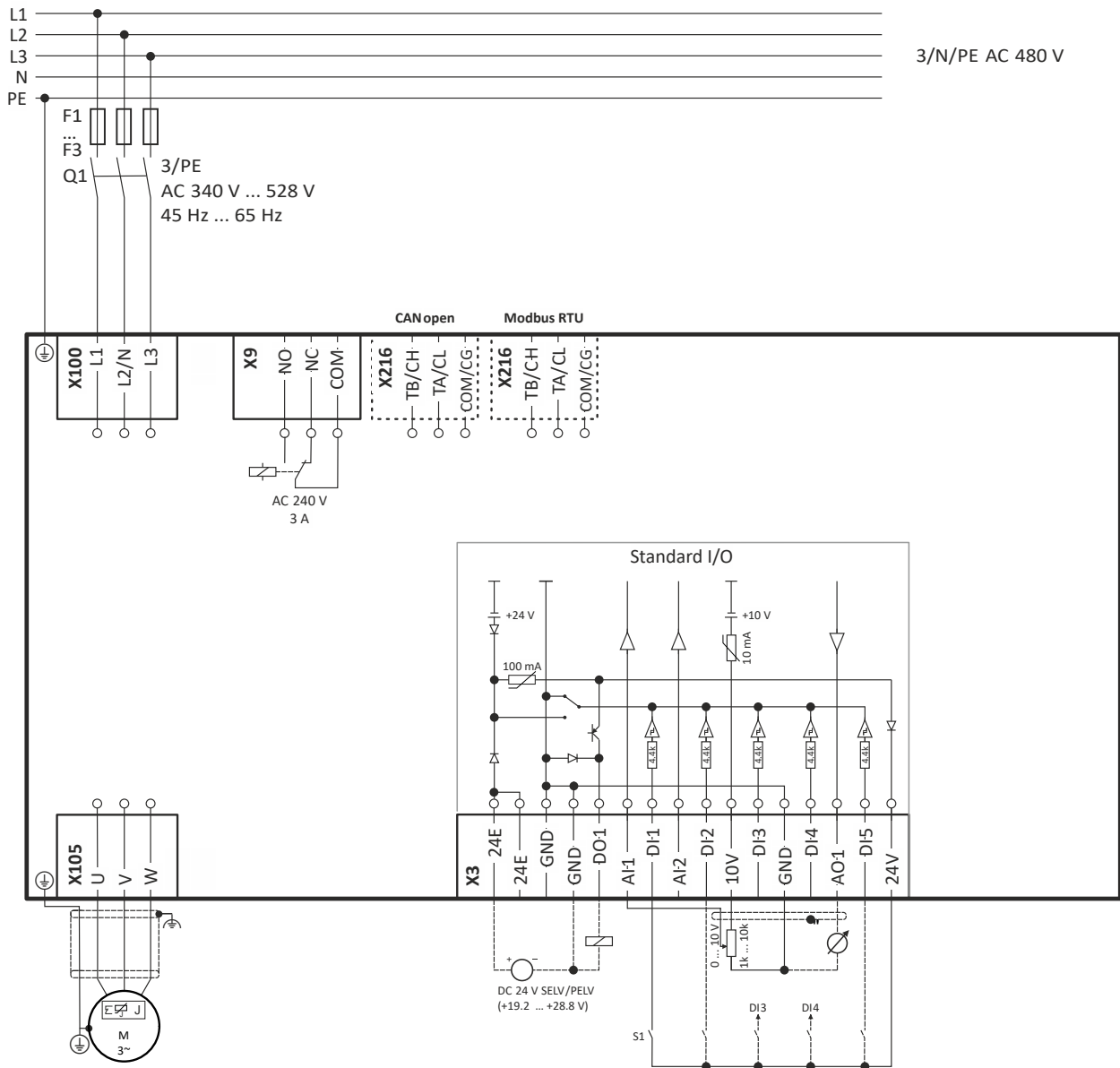

Fig. 6: Wiring example

- | | | | |
|----|------------|-----|-----------------------|
| S1 | Start/Stop | Q1 | Mains contactor |
| Fx | Fuses | --- | Dashed line = options |

Motor connection

Switching in the motor cable



Switching on the motor side of the inverter is permissible:

For safety shutdown (emergency stop).

In case several motors are driven by one inverter (only in V/f operating mode).

Please note the following:

The switching elements on the motor side must be dimensioned for with the maximum occurring load.



Control connections



In case of long cables and/or high interference the effect of the shielding can be improved. To do this, connect the shield of cables for the analog inputs and outputs at one end of the cable via a capacitor with PE potential (e. g. 10 nF/ 250 V).

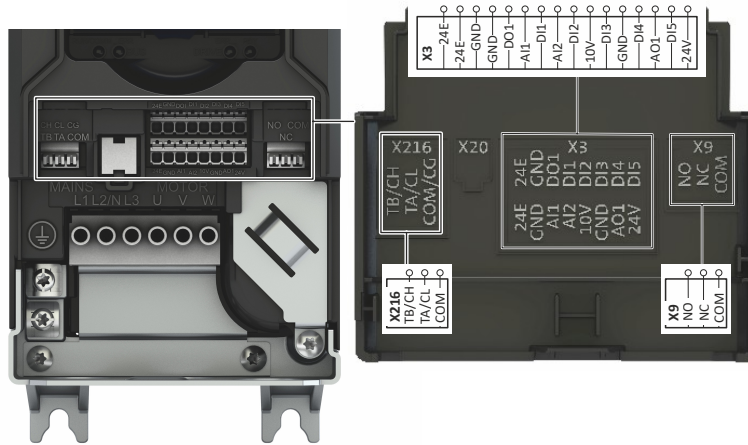

The designations of the terminals X216, X3 and X9 are located on the inside of the cover.

Connection description			Control terminals	Relay output
Connection			X3	X9
Connection type			Non-pluggable	Non-pluggable
Max. cable cross-section		mm ²	1.5	1.5
Max. cable cross-section		AWG	16	16
Stripping length		mm	9	9
Stripping length		in	0.35	0.35
Required tool			Screwdriver 0.4 x 2.5	

Information on electrical installation

Networks
CANopen



Networks

CANopen



The network must be terminated with a 120 Ω resistor at the physically first and last node.

Connect the resistor to terminals TB/CH and TA/CL.

Typical topologies

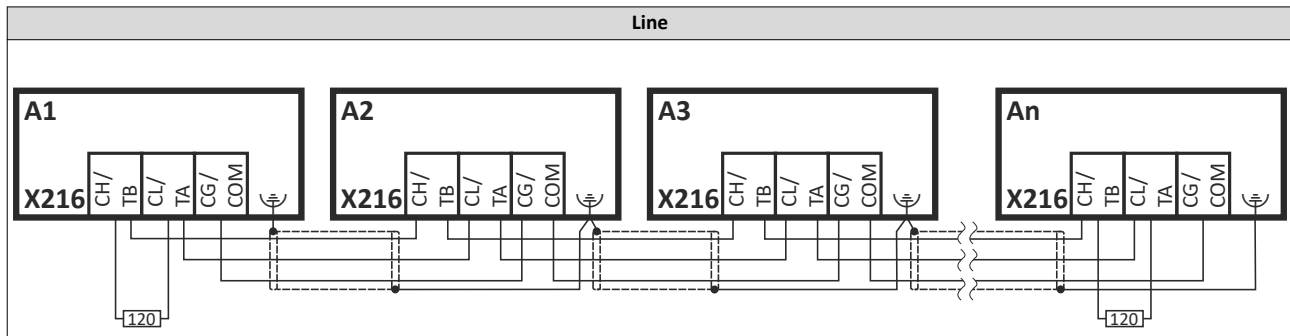

Connection description	CANopen		
Connection	X216		
Connection type	Non-pluggable		
Max. cable cross-section	mm ²	1.5	
Max. cable cross-section	AWG	16	
Stripping length	mm	9	
Stripping length	in	0.35	
Required tool	Screwdriver 0.4 x 2.5		



Information on electrical installation

Networks
Modbus RTU

Modbus RTU



The network must be terminated with a 120 Ω resistor at the physically first and last node.

Connect the resistor to terminals TB/CH and TA/CL.

Typical topologies

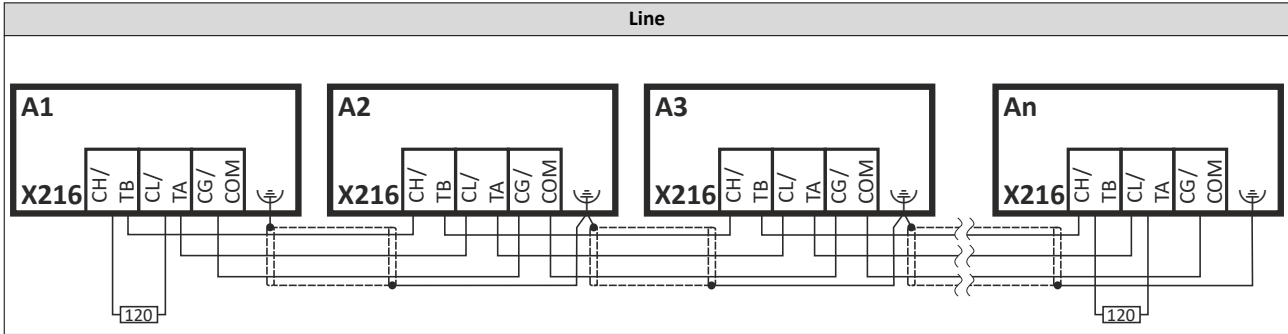

Connection description		Modbus RTU	
Connection			X216
Connection type			Non-pluggable
Max. cable cross-section	mm ²		1.5
Max. cable cross-section	AWG		16
Stripping length	mm		9
Stripping length	in		0.35
Required tool			Screwdriver 0.4 x 2.5

Technical data

Standards and operating conditions
Conformities and approvals



Technical data

Standards and operating conditions

Conformities and approvals

Conformities			
CE	2014/30/EU		EMC Directive (reference: CE-typical drive system)
	2014/35/EU		Low-Voltage Directive
EAC	TP TC 020/2011		Eurasian conformity: Electromagnetic compatibility of technical means
	TP TR 004/2011		Eurasian conformity: Safety of low voltage equipment
RoHS	2011/65/EU		Restrictions on the use of certain hazardous substances in electrical and electronic devices
Approvals			
UL	UL 61800-5-1		File No. E132659
			for USA and Canada (requirements of the CSA 22.2 No. 274)

Protection of persons and device protection

Degree of protection			Information applies to the mounted and ready-for-use state
EN	EN 60529	IP20	
NEMA	NEMA 250	Type 1	
UL	UL 50		
Insulation resistance			
Overvoltage category	EN 61800-5-1	II	> 2000 m ü. NN
		III	0 ... 2000 m ü. NN
Insulation of control circuits			
	EN 61800-5-1	Safe mains isolation	double/reinforced insulation
Leakage current			
AC	EN 61800-5-1	> 3.5 mA	Please observe regulations and safety instructions!
DC		> 10 mA	
Starting current			
		≤ 3 x rated mains current	
Protective measures			
Earth fault resistance			Earth-fault protected depending on operating status
Motor stall protection			
Short-circuit strength			
Overvoltage resistance			
Overtemperature of motor			I ² t monitoring

EMC data

Operation on public supply systems			The machine or system manufacturer is responsible for compliance with the requirements for the machine/system!
> 1 kW, mains current ≤ 16 A	EN 61000-3-2	no additional measures	
< 1kW		with mains choke	
Mains current > 16 A	EN 61000-3-12	With mains choke or mains filter	When designed for rated power.
Noise emission			
Category C1	EN 61800-3		See rated data
Category C2			
Category C3			
Noise immunity			
	EN 61800-3	Requirements fulfilled	



Motor connection

Requirements for the shielded motor cable			
Capacitance per unit length		< 150/300 pF/m	C core-core/C core-shield ≤ 4 mm ² / AWG 12
		< 75/150 pF/m	C core-core/C core-shield ≤ 2.5 mm ² / AWG 14
Electric strength		U ₀ /U = 0.6/1.0 kV	U = r.m.s. value from external conductor to external conductor
			U ₀ = r.m.s. value external conductor to PE
	UL	U ≥ 600 V	U = r.m.s. value from external conductor to external conductor

Environmental conditions

Energy efficiency			
High Efficiency	EN 50598-2	Class IE2	
Climate			
Storage	EN 60721-3-1	1K3 (-30 ... +60 °C)	
Transport	EN 60721-3-2	2K3 (-30 ... +70 °C)	
Operation	EN 60721-3-3	3K3 (-30 ... +55 °C)	Operation at a switching frequency of 2 or 4 kHz: Above +45°C: reduce rated output current by 2.5 %/°C
			Operation at a switching frequency of 8, 12 or 16 kHz: Above +40°C: reduce rated output current by 2.5 %/°C
Site altitude			
0 ... 1000 m ü. NN			
1000 ... 4000 m ü. NN			Reduce rated output current by 5 %/1000 m
Pollution			
	EN 61800-5-1	Degree of pollution 2	
	UL 61800-5-1		
Vibration resistance			
Transport	EN 60721-3-2	2M2 (sine, shock)	in original packaging
Operation	EN 61800-5-1	Amplitude 0.075 mm	10 ... 57 Hz
		acceleration resistant up to 1 g	57 ... 150 Hz
	German Lloyd	Amplitude 1 mm	5 ... 13.2 Hz
		acceleration resistant up to 0.7 g	13.2 ... 100 Hz

Electrical supply conditions

Power systems			
TN			Voltage to earth: max. 300 V
TT			

The connection to different supply forms enables a worldwide application of the inverters.

The following is supported:

- [1-phase mains connection 120 V](#) 46
- [1-phase mains connection 230/240 V](#) 50
- [1-phase mains connection 230/240 V "Light Duty"](#) 55
- [3-phase mains connection 230/240 V](#) 59
- [3-phase mains connection 230/240 V "Light Duty"](#) 65
- [3-phase mains connection 400 V](#) 69
- [3-phase mains connection 400 V "Light Duty"](#) 74
- [3-phase mains connection 480 V](#) 77
- [3-phase mains connection 480 V "Light Duty"](#) 82

Technical data

1-phase mains connection 120 V



1-phase mains connection 120 V



EMC filters are **not integrated** in inverters for this mains connection.



Technical data

1-phase mains connection 120 V
Rated data

Rated data

The output currents apply to these operating conditions:

- At switching frequency 2 kHz or 4 kHz: Ambient temperature max. 45 °C (113 °F).
- At switching frequency 8 kHz, 12 kHz or 16 kHz: Ambient temperature max. 40 °C (104 °F).

Technical data

1-phase mains connection 120 V

Rated data



Inverter			i510-P0.37/120-1	i510-P0.75/120-1
Rated power	P_{rated}	kW	0.37	0.75
Rated power	P_{rated}	hp	0.5	1
Mains voltage range			1/PE AC 90 V ... 132 V, 45 Hz ... 65 Hz	
Output voltage			3 AC 0 - 230/240 V	
Rated mains current				
without mains choke		A	9.6	16.8
with mains choke		A	-	
Apparent output power		kVA	0.9	1.6
Rated output current				
2 kHz		A	2.4	4.2
4 kHz		A	2.4	4.2
8 kHz		A	2.4	4.2
12 kHz		A	2.2	3.8
16 kHz		A	1.6	2.8
Power loss				
2 kHz		W	19	30
4 kHz		W	20	32
8 kHz		W	24	40
12 kHz		W	23	38
16 kHz		W	22	35
Overcurrent cycle 180 s				
Max. output current		A	3.6	6.3
Overload time	T_1	s	60	60
Recovery time	T_2	s	120	120
Max. output current during the recovery time		A	1.8	3.2
Overcurrent cycle 15 s				
Max. output current		A	4.8	8.4
Overload time	T_1	s	3	3
Recovery time	T_2	s	12	12
Max. output current during the recovery time		A	1.8	3.2
Cyclic mains switching			3 times per minute	
Brake chopper				
Max. output current			-	
Min. brake resistance			-	
Max. motor cable length shielded				
without EMC category		m	30	
Category C1 (2 kHz, 4 kHz, 8 kHz)		m	-	
Category C2 (2 kHz, 4 kHz, 8 kHz)		m	-	
Category C3 (2 kHz, 4 kHz, 8 kHz)		m	-	
Max. motor cable length unshielded				
without EMC category		m	60	



Fusing data



A residual current device (RCD) is optional.

Fusing data for UL/NEC compliant installations: [▶ Fusing data](#) 34

Inverter	Fuse		Circuit breaker		RCD	
	Characteristic	Max. rated current	Characteristic	Max. rated current	mA	Type
		A		A		
i510-P0.37/120-1	gG/gL, gRL	32	B	32	≥30	Typ B
i510-P0.75/120-1	gG/gL, gRL	32	B	32	≥30	Typ B

Terminal data

Rated power	P _{rated}	kW	0.37 ... 0.75
Connection description			Mains connection
Connection			X100
Connection type			Pluggable
Max. cable cross-section		mm ²	4
Max. cable cross-section		AWG	10
Stripping length		mm	8
Stripping length		in	0.3
Tightening torque		Nm	0.6
Tightening torque		lb-in	5.3
Required tool			Screwdriver 0.5 x 3.0

Rated power	P _{rated}	kW	0.37 ... 0.75
Connection description			PE connection
			-
Max. cable cross-section		mm ²	6
Max. cable cross-section		AWG	10
Stripping length		mm	10
Stripping length		in	0.4
Tightening torque		Nm	2
Tightening torque		lb-in	18
Required tool			Torx key 20

Rated power	P _{rated}	kW	0.37 ... 0.75
Connection description			Motor connection
Connection			X105
Connection type			Pluggable
Max. cable cross-section		mm ²	4
Max. cable cross-section		AWG	10
Stripping length		mm	8
Stripping length		in	0.3
Tightening torque		Nm	0.6
Tightening torque		lb-in	5.3
Required tool			Screwdriver 0.5 x 3.0

Technical data

1-phase mains connection 230/240 V



1-phase mains connection 230/240 V



EMC filters are **not integrated** in inverters of the type "i550-Px.xx/230-2".



Technical data

1-phase mains connection 230/240 V
Rated data

Rated data

The output currents apply to these operating conditions:

- At switching frequency 2 kHz or 4 kHz: Ambient temperature max. 45 °C (113 °F).
- At switching frequency 8 kHz, 12 kHz or 16 kHz: Ambient temperature max. 40 °C (104 °F).

Technical data

1-phase mains connection 230/240 V

Rated data



Inverter			i510-P0.37/230-2	i510-P0.75/230-2	i510-P1.1/230-2	i510-P1.5/230-2
Rated power	P _{rated}	kW	0.37	0.75	1.1	1.5
Rated power	P _{rated}	hp	0.5	1	1.5	2
Mains voltage range			1/PE AC 170 V ... 264 V, 45 Hz ... 65 Hz			
Output voltage			3 AC 0 - 230/240 V			
Rated mains current						
without mains choke		A	5.7	10	14.3	16.7
with mains choke		A	-			
Apparent output power		kVA	0.9	1.6	2.3	2.6
Rated output current						
2 kHz		A	2.4	4.2	6	7
4 kHz		A	2.4	4.2	6	7
8 kHz		A	2.4	4.2	6	7
12 kHz		A	2.2	3.8	5.4	6.3
16 kHz		A	1.6	2.8	4	4.7
Power loss						
2 kHz		W	19	30	38	45
4 kHz		W	20	32	40	48
8 kHz		W	24	40	51	61
12 kHz		W	23	38	54	65
16 kHz		W	22	35	49	58
Overcurrent cycle 180 s						
Max. output current		A	3.6	6.3	9	10.5
Overload time	T ₁	s	60			
Recovery time	T ₂	s	120			
Max. output current during the recovery time		A	1.8	3.2	4.5	5.3
Overcurrent cycle 15 s						
Max. output current		A	4.8	8.4	12	14
Overload time	T ₁	s	3			
Recovery time	T ₂	s	12			
Max. output current during the recovery time		A	1.8	3.2	4.5	5.3
Cyclic mains switching			3 times per minute			
Brake chopper						
Max. output current			-			
Min. brake resistance			-			
Max. motor cable length shielded						
without EMC category		m	30			
Category C1 (2 kHz, 4 kHz, 8 kHz)		m	-			
Category C2 (2 kHz, 4 kHz, 8 kHz)		m	-			
Category C3 (2 kHz, 4 kHz, 8 kHz)		m	-			
Max. motor cable length unshielded						
without EMC category		m	60		80	



Technical data

1-phase mains connection 230/240 V
Rated data

Inverter			i510-P2.2/230-2
Rated power	P_{rated}	kW	2.2
Rated power	P_{rated}	hp	3
Mains voltage range			1/PE AC 170 V ... 264 V, 45 Hz ... 65 Hz
Output voltage			3 AC 0 - 230/240 V
Rated mains current			
without mains choke		A	22.5
with mains choke		A	-
Apparent output power		kVA	3.6
Rated output current			
2 kHz		A	9.6
4 kHz		A	9.6
8 kHz		A	9.6
12 kHz		A	8.6
16 kHz		A	6.4
Power loss			
2 kHz		W	62
4 kHz		W	66
8 kHz		W	85
12 kHz		W	91
16 kHz		W	81
Overcurrent cycle 180 s			
Max. output current		A	14.4
Overload time	T_1	s	60
Recovery time	T_2	s	120
Max. output current during the recovery time		A	7.2
Overcurrent cycle 15 s			
Max. output current		A	19.2
Overload time	T_1	s	3
Recovery time	T_2	s	12
Max. output current during the recovery time		A	7.2
Cyclic mains switching			3 times per minute
Brake chopper			
Max. output current			-
Min. brake resistance			-
Max. motor cable length shielded			
without EMC category		m	30
Category C1 (2 kHz, 4 kHz, 8 kHz)		m	-
Category C2 (2 kHz, 4 kHz, 8 kHz)		m	-
Category C3 (2 kHz, 4 kHz, 8 kHz)		m	-
Max. motor cable length unshielded			
without EMC category		m	80

Technical data

1-phase mains connection 230/240 V
Fusing data



Fusing data



A residual current device (RCD) is optional.

Fusing data for UL/NEC compliant installations: [► Fusing data](#) 34

Inverter	Fuse		Circuit breaker		RCD	
	Characteristic	Max. rated current	Characteristic	Max. rated current	mA	Type
		A		A		
i510-P0.37/230-2	gG/gL, gRL	40	B	32	≥30	Typ B
i510-P0.75/230-2	gG/gL, gRL	40	B	32	≥30	Typ B
i510-P1.1/230-2	gG/gL, gRL	40	B	32	≥30	Typ B
i510-P1.5/230-2	gG/gL, gRL	40	B	32	≥30	Typ B
i510-P2.2/230-2	gG/gL, gRL	40	B	32	≥30	Typ B

Terminal data

Rated power	P _{rated}	kW	0.37 ... 1.5		2.2
Connection description			Mains connection		
Connection			X100		
Connection type			Pluggable		
Max. cable cross-section	mm ²		4		6
Max. cable cross-section	AWG		10		10
Stripping length	mm		8		8
Stripping length	in		0.3		0.3
Tightening torque	Nm		0.6		0.7
Tightening torque	lb-in		5.3		6.2
Required tool			Screwdriver 0.5 x 3.0		Screwdriver 0.6 x 3.5

Rated power	P _{rated}	kW	0.37 ... 2.2	
Connection description			PE connection	
Connection			-	
Max. cable cross-section	mm ²		6	
Max. cable cross-section	AWG		10	
Stripping length	mm		10	
Stripping length	in		0.4	
Tightening torque	Nm		2	
Tightening torque	lb-in		18	
Required tool			Torx key 20	

Rated power	P _{rated}	kW	0.37 ... 1.5		2.2
Connection description			Motor connection		
Connection			X105		
Connection type			Pluggable		
Max. cable cross-section	mm ²		4		6
Max. cable cross-section	AWG		10		10
Stripping length	mm		8		8
Stripping length	in		0.3		0.3
Tightening torque	Nm		0.6		0.7
Tightening torque	lb-in		5.3		6.2
Required tool			Screwdriver 0.5 x 3.0		Screwdriver 0.6 x 3.5



Technical data

1-phase mains connection 230/240 V "Light Duty"

1-phase mains connection 230/240 V "Light Duty"



EMC filters are **not integrated** in inverters of the type "i550-Px.xx/230-2".

Technical data

1-phase mains connection 230/240 V "Light Duty"

Rated data



Rated data

The output currents apply to these operating conditions:

- At switching frequency 2 kHz or 4 kHz: Ambient temperature max. 40 °C (104 °F).

Inverter			i510-P0.37/230-2	i510-P0.75/230-2	i510-P1.1/230-2	i510-P1.5/230-2
Rated power	P _{rated}	kW	0.55	1.1	1.5	2.2
Rated power	P _{rated}	hp	0.75	1.5	2	3
Mains voltage range			1/PE AC 170 V ... 264 V, 45 Hz ... 65 Hz			
Output voltage			3 AC 0 - 230/240 V			
Rated mains current						
without mains choke		A	6.9	12	17.1	20
with mains choke		A	-			
Apparent output power		kVA	1.2	2.2	2.6	3.6
Rated output current						
2 kHz		A	2.9	5	7.2	8.4
4 kHz		A	2.9	5	7.2	8.4
Power loss						
2 kHz		W	30	38	45	62
4 kHz		W	32	40	48	66
Overcurrent cycle 180 s						
Max. output current		A	3.6	6.3	9	10.5
Overload time	T ₁	s	60	60	60	60
Recovery time	T ₂	s	120	120	120	120
Max. output current during the recovery time		A	1.8	3.2	4.5	5.3
Overcurrent cycle 15 s						
Max. output current		A	4.8	8.4	12	14
Overload time	T ₁	s	3	3	3	3
Recovery time	T ₂	s	12	12	12	12
Max. output current during the recovery time		A	1.8	3.2	4.5	5.3
Cyclic mains switching			3 times per minute			
Brake chopper						
Max. output current			-			
Min. brake resistance			-			
Max. motor cable length shielded						
without EMC category		m	30			
Category C1 (2 kHz, 4 kHz, 8 kHz)		m	-			
Category C2 (2 kHz, 4 kHz, 8 kHz)		m	-			
Category C3 (2 kHz, 4 kHz, 8 kHz)		m	-			
Max. motor cable length unshielded						
without EMC category		m	60		80	



Technical data

1-phase mains connection 230/240 V "Light Duty"
Rated data

Inverter		i510-P2.2/230-2	
Rated power	P_{rated}	kW	3
Rated power	P_{rated}	hp	4
Mains voltage range			1/PE AC 170 V ... 264 V, 45 Hz ... 65 Hz
Output voltage			3 AC 0 - 230/240 V
Rated mains current			
without mains choke		A	27.4
with mains choke		A	-
Apparent output power		kVA	4.9
Rated output current			
2 kHz		A	11.5
4 kHz		A	11.5
Power loss			
2 kHz		W	79
4 kHz		W	84
Overcurrent cycle 180 s			
Max. output current		A	14.4
Overload time	T_1	s	60
Recovery time	T_2	s	120
Max. output current during the recovery time		A	7.2
Overcurrent cycle 15 s			
Max. output current		A	19.2
Overload time	T_1	s	3
Recovery time	T_2	s	12
Max. output current during the recovery time		A	7.2
Cyclic mains switching			3 times per minute
Brake chopper			
Max. output current			-
Min. brake resistance			-
Max. motor cable length shielded			
without EMC category		m	30
Category C1 (2 kHz, 4 kHz, 8 kHz)		m	-
Category C2 (2 kHz, 4 kHz, 8 kHz)		m	-
Category C3 (2 kHz, 4 kHz, 8 kHz)		m	-
Max. motor cable length unshielded			
without EMC category		m	80

Technical data

1-phase mains connection 230/240 V "Light Duty"
Fusing data



Fusing data



A residual current device (RCD) is optional.

Fusing data for UL/NEC compliant installations: [▶ Fusing data](#)  34

Inverter	Fuse		Circuit breaker		RCD	
	Characteristic	Max. rated current	Characteristic	Max. rated current	mA	Type
		A		A		
i510-P0.37/230-2	gG/gL, gRL	40	B	32	≥30	Typ B
i510-P0.75/230-2	gG/gL, gRL	40	B	32	≥30	Typ B
i510-P1.1/230-2	gG/gL, gRL	40	B	32	≥30	Typ B
i510-P1.5/230-2	gG/gL, gRL	40	B	32	≥30	Typ B
i510-P2.2/230-2	gG/gL, gRL	40	B	32	≥30	Typ B

Terminal data

[▶ Terminal data](#)  54



3-phase mains connection 230/240 V



EMC filters are **not integrated** in inverters for this mains connection.

Technical data

3-phase mains connection 230/240 V
Rated data



Rated data

The output currents apply to these operating conditions:

- At switching frequency 2 kHz or 4 kHz: Ambient temperature max. 45 °C (113 °F).
- At switching frequency 8 kHz, 12 kHz or 16 kHz: Ambient temperature max. 40 °C (104 °F).



Technical data

3-phase mains connection 230/240 V
Rated data

Inverter			i510-P0.37/230-2	i510-P0.75/230-2	i510-P1.1/230-2	i510-P1.5/230-2
Rated power	P_{rated}	kW	0.37	0.75	1.1	1.5
Rated power	P_{rated}	hp	0.5	1	1.5	2
Mains voltage range			3/PE AC 195 V ... 264 V, 45 Hz ... 65 Hz			
Output voltage			3 AC 0 - 230/240 V			
Rated mains current						
without mains choke		A	3.9	6.4	7.8	9.5
with mains choke		A	-			
Apparent output power		kVA	0.9	1.6	2.3	2.6
Rated output current						
2 kHz		A	2.4	4.2	6	7
4 kHz		A	2.4	4.2	6	7
8 kHz		A	2.4	4.2	6	7
12 kHz		A	2.2	3.8	5.4	6.3
16 kHz		A	1.6	2.8	4	4.7
Power loss						
2 kHz		W	19	30	38	45
4 kHz		W	20	32	40	48
8 kHz		W	24	40	51	61
12 kHz		W	23	38	54	65
16 kHz		W	22	35	49	58
Overcurrent cycle 180 s						
Max. output current		A	3.6	6.3	9	10.5
Overload time	T_1	s	60	60	60	60
Recovery time	T_2	s	120	120	120	120
Max. output current during the recovery time		A	1.8	3.2	4.5	5.3
Overcurrent cycle 15 s						
Max. output current		A	4.8	8.4	12	14
Overload time	T_1	s	3	3	3	3
Recovery time	T_2	s	12	12	12	12
Max. output current during the recovery time		A	1.8	3.2	4.5	5.3
Cyclic mains switching			3 times per minute			
Brake chopper						
Max. output current			-			
Min. brake resistance			-			
Max. motor cable length shielded						
without EMC category		m	30			
Category C1 (2 kHz, 4 kHz, 8 kHz)		m	-			
Category C2 (2 kHz, 4 kHz, 8 kHz)		m	-			
Category C3 (2 kHz, 4 kHz, 8 kHz)		m	-			
Max. motor cable length unshielded						
without EMC category		m	60		80	

Technical data

3-phase mains connection 230/240 V

Rated data



Inverter			i510-P2.2/230-2	i510-P3.0/230-3	i510-P4.0/230-3
Rated power	P_{rated}	kW	2.2	3	4
Rated power	P_{rated}	hp	3	4	5
Mains voltage range			3/PE AC 195 V ... 264 V, 45 Hz ... 65 Hz		
Output voltage			3 AC 0 - 230/240 V		
Rated mains current					
without mains choke		A	13.6	15	20.6
with mains choke		A	-		
Apparent output power		kVA	3.6	4.5	6.2
Rated output current					
2 kHz		A	9.6	12	16.5
4 kHz		A	9.6	12	16.5
8 kHz		A	9.6	12	16.5
12 kHz		A	8.6	10.8	14.9
16 kHz		A	6.4	8	11
Power loss					
2 kHz		W	62	79	102
4 kHz		W	66	84	108
8 kHz		W	85	109	140
12 kHz		W	91	104	133
16 kHz		W	81	104	133
Overcurrent cycle 180 s					
Max. output current		A	14.4	18	24.8
Overload time	T_1	s	60	60	60
Recovery time	T_2	s	120	120	120
Max. output current during the recovery time		A	7.2	9	12.4
Overcurrent cycle 15 s					
Max. output current		A	19.2	24	33
Overload time	T_1	s	3	3	3
Recovery time	T_2	s	12	12	12
Max. output current during the recovery time		A	7.2	9	12.4
Cyclic mains switching			3 times per minute		
Brake chopper					
Max. output current			-		
Min. brake resistance			-		
Max. motor cable length shielded					
without EMC category		m	30	50	
Category C1 (2 kHz, 4 kHz, 8 kHz)		m	-		
Category C2 (2 kHz, 4 kHz, 8 kHz)		m	-		
Category C3 (2 kHz, 4 kHz, 8 kHz)		m	-		
Max. motor cable length unshielded					
without EMC category		m	80	100	



Fusing data



A residual current device (RCD) is optional.

Fusing data for UL/NEC compliant installations: [▶ Fusing data](#) 34

Inverter	Fuse		Circuit breaker		RCD	
	Characteristic	Max. rated current A	Characteristic	Max. rated current A	mA	Type
i510-P0.37/230-2	gG/gL, gRL	40	B	32	≥30	Typ B
i510-P0.75/230-2	gG/gL, gRL	40	B	32	≥30	Typ B
i510-P1.1/230-2	gG/gL, gRL	40	B	32	≥30	Typ B
i510-P1.5/230-2	gG/gL, gRL	40	B	32	≥30	Typ B
i510-P2.2/230-2	gG/gL, gRL	40	B	32	≥30	Typ B
i510-P3.0/230-3	gG/gL, gRL	80	B	32	≥30	Typ B
i510-P4.0/230-3	gG/gL, gRL	80	B	32	≥30	Typ B

Technical data

3-phase mains connection 230/240 V
Terminal data



Terminal data

Rated power	P _{rated}	kW	0.37 ... 1.5	2.2 ... 4
Connection description			Mains connection	
Connection			X100	
Connection type			Pluggable	
Max. cable cross-section		mm ²	4	6
Max. cable cross-section		AWG	10	10
Stripping length		mm	8	8
Stripping length		in	0.3	0.3
Tightening torque		Nm	0.6	0.7
Tightening torque		lb-in	5.3	6.2
Required tool			Screwdriver 0.5 x 3.0	Screwdriver 0.6 x 3.5

Rated power	P _{rated}	kW	0.37 ... 4	
Connection description			PE connection	
			-	
Max. cable cross-section		mm ²	6	
Max. cable cross-section		AWG	10	
Stripping length		mm	10	
Stripping length		in	0.4	
Tightening torque		Nm	2	
Tightening torque		lb-in	18	
Required tool			Torx key 20	

Rated power	P _{rated}	kW	0.37 ... 1.5	2.2 ... 4
Connection description			Motor connection	
Connection			X105	
Connection type			Pluggable	
Max. cable cross-section		mm ²	4	6
Max. cable cross-section		AWG	10	10
Stripping length		mm	8	8
Stripping length		in	0.3	0.3
Tightening torque		Nm	0.6	0.7
Tightening torque		lb-in	5.3	6.2
Required tool			Screwdriver 0.5 x 3.0	Screwdriver 0.6 x 3.5



Technical data

3-phase mains connection 230/240 V "Light Duty"

3-phase mains connection 230/240 V "Light Duty"



EMC filters are **not integrated** in inverters for this mains connection.

Technical data

3-phase mains connection 230/240 V "Light Duty"

Rated data



Rated data

The output currents apply to these operating conditions:

- At switching frequency 2 kHz or 4 kHz: Ambient temperature max. 40 °C (104 °F).

Inverter			i510-P0.37/230-2	i510-P0.75/230-2	i510-P1.1/230-2	i510-P1.5/230-2
Rated power	P _{rated}	kW	0.55	1.1	1.5	2.2
Rated power	P _{rated}	hp	0.75	1.5	2	3
Mains voltage range			3/PE AC 195 V ... 264 V, 45 Hz ... 65 Hz			
Output voltage			3 AC 0 - 230/240 V			
Rated mains current						
without mains choke		A	4.7	7.7	9.4	11.4
with mains choke		A	-			
Apparent output power		kVA	1.2	2.2	2.6	3.6
Rated output current						
2 kHz		A	2.9	5	7.2	8.4
4 kHz		A	2.9	5	7.2	8.4
Power loss						
2 kHz		W	30	38	45	62
4 kHz		W	32	40	48	66
Overcurrent cycle 180 s						
Max. output current		A	3.6	6.3	9	10.5
Overload time	T ₁	s	60	60	60	60
Recovery time	T ₂	s	120	120	120	120
Max. output current during the recovery time		A	1.8	3.2	4.5	5.3
Overcurrent cycle 15 s						
Max. output current		A	4.8	8.4	12	14
Overload time	T ₁	s	3	3	3	3
Recovery time	T ₂	s	12	12	12	12
Max. output current during the recovery time		A	1.8	3.2	4.5	5.3
Cyclic mains switching			3 times per minute			
Brake chopper						
Max. output current			-			
Min. brake resistance			-			
Max. motor cable length shielded						
without EMC category		m	30			
Category C1 (2 kHz, 4 kHz, 8 kHz)		m	-			
Category C2 (2 kHz, 4 kHz, 8 kHz)		m	-			
Category C3 (2 kHz, 4 kHz, 8 kHz)		m	-			
Max. motor cable length unshielded						
without EMC category		m	60		80	



Technical data

3-phase mains connection 230/240 V "Light Duty"
Rated data

Inverter			i510-P2.2/230-2	i510-P3.0/230-3	i510-P4.0/230-3
Rated power	P_{rated}	kW	3	4	5.5
Rated power	P_{rated}	hp	4	5	7.5
Mains voltage range			3/PE AC 195 V ... 264 V, 45 Hz ... 65 Hz		
Output voltage			3 AC 0 - 230/240 V		
Rated mains current					
without mains choke		A	16.4	17.3	23.8
with mains choke		A	-		
Apparent output power		kVA	4.9	6.2	8.7
Rated output current					
2 kHz		A	11.5	14.4	19.8
4 kHz		A	11.5	14.4	19.8
Power loss					
2 kHz		W	79	102	137
4 kHz		W	84	108	145
Overcurrent cycle 180 s					
Max. output current		A	14.4	18	24.8
Overload time	T_1	s	60	60	60
Recovery time	T_2	s	120	120	120
Max. output current during the recovery time		A	7.2	9	12.4
Overcurrent cycle 15 s					
Max. output current		A	19.2	24	33
Overload time	T_1	s	3	3	3
Recovery time	T_2	s	12	12	12
Max. output current during the recovery time		A	7.2	9	12.4
Cyclic mains switching			3 times per minute		
Brake chopper					
Max. output current			-		
Min. brake resistance			-		
Max. motor cable length shielded					
without EMC category		m	30	50	
Category C1 (2 kHz, 4 kHz, 8 kHz)		m	-		
Category C2 (2 kHz, 4 kHz, 8 kHz)		m	-		
Category C3 (2 kHz, 4 kHz, 8 kHz)		m	-		
Max. motor cable length unshielded					
without EMC category		m	80	100	

Technical data

3-phase mains connection 230/240 V "Light Duty"
Fusing data



Fusing data



A residual current device (RCD) is optional.

Fusing data for UL/NEC compliant installations: [▶ Fusing data](#) 34

Inverter	Fuse		Circuit breaker		RCD	
	Characteristic	Max. rated current	Characteristic	Max. rated current	mA	Type
		A		A		
i510-P0.37/230-2	gG/gL, gRL	40	B	32	≥30	Typ B
i510-P0.75/230-2	gG/gL, gRL	40	B	32	≥30	Typ B
i510-P1.1/230-2	gG/gL, gRL	40	B	32	≥30	Typ B
i510-P1.5/230-2	gG/gL, gRL	40	B	32	≥30	Typ B
i510-P2.2/230-2	gG/gL, gRL	40	B	32	≥30	Typ B
i510-P3.0/230-3	gG/gL, gRL	80	B	32	≥30	Typ B
i510-P4.0/230-3	gG/gL, gRL	80	B	32	≥30	Typ B

Terminal data

[▶ Terminal data](#) 64



Technical data

3-phase mains connection 400 V
Rated data

3-phase mains connection 400 V

Rated data

The output currents apply to these operating conditions:

- At switching frequency 2 kHz or 4 kHz: Ambient temperature max. 45 °C (113 °F).
- At switching frequency 8 kHz, 12 kHz or 16 kHz: Ambient temperature max. 40 °C (104 °F).

Technical data

3-phase mains connection 400 V

Rated data



Inverter			i510-P0.75/400-3	i510-P1.1/400-3	i510-P1.5/400-3	i510-P2.2/400-3
Rated power	P _{rated}	kW	0.75	1.1	1.5	2.2
Rated power	P _{rated}	hp	1	1.5	2	3
Mains voltage range			3/PE AC 340 V ... 528 V, 45 Hz ... 65 Hz			
Output voltage			3 AC 0 - 400/480 V			
Rated mains current						
without mains choke		A	3.3	4.4	5.4	7.8
with mains choke		A	-			
Apparent output power		kVA	1.6	2.1	2.6	3.8
Rated output current						
2 kHz		A	2.4	3.2	3.9	5.6
4 kHz		A	2.4	3.2	3.9	5.6
8 kHz		A	2.4	3.2	3.9	5.6
12 kHz		A	1.9	2.9	3.5	5
16 kHz		A	1.4	2.1	2.6	3.7
Power loss						
2 kHz		W	30	38	45	62
4 kHz		W	32	40	48	66
8 kHz		W	40	51	61	85
12 kHz		W	38	54	65	91
16 kHz		W	35	49	58	81
Overcurrent cycle 180 s						
Max. output current		A	3.6	4.8	5.9	8.4
Overload time	T ₁	s	60	60	60	60
Recovery time	T ₂	s	120	120	120	120
Max. output current during the recovery time		A	1.8	2.4	2.9	4.2
Overcurrent cycle 15 s						
Max. output current		A	4.8	6.4	7.8	11.2
Overload time	T ₁	s	3	3	3	3
Recovery time	T ₂	s	12	12	12	12
Max. output current during the recovery time		A	1.8	2.4	2.9	4.2
Cyclic mains switching			3 times per minute			
Brake chopper						
Max. output current			-			
Min. brake resistance			-			
Max. motor cable length shielded						
without EMC category		m	30			
Category C1 (2 kHz, 4 kHz, 8 kHz)		m	-			
Category C2 (2 kHz, 4 kHz, 8 kHz)		m	-			
Category C3 (2 kHz, 4 kHz, 8 kHz)		m	-			
Max. motor cable length unshielded						
without EMC category		m	60	80		



Technical data

3-phase mains connection 400 V
Rated data

Inverter			i510-P3/400-3	i510-P4/400-3	i510-P5.5/400-3
Rated power	P_{rated}	kW	3	4	5.5
Rated power	P_{rated}	hp	4	5	7.5
Mains voltage range			3/PE AC 340 V ... 528 V, 45 Hz ... 65 Hz		
Output voltage			3 AC 0 - 400/480 V		
Rated mains current					
without mains choke		A	9.6	12.5	17.2
with mains choke		A	-		
Apparent output power		kVA	4.9	6.4	8.7
Rated output current					
2 kHz		A	7.3	9.5	13
4 kHz		A	7.3	9.5	13
8 kHz		A	7.3	9.5	13
12 kHz		A	5.8	7.6	10.4
16 kHz		A	4.9	6.3	8.7
Power loss					
2 kHz		W	79	102	137
4 kHz		W	84	108	145
8 kHz		W	109	140	189
12 kHz		W	104	133	180
16 kHz		W	104	133	180
Overcurrent cycle 180 s					
Max. output current		A	11	14.3	19.5
Overload time	T_1	s	60	60	60
Recovery time	T_2	s	120	120	120
Max. output current during the recovery time		A	5.5	7.1	9.8
Overcurrent cycle 15 s					
Max. output current		A	14.6	19	26
Overload time	T_1	s	3	3	3
Recovery time	T_2	s	12	12	12
Max. output current during the recovery time		A	5.5	7.1	9.8
Cyclic mains switching			3 times per minute		
Brake chopper					
Max. output current			-		
Min. brake resistance			-		
Max. motor cable length shielded					
without EMC category		m	50		
Category C1 (2 kHz, 4 kHz, 8 kHz)		m	-		
Category C2 (2 kHz, 4 kHz, 8 kHz)		m	-		
Category C3 (2 kHz, 4 kHz, 8 kHz)		m	-		
Max. motor cable length unshielded					
without EMC category		m	100		

Technical data

3-phase mains connection 400 V
Fusing data



Fusing data



A residual current device (RCD) is optional.

Fusing data for UL/NEC compliant installations: [▶ Fusing data](#) 34

Inverter	Fuse		Circuit breaker		RCD	
	Characteristic	Max. rated current	Characteristic	Max. rated current	mA	Type
		A		A		
i510-P0.75/400-3	gG/gL, gRL	32	B	32	≥30	Typ B
i510-P1.1/400-3	gG/gL, gRL	32	B	32	≥30	Typ B
i510-P1.5/400-3	gG/gL, gRL	32	B	32	≥30	Typ B
i510-P2.2/400-3	gG/gL, gRL	32	B	32	≥30	Typ B
i510-P3/400-3	gG/gL, gRL	40	B	32	≥30	Typ B
i510-P4/400-3	gG/gL, gRL	40	B	32	≥30	Typ B
i510-P5.5/400-3	gG/gL, gRL	40	B	32	≥30	Typ B



Technical data

3-phase mains connection 400 V
Terminal data

Terminal data

Rated power	P _{rated}	kW	0.75 ... 2.2	3 ... 5.5
Connection description			Mains connection	
Connection			X100	
Connection type			Pluggable	
Max. cable cross-section		mm ²	4	6
Max. cable cross-section		AWG	10	10
Stripping length		mm	8	8
Stripping length		in	0.3	0.3
Tightening torque		Nm	0.6	0.7
Tightening torque		lb-in	5.3	6.2
Required tool			Screwdriver 0.5 x 3.0	Screwdriver 0.6 x 3.5

Rated power	P _{rated}	kW	0.75 ... 5.5	
Connection description			PE connection	
Connection			PE	
Max. cable cross-section		mm ²	6	
Max. cable cross-section		AWG	10	
Stripping length		mm	10	
Stripping length		in	0.4	
Tightening torque		Nm	2	
Tightening torque		lb-in	18	
Required tool			Torx key 20	

Rated power	P _{rated}	kW	0.75 ... 2.2	3 ... 5.5
Connection description			Motor connection	
Connection			X105	
Connection type			Pluggable	
Max. cable cross-section		mm ²	4	6
Max. cable cross-section		AWG	10	10
Stripping length		mm	8	8
Stripping length		in	0.3	0.3
Tightening torque		Nm	0.6	0.7
Tightening torque		lb-in	5.3	6.2
Required tool			Screwdriver 0.5 x 3.0	Screwdriver 0.6 x 3.5

Technical data

3-phase mains connection 400 V "Light Duty"

Rated data



3-phase mains connection 400 V "Light Duty"

Rated data

The output currents apply to these operating conditions:

- At switching frequency 2 kHz or 4 kHz: Ambient temperature max. 40 °C (104 °F).

Inverter			i510-P0.75/400-3	i510-P1.1/400-3	i510-P1.5/400-3	i510-P2.2/400-3
Rated power	P _{rated}	kW	1.1	1.5	2.2	3
Rated power	P _{rated}	hp	1.5	2	3	4
Mains voltage range			3/PE AC 340 V ... 528 V, 45 Hz ... 65 Hz			
Output voltage			3 AC 0 - 400/480 V			
Rated mains current						
without mains choke		A	4.5	5	6.1	8.7
with mains choke		A	-			
Apparent output power		kVA	2.1	2.6	3.6	4.9
Rated output current						
2 kHz		A	2.9	3.8	4.7	6.7
4 kHz		A	2.9	3.8	4.7	6.7
Power loss						
2 kHz		W	38	45	62	79
4 kHz		W	40	48	66	84
Overcurrent cycle 180 s						
Max. output current		A	3.6	4.8	5.9	8.4
Overload time	T ₁	s	60	60	60	60
Recovery time	T ₂	s	120	120	120	120
Max. output current during the recovery time		A	1.8	2.4	2.9	4.2
Overcurrent cycle 15 s						
Max. output current		A	4.8	6.4	7.8	11.2
Overload time	T ₁	s	3	3	3	3
Recovery time	T ₂	s	12	12	12	12
Max. output current during the recovery time		A	1.8	2.4	2.9	4.2
Cyclic mains switching			3 times per minute			
Brake chopper						
Max. output current			-			
Min. brake resistance			-			
Max. motor cable length shielded						
without EMC category		m	30			
Category C1 (2 kHz, 4 kHz, 8 kHz)		m	-			
Category C2 (2 kHz, 4 kHz, 8 kHz)		m	-			
Category C3 (2 kHz, 4 kHz, 8 kHz)		m	-			
Max. motor cable length unshielded						
without EMC category		m	60	80		



Technical data

3-phase mains connection 400 V "Light Duty"
Rated data

Inverter			i510-P3/400-3	i510-P4/400-3	i510-P5.5/400-3
Rated power	P_{rated}	kW	4	5.5	7.5
Rated power	P_{rated}	hp	5	7.5	10
Mains voltage range			3/PE AC 340 V ... 528 V, 45 Hz ... 65 Hz		
Output voltage			3 AC 0 - 400/480 V		
Rated mains current					
without mains choke		A	10.3	14	18.3
with mains choke		A	-		
Apparent output power		kVA	6.4	8.7	11
Rated output current					
2 kHz		A	8.8	11.9	15.6
4 kHz		A	8.8	11.9	15.6
Power loss					
2 kHz		W	102	137	172
4 kHz		W	108	145	183
Overcurrent cycle 180 s					
Max. output current		A	11	14.3	19.5
Overload time	T_1	s	60	60	60
Recovery time	T_2	s	120	120	120
Max. output current during the recovery time		A	5.5	7.1	9.8
Overcurrent cycle 15 s					
Max. output current		A	14.6	19	26
Overload time	T_1	s	3	3	3
Recovery time	T_2	s	12	12	12
Max. output current during the recovery time		A	5.5	7.1	9.8
Cyclic mains switching			3 times per minute		
Brake chopper					
Max. output current			-		
Min. brake resistance			-		
Max. motor cable length shielded					
without EMC category		m	50		
Category C1 (2 kHz, 4 kHz, 8 kHz)		m	-		
Category C2 (2 kHz, 4 kHz, 8 kHz)		m	-		
Category C3 (2 kHz, 4 kHz, 8 kHz)		m	-		
Max. motor cable length unshielded					
without EMC category		m	100		

Technical data

3-phase mains connection 400 V "Light Duty"
Fusing data



Fusing data



A residual current device (RCD) is optional.

Fusing data for UL/NEC compliant installations: [▶ Fusing data](#) 34

Inverter	Fuse		Circuit breaker		RCD	
	Characteristic	Max. rated current	Characteristic	Max. rated current	mA	Type
		A		A		
i510-P0.75/400-3	gG/gL, gRL	32	B	32	≥30	Typ B
i510-P1.1/400-3	gG/gL, gRL	32	B	32	≥30	Typ B
i510-P1.5/400-3	gG/gL, gRL	32	B	32	≥30	Typ B
i510-P2.2/400-3	gG/gL, gRL	32	B	32	≥30	Typ B
i510-P3/400-3	gG/gL, gRL	40	B	32	≥30	Typ B
i510-P4/400-3	gG/gL, gRL	40	B	32	≥30	Typ B
i510-P5.5/400-3	gG/gL, gRL	40	B	32	≥30	Typ B

Terminal data

[▶ Terminal data](#) 73



Technical data

3-phase mains connection 480 V
Rated data

3-phase mains connection 480 V

Rated data

The output currents apply to these operating conditions:

- At switching frequency 2 kHz or 4 kHz: Ambient temperature max. 45 °C (113 °F).
- At switching frequency 8 kHz, 12 kHz or 16 kHz: Ambient temperature max. 40 °C (104 °F).

Technical data

3-phase mains connection 480 V

Rated data



Inverter			i510-P0.75/400-3	i510-P1.1/400-3	i510-P1.5/400-3	i510-P2.2/400-3
Rated power	P_{rated}	kW	0.75	1.1	1.5	2.2
Rated power	P_{rated}	hp	1	1.5	2	3
Mains voltage range			3/PE AC 340 V ... 528 V, 45 Hz ... 65 Hz			
Output voltage			3 AC 0 - 400/480 V			
Rated mains current						
without mains choke		A	2.8	3.7	4.5	6.5
with mains choke		A	-			
Apparent output power		kVA	1.7	2.4	2.8	3.9
Rated output current						
2 kHz		A	2.1	3	3.5	4.8
4 kHz		A	2.1	3	3.5	4.8
8 kHz		A	2.1	3	3.5	4.8
12 kHz		A	1.7	2.7	3.2	4.3
16 kHz		A	1.3	2	2.3	3.2
Power loss						
2 kHz		W	30	38	45	62
4 kHz		W	32	40	48	66
8 kHz		W	40	51	61	85
12 kHz		W	38	54	65	91
16 kHz		W	35	49	58	81
Overcurrent cycle 180 s						
Max. output current		A	3.2	4.5	5.3	7.2
Overload time	T_1	s	60	60	60	60
Recovery time	T_2	s	120	120	120	120
Max. output current during the recovery time		A	1.6	2.3	2.6	3.6
Overcurrent cycle 15 s						
Max. output current		A	4.2	6	7	9.6
Overload time	T_1	s	3	3	3	3
Recovery time	T_2	s	12	12	12	12
Max. output current during the recovery time		A	1.6	2.3	2.6	3.6
Cyclic mains switching			3 times per minute			
Brake chopper						
Max. output current			-			
Min. brake resistance			-			
Max. motor cable length shielded						
without EMC category		m	30			
Category C1 (2 kHz, 4 kHz, 8 kHz)		m	-			
Category C2 (2 kHz, 4 kHz, 8 kHz)		m	-			
Category C3 (2 kHz, 4 kHz, 8 kHz)		m	-			
Max. motor cable length unshielded						
without EMC category		m	60	80		



Technical data

3-phase mains connection 480 V
Rated data

Inverter			i510-P3/400-3	i510-P4/400-3	i510-P5.5/400-3
Rated power	P_{rated}	kW	3	4	5.5
Rated power	P_{rated}	hp	4	5	7.5
Mains voltage range			3/PE AC 340 V ... 528 V, 45 Hz ... 65 Hz		
Output voltage			3 AC 0 - 400/480 V		
Rated mains current					
without mains choke		A	8	10.5	14.3
with mains choke		A	-		
Apparent output power		kVA	5.1	6.6	8.9
Rated output current					
2 kHz		A	6.3	8.2	11
4 kHz		A	6.3	8.2	11
8 kHz		A	6.3	8.2	11
12 kHz		A	5	6.6	8.8
16 kHz		A	4.2	5.5	7.3
Power loss					
2 kHz		W	79	102	137
4 kHz		W	84	108	145
8 kHz		W	109	140	189
12 kHz		W	104	133	180
16 kHz		W	104	133	180
Overcurrent cycle 180 s					
Max. output current		A	9.5	12.3	16.5
Overload time	T_1	s	60	60	60
Recovery time	T_2	s	120	120	120
Max. output current during the recovery time		A	4.7	6.2	8.3
Overcurrent cycle 15 s					
Max. output current		A	12.6	16.4	22
Overload time	T_1	s	3	3	3
Recovery time	T_2	s	12	12	12
Max. output current during the recovery time		A	4.7	6.2	8.3
Cyclic mains switching			3 times per minute		
Brake chopper					
Max. output current			-		
Min. brake resistance			-		
Max. motor cable length shielded					
without EMC category		m	50		
Category C1 (2 kHz, 4 kHz, 8 kHz)		m	-		
Category C2 (2 kHz, 4 kHz, 8 kHz)		m	-		
Category C3 (2 kHz, 4 kHz, 8 kHz)		m	-		
Max. motor cable length unshielded					
without EMC category		m	100		

Technical data

3-phase mains connection 480 V
Fusing data



Fusing data



A residual current device (RCD) is optional.

Fusing data for UL/NEC compliant installations: [▶ Fusing data](#) 34

Inverter	Fuse		Circuit breaker		RCD	
	Characteristic	Max. rated current	Characteristic	Max. rated current	mA	Type
		A		A		
i510-P0.75/400-3	gG/gL, gRL	32	B	32	≥30	Typ B
i510-P1.1/400-3	gG/gL, gRL	32	B	32	≥30	Typ B
i510-P1.5/400-3	gG/gL, gRL	32	B	32	≥30	Typ B
i510-P2.2/400-3	gG/gL, gRL	32	B	32	≥30	Typ B
i510-P3/400-3	gG/gL, gRL	40	B	32	≥30	Typ B
i510-P4/400-3	gG/gL, gRL	40	B	32	≥30	Typ B
i510-P5.5/400-3	gG/gL, gRL	40	B	32	≥30	Typ B



Technical data

3-phase mains connection 480 V
Terminal data

Terminal data

Rated power	P _{rated}	kW	0.75 ... 2.2	3 ... 5.5
Connection description			Mains connection	
Connection			X100	
Connection type			Pluggable	
Max. cable cross-section		mm ²	4	6
Max. cable cross-section		AWG	10	10
Stripping length		mm	8	8
Stripping length		in	0.3	0.3
Tightening torque		Nm	0.6	0.7
Tightening torque		lb-in	5.3	6.2
Required tool			Screwdriver 0.5 x 3.0	Screwdriver 0.6 x 3.5

Rated power	P _{rated}	kW	0.75 ... 5.5	
Connection description			PE connection	
Connection			PE	
Max. cable cross-section		mm ²	6	
Max. cable cross-section		AWG	10	
Stripping length		mm	10	
Stripping length		in	0.4	
Tightening torque		Nm	2	
Tightening torque		lb-in	18	
Required tool			Torx key 20	

Rated power	P _{rated}	kW	0.75 ... 2.2	3 ... 5.5
Connection description			Motor connection	
Connection			X105	
Connection type			Pluggable	
Max. cable cross-section		mm ²	4	6
Max. cable cross-section		AWG	10	10
Stripping length		mm	8	8
Stripping length		in	0.3	0.3
Tightening torque		Nm	0.6	0.7
Tightening torque		lb-in	5.3	6.2
Required tool			Screwdriver 0.5 x 3.0	Screwdriver 0.6 x 3.5

Technical data

3-phase mains connection 480 V "Light Duty"

Rated data



3-phase mains connection 480 V "Light Duty"

Rated data

The output currents apply to these operating conditions:

- At switching frequency 2 kHz or 4 kHz: Ambient temperature max. 40 °C (104 °F).

Inverter			i510-P0.75/400-3	i510-P1.1/400-3	i510-P1.5/400-3	i510-P2.2/400-3
Rated power	P _{rated}	kW	1.1	1.5	2.2	3
Rated power	P _{rated}	hp	1.5	2	3	4
Mains voltage range			3/PE AC 340 V ... 528 V, 45 Hz ... 65 Hz			
Output voltage			3 AC 0 - 400/480 V			
Rated mains current						
without mains choke		A	3.9	4.2	5.1	7.3
with mains choke		A	-			
Apparent output power		kVA	2.4	2.8	3.9	5.1
Rated output current						
2 kHz		A	2.5	3.6	4.2	5.8
4 kHz		A	2.5	3.6	4.2	5.8
Power loss						
2 kHz		W	38	45	62	79
4 kHz		W	40	48	66	84
Overcurrent cycle 180 s						
Max. output current		A	3.2	4.5	5.3	7.2
Overload time	T ₁	s	60	60	60	60
Recovery time	T ₂	s	120	120	120	120
Max. output current during the recovery time		A	1.6	2.3	2.6	3.6
Overcurrent cycle 15 s						
Max. output current		A	4.2	6	7	9.6
Overload time	T ₁	s	3	3	3	3
Recovery time	T ₂	s	12	12	12	12
Max. output current during the recovery time		A	1.6	2.3	2.6	3.6
Cyclic mains switching			3 times per minute			
Brake chopper						
Max. output current			-			
Min. brake resistance			-			
Max. motor cable length shielded						
without EMC category		m	30			
Category C1 (2 kHz, 4 kHz, 8 kHz)		m	-			
Category C2 (2 kHz, 4 kHz, 8 kHz)		m	-			
Category C3 (2 kHz, 4 kHz, 8 kHz)		m	-			
Max. motor cable length unshielded						
without EMC category		m	60	80		



Technical data

3-phase mains connection 480 V "Light Duty"
Rated data

Inverter			i510-P3/400-3	i510-P4/400-3	i510-P5.5/400-3
Rated power	P_{rated}	kW	4	5.5	7.5
Rated power	P_{rated}	hp	5	7.5	10
Mains voltage range			3/PE AC 340 V ... 528 V, 45 Hz ... 65 Hz		
Output voltage			3 AC 0 - 400/480 V		
Rated mains current					
without mains choke		A	8.6	11.2	15.3
with mains choke		A	-		
Apparent output power		kVA	6.6	8.9	11.3
Rated output current					
2 kHz		A	7.6	9.8	13.2
4 kHz		A	7.6	9.8	13.2
Power loss					
2 kHz		W	102	137	172
4 kHz		W	108	145	183
Overcurrent cycle 180 s					
Max. output current		A	9.5	12.3	16.5
Overload time	T_1	s	60	60	60
Recovery time	T_2	s	120	120	120
Max. output current during the recovery time		A	4.7	6.2	8.3
Overcurrent cycle 15 s					
Max. output current		A	12.6	16.4	22
Overload time	T_1	s	3	3	3
Recovery time	T_2	s	12	12	12
Max. output current during the recovery time		A	4.7	6.2	8.3
Cyclic mains switching			3 times per minute		
Brake chopper					
Max. output current			-		
Min. brake resistance			-		
Max. motor cable length shielded					
without EMC category		m	50		
Category C1 (2 kHz, 4 kHz, 8 kHz)		m	-		
Category C2 (2 kHz, 4 kHz, 8 kHz)		m	-		
Category C3 (2 kHz, 4 kHz, 8 kHz)		m	-		
Max. motor cable length unshielded					
without EMC category		m	100		

Technical data

Dimensions
Fusing data



Fusing data



A residual current device (RCD) is optional.

Fusing data for UL/NEC compliant installations: [▶ Fusing data](#) 34

Inverter	Fuse		Circuit breaker		RCD	
	Characteristic	Max. rated current	Characteristic	Max. rated current	mA	Type
		A		A		
i510-P0.75/400-3	gG/gL, gRL	32	B	32	≥30	Typ B
i510-P1.1/400-3	gG/gL, gRL	32	B	32	≥30	Typ B
i510-P1.5/400-3	gG/gL, gRL	32	B	32	≥30	Typ B
i510-P2.2/400-3	gG/gL, gRL	32	B	32	≥30	Typ B
i510-P3/400-3	gG/gL, gRL	40	B	32	≥30	Typ B
i510-P4/400-3	gG/gL, gRL	40	B	32	≥30	Typ B
i510-P5.5/400-3	gG/gL, gRL	40	B	32	≥30	Typ B

Terminal data

[▶ Terminal data](#) 81

Dimensions



The specified installation clearances are minimum dimensions to ensure a sufficient air circulation for cooling purposes. They do not consider the bend radiuses of the connecting cables.



0.37 kW ... 2.2 kW

The dimensions in mm apply to:

0.37 kW	i510-P0.37/120-1	i510-P0.37/230-2			
0.75 kW	i510-P0.75/120-1	i510-P0.75/230-2		i510-P0.75/400-3	
1.1 kW			i510-P1.1/230-2		i510-P1.1/400-3
1.5 kW			i510-P1.5/230-2		i510-P1.5/400-3
2.2 kW					i510-P2.2/400-3
Weight	1.4 kg	1.4 kg	1.5 kg	1.4 kg	1.5 kg

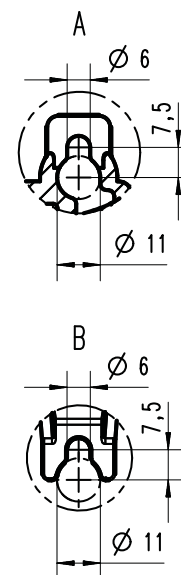
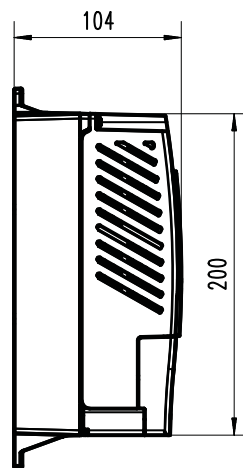
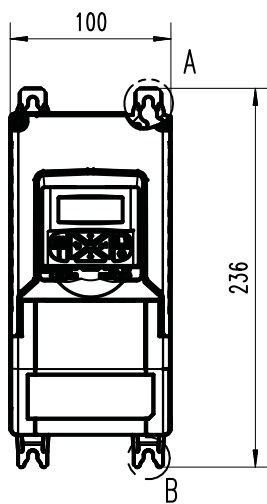
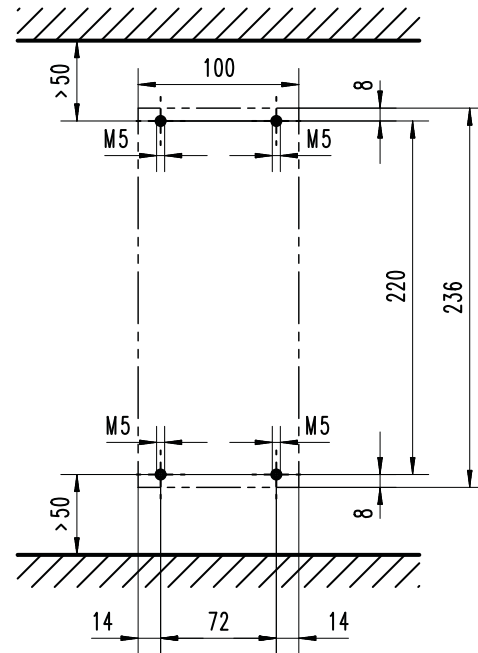
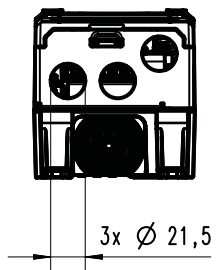

8800784

Technical data

Dimensions



0.5 hp ... 3 hp

The dimensions in inch apply to:

0.5 hp	i510-P0.37/120-1	i510-P0.37/230-2			
1 hp	i510-P0.75/120-1	i510-P0.75/230-2		i510-P0.75/400-3	
1.5 hp			i510-P1.1/230-2		i510-P1.1/400-3
2 hp			i510-P1.5/230-2		i510-P1.5/400-3
3 hp					i510-P2.2/400-3
Weight	3.1 lb	3.1 lb	3.3 lb	3.1 lb	3.3 lb

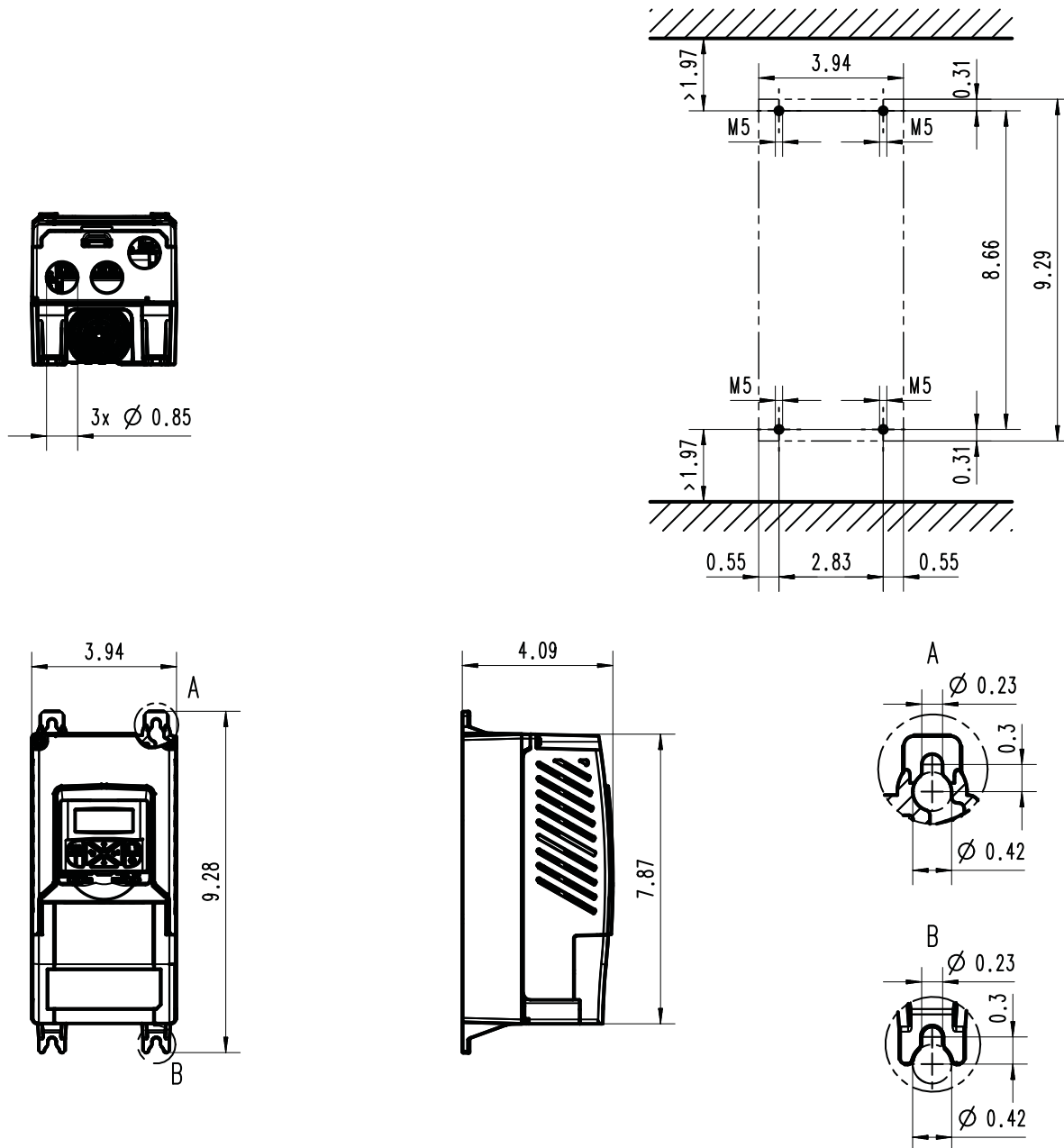

8800785



2.2 kW ... 5.5 kW

The dimensions in mm apply to:

2.2 kW	i510-P2.2/230-2		
3 kW		i510-P3.0/230-3	i510-P3/400-3
4 kW		i510-P4.0/230-3	i510-P4/400-3
5.5 kW			i510-P5.5/400-3
Weight	1.5 kg	1.6 kg	1.6 kg

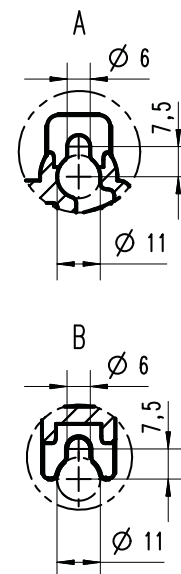
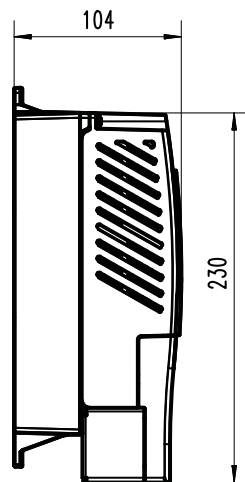
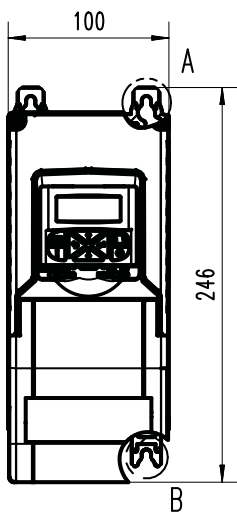
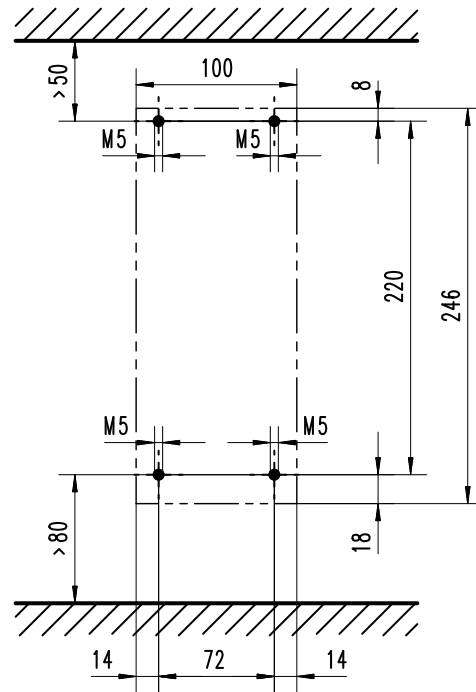
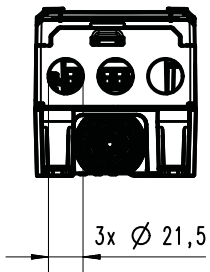

8800786

Technical data

Dimensions



3 hp ... 7.5 hp

The dimensions in inch apply to:

3 hp	i510-P2.2/230-2		
4 hp		i510-P3.0/230-3	i510-P3/400-3
5 hp		i510-P4.0/230-3	i510-P4/400-3
7.5 hp			i510-P5.5/400-3
Weight	3.3 lb	3.5 lb	3.5 lb

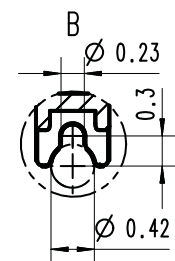
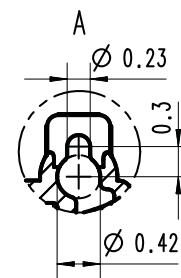
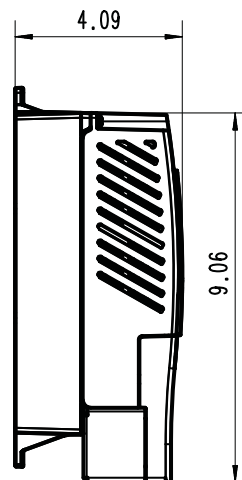
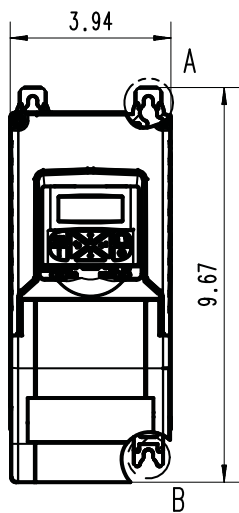
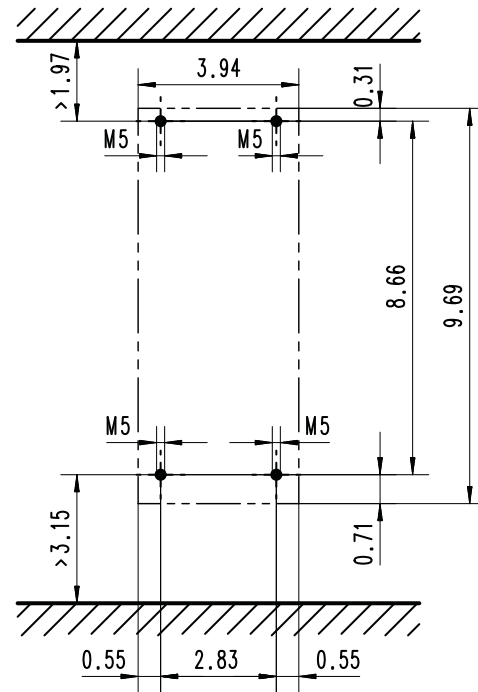
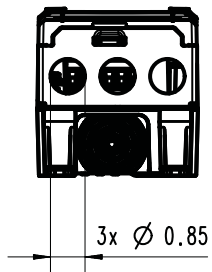

8800787



Product extensions

Overview

Integrated standard interfaces:

- Standard I/O (analog and digital inputs and outputs)
- Relay output

These **optional** product extensions provide further interfaces for the functions required for your application:

- Networks:
 - CANopen
 - Modbus RTU

Product extensions

I/O extensions
Standard I/O



I/O extensions

Standard I/O

The Standard I/O provides the inverter with analog and digital inputs and outputs and is designed for standard applications. The Standard I/O is available with different network options. ▶ [Networks](#) 95

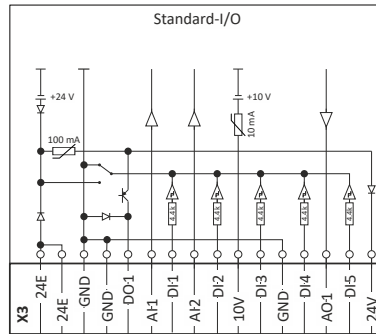

Control terminal X3		
Inputs/outputs	Terminal	Description
Digital inputs	DI1, DI2, DI3, DI4, DI5	DI3/DI4 can be optionally used as frequency or encoder input. HIGH-active/LOW-active switchable.
Digital outputs	DO1	
Analog inputs	AI1, AI2	Can be optionally used as voltage or current input.
Analog outputs	AO1	Can be optionally used as voltage or current output.
24-V input	24E	Mains-independent DC supply of the control electronics (incl. communication)
10-V output	10 V	Reference voltage for setpoint potentiometer
24-V output	24 V	
Reference potential	GND	
Connection system		Spring terminal, not pluggable



Product extensions

I/O extensions
Data of control connections

Data of control connections

Digital inputs

Switching type		PNP, NPN	Parameterisable
PNP switching level			
LOW	V	< +5	IEC 61131-2, type 1
HIGH	V	> +15	
NPN switching level			
LOW	V	> +15	
HIGH	V	< +5	
Input resistance	kΩ	4.6	
Cycle time	ms	1	
Electric strength of external voltage	V	± 30	

Frequency input			
Connection		X3/DI3, X3/DI4	
Frequency range	kHz	0 ... 100	

Encoder input			
Type		Incremental HTL encoder	
Two-track connection		X3/DI3 X3/DI4	Track A Track B
Frequency range	kHz	0 ... 100	

Digital outputs

Switching level			
LOW	V	< +5	IEC 61131-2, type 1
HIGH	V	> +15	
max. output current	mA	100	Total current for DO1 and 24V
Cycle time	ms	1	
Short-circuit strength		Unlimited period	
Electric strength of external voltage	V	± 30	
Polarity reversal protection		Integrated freewheeling diode for switching the inductive load	
Overload behaviour		Reduced voltage or periodic switch-off/on	
Reset or switch-on behaviour		Output is switched off	LOW

Product extensions

I/O extensions
Data of control connections



Analog inputs

Cycle time	ms	1	
Resolution of A/D converter	Bit	12	
Operation as voltage input			
Connection designation		X3/AI1, X3/AI2	
Input voltage DC	V	0 ... 10	
Input resistance	kΩ	70	
Accuracy	mV	± 50	Typical
Input voltage in case of open circuit	V	- 0.2 ... 0.2	Display "0"
Electric strength of external voltage	V	± 24	
Operation as current input			
Connection designation		X3/AI1, X3/AI2	
Input current	mA	0 ... 20 4 ... 20	open-circuit monitored
Accuracy	mA	± 0.1	Typical
Input current in case of open circuit	mA	< 0.1	Display "0"
Input resistance	Ω	< 250	
Electric strength of external voltage	V	± 24	

Analog inputs

Cycle time	ms	1	
Resolution of A/D converter	Bit	12	
Operation as voltage input			
Connection designation		X3/AI1, X3/AI2	
Input voltage DC	V	-10 ... 10	
Input resistance	kΩ	70	
Accuracy	mV	± 50	Typical
Input voltage in case of open circuit	V	- 0.2 ... 0.2	Display "0"
Electric strength of external voltage	V	± 24	
Operation as current input			
Connection designation		X3/AI1, X3/AI2	
Input current	mA	0 ... 20 4 ... 20	open-circuit monitored
Accuracy	mA	± 0.1	Typical
Input current in case of open circuit	mA	< 0.1	Display "0"
Input resistance	Ω	< 250	
Electric strength of external voltage	V	± 24	



Product extensions

I/O extensions
Data of control connections

Analog outputs

Short-circuit strength		Unlimited period	
Electric strength of external voltage	V	+ 24V	
Operation as voltage output			
Resolution of D/A converter	Bit	12	
Output voltage DC	V	0 ... 10	
max. output current	mA	5	
min. load resistance	kΩ	≥ 2.2	
max. capacitive load	μF	1	
Accuracy	mV	± 100	Typical
Operation as current output			
Output current	mA	0 ... 20	
		4 ... 20	open-circuit monitored
Accuracy	mA	± 0.3	Typical

10-V output

Use		Primarily for the supply of a potentiometer (1 ... 10 kΩ)	
Output voltage DC			
Typical	V	10	
Accuracy	mV	± 100	
Max. output current	mA	10	
Max. capacitive load	μF	1	
Short-circuit strength		Unlimited period	
Electric strength of external voltage	V	+ 24	

24-V input

Use		Input for mains-independent DC supply of the control electronics (incl. communication)	
Input voltage DC			
Typical	V	24	IEC 61131-2
Area	V	19.2 ... 28.8	
Input power			
Typical	W	3.6	
Max.	W	6	Depending on the use and state of inputs and outputs.
Input current			
Typical	A	0.150	
Max.	A	1.0	When switching on for 50 ms
Capacity to be charged	μF	440	
Polarity reversal protection		When polarity is reversed: No function and no destruction	
Suppression of voltage pulses		Suppressor diode 30 V, bidirectional	
Power supply unit		SELV/PELV	Externally to create a mains-independent DC supply
Max. current	A	8.0	While looping-through

24-V output

Use		Primarily for the supply of digital inputs	
Output voltage DC			
Typical	V	24	
Area	V	16 ... 28	
max. output current	mA	100	Total current for DO... and 24V
Short-circuit strength		Unlimited period	
Electric strength of external voltage	V	+ 30	
Excess current release		Automatically resettable	

Product extensions

Further control connections
Relay output



Further control connections

Relay output



Use a corresponding suppressor circuit in case of an inductive or capacitive load!

Connection		Terminal X9: COM		Common contact (Common)
		Terminal X9: NC		Normally closed contact
		Terminal X9: NO		Normally open contact
Minimum DC contact load				
Voltage		V	10	A correct switching of the relay contacts needs both values to be exceeded simultaneously.
Current		mA	10	
Switching voltage/switching current				
Maximum	AC 240 V	A	3	According to UL: General Purpose
	24 V DC	A	2	According to UL: Resistive
	240 V DC	A	0.16	

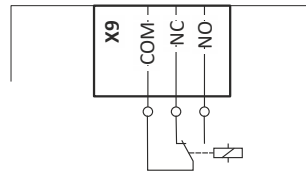



Networks

CANopen

CANopen is an internationally approved communication protocol which is designed for commercial and industrial automation applications. High data transfer rates in connection with efficient data formatting provide for the coordination of motion control devices in multi-axis applications.

Bus-related information			
Name		CANopen CiA 301 V4.2.0	
Communication medium		CAN cable in accordance with ISO 11898-2	
Use		Connection of inverter to a CANopen network	
Connection system		Pluggable double spring terminal	
Status display		2 LEDs	
Connection designation		X216: CH, CL, CG	

Technical data			
Bus terminating resistor	Ω	120	Terminated on both sides
Integrated bus terminating resistor		No	
Network topology			
Without repeater		Line	
With repeater		Line or tree	
Device			
Type		Slave	
Max. number without repeater		127	Per bus segment, incl. host system
Address		1 ... 127	Adjustable via code
Baud rate	kbps	20, 50, 125, 250, 500, 800 or 1000	Adjustable via code
Max. bus length	m	2500, 1000, 500, 250, 100, 50 or 25	Total cable length depends on the baud rate
Max. cable length between two devices		Not limited, the max. bus length is decisive	
Process data			
Transmit PDOs		3 TPDOs with 1 ... 8 Byte (adjustable)	
Receive PDOs		3 RPDOs with 1 ... 8 bytes (adjustable)	
Transmission mode for TPDOs			
With change of data		Yes	
Time-controlled, multiple of	ms	10	
After reception		1 ... 240 sync telegrams	
Parameter data			
SDO channels		Max. 2 servers	

Processing time of process data			
Update cycle	ms	10	In inverter
Processing time	ms	0 ... 1	
Application task runtime of the technology application used (tolerance)	ms	1 ... x	

Product extensions

Networks
Modbus RTU



Modbus RTU

Modbus is an internationally approved, asynchronous, serial communication protocol, designed for commercial and industrial automation applications.

Bus-related information			
Name		Modbus RTU	
Communication medium		RS485 (EIA)	
Use		Connection of inverter to a Modbus network	
Connection system		Pluggable double spring terminal	
Status display		2 LEDs	
Connection designation		X216: TA, TB, COM	

Technical data			
Communication profile		Modbus RTU	
Bus terminating resistor	Ω	120	Terminated on both sides
Integrated bus terminating resistor		No	
Network topology			
Without repeater		Line	
Device			
Type		Slave	
Max. number without repeater		32	Per bus segment, incl. host system
Max. number with repeater		90	
Address		1 ... 247	Adjustable via code
Baud rate	kbps	4.8 ... 115	Adjustable via code
Max. cable length	m	12 ... 600	Per bus segment, depending on the baud rate and the used cable type
Max. cable length between two devices		Not limited, the max. bus length is decisive	
Data channel			
SDO channels		Max. 2 servers, with 1 ... 8 bytes	Supported functions: Read Holding Registers Preset Single Register Preset Multiple Registers Read/Write 4 x registers



Accessories

Operation and diagnostics



The inverter can be configured and ordered with keypad module or WLAN module. The inverter is then delivered with the module mounted.

Keypad

Parameter setting and diagnostics

Thanks to the intuitive operating structure, the navigation keys allow a quick and easy access to the most important parameters, either to configure functions or to query current values. Parameters and actual values are indicated on the easy-to-read display.



USB module

Interface to the PC

Connect the inverter via a USB 2.0 connection cable to a PC on which the Lenze "EASY Starter" engineering tool is installed. Configure the inverter with the "EASY Starter" using graphical user interfaces. You can create diagnostics with trend functions or observe parameter values.

Parameterising without supplying the inverter with voltage: in many cases, the USB interface of the PC is sufficient for the voltage supply if you connect the inverter directly to the PC without a hub.



USB module	
Order code	Version
I5MADU0000000S	Parameterization without voltage supply of the inverter is possible. USB 2.0 connecting cable required

Connecting cable		
Order code	Length	Type
EWL0085/S	3 m	USB 2.0-connecting cable (A-plug to micro B-plug)
EWL0086/S	5 m	

Accessories

Operation and diagnostics
WLAN module



WLAN module

Communicate wirelessly with the inverter, via a PC using the Lenze Engineering Tool "EASY Starter" or the Lenze "SMART Keypad App" for Android and iOS smartphones.



⚠ WARNING!

- ▶ This product contains FCC ID: QQQWF121/IC: 5123A-BGTWF121
- ▶ To comply with FCC and Industry Canada RF radiation exposure limits for general population, the transmitter with its antenna must be installed such that a minimum separation distance of 20 cm is maintained between the radiator (antenna) and all persons at all times.
- ▶ This product must not be collocated or operated in conjunction with any other antenna or transmitter.
- ▶ -----
- ▶ Le produit contient un module transmetteur certifié FCC ID: QQQWF121/IC: 5123A-BGTWF121
- ▶ Afin de se conformer aux réglementations de la FCC et d'Industry Canada relatives aux limites d'exposition aux rayonnements RF pour le grand public, le transmetteur et son antenne doivent être installés de sorte qu'une distance minimale de 20 cm soit constamment maintenue entre le radiateur (antenne) et toute personne.
- ▶ Le produit ne doit pas être utilisé en combinaison avec d'autres antennes ou transmetteurs.

The module can be used if the certification is recognized in a country according to one of these standards.

Conformity and approvals		
CE	RED	EN 301489-1 V2.1.1:2016
		EN 301489-17 V3.1.1:2016
		EN 300328 V2.1.1:2016
FCC	Part 15.107/15.109 ICES-003	

Additional conformities and approvals:

- IC
- CMIIT

LED status displays			
LED 1	LED 2	LED 3	Meaning
Power (green)	TX/RX (yellow)	WLAN (green)	
Supply voltage status	Communication status	WLAN status	
OFF	OFF	OFF	No voltage
ON	ON	ON	Self-test (approx. 1 s)
ON	OFF	OFF	Ready for operation No active WLAN connection
ON	Flashing	ON	Communication active
ON	OFF	Blinking	Client Mode Waiting for connection
Blinking	OFF	OFF	Trouble



Accessories

Memory modules
WLAN module

Connection data (default setting)	
IP address	192.168.178.1
SSID	<Product type>_<10-digit identifier>
Password	password

Memory modules

For standard set-up, Lenze offers its customers multipacked, unwritten memory modules (EPM). In combination with the EPM copier, the EPMs can be duplicated at any location.

A memory module is included in the scope of supply of the inverter.



Memory module		
Order code	Type	VPE
		Piece
I0MAPA0000000M	Easily pluggable Duplicate data set with memory module copier	12

Memory module copier

For duplicating data on memory modules for a faster standard set-up.

The memory module copier is a copying system for all memory modules from Lenze. With the help of simple optical user guidance, the data of a module is copied quickly and reliably to another memory module.



Memory module copiers	
Order code	Type
EZAEDE1001	Data set copier for memory modules

Purchase order

Notes on ordering



Purchase order

Notes on ordering

You can order the frequency inverter i510 protec in the protection class NEMA 1 (IP20).

Additional feature options can be optionally configured during order placement.

- Rated power
- Mains voltage
- Application area (default parameter setting)
- Product extension (keypad module, WLAN module, fieldbus network CANopen or Modbus RTU)

The inverters are supplied as a complete device in the selected configuration.

Subsequent modification of the configured inverter is not possible. Only in this way can the compact design and the protection class be achieved and assured.

The selection can be made with the "EASY Product Finder" on the Lenze homepage.

»EASY Product Finder«

The »EASY Product Finder« helps you to configure your required product in next to no time. In addition, you can retrieve all important technical details such as data sheets, CAD data, and EPLAN data.

The link and the QR code lead directly to the "EASY Product Finder": [EASY Product Finder](#)





Order code

The following is a list of the information required to order an i510 protec frequency inverter.

Order example

Description of the component	Order code
Complete inverter	I51A P 222 F 0 0 0 0 1 002S
Rated power 2.2 kW (i510-P2.2/400-3)	
Three-phase mains connection 400 V	
Product version: Standard	
Safety technology: Without safety function	
Degree of protection: IP20 / NEMA 1	
Interference suppression: Without interference suppression	
Default parameter setting: Region US (60-Hz networks)	
Product extension: Standard I/O with CANopen	

Assignment of product name and order code

When listing the technical data of the various variants, the easily legible product name is used.

The product name contains the power in kW, mains voltage class and the number of phases.

This information results in the first 9 characters of the order code:

Complete inverter			
Power		Inverter	Order code
kW	hp		
Single-phase mains connection 120 V			
0.37	0.5	i510-P0.37/120-1	I51AP137A
0.75	1.0	i510-P0.75/120-1	I51AP175A
Single/three-phase mains connection 230/240 V			
0.37	0.5	i510-P0.37/230-2	I51AP137D
0.75	1.0	i510-P0.75/230-2	I51AP175D
1.1	1.5	i510-P1.1/230-2	I51AP211D
1.5	2.0	i510-P1.5/230-2	I51AP215D
2.2	3.0	i510-P2.2/230-2	I51AP222D
Three-phase mains connection 230/240 V			
3.0	4.0	i510-P3.0/230-3	I51AP230C
4.0	5.0	i510-P4.0/230-3	I51AP240C
Three-phase mains connection 400/480 V			
0.75	1.0	i510-P0.75/400-3	I51AP175F
1.1	1.5	i510-P1.1/400-3	I51AP211F
1.5	2.0	i510-P1.5/400-3	I51AP215F
2.2	3.0	i510-P2.2/400-3	I51AP222F
3.0	4.0	i510-P3.0/400-3	I51AP230F
4.0	5.0	i510-P4.0/400-3	I51AP240F
5.5	7.5	i510-P5.5/400-3	I51AP255F

The other positions of the order code indicate options and design variants. The following table shows the structure of the complete order code.

Purchase order

Order code



Order code structure

		I	5	1	A	P	□□□	□	□	□	□	□	□	□□□	
Product type	Inverter	I													
Product family	i500		5												
Product	i510			1											
Product generation	Generation 1				A										
Mounting type	Wall mounting					P									
Rated power (Examples)	0.37 kW						137								
	0.75 kW						175								
	2.2 kW						222								
Mains voltage and connection type	1/N/PE AC 120 V							A							
	3/PE AC 230/240 V							C							
	1/N/PE AC 230/240 V							D							
	3/PE AC 230/240 V							F							
	3/PE AC 400 V 3/PE AC 480 V								0						
Product variant	Standard								0						
Integrated functional safety	Without safety function									0					
Degree of protection	NEMA 1 (IP20), uncoated										0				
Interference suppression	Without											0			
Application area	Default parameter setting: Region EU (50-Hz networks)												0		
	Default parameter setting: Region US (60-Hz networks)												1		
Product extension	Standard I/O: ...													0	
	Keypad module with Standard I/O ...													K	
	WLAN module with Standard I/O ...													W	
	... without network														00S
	... with CANopen														02S
... with Modbus RTU														03S	



Environmental notes and recycling

Lenze has been certified to the worldwide DIN EN ISO 14001 environmental management standard for many years. As part of our environmental policy and the associated climate responsibility, please note the following information on hazardous ingredients and the recycling of Lenze products and their packaging:



Lenze products are partly subject to the EU Directive 2011/65/EU on the restriction of certain hazardous substances in electrical and electronic equipment (RoHS). This is documented accordingly in the EU declaration of conformity and with the CE mark.



Lenze products are not subject to EU Directive 2012/19/EU on waste electrical and electronic equipment (WEEE), but some contain batteries/rechargeable batteries in accordance with EU Directive 2006/66/EC (Battery Directive). The disposal route, which is separate from household waste, is indicated by corresponding labels with the "crossed-out trash can". Any batteries/rechargeable batteries included are designed to last the life of the product and do not need to be replaced or otherwise removed by the end user.



Lenze products are usually sold with cardboard or plastic packaging. This packaging complies with EU Directive 94/62/EC on packaging and packaging waste (Packaging Directive). The required disposal route is indicated by material-specific labels with the "recycling triangle".

Example: "21 - other cardboard"

REACH

Lenze products are subject to the European Regulation EC No. 1907/2006 (REACH Chemicals Regulation). When used as intended, exposure of substances to humans, animals and the environment is excluded.

Lenze products are industrial electrical and electronic products and are disposed of professionally. Both the mechanical and electrical components such as electric motors, gearboxes or inverters contain valuable raw materials that can be recycled and reused. Proper recycling and thus maintaining the highest possible level of recyclability is therefore important and sensible from an economic and ecological point of view.

- Coordinate professional disposal with your waste disposal company.
- Separate mechanical and electrical components, packaging, hazardous waste (e.g. gear oils) and batteries/rechargeable batteries wherever possible.
- Dispose of the separated waste in an environmentally sound and proper manner (no household waste or municipal bulky waste).

What?	Material	Disposal instructions
Pallets	Wood	Return to manufacturers, freight forwarders or reusable materials collection system
Packaging material	Paper, cardboard, pasteboard, plastics	Collect and dispose of separately
Products		
Electronic devices	Metal, plastics, circuit boards, heatsinks	As electronic waste give to professional disposer for recycling
Gearbox	Oil	Drain oil and dispose of separately
	Casting, steel, aluminium	Dispose as metal scrap
Motors	Casting, copper, rotors, magnets, potting compound	As engine scrap give to professional disposer for recycling
Dry-cell batteries/rechargeable batteries		As used batteries give to professional disposer for recycling



Further information on Lenze's environmental and climate responsibility and on the topic of energy efficiency can be found on the Internet:

www.Lenze.com → search word: "Sustainability"



Appendix

Good to know

Approvals and directives

CCC	China Compulsory Certification documents the compliance with the legal product safety requirements of the PR of China - in accordance with Guobiao standards.
c _{CSA} _{US}	CSA certificate, tested according to US and Canada standards
UE	Union Européenne documents the declaration of the manufacturer that EU Directives are complied with.
CEL	China Energy Label documents the compliance with the legal energy efficiency requirements for motors, tested according to the PR of China and Guobiao standards
CSA	CSA Group (Canadian Standards Association) CSA certificate, tested according to Canada standards
UL ^{Energy} _{US CA}	Energy Verified Certificate Determining the energy efficiency according to CSA C390 for products within the scope of energy efficiency requirements in the USA and Canada
c _{UL} _{US}	UL certificate for products, tested according to US and Canada standards
c _{UR} _{US}	UL certificate for components, tested according to US and Canada standards
EAC	Customs union Russia / Belarus / Kazakhstan certificate documents the declaration of the manufacturer that the specifications for the Eurasian conformity (EAC) required for placing electronic and electromechanical products on the market of the entire territory of the Customs Union (Russia, Belarus, Kazakhstan, Armenia and Kyrgyzstan) are complied with.
UL	Underwriters Laboratory Listed Product
UL _{LISTED}	UL Listing approval mark as proof that the product has been tested and the applicable safety requirements have been confirmed by UL (Underwriters Laboratory).
UR	UL Recognized Component approval mark as proof that the UL approved component can be used in a product or system bearing the UL Listing approval mark.



Operating modes of the motor

Operating modes S1 ... S10 as specified by EN 60034-1 describe the basic stress of an electrical machine.

In continuous operation a motor reaches its permissible temperature limit if it outputs the rated power dimensioned for continuous operation. However, if the motor is only subjected to load for a short time, the power output by the motor may be greater without the motor reaching its permissible temperature limit. This behaviour is referred to as overload capacity.

Depending on the duration of the load and the resulting temperature rise, the required motor can be selected reduced by the overload capacity.

The most important operating modes

Continuous operation S1	Short-time operation S2
<p>Operation with a constant load until the motor reaches the thermal steady state. The motor may be actuated continuously with its rated power.</p>	<p>Operation with constant load; however, the motor does not reach the thermal steady state. During the following standstill, the motor winding cools down to the ambient temperature again. The increase in power depends on the load duration.</p>
Intermittent operation S3	Non-intermittent periodic operation S6
<p>Sequence of identical duty cycles comprising operation with a constant load and subsequent standstill. Start-up and braking processes do not have an impact on the winding temperature. The steady-state is not reached. The guide values apply to a cycle duration of 10 minutes. The power increase depends on the cycle duration and on the load period/downtime ratio.</p>	<p>Sequence of identical duty cycles comprising operation with a constant load and subsequent no-load operation. The motor cools down during the no-load phase. Start-up and braking processes do not have an impact on the winding temperature. The steady-state is not reached. The guide values apply to a cycle duration of 10 minutes. The power increase depends on the cycle duration and on the load period/idle time ratio.</p>

P Power
t Time
 t_L Idle time
 ϑ Temperature

P_V Power loss
 t_B Load period
 t_S Cycle duration



Motor control types

The inverter provides various motor control types.

Linear V/f characteristic control

The output voltage is increased proportionately to the output frequency.

In case of low output frequencies, the motor voltage can be increased to ensure a minimum current for the breakaway torque. In the field weakening range, the output voltage of the inverter is constant (mains voltage) and the frequency can be further increased depending on the load. The maximum torque of the motor is reduced proportionately to the square of the frequency increase, the maximum output power of the motor being constant.

Application areas are for instance: Single drives with constant load.

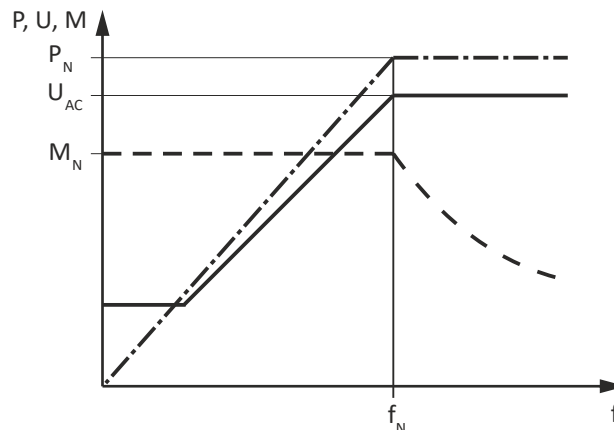

P	Power	M_{rated}	Rated torque
V	Voltage	f_{rated}	Rated frequency
M	Torque	M_{rated}	Rated torque
f	Frequency	f_{rated}	Rated frequency

Square-law V/f characteristic control

The output voltage is increased squarely to the output frequency.

In case of low output frequencies, the motor voltage can be increased to ensure a minimum current for the breakaway torque. In the field weakening range, the output voltage of the inverter is constant (mains voltage) and the frequency can be further increased depending on the load. The maximum torque of the motor is reduced squarely to the frequency increase, the maximum output power of the motor being constant.

Application areas are for instance:

- Pumps
- Fans
- Ventilators

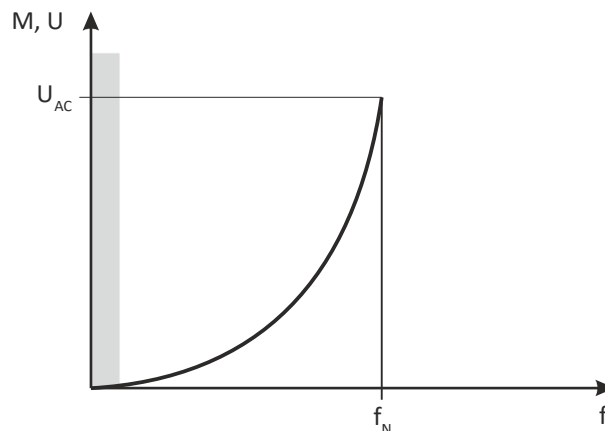

V	Voltage	U_{AC}	Mains voltage
f	Frequency	f_{rated}	Rated frequency
M	Torque		

VFCeco

The VFCeco mode has a special effect in the partial load operational range. Usually, three-phase AC motors are supplied there with a higher magnetising current than required by the operating conditions. The VFCeco mode reduces the losses in the partial load operational range so that savings up to 30 % are possible.

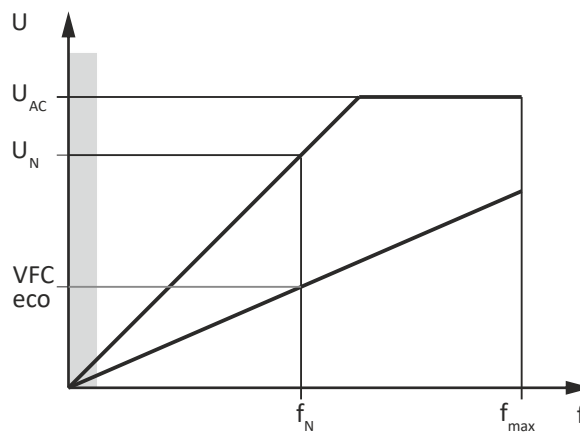

V	Voltage	f	Frequency
U_{AC}	Mains voltage	f_{rated}	Rated frequency
U_{rated}	Rated voltage	f_{max}	Max. frequency

Sensorless vector control (SLVC)

In vector control, an inverted voltage model is used for calculation. The parameters are detected via a parameter identification. The inverter determines the angle between current and voltage. This imposes a current on the motor".

Compared to the V/f characteristic control, the vector control serves to achieve improved drive characteristics thanks to:

- higher torque throughout the entire speed range
- higher speed accuracy and higher concentricity factor
- higher efficiency

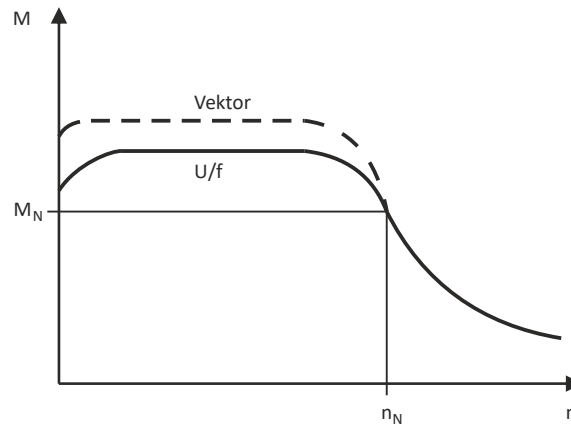

M	Torque	M_{rated}	Rated torque
n	Speed	n_{rated}	Rated speed

Application areas are for instance:

- Single drives with changing loads
- Single drives with high starting duty
- Sensorless speed control of three-phase AC motors

Switching frequencies

On an inverter, the term "switching frequency" is understood to mean the frequency with which the input and outputs of the output module (inverter) are switched. On an inverter, the switching frequency can generally be set to values between 2 and 16 kHz, whereby the selection is based on the respective power output.

As switching the modules cause heat losses, the inverter can provide higher output currents at low switching frequencies than at high frequencies. Additionally, it is distinguished between the operation at a permanently set switching frequency and a variably set switching frequency. Here, the switching frequency is automatically reduced as a function of the device utilization.

At a higher switching frequency, the noise generation is less.

Options for the switching frequency:

- 2 kHz
- 4 kHz
- 8 kHz
- 12 kHz
- 16 kHz
- variable (automatic adaptation)



Enclosures

The degree of protection indicates the suitability of a motor for specific ambient conditions with regard to humidity as well as the protection against contact and the ingress of foreign particles. The degrees of protection are classified by EN 60529.

The first code number after the code letters IP indicates the protection against the ingress of foreign particles and dust. The second code number refers to the protection against the ingress of humidity.

Code number 1	Degree of protection	Code number 2	Degree of protection
0	No protection	0	No protection
1	Protection against the ingress of foreign particles $d > 50$ mm. No protection in case of deliberate access.	1	Protection against vertically dripping water (dripping water).
2	Protection against medium-sized foreign particles, $d > 12$ mm, keeping away fingers or the like.	2	Protection against diagonally falling water (dripping water), 15° compared to normal service position.
3	Protection against small foreign particles $d > 2.5$ mm. Keeping away tools, wires or the like.	3	Protection against spraying water, up to 60° from vertical.
4	Protection against granular foreign particles, $d > 1$ mm, keeping away tools, wire or the like.	4	Protection against spraying water from all directions.
5	Protection against dust deposits (dust-protected), complete protection against contact.	5	Protection against water jets from all directions.
6	Protection against the ingress of dust (dust-proof), complete protection against contact.	6	Protection against choppy seas or heavy water jets (flood protection).

Glossary

Abbreviation	Meaning
AIE	Acknowledge In Error, error acknowledgement
AIS	Acknowledge In Stop, restart acknowledgement
OFF state	Triggered signal status of the sensors
CCF	Common Cause Error (also β -value)
EC_FS	Error Class Fail Safe
EC_SS1	Error-Class Safe Stop 1
EC_SS2	Error-Class Safe Stop 2
EC_STO	Error-Class Safe Torque Off Stop 0
ON state	Signal status of the safety sensor in normal operation
FIT	Failure In Time, $1 \text{ FIT} = 10^{-9} \text{ Error/h}$
FMEA	Failure Mode and Effect Analysis
FSoE	FailSafe over EtherCAT
GSDML	Device description file with PROFINET-specific data to integrate the configuring software of a PROFINET controller.
HFT	Hardware Failure Tolerance
Cat.	Category in accordance with EN ISO 13849-1
OSSD	Output Signal Switching Device, tested signal output
PELV	Protective Extra Low Voltage, extra-low voltage with safe isolation
PL	Performance Level according to EN ISO 13849-1
PM	Plus-Minus – switched signal paths
PP	Plus-Plus – switched signal paths
PS	PROFIsafe
PWM	Pulse width modulation
SCS	Safe crawling speed
SD-In	Safe Digital Input
SD-Out	Safe Digital Output
SELV	Safety Extra Low Voltage
SFF	Safe Failure Fraction
SIL	Safety Integrity Level in accordance with IEC 61508

