

Benennung/Description

**Blitz-Sirene 32 Töne**  
**Flash/Sounder 32 tones**

Artikel-Nummer  
 Material number

**439 X#0 XX**

Ausdruck ist nur zur Information und wird bei Änderung nicht berücksichtigt. / This printed copy is for information only and is subject to alteration.









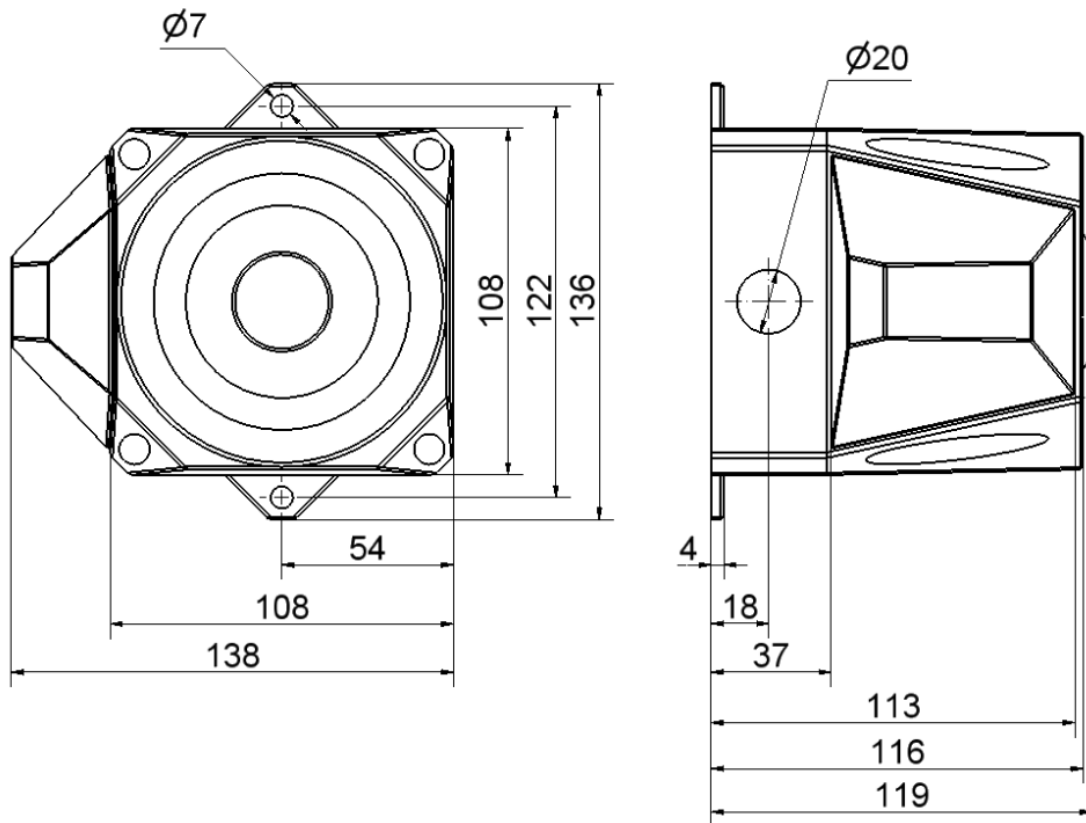



















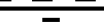





Bestell-Nr. / order no.		Gehäuse/ Housing		
<b>439 0#0 55</b>	9-60 VDC	RD	230 mA	ca. 430 g
<b>439 1#0 55</b>	9-60 VDC	GY	230 mA	ca. 425 g
<b>439 0#0 68</b>	115-230VAC	RD	30 mA	ca. 430 g
<b>439 1#0 68</b>	115-230VAC	GY	30 mA	ca. 425 g



# 1 = RD 3 = YE

Andere Spannungen auf Anfrage / other voltages available on request



								
								dB(A)
1	14	11111		800 & 970Hz	2Hz (250ms-250ms)	BS Fire Tone	102	
2	14	11110		800 & 970Hz	7Hz (7/s)	BS Fire Tone	103	
3	14	11101		800 & 970Hz	1Hz (1/s)	BS Fire Tone	105	
4	14	11100		2850Hz	Steady		107	
5	4	11011		2400 ~ 2850Hz	7Hz		111	
6	4	11010		2400 ~ 2850Hz	1Hz		113	
7	14	11001		300 ~ 1200Hz	3s Sweep, 0.5s silence, then repeat	Dutch Fire Tone	106	
8	14	11000		1200 ~ 500Hz	1Hz	DIN Tone	107	
9	4	10111		2400 & 2850Hz	2Hz (250ms-250ms)		108	
10	14	10110		970Hz	0.5Hz (1s On / 1s Off)		103	
11	14	10101		800 & 970Hz	1Hz (500ms-500ms)	BS Fire Tone	103	
12	4	10100		2850Hz	0.5Hz (1s On / 1s Off)		107	
13	14	10011		970Hz	0.8Hz (250ms On / 1s Off)		102	
14	14	10010		970Hz	Steady	BS Fire Tone	103	
15	14	10001		554 & 440Hz	100ms ~ 400ms	French Fire Tone	105	
16	16	10000		660Hz	3.3Hz (150ms On / 150ms Off)	Swedish Fire Tone	101	
17	17	01111		660Hz	0.28Hz (1.8s On / 1.8s Off)	Swedish Fire Tone	102	
18	18	01110		660Hz	0.05Hz (13s Off / 6.5Hz On)	Swedish Fire Tone	102	
19	19	01101		660Hz	Steady	Swedish Fire Tone	102	
20	20	01100		554 & 440Hz	0.5Hz (1s On / 1s Off)	Swedish Fire Tone	105	
21	21	01011		660Hz	1Hz (500ms ~ 500ms)	Swedish Fire Tone	102	
22	14	01010		2850Hz	4Hz (150ms On / 100ms Off)	Pelican Crossing	106	
23	14	01001		800 ~ 970Hz	50Hz	BS Fire Tone	103	
24	4	01000		2400 ~ 2850Hz	50Hz		110	
25	25	00111		970Hz	3 x 500ms pulses followed by 1.5s silence then repeat	ISO 8201	103	
26	26	00110		970 & 800Hz	3 x 500ms pulsed sweep followed by 1.5s silence	ISO 8201	104	
27	27	00101		4000Hz	3 x 500ms pulsed two tone followed by 1.5s silence		103	
28	10	00100		800 & 970Hz	2Hz (250ms ~ 250ms)	BS Fire Tone	103	
29	988Hz	00011		990 & 650Hz	2Hz (250ms ~ 250ms) (Symphoni Tones)	BS Fire Tone	105	
30	510Hz	00010		510 & 610Hz	2Hz (250ms ~ 250ms) (Squashni Micro Tones)	BS Fire Tone	104	
31	31	00001		300 ~ 1200Hz	1Hz		106	
32	32	00000		510 & 610Hz	1Hz (500ms ~ 500ms)		105	

<b>Elektrische Daten</b>		<b>Electrical specifications</b>	
Blitzfrequenz	ca. 1 Hz	Flashing frequency	ca. 1 Hz
Blitzleistung	ca. 2 Ws	Flashing energy	ca. 2 Ws
Einschaltdauer	100 % ED	Duty cycle	100 %
Lautstärke	105 dB(A) / 1m	Volume	105 dB(A) / 1m
Spannungsbereich	9 - 60 V ± 0% 115 - 230 V ± 0%	Voltage range	9 - 60 V ± 0% 115 - 230 V ± 0%
Stromaufnahme	Siehe Liste	Current consumption	See list
Tonart	32 Töne	Tone type	32 tones
Tonfrequenz	ca. 300 - 4000 Hz	Tone frequency	ca. 300 - 4000 Hz
<b>Mechanische Daten</b>		<b>Mechanical specifications</b>	
Anschluss	Anschlussklemme mit Drahtschutz 0,25-2,5mm <sup>2</sup> eindräh- tig/ 0,25-1,5mm <sup>2</sup> mit Ader- endhülse	Connection	Terminal clamp with wire protection single wire / 0,25-1,5mm <sup>2</sup> with ferrule
Befestigung	Wandmontage	Fixing	Wall mounting
Einbaulage	Schallaustritt nicht nach oben	Installation position	Accoustics outlet not facing upwards
Kabeleinführung	Kabelverschraubung M20x1,5 (nicht im Lieferum- fang enthalten)	Cable entry	Cable gland M20x1,5 (not included in delivery)
Schutzart	IP66 in montiertem Zustand	Protection rating	IP66 when mounted
Temperatur	-25° ... +70 °C	Temperature	-25° ... +70 °C
Umgebungs- bedingungen	Verschmutzungsgrad 3, U <sub>i</sub> = 250V; U <sub>imp</sub> = 2.500V, Überspannungskategorie II	Environmental conditions	Pollution degree 3, U <sub>i</sub> = 250V; U <sub>imp</sub> = 2.500V, Overvoltage category II
Werkstoff Gehäuse	ABS	Material housing	ABS
Werkstoff Kalotte	PC	Material dome	PC
<b>Sonstige Daten</b>		<b>Other specifications</b>	
Hinweis	Alle Angaben beziehen sich auf U <sub>nenn</sub> und Raumtemperatur. Die Hinweise der Montageanlei- tung sind zu beachten.	Note	All specifications refer to U <sub>nom</sub> and room temperature. The advice contained in the instal- lation instruction is to be observed.
Vorschriften	Die zutreffenden EU-Richtlinien werden erfüllt.	Regulations	Conforms to current EU Directives.
Zulassung		Approval	

