

WEG Standard Product Catalog

Motors, Drives, Enclosed Motor Controls, Gears, and Alternators

2020

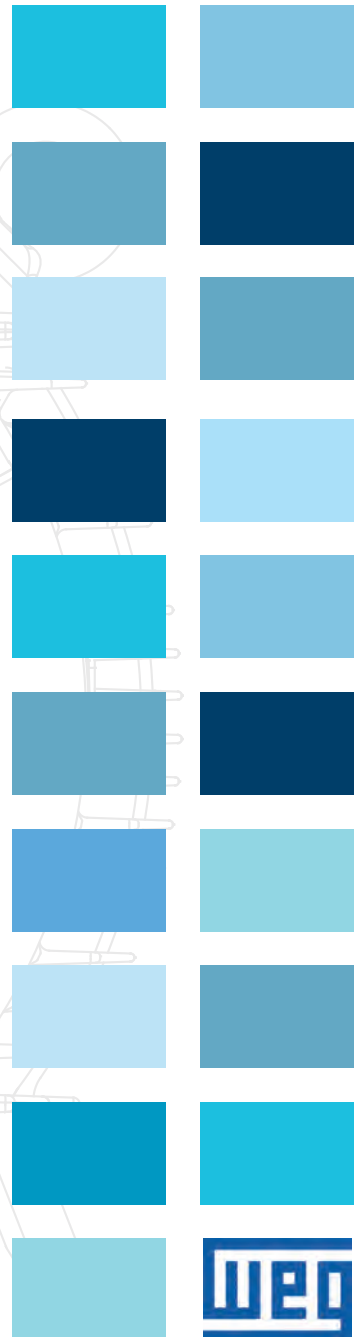

Register to keep your
catalog up-to-date





What's NEW



Encapsulated Wash Down Duty Motors page A-126



WITH EXCLUSIVE
EZ CONNECT
TECHNOLOGY

Rolled Steel Brake Motors page A-70, A-269



W40 Cast Iron Motors

General Purpose, Fire Pump, Close Couple JP and JM



Variable Frequency Drives Enclosed Motor Controls page A-313



Low and Medium Voltage

Motor Scan 4.0 page A-287

- MANAGEMENT OF MAINTENANCE
- VIBRATION
- TEMPERATURE
- CONFIGURATION OF WARNING LIMITS
- BLUETOOTH®
- RUNNING HOURS



Single-Phase General Purpose Motors - (A-17)

SECTION A

TEFC – Foot Mount	A-19
TEFC – C-Face – Foot Mount	A-21
TEFC – C-Face – Footless	A-22
TEFC – Foot Mount – Thermally Protected	A-22
ODP – Foot Mount	A-23
ODP – Resilient Base	A-24
ODP – C-Face – Foot Mount	A-25
ODP – C-Face – Footless	A-26
ODP – Foot Mount – Thermally protected	A-26

Three-Phase General Purpose Motors - (A-28)

TEFC – Foot Mount	A-32
TEFC – C-Face – Foot Mount	A-42
TEFC – C-Face – Footless	A-46
ODP – Foot Mount	A-50
ODP – C-Face – Foot Mount	A-56
ODP – C-Face – Footless	A-60
ODP – Resilient Base	A-60

IEEE 841 – Three-Phase

TEFC – Foot Mount – NEMA Premium®	A-62
TEFC – C-Face – Foot Mount – NEMA Premium®	A-66
TEFC – C-Face – Footless – NEMA Premium®	A-67

BRAKE MOTORS – Three-Phase

TEFC – Foot Mount - Cast Iron	A-69
TEFC – Foot Mount – Rolled Steel	A-71
TEFC – C-Face – Foot Mount – Rolled Steel	A-72
TEFC – C-Face – Footless – Rolled Steel	A-72

IEC TRU-METRIC™ - Three-Phase

TEFC – Foot Mount	A-75
TEFC – Foot Mount – FF-Face	A-78

Super Premium Efficiency Motors - (A-79)

GENERAL PURPOSE – Three-Phase

TEFC – Foot Mount – Super Premium	A-80
-----------------------------------	------

Severe Duty – Three-Phase Motors - (A-83)

GENERAL PURPOSE

TEFC – Foot Mount	A-86
TEFC – C-Face – Foot Mount	A-93
TEFC – C-Face – Footless	A-95

IEEE 841

TEFC – Foot Mount	A-97
TEFC – C-Face – Foot Mount	A-101
TEFC – C-Face – Footless	A-102

CRUSHER DUTY

TEFC – Foot Mount	A-105
-------------------	-------

VECTOR DUTY

TENV – Foot Mount – Double C-Face	A-107
-----------------------------------	-------

IEC TRU-METRIC™

TEFC – Foot Mount IE3	A-109
TEFC – Foot Mount - FF-Face Motors	A-110

Single-Phase General Purpose Motors
Three-Phase General Purpose Motors
Super Premium Efficiency Motors
Severe Duty - Three-Phase Motors
IoT Solutions Motor Scan
Explosion Proof Motors
Wash Down Duty
Alternators
Fractional Motors
DC Motors and Gearmotors
Air Handling Motors
Speed Reducers
Pump Motors
VFDs and Enclosed Motor Controls
IEC Motors
Parts & Modifications
Farm Duty Motors
Electrical Data
Definite Purpose Motors
Mechanical Data
Medium Voltage Motors and Soft Starters
Catalog Index

Continued on next page

Table of Contents

SECTION A

Single-Phase General Purpose Motors	Three-Phase General Purpose Motors	Super Premium Efficiency Motors	Severe Duty - Three-Phase Motors	Exposion Proof Motors	Alternators	DC Motors and Gearmotors	Speed Reducers	VFD's and Enclosed Motor Controls	Parts & Modifications	Electrical Data	Mechanical Data	Catalog Index
				lot Solutions Motor Scan	Wash Down Duty	Fractional Motors	Air Handling Motors	Pump Motors	IEC Motors	Farm Duty Motors	Definite Purpose Motors	Medium Voltage Motors and Soft Starters

Explosion Proof Motors - (A-111)

SINGLE-PHASE

Foot Mount	A-113
C-Face – Foot Mount	A-113

THREE-PHASE

Foot Mount	A-115
C-Face – Foot Mount	A-119
C-Face – Footless	A-120
JP – Foot Mount	A-120
ATEX Foot Mount	A-123

Washdown Duty - (A-126)

HYDRODUTY™ - STAINLESS STEEL

TEFC – Three-Phase - C-Face Foot Mount	A-129
TENV – Three-Phase - C-Face Foot Mount	A-129
TEFC – Three-Phase C-Face Footless	A-130
TENV – Three-Phase C-Face Footless	A-130
C-Face Foot Mount Optimal Match CFW08 Washdown Drive	A-131
C-Face Footless Optimal Match CFW08 Washdown Drive	A-132

PICKERPLUS™ - WHITE EPOXY

TEFC - Three-Phase - C-Face Foot Mount	A-133
TEFC – Three-Phase C-Face Footless	A-133

SHARK™ - STAINLESS STEEL

TEFC - Three-Phase - C-Face Foot Mount	A-134
TENV - Three-Phase - C-Face Foot Mount	A-134
TEFC – Three-Phase C-Face Footless	A-135
TENV – Three-Phase C-Face Footless	A-135
C-Face Foot Mount Optimal Match CFW08 Washdown Drive	A-136
C-Face Footless Optimal Match CFW08 Washdown Drive	A-137

HYDROWASH™ - WHITE EPOXY

TEFC - Three-Phase - C-Face Foot Mount	A-138
TENV - Three-Phase - C-Face Foot Mount	A-138
TEFC – Three-Phase C-Face Footless	A-138
TEFC – Three-Phase C-Face Footless	A-138
C-Face Foot Mount Optimal Match CFW08 Washdown Drive	A-139
C-Face Footless Optimal Match CFW08 Washdown Drive	A-139

WASHDOWN DUTY VARIABLE FREQUENCY DRIVE

CFW08 Washdown VFD - NEMA 4X Enclosure	A-142
CFW08 Options and Accessories	A-143
Dynamic Braking Resistors for CFW08 Wash	A-144
CFW08 Technical Data	A-145

Fractional Motors - (A-146)

SINGLE-PHASE

TEFC – Foot Mount	A-149
TEFC – C-Face – Foot Mount	A-150
TEFC – C-Face – Footless	A-150
TEFC – Foot Mount – Thermally Protected	A-151
ODP – Foot Mount	A-152
ODP – Resilient Base	A-153
ODP – C-Face – Foot Mount	A-154
ODP – C-Face – Footless	A-155
ODP – Foot Mount – Thermally Protected	A-155

Continued on next page

Fractional Motors - *continued*

THREE-PHASE

TEFC – Foot Mount	A-156
TEFC – C-Face – Foot Mount	A-157
TEFC – C-Face – Footless	A-158
ODP – Foot Mount	A-159
ODP – C-Face – Foot Mount	A-160
ODP – C-Face – Footless	A-161
ODP – Resilient Base	A-161

DC MOTORS

NEMA 56 PMDC Motors	A-162
NEMA 145TC PMDC Motors	A-162

EXPLOSION PROOF - SINGLE-PHASE

Foot Mount	A-164
C-Face – Foot Mount	A-164

EXPLOSION PROOF - THREE-PHASE

Foot Mount	A-165
C-Face – Foot Mount	A-165

Air Handling Motors - (A-166)

COMMERCIAL HVAC MOTORS

TEFC – Single-Phase – Foot Mount	A-168
TEAO – Single-Phase – Resilient Base	A-168
TEAO – Single-Phase – Foot Mount	A-168
ODP – Single-Phase – Foot Mount	A-169
ODP – Single-Phase – Resilient Base	A-170
ODP – Three-Phase – Resilient Base	A-171
ODP – Single-Phase – Evaporative Cooler	A-171

HVAC MOTORS - WITH INTERNAL AEGIS® SGR

TEFC – Three-Phase – Foot Mount	A-172
ODP – Three-Phase – Foot Mount	A-176

COOLING TOWER MOTORS – THREE-PHASE

TEFC – Three-Phase – Foot Mount – NEMA Premium®	A-180
TEAO – Three-Phase – Foot Mount – NEMA Premium®	A-183
TEFC – Three-Phase – Double Speed (1 & 2 Windings) – High Efficiency	A-185

PAD MOUNT MOTORS – Three-Phase

TEAO – NEMA Premium®	A-189
----------------------	-------

Pump Motors - (A-190)

JET PUMP SINGLE-PHASE (56C/56J FRAMES)

TEFC – Foot Mount	A-192
TEFC – Footless	A-192
ODP – Foot Mount	A-193
ODP – Footless	A-193

JET PUMP THREE-PHASE (56C/56J FRAMES)

TEFC – Foot Mount	A-194
TEFC – Footless	A-194
ODP – Foot Mount	A-195
ODP – Footless	A-195

Continued on next page

Single-Phase General Purpose Motors
Three-Phase General Purpose Motors
Super Premium Efficiency Motors
Severe Duty - Three-Phase Motors
Explosion Proof Motors
Alternators
DC Motors and Gearmotors
Speed Reducers
VFDs and Enclosed Motor Controls
Parts & Modifications
Electrical Data
Mechanical Data
Catalog Index

IoT Solutions Motor Scan
Wash Down Duty
Fractional Motors
Air Handling Motors
Pump Motors
IEC Motors
Farm Duty Motors
Definite Purpose Motors
Medium Voltage Motors and Soft Starters

SECTION A

Pump Motors - *continued*

POOL & SPA SINGLE-PHASE MOTORS

ODP – C-Face – Start Capacitor – High Service Factor	A-197
ODP – Square Face – Start Capacitor – High Service Factor	A-197
ODP – C-Face – Start Capacitor – Low Service Factor	A-198
ODP – Square Face – Start Capacitor – Low Service Factor	A-198

CLOSE-COUPLED PUMP TEFC MOTORS

JM – TEFC – Single-Phase	A-199
JP – TEFC – Single-Phase	A-200
JM – TEFC – Three-Phase	A-202
JP – TEFC – Three-Phase	A-206
JP – TEFC – Explosion Proof	A-209

CLOSE-COUPLED PUMP ODP MOTORS

JM – ODP – Single-Phase	A-210
JP – ODP – Single-Phase	A-210
JM – ODP – Three-Phase	A-211
JM – ODP – Three-Phase – Footless Vertical	A-214
JP – ODP – Three-Phase	A-215
JP – ODP – Three-Phase – Footless Vertical	A-218

CLOSE-COUPLED PUMP TEFC MOTORS - WITH INTERNAL AEGIS® SGR

JM – TEFC – Three-Phase	A-220
JP – TEFC – Three-Phase	A-221

CLOSE-COUPLED PUMP ODP MOTORS - WITH INTERNAL AEGIS® SGR

JM – ODP – Three-Phase	A-222
JP – ODP – Three-Phase	A-223

FIRE PUMP MOTORS

ODP – Three-Phase	A-225
ODP – Three-Phase – C-Face	A-227
ODP – Three-Phase – JM - Footless Vertical	A-228
ODP – Three-Phase – JP - Footless Vertical	A-229
TEFC (50Hz) – Three-Phase – IE2	A-231

P-BASE MOTORS

TEFC – Three-Phase – NEMA Premium®	A-233
------------------------------------	-------

IEC Motors - (A-236)

TRU-METRIC™

TEFC – Foot Mount	A-238
TEFC – Foot Mount - FF-Face	A-241

ATEX MOTORS

TEFC – Ex ec	A-243
TEFC – Ex d b- IE2	A-248

Continued on next page

Single-Phase General Purpose Motors
Three-Phase General Purpose Motors
Super Premium Efficiency Motors
Severe Duty - Three-Phase Motors
Explosion Proof Motors
Alternators
DC Motors and Gearmotors
Speed Reducers
VFDs and Enclosed Motor Controls
Parts & Modifications
Electrical Data
Mechanical Data
Catalog Index

IoT Solutions Motor Scan
Wash Down Duty
Fractional Motors
Air Handling Motors
Pump Motors
IEC Motors
Farm Duty Motors
Definite Purpose Motors
Medium Voltage Motors and Soft Starters

Farm Duty Motors - (A-250)

TEFC – Single-Phase – General Purpose – Foot Mount	A-252
TEFC – Single-Phase – Auger Drive – Footless	A-253
TEAO – Single-Phase – Poultry Fan – Foot Mount	A-253
TEAO – Single-Phase – Poultry Fan – Resilient Base	A-253
TEAO – Three-Phase – Grain Dryer/Vane Axial Fan	A-254
TEAO – Single-Phase – Grain Dryer/Vane Axial Fan	A-254
TEAO – Single-Phase – Aeration Fan	A-254
TEAO – Three-Phase – Aeration Fan	A-254
TEFC – Single-Phase – C-Face - Foot Mount - Irrigation Duty	A-255
TEFC – Three-Phase – C-Face - Foot Mount - Irrigation Duty	A-255
Irrigation Drive Motors	A-256
Jet End Booster Pump Motors	A-256

Definite Purpose Motors - (A-257)

VECTOR DUTY MOTORS

TENV – Three-Phase – Foot Mount – Double C-Face	A-258
---	-------

OIL WELL PUMPING – TEFC

TEFC – Three-Phase – NEMA Design 'D'	A-261
--------------------------------------	-------

COMPRESSOR DUTY MOTORS

ODP – Single-Phase – Foot Mount	A-263
ODP – Three-Phase – Foot Mount – NEMA Premium®	A-264

HYDRAULIC PUMP MOTORS

TEFC – Three-Phase – SAE-A – High Efficiency	A-265
--	-------

BRAKE MOTORS

TEFC – Foot Mount - Cast Iron	A-267
TEFC – Foot Mount - Rolled Steel	A-269
TEFC – C-Face – Foot Mount - Rolled Steel	A-270
TEFC – C-Face – Footless - Rolled Steel	A-270

SAW ARBOR MOTORS

TEFC – Three-Phase – Right-Hand Thread	A-271
TEFC – Three-Phase – Left-Hand Thread	A-271

SOOT BLOWER MOTORS

TEFC – C-Face – Footless	A-272
--------------------------	-------

Medium Voltage Motors and Soft Starters (A-273)

W22 Severe Duty Motors – TEFC

W22 Medium Voltage Motors – TEFC 2300 – 4160V	A-275
W22 Medium Voltage Motors – TEFC Add-On Modifications	A-276
W22 Medium Voltage 2300V - Electrical Data	A-277
W22 Medium Voltage 4160V - Electrical Data	A-279
Mechanical Data	A-281
Medium Voltage Worksheet	A-285
SSW7000C Medium Voltage Soft Starter	A-286

Motor Scan 4.0 - (A-287)

Motor Scan 4.0	A-287
Motor Scan Gateway	A-287
Motor Scan Technical Information	A-288

SECTION A

	Single-Phase General Purpose Motors
	Three-Phase General Purpose Motors
	Super Premium Efficiency Motors
	Severe Duty - Three-Phase Motors
IoT Solutions Motor Scan	Explosion Proof Motors
Wash Down Duty	Alternators
Fractional Motors	DC Motors and Gearmotors
Air Handling Motors	Speed Reducers
Pump Motors	VFDs and Enclosed Motor Controls
IEC Motors	Parts & Modifications
Farm Duty Motors	Electrical Data
Definite Purpose Motors	Mechanical Data
Medium Voltage Motors and Soft Starters	Catalog Index

Continued on next page

SECTION A

Synchronous Alternators - (A-289)

G Plus Line	A-290
AG10 Line	A-291
Modifications	A-292

DC Motors and Gearmotors - (A-293)

Permanent Magnet DC Motors

Brushes for RAE "MT" Motors	A-293
NEMA 56 PMDC Motors	A-294
NEMA 145TC PMDC Motors	A-294
M1600 Permanent Magnet Motor - 2.375" diameter	A-295
M4000 Permanent Magnet Motor - 3.12" diameter	A-295
Mechanical Data	A-296

Parallel Shaft Gearmotors

GIL 100 Series Gearbox	A-297
GIL 200 Series Gearbox	A-298

Right Angle Gearmotors

G33 Series Single Worm Reduction	A-299
----------------------------------	-------

Speed Reducers - (A-300)

How to Order Information	A-300
TG-90™ Quill Type Speed Reducers	A-302
TG-90™ Solid Shaft Speed Reducers	A-306
Dimensions	A-310

Variable Frequency Drives and Enclosed Motor Controls - (A-313)

(for complete line of products see WEG's Automation Catalogs)

CFW300 Variable Frequency Drive	A-314
CFW500 Variable Frequency Drive	A-319
CFW700 Variable Frequency Drive	A-325
CFW08 Wash - Washdown Duty VFD	A-333
EDP11 - Enclosed VFD Panel	A-339
EDP11 - Enclosed VFD Panel - Dimensions	A-349
GPH2 - Combination Soft Starter	A-351
GPH2 - Combination Soft Starter - Dimensions	A-357
ESW Non-Combination Across the Line Starters - 3 Phase - Enclosure Type 1	A-363
ESW Non-Combination Across the Line Starters - Non-reversing - Single-Phase - Enclosure Type 1	A-364
ESW/ESWS Starters and Field Mod Kits	A-365
ESW Wiring Diagram and Dimensions	A-366
PESW Non-Combination Across the Line Starters - Enclosure Type 4X - Three Phase	A-368
PESW Non-Combination Across the Line Starters - Enclosure Type 4X - Single Phase	A-370
PESW Wiring Diagram and Dimensions	A-371
ESWC Combination Type-C Across the Line Starter	A-373
ESWE Combination Type-E Across the Line Starter Enclosure Type 4X - without CPT	A-376
ESWE Combination Type-E Across the Line Starter Enclosure Type 4X - with CPT	A-376
ESWF Combination Type-F Across the Line Starter Enclosure Type 4/12 - without CPT	A-379
ESWF Combination Type-F Across the Line Starter Enclosure Type 4/12 - with CPT	A-380
ESWX Part Number Breakdown	A-381
ESWX-M16 Series Explosion Proof Manual Motor Starters	A-383
ESWX-M25 Series Explosion Proof Manual Motor Starters	A-384

Continued on next page

Single-Phase General Purpose Motors
Three-Phase General Purpose Motors
Super Premium Efficiency Motors
Severe Duty - Three-Phase Motors
Explosion Proof Motors
Alternators
DC Motors and Gearmotors
Speed Reducers
VFDs and Enclosed Motor Controls
Parts & Modifications
Electrical Data
Mechanical Data
Catalog Index

IoT Solutions Motor Scan
Wash Down Duty
Fractional Motors
Air Handling Motors
Pump Motors
IEC Motors
Farm Duty Motors
Definite Purpose Motors
Medium Voltage Motors and Soft Starters

Variable Frequency Drives and Enclosed Motor Controls - *continued*

ESWX-M65 Series Explosion Proof Manual Motor Starters.....	A-384
ESWX-M100 Series Explosion Proof Manual Motor Starters.....	A-384
Accessories	A-385
ESWX NEMA 7/9 Series Explosion Proof Manual Motor Starters.....	A-386
ESWX Dimensional Data	A-387
Custom Control Panels Data Worksheet and Request for Quote	A-390

Medium Voltage Starters

SSW7000C - 2300V and 4160V	A-393
SSW7000C Options.....	A-394
SSW7000C Dimensions	A-394
SSW7000C Technical Data	A-396

Add-On Modifications and Parts - (A-397)

In-House Modifications	A-398
Factory Built Modifications	A-402
Parts.....	A-406

SECTION B

Electrical Data	B-1
------------------------------	------------

Mechanical Data.....	B-54
-----------------------------	-------------

Product Index	B-117
----------------------------	--------------

**For complete line of Automation Products see WEG's
Automation Catalogs**

Quick Links @ www.weg.net



Single-Phase
General Purpose
Motors

Three-Phase
General Purpose
Motors

Super Premium
Efficiency Motors

Severe Duty -
Three-Phase
Motors

IoT Solutions
Motor Scan

Explosion Proof
Motors

Wash Down Duty

Alternators

Fractional
Motors

DC Motors and
Gearmotors

Air Handling
Motors

Speed Reducers

Pump Motors

VFD's and
Enclosed Motor
Controls

IEC
Motors

Parts &
Modifications

Farm Duty
Motors

Electrical Data

Definite Purpose
Motors

Mechanical Data

Medium Voltage
Motors and Soft
Starters

Catalog Index

W22 Severe Duty Motors – TEFC

Components Design

Optimal Cooling System

Fan Cover

- Aerodynamic design
- Minimal noise levels
- Superb air flow distribution over frame
- Superior mechanical strength

Fan

- Reinforced fan hub structure
- Low noise design with exceptional air flow

Frame

- Terminal box position outlet on top 447T and larger
- Low temperature on windings and bearings
- Low noise design

Pad for vibration sensor

- Displaced 90° from each other

Enhanced Lifting Provisions

- Easy handling - horizontal & vertical
- Superior mechanical strength and handling safety

Solid feet

- Impact resistance
- Ideal for high vibration level applications

Endshields Subsystem

DE (Drive Endshield)

- Fin design increases air flow
- Bearing moved outwards for better load support
- Bearing heat dissipation for reduced bearing temperature
- Reinforced endshield structure

NDE (Non-Drive Endshield)

- Smooth exterior surface
- Optimal air flow
- Designed for low noise
- Structural rigidity for low vibration
- Insulated housing standard on L447/9T and above

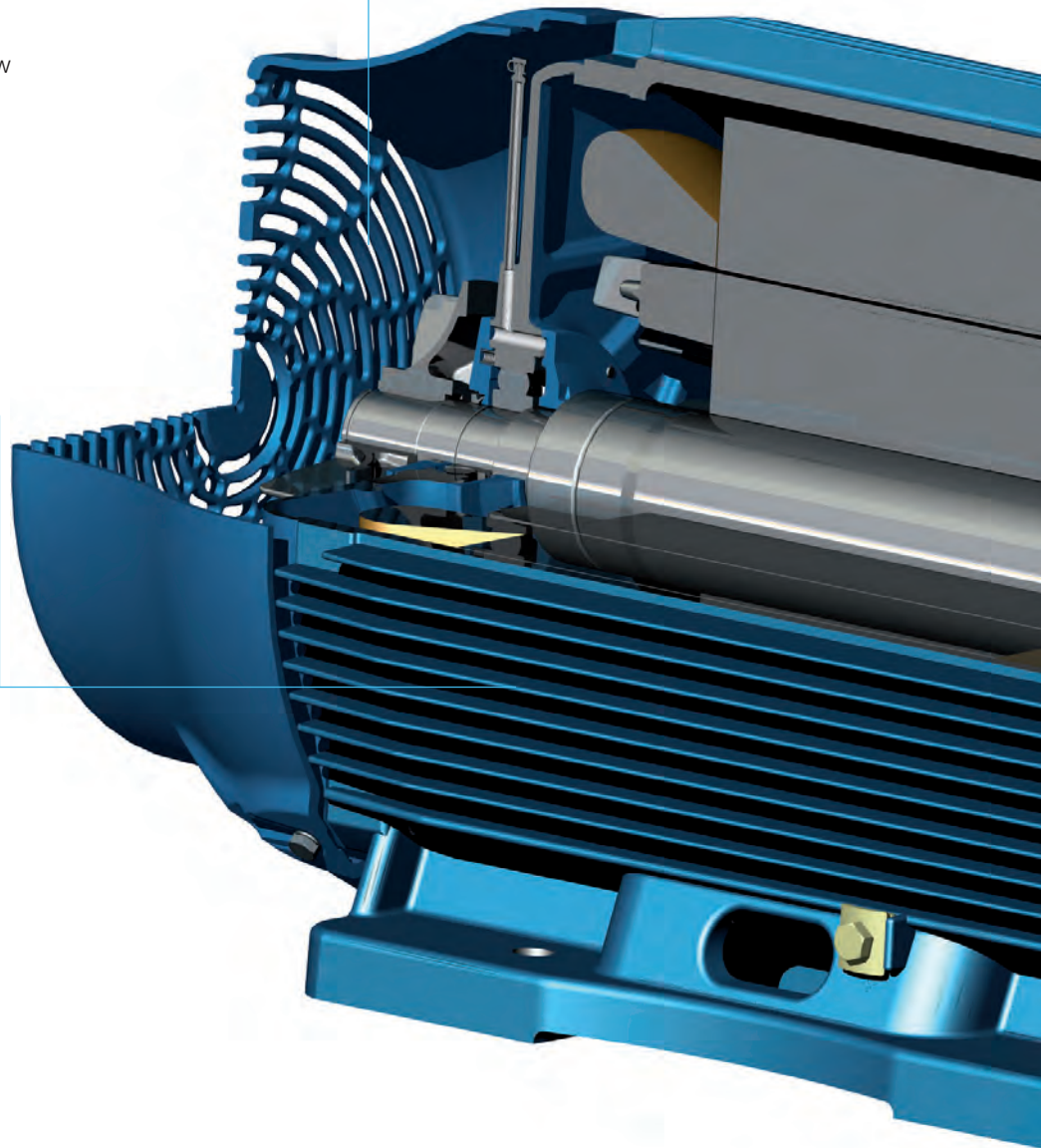

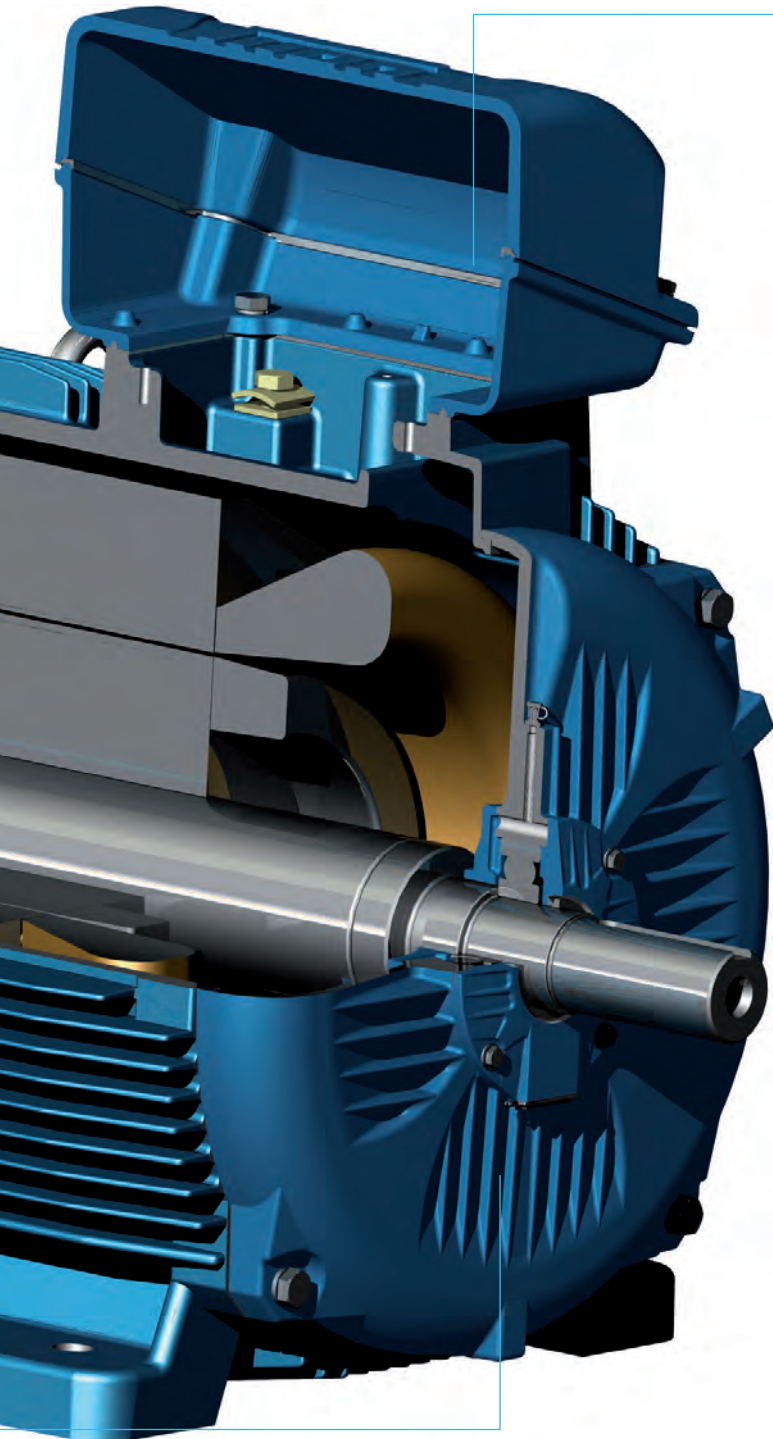

Terminal Box

- Excellent connection quality
- Easy cable handling during installation
- Ample space available for accessory installation
- Easy to maintain
- Mounting F1/F2
- F3 Mounting optional on $\leq 445T$
- F3 Mounting field modifiable 447T and larger
- Rotation on 90° stages

Bearing Caps

External

- Finned surface for superb bearing heat dissipation

Internal

- Positive pressure lubrication system
- High quality bearing lubrication
- Reduced bearing temperature

Seal Subsystem

- Excellent dust and moisture protection
- Excellent protection to high-pressure cleaning

No-Fault Warranty (excludes Washdown motors)

Motors with frame sizes 215T and smaller are covered under a “No-Fault” warranty. This warranty claim is offered one time, per end-user, per application. If there is more than one failure, please contact the Service Department for review. The following must be sent to the WEG Service Department to process a “No-Fault” warranty claim.

- Original nameplate from the failed motor
- Copy of the original WEG invoice or invoice # for the failed motor
- Brief description of the failure for quality control purposes
- Please send request no later than 30 days after failure.

Warranty on Larger Motors

WEG Electric requires that motors larger than 215T frame be inspected by a WEG Authorized Service Center, or if none is available, an EASA-affiliated service shop. Depending on the inspection results, WEG will decide whether to cover the motor under warranty. Prior to a decision being made on a claim for warranty, the following are required from the service shop and customer.

- Completed EASA inspection report
- Repair Quote
- Copy of the original WEG Invoice or WEG Invoice Number
- For Frame 215T and above, photos of the failure in JPEG format suitable for e-mailing

The inclusion of photos allows WEG to properly evaluate the details of your claim, as well as to ensure that any data sent to our factory Quality Control engineers are fully understood. The warranty claim will be evaluated after receipt of the above items. Upon review of the claim, the WEG Service Department will make contact and advise how to proceed. The service shop should not remove the nameplate nor make repairs without being requested to do so by a WEG Service Department representative.

NOTE: For all Ingersoll-Rand motors, please contact the WEG Service Department prior to any inspection.

Warranty on Washdown Motors:

HydroDuty™, PickerPlus™, HydroWash™ and Shark™

The warranty coverage period on these models is 12/24: 12 months from date of first installation or 24 months from the date on motor nameplate, whichever occurs first. Any warranty claim submitted to the WEG Service Department must include:

- Copy of the original WEG invoice or invoice number for the failed motor
- Brief description of the failure for quality control purposes accompanied by photographs of the motor wire connections and any other photograph supporting the claimed failure

WEG Service Department will analyze the claim, along with the supporting documents and determine if the warranty is applicable. When warranty is granted and credit or replacement is determined, it will be executed once the terminal box cover of the failed motor is submitted and received at the WEG Service Department.

Communication

Correspondence with the WEG Service Department may be via e-mail, fax or regular mail. Please keep a photocopy of all nameplates for your records.

Limited Warranty:

WEG Electric Corp. is proud of all of our product lines. WEG and its employees are committed to our customers and users to provide the best designed and manufactured motors, drives and controls. WEG provides a limited warranty on our products against defects in materials and workmanship for a specific period from the date of purchase. If a motor's date code is within its stated warranty period (18 month, 36 month, etc.), no proof of purchase is required. Otherwise, a copy of the

invoice is necessary to show the date of purchase.

Warranty Period:

- The standard warranty for WEG products is 18 months from the invoice date.
- For General Purpose TEFC and ODP Premium Efficiency motors the warranty is 36 months from the invoice date.
- For IEEE 841 motors, the warranty is 60 months from the invoice date.

Authorized Service Centers:

WEG has service centers around the world to meet the needs of our customers. Information regarding the nearest service center can be found on our web site at www.weg.net or by calling 1-800-ASK-4WEG (1-800-275-4934). Any warranty repair by a service shop must be pre-approved by WEG.

Warranty Service:

If a WEG product requires warranty service due to defective materials or workmanship, WEG will, at its option, either repair or replace the defective product. By “replace”, WEG means the original purchaser's account will be credited for the cost on the WEG invoice (less freight). If warranty is granted, and replacement is specified, the motor's nameplate must be sent to the Service Dept. Warranty is applied to products that have been, at all times, properly maintained and operated or used under normal operating conditions for which the product was designed. WEG is not responsible for any expenses incurred in installation, removal from service, transportation (freight) or consequential expenses.

Limitation of Warranty:

THE FOREGOING WARRANTIES ARE EXCLUSIVE AND IN LIEU OF ALL OTHER WARRANTIES OF QUALITY AND PERFORMANCE, WRITTEN, ORAL OR IMPLIED, AND ALL OTHER WARRANTIES INCLUDING ANY IMPLIED WARRANTIES OF MERCHANTABILITY OR FITNESS FOR A PARTICULAR PURPOSE OR ARISING FROM COURSE OF DEALING OR USAGE OF TRADE ARE HEREBY DISCLAIMED BY WEG. THE FOREGOING OBLIGATION TO REPAIR OR REPLACE WEG PRODUCTS OR PARTS SHALL BE THE SOLE AND EXCLUSIVE REMEDY OF THE PURCHASER, ITS CUSTOMERS, OR USERS OF THE PRODUCTS OR PARTS.

Proper Storage of Motors:

When motors are not immediately installed, they should be stored in their normal upright position in a dry even temperature location, free of dust, gases and corrosive atmosphere. Inactive motors tend to expel grease from between the bearing surfaces, thereby removing the protective film that impedes metal-to-metal contact. At least once per month shafts should be rotated in accordance with WEG's installation and maintenance manual. Motors stored for a period exceeding one year should have the bearings re-lubricated in accordance with the WEG motor installation and maintenance manual.

Return Policy

WEG products that are purchased from our stocking warehouses must be returned within 90 days, freight to be paid by customer. Returned products must be unused, and in undamaged original packaging. If products are ordered incorrectly by the customer and need to be returned to stock, then a 20% re-stocking charge will be applied. If the returned products are deemed not to be in unused, undamaged condition, or in original packaging, then additional fees will be applied (up to and including full price of item). Returns on any modified products will not be allowed. Any products that are ordered as specials (with features that would not allow them to be stocked items) cannot be returned.

Contact WEG Service:

Toll-Free: 1-800-839-2529











E-Mail: warranty@weg.net

NEMA Market Certificates and Logos

Line	Certificate	Logo	File	Certificate	VFD use
W22	UL Listed Safe area		E104590	Vol. 5 - Sec.10	Yes
	CSA Safe Area		LR 38324	2194017	Yes
	CSA Div 2		LR 50962	2156668	Yes
ODP/W40 to L6809	UL Listed Safe area		E104590		Yes
	CSA Safe Area		LR 38324	2315224	Yes
HGF//W22MV/W50	UL Listed Safe area		E104590		
	CSA Div 2		LR 50962	1959652	Yes
W22 Fire Pump	UL Listed Safe area		EX5990	Vol. 1 - Sec.4	Yes
	CSA Safe Area		LR 38324	2194017	Yes

continued on next page

NEMA Market Certificates and Logos - *continued*

Line	Certificate	Logo	File	Certificate	VFD use
Rolled Steel W01	CSA Safe Area		LR 38324	70014056	Yes
	CSA Div 2		LR 50962	70088957	Yes
	UL Listed Safe area		E104590	Vol. 5 - Sec.1	Yes
	UL Listed Safe area, thermally protected		E104590	Vol.1 - Sec.22	No
	UL Listed Safe area, with thermal protection certified by UL 1004-3		E125311	Vol. 1 - Sec.25	No
W21X	UL Listed Hazardous area		E87848		No
	CSA Hazardous Area		050962_C	1629892	Yes
56XP	UL Listed Hazardous area		E87848		No
Bluffton	CSA Safe Area		241536		No
All WEG	CSA Energy Verified		078282_0		NA

Part Number Configuration

Ordering

WEG catalog numbers contain up to 20 characters, distributed as follows:

XXX (HP)	XX (rpm)	XXX (Model)	X (Volts)	XXXX (Application + Frame)	XXXX When Applicable
-------------	-------------	----------------	--------------	-------------------------------	-------------------------

HP¹ - .12 - .16 - .25 - .33 - .50 - .75 - 001 - 0015 - 002 - 003 - 004 - 0045 - 005 - 007 - 010 - 015 - 020 - 025 - 030 - 040 - 050 - 075 - 100 - 125 - 150 - 200 - 250 - 300 - 400 - 450 - 500 - 600 - 650 ...

RPM - **36:** 3600rpm **18:** 1800rpm **12:** 1200rpm **09:** 900rpm
30: 3000rpm **15:** 1500rpm **10:** 1000rpm **07:** 750rpm

Model - Three Characters:

X ENCLOSURE	X EFFICIENCY	X PHASE
E - Totally Enclosed	S - Standard Efficiency	1 - 1 Phase
S - Severe Duty IEEE 841	P - High Efficiency	3 - 3 Phase
O - Open drip proof	T - NEMA Premium®	
X - eXplosion proof	G - Super Premium	
A - Totally Enclosed Air Over		
N - Totally Enclosed Non Ventilated		

Voltage	
A - 115V	L - 415V
B - 115 / 208 - 230V	M - 220 / 380 - 415V
C - 208 - 230V	N - 220 / 380V
D - 230V	O - 380 - 415V
E - 230 / 460V* # useable at 208V	P - 200V
F - 230 / 460V	Q - 460V
G - 460V PWS	R - 115 / 230V
H - 575V	V - 200 / 400V
I - 220V	W - 460 // 220 - 240 / 380 - 415V
J - 380V	X - Other Voltage
K - 190 / 380V	Y - 460 // 380 - 415 / 660 - 690V

* Suitable for PWS on 254T and larger on low voltage connection.

For Rolled Steel Motors: 190-220/380-415V at 50Hz (derate may apply).

- For IEC Metric motors, the output will be given in kW:
.12 - .18 - .25 - .37 - .55 - .75 - 001 - 0015 - 002 - 003 - 004 - 0045 - 005 - 007 - 009 - 011 - 015 - 018 - 022 - 030 - 037 - 045 - 055 - 075 - 090 - 110 - 130 - 150 - 185 - 200 - 220 - 250 - 300 - 315 ...
- 0015 (1.5HP) is the rating that will have four digits for output identification and only one for RPM.
- 0045 (4.5kW) is the rating that will have four digits for output identification and only one for RPM.

Frame

The frame number must be included as long as the number of remaining characters allows.

Example: 143T, 143TC, 405T, 405TS, 184JP.

XXXX Suffix

- W22, -W2, -W or W = W22 platform
- W22S, -W2S or -WS = Single punched feet
- W22G, -W2G, -W40G or -WG = AEGIS® Ring Inside
- S = Rolled Steel platform
- SG = Rolled Steel/AEGIS® Ring inside
- SRT = Rolled Steel/short frame
- W40 or W4 = W40 platform
- SRG = Rolled Steel/short frame/AEGIS® Ring inside

Application / Feature

For Definite Purpose lines, two pre-selected letters must be used after voltage code:

- AD - Auger Drive
- AL - ALuminum Frame
- AX - ATEX Motor
- BM - Brake Motor
- CD - Compressor Duty
- CT - Cooling Tower
- EC - Evaporative Cooler
- FD - Farm Duty
- FL - Footless for Fractionals (after frame)
- FP - Fire Pump
- HP - Hydraulic Pump
- ID - Irrigation Duty
- IE - IEEE 841 (Severe Duty IEEE 841)
- JP - Jet Pump
- CD - Crusher-Duty
- OL - Manual OverLoad Protection
- OW - Oil Well Pumping
- PF - Poultry Fan
- PM - Pad Mount
- R - (Before the frame size): Round Body
- RB - Roller Bearings (Integrals)²
- RB - Resilient Base (Fractionals)
- SA - Saw Arbor
- SP - Split Phase
- SS - Stainless Steel
- VD - Vector Duty (TEBC or TENV)

² Roller bearings are recommended for all belt driven applications 100HP and above.

- Models in black text are Standard Efficiency
- Models in blue text are NEMA Premium® Efficiency
- Models in green text are NEMA Super Premium Efficiency

WEG MOTORS FOR VFD APPLICATIONS - CRITERIA

(Not applicable to motors rated for use in Division 1 hazardous areas. In such cases please contact WEG)
Valid for TEFC NEMA Premium® & IEC Tru-Metric - W22 Platforms and ODP

INSULATION SYSTEM AND BEARING CRITERIA

(If any of the conditions below are not met, VFD line filters must be used)

INSULATION SYSTEMS (for all NEMA frame sizes - from 143 to 589 and IEC frame sizes - from 90 to 355) - up to 690 V

Rated Voltage	Feature	Voltage Spikes motor terminals (maximum)	dV/dt inverter terminals (maximum)	Rise Time inverter terminals (minimum)	MTBP Minimum Time Between Pulse
$V_{rated} \leq 460$ V	Standard Insulation	≤ 2000 V	≤ 5200 V/ μ s	$\geq 0,1$ μ s	≥ 6 μ s
460 V < $V_{rated} \leq 575$ V	Reinforced Insulation	≤ 2000 V	≤ 6500 V/ μ s		

BEARING PROTECTION (for all rated voltage ranges)

NEMA Frame Size	Feature
Frame ≤ 449	· Optional: Insulated NDE endbell / insulated bearing
L449T – 589	Insulated NDE endbell standard L449 and above. Optional: insulated bearing (*) Shaft grounding recommended where insulated bearings are applied
IEC Frame Size	Feature
Frame ≤ 315	· Optional: Insulated NDE endbell / insulated bearing
315L – 355	Insulated NDE endbell standard 315L and above. Optional: insulated bearing (*) Shaft grounding recommended where insulated bearings are applied

(*) For insulated bearing, please contact WEG

TORQUE CRITERIA - Valid for 2, 4, 6 and 8 pole motors

NEMA PREMIUM® EFFICIENCY / IEC MOTORS - TEFC MOTORS

Frame Size	Constant Torque	Variable Torque
143 – 586/7 / 90 – 355 ⁽¹⁾	20:1 / 12:1	1000:1
586/7 / 355 ⁽²⁾	6:1 / 2:1	1000:1 / 10:1

Satisfactory motor performance depends on proper drive setup - please contact WEG.

⁽¹⁾ For 250 HP / 185 kW or lower power motors. Also valid for 449 / 315 frames.

⁽²⁾ For motors higher than 250 HP / 185 kW.

HIGH EFFICIENCY AND NEMA PREMIUM® EFFICIENCY - ODP MOTORS

Frame Size	Constant Torque	Variable Torque
182T – 364/5T	4:1	1000:1
404/5T – 5010T	2:1	1000:1

NOTES:

- Maximum recommended Inverter switching frequency of 5 kHz (minimum of 2.5 kHz)
 - The speed ranges stated above are related to the motor thermal capacity only to 60HZ operated motors
 - NEMA Premium® Efficiency WEG motors of all frame sizes can also be blower cooled under request. In such case, the motor will be suitable for variable and constant torque applications rated up to 1000:1
 - NEMA Premium® Efficiency WEG motors comply with those maximum safe operating speeds established in NEMA MG1-2016, part 30 (consult table 30-1)
 - Per IEC standard 60034-18-41:
 - Exceed severe IVIC (**) level phase to ground - > 2392
 - Exceed moderate IVIC (**) level phase to phase - > 2563
- (**) Impulse Voltage Insulation Class

Single-Phase General Purpose Motors - (A-17)

TEFC – Foot Mount	A-19
TEFC – C-Face – Foot Mount	A-21
TEFC – C-Face – Footless	A-22
TEFC – Foot Mount – Thermally Protected.	A-22
ODP – Foot Mount.	A-23
ODP – Resilient Base	A-24
ODP – C-Face – Foot Mount	A-25
ODP – C-Face – Footless	A-26
ODP – Foot Mount – Thermally protected	A-26



TEFC Rolled Steel



ODP Rolled Steel



TEFC Cast Iron



Resilient Base

TEFC & ODP

High Starting Torque makes these motors ideal for a wide range of applications.

Standard Features:

- Ball bearings
- Class F insulation
- F1 Mounted
- V-ring Seals

Features that make a difference:

- High Starting Torque
- 182T frames and up are cast iron for severe duty
- NPT Threaded Holes in Terminal Box

ADDITIONAL TECHNICAL DATA

ELECTRICAL DATA: TEFC -Cast Iron - B-5
 TEFC - RS - Standard Eff. - B-6
 ODP - RS - Standard Eff. - B-9
 ODP - RS - Premium Eff. - B-11

MECHANICAL DATA: TEFC - Cast Iron - B-56
 TEFC - RS - Standard Eff. - B-60
 ODP - RS - Standard Eff. - B-64
 ODP - RS - Premium Eff. - B-68



Please refer to back cover for description of "NOTES"

For detailed specifications, data sheets, drawings and performance curves visit <http://www.weg.net>

Data subject to change without notice.



Single-Phase General Purpose Motors

Single-Phase
General Purpose
Motors

TEFC - Foot Mount

HP	kW	RPM	Frame	Catalog Number	List Price	Mult. Symbol	Approx. Shipping Weight (lbs)	Service Factor	FL Amps @ High	FL. Eff (%)	"C" Dimension (in)	Voltage (V)	Notes
0.25	0.18	3600	W56	.2536ES1BW56-S	\$257	F1	20	1.15	2.10	50.0	10.713	115/208-230	9
		1800	W56	.2518ES1BW56-S	\$267	F1	20	1.15	2.30	57.0	11.106	115/208-230	9
0.33	0.25	3600	W56	.3336ES1BW56-S	\$267	F1	23	1.15	2.60	54.0	11.106	115/208-230	9
		1800	W56	.3318ES1BW56-S	\$283	F1	22	1.15	3.00	61.0	11.500	115/208-230	9
		1800	W56	.3318ES1RFDW56-S	\$284	R1	22	1.15	3.00	61.0	11.500	115/230	4,9
0.50	0.37	3600	W56	.5036ES1BW56-S	\$284	F1	24	1.15	3.50	60.0	11.500	115/208-230	9
		3600	W56	.5036ES1BOLW56-S	\$316	F1	24	1.15	3.50	60.0	11.500	115/208-230	4,9
		1800	W56	.5018ES1RFDW56-S	\$308	R1	25	1.15	4.00	64.0	11.894	115/230	4,9
		1800	W56	.5018ES1BW56-S	\$312	F1	24	1.15	4.00	64.0	11.894	115/208-230	9
		1200	56	.5012ES1B56-S	\$512	F1	38	1.15	3.20	71.0	13.508	115/208-230	9
0.75	0.55	3600	56	.7536ES1BOL56-S	\$329	F1	31	1.15	4.00	66.0	12.721	115/208-230	4,9
		3600	56	.7536ES1B56-S	\$297	F1	31	1.15	4.00	66.0	12.721	115/208-230	9
		1800	56	.7518ES1RFD56-S	\$357	R1	34	1.15	5.30	68.5	13.114	115/230	4,9
		1800	56	.7518ES1B56-S	\$348	F1	33	1.15	5.30	68.5	13.114	115/208-230	9
		1200	56	.7512ES1B56-S	\$648	F1	44	1.15	4.70	70.0	14.295	115/208-230	9
1	0.75	3600	56	00136ES1BOL56-S	\$408	F1	35	1.15	5.10	70.0	13.114	115/208-230	4,9
		3600	56	00136ES1B56-S	\$376	F1	34	1.15	5.10	70.0	13.114	115/208-230	9
		3600	143/5T	00136ES1B143T-S	\$553	RS	35	1.15	5.10	70.0	13.212	115/208-230	9
		1800	56	00118ES1RFD56-S	\$394	R1	40	1.15	6.80	71.0	13.901	115/230	4,9
		1800	56	00118ES1B56-S	\$401	F1	39	1.15	6.80	71.9	13.902	115/208-230	9
		1800	143/5T	00118ES1RFD143T-S	\$400	R1	40	1.15	6.80	71.0	13.901	115/230	4,9
		1800	143/5T	00118ES1E143T-S	\$531	RS	42	1.15	3.40	71.0	13.970	208-230/460	9
1.5	1.1	3600	56	00156ES1B56-S	\$432	F1	39	1.15	6.60	75.0	13.902	115/208-230	9
		3600	56	00156ES1BOL56-S	\$463	F1	39	1.15	6.60	75.0	13.902	115/208-230	4,9
		3600	143/5T	00156ES1B143T-S	\$602	RS	40	1.15	6.60	75.0	13.970	115/208-230	9
		1800	56H	00158ES1RFD56H-S	\$502	R1	51	1.15	7.50	77.0	15.083	115/230	4,9
		1800	56H	00158ES1B56-S	\$456	F1	40	1.15	7.50	77.0	15.083	115/208-230	9
		1800	143/5T	00158ES1RFD145T-S	\$504	R1	50	1.15	7.48	77.0	15.083	115/230	4,9
		1800	143/5T	00158ES1B145T-S	\$612	RS	48	1.15	7.50	77.0	15.152	115/208-230	9
		1800	143/5T	00158ES1E145T-S	\$611	RS	48	1.15	3.70	77.0	15.152	208-230/460	9
		1200	182T	00152ES1E182T-W22	\$1,100	W1	97	1.15	4.90	75.0	16.050	208-230/460	39

continued on next page

Please refer to back cover for description of "NOTES"

For detailed specifications, data sheets, drawings and performance curves visit <http://www.weg.net>

Data subject to change without notice.

Can't find what you are looking for? Call 1-800-ASK-4WEG (275-4934)

TEFC - Foot Mount - *continued*

HP	kW	RPM	Frame	Catalog Number	List Price	Mult. Symbol	Approx. Shipping Weight (lbs)	Service Factor	FL Amps @ High	FL Eff (%)	"C" Dimension (in)	Voltage (V)	Notes
2	1.5	3600	56	00236ES1B0L56-S	\$592	F1	44	1.15	8.70	77.0	14.295	115/208-230	4,9
		3600	56H	00236ES1B56-S	\$561	F1	44	1.15	8.70	77.0	14.295	115/208-230	9
		3600	143/5T	00236ES1E145T-S	\$640	RS	43	1.15	4.40	77.0	14.365	208-230/460	9
		3600	143/5T	00236ES1B145T-S	\$641	RS	43	1.15	8.70	77.0	14.365	115/208-230	9
		1800	56H	00218ES1RFD56H-S	\$529	R1	56	1.15	10.0	78.5	15.870	115/230	4,9
		1800	143/5T	00218ES1RFD145T-S	\$578	R1	57	1.15	10.0	78.5	15.870	115/230	4,9
		1800	143/5T	00218ES1E145T-S	\$615	RS	56	1.15	5.00	78.5	15.938	208-230/460	9
		1800	143/5T	00218ES1B145T-S	\$615	RS	56	1.15	10.0	78.5	15.938	115/208-230	9
		1800	182/4T	00218ES1RFD182T-W22	\$790	R1	89	1.15	10.0	81.0	17.244	115/230	4,39
		1200	213/5T	00212ES1E213T-W22	\$1,209	W1	125	1.15	5.30	78.0	20.984	208-230/460	39
3	2.2	3600	143/5T	00336ES1E145T-S	\$829	RS	53	1.15	6.40	80.0	15.545	208-230/460	9
		3600	143/5T	00336ES1B145T-S	\$830	RS	53	1.15	12.7	80.0	15.545	115/208-230	9
		3600	182T	00336ES1B182T-W22	\$882	W1	92	1.15	13.6	80.0	17.240	115/208-230	39
		3600	182T	00336ES1E182T-W22	\$879	W1	96	1.15	6.80	80.0	16.050	208-230/460	39
		1800	184T	00318ES1E184T-W22	\$874	W1	99	1.15	6.80	77.0	17.050	208-230/460	39
		1800	184T	00318ES1C184T-W22	\$875	W1	99	1.15	13.6	77.0	17.050	208-230	39
		1800	182/4T	00318ES1DFD184T-W22	\$915	R1	93	1.15	14.5	81.0	17.244	230	4,39
		1200	215T	00312ES1E215T-W22	\$1,327	W1	170	1.15	6.70	80.0	20.984	208-230/460	39
5	3.7	3600	184T	00536ES1E184T-W22	\$1,038	W1	110	1.15	10.5	83.0	17.050	208-230/460	39
		3600	184T	00536ES1B184T-W22	\$1,040	W1	110	1.15	21.0	83.0	17.050	115/208-230	39
		1800	184T	00518ES1E184T-W22	\$1,064	W1	118	1.15	10.7	79.0	17.050	208-230/460	39
		1800	184T	00518ES1C184T-W22	\$1,066	W1	118	1.15	21.4	79.0	17.050	208-230	39
		1800	184T	00518ES1DFD184T-W22	\$1,074	R1	119	1.15	21.4	79.0	17.050	230	4,39
		1800	213/5TZ	00518ES1DFD215Z-W22	\$1,205	R1	136	1.15	21.4	79.0	20.984	230	4,39
		1800	213/5T	00518ES1DFD215T-W22	\$1,205	R1	136	1.15	21.4	79.0	20.984	230	4,39
		1200	215T	00512ES1E215T-W22	\$1,588	W1	172	1.15	11.0	80.0	19.567	208-230/460	39
7.5	5.5	3600	213T	00736ES1E213T-W22	\$1,548	W1	147	1.15	14.9	86.0	18.021	208-230/460	39
		3600	213T	00736ES1B213T-W22	\$1,552	W1	147	1.15	29.8	86.0	18.021	115/208-230	39
		1800	215T	00718ES1E215T-W22	\$1,359	W1	164	1.15	17.0	83.0	19.567	208-230/460	39
		1800	215T	00718ES1DFD215T-W22	\$1,463	R1	168	1.15	33.0	83.0	19.567	230	4,39
		1800	215TZ	00718ES1DFD215Z-W22	\$1,463	R1	168	1.15	33.0	83.0	19.567	230	4,39
10	7.5	3600	215T	01036ES1E215T-W22	\$1,916	W1	162	1.15	19.4	86.0	19.567	208-230/460	39
		1800	215T	01018ES1E215T-W22	\$1,579	W1	188	1.15	19.5	84.0	19.567	208-230/460	39
		1800	215T	01018ES1DFD215T-W22	\$1,692	R1	193	1.15	40.0	83.0	19.567	230	4,39
12.5	9.2	3600	215T	01236ES1C215T-W22	\$2,015	W1	182	1.15	53.6	88.5	19.567	208-230	39
		1800	215T	01218ES1E215T-W22	\$1,776	W1	205	1.15	27.2	82.5	19.462	208-230/460	4,39

Please refer to back cover for description of "NOTES"

For detailed specifications, data sheets, drawings and performance curves visit <http://www.weg.net>



Single-Phase General Purpose Motors

Single-Phase
General Purpose
Motors

TEFC - C-Face - Foot Mount

HP	kW	RPM	Frame	Catalog Number	List Price	Mult. Symbol	Approx. Shipping Weight (lbs)	Service Factor	FL Amps @ High	FL. Eff (%)	"C" Dimension (in)	Voltage (V)	Notes
0.25	0.18	3600	W56C	.2536ES1BW56C-S	\$280	F1	20	1.15	2.10	50.0	10.713	115/208-230	9
		1800	W56C	.2518ES1BW56C-S	\$288	F1	20	1.15	2.30	57.0	11.106	115/208-230	9
0.33	0.25	3600	W56C	.3336ES1BW56C-S	\$288	F1	22	1.15	2.60	54.0	11.106	115/208-230	9
		1800	W56C	.3318ES1BW56C-S	\$304	F1	22	1.15	3.00	61.0	11.500	115/208-230	9
0.50	0.37	3600	W56C	.5036ES1BW56C-S	\$313	F1	24	1.15	3.50	60.0	11.500	115/208-230	9
		1800	W56C	.5018ES1BW56C-S	\$333	F1	26	1.15	4.00	64.0	11.894	115/208-230	9
		1800	W56C	.5018ES1BOW56C-S	\$348	F1	24	1.15	4.00	64.0	11.894	115/208-230	3,9
		1200	56C	.5012ES1B56C-S	\$535	F1	39	1.15	3.20	67.0	13.508	115/208-230	9
0.75	0.55	3600	56C	.7536ES1B56C-S	\$353	F1	32	1.15	4.00	66.0	12.721	115/208-230	9
		1800	56C	.7518ES1B56C-S	\$370	F1	34	1.15	5.30	68.5	13.114	115/208-230	9
		1200	56HC	.7512ES1B56C-S	\$669	F1	45	1.15	4.70	70.0	14.295	115/208-230	9
1	0.75	3600	56C	00136ES1B56C-S	\$378	F1	35	1.15	5.10	70.0	13.114	115/208-230	9
		1800	56C	00118ES1B56C-S	\$424	F1	40	1.15	6.80	71.0	13.902	115/208-230	9
		1800	56C	00118ES1B056C-S	\$439	F1	40	1.15	6.80	71.0	13.902	115/208-230	3,9
1.5	1.1	3600	56C	00156ES1B56C-S	\$454	F1	40	1.15	6.60	75.0	13.902	115/208-230	9
		1800	56HC	00158ES1B056C-S	\$493	F1	41	1.15	7.50	77.0	15.083	115/208-230	3,9
		1800	56HC	00158ES1B56C-S	\$478	F1	41	1.15	7.50	77.0	15.083	115/208-230	9
2	1.5	3600	56HC	00236ES1B56C-S	\$589	F1	44	1.15	8.70	77.0	14.295	115/208-230	9
		1800	143/5TC	00218ES1B145TC-S	\$643	RS	52	1.15	10.0	78.5	15.938	115/208-230	9
3	2.2	3600	143/5TC	00336ES1E145TC-S	\$858	RS	56	1.15	6.40	80.0	15.545	208-230/460	9
		1800	184TC	00318ES1E184TC	\$913	W1	99	1.15	6.80	77.0	17.050	208-230/460	39
		1800	184TC	00318ES1B184TC	\$913	W1	99	1.15	13.6	77.0	17.050	115/208-230	39
		1800	184TC	00318ES1C184TC	\$913	W1	99	1.15	13.6	77.0	17.050	208-230	39
5	3.7	3600	184TC	00536ES1E184TC	\$1,077	W1	109	1.15	10.5	83.0	17.050	208-230/460	39
		1800	184TC	00518ES1E184TC	\$1,103	W1	118	1.15	10.7	79.0	17.050	208-230/460	39
		1800	184TC	00518ES1C184TC	\$1,103	W1	118	1.15	21.4	79.0	17.050	208-230	39
7.5	5.5	3600	213TC	00736ES1E213TC	\$1,598	W1	147	1.15	14.9	86.0	18.021	208-230/460	39
		1800	215TC	00718ES1E215TC	\$1,410	W1	166	1.15	17.0	83.0	19.567	208-230/460	39
10	7.5	3600	215TC	01036ES1E215TC	\$1,970	W1	164	1.15	19.4	86.0	19.567	208-230/460	39
		1800	215TC	01018ES1E215TC	\$1,633	W1	190	1.15	19.5	84.0	19.567	208-230/460	39
12.5	9.2	1800	215TC	01218ES1E215TC	\$1,827	W1	202	1.15	24.0	84.0	19.567	208-230/460	39

Please refer to back cover for description of "NOTES"

For detailed specifications, data sheets, drawings and performance curves visit <http://www.weg.net>

Data subject to change without notice.

Can't find what you are looking for? Call 1-800-ASK-4WEG (275-4934)

Single-Phase General Purpose Motors



Single-Phase
General Purpose
Motors

TEFC - C-Face - Footless

HP	kW	RPM	Frame	Catalog Number	List Price	Mult. Symbol	Approx. Shipping Weight (lbs)	Service Factor	FL Amps @ High	FL Eff (%)	"C" Dimension (in)	Voltage (V)	Notes
0.33	0.25	3600	W56C	.3336ES1BW56CFL-S	\$288	F1	21	1.15	2.60	53.0	11.106	115/208-230	9,20
		1800	W56C	.3318ES1BW56CFL-S	\$304	F1	22	1.15	3.00	61.0	11.500	115/208-230	9,20
0.50	0.37	3600	W56C	.5036ES1BW56CFL-S	\$313	F1	24	1.15	3.50	60.0	11.500	115/208-230	9,20
		1800	W56C	.5018ES1BW56CFL-S	\$333	F1	24	1.15	4.00	64.0	11.894	115/208-230	9,20
		1200	56C	.5012ES1B56CFL-S	\$535	F1	38	1.15	3.20	71.0	13.508	115/208-230	9,20
0.75	0.55	3600	56C	.7536ES1B56CFL-S	\$353	F1	31	1.15	4.00	66.0	12.721	115/208-230	9,20
		1800	56C	.7518ES1B56CFL-S	\$370	F1	34	1.15	5.30	68.5	13.114	115/208-230	9,20
		1200	56C	.7512ES1B56CFL-S	\$669	F1	44	1.15	4.70	70.0	14.295	115/208-230	9,20
1	0.75	3600	56C	00136ES1B56CFL-S	\$378	F1	35	1.15	5.10	70.0	13.114	115/208-230	9,20
		1800	56C	00118ES1B56CFL-S	\$424	F1	39	1.15	6.80	71.0	13.902	115/208-230	9,20
		1800	143/5TC	00118ES1ER143TC-S	\$559	RS	43	1.15	3.40	71.0	13.970	208-230/460	9,15
1.5	1.1	3600	56C	00156ES1B56CFL-S	\$454	F1	39	1.15	6.60	75.0	13.902	115/208-230	9,20
		1800	56C	00158ES1B56CFL-S	\$478	F1	40	1.15	7.50	77.0	15.083	115/208-230	9,20
2	1.5	3600	56C	00236ES1B56CFL-S	\$589	F1	43	1.15	8.70	77.0	14.295	115/208-230	9,20
3	2.2	1800	184TC	00318ES1ER184TC	\$912	W1	98	1.15	6.80	77.0	17.050	208-230/460	15,39



TEFC - Foot Mount - Thermally Protected

HP	kW	RPM	Frame	Catalog Number	List Price	Mult. Symbol	Approx. Shipping Weight (lbs)	Service Factor	FL Amps @ High	FL Eff (%)	"C" Dimension (in)	Voltage (V)	Notes
0.33	0.25	1800	W56	.3318ES1RFDW56-S	\$284	R1	22	1.15	3.00	61.0	11.500	115/230	4,9
0.50	0.37	3600	W56	.5036ES1BOLW56-S	\$316	F1	24	1.15	3.50	60.0	11.500	115/208-230	4,9
		1800	W56	.5018ES1RFDW56-S	\$308	R1	25	1.15	4.00	64.0	11.894	115/230	4,9
0.75	0.55	3600	56	.7536ES1BOL56-S	\$329	F1	31	1.15	4.00	66.0	12.721	115/208-230	4,9
		1800	56	.7518ES1RFD56-S	\$357	R1	34	1.15	5.30	68.5	13.114	115/230	4,9
1	0.75	3600	56	00136ES1BOL56-S	\$408	F1	35	1.15	5.10	70.0	13.114	115/208-230	4,9
		1800	56	00118ES1RFD56-S	\$394	R1	40	1.15	6.80	71.0	13.901	115/230	4,9
		1800	143/5T	00118ES1RFD143T-S	\$400	R1	40	1.15	6.80	71.0	13.901	115/230	4,9
1.5	1.1	3600	56	00156ES1BOL56-S	\$463	F1	39	1.15	6.60	75.0	13.902	115/208-230	4,9
		1800	56H	00158ES1RFD56H-S	\$502	R1	51	1.15	7.50	77.0	15.083	115/230	4,9
		1800	143/5T	00158ES1RFD145T-S	\$504	R1	50	1.15	7.48	77.0	15.083	115/230	4,9
2	1.5	3600	56	00236ES1BOL56-S	\$592	F1	44	1.15	8.70	77.0	14.295	115/208-230	4,9
		1800	56H	00218ES1RFD56H-S	\$529	R1	56	1.15	10.0	78.5	15.870	115/230	4,9
		1800	143/5T	00218ES1RFD145T-S	\$578	R1	57	1.15	10.0	78.5	15.870	115/230	4,9
		1800	W182/4T	00218ES1RFD182T	\$790	R1	89	1.15	10.0	81.0	17.244	115/230	4,39
3	2.2	1800	W182/4T	00318ES1DFD184T	\$915	R1	93	1.15	14.5	81.0	17.244	230	4,39
5	3.7	1800	184T	00518ES1DFD184T	\$1,074	R1	119	1.15	21.4	79.0	17.050	230	4,39
		1800	W213/5T	00518ES1DFD215T	\$1,205	R1	136	1.15	21.4	79.0	20.984	230	4,39
		1800	W213/5TZ	00518ES1DFD215Z	\$1,205	R1	136	1.15	21.4	79.0	20.984	230	4,39
7.5	5.5	1800	215T	00718ES1DFD215T	\$1,463	R1	168	1.15	33.0	83.0	19.567	230	4,39
		1800	215TZ	00718ES1DFD215Z	\$1,463	R1	168	1.15	33.0	83.0	19.567	230	4,39
10	7.5	1800	215T	01018ES1DFD215T	\$1,692	R1	193	1.15	40.0	83.0	19.567	230	4,39

Please refer to back cover for description of "NOTES"

For detailed specifications, data sheets, drawings and performance curves visit <http://www.weg.net>



Single-Phase General Purpose Motors

Single-Phase
General Purpose
Motors

ODP - Foot Mount

HP	kW	RPM	Frame	Catalog Number	List Price	Mult. Symbol	Approx. Shipping Weight (lbs)	Service Factor	FL Amps @ High	FL. Eff (%)	"C" Dimension (in)	Voltage (V)	Notes
0.12	0.09	1800	48	.12180S1B48-S	\$201	F1B	18	1.40	1.40	50.0	9.098	115/208-230	9
		3600	48	.16360S1B48-S	\$216	F1B	21	1.35	1.40	53.0	9.098	115/208-230	9
0.16	0.12	1800	48	.16180S1B48-S	\$208	F1B	22	1.35	1.70	53.0	9.098	115/208-230	9
		3600	48	.25360T1B48-S	\$253	F2B	19	1.35	1.30	66.6	9.492	115/208-230	9
0.25	0.18	3600	W56	.25360T1BW56-S	\$253	F2B	19	1.35	1.30	66.6	9.866	115/208-230	9
		1800	48	.25180T1B48-S	\$241	F2B	18	1.35	1.60	68.5	9.492	115/208-230	9
		1800	W56	.25180T1BW56-S	\$241	F2B	19	1.35	1.60	68.5	9.866	115/208-230	9
		3600	48	.33360T1B48-S	\$256	F2B	23	1.35	1.60	70.5	9.886	115/208-230	9
0.33	0.25	1800	48	.33180T1B48-S	\$275	F2B	20	1.35	2.10	72.4	9.886	115/208-230	9
		1800	W56	.33180T1BW56-S	\$275	F2B	21	1.35	2.10	72.4	10.260	115/208-230	9
		3600	48	.50360T1B48-S	\$276	F2B	23	1.25	2.40	72.4	9.886	115/208-230	9
0.50	0.37	3600	W56	.50360S1BCDW56-S	\$224	C1S	28	1.00	3.10	63.0	9.866	115/208-230	1,4,6,9
		3600	W56	.50360T1BW56-S	\$282	F2B	24	1.25	2.40	72.4	10.260	115/208-230	9
		1800	48	.50180T1B48-S	\$318	F2B	23	1.25	2.80	76.2	10.280	115/208-230	9
		1800	W56	.50180T1BW56-S	\$307	F2B	23	1.25	2.80	76.2	10.654	115/208-230	9
		3600	W56	.75360S1BCDW56-S	\$237	C1S	22	1.00	4.30	68.5	10.260	115/208-230	1,4,6,9
0.75	0.55	3600	56	.75360T1B56-S	\$320	F2B	30	1.25	3.40	76.2	11.890	115/208-230	9
		1800	56	.75180T1B56-S	\$387	F2B	38	1.25	3.40	81.8	11.890	115/208-230	9
		3600	56	001360S1BCD56-S	\$278	C1S	36	1.00	6.60	67.0	11.102	115/208-230	1,4,6,9
1	0.75	3600	56	001360T1B56-S	\$347	F2B	35	1.25	4.30	80.4	11.890	115/208-230	9
		1800	56	001180T1B56-S	\$421	F2B	41	1.15	4.50	82.6	12.677	115/208-230	9
		1800	56	001180T1B056-S	\$438	F2B	41	1.15	4.50	82.6	12.677	115/208-230	3,9
		3600	56	001560S1BCD56-S	\$311	C1S	40	1.00	8.70	68.0	11.496	115/208-230	1,4,6,9
1.5	1.1	3600	56	001560T1B56-S	\$393	F2B	38	1.15	6.20	81.5	12.284	115/208-230	9
		1800	56H	001580T1B56-S	\$523	F2B	49	1.15	6.80	83.8	13.071	115/208-230	9
		1800	56H	001580T1B056-S	\$541	F2B	50	1.15	6.80	83.8	13.465	115/208-230	3,9
		3600	56H	002360S1BCD56-S	\$372	C1S	34	1.00	8.90	70.0	11.890	115/208-230	1,4,6,9
2	1.5	3600	56H	002360T1B56-S	\$485	F2B	43	1.15	8.40	82.9	12.677	115/208-230	9
		1800	56H	002180T1B56-S	\$626	F2B	54	1.15	9.30	84.5	13.465	115/208-230	9
		3600	56H	003360S1CCD56-S	\$432	C1S	41	1.00	12.7	80.0	12.677	208-230	1,4,6,9
3	2.2	3600	56H	003360T1B56-S	\$568	F2B	52	1.15	12.2	84.1	13.465	115/208-230	9
		3600	182T	003360S1B182T	\$607	W1B	91	1.25	15.0	81.5	14.448	115/208-230	39
		3600	182T	003360S1C182T	\$606	W1B	91	1.25	15.0	81.5	14.448	208-230	39
		1800	184T	003180S1B184T	\$690	W1B	105	1.25	17.5	75.0	14.870	115/208-230	39
		1800	184T	003180S1C184T	\$690	W1B	105	1.25	17.5	75.0	14.870	208-230	39
		1800	184T	003180S1CCDOL184T	\$687	C1	99	1.15	17.5	75.0	14.875	208-230	4,6,39

continued on next page

Please refer to back cover for description of "NOTES"

For detailed specifications, data sheets, drawings and performance curves visit <http://www.weg.net>

Data subject to change without notice.

Can't find what you are looking for? Call 1-800-ASK-4WEG (275-4934)

ODP - Foot Mount - *continued*

HP	kW	RPM	Frame	Catalog Number	List Price	Mult. Symbol	Approx. Shipping Weight (lbs)	Service Factor	FL Amps @ High	FL. Eff (%)	"C" Dimension (in)	Voltage (V)	Notes
5	3.7	3600	56H	005360S1DCD56H-S	\$458	C1S	53	1.00	20.3	80.0	13.465	230	1,4,6,9
		3600	56HZ	005360S1DCD56HZ-S	\$481	C1S	53	1.00	20.3	80.0	13.533	230	1,4,5,6,9
		3600	W182/4Y	005360S1CCDW184Y-S	\$526	C1S	56	1.00	20.7	80.0	15.152	208-230	1,4,5,6,9
		3600	184T	005360S1B184T	\$863	W1B	110	1.25	21.0	81.5	14.870	115/208-230	39
		3600	184T	005360S1C184T	\$863	W1B	110	1.25	21.0	81.5	14.870	208-230	39
		3600	184T	005360S1D184T	\$862	W1B	110	1.25	21.0	81.5	14.870	230	39
		1800	184T	005180S1C184T	\$725	W1B	107	1.25	22.0	82.5	14.870	208-230	39
		1800	184T	005180S1CCDOL184T	\$721	C1	101	1.15	21.5	82.5	14.875	208-230	4,6,39
		1800	184T	005180S1CCD184T	\$682	C1	102	1.25	21.5	82.5	14.875	208-230	6,10,39
7.5	5.5	3600	184T	007360S1C184T	\$961	W1B	120	1.25	30.0	85.0	14.870	208-230	39
		1800	213/5T	007180S1F215T	\$961	W1B	130	1.15	15.3	85.0	19.660	230/460	5,9,28
		1800	215T	007180S1CCD215T	\$961	C1	129	1.15	31.3	84.5	19.660	208-230	5,6,9,28
10	7.5	1800	215T	010180S1CCD215T	\$1,468	C1	162	1.15	43.0	85.0	21.235	208-230	5,6,9,28



ODP - Resilient Base

HP	kW	RPM	Frame	Catalog Number	List Price	Mult. Symbol	Approx. Shipping Weight (lbs)	Service Factor	FL Amps @ High	FL. Eff (%)	"C" Dimension (in)	Voltage (V)	Notes
0.16	0.12	1800	48Z	.16180S1ASPRB048Z-S	\$272	F1B	21	1.35	3.00	50.5	10.138	115	3,9,13,16
		1800	48Z	.16180S1ASPRB48Z-S	\$260	F1B	21	1.35	3.00	50.5	10.138	115	3,9,13,16
0.25	0.18	1800	48Z	.25180S1BSPRB048Z-S	\$274	F1B	22	1.35	2.10	55.0	10.138	115/208-230	3,9,13,16
		1800	48Z	.25180S1ASPRB048Z-S	\$274	F1B	22	1.35	4.30	55.0	10.138	115	3,9,13,16
		1800	48Z	.25180S1ASPRB48Z-S	\$262	F1B	22	1.35	4.30	55.0	10.138	115	3,9,13,16
0.33	0.25	1800	48Z	.33180S1BSPRB048Z-S	\$284	F1B	24	1.35	2.60	60.8	10.138	115/208-230	3,9,13,16
		1800	48Z	.33180S1BSPRB48Z-S	\$272	F1B	24	1.35	2.60	60.8	10.138	115/208-230	3,9,13,16
		1800	W56	.33180S1BSPRBOW56-S	\$288	F1B	25	1.35	2.60	62.0	10.138	115/208-230	3,9,13,16
		1800	W56	.33180S1BSPRBW56-S	\$276	F1B	25	1.35	2.60	62.0	10.138	115/208-230	3,9,13,16
		1800	W56	.33180T1BRBOW56-S	\$325	F2B	24	1.35	2.10	72.4	10.925	115/208-230	3,9,13
0.50	0.37	1800	48Z	.50180S1BSPRB048Z-S	\$311	F1B	29	1.25	3.70	63.5	10.925	115/208-230	3,9,13,16
		1800	48Z	.50180S1BSPRB48Z-S	\$299	F1B	29	1.25	3.70	63.5	10.925	115/208-230	3,9,13,16
		1800	W56	.50180S1BSPRBOW56-S	\$316	F1B	30	1.25	3.70	63.5	10.945	115/208-230	3,9,13,16
		1800	W56	.50180S1BSPRBW56-S	\$304	F1B	30	1.25	3.70	63.5	10.945	115/208-230	3,9,13,16
		1800	W56	.50180T1BRBOW56-S	\$368	F2B	26	1.25	2.75	76.2	11.319	115/208-230	3,9,13
0.75	0.55	1800	56	.75180T1BRB056-S	\$434	F2B	38	1.25	3.40	81.8	12.402	115/208-230	3,9,13
1	0.75	1800	56	001180T1BRB056-S	\$468	F2B	43	1.15	4.50	82.6	13.189	115/208-230	3,9,13
1.5	1.1	3600	56	001560T1BRB056-S	\$450	F2B	39	1.15	6.20	81.5	12.795	115/208-230	3,9,13
		1800	56H	001580T1BRB056-S	\$570	F2B	50	1.15	6.80	83.8	13.583	115/208-230	3,9,13
2	1.5	1800	56H	002180T1BRB056H-S	\$616	F2B	57	1.15	9.30	84.5	14.373	115/208-230	3,9,13

Please refer to back cover for description of "NOTES"

For detailed specifications, data sheets, drawings and performance curves visit <http://www.weg.net>



Single-Phase General Purpose Motors

Single-Phase
General Purpose
Motors

ODP - C-Face - Foot Mount

HP	kW	RPM	Frame	Catalog Number	List Price	Mult. Symbol	Approx. Shipping Weight (lbs)	Service Factor	FL Amps @ High	FL. Eff (%)	"C" Dimension (in)	Voltage (V)	Notes
0.12	0.09	1800	48CH	.12180S1B48CH-S	\$222	F1B	18	1.40	1.40	50.0	9.098	115/208-230	9
0.16	0.12	3600	48CH	.16360S1B48CH-S	\$237	F1B	21	1.35	1.40	53.0	9.098	115/208-230	9
		1800	48CH	.16180S1B48CH-S	\$231	F1B	22	1.35	1.70	53.0	9.098	115/208-230	9
0.25	0.18	3600	48CH	.25360T1B48CH-S	\$277	F2B	19	1.35	1.30	66.6	9.492	115/208-230	9
		3600	W56C	.25360T1BW56C-S	\$281	F2B	19	1.35	1.30	66.6	9.866	115/208-230	9
		1800	48CH	.25180T1B48CH-S	\$269	F2B	18	1.35	1.60	68.5	9.492	115/208-230	9
		1800	W56C	.25180T1BW56C-S	\$269	F2B	19	1.35	1.60	68.5	9.866	115/208-230	9
0.33	0.25	3600	48CH	.33360T1B48CH-S	\$282	F2B	23	1.35	1.60	70.5	9.886	115/208-230	9
		3600	W56C	.33360T1BW56C-S	\$285	F2B	23	1.35	1.60	70.5	10.260	115/208-230	9
		1800	48CH	.33180T1B48CH-S	\$299	F2B	20	1.35	2.10	72.4	9.886	115/208-230	9
		1800	W56C	.33180T1BW56C-S	\$303	F2B	21	1.35	2.10	72.4	10.260	115/208-230	9
0.50	0.37	3600	48CH	.50360T1B48CH-S	\$300	F2B	23	1.25	2.40	72.4	9.886	115/208-230	9
		3600	W56C	.50360T1BW56C-S	\$310	F2B	24	1.25	2.40	72.4	10.260	115/208-230	9
		1800	W56C	.50180T1BOW56C-S	\$352	F2B	24	1.25	2.80	76.2	10.654	115/208-230	3,9
		1800	W56C	.50180T1BW56C-S	\$335	F2B	24	1.25	2.80	76.2	10.654	115/208-230	9
0.75	0.55	3600	56C	.75360T1B56C-S	\$348	F2B	30	1.25	3.40	76.2	11.890	115/208-230	9
		1800	56C	.75180T1B56C-S	\$415	F2B	38	1.25	3.40	81.8	11.890	115/208-230	9
1	0.75	3600	56C	001360T1B56C-S	\$375	F2B	35	1.25	4.30	80.4	11.890	115/208-230	9
		1800	56C	001180T1B56C-S	\$449	F2B	41	1.15	4.50	82.6	12.677	115/208-230	9
1.5	1.1	3600	56C	001560T1B56C-S	\$421	F2B	38	1.15	6.20	81.5	12.284	115/208-230	9
		1800	56HC	001580T1B56C-S	\$551	F2B	49	1.15	6.80	83.8	13.071	115/208-230	9
2	1.5	3600	56HC	002360T1B56C-S	\$513	F2B	43	1.15	8.40	82.9	12.677	115/208-230	9
		1800	56HC	002180T1B56C-S	\$654	F2B	54	1.15	9.30	84.5	13.465	115/208-230	9
3	2.2	3600	56HC	003360T1B56C-S	\$596	F2B	52	1.15	12.2	84.1	13.465	115/208-230	9

Please refer to back cover for description of "NOTES"

For detailed specifications, data sheets, drawings and performance curves visit <http://www.weg.net>

Data subject to change without notice.

Can't find what you are looking for? Call 1-800-ASK-4WEG (275-4934)

Single-Phase General Purpose Motors



Single-Phase
General Purpose
Motors

ODP - C-Face - Footless

HP	kW	RPM	Frame	Catalog Number	List Price	Mult. Symbol	Approx. Shipping Weight (lbs)	Service Factor	FL Amps @ High	FL. Eff (%)	"C" Dimension (in)	Voltage (V)	Notes
0.33	0.25	3600	W56C	.33360T1BW56CFL-S	\$285	F2B	23	1.35	1.60	70.5	10.260	115/208-230	9,20
		3600	W56C	.33360T1BOW56CFL-S	\$302	F2B	23	1.35	1.60	70.5	10.260	115/208-230	3,9,20
		1800	W56C	.33180T1BW56CFL-S	\$303	F2B	20	1.35	2.10	72.4	10.260	115/208-230	9,20
0.50	0.37	3600	W56C	.50360T1BOW56CFL-S	\$327	F2B	23	1.25	2.40	72.4	10.260	115/208-230	3,9,20
		3600	W56C	.50360T1BW56CFL-S	\$310	F2B	23	1.25	2.40	72.4	10.260	115/208-230	9,20
		1800	W56C	.50180T1BW56CFL-S	\$335	F2B	23	1.25	2.80	76.2	10.654	115/208-230	9,20
0.75	0.55	3600	56C	.75360T1B056CFL-S	\$365	F2B	29	1.25	3.40	76.2	11.890	115/208-230	3,9,20
		3600	56C	.75360T1B56CFL-S	\$348	F2B	29	1.25	3.40	76.2	11.890	115/208-230	9,20
		1800	56C	.75180T1B56CFL-S	\$415	F2B	38	1.25	3.40	81.8	11.890	115/208-230	9,20
1	0.75	3600	56C	001360T1B56CFL-S	\$375	F2B	35	1.25	4.30	80.4	11.890	115/208-230	9,20
		3600	56C	001360T1B056CFL-S	\$392	F2B	35	1.25	4.30	80.4	11.890	115/208-230	3,9,20
		1800	56C	001180T1B56CFL-S	\$449	F2B	41	1.15	4.50	82.6	12.677	115/208-230	9,20
1.5	1.1	3600	56C	001560T1B56CFL-S	\$421	F2B	38	1.15	6.20	81.5	12.284	115/208-230	9,20
		3600	56C	001560T1B056CFL-S	\$438	F2B	38	1.15	6.20	81.5	12.284	115/208-230	3,9,20
		1800	56C	001580T1B56CFL-S	\$551	F2B	48	1.15	6.80	83.8	13.071	115/208-230	9,20
2	1.5	3600	56C	002360T1B56CFL-S	\$513	F2B	43	1.15	8.40	82.9	12.677	115/208-230	9,20
		3600	56C	002360T1B056CFL-S	\$530	F2B	43	1.15	8.40	82.9	12.677	115/208-230	3,9,20
		1800	56C	002180T1B56CFL-S	\$654	F2B	54	1.15	9.30	84.5	13.465	115/208-230	9,20
3	2.2	3600	56C	003360T1B056CFL-S	\$613	F2B	51	1.15	12.2	84.1	13.465	115/208-230	3,9,20
		3600	56C	003360T1B56CFL-S	\$596	F2B	51	1.15	12.2	84.1	13.465	115/208-230	9,20



ODP - Foot Mount - Thermally Protected

HP	kW	RPM	Frame	Catalog Number	List Price	Mult. Symbol	Approx. Shipping Weight (lbs)	Service Factor	FL Amps @ High	FL. Eff (%)	"C" Dimension (in)	Voltage (V)	Notes
0.50	0.37	3600	W56	.50360S1BCDW56-S	\$224	C1S	28	1.00	3.10	63.0	9.866	115/208-230	1,4,6,9
0.75	0.55	3600	W56	.75360S1BCDW56-S	\$237	C1S	22	1.00	4.30	68.5	10.260	115/208-230	1,4,6,9
1	0.75	3600	56	001360S1BCD56-S	\$278	C1S	36	1.00	6.60	67.0	11.102	115/208-230	1,4,6,9
		1800	56	001180T1B056-S	\$438	F2B	41	1.15	4.50	82.6	12.677	115/208-230	3,9
1.5	1.1	3600	56	001560S1BCD56-S	\$311	C1S	40	1.00	8.70	68.0	11.496	115/208-230	1,4,6,9
		1800	56H	001580T1B056-S	\$541	F2B	50	1.15	6.80	83.8	13.465	115/208-230	3,9
2	1.5	3600	56H	002360S1BCD56-S	\$372	C1S	34	1.00	8.90	70.0	11.890	115/208-230	1,4,6,9
3	2.2	3600	56H	003360S1CCD56-S	\$432	C1S	41	1.00	12.7	80.0	12.677	208-230	1,4,6,9
5	3.7	3600	56H	005360S1DCD56H-S	\$458	C1S	53	1.00	20.3	80.0	13.465	230	1,4,6,9
		3600	56HZ	005360S1DCD56HZ-S	\$481	C1S	53	1.00	20.3	80.0	13.533	230	1,4,5,6,9
		3600	W182/4Y	005360S1CCDW184Y-S	\$526	C1S	56	1.00	20.7	80.0	15.152	208-230	1,4,5,6,9

Please refer to back cover for description of "NOTES"

For detailed specifications, data sheets, drawings and performance curves visit <http://www.weg.net>

Data subject to change without notice.

MUCH MORE than your **Typical** **CAST IRON MOTOR**



You do not need a special motor for severe duty applications.
Severe Duty is standard with WEG W22 motors.

- Severe Duty (IP55)
- 1.25 SF (up to 100 HP)
- IEEE841 Vibration Levels
- Certified Class I, Div 2
- Inverter Rated 20:1 CT

Available in NEMA Premium or Super Premium Efficiency Levels



**ASK WHAT WEG
CAN DO FOR YOU!**

Three-Phase General Purpose Motors

TEFC – Foot Mount	A-32
TEFC – C-Face – Foot Mount	A-42
TEFC – C-Face – Footless	A-46
ODP – Foot Mount	A-50
ODP – C-Face – Foot Mount	A-56
ODP – C-Face – Footless	A-60
ODP – Resilient Base	A-60

IEEE 841 - Three-Phase

TEFC – Foot Mount – NEMA Premium®	A-62
TEFC – C-Face – Foot Mount – NEMA Premium®	A-66
TEFC – C-Face – Footless – NEMA Premium®	A-67

BRAKE MOTORS – Three-Phase

TEFC – Foot Mount - Cast Iron	A-69
TEFC – C-Face – Foot Mount - Cast Iron	A-70
TEFC – Foot Mount - Rolled Steel	A-71
TEFC – C-Face – Foot Mount - Rolled Steel	A-72
TEFC – C-Face – Footless - Rolled Steel	A-72

IEC TRU-METRIC™ - Three-Phase

TEFC – Foot Mount	A-75
TEFC – Foot Mount - FF-Face	A-78

Please refer to back cover for description of "NOTES"

For detailed specifications, data sheets, drawings and performance curves visit <http://www.weg.net>

Three Phase General Purpose Motors

W22 - CAST IRON

Three-Phase
General Purpose
Motors

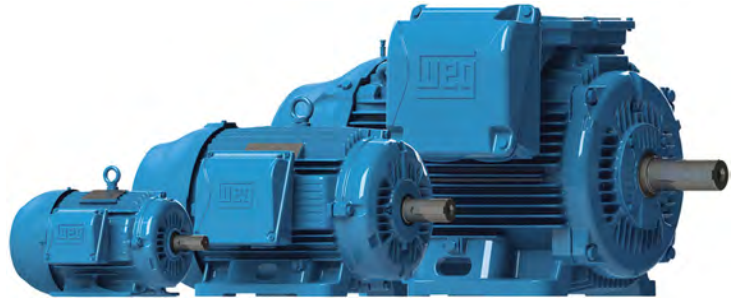

Standard Features:

- 50/60 Hz rated (380V on nameplate - 400/415 available)
- Rated 50HZ at same horsepower up to 250HP 1.0 Service Factor for 2, 4 & 6 pole motors
- Rated 50Hz at same horsepower up to 125HP 1.0 Service Factor for 8 pole motors
- Class F insulation (impregnation resin and magnet wire are class H)
- F1 mounted (cast iron frames are F2 convertible). Frames 447T and up can easily be F2 converted by simply rotating the terminal box adapter
- Cast iron frames: regreasable ball bearings (frames 254T and up)
- Gasketed conduit box

Inverter Rated*

1000:1 for Variable Torque

NEMA Premium®

20:1 Constant Torque up to 250HP

6:1 Constant Torque 300HP and up

* Insulated NDE housing standard on L447/9T and above

Features that make a difference:

- All NEMA Premium® ratings have a 1.25 Service Factor (up to 100 HP) resulting in cooler operation and extended life of the motor
- All Cast Iron Construction, including Terminal Box and Fan Cover*
- Solid feet for reduced vibration levels and impact absorption
- Optimized ventilation system for cooler operation and extended life
- High Grade FC200 cast iron provides superior mechanical strength and heat dissipation
- All WEG W22 motors are Totally Enclosed Fan Cooled with a true IP55 rating against dust and moisture. (IP56, IP65 and IP66 available as options)
- Exclusive W-Seal 364T and larger provides superior bearing protection
- Taconite Labyrinth seal 586 Frame and larger
- Exclusive WEG painting system exceed 200hrs ASTM 117 corrosion test (Exceeds IEEE 841 standard)
- Balanced to 0.08 inches per second vibration limits (Meets IEEE 841 standard)
- Four Bolt Conduit Cover with glued Neoprene Gasket
- Impregnation Resin and magnet wire are insulation class H
- Stainless Steel Nameplate - Laser etched with high contrast background
- Corrosion Proof Drains
- Inverter Duty per NEMA MG1, Part 31
- Certified Class I Div 2, Groups A, B, C & D, Class II, Div 2, Groups F & G
- Suitable for IEEE45 and USCG 259 – Marine Duty

*Cast iron fan cover available as an option on 143-215T frames

ADDITIONAL TECHNICAL DATA

ELECTRICAL DATA: B-12

MECHANICAL DATA: B-72



W22

TEFC - Cast Iron

Three-Phase
General Purpose
Motors

Cooling System

Fan Cover

- Aerodynamic design
- Minimal noise levels
- Superb air flow distribution over frame
- Superior mechanical strength

Fan

- Reinforced fan hub structure
- Low noise design with exceptional air flow

Terminal Box

- Excellent connection quality
- Easy cable handling during installation
- Ample space available for accessory installation
- Easy to maintain
- Mounting F1/F2/F3
- Rotation on 90° stages

Bearing Caps

External

- Finned surface for superb bearing heat dissipation

Internal

- Positive pressure lubrication system
- High quality bearing lubrication
- Reduced bearing temperature

Seal Subsystem

- Excellent dust and moisture protection
- Excellent protection to high-pressure cleaning

Frame

- Low temperature on windings and bearings
- Low noise design
- Terminal box position outlet on top 447T and larger

Pad for vibration sensor

- Displaced 90° from each other

Enhanced Lifting Provisions

- Easy handling - horizontal & vertical
- Superior mechanical strength and handling safety

Solid feet

- Impact resistance
- Ideal for high vibration level applications

Endshields Subsystem

DE (Drive Endshield)

- Fin design increases air flow
- Bearing moved outwards for better load support
- Bearing heat dissipation for reduced bearing temperature
- Reinforced endshield structure

NDE (Non-Drive Endshield)

- Smooth exterior surface
- Optimal air flow
- Designed for low noise
- Structural rigidity for low vibration
- Insulated housing standard on L447/9T and above

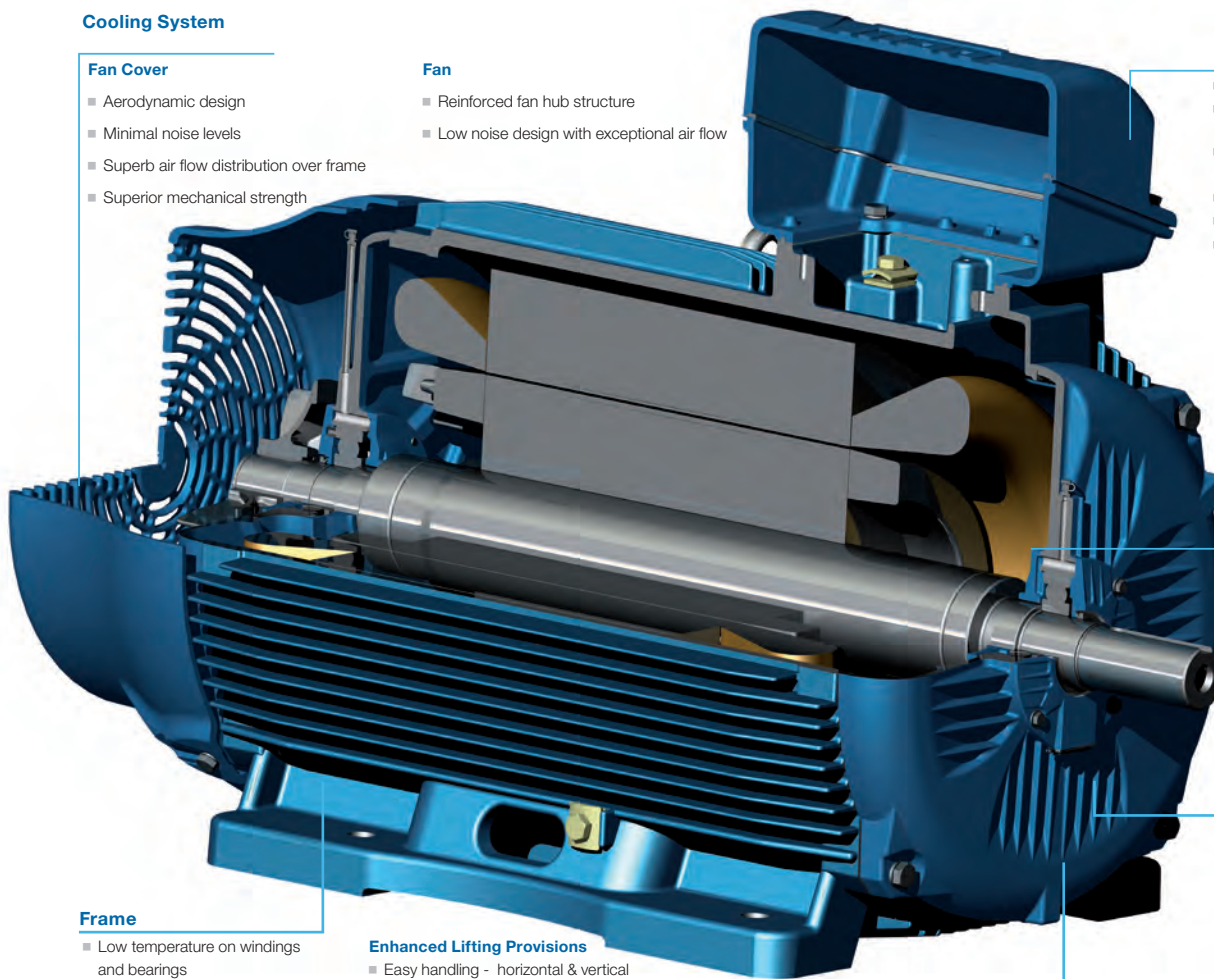

Three-Phase General Purpose Motors

TEFC - ROLLED STEEL

Standard Features:

- Rated Output: 0.25 to 25 HP
- Number of Poles: 2 to 6
- Class F insulation
- Frame Sizes: NEMA 56 to 254/6T
- Frequency: 60 Hz (dual rated 50 Hz 190-220/380-415V)
- F1 mount as standard
- Foot mount / C-face / Footless availability
- Enclosure: TEFC
- Aluminum endshields
- Certified Class I, Div 2, Groups A,B,C,D
- Cast Iron flanges for improved strength (182/4TC and larger)
- Internal bolts, giving a clean surface to the motor, avoiding trapping materials and allowing easy paint job after assembly to the load if required
- Double shielded ball bearings on frames 56 to 213/5T.
- Versions: General Purpose, Jet Pump, Close-coupled Pump type "JM" and "JP", and Crop Dryer

Optional Features:

- IP56 ingress protection
- F2 and F3 mount
- Enclosure: TEAO and TENV
- Regreasable bearings optional on 182/4T and 213/5T
- Double sealed ball bearings and/or bearing cap
- Drip cover
- Internal AEGIS® SGR
- Space heaters and thermal protection (thermostats and thermistors)
- Refer to the mod section for more options



Features that make a difference:

- New ventilation system for improved thermal performance
- Robust foot design suitable for tougher applications
- New and more robust eyebolts design (frames 182/4T and up) plus a second eyebolt on non-drive end allowing vertical lifting capability (frames 213/5T and 254/6T)
- Oversized diagonally split aluminum terminal box that exceeds IP55 requirements
- Terminal box rotatable in 90 degree increments for flexibility during installation
- Option for internal AEGIS® SGR
- Color coded leads as standard for easy wiring
- Regreasable ball bearings on 254/6T frame as standard (optional for 182/4T and 213/5T)
- IP55 Ingress Protection as standard, being appropriate for severe environments
- Bearing cap as standard on flanged motors, optional on non flanged
- Suitable for VFD operation as per NEMA MG1 part 31.4.4.2
- Motor frame painting system 500 hours salt spray resistant

ADDITIONAL TECHNICAL DATA

ELECTRICAL DATA: B-15

MECHANICAL DATA: B-75



Three-Phase General Purpose Motors



TEFC - Foot Mount

Three-Phase
General Purpose
Motors

HP	kW	RPM	Frame	Catalog Number	List Price	Mult. Symbol	Approx. Shipping Weight (lbs)	Service Factor	FL Amps @ High	FL Eff (%)	"C" Dimension (in)	Voltage (V)	Notes
0.25	0.18	3600	56	.2536ES3E56-S	\$237	F1	21	1.15	0.50	57.5	11.142	208-230/460	9
		1800	56	.2518ES3E56-S	\$249	F1	23	1.15	0.50	70.0	11.142	208-230/460	9
0.33	0.25	3600	56	.3336ES3E56-S	\$249	F1	22	1.15	0.60	62.0	11.142	208-230/460	9
		1800	56	.3318ES3E56-S	\$253	F1	24	1.15	0.60	74.0	11.535	208-230/460	9
0.5	0.37	3600	56	.5036ES3E56-S	\$258	F1	24	1.15	0.80	68.0	11.535	208-230/460	9
		1800	56	.5018ES3E56-S	\$287	F1	26	1.15	0.90	77.0	11.535	208-230/460	9
		1800	56	.5018ES3H56-S	\$288	F1	26	1.15	0.70	77.0	11.535	575	9
		1200	56	.5012ES3E56-S	\$417	F1	31	1.15	1.00	72.0	12.323	208-230/460	9
0.75	0.55	3600	56	.7536ES3E56-S	\$287	F1	25	1.15	1.10	72.0	11.535	208-230/460	9
		3600	56	.7536ES3H56-S	\$288	F1	25	1.15	0.90	72.0	11.535	575	9
		1800	56	.7518ES3E56-S	\$311	F1	28	1.15	1.20	78.5	11.929	208-230/460	9
		1200	56H	.7512ES3E56-S	\$427	F1	34	1.15	1.30	75.5	12.716	208-230/460	9
1	0.75	3600	W56	00136ET3EW56-S	\$392	F1	25	1.15	1.50	78.5	11.106	230/460	9
		3600	W56	00136ET3HW56-S	\$392	F1	25	1.15	1.20	78.5	11.106	575	9
		3600	143/5T	00136ET3E143T-S	\$420	RSP	31	1.15	1.40	78.5	13.189	230/460	9
		3600	143/5T	00136ET3H143T-S	\$420	RSP	31	1.15	1.10	78.5	13.189	575	9
		3600	143/5T	00136ET3E143T-W22	\$538	N1	45	1.25	1.44	81.5	13.358	230/460	
		3600	143/5T	00136ET3H143T-W22	\$538	N1	44	1.25	1.15	81.5	13.358	575	
		1800	56	00118ET3E56-S	\$379	F1	41	1.15	1.50	85.5	13.504	230/460	9
		1800	56	00118ET3H56-S	\$379	F1	41	1.15	1.20	85.5	13.504	575	9
		1800	143/5T	00118ET3E143T-S	\$459	RSP	42	1.15	1.50	85.5	13.583	230/460	9
		1800	143/5T	00118ET3H143T-S	\$459	RSP	42	1.15	1.20	85.5	13.583	575	9
		1800	143/5T	00118ET3E143T-W22	\$527	N1	48	1.25	1.47	85.5	13.358	230/460	
		1800	143/5T	00118ET3H143T-W22	\$527	N1	48	1.25	1.18	85.5	13.358	575	
		1200	56H	00112ET3E56-S	\$497	F1	42	1.15	1.60	82.5	13.504	230/460	9
		1200	143/5T	00112ET3E145T-S	\$529	RSP	43	1.15	1.60	82.5	13.583	230/460	9
		1200	143/5T	00112ET3H145T-S	\$529	RSP	43	1.15	1.30	82.5	13.583	575	9
		1200	143/5T	00112ET3E145T-W22	\$608	N1	55	1.25	1.73	82.5	13.358	230/460	
		1200	143/5T	00112ET3H145T-W22	\$608	N1	55	1.25	1.38	82.5	13.358	575	
		900	182/4T	00109ET3E182T-W22	\$1,043	N1	88	1.25	2.30	78.5	15.860	230/460	
		900	182/4T	00109ET3H182T-W22	\$1,043	N1	104	1.25	1.84	78.5	15.860	575	

continued on next page

Please refer to back cover for description of "NOTES"

For detailed specifications, data sheets, drawings and performance curves visit <http://www.weg.net>



TEFC - Foot Mount - *continued*

HP	kW	RPM	Frame	Catalog Number	List Price	Mult. Symbol	Approx. Shipping Weight (lbs)	Service Factor	FL Amps @ High	FL Eff (%)	"C" Dimension (in)	Voltage (V)	Notes
1.5	1.1	3600	56	00156ET3E56-S	\$433	F1	37	1.15	1.90	84.0	13.109	230/460	9
		3600	143/5T	00156ET3E143T-S	\$473	RSP	39	1.15	1.90	84.0	13.189	230/460	9
		3600	143/5T	00156ET3H143T-S	\$473	RSP	39	1.15	1.50	84.0	13.189	575	9
		3600	143/5T	00156ET3E143T-W22	\$543	N1	49	1.25	1.96	84.0	13.358	230/460	
		3600	143/5T	00156ET3H143T-W22	\$543	N1	49	1.25	1.57	84.0	13.358	575	
		1800	56H	00158ET3E56-S	\$435	F1	44	1.15	2.00	86.5	13.504	230/460	9
		1800	143/5T	00158ET3E145T-S	\$480	RSP	43	1.15	2.00	86.5	13.583	230/460	9
		1800	143/5T	00158ET3H145T-S	\$480	RSP	43	1.15	1.60	86.5	13.583	575	9
		1800	143/5T	00158ET3E145T-W22	\$551	N1	53	1.25	2.02	86.5	13.358	230/460	
		1800	143/5T	00158ET3H145T-W22	\$551	N1	53	1.25	1.62	86.5	13.358	575	
		1200	182/4T	00152ET3E182T-S	\$656	RSP	76	1.15	2.20	87.5	16.339	230/460	9
		1200	182/4T	00152ET3H182T-S	\$656	RSP	76	1.15	1.80	87.5	16.339	575	9
		1200	182/4T	00152ET3E182T-W22	\$754	N1	97	1.25	2.54	87.5	15.860	230/460	
		1200	182/4T	00152ET3H182T-W22	\$754	N1	97	1.25	2.03	87.5	15.860	575	
		900	182/4T	00159ET3E184T-W22	\$1,207	N1	102	1.25	2.70	82.5	15.860	230/460	
		900	182/4T	00159ET3H184T-W22	\$1,207	N1	102	1.25	2.16	82.5	15.860	575	
2	1.5	3600	56H	00236ET3E56-S	\$489	F1	44	1.15	2.50	85.5	13.898	230/460	9
		3600	143/5T	00236ET3E145T-S	\$514	RSP	45	1.15	2.50	85.5	13.976	230/460	9
		3600	143/5T	00236ET3H145T-S	\$514	RSP	45	1.15	2.00	85.5	13.976	575	9
		3600	143/5T	00236ET3E145T-W22	\$591	N1	54	1.25	2.56	85.5	13.358	230/460	
		3600	143/5T	00236ET3H145T-W22	\$591	N1	54	1.25	2.05	85.5	13.358	575	
		1800	56H	00218ET3E56-S	\$478	F1	46	1.15	2.70	86.5	13.898	230/460	9
		1800	143/5T	00218ET3E145T-S	\$533	RSP	47	1.15	2.70	86.5	13.976	230/460	9
		1800	143/5T	00218ET3H145T-S	\$533	RSP	47	1.15	2.20	86.5	13.976	575	9
		1800	143/5T	00218ET3E145T-W22	\$612	N1	51	1.25	2.76	86.5	13.358	230/460	
		1800	143/5T	00218ET3H145T-W22	\$612	N1	54	1.25	2.21	86.5	13.358	575	
		1200	182/4T	00212ET3E184T-S	\$713	RSP	86	1.15	3.00	88.5	17.126	230/460	9
		1200	182/4T	00212ET3H184T-S	\$713	RSP	86	1.15	2.40	88.5	17.126	575	9
		1200	182/4T	00212ET3E184T-W22	\$819	N1	108	1.25	3.22	88.5	15.860	230/460	39
		1200	182/4T	00212ET3H184T-W22	\$819	N1	103	1.25	2.58	88.5	15.860	575	39
		900	213/5T	00209ET3E213T-W22	\$1,848	N1	171	1.25	3.39	85.5	19.517	230/460	
		900	213/5T	00209ET3H213T-W22	\$1,848	N1	171	1.25	2.71	85.5	19.517	575	

continued on next page

Three-Phase
General Purpose
Motors

Please refer to back cover for description of "NOTES"

For detailed specifications, data sheets, drawings and performance curves visit <http://www.weg.net>

Data subject to change without notice.

Can't find what you are looking for? Call 1-800-ASK-4WEG (275-4934)

TEFC - Foot Mount - *continued*

 Three-Phase
General Purpose
Motors

HP	kW	RPM	Frame	Catalog Number	List Price	Mult. Symbol	Approx. Shipping Weight (lbs)	Service Factor	FL Amps @ High	FL Eff (%)	"C" Dimension (in)	Voltage (V)	Notes
3	2.2	3600	56H	00336ET3E56-S	\$578	F1	54	1.15	3.50	86.5	15.079	230/460	9
		3600	182/4T	00336ET3E182T-S	\$665	RSP	73	1.15	3.70	86.5	16.339	230/460	9
		3600	182/4T	00336ET3H182T-S	\$665	RSP	73	1.15	3.00	86.5	16.339	575	9
		3600	182/4T	00336ET3E182T-W22	\$763	N1	99	1.25	3.63	86.5	15.860	230/460	
		3600	182/4T	00336ET3H182T-W22	\$763	N1	99	1.25	2.90	86.5	15.860	575	
		1800	182/4T	00318ET3E182T-S	\$577	RSP	100	1.15	3.80	89.5	17.913	230/460	9
		1800	182/4T	00318ET3H182T-S	\$577	RSP	100	1.15	3.00	89.5	17.913	575	9
		1800	182/4T	00318ET3E182T-W22	\$663	N1	92	1.25	3.91	89.5	15.860	230/460	
		1800	182/4T	00318ET3H182T-W22	\$663	N1	94	1.25	3.13	89.5	15.860	575	
		1200	213/5T	00312ET3E213T-S	\$983	RSP	134	1.15	4.20	89.5	19.291	230/460	9
		1200	213/5T	00312ET3H213T-S	\$983	RSP	133	1.15	3.40	89.5	19.291	575	9
		1200	213/5T	00312ET3E213T-W22	\$1,129	N1	160	1.25	4.41	89.5	19.517	230/460	
		1200	213/5T	00312ET3H213T-W22	\$1,129	N1	163	1.25	3.53	89.5	19.517	575	
		900	213/5T	00309ET3E215T-W22	\$2,115	N1	189	1.25	4.55	85.5	19.517	230/460	
900	213/5T	00309ET3H215T-W22	\$2,115	N1	188	1.25	3.64	85.5	19.517	575			
5	3.7	3600	182/4T	00536ET3E184T-SRT	\$810	RSP	85	1.15	5.90	88.5	16.339	230/460	9
		3600	182/4T	00536ET3E184T-S	\$760	RSP	85	1.15	5.90	88.5	17.913	230/460	9
		3600	182/4T	00536ET3H184T-S	\$760	RSP	85	1.15	4.70	88.5	17.913	575	9
		3600	182/4T	00536ET3E184T-W22	\$873	N1	103	1.25	5.90	88.5	15.860	230/460	
		3600	182/4T	00536ET3H184T-W22	\$873	N1	106	1.25	4.72	88.5	15.860	575	
		1800	182/4T	00518ET3E184T-SRT	\$840	RSP	93	1.15	6.49	89.5	16.732	230/460	9
		1800	182/4T	00518ET3H184T-SRT	\$840	RSP	93	1.15	5.19	89.5	16.732	575	9
		1800	182/4T	00518ET3E184T-S	\$672	RSP	93	1.15	6.50	89.5	17.913	230/460	9
		1800	182/4T	00518ET3H184T-S	\$672	RSP	93	1.15	5.20	89.5	17.913	575	9
		1800	182/4T	00518ET3P184T-S	\$672	RSP	93	1.15	15.0	89.5	17.913	200	9
		1800	182/4T	00518ET3E184T-W22	\$772	N1	101	1.25	6.45	89.5	15.860	230/460	
		1800	182/4T	00518ET3H184T-W22	\$772	N1	104	1.25	5.16	89.5	15.860	575	
		1800	182/4T	00518ET3P184T-W22	\$772	N1	103	1.25	14.8	89.5	15.860	200	
		1200	213/5T	00512ET3E215T-S	\$1,160	RSP	153	1.15	6.70	89.5	20.079	230/460	9
		1200	213/5T	00512ET3H215T-S	\$1,160	RSP	152	1.15	5.40	89.5	20.079	575	9
		1200	213/5T	00512ET3E215T-W22	\$1,332	N1	170	1.25	6.83	89.5	19.517	230/460	
		1200	213/5T	00512ET3H215T-W22	\$1,332	N1	180	1.25	5.46	89.5	19.517	575	
		900	254/6T	00509ET3E254T-W22	\$3,301	N1	302	1.25	7.58	87.5	24.945	230/460	
900	254/6T	00509ET3H254T-W22	\$3,301	N1	321	1.25	6.06	87.5	24.945	575			

continued on next page

Please refer to back cover for description of "NOTES"

For detailed specifications, data sheets, drawings and performance curves visit <http://www.weg.net>



TEFC - Foot Mount - *continued*

HP	kW	RPM	Frame	Catalog Number	List Price	Mult. Symbol	Approx. Shipping Weight (lbs)	Service Factor	FL Amps @ High	FL Eff (%)	"C" Dimension (in)	Voltage (V)	Notes
7.5	5.5	3600	182/4T	00736ET3E184T-W22	\$1,074	N1	106	1.25	8.76	89.5	15.860	230/460	12
		3600	213/5T	00736ET3E213T-SRT	\$1,078	RSP	126	1.15	8.67	89.5	18.897	230/460	9
		3600	213/5T	00736ET3E213T-S	\$980	RSP	143	1.15	8.70	89.5	20.079	230/460	9
		3600	213/5T	00736ET3H213T-S	\$980	RSP	143	1.15	7.00	89.5	20.079	575	9
		3600	213/5T	00736ET3E213T-W22	\$1,125	N1	149	1.25	8.76	89.5	19.517	230/460	
		3600	213/5T	00736ET3H213T-W22	\$1,125	N1	163	1.25	7.01	89.5	19.517	575	
		1800	213/5T	00718ET3E213T-S	\$948	RSP	140	1.15	9.10	91.7	18.898	230/460	9
		1800	213/5T	00718ET3H213T-S	\$948	RSP	140	1.15	7.30	91.7	18.898	575	9
		1800	213/5T	00718ET3P213T-S	\$948	RSP	140	1.15	20.9	91.7	18.898	200	9
		1800	213/5T	00718ET3E213T-W22	\$1,089	N1	170	1.25	9.18	91.7	19.517	230/460	
		1800	213/5T	00718ET3H213T-W22	\$1,089	N1	174	1.25	7.34	91.7	19.517	575	
		1800	213/5T	00718ET3P213T-W22	\$1,089	N1	175	1.25	21.1	91.7	19.517	200	
		1200	254/6T	00712ET3E254T-S	\$1,799	RSP	231	1.15	10.0	91.0	22.559	230/460	9
		1200	254/6T	00712ET3H254T-S	\$1,799	RSP	229	1.15	8.00	91.0	22.559	575	9
		1200	254/6T	00712ET3E254T-W22	\$2,065	N1	300	1.25	9.48	91.0	24.945	230/460	
		1200	254/6T	00712ET3H254T-W22	\$2,065	N1	316	1.25	7.58	91.0	24.945	575	39
		900	254/6T	00709ET3E256T-W22	\$3,658	N1	317	1.25	11.1	87.5	24.945	230/460	
		900	254/6T	00709ET3H256T-W22	\$3,658	N1	373	1.25	8.88	87.5	24.945	575	
10	7.5	3600	213/5T	01036ET3E215T-SRT	\$1,276	RSP	178	1.15	11.5	90.2	19.291	230/460	9
		3600	213/5T	01036ET3E215T-S	\$1,160	RSP	178	1.15	11.5	90.2	21.654	230/460	9
		3600	213/5T	01036ET3H215T-S	\$1,160	RSP	178	1.15	9.20	90.2	21.654	575	9
		3600	213/5T	01036ET3E215T-W22	\$1,332	N1	172	1.25	11.6	90.2	19.517	230/460	
		3600	213/5T	01036ET3H215T-W22	\$1,332	N1	180	1.25	9.28	90.2	19.517	575	
		1800	213/5T	01018ET3E215T-S	\$1,110	RSP	151	1.15	12.2	91.7	19.291	230/460	9
		1800	213/5T	01018ET3H215T-S	\$1,110	RSP	151	1.15	9.80	91.7	19.291	575	9
		1800	213/5T	01018ET3E215T-W22	\$1,273	N1	175	1.25	12.4	91.7	19.517	230/460	
		1800	213/5T	01018ET3H215T-W22	\$1,273	N1	188	1.25	9.92	91.7	19.517	575	
		1800	213/5T	01018ET3P215T-W22	\$1,273	N1	189	1.25	28.5	91.7	19.517	200	
		1200	254/6T	01012ET3E256T-S	\$2,088	RSP	261	1.15	13.8	91.0	23.346	230/460	9
		1200	254/6T	01012ET3H256T-S	\$2,088	RSP	259	1.15	11.0	91.0	23.346	575	9
		1200	254/6T	01012ET3E256T-W22	\$2,396	N1	318	1.25	12.9	91.0	24.945	230/460	
		1200	254/6T	01012ET3H256T-W22	\$2,396	N1	325	1.25	10.3	91.0	24.945	575	
		900	284/6T	01009ET3E284T-W22	\$4,634	N1	373	1.25	13.4	90.2	27.929	230/460	
900	284/6T	01009ET3H284T-W22	\$4,634	N1	371	1.25	10.7	90.2	27.929	575			

continued on next page

Please refer to back cover for description of "NOTES"

For detailed specifications, data sheets, drawings and performance curves visit <http://www.weg.net>

Data subject to change without notice.

TEFC - Foot Mount - *continued*

 Three-Phase
General Purpose
Motors

HP	kW	RPM	Frame	Catalog Number	List Price	Mult. Symbol	Approx. Shipping Weight (lbs)	Service Factor	FL Amps @ High	FL Eff (%)	"C" Dimension (in)	Voltage (V)	Notes
15	11	3600	213/5T	01536ET3E215T-W22	\$1,697	N1	192	1.25	17.0	91.0	19.517	230/460	12
		3600	254/6T	01536ET3E254T-S	\$1,589	RSP	216	1.15	17.4	91.0	22.559	230/460	9
		3600	254/6T	01536ET3H254T-S	\$1,589	RSP	216	1.15	13.9	91.0	22.559	575	9
		3600	254/6T	01536ET3E254T-W22	\$1,824	N1	293	1.25	17.2	91.0	24.945	230/460	
		3600	254/6T	01536ET3H254T-W22	\$1,824	N1	298	1.25	13.8	91.0	24.945	575	
		1800	254/6T	01518ET3E254T-S	\$1,610	RSP	248	1.15	18.2	92.4	22.559	230/460	9
		1800	254/6T	01518ET3H254T-S	\$1,610	RSP	248	1.15	14.6	92.4	22.559	575	9
		1800	254/6T	01518ET3P254T-S	\$1,610	RSP	248	1.15	41.9	92.4	22.559	200	9
		1800	254/6T	01518ET3E254T-W22	\$1,848	N1	339	1.25	18.0	92.4	24.945	230/460	
		1800	254/6T	01518ET3H254T-W22	\$1,848	N1	347	1.25	14.4	92.4	24.945	575	
		1800	254/6T	01518ET3P254T-W22	\$1,848	N1	349	1.25	41.4	92.4	24.945	200	
		1200	284/6TS	01512ET3E284TS-W22	\$3,291	N1	420	1.25	17.9	91.7	26.557	230/460	
		1200	284/6TS	01512ET3H284TS-W22	\$3,291	N1	360	1.25	14.3	91.7	26.557	575	
		1200	284/6T	01512ET3E284T-W22	\$3,291	N1	406	1.25	17.9	91.7	27.929	230/460	
		1200	284/6T	01512ET3H284T-W22	\$3,291	N1	420	1.25	14.3	91.7	27.929	575	
		20	15	900	284/6T	01509ET3E286T-W22	\$5,368	N1	429	1.25	19.4	90.2	27.929
900	284/6T			01509ET3H286T-W22	\$5,368	N1	428	1.25	15.5	90.2	27.929	575	
3600	254/6T			02036ET3E256T-S	\$2,076	RSP	256	1.15	22.7	91.0	23.346	230/460	9
3600	254/6T			02036ET3H256T-S	\$2,076	RSP	256	1.15	18.2	91.0	23.346	575	9
3600	254/6T			02036ET3E256T-W22	\$2,382	N1	317	1.25	23.2	91.0	24.945	230/460	
3600	254/6T			02036ET3H256T-W22	\$2,382	N1	323	1.25	18.6	91.0	24.945	575	
1800	254/6T			02018ET3E256T-S	\$1,918	RSP	279	1.15	24.7	92.4	23.346	230/460	9
1800	254/6T			02018ET3H256T-S	\$1,918	RSP	279	1.15	19.8	93.0	23.346	575	9
1800	254/6T			02018ET3E256T-W22	\$2,201	N1	386	1.25	24.1	93.0	24.945	230/460	
1800	254/6T			02018ET3H256T-W22	\$2,201	N1	396	1.25	19.3	93.0	24.945	575	
1800	254/6T			02018ET3P256T-W22	\$2,201	N1	397	1.25	55.4	93.0	24.945	200	
1200	284/6T			02012ET3E286T-W22	\$3,962	N1	432	1.25	24.2	91.7	27.929	230/460	
1200	284/6T			02012ET3H286T-W22	\$3,962	N1	447	1.25	19.4	91.7	27.929	575	
900	284/6T			02009ET3E286T-W22	\$5,854	N1	556	1.00	28.2	90.2	27.929	230/460	1,12,37
900	324/6T			02009ET3E324T-W22	\$6,339	N1	548	1.25	28.3	91.0	31.116	230/460	
900	324/6T			02009ET3H324T-W22	\$6,339	N1	546	1.25	22.6	91.0	31.116	575	
25	18.5	3600	254/6T	02536ET3E256T-S	\$2,487	RSP	252	1.15	28.5	91.7	23.346	230/460	9
		3600	284/6TS	02536ET3E284TS-W22	\$2,998	N1	391	1.25	28.5	91.7	26.557	230/460	
		3600	284/6TS	02536ET3H284TS-W22	\$2,998	N1	405	1.25	22.8	91.7	26.557	575	
		1800	284/6TS	02518ET3E284TS-W22	\$2,743	N1	438	1.25	29.5	93.6	26.557	230/460	
		1800	284/6T	02518ET3E284T-W22	\$2,743	N1	408	1.25	29.5	93.6	27.929	230/460	
		1800	284/6T	02518ET3H284T-W22	\$2,743	N1	439	1.25	23.6	93.6	27.929	575	
		1200	324/6T	02512ET3E324T-W22	\$4,737	N1	569	1.25	30.4	93.0	31.116	230/460	
		1200	324/6T	02512ET3H324T-W22	\$4,737	N1	583	1.25	24.3	93.0	31.116	575	
		900	324/6T	02509ET3E326T-W22	\$7,315	N1	593	1.25	35.9	91.0	31.116	230/460	
900	324/6T	02509ET3H326T-W22	\$7,315	N1	593	1.25	28.7	91.0	31.116	575			

continued on next page

Please refer to back cover for description of "NOTES"

For detailed specifications, data sheets, drawings and performance curves visit <http://www.weg.net>



TEFC - Foot Mount - *continued*

HP	kW	RPM	Frame	Catalog Number	List Price	Mult. Symbol	Approx. Shipping Weight (lbs)	Service Factor	FL Amps @ High	FL Eff (%)	"C" Dimension (in)	Voltage (V)	Notes
30	22	3600	284/6TS	03036ET3E286TS-W22	\$3,561	N1	408	1.25	33.8	91.7	26.557	230/460	
		3600	284/6TS	03036ET3H286TS-W22	\$3,561	N1	425	1.25	27.0	91.7	26.557	575	
		1800	284/6TS	03018ET3E286TS-W22	\$3,223	N1	476	1.25	35.1	93.6	26.557	230/460	
		1800	284/6T	03018ET3E286T-W22	\$3,223	N1	461	1.25	35.1	93.6	27.929	230/460	
		1800	284/6T	03018ET3H286T-W22	\$3,223	N1	476	1.25	28.1	93.6	27.929	575	
		1200	324/6T	03012ET3E326T-W22	\$5,273	N1	530	1.25	36.2	93.0	31.116	230/460	
		1200	324/6T	03012ET3H326T-W22	\$5,273	N1	627	1.25	29.0	93.0	31.116	575	
		900	364/5T	03009ET3E364T-W22	\$11,215	N1	899	1.25	37.0	92.4	34.251	230/460	
40	30	3600	324/6TS	04036ET3E324TS-W22	\$4,725	N1	546	1.25	45.8	92.4	29.616	230/460	
		3600	324/6TS	04036ET3H324TS-W22	\$4,725	N1	589	1.25	36.6	92.4	29.616	575	
		1800	324/6TS	04018ET3E324TS-W22	\$4,178	N1	613	1.25	47.1	94.1	31.116	230/460	
		1800	324/6T	04018ET3E324T-W22	\$4,178	N1	591	1.25	47.1	94.1	31.116	230/460	
		1800	324/6T	04018ET3H324T-W22	\$4,178	N1	614	1.25	37.7	94.1	31.116	575	
		1800	324/6T	04018ET3P324T-W22	\$4,178	N1	625	1.25	108	94.1	31.116	200	
		1200	364/5T	04012ET3E364T-W22	\$7,284	N1	964	1.25	46.5	94.1	34.251	230/460	
		1200	364/5T	04012ET3H364T-W22	\$7,284	N1	904	1.25	37.2	94.1	34.251	575	
900	364/5T	04009ET3E365T-W22	\$12,194	N1	954	1.25	50.3	92.4	34.251	230/460			
50	37	3600	324/6TS	05036ET3E326TS-W22	\$5,316	N1	587	1.25	56.1	93.0	29.616	230/460	
		3600	324/6TS	05036ET3H326TS-W22	\$5,316	N1	610	1.25	44.9	93.0	29.616	575	
		1800	324/6TS	05018ET3E326TS-W22	\$5,100	N1	637	1.25	59.2	94.5	31.116	230/460	
		1800	324/6T	05018ET3E326T-W22	\$5,100	N1	585	1.25	59.2	94.5	31.116	230/460	
		1800	324/6T	05018ET3H326T-W22	\$5,100	N1	634	1.25	47.4	94.5	31.116	575	
		1200	364/5T	05012ET3E365T-W22	\$8,518	N1	914	1.25	57.4	94.1	34.251	230/460	
		1200	364/5T	05012ET3H365T-W22	\$8,518	N1	1026	1.25	45.9	94.1	34.251	575	
		900	404/5T	05009ET3E404T-W22	\$17,648	N1	1214	1.25	60.0	93.0	39.730	230/460	
60	45	3600	364/5TS	06036ET3E364TS-W22	\$7,552	N1	855	1.25	67.0	93.6	32.338	230/460	
		3600	364/5TS	06036ET3G364TS-W22	\$7,552	N1	961	1.25	67.0	93.6	32.338	460	
		3600	364/5TS	06036ET3H364TS-W22	\$7,552	N1	968	1.25	53.6	93.6	32.338	575	
		1800	364/5TS	06018ET3E364TS-W22	\$7,389	N1	1026	1.25	68.3	95.0	32.338	230/460	
		1800	364/5T	06018ET3E364T-W22	\$7,389	N1	946	1.25	68.3	95.0	34.251	230/460	
		1800	364/5T	06018ET3G364T-W22	\$7,389	N1	1025	1.25	68.3	95.0	34.251	460	
		1800	364/5T	06018ET3H364T-W22	\$7,389	N1	1033	1.25	54.6	95.0	34.251	575	
		1200	404/5T	06012ET3E404T-W22	\$10,497	N1	1252	1.25	69.5	94.5	39.730	230/460	
		1200	404/5T	06012ET3ERB404T-W22	\$10,497	N1	1262	1.25	69.5	94.5	39.730	230/460	14
		1200	404/5T	06012ET3G404T-W22	\$10,497	N1	1213	1.25	69.5	94.5	39.730	460	
		1200	404/5T	06012ET3H404T-W22	\$10,497	N1	1255	1.25	55.6	94.5	39.730	575	
900	404/5T	06009ET3E405T-W22	\$20,443	N1	1263	1.25	73.0	93.0	39.730	230/460			

continued on next page

Three-Phase
General Purpose
Motors

Please refer to back cover for description of "NOTES"

For detailed specifications, data sheets, drawings and performance curves visit <http://www.weg.net>

Data subject to change without notice.

Can't find what you are looking for? Call 1-800-ASK-4WEG (275-4934)

TEFC - Foot Mount - *continued*

 Three-Phase
General Purpose
Motors

HP	kW	RPM	Frame	Catalog Number	List Price	Mult. Symbol	Approx. Shipping Weight (lbs)	Service Factor	FL Amps @ High	FL. Eff (%)	"C" Dimension (in)	Voltage (V)	Notes
75	55	3600	364/5TS	07536ET3E365TS-W22	\$9,091	N1	900	1.25	81.9	93.6	32.338	230/460	
		3600	364/5TS	07536ET3G365TS-W22	\$9,091	N1	963	1.25	81.9	93.6	32.338	460	
		3600	364/5TS	07536ET3H365TS-W22	\$9,091	N1	967	1.25	65.5	93.6	32.338	575	
		1800	364/5TS	07518ET3E365TS-W22	\$8,705	N1	988	1.25	84.1	95.4	32.338	230/460	
		1800	364/5T	07518ET3E365T-W22	\$8,705	N1	969	1.25	84.1	95.4	34.251	230/460	
		1800	364/5T	07518ET3G365T-W22	\$8,705	N1	1045	1.25	84.1	95.4	34.251	460	
		1800	364/5T	07518ET3H365T-W22	\$8,705	N1	1050	1.25	67.3	95.4	34.251	575	
		1200	404/5T	07512ET3E405T-W22	\$12,058	N1	1303	1.25	84.9	94.5	39.730	230/460	
		1200	404/5T	07512ET3ERB405T-W22	\$12,058	N1	1262	1.25	84.9	94.5	39.730	230/460	14
		1200	404/5T	07512ET3G405T-W22	\$12,058	N1	1298	1.25	84.9	94.5	39.730	460	
		1200	404/5T	07512ET3GRB405T-W22	\$12,058	N1	1309	1.25	84.9	94.5	39.730	460	14
		1200	404/5T	07512ET3H405T-W22	\$12,058	N1	1303	1.25	67.9	94.5	39.730	575	
				900	444/5T	07509ET3E444T-W22	\$23,334	N1	1665	1.25	93.0	93.6	45.157
100	75	3600	404/5TS	10036ET3E405TS-W22	\$12,002	N1	1024	1.25	110	94.1	36.732	230/460	
		3600	404/5TS	10036ET3G405TS-W22	\$12,002	N1	1176	1.25	110	94.1	36.732	460	
		3600	404/5TS	10036ET3H405TS-W22	\$12,002	N1	1182	1.25	88.0	94.1	36.732	575	
		1800	404/5TS	10018ET3E405TS-W22	\$11,689	N1	1266	1.25	111	95.4	36.732	230/460	
		1800	404/5T	10018ET3E405T-W22	\$11,689	N1	1190	1.25	111	95.4	39.730	230/460	
		1800	404/5T	10018ET3ERB405T-W22	\$11,689	N1	1239	1.25	111	95.4	39.730	230/460	14
		1800	404/5T	10018ET3G405T-W22	\$11,689	N1	1280	1.25	111	95.4	39.730	460	
		1800	404/5T	10018ET3GRB405T-W22	\$11,689	N1	1199	1.25	111	95.4	39.730	460	14
		1800	404/5T	10018ET3H405T-W22	\$11,689	N1	1283	1.25	88.8	95.4	39.730	575	
		1800	404/5T	10018ET3HRB405T-W22	\$11,689	N1	1294	1.25	88.8	95.4	39.730	575	14
		1200	444/5T	10012ET3E444T-W22	\$15,631	N1	1786	1.25	121	95.0	45.157	230/460	
		1200	444/5T	10012ET3ERB444T-W22	\$15,631	N1	1859	1.25	121	95.0	45.157	230/460	14
		1200	444/5T	10012ET3G444T-W22	\$15,631	N1	1840	1.25	121	95.0	45.157	460	
		1200	444/5T	10012ET3GRB444T-W22	\$15,631	N1	1854	1.25	121	95.0	45.157	460	14
		1200	444/5T	10012ET3H444T-W22	\$15,631	N1	1837	1.25	96.8	95.0	45.157	575	
		900	444/5T	10009ET3E445T-W22	\$26,988	N1	1900	1.25	127	94.1	45.157	230/460	
		900	444/5T	10009ET3G445T-W22	\$26,988	N1	1939	1.25	127	94.1	45.157	460	

continued on next page

Please refer to back cover for description of "NOTES"

For detailed specifications, data sheets, drawings and performance curves visit <http://www.weg.net>



TEFC - Foot Mount - *continued*

HP	kW	RPM	Frame	Catalog Number	List Price	Mult. Symbol	Approx. Shipping Weight (lbs)	Service Factor	FL Amps @ High	FL Eff (%)	"C" Dimension (in)	Voltage (V)	Notes
125	90	3600	444/5TS	12536ET3E444TS-W22	\$15,350	N1	1802	1.15	134	95.0	41.407	230/460	
		3600	444/5TS	12536ET3G444TS-W22	\$15,350	N1	1798	1.15	134	95.0	41.407	460	
		3600	444/5TS	12536ET3H444TS-W22	\$15,350	N1	1795	1.15	107	95.0	41.407	575	
		1800	444/5TS	12518ET3E444TS-W22	\$14,748	N1	1627	1.15	139	95.4	41.407	230/460	
		1800	444/5T	12518ET3E444T-W22	\$14,748	N1	1699	1.15	139	95.4	45.157	230/460	
		1800	444/5T	12518ET3ERB444T-W22	\$14,748	N1	1730	1.15	139	95.4	45.157	230/460	14
		1800	444/5T	12518ET3G444T-W22	\$14,748	N1	1710	1.15	139	95.4	45.157	460	
		1800	444/5T	12518ET3GRB444T-W22	\$14,748	N1	1736	1.15	139	95.4	45.157	460	14
		1800	444/5T	12518ET3H444T-W22	\$14,748	N1	1815	1.15	111	95.4	45.157	575	
		1200	444/5T	12512ET3E445T-W22	\$17,947	N1	1980	1.15	143	95.0	45.157	230/460	
		1200	444/5T	12512ET3ERB445T-W22	\$17,947	N1	1993	1.15	143	95.0	45.157	230/460	14
		1200	444/5T	12512ET3G445T-W22	\$17,947	N1	1893	1.15	143	95.0	45.157	460	
		1200	444/5T	12512ET3GRB445T-W22	\$17,947	N1	1996	1.15	143	95.0	45.157	460	14
		1200	444/5T	12512ET3H445T-W22	\$17,947	N1	1974	1.15	114	95.0	45.157	575	
		900	445/7T	12509ET3G447T-W22	\$28,175	N1	2235	1.15	151	94.5	48.701	460	
150	110	3600	444/5TS	15036ET3E445TS-W22	\$18,882	N1	1899	1.15	161	95.0	41.407	230/460	
		3600	444/5TS	15036ET3G445TS-W22	\$18,882	N1	1908	1.15	161	95.0	41.407	460	
		1800	444/5TS	15018ET3G445TS-W22	\$17,420	N1	1869	1.15	170	95.8	41.407	460	
		1800	444/5T	15018ET3E445T-W22	\$17,420	N1	1918	1.15	170	95.8	45.157	230/460	
		1800	444/5T	15018ET3G445T-W22	\$17,420	N1	1905	1.15	170	95.8	45.157	460	
		1800	444/5T	15018ET3GRB445T-W22	\$17,420	N1	1853	1.15	170	95.8	45.157	460	14
		1800	444/5T	15018ET3H445T-W22	\$17,420	N1	1958	1.15	136	95.8	45.157	575	
		1800	444/5T	15018ET3HRB445T-W22	\$17,420	N1	2034	1.15	136	95.8	45.157	575	14
		1200	445/7T	15012ET3E447T-W22	\$20,639	N1	2354	1.15	176	95.8	48.701	230/460	
		1200	445/7T	15012ET3G447T-W22	\$20,639	N1	2472	1.15	176	95.8	48.701	460	
		1200	445/7T	15012ET3GRB447T-W22	\$20,639	N1	2371	1.15	176	95.8	48.701	460	14
		1200	445/7T	15012ET3H447T-W22	\$20,639	N1	2467	1.15	141	95.8	48.701	575	
900	447/9T	15009ET3G449T-W22	\$30,677	N1	3079	1.15	185	94.5	56.338	460			

continued on next page

Please refer to back cover for description of "NOTES"

For detailed specifications, data sheets, drawings and performance curves visit <http://www.weg.net>

Data subject to change without notice.

Can't find what you are looking for? Call 1-800-ASK-4WEG (275-4934)

TEFC - Foot Mount - *continued*

 Three-Phase
General Purpose
Motors

HP	kW	RPM	Frame	Catalog Number	List Price	Mult. Symbol	Approx. Shipping Weight (lbs)	Service Factor	FL Amps @ High	FL Eff (%)	"C" Dimension (in)	Voltage (V)	Notes
200	150	3600	445/7TS	20036ET3E447TS-W22	\$23,562	N1	2224	1.15	219	95.4	44.951	230/460	
		3600	445/7TS	20036ET3G447TS-W22	\$23,562	N1	2046	1.15	219	95.4	44.951	460	
		3600	504/5S	20036ET3G504S-W22	\$23,562	N1	2373	1.15	222	95.4	48.215	460	
		1800	445/7TS	20018ET3G447TS-W22	\$21,098	N1	2138	1.15	230	96.2	44.951	460	
		1800	445/7T	20018ET3E447T-W22	\$21,098	N1	2349	1.15	230	96.2	48.701	230/460	
		1800	445/7T	20018ET3G447T-W22	\$21,098	N1	2224	1.15	230	96.2	48.701	460	
		1800	445/7T	20018ET3GRB447T-W22	\$21,098	N1	2209	1.15	230	96.2	48.701	460	14
		1800	445/7T	20018ET3H447T-W22	\$21,098	N1	2477	1.15	184	96.2	48.701	575	
		1800	445/7T	20018ET3HRB447T-W22	\$21,098	N1	1850	1.15	184	96.2	48.701	575	14
		1800	504/5	20018ET3G504-W22	\$21,098	N1	2621	1.15	228	96.2	54.095	460	
		1200	445/7T	20012ET3G447T-W22	\$25,133	N1	2406	1.15	237	95.8	48.701	460	
		1200	445/7T	20012ET3GRB447T-W22	\$25,133	N1	2588	1.15	237	95.8	48.701	460	14
		1200	447/9T	20012ET3E449T-W22	\$25,255	N1	2495	1.15	237	95.8	56.338	230/460	
		1200	447/9T	20012ET3G449T-W22	\$25,255	N1	3044	1.15	237	95.8	56.338	460	
		1200	447/9T	20012ET3GRB449T-W22	\$25,255	N1	2940	1.15	237	95.8	56.338	460	14
		1200	447/9T	20012ET3H449T-W22	\$25,255	N1	2933	1.15	190	95.8	56.338	575	
		1200	504/5	20012ET3G505-W22	\$25,133	N1	2467	1.15	237	95.8	54.095	460	
		900	447/9T	20009ET3G449T-W22	\$49,899	N1	3255	1.15	254	95.0	56.338	460	
250	185	3600	445/7TS	25036ET3G447TS-W22	\$29,846	N1	2535	1.15	266	95.8	44.951	460	
		3600	447/9TS	25036ET3G449TS-W22	\$33,173	N1	2730	1.15	266	95.8	52.588	460	
		1800	445/7TS	25018ET3G447TS-W22	\$27,189	N1	2709	1.15	281	96.2	44.951	460	
		1800	445/7TS	25018ET3H447TS-W22	\$27,189	N1	2896	1.15	225	96.2	44.951	575	
		1800	445/7T	25018ET3G447T-W22	\$26,716	N1	2446	1.15	281	96.2	48.701	460	
		1800	445/7T	25018ET3GRB447T-W22	\$26,716	N1	2554	1.15	281	96.2	48.701	460	14
		1800	445/7T	25018ET3HRB447T-W22	\$26,716	N1	2414	1.15	225	96.2	48.701	575	14
		1800	447/9T	25018ET3G449T-W22	\$26,803	N1	2879	1.15	281	96.2	56.338	460	
		1800	447/9T	25018ET3GRB449T-W22	\$26,803	N1	2815	1.15	281	96.2	56.338	460	14
		1200	447/9T	25012ET3E449T-W22	\$35,555	N1	3217	1.15	292	95.8	56.338	230/460	
		1200	447/9T	25012ET3G449T-W22	\$35,555	N1	3090	1.15	292	95.8	56.338	460	
		1200	447/9T	25012ET3GRB449T-W22	\$35,555	N1	3224	1.15	292	95.8	56.338	460	14
		1200	447/9T	25012ET3H449T-W22	\$35,555	N1	3206	1.15	234	95.8	56.338	575	
		1200	586/7	25012ET3G586/7-W22	\$39,631	N1	3769	1.15	299	95.8	61.902	460	43
		900	L447/9T	25009ET3G449T-W22	\$56,168	N1	3590	1.15	308	95.4	57.181	460	43
300	220	3600	447/9TS	30036ET3G449TS-W22	\$38,269	N1	2987	1.15	320	95.8	52.588	460	
		1800	447/9TS	30018ET3G449TS-W22	\$31,384	N1	2894	1.15	330	96.2	52.588	460	44
		1800	447/9T	30018ET3G449T-W22	\$31,384	N1	2888	1.15	330	96.2	56.338	460	
		1800	447/9T	30018ET3GRB449T-W22	\$31,384	N1	2992	1.15	330	96.2	56.338	460	14
		1200	447/9T	30012ET3G449T-W22	\$38,437	N1	3178	1.15	356	95.8	56.338	460	37
		1200	586/7	30012ET3G586/7-W22	\$44,301	N1	4061	1.15	356	95.8	61.902	460	43
		900	L447/9T	30009ET3G449T-W22	\$58,655	N1	3826	1.15	371	95.4	57.181	460	19,43

continued on next page

Please refer to back cover for description of "NOTES"

For detailed specifications, data sheets, drawings and performance curves visit <http://www.weg.net>



TEFC - Foot Mount - *continued*

HP	kW	RPM	Frame	Catalog Number	List Price	Mult. Symbol	Approx. Shipping Weight (lbs)	Service Factor	FL Amps @ High	FL. Eff (%)	"C" Dimension (in)	Voltage (V)	Notes
350	260	3600	447/9TS	35036ET3G449TS-W22	\$43,805	N1	3120	1.15	377	96.2	52.588	460	
		1800	447/9TS	35018ET3G449TS-W22	\$36,517	N1	3123	1.15	394	96.2	52.588	460	44
		1800	447/9T	35018ET3G449T-W22	\$36,517	N1	3168	1.15	394	96.2	56.338	460	
		1800	447/9T	35018ET3GRB449T-W22	\$36,517	N1	2941	1.15	394	96.2	56.338	460	14
		1200	L447/9T	35012ET3G449T-W22	\$47,633	N1	3781	1.15	415	95.8	57.181	460	37,43
		1200	L447/9T	35012ET3GRB449T-W22	\$47,633	N1	3800	1.15	415	95.8	57.181	460	14,19,37,43
		900	586/7	35009ET3G586/7-W22	\$64,873	N1	5028	1.00	426	95.8	61.902	460	1,43
400	300	3600	L447/9TS	40036ET3G449TS-W22	\$44,605	N1	3361	1.15	432	95.8	53.431	460	43
		1800	L447/9TS	40018ET3G449TS-W22	\$43,805	N1	3328	1.15	445	96.2	53.431	460	43
		1800	L447/9T	40018ET3G449T-W22	\$43,805	N1	3416	1.15	445	96.2	57.181	460	43
		1800	L447/9T	40018ET3GRB449T-W22	\$43,805	N1	3404	1.15	445	96.2	57.181	460	14,43
		1800	L447/9T	40018ET3H449T-W22	\$43,805	N1	3400	1.15	356	96.2	57.181	575	43
		1200	L447/9T	40012ET3G449T-W22	\$52,307	N1	3720	1.15	477	95.8	57.181	460	19,37,43
		1200	L447/9T	40012ET3GRB449T-W22	\$52,307	N1	3827	1.15	477	95.8	57.181	460	14,19,37,43
		1200	586/7	40012ET3G586/7-W22	\$56,201	N1	4663	1.15	483	96.2	61.902	460	43
		900	588/9	40009ET3G588/9-W22	\$66,123	N1	3308	1.00	498	95.7	69.381	460	1,43
450	330	3600	L447/9TS	45036ET3G449TS-W22	\$49,610	N1	3537	1.00	475	95.8	53.431	460	1,19,43
		1800	L447/9T	45018ET3G449T-W22	\$48,010	N1	3681	1.15	501	96.2	57.181	460	43
		1800	L447/9T	45018ET3GRB449T-W22	\$48,010	N1	3657	1.15	501	96.2	57.181	460	14,43
		1200	586/7	45012ET3G586/7-W22	\$62,251	N1	4957	1.00	532	96.2	61.902	460	1,43
		1200	586/7	45012ET3GRB586/7-W22	\$62,251	N1	5248	1.00	532	96.2	61.902	460	1,14,43
		900	588/9	45009ET3G588/9-W22	\$68,715	N1	5915	1.00	534	95.8	69.381	460	1,43,44
500	370	3600	586/7S	50036ET3G586/7S-W22	\$56,305	N1	4649	1.15	530	96.2	55.027	460	43,44
		1800	L447/9T	50018ET3G449T-W22	\$50,594	N1	3889	1.00	561	96.2	57.181	460	1,19,43,44
		1800	L447/9T	50018ET3GRB449T-W22	\$50,594	N1	5424	1.00	561	96.2	57.181	460	14,19,43
		1200	586/7	50012ET3G586/7-W22	\$62,962	N1	4916	1.00	603	96.2	61.902	460	1,43,44
600	450	3600	588/9S	60036ET3G588/9S-W22	\$64,635	N1	5142	1.00	650	96.5	62.506	460	1,43,44
		1800	586/7	60018ET3G586/7-W22	\$60,316	N1	4963	1.00	665	96.5	61.902	460	1,43,44
		1200	588/9	60012ET3G588/9-W22	\$71,374	N1	6168	1.00	743	96.2	69.381	460	1,43,44
650	480	3600	588/9S	65036ET3G588/9S-W22	\$66,835	N1	4805	1.00	685	96.6	62.506	460	1,43,44
		1800	588/9	65018ET3G588/9-W22	\$66,701	N1	5597	1.00	734	96.6	69.381	460	1,43,44
700	515	3600	588/9S	70036ET3G588/9S-W22	\$71,254	N1	5680	1.00	736	96.6	62.506	460	1,19,43,44
		1800	588/9	70018ET3G588/9-W22	\$71,185	N1	5940	1.00	788	96.6	69.381	460	1,43,44
750	550	1800	588/9	75018ET3G588/9-W22	\$74,025	N1	5154	1.00	840	96.7	69.381	460	1,43,44

Please refer to back cover for description of "NOTES"

For detailed specifications, data sheets, drawings and performance curves visit <http://www.weg.net>

Data subject to change without notice.

Can't find what you are looking for? Call 1-800-ASK-4WEG (275-4934)

Three-Phase General Purpose Motors

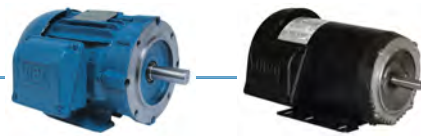

TEFC - C-Face - Foot Mount

Three-Phase
General Purpose
Motors

HP	kW	RPM	Frame	Catalog Number	List Price	Mult. Symbol	Approx. Shipping Weight (lbs)	Service Factor	FL Amps @ High	FL. Eff (%)	"C" Dimension (in)	Voltage (V)	Notes
0.25	0.18	3600	56C	.2536ES3E56C-S	\$258	F1	21	1.15	0.50	57.5	11.142	208-230/460	9
		1800	56C	.2518ES3E56C-S	\$270	F1	23	1.15	0.50	70.0	11.142	208-230/460	9
		1800	56C	.2518ES3H56C-S	\$270	F1	23	1.15	0.40	70.0	11.142	575	9
0.33	0.25	3600	56C	.3336ES3E56C-S	\$270	F1	22	1.15	0.60	62.0	11.142	208-230/460	9
		3600	56C	.3336ES3H56C-S	\$270	F1	22	1.15	0.50	62.0	11.142	575	9
		1800	56C	.3318ES3E56C-S	\$274	F1	24	1.15	0.60	74.0	11.535	208-230/460	9
0.5	0.37	3600	56C	.5036ES3H56C-S	\$281	F1	24	1.15	0.70	68.0	11.535	575	9
		1800	56C	.5018ES3E56C-S	\$311	F1	26	1.15	0.90	77.0	11.535	208-230/460	9
		1800	56C	.5018ES3H56C-S	\$263	F1	26	1.15	0.70	77.0	11.535	575	9
0.75	0.55	1200	56C	.5012ES3E56C-S	\$440	F1	31	1.15	1.00	72.0	12.323	208-230/460	9
		3600	56C	.7536ES3E56C-S	\$311	F1	25	1.15	1.10	72.0	11.535	208-230/460	9
		3600	56C	.7536ES3H56C-S	\$310	F1	25	1.15	0.90	72.0	11.535	575	9
		1800	56C	.7518ES3E56C-S	\$332	F1	28	1.15	1.20	78.5	11.929	208-230/460	9
		1800	56C	.7518ES3H56C-S	\$333	F1	28	1.15	1.00	78.5	11.929	575	9
1	0.75	1200	56HC	.7512ES3E56C-S	\$449	F1	34	1.15	1.30	75.5	12.716	208-230/460	9
		3600	W56C	00136ET3EW56C-S	\$420	F1	25	1.15	1.50	78.5	11.106	230/460	9
		3600	W56C	00136ET3HW56C-S	\$420	F1	25	1.15	1.20	78.5	11.106	575	9
		3600	143/5TC	00136ET3E143TC-W22	\$566	N1	47	1.25	1.44	81.5	13.358	230/460	
		1800	56C	00118ET3E56C-S	\$407	F1	41	1.15	1.50	85.5	13.504	230/460	9
		1800	56C	00118ET3H56C-S	\$407	F1	41	1.15	1.20	85.5	13.504	575	9
		1800	143/5TC	00118ET3E143TC-S	\$484	RSP	42	1.15	1.50	85.5	13.583	230/460	9
		1800	143/5TC	00118ET3H143TC-S	\$484	RSP	42	1.15	1.20	85.5	13.583	575	9
		1800	143/5TC	00118ET3E143TC-W22	\$555	N1	50	1.25	1.47	85.5	13.358	230/460	
		1800	143/5TC	00118ET3H143TC-W22	\$555	N1	50	1.25	1.18	85.5	13.358	575	
		1200	56HC	00112ET3E56C-S	\$525	F1	42	1.15	1.60	82.5	13.504	230/460	9
		1200	143/5TC	00112ET3E145TC-S	\$554	RSP	43	1.15	1.60	82.5	13.583	230/460	9
1.5	1.1	1200	143/5TC	00112ET3E145TC-W22	\$636	N1	57	1.25	1.73	82.5	13.358	230/460	
		3600	56C	00156ET3E56C-S	\$461	F1	37	1.15	1.90	84.0	13.109	230/460	9
		3600	56C	00156ET3H56C-S	\$461	F1	37	1.15	1.50	84.0	13.109	575	9
		3600	143/5TC	00156ET3E143TC-S	\$497	RSP	39	1.15	1.90	84.0	13.189	230/460	9
		3600	143/5TC	00156ET3E143TC-W22	\$571	N1	52	1.25	1.96	84.0	13.358	230/460	
		3600	143/5TC	00156ET3H143TC-W22	\$571	N1	51	1.25	1.57	84.0	13.358	575	
		1800	56HC	00158ET3E56C-S	\$463	F1	44	1.15	2.00	86.5	13.504	230/460	9
		1800	56HC	00158ET3H56C-S	\$463	F1	44	1.15	1.60	86.5	13.504	575	9
		1800	143/5TC	00158ET3E145TC-S	\$504	RSP	43	1.15	2.00	86.5	13.583	230/460	9
		1800	143/5TC	00158ET3H145TC-S	\$504	RSP	43	1.15	1.60	86.5	13.583	575	9
		1800	143/5TC	00158ET3E145TC-W22	\$579	N1	56	1.25	2.02	86.5	13.358	230/460	
		1800	143/5TC	00158ET3H145TC-W22	\$579	N1	56	1.25	1.62	86.5	13.358	575	
1200	182/4TC	00152ET3E182TC-S	\$690	RSP	85	1.15	2.20	87.5	16.339	230/460	9		
1200	182/4TC	00152ET3E182TC-W22	\$792	N1	101	1.25	2.54	87.5	15.860	230/460			

continued on next page

Please refer to back cover for description of "NOTES"

For detailed specifications, data sheets, drawings and performance curves visit <http://www.weg.net>



TEFC - C-Face - Foot Mount - *continued*

HP	kW	RPM	Frame	Catalog Number	List Price	Mult. Symbol	Approx. Shipping Weight (lbs)	Service Factor	FL Amps @ High	FL Eff (%)	"C" Dimension (in)	Voltage (V)	Notes
2	1.5	3600	56HC	00236ET3E56C-S	\$517	F1	44	1.15	2.50	85.5	13.898	230/460	9
		3600	56HC	00236ET3H56C-S	\$517	F1	44	1.15	2.00	85.5	13.898	575	9
		3600	143/5TC	00236ET3H145TC-S	\$539	RSP	45	1.15	2.00	85.5	13.976	575	9
		3600	143/5TC	00236ET3E145TC-W22	\$619	N1	56	1.25	2.56	85.5	13.358	230/460	
		3600	143/5TC	00236ET3H145TC-W22	\$619	N1	56	1.25	2.05	85.5	13.358	575	
		1800	56HC	00218ET3E56C-S	\$506	F1	46	1.15	2.70	86.5	13.898	230/460	9
		1800	143/5TC	00218ET3E145TC-S	\$558	RSP	47	1.15	2.70	86.5	13.976	230/460	9
		1800	143/5TC	00218ET3H145TC-S	\$558	RSP	47	1.15	2.20	86.5	13.976	575	9
		1800	143/5TC	00218ET3E145TC-W22	\$640	N1	53	1.25	2.76	86.5	13.358	230/460	
		1800	143/5TC	00218ET3H145TC-W22	\$640	N1	57	1.25	2.21	86.5	13.358	575	
		1200	182/4TC	00212ET3E184TC-S	\$747	RSP	96	1.15	3.00	88.5	17.126	230/460	9
		1200	182/4TC	00212ET3E184TC-W22	\$857	N1	112	1.25	3.22	88.5	15.860	230/460	39
3	2.2	3600	56HC	00336ET3E56C-S	\$606	F1	54	1.15	3.50	86.5	15.079	230/460	9
		3600	56HC	00336ET3H56C-S	\$606	F1	54	1.15	2.80	86.5	15.079	575	9
		3600	143/5TC	00336ET3E145TC-S	\$674	RSP	54	1.15	3.50	86.5	15.157	230/460	9
		3600	182/4TC	00336ET3E182TC-S	\$698	RSP	73	1.15	3.70	86.5	16.339	230/460	9
		3600	182/4TC	00336ET3H182TC-S	\$698	RSP	73	1.15	3.00	86.5	16.339	575	9
		3600	182/4TC	00336ET3E182TC-W22	\$802	N1	103	1.25	3.63	86.5	15.860	230/460	
		3600	182/4TC	00336ET3H182TC-W22	\$802	N1	103	1.25	2.90	86.5	15.860	575	
		1800	182/4TC	00318ET3E182TC-S	\$610	RSP	100	1.15	3.80	89.5	17.913	230/460	9
		1800	182/4TC	00318ET3H182TC-S	\$610	RSP	100	1.15	3.00	89.5	17.913	575	9
		1800	182/4TC	00318ET3E182TC-W22	\$700	N1	96	1.25	3.91	89.5	15.860	230/460	
		1800	182/4TC	00318ET3H182TC-W22	\$700	N1	98	1.25	3.13	89.5	15.860	575	
		1200	213/5TC	00312ET3E213TC-W22	\$1,180	N1	166	1.25	4.41	89.5	19.517	230/460	
900	213/5TC	00309ET3E215TC-W22	\$2,166	N1	192	1.25	4.55	85.5	19.517	230/460			
5	3.7	3600	182/4TC	00536ET3H184TC-S	\$793	RSP	98	1.15	4.70	88.5	17.913	575	9
		3600	182/4TC	00536ET3E184TC-W22	\$911	N1	110	1.25	5.90	88.5	15.860	230/460	
		3600	182/4TC	00536ET3H184TC-W22	\$911	N1	109	1.25	4.72	88.5	15.860	575	
		1800	182/4TC	00518ET3E184TC-S	\$706	RSP	81	1.15	6.50	89.5	17.913	230/460	9
		1800	182/4TC	00518ET3H184TC-S	\$706	RSP	93	1.15	5.20	89.5	17.913	575	9
		1800	182/4TC	00518ET3E184TC-W22	\$810	N1	107	1.25	6.45	89.5	15.860	230/460	
		1800	182/4TC	00518ET3H184TC-W22	\$810	N1	108	1.25	5.16	89.5	15.860	575	
		1200	213/5TC	00512ET3E215TC-W22	\$1,384	N1	183	1.25	6.83	89.5	19.517	230/460	
7.5	5.5	3600	182/4TC	00736ET3E184TC-S	\$985	RSP	101	1.15	8.60	89.5	17.126	230/460	9
		3600	213/5TC	00736ET3H213TC-S	\$1,025	RSP	153	1.15	7.00	89.5	20.079	575	9
		3600	182/4TC	00736ET3E184TC-W22	\$1,112	N1	110	1.25	8.76	89.5	15.860	230/460	
		3600	182/4TC	00736ET3H184TC-W22	\$1,112	N1	109	1.25	7.01	89.5	15.860	575	
		3600	213/5TC	00736ET3E213TC-W22	\$1,177	N1	166	1.25	8.76	89.5	19.517	230/460	
		3600	213/5TC	00736ET3H213TC-W22	\$1,177	N1	166	1.25	7.01	89.5	19.517	575	
		1800	213/5TC	00718ET3E213TC-W22	\$1,141	N1	174	1.25	9.18	91.7	19.517	230/460	
		1800	213/5TC	00718ET3H213TC-W22	\$1,141	N1	178	1.25	7.34	91.7	19.517	575	
		1200	254/6TC	00712ET3E254TC-W22	\$2,134	N1	321	1.25	9.48	91.0	24.945	230/460	
900	254/6TC	00709ET3E256TC-W22	\$3,726	N1	341	1.25	11.1	87.5	24.945	230/460			

continued on next page

Please refer to back cover for description of "NOTES"

For detailed specifications, data sheets, drawings and performance curves visit <http://www.weg.net>

Data subject to change without notice.

Can't find what you are looking for? Call 1-800-ASK-4WEG (275-4934)

TEFC - C-Face - Foot Mount - *continued*

 Three-Phase
General Purpose
Motors

HP	kW	RPM	Frame	Catalog Number	List Price	Mult. Symbol	Approx. Shipping Weight (lbs)	Service Factor	FL Amps @ High	FL Eff (%)	"C" Dimension (in)	Voltage (V)	Notes
10	7.5	3600	213/5TC	01036ET3H215TC-S	\$1,205	RSP	178	1.15	9.20	90.2	21.654	575	9
		3600	213/5TC	01036ET3E215TC-S	\$1,205	RSP	178	1.15	11.5	90.2	21.654	230/460 V	9
		3600	213/5TC	01036ET3E215TC-W22	\$1,383	N1	178	1.25	11.6	90.2	19.517	230/460	
		3600	213/5TC	01036ET3H215TC-W22	\$1,383	N1	183	1.25	9.28	90.2	19.517	575	
		1800	213/5TC	01018ET3E215TC-S	\$1,354	RSP	151	1.15	12.2	91.7	19.291	230/460	9
		1800	213/5TC	01018ET3H215TC-S	\$1,154	RSP	151	1.15	9.80	91.7	19.291	575	9
		1800	213/5TC	01018ET3E215TC-W22	\$1,325	N1	183	1.25	12.4	91.7	19.517	230/460	
		1800	213/5TC	01018ET3H215TC-W22	\$1,325	N1	191	1.25	9.92	91.7	19.517	575	
		1200	254/6TC	01012ET3E256TC-W22	\$2,465	N1	329	1.25	12.9	91.0	24.945	230/460	
15	11	3600	213/5TC	01536ET3E215TC-W22	\$1,748	N1	187	1.25	17.0	91.0	19.517	230/460	
		3600	254/6TC	01536ET3H254TC-S	\$1,649	RSP	216	1.15	13.9	91.0	22.559	575	9
		3600	254/6TC	01536ET3E254TC-W22	\$1,893	N1	295	1.25	17.2	91.0	24.945	230/460	
		3600	254/6TC	01536ET3H254TC-W22	\$1,893	N1	302	1.25	13.8	91.0	24.945	575	
		1800	254/6TC	01518ET3H254TC-S	\$1,670	RSP	248	1.15	14.6	92.4	22.559	575	9
		1800	254/6TC	01518ET3E254TC-W22	\$1,917	N1	340	1.25	18.0	92.4	24.945	230/460	
		1800	254/6TC	01518ET3H254TC-W22	\$1,917	N1	351	1.25	14.4	92.4	24.945	575	
		1200	284/6TC	01512ET3E284TC-W22	\$3,388	N1	430	1.25	17.9	91.7	27.929	230/460	
		1200	284/6TC	01512ET3H284TC-W22	\$3,388	N1	428	1.25	14.3	91.7	27.929	575	
20	15	3600	254/6TC	02036ET3H256TC-S	\$2,136	RSP	256	1.15	18.2	91.0	23.346	575	9
		3600	254/6TC	02036ET3E256TC-W22	\$2,451	N1	318	1.25	23.2	91.0	24.945	230/460	
		3600	254/6TC	02036ET3H256TC-W22	\$2,451	N1	327	1.25	18.6	91.0	24.945	575	
		1800	254/6TC	02018ET3H256TC-S	\$1,978	RSP	279	1.15	19.8	93.0	23.346	575	9
		1800	254/6TC	02018ET3E256TC-W22	\$2,270	N1	389	1.25	24.1	93.0	24.945	230/460	
		1800	254/6TC	02018ET3H256TC-W22	\$2,270	N1	401	1.25	19.3	93.0	24.945	575	
		1200	284/6TC	02012ET3E286TC-W22	\$4,060	N1	457	1.25	24.2	91.7	27.929	230/460	
25	18.5	3600	284/6TSC	02536ET3E284TSC-W22	\$3,096	N1	416	1.25	28.5	91.7	26.557	230/460	
		3600	284/6TSC	02536ET3H284TSC-W22	\$3,096	N1	413	1.25	22.8	91.7	26.557	575	
		1800	284/6TC	02518ET3E284TC-W22	\$2,840	N1	418	1.25	29.5	93.6	27.929	230/460	
		1800	284/6TC	02518ET3H284TC-W22	\$2,840	N1	447	1.25	23.6	93.6	27.929	575	
		1200	324/6TC	02512ET3E324TC-W22	\$4,858	N1	601	1.25	30.4	93.0	31.116	230/460	
30	22	3600	284/6TSC	03036ET3E286TSC-W22	\$3,659	N1	433	1.25	33.8	91.7	26.557	230/460	
		3600	284/6TSC	03036ET3H286TSC-W22	\$3,659	N1	433	1.25	27.0	91.7	26.557	575	
		1800	284/6TC	03018ET3E286TC-W22	\$3,321	N1	466	1.25	35.1	93.6	27.929	230/460	
		1800	284/6TC	03018ET3H286TC-W22	\$3,321	N1	484	1.25	28.1	93.6	27.929	575	
		1200	324/6TC	03012ET3E326TC-W22	\$5,394	N1	645	1.25	36.2	93.0	31.116	230/460	
40	30	3600	324/6TSC	04036ET3E324TSC-W22	\$4,845	N1	606	1.25	45.8	92.4	29.616	230/460	
		3600	324/6TSC	04036ET3H324TSC-W22	\$4,845	N1	605	1.25	36.6	92.4	29.616	575	
		1800	324/6TSC	04018ET3E324TSC-W22	\$4,300	N1	629	1.25	47.1	94.1	29.616	230/460	
		1800	324/6TC	04018ET3E324TC-W22	\$4,300	N1	606	1.25	47.1	94.1	31.116	230/460	
		1800	324/6TC	04018ET3H324TC-W22	\$4,300	N1	630	1.25	37.7	94.1	31.116	575	
		1200	364/5TC	04012ET3E364TC-W22	\$7,576	N1	1032	1.25	46.5	94.1	34.251	230/460	
50	37	3600	324/6TSC	05036ET3E326TSC-W22	\$5,437	N1	628	1.25	56.1	93.0	29.616	230/460	
		1800	324/6TSC	05018ET3E326TSC-W22	\$5,221	N1	614	1.25	59.2	94.5	29.616	230/460	
		1800	324/6TC	05018ET3E326TC-W22	\$5,221	N1	625	1.25	59.2	94.5	31.116	230/460	
		1800	324/6TC	05018ET3H326TC-W22	\$5,221	N1	651	1.25	47.4	94.5	31.116	575	
		1200	364/5TC	05012ET3E365TC-W22	\$8,960	N1	1048	1.25	57.4	94.1	34.251	230/460	

Please refer to back cover for description of "NOTES"

 For detailed specifications, data sheets, drawings and performance curves visit <http://www.weg.net>



TEFC - C-Face - Foot Mount - *continued*

HP	kW	RPM	Frame	Catalog Number	List Price	Mult. Symbol	Approx. Shipping Weight (lbs)	Service Factor	FL Amps @ High	FL. Eff (%)	"C" Dimension (in)	Voltage (V)	Notes
60	45	3600	364/5TSC	06036ET3E364TSC-W22	\$7,994	N1	990	1.25	67.0	93.6	32.338	230/460	
		3600	364/5TSC	06036ET3H364TSC-W22	\$7,994	N1	992	1.25	53.6	93.6	32.338	575	
		1800	364/5TC	06018ET3E364TC-W22	\$7,831	N1	961	1.25	68.3	95.0	34.251	230/460	
		1800	364/5TC	06018ET3H364TC-W22	\$7,831	N1	1060	1.25	54.6	95.0	34.251	575	
75	55	3600	364/5TSC	07536ET3E365TSC-W22	\$9,533	N1	993	1.25	81.9	93.6	32.338	230/460	
		1800	364/5TC	07518ET3E365TC-W22	\$9,148	N1	1024	1.25	84.1	95.4	34.251	230/460	
		1800	364/5TC	07518ET3H365TC-W22	\$9,148	N1	1075	1.25	67.3	95.4	34.251	575	
		1200	404/5TC	07512ET3H405TC-W22	\$12,549	N1	1337	1.25	67.9	94.5	39.730	575	
100	75	1800	404/5TSC	10018ET3E405TSC-W22	\$12,179	N1	1256	1.25	111	95.4	36.732	230/460	
		1800	404/5TC	10018ET3E405TC-W22	\$12,179	N1	1256	1.25	111	95.4	39.730	230/460	
		1800	404/5TC	10018ET3H405TC-W22	\$12,179	N1	1318	1.25	88.8	95.4	39.730	575	
125	90	1800	444/5TSC	12518ET3G444TSC-W22	\$16,218	N1	1759	1.15	139	95.4	41.407	460	
		1800	444/5TC	12518ET3E444TC-W22	\$16,218	N1	1887	1.15	139	95.4	45.157	230/460	
		1800	444/5TC	12518ET3G444TC-W22	\$16,218	N1	1851	1.15	139	95.4	45.157	460	
		1800	444/5TC	12518ET3H444TC-W22	\$16,218	N1	1851	1.15	111	95.4	45.157	575	
150	110	1800	444/5TC	15018ET3E445TC-W22	\$18,025	N1	1919	1.15	170	95.8	45.157	230/460	
		1800	444/5TC	15018ET3G445TC-W22	\$18,025	N1	1997	1.15	170	95.8	45.157	460	
200	150	1800	445/7TC	20018ET3G447TC-W22	\$21,704	N1	2523	1.15	230	96.2	48.701	460	
250	185	1800	445/7TSC	25018ET3G447TSC-W22	\$27,795	N1	2361	1.15	281	96.2	44.951	460	
300	220	1800	447/9TC	30018ET3G449TC-W22	\$31,990	N1	3069	1.15	330	96.2	56.338	460	

Please refer to back cover for description of "NOTES"

For detailed specifications, data sheets, drawings and performance curves visit <http://www.weg.net>

Data subject to change without notice.

Can't find what you are looking for? Call 1-800-ASK-4WEG (275-4934)



TEFC - C-Face - Footless

Three-Phase
General Purpose
Motors

HP	kW	RPM	Frame	Catalog Number	List Price	Mult. Symbol	Approx. Shipping Weight (lbs)	Service Factor	FL Amps @ High	FL Eff (%)	"C" Dimension (in)	Voltage (V)	Notes
0.33	0.25	3600	56C	.3336ES3E56CFL-S	\$270	F1	22	1.15	0.60	62.0	11.142	208-230/460	9,20
		3600	56C	.3336ES3H56CFL-S	\$270	F1	22	1.15	0.50	62.0	11.142	575	9,20
		1800	56C	.3318ES3E56CFL-S	\$274	F1	24	1.15	0.60	74.0	11.535	208-230/460	9,20
0.5	0.37	1800	56C	.5018ES3E56CFL-S	\$311	F1	26	1.15	0.90	77.0	11.535	208-230/460	9,20
		1800	56C	.5018ES3H56CFL-S	\$281	F1	26	1.15	0.70	77.0	11.535	575	9,20
0.75	0.55	3600	56C	.7536ES3E56CFL-S	\$311	F1	25	1.15	1.10	72.0	11.535	208-230/460	9,20
		3600	56C	.7536ES3H56CFL-S	\$310	F1	25	1.15	0.90	72.0	11.535	575	9,20
		1800	56C	.7518ES3E56CFL-S	\$332	F1	28	1.15	1.20	78.5	11.929	208-230/460	9,20
		1800	56C	.7518ES3H56CFL-S	\$333	F1	28	1.15	1.00	78.5	11.929	575	9,20
		1200	56C	.7512ES3E56CFL-S	\$449	F1	34	1.15	1.30	75.5	12.716	208-230/460	9,20
		1200	56C	.7512ES3H56CFL-S	\$448	F1	34	1.15	1.10	75.5	12.716	575	9,20
1	0.75	3600	W56C	00136ET3EW56CFL-S	\$420	F1	25	1.15	1.50	78.5	11.106	230/460	9,20
		3600	143TC	00136ET3ER143TC-W22	\$577	N1	44	1.25	1.44	81.5	13.065	230/460	15
		1800	56C	00118ET3E56CFL-S	\$407	F1	41	1.15	1.50	85.5	13.504	230/460	9,20
		1800	56C	00118ET3H56CFL-S	\$407	F1	41	1.15	1.20	85.5	13.504	575	9,20
		1800	143/5TC	00118ET3ER143TC-S	\$484	RSP	42	1.15	1.50	85.5	13.583	230/460	9,15
		1800	143TC	00118ET3ER143TC-W22	\$572	N1	47	1.25	1.47	85.5	13.065	230/460	15
		1200	56C	00112ET3E56CFL-S	\$528	F1	42	1.15	1.60	82.5	13.504	230/460	9,20
		1200	56C	00112ET3H56CFL-S	\$528	F1	42	1.15	1.30	82.5	13.504	575	9,20
		1200	143/5TC	00112ET3ER145TC-S	\$554	RSP	43	1.15	1.60	82.5	13.583	230/460	9,15
1.5	1.1	1200	145TC	00112ET3ER145TC-W22	\$655	N1	56	1.25	1.73	82.5	16.197	230/460	15
		3600	56C	00156ET3E56CFL-S	\$461	F1	37	1.15	1.90	84.0	13.109	230/460	9,20
		3600	143/5TC	00156ET3ER143TC-S	\$497	RSP	39	1.15	1.90	84.0	13.189	230/460	9,15
		3600	143TC	00156ET3ER143TC-W22	\$588	N1	48	1.25	1.96	84.0	13.065	230/460	15
		1800	56C	00158ET3E56CFL-S	\$463	F1	44	1.15	2.00	86.5	13.504	230/460	9,20
		1800	143/5TC	00158ET3ER145TC-S	\$504	RSP	43	1.15	2.00	86.5	13.583	230/460	9,15
		1800	145TC	00158ET3ER145TC-W22	\$596	N1	55	1.25	2.02	86.5	14.077	230/460	15
		1200	182/4TC	00152ET3ER182TC-S	\$690	RSP	90	1.15	2.20	87.5	16.339	230/460	9,15
1200	182TC	00152ET3ER182TC-W22	\$816	N1	100	1.25	2.54	87.5	16.197	230/460	15,39		
2	1.5	3600	56C	00236ET3E56CFL-S	\$517	F1	44	1.15	2.50	85.5	13.898	230/460	9,20
		3600	143/5TC	00236ET3ER145TC-S	\$539	RSP	45	1.15	2.50	85.5	13.976	230/460	9,15
		3600	145TC	00236ET3ER145TC-W22	\$638	N1	55	1.25	2.56	85.5	14.077	230/460	15
		1800	56C	00218ET3E56CFL-S	\$506	F1	46	1.15	2.70	86.5	13.898	230/460	9,20
		1800	143/5TC	00218ET3ER145TC-S	\$558	RSP	47	1.15	2.70	86.5	13.976	230/460	9,15
		1800	145TC	00218ET3ER145TC-W22	\$659	N1	56	1.25	2.76	86.5	14.077	230/460	15
		1200	182/4TC	00212ET3ER184TC-S	\$747	RSP	98	1.15	3.00	88.5	17.126	230/460	9,15
		1200	184TC	00212ET3ER184TC-W22	\$883	N1	110	1.25	3.22	88.5	17.197	230/460	15,39

continued on next page

Refer to electrical and mechanical data sections for additional technical information. Please refer to back cover for description of "NOTES"

For detailed specifications, data sheets, drawings and performance curves visit <http://www.weg.net>



TEFC - C-Face - Footless - continued

HP	kW	RPM	Frame	Catalog Number	List Price	Mult. Symbol	Approx. Shipping Weight (lbs)	Service Factor	FL Amps @ High	FL Eff (%)	"C" Dimension (in)	Voltage (V)	Notes
3	2.2	3600	56C	00336ET3E56CFL-S	\$606	F1	54	1.15	3.50	86.5	15.079	230/460	9,20
		3600	56C	00336ET3H56CFL-S	\$606	F1	54	1.15	2.80	86.5	15.079	575	9,20
		3600	145TC	00336ET3ER145TC-W22	\$677	N1	58	1.25	3.71	86.5	14.077	230/460	15
		3600	182/4TC	00336ET3ER182TC-S	\$698	RSP	73	1.15	3.70	86.5	16.339	230/460	9,15
		3600	182TC	00336ET3ER182TC-W22	\$826	N1	108	1.25	3.63	86.5	16.197	230/460	15,39
		1800	182/4TC	00318ET3ER182TC-S	\$610	RSP	100	1.15	3.80	89.5	17.913	230/460	9,15
		1800	182TC	00318ET3ER182TC-W22	\$721	N1	104	1.25	3.91	89.5	16.197	230/460	15,39
		1200	213/5TC	00312ET3ER213TC-S	\$1,028	RSP	148	1.15	4.20	89.5	19.291	230/460	9,15
		1200	213TC	00312ET3ER213TC-W22	\$1,203	N1	154	1.25	4.41	89.5	19.399	230/460	15
5	3.7	3600	182/4TC	00536ET3ER184TC-S	\$793	RSP	98	1.15	5.90	88.5	17.913	230/460	9,15
		3600	184TC	00536ET3ER184TC-W22	\$938	N1	115	1.25	5.90	88.5	17.197	230/460	15
		1800	182/4TC	00518ET3ER184TC-S	\$706	RSP	93	1.15	6.50	89.5	17.913	230/460	9,15
		1800	184TC	00518ET3ER184TC-W22	\$834	N1	113	1.25	6.45	89.5	17.197	230/460	15
		1200	213/5TC	00512ET3ER215TC-S	\$1,206	RSP	162	1.15	6.70	89.5	20.079	230/460	9,15
		1200	215TC	00512ET3ER215TC-W22	\$1,426	N1	178	1.25	6.83	89.5	20.895	230/460	15
7.5	5.5	3600	213/5TC	00736ET3ER213TC-S	\$1,025	RSP	153	1.15	8.70	89.5	20.079	230/460	9,15
		3600	213TC	00736ET3ER213TC-W22	\$1,212	N1	155	1.25	8.76	89.5	19.399	230/460	15
		1800	213/5TC	00718ET3ER213TC-S	\$994	RSP	140	1.15	9.10	91.7	18.898	230/460	9,15
		1800	213TC	00718ET3ER213TC-W22	\$1,175	N1	167	1.25	9.18	91.7	19.399	230/460	15
		1200	254/6TC	00712ET3ER254TC-S	\$1,859	RSP	257	1.15	10.0	91.0	22.559	230/460	9,15
10	7.5	3600	213/5TC	01036ET3ER215TC-S	\$1,205	RSP	178	1.15	11.5	90.2	21.654	230/460	9,15
		3600	215TC	01036ET3ER215TC-W22	\$1,424	N1	179	1.25	11.6	90.2	20.895	230/460	15
		1800	213/5TC	01018ET3ER215TC-S	\$1,154	RSP	151	1.15	12.2	91.7	19.291	230/460	9,15
		1800	215TC	01018ET3ER215TC-W22	\$1,366	N1	187	1.25	12.4	91.7	20.895	230/460	15
		1800	213/5TC	01018ET3HR215TC-S	\$1,154	RSP	151	1.15	9.80	91.7	19.291	575	9,15
		1200	254/6TC	01012ET3ER256TC-S	\$2,148	RSP	286	1.15	13.8	91.0	23.346	230/460	9,15
15	11	3600	254/6TC	01536ET3ER254TC-S	\$1,649	RSP	216	1.15	17.4	91.0	22.559	230/460	9,15
		3600	254TC	01536ET3ER254TC-W22	\$1,950	N1	300	1.25	17.2	91.0	25.063	230/460	15
		1800	254/6TC	01518ET3ER254TC-S	\$1,670	RSP	248	1.15	18.2	92.4	22.559	230/460	9,15
		1800	254TC	01518ET3ER254TC-W22	\$1,975	N1	348	1.25	18.0	92.4	25.063	230/460	15
		1800	254/6TC	01518ET3HR254TC-S	\$1,670	RSP	248	1.15	14.6	92.4	22.559	575	9,15
20	15	3600	254/6TC	02036ET3ER256TC-S	\$2,136	RSP	256	1.15	22.7	91.0	23.346	230/460	9,15
		3600	256TC	02036ET3ER256TC-W22	\$2,525	N1	335	1.25	23.2	91.0	26.795	230/460	15
		1800	254/6TC	02018ET3ER256TC-S	\$1,978	RSP	279	1.15	24.7	93.0	23.346	230/460	9,15
		1800	256TC	02018ET3ER256TC-W22	\$2,338	N1	407	1.25	24.1	93.0	26.795	230/460	15
25	18.5	3600	284TSC	02536ET3ER284TSC-W22	\$3,187	N1	406	1.25	28.5	91.7	27.305	230/460	15
		1800	284TC	02518ET3ER284TC-W22	\$2,925	N1	441	1.25	29.5	93.6	28.677	230/460	15
30	22	3600	286TSC	03036ET3ER286TSC-W22	\$3,767	N1	436	1.25	33.8	91.7	28.801	230/460	15
		1800	286TC	03018ET3ER286TC-W22	\$3,421	N1	489	1.25	35.1	93.6	30.173	230/460	15
		1200	326TSC	03012ET3ER326TSC-W22	\$5,768	N1	732	1.25	36.2	93.0	32.254	230/460	15
40	30	3600	324TSC	04036ET3ER324TSC-W22	\$4,988	N1	684	1.25	45.8	92.4	30.758	230/460	15
		1800	324TC	04018ET3ER324TC-W22	\$4,429	N1	613	1.25	47.1	94.1	32.258	230/460	15
50	37	1800	326TC	05018ET3ER326TC-W22	\$5,378	N1	648	1.25	59.2	94.5	33.754	230/460	15
60	45	1800	364/5TC	06018ET3ER364TC-W22	\$8,053	N1	869	1.25	68.3	95.0	37.440	230/460	15
75	55	1800	364/5TC	07518ET3ER365TC-W22	\$9,408	N1	1256	1.25	84.1	95.4	37.440	230/460	15

Refer to electrical and mechanical data sections for additional technical information. Please refer to back cover for description of "NOTES"

For detailed specifications, data sheets, drawings and performance curves visit <http://www.weg.net>

Data subject to change without notice.

Can't find what you are looking for? Call 1-800-ASK-4WEG (275-4934)

Three-Phase General Purpose Motors

W40 - ODP CAST IRON

WEG Open Drip Proof (ODP) motor is a general purpose line designed for environments where dirt and moisture are minimal. The ODP cast iron frame is designed to provide maximum ventilation and heat dissipation, offering low vibration levels, high mechanical stiffness and durability. Widely used in applications such as compressors, pumps and chillers, the ODP motor line meets or exceeds the efficiency levels determined by International Standards and the minimum efficiency level programs in force worldwide.

Standard Features

- Rated output: NEMA (60 Hz) - 15 to 2,500 HP
- Number of poles: 2 through 6
- Frame sizes NEMA 254T to L6808/09
- Frequency: 50 or 60 Hz
- Voltage: 208 to 4,160 V
- Degree of protection ODP (IP23) for frames 256T to L5810 WPI (IP24) for frame size L6808/09
- Efficiency levels: NEMA Premium® Efficiency (60Hz)
- Color: RAL 5009
- Solid Mounting Feet
- Cooling method: IC-01 according to DIN EN 60034-6
- Mounting: F-1
- Frame, end-shields and terminal box material: FC 200 cast iron
- Flying leads for motor connection
- PT100 3 wires - one per phase for frame size 5010/11 up to L6808/09 - Voltage 1.2kV and above

Optional Features

- Voltage: 5,000 to 6,600 V
- Accessories terminal box (standard for medium and high voltage motors)
- Thermal protections: Thermostats or RTD's (Pt-100) on windings or bearings
- Space heaters
- Cable glands
- Roller bearings
- Rodent Screens



Features that make a difference:

- Nameplated 50 Hz at reduced HP IE3 Efficiency and CE Mark
- Class F insulation (Impregnation Resin and Magnet wire are class H)
- Class B Rise at 1.15 Service Factor
- F1 Mounted (Cast Iron Frame motors are F2 convertible)
- Stainless Steel Nameplate - Laser etched with high contrast background (Cast Iron Frames only)
- Cast Iron Frames: Regreasable ball bearings (Frames 254T and up)

Inverter Rated:

1000:1 for variable torque
2:1 for constant torque

ADDITIONAL TECHNICAL DATA

ELECTRICAL DATA: B17

MECHANICAL DATA: B-78



Three-Phase General Purpose Motors

ODP ROLLED STEEL

Standard Features:

- Rated Output: 0.25 to 25 HP
- Number of Poles: 2 through 6
- Class F insulation
- Frame Sizes: NEMA 56 to 254/6T
- Efficiency levels: NEMA Premium®
- Frequency: 60 Hz (dual rated 50 Hz 190-220/380-415V)
- IP21 standard
- F1 mount as standard
- Foot mount / C-face / Footless availability
- Enclosure: ODP
- Aluminum endshields
- Cast Iron flanges for improved strength (182/4TC and larger)
- Internal bolts, giving a clean surface to the motor, avoiding trapping materials and allowing easy paint job after assembly to the load if required
- Double shielded ball bearings on frames 56 to 213/5T. Optional double sealed ball bearings and/or bearing cap
- Versions: General Purpose, Jet Pump, Close-coupled Pump type “JM” and “JP” and Compressor Duty

Optional Features:

- F2 and Build Option F3 mount
- Build Option Enclosure: ODP AO
- Regreasable bearings optional on 182/4T and 213/5T
- Double sealed ball bearings and/or bearing cap
- Drip cover
- Internal AEGIS® SGR
- Space heaters and thermal protection (thermostats or thermistors)
- Refer to the mod section for more options



Three-Phase
General Purpose
Motors

Features that make a difference:

- New ventilation system for improved thermal performance
- Robust feet design suitable for tougher applications
- New and more robust eyebolts design (frames 182/4T and up) plus a second eyebolt on non-drive end allowing vertical lifting capability (frames 213/5T and 254/6T)
- Oversized diagonally split aluminum terminal box that exceeds IP55 requirements
- Terminal box rotatable in 90 degree increments for flexibility during installation
- Option for internal AEGIS® SGR
- Color coded leads as standard for easy wiring
- Regreasable ball bearings on 254/6T frame as standard (optional for 182/4T and 213/5T)
- Bearing cap as standard on flanged motors, optional on non flanged
- Suitable for VFD operation as per NEMA MG1 part 31.4.4.2
- Motor frame painting system 500 hours salt spray resistant

ADDITIONAL TECHNICAL DATA

ELECTRICAL DATA: B-16

MECHANICAL DATA: B-77



Three-Phase General Purpose Motors



ODP Foot Mount

Three-Phase General Purpose Motors

HP	kW	RPM	Frame	Catalog Number	List Price	Mult. Symbol	Approx. Shipping Weight (lbs)	Service Factor	FL Amps @ High	FL. Eff (%)	C Dimension (in)	Voltage (V)	Notes
0.25	0.18	3600	56	.25360T3E56-S	\$231	F2B	19	1.35	0.46	65.6	10.315	230/460	9
		1800	48	.25180T3E48-S	\$235	F2B	18	1.35	0.48	70.0	9.492	230/460	9
		1800	56	.25180T3E56-S	\$235	F2B	19	1.35	0.53	69.5	9.921	230/460	9
		1200	56	.25120T3E56-S	\$288	F2B	21	1.35	0.55	67.5	10.315	230/460	9
0.33	0.25	3600	56	.33360T3E56-S	\$242	F2B	19	1.35	0.61	69.5	10.315	230/460	9
		1800	56	.33180T3E56-S	\$256	F2B	20	1.35	0.67	73.4	10.315	230/460	9
		1800	56	.33180T3H56-S	\$269	F2B	20	1.35	0.54	73.4	10.315	575	9
		1200	56	.33120T3E56-S	\$333	F2B	22	1.35	0.70	71.4	10.315	230/460	9
0.5	0.37	3600	56	.50360T3E56-S	\$258	F2B	20	1.25	0.81	73.4	10.315	230/460	9
		1800	56	.50180T3E56-S	\$296	F2B	24	1.25	0.86	78.2	10.709	230/460	9
		1800	56	.50180T3H56-S	\$311	F2B	24	1.25	0.69	78.2	10.709	575	9
		1200	56	.50120T3E56-S	\$349	F2B	25	1.25	0.93	75.3	10.709	230/460	9
0.75	0.55	3600	56	.75360T3E56-S	\$305	F2B	22	1.25	1.14	76.8	10.709	230/460	9
		1800	56	.75180T3E56-S	\$330	F2B	27	1.25	1.15	81.1	11.102	230/460	9
		1800	56	.75180T3H56-S	\$347	F2B	27	1.25	0.92	81.1	11.102	575	9
		1200	56H	.75120T3E56-S	\$384	F2B	38	1.15	1.26	81.7	12.677	230/460	9
1	0.75	3600	56	001360T3E56-S	\$355	F2B	23	1.25	1.51	77.0	10.709	230/460	9
		3600	143/5T	001360T3E143T-S	\$385	N1S	29	1.15	1.40	80.0	11.181	230/460	9
		1800	56	001180T3E56-S	\$350	F2B	30	1.15	1.57	83.5	11.495	230/460	9
		1800	143/5T	001180T3E143T-S	\$390	N1S	38	1.15	1.50	85.5	11.181	230/460	9
		1800	143/5T	001180T3H143T-S	\$390	N1S	38	1.15	1.20	85.5	11.181	575	9
		1800	143/5T	001180T3P143T-S	\$390	N1S	38	1.15	3.50	85.5	11.181	200	9
		1200	56H	001120T3E56-S	\$458	F2B	42	1.15	1.68	82.5	13.070	230/460	9
		1200	143/5T	001120T3E145T-S	\$446	N1S	38	1.15	1.70	82.5	11.181	230/460	9
1.5	1.1	3600	56	001560T3E56-S	\$380	F2B	30	1.15	1.85	84.0	11.889	230/460	9
		3600	143/5T	001560T3E143T-S	\$442	N1S	33	1.15	1.90	84.0	11.181	230/460	9
		3600	143/5T	001560T3H143T-S	\$442	N1S	33	1.15	1.50	84.0	11.181	575	9
		1800	56H	001580T3E56-S	\$361	F2B	40	1.15	2.10	86.5	12.677	230/460	9
		1800	143/5T	001580T3E145T-S	\$449	N1S	45	1.15	2.10	86.5	12.362	230/460	9
		1800	143/5T	001580T3H145T-S	\$449	N1S	45	1.15	1.70	86.5	12.362	575	9
		1800	143/5T	001580T3P145T-S	\$449	N1S	45	1.15	4.80	86.5	12.362	200	9
		1200	182/4T	001520T3E182T-S	\$588	N1S	63	1.15	2.30	86.5	13.976	230/460	9
2	1.5	3600	56H	002360T3E56-S	\$436	F2B	38	1.15	2.42	85.5	12.677	230/460	9
		3600	143/5T	002360T3E145T-S	\$487	N1S	40	1.15	2.40	85.5	11.969	230/460	9
		3600	143/5T	002360T3H145T-S	\$487	N1S	40	1.15	1.90	85.5	11.969	575	9
		1800	56H	002180T3E56-S	\$371	F2B	40	1.15	2.69	86.5	12.677	230/460	9
		1800	143/5T	002180T3E145T-S	\$492	N1S	43	1.15	2.70	86.5	12.362	230/460	9
		1800	143/5T	002180T3H145T-S	\$492	N1S	43	1.15	2.20	86.5	12.362	575	9
		1800	143/5T	002180T3P145T-S	\$492	N1S	43	1.15	6.20	86.5	12.362	200	9
		1200	182/4T	002120T3E184T-S	\$597	N1S	73	1.15	3.00	87.5	14.764	230/460	9
		1200	182/4T	002120T3H184T-S	\$597	N1S	73	1.15	2.40	87.5	14.764	575	9

continued on next page

Please refer to back cover for description of "NOTES"

For detailed specifications, data sheets, drawings and performance curves visit <http://www.weg.net>



ODP Foot Mount - continued

Three-Phase
General Purpose
Motors

HP	kW	RPM	Frame	Catalog Number	List Price	Mult. Symbol	Approx. Shipping Weight (lbs)	Service Factor	FL Amps @ High	FL. Eff (%)	C Dimension (in)	Voltage (V)	Notes
3	2.2	3600	56H	003360T3E56-S	\$485	F2B	42	1.15	3.59	85.5	13.070	230/460	9
		3600	143/5T	003360T3E145T-S	\$545	N1S	43	1.15	3.60	85.5	12.362	230/460	9
		3600	143/5T	003360T3H145T-S	\$545	N1S	43	1.15	2.90	85.5	12.362	575	9
		1800	56HZ	003180T3E56Z-S	\$481	F2B	48	1.15	3.97	86.9	13.071	230/460	9
		1800	182/4T	003180T3E182T-S	\$524	N1S	73	1.15	3.90	89.5	15.157	230/460	9
		1800	182/4T	003180T3H182T-S	\$524	N1S	73	1.15	3.10	89.5	15.157	575	9
		1800	182/4T	003180T3P182T-S	\$524	N1S	73	1.15	8.90	89.5	15.157	200	9
		1800	182/4T	003180T3V182T-S	\$524	N1S	72	1.15	4.40	89.5	15.157	200/400	9
		1200	213/5T	003120T3E213T-S	\$775	N1S	113	1.15	4.20	88.5	16.575	230/460	9
		1200	213/5T	003120T3H213T-S	\$775	N1S	113	1.15	3.30	88.5	16.575	575	9
5	3.7	3600	182/4T	005360T3E182T-S	\$651	N1S	61	1.15	6.10	86.5	14.764	230/460	9
		3600	182/4T	005360T3H182T-S	\$651	N1S	61	1.15	4.90	86.5	14.764	575	9
		3600	182/4T	005360T3V182T-S	\$651	N1S	61	1.15	7.00	86.5	14.764	200/400	9
		1800	182/4T	005180T3E184T-S	\$630	N1S	88	1.15	6.30	89.5	16.339	230/460	9
		1800	182/4T	005180T3H184T-S	\$630	N1S	88	1.15	5.10	89.5	16.339	575	9
		1800	182/4T	005180T3P184T-S	\$630	N1S	88	1.15	14.6	89.5	16.339	200	9
		1800	182/4T	005180T3V184T-S	\$630	N1S	88	1.15	7.30	89.5	16.339	200/400	9
		1200	213/5T	005120T3E215T-S	\$1,057	N1S	135	1.15	6.70	89.5	16.969	230/460	9
1200	213/5T	005120T3H215T-S	\$1,057	N1S	135	1.15	5.40	89.5	16.969	575	9		
7.5	5.5	3600	182/4T	007360T3E184T-S	\$920	N1S	76	1.15	8.70	88.5	15.157	230/460	9
		3600	182/4T	007360T3H184T-S	\$920	N1S	76	1.15	6.90	88.5	15.157	575	9
		1800	213/5T	007180T3E213T-S	\$910	N1S	125	1.15	9.30	91.0	16.575	230/460	9
		1800	213/5T	007180T3H213T-S	\$910	N1S	125	1.15	7.40	91.0	16.575	575	9
		1800	213/5T	007180T3P213T-S	\$910	N1S	125	1.15	21.3	91.0	16.575	200	9
		1200	254/6T	007120T3E254T-S	\$1,467	N1S	209	1.15	10.2	90.2	20.472	230/460	9
		1200	254/6T	007120T3H254T-S	\$1,467	N1S	209	1.15	8.20	90.2	20.472	575	9
		1200	254T	007120T3E254T-W40	\$1,467	N1B	249	1.25	9.94	90.2	20.537	230/460	
10	7.5	3600	213/5T	010360T3E213T-S	\$1,081	N1S	126	1.15	12.0	89.5	16.969	230/460	9
		3600	213/5T	010360T3H213T-S	\$1,081	N1S	126	1.15	9.60	89.5	16.969	575	9
		1800	213/5T	010180T3E215T-S	\$1,102	N1S	130	1.15	12.4	91.7	16.575	230/460	9
		1800	213/5T	010180T3H215T-S	\$1,102	N1S	130	1.15	9.90	91.7	16.575	575	9
		1800	213/5T	010180T3P215T-S	\$1,102	N1S	130	1.15	28.5	91.7	16.575	200	9
		1200	254/6T	010120T3E256T-S	\$1,717	N1S	237	1.15	13.9	91.7	20.472	230/460	9
		1200	254/6T	010120T3H256T-S	\$1,717	N1S	237	1.15	11.1	91.7	20.472	575	9
		1200	254/6T	010120T3E256T-W40	\$1,717	N1B	289	1.25	12.8	91.7	22.285	230/460	
15	11	3600	213/5T	015360T3E215T-S	\$1,492	N1S	141	1.15	17.2	90.2	17.756	230/460	9
		3600	213/5T	015360T3H215T-S	\$1,492	N1S	141	1.15	13.8	90.2	17.756	575	9
		1800	254/6T	015180T3E254T-S	\$1,477	N1S	211	1.15	18.6	93.0	20.472	230/460	9
		1800	254/6T	015180T3H254T-S	\$1,477	N1S	211	1.15	14.9	93.0	20.472	575	9
		1800	254/6T	015180T3P254T-S	\$1,477	N1S	211	1.15	42.8	93.0	20.472	200	9
		1800	254/6T	015180T3V254T-S	\$1,477	N1S	211	1.15	21.4	93.0	20.472	200/400	9
		1800	254T	015180T3E254T-W40	\$1,477	N1B	284	1.25	17.5	93.0	20.537	230/460	
		1800	254T	015180T3H254T-W40	\$1,477	N1B	283	1.25	14.0	93.0	20.537	575	
		1800	254T	015180T3P254T-W40	\$1,477	N1B	283	1.25	40.3	93.0	20.537	200	
		1200	284T	015120T3E284T-W40	\$2,412	N1B	339	1.25	18.4	91.7	23.158	230/460	
1200	284T	015120T3H284T-W40	\$2,412	N1B	338	1.25	14.7	91.7	23.158	575			

continued on next page

Please refer to back cover for description of "NOTES"

For detailed specifications, data sheets, drawings and performance curves visit <http://www.weg.net>

Data subject to change without notice.

Can't find what you are looking for? Call 1-800-ASK-4WEG (275-4934)

ODP Foot Mount - *continued*

Three-Phase
General Purpose
Motors

HP	kW	RPM	Frame	Catalog Number	List Price	Mult. Symbol	Approx. Shipping Weight (lbs)	Service Factor	FL Amps @ High	FL. Eff (%)	C Dimension (in)	Voltage (V)	Notes
20	15	3600	254/6T	020360T3E254T-S	\$1,760	N1S	187	1.15	23.8	91.0	20.472	230/460	9
		3600	254/6T	020360T3H254T-S	\$1,760	N1S	187	1.15	19.0	91.0	20.472	575	9
		3600	254T	020360T3E254T-W40	\$1,760	N1B	230	1.25	24.3	91.0	20.537	230/460	
		3600	254T	020360T3H254T-W40	\$1,760	N1B	221	1.25	19.4	91.0	20.537	575	
		1800	254/6T	020180T3E256T-S	\$1,832	N1S	235	1.15	25.0	93.0	20.472	230/460	9
		1800	254/6T	020180T3H256T-S	\$1,832	N1S	235	1.15	20.0	93.0	20.472	575	9
		1800	254/6T	020180T3P256T-S	\$1,832	N1S	235	1.15	57.5	93.0	20.472	200	9
		1800	254/6T	020180T3V256T-S	\$1,832	N1S	235	1.15	28.8	93.0	20.472	200/400	9
		1800	254/6T	020180T3E256T-W40	\$1,832	N1B	320	1.25	24.1	93.0	22.285	230/460	
		1800	254/6T	020180T3H256T-W40	\$1,832	N1B	300	1.25	19.3	93.0	22.285	575	
		1800	254/6T	020180T3P256T-W40	\$1,832	N1B	319	1.25	55.4	93.0	22.285	200	
		1200	284/6T	020120T3E286T-W40	\$3,034	N1B	414	1.25	24.3	92.4	24.658	230/460	
		1200	284/6T	020120T3H286T-W40	\$3,034	N1B	413	1.25	19.4	92.4	24.658	575	
25	18.5	3600	254/6T	025360T3E256T-S	\$2,139	N1S	202	1.15	29.1	91.7	20.472	230/460	9
		3600	254/6T	025360T3H256T-S	\$2,139	N1S	202	1.15	23.3	91.7	20.472	575	9
		3600	254/6T	025360T3E256T-W40	\$2,139	N1B	260	1.25	28.8	91.7	22.285	230/460	
		3600	254/6T	025360T3H256T-W40	\$2,139	N1B	258	1.25	23.0	91.7	22.285	575	
		1800	284TS	025180T3E284TS-W40	\$2,160	N1B	379	1.25	29.5	93.6	21.783	230/460	
		1800	284TS	025180T3H284TS-W40	\$2,160	N1B	377	1.25	23.6	93.6	21.783	575	
		1800	284TS	025180T3V284TS-W40	\$2,160	N1B	396	1.25	33.9	93.6	21.783	200/400	
		1800	284T	025180T3E284T-W40	\$2,160	N1B	380	1.25	29.5	93.6	23.158	230/460	
		1800	284T	025180T3H284T-W40	\$2,160	N1B	379	1.25	23.6	93.6	23.158	575	
		1800	284T	025180T3P284T-W40	\$2,160	N1B	380	1.25	67.9	93.6	23.158	200	
		1200	324T	025120T3E324T-W40	\$3,519	N1B	485	1.25	30.8	93.0	25.807	230/460	
30	22	3600	284TS	030360T3E284TS-W40	\$2,487	N1B	332	1.25	35.0	91.7	21.783	230/460	
		3600	284TS	030360T3H284TS-W40	\$2,487	N1B	330	1.25	28.0	91.7	21.783	575	
		3600	284TS	030360T3V284TS-W40	\$2,487	N1B	333	1.25	40.3	91.7	21.783	200/400	
		1800	284/6TS	030180T3E286TS-W40	\$2,530	N1B	425	1.25	34.9	94.1	23.283	230/460	
		1800	284/6TS	030180T3H286TS-W40	\$2,530	N1B	429	1.25	27.9	94.1	23.283	575	
		1800	284/6TS	030180T3V286TS-W40	\$2,590	N1B	424	1.25	40.1	94.1	23.283	200/400	
		1800	284/6T	030180T3E286T-W40	\$2,530	N1B	427	1.25	34.9	94.1	24.658	230/460	
		1800	284/6T	030180T3H286T-W40	\$2,530	N1B	426	1.25	27.9	94.1	24.658	575	
		1800	284/6T	030180T3P286T-W40	\$2,530	N1B	427	1.25	80.3	94.1	24.658	200	
		1200	324/6T	030120T3E326T-W40	\$3,890	N1B	548	1.25	36.0	93.6	27.307	230/460	
		1200	324/6T	030120T3H326T-W40	\$3,890	N1B	577	1.25	28.8	93.6	27.307	575	

continued on next page

Please refer to back cover for description of "NOTES"

For detailed specifications, data sheets, drawings and performance curves visit <http://www.weg.net>



ODP Foot Mount - *continued*

HP	kW	RPM	Frame	Catalog Number	List Price	Mult. Symbol	Approx. Shipping Weight (lbs)	Service Factor	FL Amps @ High	FL. Eff (%)	C Dimension (in)	Voltage (V)	Notes
40	30	3600	284/6TS	040360T3E286TS-W40	\$3,308	N1B	375	1.25	46.8	92.4	23.283	230/460	
		3600	284/6TS	040360T3H286TS-W40	\$3,308	N1B	375	1.25	37.4	92.4	23.283	575	
		3600	284/6TS	040360T3P286TS-W40	\$3,308	N1B	393	1.25	108	92.4	23.283	200	
		3600	284/6TS	040360T3V286TS-W40	\$3,308	N1B	390	1.25	53.8	92.4	23.283	200/400	
		1800	324TS	040180T3E324TS-W40	\$3,095	N1B	479	1.25	47.6	94.1	24.307	230/460	
		1800	324TS	040180T3H324TS-W40	\$3,095	N1B	547	1.25	38.1	94.1	24.307	575	
		1800	324TS	040180T3V324TS-W40	\$3,095	N1B	506	1.25	54.7	94.1	24.307	200/400	
		1800	324T	040180T3E324T-W40	\$3,095	N1B	481	1.25	47.6	94.1	25.807	230/460	
		1800	324T	040180T3H324T-W40	\$3,095	N1B	475	1.25	38.1	94.1	25.807	575	
		1800	324T	040180T3P324T-W40	\$3,095	N1B	481	1.25	110	94.1	25.807	200	
		1200	364/5T	040120T3E364T-W40	\$5,544	N1B	855	1.25	47.1	94.1	29.725	230/460	
		1200	364/5T	040120T3H364T-W40	\$5,544	N1B	849	1.25	37.7	94.1	29.725	575	
50	37	3600	324TS	050360T3E324TS-W40	\$3,820	N1B	459	1.25	58.7	93.0	24.307	230/460	
		3600	324TS	050360T3H324TS-W40	\$3,820	N1B	456	1.25	47.0	93.0	24.307	575	
		3600	324TS	050360T3V324TS-W40	\$3,820	N1B	459	1.25	67.5	93.0	24.307	200/400	
		1800	324/6TS	050180T3E326TS-W40	\$3,788	N1B	542	1.25	58.5	94.5	25.807	230/460	
		1800	324/6TS	050180T3G326TS-W40	\$3,788	N1B	541	1.25	58.5	94.5	25.807	460	
		1800	324/6TS	050180T3H326TS-W40	\$3,788	N1B	533	1.25	46.8	94.5	25.807	575	
		1800	324/6TS	050180T3V326TS-W40	\$3,788	N1B	574	1.25	67.3	94.5	25.807	200/400	
		1800	324/6T	050180T3E326T-W40	\$3,788	N1B	544	1.25	58.5	94.5	27.307	230/460	
		1800	324/6T	050180T3H326T-W40	\$3,788	N1B	535	1.25	46.8	94.5	27.307	575	
		1800	324/6T	050180T3P326T-W40	\$3,788	N1B	545	1.25	135	94.5	27.307	200	
		1200	364/5T	050120T3E365T-W40	\$6,392	N1B	886	1.25	58.1	94.1	29.725	230/460	
		1200	364/5T	050120T3V365T-W40	\$6,392	N1B	884	1.25	66.8	94.1	29.725	200/400	
60	45	3600	324/6TS	060360T3E326TS-W40	\$4,581	N1B	504	1.25	71.0	93.6	25.807	230/460	
		3600	324/6TS	060360T3G326TS-W40	\$4,581	N1B	502	1.25	71.0	93.6	25.807	460	
		3600	324/6TS	060360T3H326TS-W40	\$4,581	N1B	501	1.25	56.8	93.6	25.807	575	
		3600	324/6TS	060360T3V326TS-W40	\$4,581	N1B	510	1.25	81.7	93.6	25.807	200/400	
		1800	364/5TS	060180T3E364TS-W40	\$4,443	N1B	851	1.25	69.9	95.0	27.522	230/460	
		1800	364/5TS	060180T3G364TS-W40	\$4,443	N1B	849	1.25	69.9	95.0	27.522	460	
		1800	364/5TS	060180T3H364TS-W40	\$4,443	N1B	847	1.25	55.9	95.0	27.522	575	
		1800	364/5TS	060180T3V364TS-W40	\$4,443	N1B	850	1.25	80.4	95.0	27.522	200/400	
		1800	364/5T	060180T3E364T-W40	\$4,443	N1B	855	1.25	69.9	95.0	29.725	230/460	
		1800	364/5T	060180T3G364T-W40	\$4,443	N1B	847	1.25	69.9	95.0	29.725	460	
		1800	364/5T	060180T3H364T-W40	\$4,443	N1B	852	1.25	55.9	95.0	29.725	575	
		1200	404/5T	060120T3E404T-W40	\$7,562	N1B	1045	1.25	70.3	94.5	34.100	230/460	

continued on next page

Please refer to back cover for description of "NOTES"

For detailed specifications, data sheets, drawings and performance curves visit <http://www.weg.net>

Data subject to change without notice.

ODP Foot Mount - *continued*

 Three-Phase
General Purpose
Motors

HP	kW	RPM	Frame	Catalog Number	List Price	Mult. Symbol	Approx. Shipping Weight (lbs)	Service Factor	FL Amps @ High	FL Eff (%)	C Dimension (in)	Voltage (V)	Notes
75	55	3600	364/5TS	075360T3E364TS-W40	\$5,799	N1B	789	1.25	84.8	93.6	27.522	230/460	
		3600	364/5TS	075360T3G364TS-W40	\$5,799	N1B	794	1.25	84.8	93.6	27.522	460	
		3600	364/5TS	075360T3H364TS-W40	\$5,799	N1B	794	1.25	67.8	93.6	27.522	575	
		3600	364/5TS	075360T3V364TS-W40	\$5,799	N1B	789	1.25	97.5	93.6	27.522	200/400	
		1800	364/5TS	075180T3E365TS-W40	\$5,658	N1B	874	1.25	85.5	95.0	27.522	230/460	
		1800	364/5TS	075180T3G365TS-W40	\$5,658	N1B	872	1.25	85.5	95.0	27.522	460	
		1800	364/5TS	075180T3H365TS-W40	\$5,658	N1B	872	1.25	68.4	95.0	27.522	575	
		1800	364/5TS	075180T3V365TS-W40	\$5,658	N1B	876	1.25	98.3	95.0	27.522	200/400	
		1800	364/5T	075180T3E365T-W40	\$5,658	N1B	879	1.25	85.5	95.0	29.725	230/460	
		1800	364/5T	075180T3ERB365T-W40	\$6,632	N1B	875	1.25	85.5	95.0	29.725	230/460	14
		1800	364/5T	075180T3G365T-W40	\$5,658	N1B	877	1.25	85.5	95.0	29.725	460	
		1800	364/5T	075180T3GRB365T-W40	\$6,632	N1B	897	1.25	85.5	95.0	29.725	460	14
		1800	364/5T	075180T3H365T-W40	\$5,658	N1B	876	1.25	68.4	95.0	29.725	575	
100	75	1200	404/5T	075120T3E405T-W40	\$8,358	N1B	1077	1.25	85.9	94.5	34.100	230/460	
		3600	364/5TS	100360T3E365TS-W40	\$6,644	N1B	842	1.25	116	93.6	27.522	230/460	
		3600	364/5TS	100360T3G365TS-W40	\$6,644	N1B	840	1.25	116	93.6	27.522	460	
		3600	364/5TS	100360T3H365TS-W40	\$6,644	N1B	836	1.25	92.8	93.6	27.522	575	
		3600	364/5TS	100360T3V365TS-W40	\$6,644	N1B	835	1.25	133	93.6	27.522	200/400	
		1800	404/5TS	100180T3E404TS-W40	\$7,141	N1B	1048	1.25	115	95.4	31.100	230/460	
		1800	404/5TS	100180T3G404TS-W40	\$7,141	N1B	1043	1.25	115	95.4	31.100	460	
		1800	404/5TS	100180T3V404TS-W40	\$7,141	N1B	1049	1.25	132	95.4	31.100	200/400	
		1800	404/5T	100180T3E404T-W40	\$7,141	N1B	1064	1.25	115	95.4	34.100	230/460	
		1800	404/5T	100180T3ERB404T-W40	\$7,141	N1B	1086	1.25	115	95.4	34.100	230/460	14
		1800	404/5T	100180T3G404T-W40	\$7,141	N1B	1059	1.25	115	95.4	34.100	460	
		1800	404/5T	100180T3GRB404T-W40	\$7,141	N1B	1081	1.25	115	95.4	34.100	460	14
		1800	404/5T	100180T3H404T-W40	\$7,141	N1B	1059	1.25	92.0	95.4	34.100	575	
125	90	1200	444/5T	100120T3E444T-W40	\$11,863	N1B	1497	1.25	127	95.0	38.108	230/460	
		1200	444/5T	100120T3G444T-W40	\$11,863	N1B	1490	1.25	127	95.0	38.108	460	
		3600	404/5TS	125360T3E404TS-W40	\$8,826	N1B	975	1.25	136	94.1	31.100	230/460	
		3600	404/5TS	125360T3G404TS-W40	\$8,826	N1B	971	1.25	136	94.1	31.100	460	
		3600	404/5TS	125360T3H404TS-W40	\$8,826	N1B	969	1.25	109	94.1	31.100	575	
		1800	404/5TS	125180T3E405TS-W40	\$7,981	N1B	1123	1.25	138	95.4	31.100	230/460	
		1800	404/5TS	125180T3G405TS-W40	\$7,981	N1B	1119	1.25	138	95.4	31.100	460	
		1800	404/5T	125180T3E405T-W40	\$7,981	N1B	1139	1.25	138	95.4	34.100	230/460	
		1800	404/5T	125180T3ERB405T-W40	\$7,981	N1B	1161	1.25	138	95.4	34.100	230/460	14
		1800	404/5T	125180T3G405T-W40	\$7,981	N1B	1135	1.25	138	95.4	34.100	460	
		1800	404/5T	125180T3GRB405T-W40	\$7,981	N1B	1157	1.25	138	95.4	34.100	460	14
		1800	404/5T	125180T3H405T-W40	\$7,981	N1B	1134	1.25	110	95.4	34.100	575	
		1200	444/5T	125120T3G445T-W40	\$12,753	N1B	1544	1.25	154	95.0	38.108	460	
150	110	3600	404/5TS	150360T3G405TS-W40	\$11,416	N1B	988	1.25	167	94.1	31.100	460	
		3600	404/5TS	150360T3H405TS-W40	\$11,416	N1B	987	1.25	134	94.1	31.100	575	
		1800	444/5TS	150180T3G444TS-W40	\$10,668	N1B	1474	1.25	170	95.8	34.358	460	
		1800	444/5T	150180T3G444T-W40	\$10,668	N1B	1530	1.25	170	95.8	38.108	460	
		1800	444/5T	150180T3GRB444T-W40	\$10,668	N1B	1541	1.25	170	95.8	38.108	460	14
		1800	444/5T	150180T3H444T-W40	\$10,668	N1B	1526	1.25	136	95.8	38.108	575	
		1200	444/5T	150120T3G445T-W40	\$13,615	N1B	1686	1.25	183	95.4	38.108	460	

continued on next page

Please refer to back cover for description of "NOTES"

For detailed specifications, data sheets, drawings and performance curves visit <http://www.weg.net>



ODP Foot Mount - continued

HP	kW	RPM	Frame	Catalog Number	List Price	Mult. Symbol	Approx. Shipping Weight (lbs)	Service Factor	FL Amps @ High	FL Eff (%)	C Dimension (in)	Voltage (V)	Notes
200	150	3600	444/5TS	200360T3G444TS-W40	\$14,504	N1B	1414	1.15	225	95.0	34.358	460	
		3600	444/5TS	200360T3H444TS-W40	\$14,504	N1B	1413	1.15	180	95.0	34.358	575	
		1800	444/5TS	200180T3G445TS-W40	\$13,004	N1B	1548	1.15	234	95.8	34.358	460	
		1800	444/5T	200180T3G445T-W40	\$13,004	N1B	1604	1.15	234	95.8	38.108	460	
		1800	444/5T	200180T3GRB445T-W40	\$13,004	N1B	1615	1.15	234	95.8	38.108	460	14
		1200	447/9T	200120T3G447/9T-W40	\$23,380	N1B	2214	1.15	241	95.4	48.317	460	37
250	185	3600	444/5TS	250360T3G445TS-W40	\$18,983	N1B	1527	1.15	278	95.0	34.358	460	
		3600	444/5TS	250360T3H445TS-W40	\$18,983	N1B	1522	1.15	222	95.0	34.358	575	
		1800	444/5TS	250180T3G445TS-W40	\$15,513	N1B	1623	1.15	289	95.8	34.358	460	
		1800	444/5T	250180T3G445T-W40	\$15,513	N1B	1679	1.15	289	95.8	38.108	460	
		1800	444/5T	250180T3GRB445T-W40	\$15,513	N1B	1691	1.15	289	95.8	38.108	460	14
		1800	444/5T	250180T3H445T-W40	\$15,513	N1B	1680	1.15	231	95.8	38.108	575	
		1200	447/9T	250120T3G447/9T-W40	\$27,249	N1B	2379	1.15	299	95.8	48.317	460	37
300	220	3600	444/5TS	300360T3G445TS-W40	\$22,294	N1B	1593	1.15	329	95.4	34.358	460	
		1800	447/9TS	300180T3G447/9TS-W40	\$24,878	N1B	2083	1.15	324	95.8	42.959	460	
		1800	447/9T	300180T3G447/9T-W40	\$24,878	N1B	2127	1.15	324	95.8	48.317	460	
		1200	447/9T	300120T3G447/9T-W40	\$29,853	N1B	2809	1.15	366	95.4	48.317	460	37
350	260	3600	447/9TS	350360T3G447/9TS-W40	\$25,055	N1B	2108	1.15	384	95.4	42.959	460	37
		1800	447/9TS	350180T3G447/9TS-W40	\$25,174	N1B	2244	1.15	396	95.8	42.959	460	
		1800	447/9T	350180T3G447/9T-W40	\$25,174	N1B	2319	1.15	396	95.8	48.317	460	
400	300	3600	447/9TS	400360T3G447/9TS-W40	\$26,678	N1B	2189	1.15	442	95.8	42.959	460	37
		1800	447/9TS	400180T3G447/9TS-W40	\$28,311	N1B	2454	1.15	452	95.8	42.959	460	
		1800	447/9T	400180T3G447/9T-W40	\$28,311	N1B	2509	1.15	452	95.8	48.317	460	
450	330	3600	447/9TS	450360T3G447/9TS-W40	\$28,239	N1B	2294	1.15	478	96.2	42.959	460	37
500	370	3600	447/9TS	500360T3G447/9TS-W40	\$31,476	N1B	2377	1.15	536	96.2	42.959	460	37
550	400	3600	447/9TS	550360T3G447/9TS-W40	\$32,629	N1B	2452	1.15	580	96.2	42.959	460	37
600	440	3600	447/9TS	600360T3G447/9TS-W40	\$32,994	N1B	2540	1.15	638	96.2	42.959	460	37
700	515	3600	5010/11S	700360T3Q5010S-W40	\$42,603	N1B	3684	1.15	764	96.2	56.000	460	37,43
800	595	3600	5010/11S	800360T3Q5010S-W40	\$45,039	N1B	3528	1.15	885	96.2	56.000	460	37,43

Please refer to back cover for description of "NOTES"

For detailed specifications, data sheets, drawings and performance curves visit <http://www.weg.net>

Data subject to change without notice.

Can't find what you are looking for? Call 1-800-ASK-4WEG (275-4934)

Three-Phase General Purpose Motors



ODP - C-Face - Foot Mount

Three-Phase
General Purpose
Motors

HP	kW	RPM	Frame	Catalog Number	List Price	Mult. Symbol	Approx. Shipping Weight (lbs)	Service Factor	FL Amps @ High	FL Eff (%)	"C" Dimension (in)	Voltage (V)	Notes
0.25	0.18	3600	56C	.25360T3E56C-S	\$259	F2B	19	1.35	0.46	65.6	10.315	230/460	9
		1800	56C	.25180T3E56C-S	\$263	F2B	19	1.35	0.53	69.5	9.921	230/460	9
		1200	56C	.25120T3E56C-S	\$316	F2B	21	1.35	0.55	67.5	10.315	230/460	9
0.33	0.25	3600	56C	.33360T3E56C-S	\$270	F2B	19	1.35	0.61	69.5	10.315	230/460	9
		1800	56C	.33180T3E56C-S	\$284	F2B	20	1.35	0.67	73.4	10.315	230/460	9
		1200	56C	.33120T3E56C-S	\$361	F2B	22	1.35	0.70	71.4	10.315	230/460	9
0.5	0.37	3600	56C	.50360T3E56C-S	\$286	F2B	20	1.25	0.81	73.4	10.315	230/460	9
		1800	56C	.50180T3E56C-S	\$324	F2B	24	1.25	0.86	78.2	10.709	230/460	9
		1200	56C	.50120T3E56C-S	\$377	F2B	25	1.25	0.93	75.3	10.709	230/460	9
0.75	0.55	3600	56C	.75360T3E56C-S	\$333	F2B	22	1.25	1.14	76.8	10.709	230/460	9
		1800	56C	.75180T3E56C-S	\$358	F2B	27	1.25	1.15	81.1	11.102	230/460	9
		1800	56C	.75180T3H56C-S	\$358	F2B	27	1.25	0.92	81.1	11.102	575	9
		1200	56HC	.75120T3E56C-S	\$412	F2B	38	1.15	1.26	81.7	12.677	230/460	9
1	0.75	3600	56C	001360T3E56C-S	\$383	F2B	23	1.25	1.51	77.0	10.709	230/460	9
		1800	56C	001180T3E56C-S	\$378	F2B	30	1.15	1.57	83.5	11.495	230/460	9
		1800	143/5TC	001180T3E143TC-S	\$424	N1S	38	1.15	1.50	85.5	11.181	230/460	9
		1800	143/5TC	001180T3H143TC-S	\$424	N1S	38	1.15	1.20	85.5	11.181	575	9
		1800	143/5TC	001180T3P143TC-S	\$424	N1S	38	1.15	3.50	85.5	11.181	200	9
		1200	56HC	001120T3E56C-S	\$486	F2B	42	1.15	1.68	82.5	13.070	230/460	9
1.5	1.1	3600	56C	001560T3E56C-S	\$408	F2B	30	1.15	1.85	84.0	11.889	230/460	9
		3600	143/5TC	001560T3E143TC-S	\$476	N1S	33	1.15	1.90	84.0	11.181	230/460	9
		3600	143/5TC	001560T3H143TC-S	\$476	N1S	33	1.15	1.50	84.0	11.181	575	9
		1800	56HC	001580T3E56C-S	\$389	F2B	40	1.15	2.10	86.5	12.677	230/460	9
		1800	143/5TC	001580T3E145TC-S	\$483	N1S	45	1.15	2.10	86.5	12.362	230/460	9
		1800	143/5TC	001580T3H145TC-S	\$483	N1S	45	1.15	1.70	86.5	12.362	575	9
		1800	143/5TC	001580T3P145TC-S	\$483	N1S	45	1.15	4.80	86.5	12.362	200	9
2	1.5	3600	56HC	002360T3E56C-S	\$464	F2B	38	1.15	2.42	85.5	12.677	230/460	9
		3600	143/5TC	002360T3E145TC-S	\$521	N1S	40	1.15	2.40	85.5	11.969	230/460	9
		3600	143/5TC	002360T3H145TC-S	\$521	N1S	40	1.15	1.90	85.5	11.969	575	9
		1800	56HC	002180T3E56C-S	\$399	F2B	40	1.15	2.69	86.5	12.677	230/460	9
		1800	143/5TC	002180T3E145TC-S	\$526	N1S	43	1.15	2.70	86.5	12.362	230/460	9
		1800	143/5TC	002180T3H145TC-S	\$526	N1S	43	1.15	2.20	86.5	12.362	575	9
		1800	143/5TC	002180T3V145TC-S	\$526	N1S	43	1.15	3.10	86.5	12.362	200/400	9
		1200	182/4TC	002120T3E184TC-S	\$635	N1S	73	1.15	3.00	87.5	14.764	230/460	9
		1200	182/4TC	002120T3H184TC-S	\$635	N1S	73	1.15	2.40	87.5	14.764	575	9
		3	2.2	3600	56HC	003360T3E56C-S	\$513	F2B	42	1.15	3.59	85.5	13.070
3600	143/5TC			003360T3E145TC-S	\$579	N1S	43	1.15	3.60	85.5	12.362	230/460	9
3600	143/5TC			003360T3H145TC-S	\$579	N1S	43	1.15	2.90	85.5	12.362	575	9
3600	143/5TC			003360T3V145TC-S	\$579	N1S	43	1.15	4.10	85.5	12.362	200/400	9
1800	182/4TC			003180T3E182TC-S	\$562	N1S	73	1.15	3.90	89.5	15.157	230/460	9
1800	182/4TC			003180T3H182TC-S	\$562	N1S	82	1.15	3.10	89.5	15.157	575	9
1800	182/4TC			003180T3V182TC-S	\$562	N1S	82	1.15	4.40	89.5	15.157	200/400	9
1200	213/5TC			003120T3E213TC-S	\$826	N1S	113	1.15	4.20	88.5	16.575	230/460	9
		1200	213/5TC	003120T3H213TC-S	\$826	N1S	113	1.15	3.30	88.5	16.575	575	9

continued on next page

Please refer to back cover for description of "NOTES"

For detailed specifications, data sheets, drawings and performance curves visit <http://www.weg.net>



ODP - C-Face - Foot Mount - continued

Three-Phase
General Purpose
Motors

HP	KW	RPM	Frame	Catalog Number	List Price	Mult. Symbol	Approx. Shipping Weight (lbs)	Service Factor	FL Amps @ High	FL. Eff (%)	"C" Dimension (in)	Voltage (V)	Notes
5	3.7	3600	182/4TC	005360T3E182TC-S	\$689	N1S	61	1.15	6.10	86.5	14.764	230/460	9
		3600	182/4TC	005360T3H182TC-S	\$689	N1S	61	1.15	4.90	86.5	14.764	575	9
		3600	182/4TC	005360T3V182TC-S	\$689	N1S	61	1.15	7.00	86.5	14.764	200/400	9
		1800	182/4TC	005180T3E184TC-S	\$668	N1S	88	1.15	6.30	89.5	16.339	230/460	9
		1800	182/4TC	005180T3H184TC-S	\$668	N1S	97	1.15	5.10	89.5	16.339	575	9
		1800	182/4TC	005180T3V184TC-S	\$668	N1S	97	1.15	7.30	89.5	16.339	200/400	9
		1200	213/5TC	005120T3E215TC-S	\$1,108	N1S	135	1.15	6.70	89.5	16.969	230/460	9
		1200	213/5TC	005120T3H215TC-S	\$1,108	N1S	135	1.15	5.40	89.5	16.969	575	9
7.5	5.5	3600	182/4TC	007360T3E184TC-S	\$958	N1S	76	1.15	8.70	88.5	15.157	230/460	9
		3600	182/4TC	007360T3H184TC-S	\$958	N1S	76	1.15	6.90	88.5	15.157	575	9
		1800	213/5TC	007180T3E213TC-S	\$961	N1S	125	1.15	9.30	91.0	16.575	230/460	9
		1800	213/5TC	007180T3H213TC-S	\$961	N1S	125	1.15	7.40	91.0	16.575	575	9
		1800	213/5TC	007180T3V213TC-S	\$961	N1S	125	1.15	10.6	91.0	16.575	200/400	9
		1200	254/6TC	007120T3E254TC-S	\$1,535	N1S	209	1.15	10.2	90.2	20.472	230/460	9
		1200	254/6TC	007120T3H254TC-S	\$1,535	N1S	209	1.15	8.20	90.2	20.472	575	9
		1200	254TC	007120T3E254TC-W40	\$1,535	N1B	247	1.25	9.94	90.2	21.037	230/460	
1200	254TC	007120T3H254TC-W40	\$1,535	N1B	255	1.25	7.95	90.2	21.037	575			
10	7.5	3600	213/5TC	010360T3E213TC-S	\$1,132	N1S	126	1.15	12.0	89.5	16.969	230/460	9
		3600	213/5TC	010360T3H213TC-S	\$1,132	N1S	126	1.15	9.60	89.5	16.969	575	9
		3600	213/5TC	010360T3V213TC-S	\$1,132	N1S	126	1.15	13.8	89.5	16.969	200/400	9
		1800	213/5TC	010180T3E215TC-S	\$1,153	N1S	130	1.15	12.4	91.7	16.575	230/460	9
		1800	213/5TC	010180T3H215TC-S	\$1,153	N1S	130	1.15	9.90	91.7	16.575	575	9
		1800	213/5TC	010180T3V215TC-S	\$1,153	N1S	130	1.15	14.3	91.7	16.575	200/400	9
		1200	254/6TC	010120T3E256TC-S	\$1,785	N1S	237	1.15	13.9	91.7	20.472	230/460	9
		1200	254/6TC	010120T3H256TC-S	\$1,785	N1S	237	1.15	11.1	91.7	20.472	575	9
		1200	254/6TC	010120T3E256TC-W40	\$1,785	N1B	282	1.25	12.8	91.7	22.785	230/460	
1200	254/6TC	010120T3H256TC-W40	\$1,785	N1B	276	1.25	10.2	91.7	22.785	575			
15	11	3600	213/5TC	015360T3E215TC-S	\$1,543	N1S	141	1.15	17.2	90.2	17.756	230/460	9
		3600	213/5TC	015360T3H215TC-S	\$1,543	N1S	141	1.15	13.8	90.2	17.756	575	9
		3600	213/5TC	015360T3V215TC-S	\$1,543	N1S	141	1.15	19.8	90.2	17.756	200/400	9
		1800	254/6TC	015180T3E254TC-S	\$1,545	N1S	211	1.15	18.6	93.0	20.472	230/460	9
		1800	254/6TC	015180T3H254TC-S	\$1,545	N1S	211	1.15	14.9	93.0	20.472	575	9
		1800	254/6TC	015180T3V254TC-S	\$1,545	N1S	211	1.15	21.4	93.0	20.472	200/400	9
		1800	254TC	015180T3E254TC-W40	\$1,545	N1B	290	1.25	17.5	93.0	21.037	230/460	
		1800	254TC	015180T3H254TC-W40	\$1,545	N1B	289	1.25	14.0	93.0	21.037	575	
		1800	254TC	015180T3V254TC-W40	\$1,545	N1B	264	1.25	20.1	93.0	21.037	200/400	
		1200	284TC	015120T3E284TC-W40	\$2,497	N1B	346	1.25	18.4	91.7	23.158	230/460	
1200	284TC	015120T3H284TC-W40	\$2,497	N1B	346	1.25	14.0	93.0	23.158	575			

continued on next page

Please refer to back cover for description of "NOTES"

For detailed specifications, data sheets, drawings and performance curves visit <http://www.weg.net>

Data subject to change without notice.

Can't find what you are looking for? Call 1-800-ASK-4WEG (275-4934)

ODP - C-Face - Foot Mount - *continued*

Three-Phase
General Purpose
Motors

HP	kW	RPM	Frame	Catalog Number	List Price	Mult. Symbol	Approx. Shipping Weight (lbs)	Service Factor	FL Amps @ High	FL. Eff (%)	"C" Dimension (in)	Voltage (V)	Notes
20	15	3600	254/6TC	020360T3E254TC-S	\$1,828	N1S	187	1.15	23.8	91.0	20.472	230/460	9
		3600	254/6TC	020360T3H254TC-S	\$1,828	N1S	187	1.15	19.0	91.0	20.472	575	9
		3600	254TC	020360T3E254TC-W40	\$1,828	N1B	221	1.25	24.3	91.0	21.037	230/460	
		3600	254TC	020360T3H254TC-W40	\$1,828	N1B	221	1.25	19.4	91.0	21.037	575	
		1800	254/6TC	020180T3E256TC-S	\$1,900	N1S	235	1.15	25.0	93.0	20.472	230/460	9
		1800	254/6TC	020180T3H256TC-S	\$1,900	N1S	235	1.15	20.0	93.0	20.472	575	9
		1800	254/6TC	020180T3V256TC-S	\$1,900	N1S	235	1.15	28.8	93.0	20.472	200/400	9
		1800	254/6TC	020180T3E256TC-W40	\$1,900	N1B	326	1.25	24.1	93.0	22.785	230/460	
		1800	254/6TC	020180T3H256TC-W40	\$1,900	N1B	300	1.25	19.3	93.0	22.785	575	
		1800	254/6TC	020180T3V256TC-W40	\$1,900	N1B	301	1.25	27.7	93.0	22.785	200/400	
		1200	284/6TC	020120T3E286TC-W40	\$3,119	N1B	422	1.25	24.3	92.4	24.658	230/460	
		1200	284/6TC	020120T3H286TC-W40	\$3,119	N1B	421	1.25	19.4	92.4	24.658	575	
25	18.5	3600	254/6TC	025360T3E256TC-S	\$2,207	N1S	202	1.15	29.1	91.7	20.472	230/460	9
		3600	254/6TC	025360T3H256TC-S	\$2,207	N1S	202	1.15	23.3	91.7	20.472	575	9
		3600	254/6TC	025360T3E256TC-W40	\$2,207	N1B	266	1.25	28.8	91.7	22.785	230/460	
		3600	254/6TC	025360T3H256TC-W40	\$2,207	N1B	262	1.25	23.0	91.7	22.785	575	
		1800	284TC	025180T3E284TC-W40	\$2,245	N1B	388	1.25	29.5	93.6	23.158	230/460	
		1800	284TC	025180T3H284TC-W40	\$2,245	N1B	387	1.25	23.6	93.6	23.158	575	
		1800	284TC	025180T3V284TC-W40	\$2,245	N1B	387	1.25	33.9	93.6	23.158	200/400	
		1200	324TC	025120T3E324TC-W40	\$3,619	N1B	501	1.25	30.8	93.0	25.807	230/460	
30	22	3600	284TSC	030360T3E284TSC-W40	\$2,572	N1B	339	1.25	35.0	91.7	21.783	230/460	
		3600	284TSC	030360T3H284TSC-W40	\$2,572	N1B	338	1.25	28.0	91.7	21.783	575	
		3600	284TSC	030360T3V284TSC-W40	\$2,572	N1B	340	1.25	40.3	91.7	21.783	200/400	
		1800	284/6TC	030180T3E286TC-W40	\$2,615	N1B	434	1.25	34.9	94.1	24.658	230/460	
		1800	284/6TC	030180T3H286TC-W40	\$2,615	N1B	434	1.25	27.9	94.1	24.658	575	
		1800	284/6TC	030180T3V286TC-W40	\$2,615	N1B	434	1.25	40.1	94.1	24.658	200/400	
		1200	324/6TC	030120T3E326TC-W40	\$3,990	N1B	564	1.25	36.0	93.6	27.307	230/460	
40	30	3600	286TSC	040360T3H286TSC*	\$3,393	N1B	396	1.15	37.7	92.4	23.504	575	
		3600	284/6TSC	040360T3E286TSC-W40	\$3,393	N1B	383	1.25	46.8	92.4	23.283	230/460	
		3600	284/6TSC	040360T3H286TSC-W40	\$3,393	N1B	396	1.25	37.4	92.4	23.283	575	
		1800	324TSC	040180T3E324TSC-W40	\$3,195	N1B	573	1.25	47.6	94.1	24.307	230/460	
		1800	324TC	040180T3E324TC-W40	\$3,195	N1B	497	1.25	47.6	94.1	25.807	230/460	
		1800	324TC	040180T3H324TC-W40	\$3,195	N1B	489	1.25	38.1	94.1	25.807	575	
		1200	364/5TC	040120T3E364TC-W40	\$5,938	N1B	881	1.25	47.1	94.1	29.725	230/460	
50	37	3600	324TSC	050360T3H324TSC*	\$3,920	N1B	521	1.15	47.3	93.0	24.685	575	
		3600	324TSC	050360T3E324TSC-W40	\$3,920	N1B	474	1.25	58.7	93.0	24.307	230/460	
		3600	324TSC	050360T3H324TSC-W40	\$3,920	N1B	471	1.25	47.0	93.0	24.307	575	
		1800	324/6TSC	050180T3E326TSC-W40	\$3,888	N1B	557	1.25	58.5	94.5	25.807	230/460	
		1800	324/6TC	050180T3E326TC-W40	\$3,888	N1B	560	1.25	58.5	94.5	27.307	230/460	
		1800	324/6TC	050180T3H326TC-W40	\$3,888	N1B	551	1.25	46.8	94.5	27.307	575	
		1200	364/5TC	050120T3E365TC-W40	\$6,786	N1B	912	1.25	58.1	94.1	29.725	230/460	
60	45	3600	326TSC	060360T3E326TSC*	\$4,681	N1B	560	1.15	71.0	93.6	26.181	230/460	
		3600	324/6TSC	060360T3E326TSC-W40	\$4,681	N1B	520	1.25	71.0	93.6	25.807	230/460	
		1800	364/5TC	060180T3E364TC-W40	\$4,837	N1B	881	1.25	69.9	95.0	29.725	230/460	
		1800	364/5TC	060180T3H364TC-W40	\$4,837	N1B	878	1.25	55.9	95.0	29.725	575	

continued on next page

Please refer to back cover for description of "NOTES"

For detailed specifications, data sheets, drawings and performance curves visit <http://www.weg.net>



ODP - C-Face - Foot Mount - *continued*

HP	kW	RPM	Frame	Catalog Number	List Price	Mult. Symbol	Approx. Shipping Weight (lbs)	Service Factor	FL Amps @ High	FL. Eff (%)	"C" Dimension (in)	Voltage (V)	Notes
75	55	3600	364/5TSC	075360T3E364TSC-W40	\$6,193	N1B	816	1.25	84.8	93.6	27.600	230/460	
		1800	364/5TC	075180T3E365TC-W40	\$6,052	N1B	905	1.25	85.5	95.0	29.725	230/460	
		1800	364/5TC	075180T3H365TC-W40	\$6,052	N1B	902	1.25	68.4	95.0	29.725	575	
100	75	1800	404/5TSC	100180T3E404TSC-W40	\$7,587	N1B	1074	1.25	115	95.4	31.100	230/460	
		1800	404/5TSC	100180T3H404TSC-W40	\$7,587	N1B	1069	1.25	92.0	95.4	31.100	575	
		1800	404/5TC	100180T3E404TC-W40	\$7,587	N1B	1088	1.25	115	95.4	34.100	230/460	
		1800	404/5TC	100180T3H404TC-W40	\$7,587	N1B	1083	1.25	92.0	95.4	34.100	575	
125	90	1800	404/5TSC	125180T3E405TSC-W40	\$8,427	N1B	1150	1.25	138	95.4	31.100	230/460	
		1800	404/5TSC	125180T3G405TSC-W40	\$8,427	N1B	1145	1.25	138	95.4	31.100	460	
		1800	404/5TC	125180T3E405TC-W40	\$8,427	N1B	1164	1.25	138	95.4	34.100	230/460	
		1800	404/5TC	125180T3G405TC-W40	\$8,427	N1B	1159	1.25	138	95.4	34.100	460	
		1800	404/5TC	125180T3H405TC-W40	\$8,427	N1B	1158	1.25	110	95.4	34.100	575	
150	110	3600	404/5TSC	150360T3G405TSC-W40	\$11,862	N1B	1014	1.25	167	94.1	31.100	460	
		1800	444/5TSC	150180T3G444TSC-W40	\$11,228	N1B	1522	1.25	170	95.8	34.358	460	
		1800	444/5TC	150180T3G444TC-W40	\$11,228	N1B	1583	1.25	170	95.8	38.325	460	
		1800	444/5TC	150180T3H444TC-W40	\$11,228	N1B	1582	1.25	136	95.8	38.325	575	
200	150	3600	444/5TSC	200360T3G444TSC-W40	\$15,064	N1B	1463	1.15	225	95.0	34.358	460	
		1800	444/5TC	200180T3G445TC-W40	\$13,564	N1B	1657	1.15	234	95.8	38.325	460	
250	185	3600	444/5TSC	250360T3G445TSC-W40	\$19,543	N1B	1575	1.15	278	95.0	34.358	460	
		1800	444/5TC	250180T3G445TC-W40	\$16,073	N1B	1733	1.15	289	95.8	38.325	460	

* To be discontinued and replaced by W40 model once inventory is depleted.

Please refer to back cover for description of "NOTES"

For detailed specifications, data sheets, drawings and performance curves visit <http://www.weg.net>

Data subject to change without notice.

Can't find what you are looking for? Call 1-800-ASK-4WEG (275-4934)

Three-Phase General Purpose Motors



ODP - C-Face - Footless

Three-Phase
General Purpose
Motors

HP	kW	RPM	Frame	Catalog Number	List Price	Mult. Symbol	Approx. Shipping Weight (lbs)	Service Factor	FL Amps @ High	FL. Eff (%)	"C" Dimension (in)	Voltage (V)	Notes
0.25	0.18	1800	56C	.25180T3E56CFL-S	\$263	F2B	19	1.35	0.53	66.0	9.921	230/460	9,20
		1800	56C	.25180T3H56CFL-S	\$263	F2B	19	1.35	0.42	69.5	9.921	575	9,20
0.33	0.25	3600	56C	.33360T3E56CFL-S	\$270	F2B	19	1.35	0.61	69.5	10.315	230/460	9,20
		1800	56C	.33180T3E56CFL-S	\$284	F2B	20	1.35	0.67	73.4	10.315	230/460	9,20
		1800	56C	.33180T3H56CFL-S	\$284	F2B	20	1.35	0.54	73.4	10.315	575	9,20
0.5	0.37	3600	56C	.50360T3E56CFL-S	\$286	F2B	20	1.25	0.81	73.4	10.315	230/460	9,20
		1800	56C	.50180T3E56CFL-S	\$324	F2B	24	1.25	0.86	78.2	10.709	230/460	9,20
		1800	56C	.50180T3H56CFL-S	\$324	F2B	24	1.25	0.69	78.2	10.709	575	9,20
0.75	0.55	3600	56C	.75360T3E56CFL-S	\$333	F2B	22	1.25	1.14	76.8	10.709	230/460	9,20
		1800	56C	.75180T3E56CFL-S	\$358	F2B	27	1.25	1.15	81.1	11.102	230/460	9,20
		1800	56C	.75180T3H56CFL-S	\$358	F2B	27	1.25	0.92	81.1	11.102	575	9,20
1	0.75	3600	56C	001360T3E56CFL-S	\$383	F2B	23	1.25	1.51	77.0	10.709	230/460	9,20
		1800	56C	001180T3E56CFL-S	\$378	F2B	30	1.15	1.57	83.5	11.495	230/460	9,20
		1800	56C	001180T3H56CFL-S	\$378	F2B	30	1.15	1.26	83.5	11.495	575	9,20
1.5	1.1	3600	56C	001560T3E56CFL-S	\$408	F2B	30	1.15	1.85	84.0	11.889	230/460	9,20
		1800	56C	001580T3E56CFL-S	\$389	F2B	40	1.15	2.10	86.5	12.677	230/460	9,20
		1800	56C	001580T3H56CFL-S	\$389	F2B	40	1.15	1.68	86.5	12.677	575	9,20
2	1.5	3600	56C	002360T3E56CFL-S	\$464	F2B	38	1.15	2.42	85.5	12.677	230/460	9,20
		1800	56C	002180T3E56CFL-S	\$399	F2B	40	1.15	2.69	86.5	12.677	230/460	9,20
		1800	56C	002180T3H56CFL-S	\$399	F2B	40	1.15	2.15	86.5	12.677	575	9,20
3	2.2	3600	56C	003360T3E56CFL-S	\$513	F2B	42	1.15	3.59	85.5	13.070	230/460	9,20



ODP - Resilient Base

HP	kW	RPM	Frame	Catalog Number	List Price	Mult. Symbol	Approx. Shipping Weight (lbs)	Service Factor	FL Amps @ High	FL. Eff (%)	"C" Dimension (in)	Voltage (V)	Notes
0.33	0.25	1800	56	.33180T3ERB56-S	\$314	F2B	22	1.35	0.67	73.4	10.827	230/460	9,13
0.5	0.37	1800	56	.50180T3ERB56-S	\$354	F2B	25	1.25	0.86	78.2	11.220	230/460	9,13
0.75	0.55	1800	56	.75180T3ERB56-S	\$388	F2B	28	1.25	1.15	81.1	11.614	230/460	9,13
1	0.75	1800	56	001180T3ERB56-S	\$408	F2B	31	1.15	1.57	83.5	12.008	230/460	9,13
1.5	1.1	1800	56H	001580T3ERB56-S	\$419	F2B	42	1.15	2.10	86.5	13.189	230/460	9,13

Please refer to back cover for description of "NOTES"

For detailed specifications, data sheets, drawings and performance curves visit <http://www.weg.net>

Three-Phase General Purpose Motors

IEEE 841 - THREE PHASE TEFC - NEMA Premium®

WEG's IEEE 841 motors are specially suited for Pulp & Paper mills, Steel mills, Petrochemical Plants and diverse demanding applications requiring severe duty long life motors.

WEG's W22 cast iron platform has an improved cooling system and solid feet for cooler operation and reduced vibration and noise extending the life of the motor.

Standard Features:

- Class F insulation (Impregnation Resin and magnet wire are class H)
- F1 Mounted (F2 convertible). Frames 447T and up can easily be F2 converted by simply rotating the terminal box adapter
- Stainless Steel Nameplate - Laser etched with high contrast background
- All frames with regreasable ball bearings
- Class I, Div. 2, Groups A, B, C & D – T3, Class II, Div 2, Groups F & G – T3C

*Inverter Rated:

1000:1 for variable torque

20:1 for constant torque

** Frame 586/7 250HP and up 6:1 CT and 1000:1 VT*

** Insulated bearing housing on the NDE standard on L447/9T and above*



Features that make a difference:

- 1.25 Service Factor up to 100 HP
- InproSeal Bearing Isolators both ends
- Bearing protection meets IP56
- Rubber lead separator between terminal box and frame
- Vibration: 0.04 inches per second or less
- Guaranteed foot flatness to within 0.005"
- Bearing life 50,000 hours (L-10)
- Epoxy Paint system exceeds 250hrs Salt Spray test
- Interior surfaces are epoxy coated
- Non-sparking fan
- NPT Threaded terminal box
- Seamless copper lead lugs
- Seamless Stainless Steel grease extension tubes
- Automatic grease relief fittings
- IEEE 841 Test Report in conduit box
- Suitable for IEEE45 and USCG 259 – Marine Duty

ADDITIONAL TECHNICAL DATA

ELECTRICAL DATA: B-12

MECHANICAL DATA: B-72



Three-Phase General Purpose Motors



IEEE 841 - Three-Phase

TEFC - Foot Mount

Three-Phase
General Purpose
Motors

HP	kW	RPM	Frame	Catalog Number	List Price	Mult. Symbol	Approx. Shipping Weight (lbs)	Service Factor	FL Amps @ High	FL. Eff (%)	"C" Dimension (in)	Voltage (V)	Notes
1	0.75	1800	143/5T	00118ST3QIE143T-W22	\$922	11	58	1.25	1.47	85.5	13.358	460	
		1800	143/5T	00118ST3HIE143T-W22	\$922	11	58	1.25	1.18	85.5	13.358	575	
		1200	143/5T	00112ST3QIE145T-W22	\$1,062	11	66	1.25	1.73	82.5	13.358	460	
		1200	143/5T	00112ST3HIE145T-W22	\$1,062	11	66	1.25	1.38	82.5	13.358	575	
		900	182/4T	00109ST3QIE182T-W22	\$2,006	11	97	1.25	2.30	78.5	15.860	460	
1.5	1.1	3600	143/5T	00156ST3QIE143T-W22	\$981	11	59	1.25	1.96	84.0	13.358	460	
		3600	143/5T	00156ST3HIE143T-W22	\$981	11	43	1.25	1.57	84.0	13.358	575	
		1800	143/5T	00158ST3QIE145T-W22	\$981	11	63	1.25	2.02	86.5	13.358	460	
		1800	143/5T	00158ST3HIE145T-W22	\$981	11	63	1.25	1.62	86.5	13.358	575	
		1200	182/4T	00152ST3QIE182T-W22	\$1,286	11	108	1.25	2.54	87.5	15.860	460	
		1200	182/4T	00152ST3HIE182T-W22	\$1,286	11	74	1.25	2.03	87.5	15.860	575	
		900	182/4T	00159ST3QIE184T-W22	\$2,016	11	112	1.25	2.70	82.5	15.860	460	
2	1.5	3600	143/5T	00236ST3QIE145T-W22	\$1,023	11	64	1.25	2.56	85.5	13.358	460	
		3600	143/5T	00236ST3HIE145T-W22	\$1,023	11	64	1.25	2.05	85.5	13.358	575	
		1800	143/5T	00218ST3QIE145T-W22	\$1,023	11	64	1.25	2.76	86.5	13.358	460	
		1800	143/5T	00218ST3HIE145T-W22	\$1,023	11	64	1.25	2.21	86.5	13.358	575	
		1200	182/4T	00212ST3QIE184T-W22	\$1,363	11	113	1.25	3.22	88.5	15.860	460	
		1200	182/4T	00212ST3HIE184T-W22	\$1,363	11	114	1.25	2.58	88.5	15.860	575	39
		900	213/5T	00209ST3QIE213T-W22	\$2,701	11	154	1.25	3.39	85.5	19.517	460	
3	2.2	3600	182/4T	00336ST3QIE182T-W22	\$1,267	11	109	1.25	3.63	86.5	15.860	460	
		3600	182/4T	00336ST3HIE182T-W22	\$1,267	11	108	1.25	2.90	86.5	15.860	575	
		1800	182/4T	00318ST3QIE182T-W22	\$1,224	11	106	1.25	3.91	89.5	15.860	460	
		1800	182/4T	00318ST3HIE182T-W22	\$1,224	11	104	1.25	3.13	89.5	15.860	575	
		1200	213/5T	00312ST3QIE213T-W22	\$1,537	11	173	1.25	4.41	89.5	19.517	460	
		1200	213/5T	00312ST3HIE213T-W22	\$1,537	11	173	1.25	3.53	89.5	19.517	575	
		900	213/5T	00309ST3QIE215T-W22	\$2,883	11	199	1.25	4.55	85.5	19.517	460	
5	3.7	3600	182/4T	00536ST3QIE184T-W22	\$1,429	11	116	1.25	5.90	88.5	15.860	460	
		3600	182/4T	00536ST3HIE184T-W22	\$1,429	11	116	1.25	4.72	88.5	15.860	575	
		1800	182/4T	00518ST3QIE184T-W22	\$1,371	11	115	1.25	6.45	89.5	15.860	460	
		1800	182/4T	00518ST3HIE184T-W22	\$1,371	11	115	1.25	5.16	89.5	15.860	575	
		1200	213/5T	00512ST3QIE215T-W22	\$1,901	11	191	1.25	6.83	89.5	19.517	460	
		1200	213/5T	00512ST3HIE215T-W22	\$1,901	11	191	1.25	5.46	89.5	19.517	575	
		900	254/6T	00509ST3QIE254T-W22	\$4,243	11	306	1.25	7.58	87.5	24.945	460	
7.5	5.5	3600	213/5T	00736ST3QIE213T-W22	\$1,751	11	174	1.25	8.76	89.5	19.517	460	
		3600	213/5T	00736ST3HIE213T-W22	\$1,751	11	173	1.25	7.01	89.5	19.517	575	
		1800	213/5T	00718ST3QIE213T-W22	\$1,646	11	185	1.25	9.18	91.7	19.517	460	
		1800	213/5T	00718ST3HIE213T-W22	\$1,646	11	185	1.25	7.34	91.7	19.517	575	
		1200	254/6T	00712ST3QIE254T-W22	\$2,544	11	322	1.25	9.48	91.0	24.945	460	
		1200	254/6T	00712ST3HIE254T-W22	\$2,544	11	299	1.25	7.58	91.0	24.945	575	
		900	254/6T	00709ST3QIE256T-W22	\$5,040	11	321	1.25	11.1	87.5	24.945	460	

continued on next page

Please refer to back cover for description of "NOTES"

For detailed specifications, data sheets, drawings and performance curves visit <http://www.weg.net>



TEFC - Foot Mount - continued

Three-Phase
General Purpose
Motors

HP	kW	RPM	Frame	Catalog Number	List Price	Mult. Symbol	Approx. Shipping Weight (lbs)	Service Factor	FL Amps @ High	FL Eff (%)	"C" Dimension (in)	Voltage (V)	Notes
10	7.5	3600	213/5T	01036ST3QIE215T-W22	\$1,920	I1	191	1.25	11.6	90.2	19.517	460	
		3600	213/5T	01036ST3HIE215T-W22	\$1,920	I1	191	1.25	9.28	90.2	19.517	575	
		1800	213/5T	01018ST3QIE215T-W22	\$1,760	I1	188	1.25	12.4	91.7	19.517	460	
		1800	213/5T	01018ST3HIE215T-W22	\$1,760	I1	199	1.25	9.92	91.7	19.517	575	
		1200	254/6T	01012ST3QIE256T-W22	\$2,834	I1	329	1.25	12.9	91.0	24.945	460	
		1200	254/6T	01012ST3HIE256T-W22	\$2,834	I1	329	1.25	10.3	91.0	24.945	575	
		900	284/6T	01009ST3QIE284T-W22	\$5,936	I1	380	1.25	13.4	90.2	27.929	460	
15	11	3600	254/6T	01536ST3QIE254T-W22	\$2,428	I1	303	1.25	17.2	91.0	24.945	460	
		3600	254/6T	01536ST3HIE254T-W22	\$2,428	I1	303	1.25	13.8	91.0	24.945	575	
		1800	254/6T	01518ST3QIE254T-W22	\$2,257	I1	341	1.25	18.0	92.4	24.945	460	
		1800	254/6T	01518ST3HIE254T-W22	\$2,257	I1	351	1.25	14.4	92.4	24.945	575	
		1200	284/6T	01512ST3QIE284T-W22	\$4,203	I1	430	1.25	17.9	91.7	27.929	460	
		1200	284/6T	01512ST3HIE284T-W22	\$4,203	I1	425	1.25	14.3	91.7	27.929	575	
		900	284/6T	01509ST3QIE286T-W22	\$6,742	I1	437	1.25	19.4	90.2	27.929	460	
20	15	3600	254/6T	02036ST3QIE256T-W22	\$2,957	I1	329	1.25	23.2	91.0	24.945	460	
		3600	254/6T	02036ST3HIE256T-W22	\$2,957	I1	328	1.25	18.6	91.0	24.945	575	
		1800	254/6T	02018ST3QIE256T-W22	\$2,597	I1	385	1.25	24.1	93.0	24.945	460	
		1800	254/6T	02018ST3HIE256T-W22	\$2,597	I1	400	1.25	19.3	93.0	24.945	575	
		1200	284/6T	02012ST3QIE286T-W22	\$4,773	I1	456	1.25	24.2	91.7	27.929	460	
		1200	284/6T	02012ST3HIE286T-W22	\$4,773	I1	456	1.25	19.4	91.7	27.929	575	
		900	324/6T	02009ST3QIE324T-W22	\$8,269	I1	551	1.25	28.3	91.0	31.116	460	
25	18.5	3600	284/6TS	02536ST3QIE284TS-W22	\$3,368	I1	413	1.25	28.5	91.7	26.557	460	
		3600	284/6TS	02536ST3HIE284TS-W22	\$3,368	I1	403	1.25	22.8	91.7	26.557	575	
		1800	284/6T	02518ST3QIE284T-W22	\$2,926	I1	448	1.25	29.5	93.6	27.929	460	
		1800	284/6T	02518ST3HIE284T-W22	\$2,926	I1	447	1.25	23.6	93.6	27.929	575	
		1200	324/6T	02512ST3QIE324T-W22	\$5,211	I1	588	1.25	30.4	93.0	31.116	460	
		1200	324/6T	02512ST3HIE324T-W22	\$5,211	I1	587	1.25	24.3	93.0	31.116	575	
		900	324/6T	02509ST3QIE326T-W22	\$8,838	I1	596	1.25	35.9	91.0	31.116	460	
30	22	3600	284/6TS	03036ST3QIE286TS-W22	\$3,799	I1	433	1.25	33.8	91.7	26.557	460	
		3600	284/6TS	03036ST3HIE286TS-W22	\$3,799	I1	433	1.25	27.0	91.7	26.557	575	
		1800	284/6T	03018ST3QIE286T-W22	\$3,509	I1	454	1.25	35.1	93.6	27.929	460	
		1800	284/6T	03018ST3HIE286T-W22	\$3,509	I1	484	1.25	28.1	93.6	27.929	575	
		1200	324/6T	03012ST3QIE326T-W22	\$5,359	I1	633	1.25	35.8	93.0	31.116	460	
		1200	324/6T	03012ST3HIE326T-W22	\$5,359	I1	632	1.25	28.6	93.0	31.116	575	
		900	364/5T	03009ST3QIE364T-W22	\$13,149	I1	900	1.25	37.0	92.4	34.251	460	
40	30	3600	324/6TS	04036ST3QIE324TS-W22	\$5,306	I1	591	1.25	45.8	92.4	29.616	460	
		3600	324/6TS	04036ST3HIE324TS-W22	\$5,306	I1	591	1.25	36.6	92.4	29.616	575	
		1800	324/6T	04018ST3QIE324T-W22	\$4,692	I1	590	1.25	47.1	94.1	31.116	460	
		1800	324/6T	04018ST3HIE324T-W22	\$4,692	I1	617	1.25	37.7	94.1	31.116	575	
		1200	364/5T	04012ST3QIE364T-W22	\$8,636	I1	1007	1.25	46.5	94.1	34.251	460	
		1200	364/5T	04012ST3HIE364T-W22	\$8,636	I1	1003	1.25	37.2	94.1	34.251	575	
		900	364/5T	04009ST3QIE365T-W22	\$14,909	I1	955	1.25	50.3	92.4	34.251	460	

continued on next page

Please refer to back cover for description of "NOTES"

For detailed specifications, data sheets, drawings and performance curves visit <http://www.weg.net>

Data subject to change without notice.

Can't find what you are looking for? Call 1-800-ASK-4WEG (275-4934)

IEEE 841 - Three-Phase

TEFC - Foot Mount - *continued*

Three-Phase
General Purpose
Motors

HP	kW	RPM	Frame	Catalog Number	List Price	Mult. Symbol	Approx. Shipping Weight (lbs)	Service Factor	FL Amps @ High	FL Eff (%)	"C" Dimension (in)	Voltage (V)	Notes
50	37	3600	324/6TS	05036ST3QIE326TS-W22	\$5,970	11	613	1.25	56.1	93.0	29.616	460	
		3600	324/6TS	05036ST3HIE326TS-W22	\$5,970	11	612	1.25	44.9	93.0	29.616	575	
		1800	324/6T	05018ST3QIE326T-W22	\$5,233	11	610	1.25	59.2	94.5	31.116	460	
		1800	324/6T	05018ST3HIE326T-W22	\$5,233	11	636	1.25	47.4	94.5	31.116	575	
		1200	364/5T	05012ST3QIE365T-W22	\$9,369	11	1022	1.25	57.4	94.1	34.251	460	
		1200	364/5T	05012ST3HIE365T-W22	\$9,369	11	1019	1.25	45.9	94.1	34.251	575	
		900	404/5T	05009ST3QIE404T-W22	\$19,331	11	1214	1.25	60.0	93.0	39.730	460	
60	45	3600	364/5TS	06036ST3QIE364TS-W22	\$8,665	11	965	1.25	67.0	93.6	32.338	460	
		3600	364/5TS	06036ST3HIE364TS-W22	\$8,665	11	963	1.25	53.6	93.6	32.338	575	
		1800	364/5T	06018ST3QIE364T-W22	\$8,044	11	957	1.25	68.3	95.0	34.251	460	
		1800	364/5T	06018ST3HIE364T-W22	\$8,044	11	1030	1.25	54.6	95.0	34.251	575	
		1200	404/5T	06012ST3QIE404T-W22	\$11,790	11	1253	1.25	69.5	94.5	39.730	460	
		1200	404/5T	06012ST3HIE404T-W22	\$11,790	11	1249	1.25	55.6	94.5	39.730	575	
		900	404/5T	06009ST3QIE405T-W22	\$22,579	11	1261	1.25	73.0	93.0	39.730	460	
75	55	3600	364/5TS	07536ST3QIE365TS-W22	\$10,210	11	1012	1.25	81.9	93.6	32.338	460	
		3600	364/5TS	07536ST3HIE365TS-W22	\$10,210	11	972	1.25	65.5	93.6	32.338	575	
		1800	364/5T	07518ST3QIE365T-W22	\$9,289	11	996	1.25	84.1	95.4	34.251	460	
		1800	364/5T	07518ST3QIERB365T-W22	\$10,019	11	1019	1.25	84.1	95.4	34.251	460	14
		1800	364/5T	07518ST3HIE365T-W22	\$9,289	11	1045	1.25	67.3	95.4	34.251	575	
		1200	404/5T	07512ST3QIE405T-W22	\$12,866	11	1317	1.25	84.9	94.5	39.730	460	
		1200	404/5T	07512ST3QIERB405T-W2	\$12,866	11	1326	1.25	84.9	94.5	39.730	460	14
		1200	404/5T	07512ST3HIE405T-W22	\$12,866	11	1298	1.25	67.9	94.5	39.730	575	
900	444/5T	07509ST3QIE444T-W22	\$23,457	11	1666	1.25	93.0	93.6	44.950	460			
100	75	3600	404/5TS	10036ST3QIE405TS-W22	\$12,806	11	1182	1.25	110	94.1	36.732	460	
		3600	404/5TS	10036ST3HIE405TS-W22	\$12,806	11	1191	1.25	88.0	94.1	36.732	575	
		1800	404/5T	10018ST3QIE405T-W22	\$12,471	11	1276	1.25	116	95.4	39.730	460	
		1800	404/5T	10018ST3QIERB405T-W2	\$12,471	11	1292	1.25	116	95.4	39.730	460	14
		1800	404/5T	10018ST3HIE405T-W22	\$12,471	11	1339	1.25	92.8	95.4	39.730	575	
		1800	404/5T	10018ST3HIERB405T-W2	\$12,471	11	1348	1.25	92.8	95.4	39.730	575	14
		1200	444/5T	10012ST3QIE444T-W22	\$17,933	11	1800	1.25	121	95.0	44.950	460	
		1200	444/5T	10012ST3QIERB444T-W2	\$17,933	11	1915	1.25	121	95.0	44.950	460	14
		1200	444/5T	10012ST3HIE444T-W22	\$17,933	11	1900	1.25	96.8	95.0	44.950	575	
		900	444/5T	10009ST3QIE445T-W22	\$24,681	11	1944	1.25	127	94.1	44.950	460	
900	444/5T	10009ST3QIERB445T-W2	\$24,681	11	1763	1.25	127	94.1	44.950	460	14		
125	90	3600	444/5TS	12536ST3QIE444TS-W22	\$18,198	11	1805	1.15	134	95.0	41.200	460	
		3600	444/5TS	12536ST3HIE444TS-W22	\$18,198	11	1796	1.15	107	95.0	41.200	575	
		1800	444/5T	12518ST3QIE444T-W22	\$16,564	11	1708	1.15	139	95.4	44.950	460	
		1800	444/5T	12518ST3QIERB444T-W2	\$16,564	11	1836	1.15	139	95.4	44.950	460	14
		1800	444/5T	12518ST3HIE444T-W22	\$16,564	11	1822	1.15	111	95.4	44.950	575	
		1200	444/5T	12512ST3QIE445T-W22	\$20,158	11	2016	1.15	143	95.0	44.950	460	
		1200	444/5T	12512ST3QIERB445T-W2	\$20,158	11	2028	1.15	143	95.0	44.950	460	14
		1200	444/5T	12512ST3HIE445T-W22	\$20,158	11	2013	1.15	114	95.0	44.950	575	
		900	445/7T	12509ST3QIE447T-W22	\$29,733	11	2239	1.15	151	94.5	48.701	460	
900	445/7T	12509ST3QIERB447T-W2	\$29,733	11	2273	1.15	151	94.5	48.701	460	14		

continued on next page

Please refer to back cover for description of "NOTES"

For detailed specifications, data sheets, drawings and performance curves visit <http://www.weg.net>



TEFC - Foot Mount - *continued*

Three-Phase
General Purpose
Motors

HP	kW	RPM	Frame	Catalog Number	List Price	Mult. Symbol	Approx. Shipping Weight (lbs)	Service Factor	FL Amps @ High	FL Eff (%)	"C" Dimension (in)	Voltage (V)	Notes
150	110	3600	444/5TS	15036ST3QIE445TS-W22	\$21,433	I1	1900	1.15	161	95.0	41.200	460	
		3600	444/5TS	15036ST3HIE445TS-W22	\$21,433	I1	1908	1.15	129	95.0	41.200	575	
		1800	444/5T	15018ST3QIE445T-W22	\$18,587	I1	1910	1.15	170	95.8	44.950	460	
		1800	444/5T	15018ST3QIERB445T-W2	\$18,587	I1	2041	1.15	170	95.8	44.950	460	14
		1800	444/5T	15018ST3HIE445T-W22	\$18,587	I1	2027	1.15	136	95.8	44.950	575	
		1800	444/5T	15018ST3HIERB445T-W2	\$18,587	I1	2038	1.15	136	95.8	44.950	575	14
		1200	445/7T	15012ST3QIE447T-W22	\$23,181	I1	2511	1.15	176	95.8	48.701	460	
		1200	445/7T	15012ST3QIERB447T-W2	\$23,181	I1	2543	1.15	176	95.8	48.701	460	14
		1200	445/7T	15012ST3HIE447T-W22	\$23,181	I1	2531	1.15	141	95.8	48.701	575	
		900	445/7T	15009ST3QIE447T-W22	\$34,755	I1	2409	1.15	185	94.5	48.701	460	
		900	445/7T	15009ST3QIERB447T-W2	\$34,755	I1	2421	1.15	185	94.5	48.701	460	14
200	150	3600	445/7TS	20036ST3QIE447TS-W22	\$28,568	I1	2240	1.15	219	95.4	44.951	460	
		3600	445/7TS	20036ST3HIE447TS-W22	\$28,568	I1	2209	1.15	175	95.4	44.951	575	
		1800	445/7T	20018ST3QIE447T-W22	\$23,696	I1	2320	1.15	230	96.2	48.701	460	
		1800	445/7T	20018ST3QIERB447T-W2	\$23,696	I1	2520	1.15	230	96.2	48.701	460	14
		1800	445/7T	20018ST3HIE447T-W22	\$23,696	I1	2502	1.15	184	96.2	48.701	575	
		1200	447/9T	20012ST3QIE449T-W22	\$27,577	I1	2978	1.15	237	95.8	56.338	460	
		1200	447/9T	20012ST3QIERB449T-W2	\$27,557	I1	3052	1.15	237	95.8	56.338	460	14
		1200	447/9T	20012ST3HIE449T-W22	\$27,577	I1	3030	1.15	190	95.8	56.338	575	
		1200	447/9T	20012ST3HIERB449T-W2	\$27,557	I1	3046	1.15	190	95.8	56.338	575	14
				900	L447/9T	20009ST3QIE449T-W22	\$57,394	I1	3655	1.15	242	95.0	57.181
		900	L447/9T	20009ST3QIERB449T-W2	\$57,394	I1	3669	1.15	242	95.0	57.181	460	14,43
		900	L447/9T	20009ST3HIE449T-W22	\$57,394	I1	3569	1.15	194	95.0	57.181	575	43
250	185	3600	447/9TS	25036ST3QIE449TS-W22	\$34,663	I1	2603	1.15	266	95.8	52.940	460	
		1800	447/9T	25018ST3QIE449T-W22	\$30,081	I1	2904	1.15	281	96.2	56.338	460	
		1800	447/9T	25018ST3QIERB449T-W2	\$30,081	I1	2869	1.15	281	96.2	56.338	460	14
		1200	447/9T	25012ST3QIE449T-W22	\$39,415	I1	3190	1.15	292	95.8	56.338	460	
		1200	447/9T	25012ST3QIERB449T-W2	\$39,415	I1	2702	1.15	292	95.8	56.338	460	14
300	220	1800	447/9T	30018ST3QIE449T-W22	\$36,810	I1	3102	1.15	330	96.2	56.338	460	
		1800	447/9T	30018ST3QIERB449T-W2	\$36,810	I1	3130	1.15	330	96.2	56.338	460	14
		1200	L447/9T	30012ST3QIE449T-W22	\$44,648	I1	3645	1.15	351	95.8	57.181	460	43
		1200	L447/9T	30012ST3QIERB449T-W2	\$44,648	I1	3571	1.15	351	95.8	57.181	460	14,43
350	260	1800	L447/9T	35018ST3QIE449T-W22	\$44,105	I1	3580	1.15	394	96.2	57.181	460	43
		1800	L447/9T	35018ST3QIERB449T-W2	\$44,105	I1	3580	1.15	394	96.2	57.181	460	14,43
		1200	L447/9T	35012ST3QIE449T-W22	\$52,634	I1	3824	1.15	415	95.8	57.181	460	43, 37
		1200	L447/9T	35012ST3QIERB449T-W2	\$52,634	I1	3756	1.15	415	95.8	57.181	460	14,43
400	300	1800	L447/9T	40018ST3QIE449T-W22	\$48,396	I1	3467	1.15	455	96.2	57.181	460	43
		1800	L447/9T	40018ST3QIERB449T-W2	\$48,396	I1	3467	1.15	455	96.2	57.181	460	14,43

Please refer to back cover for description of "NOTES"

For detailed specifications, data sheets, drawings and performance curves visit <http://www.weg.net>

Data subject to change without notice.

Can't find what you are looking for? Call 1-800-ASK-4WEG (275-4934)

Three-Phase General Purpose Motors



IEEE 841 - Three-Phase

TEFC - C-Face - Foot Mount

Three-Phase
General Purpose
Motors

HP	kW	RPM	Frame	Catalog Number	List Price	Mult. Symbol	Approx. Shipping Weight (lbs)	Service Factor	FL Amps @ High	FL. Eff (%)	"C" Dimension (in)	Voltage (V)	Notes
1	0.75	1800	143/5TC	00118ST3QIE143TC-W22	\$972	I1	55	1.25	1.47	85.5	13.358	460	
		1200	143/5TC	00112ST3QIE145TC-W22	\$1,112	I1	63	1.25	1.73	82.5	13.358	460	
1.5	1.1	3600	143/5TC	00156ST3QIE143TC-W22	\$1,031	I1	57	1.25	1.96	84.0	13.358	460	
		1800	143/5TC	00158ST3QIE145TC-W22	\$1,031	I1	61	1.25	2.02	86.5	13.358	460	
		1200	182/4TC	00152ST3QIE182TC-W22	\$1,351	I1	112	1.25	2.54	87.5	15.860	460	
		900	182/4TC	00159ST3QIE184TC-W22	\$2,081	I1	116	1.25	2.70	82.5	15.860	460	
2	1.5	3600	143/5TC	00236ST3QIE145TC-W22	\$1,073	I1	62	1.25	2.56	85.5	13.358	460	
		1800	143/5TC	00218ST3QIE145TC-W22	\$1,073	I1	62	1.25	2.76	86.5	13.358	460	
		1200	182/4TC	00212ST3QIE184TC-W22	\$1,428	I1	117	1.25	3.22	88.5	15.860	460	39
		900	213/5TC	00209ST3QIE213TC-W22	\$2,781	I1	185	1.25	3.39	85.5	19.517	460	
3	2.2	3600	182/4TC	00336ST3QIE182TC-W22	\$1,332	I1	113	1.25	3.63	86.5	15.860	460	
		1800	182/4TC	00318ST3QIE182TC-W22	\$1,289	I1	109	1.25	3.91	89.5	15.860	460	
		1200	213/5TC	00312ST3QIE213TC-W22	\$1,617	I1	178	1.25	4.41	89.5	19.517	460	
		900	213/5TC	00309ST3QIE215TC-W22	\$2,963	I1	181	1.25	4.55	85.5	19.517	460	
5	3.7	3600	182/4TC	00536ST3QIE184TC-W22	\$1,494	I1	120	1.25	5.90	88.5	15.860	460	
		1800	182/4TC	00518ST3QIE184TC-W22	\$1,436	I1	119	1.25	6.45	89.5	15.860	460	
		1200	213/5TC	00512ST3QIE215TC-W22	\$1,981	I1	194	1.25	6.83	89.5	19.517	460	
		900	254/6TC	00509ST3QIE254TC-W22	\$4,363	I1	309	1.25	7.58	87.5	24.945	460	
7.5	5.5	3600	213/5TC	00736ST3QIE213TC-W22	\$1,831	I1	177	1.25	8.76	89.5	19.517	460	
		1800	213/5TC	00718ST3QIE213TC-W22	\$1,726	I1	189	1.25	9.18	91.7	19.517	460	
		1200	254/6TC	00712ST3QIE254TC-W22	\$2,664	I1	325	1.25	9.48	91.0	24.945	460	
		900	254/6TC	00709ST3QIE256TC-W22	\$5,160	I1	321	1.25	11.1	87.5	24.945	460	
10	7.5	3600	213/5TC	01036ST3QIE215TC-W22	\$2,000	I1	195	1.25	11.6	90.2	19.517	460	
		1800	213/5TC	01018ST3QIE215TC-W22	\$1,840	I1	203	1.25	12.4	91.7	19.517	460	
		1200	254/6TC	01012ST3QIE256TC-W22	\$2,954	I1	340	1.25	12.9	91.0	24.945	460	
		900	284/6TC	01009ST3QIE284TC-W22	\$6,136	I1	400	1.25	13.4	90.2	27.929	460	
15	11	3600	254/6TC	01536ST3QIE254TC-W22	\$2,548	I1	306	1.25	17.2	91.0	24.945	460	
		1800	254/6TC	01518ST3QIE254TC-W22	\$2,377	I1	355	1.25	18.0	92.4	24.945	460	
		1200	284/6TC	01512ST3QIE284TC-W22	\$4,403	I1	434	1.25	17.9	91.7	27.929	460	
		900	284/6TC	01509ST3QIE286TC-W22	\$6,942	I1	444	1.25	19.4	90.2	27.929	460	
20	15	3600	254/6TC	02036ST3QIE256TC-W22	\$3,077	I1	332	1.25	23.2	91.0	24.945	460	
		1800	254/6TC	02018ST3QIE256TC-W22	\$2,717	I1	404	1.25	24.1	93.0	24.945	460	
		1200	284/6TC	02012ST3QIE286TC-W22	\$4,973	I1	465	1.25	24.2	91.7	27.929	460	
		900	324/6TC	02009ST3QIE324TC-W22	\$8,494	I1	482	1.25	28.3	91.0	31.116	460	
25	18.5	3600	284/6TSC	02536ST3QIE284TSC-W2	\$3,568	I1	389	1.25	28.5	91.7	26.557	460	
		1800	284/6TC	02518ST3QIE284TC-W22	\$3,126	I1	456	1.25	29.5	93.6	27.929	460	
		1200	324/6TC	02512ST3QIE324TC-W22	\$5,436	I1	603	1.25	30.4	93.0	31.116	460	
		900	324/6TC	02509ST3QIE326TC-W22	\$9,063	I1	539	1.25	35.9	91.0	31.116	460	
30	22	3600	284/6TSC	03036ST3QIE286TSC-W2	\$3,999	I1	441	1.25	33.8	91.7	26.557	460	
		1800	284/6TC	03018ST3QIE286TC-W22	\$3,709	I1	493	1.25	35.1	93.6	27.929	460	
		1200	324/6TC	03012ST3QIE326TC-W22	\$5,584	I1	646	1.25	35.8	93.0	31.116	460	
		900	364/5TC	03009ST3QIE364TC-W22	\$13,524	I1	917	1.25	37.0	92.4	34.251	460	

continued on next page

Please refer to back cover for description of "NOTES"

For detailed specifications, data sheets, drawings and performance curves visit <http://www.weg.net>

TEFC - C-Face - Foot Mount - *continued*

HP	kW	RPM	Frame	Catalog Number	List Price	Mult. Symbol	Approx. Shipping Weight (lbs)	Service Factor	FL Amps @ High	FL Eff (%)	"C" Dimension (in)	Voltage (V)	Notes
40	30	3600	324/6TSC	04036ST3QIE324TSC-W2	\$5,531	I1	602	1.25	45.8	92.4	29.616	460	
		1800	324/6TC	04018ST3QIE324TC-W22	\$4,917	I1	633	1.25	47.1	94.1	31.116	460	
		1200	364/5TC	04012ST3QIE364TC-W22	\$9,011	I1	1032	1.25	46.5	94.1	34.251	460	
		900	364/5TC	04009ST3QIE365TC-W22	\$15,284	I1	990	1.25	50.3	92.4	34.251	460	
50	37	3600	324/6TSC	05036ST3QIE326TSC-W2	\$6,195	I1	627	1.25	56.1	93.0	29.616	460	
		1800	324/6TC	05018ST3QIE326TC-W22	\$5,458	I1	651	1.25	59.2	94.5	31.116	460	
		1200	364/5TC	05012ST3QIE365TC-W22	\$9,744	I1	983	1.25	57.4	94.1	34.251	460	
		900	404/5TC	05009ST3QIE404TC-W22	\$19,856	I1	1132	1.25	60.0	93.0	39.730	460	
60	45	1200	404/5TC	06012ST3QIE404TC-W22	\$12,315	I1	1156	1.25	69.5	94.5	39.730	460	



TEFC - C-Face - Footless

HP	kW	RPM	Frame	Catalog Number	List Price	Mult. Symbol	Approx. Shipping Weight (lbs)	Service Factor	FL Amps @ High	FL Eff (%)	"C" Dimension (in)	Voltage (V)	Notes
1	0.75	1800	143/5TC	00118ST3QIER143TC-W2	\$1,000	I1	54	1.25	1.47	85.5	14.066	460	15
1.5	1.1	1800	143/5TC	00158ST3QIER145TC-W2	\$1,061	I1	62	1.25	2.02	86.5	14.066	460	15
2	1.5	1800	143/5TC	00218ST3QIER145TC-W2	\$1,104	I1	63	1.25	2.76	86.5	14.066	460	15
3	2.2	1800	182/4TC	00318ST3QIER182TC-W2	\$1,326	I1	110	1.25	3.91	89.5	17.080	460	15,39
5	3.7	1800	182/4TC	00518ST3QIER184TC-W2	\$1,478	I1	119	1.25	6.45	89.5	17.080	460	15
7.5	5.5	1800	213/5TC	00718ST3QIER213TC-W2	\$1,776	I1	177	1.25	9.18	91.7	21.269	460	15
10	7.5	1800	213/5TC	01018ST3QIER215TC-W2	\$1,893	I1	192	1.25	12.4	91.7	21.269	460	15

Please refer to back cover for description of "NOTES"

For detailed specifications, data sheets, drawings and performance curves visit <http://www.weg.net>

Data subject to change without notice.

Can't find what you are looking for? Call 1-800-ASK-4WEG (275-4934)

Three-Phase General Purpose Motors

BRAKE MOTORS

TEFC - Three-Phase - NEMA Premium®

WEG W22 brake motors consist of an induction motor coupled to a disc brake. Brake is of sturdy construction with few moving parts which guarantees long durability and minimum maintenance.



Standard Features:

- Class F insulation (Impregnation Resin and Magnet wire are class H)
- 230V Brake Rectifier
- F1 Mounted
- Stainless Steel Nameplate - Laser etched with high contrast background
- Regreasable ball bearings (Frames 254T and up)
- 60HZ - 50HZ available with custom build

Note: If separate power supply to the Brake is required, (Such as on Motors operating with Variable Frequency Drive), 230V to the Brake module is standard.

Features that make a difference:

- 1.25 Service Factor
- NPT Threaded terminal box
- Armature type brake
- Manual Release

Inverter Rated:
1000:1 for variable torque
20:1 for constant torque

Optional Feature:

460V brake rectifier is available with motor modification

Brake Torques

Frame	N.m	lb.ft	Optional lb.ft
143/5T	16	12	17
182/4T	60	44	N/A
213/5T	125	59	92
254/6T	235	111	173
284/6T	400	192	254





Three-Phase General Purpose Motors

CAST IRON BRAKE MOTORS

TEFC – Foot Mount

Three-Phase
General Purpose
Motors

HP	kW	RPM	Frame	Catalog Number	List Price	Mult. Symbol	Approx. Shipping Weight (lbs)	Service Factor	FL Amps @ High	FL. Eff (%)	"C" Dimension (in)	Voltage (V)	Notes
1	0.75	1800	143/5T	00118ET3EBM143T-W22	\$1,494	B1	59	1.25	1.47	85.5	16.231	230/460	25
		1800	143/5T	00118ET3HBM143T-W22	\$1,494	B1	62	1.25	1.18	85.5	16.231	575	25
		1200	143/5T	00112ET3EBM145T-W22	\$1,587	B1	66	1.25	1.73	82.5	16.231	230/460	25
		900	182/4T	00109ET3EBM182T-W22	\$2,594	B1	126	1.25	2.30	78.5	19.314	230/460	25
1.5	1.1	3600	143/5T	00156ET3EBM143T-W22	\$1,501	B1	73	1.25	1.96	84.0	16.231	230/460	25
		1800	143/5T	00158ET3EBM145T-W22	\$1,569	B1	65	1.25	2.02	86.5	16.231	230/460	25
		1200	182/4T	00152ET3EBM182T-W22	\$2,264	B1	117	1.25	2.54	87.5	19.314	230/460	25
		900	182/4T	00159ET3EBM184T-W22	\$2,703	B1	156	1.25	2.70	82.5	19.314	230/460	25
2	1.5	3600	143/5T	00236ET3EBM145T-W22	\$1,501	B1	62	1.25	2.56	85.5	16.231	230/460	25
		1800	143/5T	00218ET3EBM145T-W22	\$1,594	B1	66	1.25	2.76	86.5	16.231	230/460	25
		1200	182/4T	00212ET3EBM184T-W22	\$2,369	B1	122	1.25	3.23	88.5	19.314	230/460	25
		900	213/5T	00209ET3EBM213T-W22	\$3,345	B1	217	1.25	3.39	85.5	23.188	230/460	25
3	2.2	3600	182/4T	00336ET3EBM182T-W22	\$2,290	B1	140	1.25	3.63	86.5	19.314	230/460	25
		1800	182/4T	00318ET3EBM182T-W22	\$2,052	B1	115	1.25	3.91	89.5	19.314	230/460	25
		1200	213/5T	00312ET3EBM213T-W22	\$3,220	B1	196	1.25	4.41	89.5	23.188	230/460	25
		900	213/5T	00309ET3EBM215T-W22	\$3,740	B1	259	1.25	4.55	85.5	23.188	230/460	25
5	3.7	3600	182/4T	00536ET3EBM184T-W22	\$2,343	B1	126	1.25	5.90	88.5	19.314	230/460	25
		1800	182/4T	00518ET3EBM184T-W22	\$2,291	B1	124	1.25	6.45	89.5	19.314	230/460	25
		1800	182/4T	00518ET3HBM184T-W22	\$2,291	B1	124	1.25	5.16	89.5	19.314	575	25
		1200	213/5T	00512ET3EBM215T-W22	\$3,406	B1	213	1.25	6.83	89.5	23.188	230/460	25
		900	254/6T	00509ET3EBM254T-W22	\$5,641	B1	358	1.25	7.58	87.5	29.839	230/460	25
7.5	5.5	3600	213/5T	00736ET3EBM213T-W22	\$3,002	B1	200	1.25	8.76	89.5	23.188	230/460	25
		1800	213/5T	00718ET3EBM213T-W22	\$2,903	B1	215	1.25	9.18	91.7	23.188	230/460	25
		1200	254/6T	00712ET3EBM254T-W22	\$5,172	B1	377	1.25	9.48	91.0	29.839	230/460	25
		900	254/6T	00709ET3EBM256T-W22	\$6,415	B1	377	1.25	11.1	87.5	29.839	230/460	25
10	7.5	3600	213/5T	01036ET3EBM215T-W22	\$3,492	B1	238	1.25	11.6	90.2	23.188	230/460	25
		1800	213/5T	01018ET3EBM215T-W22	\$3,474	B1	221	1.25	12.4	91.7	23.188	230/460	25
		1800	213/5T	01018ET3HBM215T-W22	\$3,474	B1	200	1.25	9.92	91.7	23.188	575	25
		1200	254/6T	01012ET3EBM256T-W22	\$5,759	B1	367	1.25	12.9	91.0	29.839	230/460	25
15	11	3600	254/6T	01536ET3EBM254T-W22	\$4,745	B1	384	1.25	17.2	91.0	29.839	230/460	25
		1800	254/6T	01518ET3EBM254T-W22	\$5,205	B1	407	1.25	18.0	92.4	29.839	230/460	25
		1800	254/6T	01518ET3HBM254T-W22	\$5,205	B1	369	1.25	14.4	92.4	29.839	575	25
20	15	3600	254/6T	02036ET3EBM256T-W22	\$5,768	B1	424	1.25	23.2	91.0	29.839	230/460	25
		1800	254/6T	02018ET3EBM256T-W22	\$5,771	B1	456	1.25	24.1	93.0	29.839	230/460	25
25	18.5	1800	284/6T	02518ET3EBM284T-W22	\$6,796	B1	520	1.25	29.5	93.6	32.976	230/460	25
30	22	1800	284/6T	03018ET3EBM286T-W22	\$7,276	B1	558	1.25	35.1	93.6	32.976	230/460	25

Please refer to back cover for description of "NOTES"

For detailed specifications, data sheets, drawings and performance curves visit <http://www.weg.net>

Data subject to change without notice.

Can't find what you are looking for? Call 1-800-ASK-4WEG (275-4934)

ROLLED STEEL BRAKE MOTORS

Spring-Set brake (Solenoid Actuated)

Standard Features:

- 1.15 Service Factor
- Manual Release Lever
- AC brake
- Inverter Rated
- IP55 Enclosure
- Dual Frequency (50/60 Hz)

Applications:

- Conveyors
- Door Operators
- Packaging Equipment
- Unit Handling



Please refer to back cover for description of "NOTES"

For detailed specifications, data sheets, drawings and performance curves visit <http://www.weg.net>



Three-Phase General Purpose Motors



ROLLED STEEL BRAKE MOTORS

TEFC - Foot Mount

Three-Phase
General Purpose
Motors

HP	kW	RPM	Frame	Catalog Number	List Price	Mult Symbol	Approx. Shipping Weight (lbs)	Brake Torque (ft.lb)	FL. Amps @ High	FL. Eff (%)	"C" Dimension (in)	Volts	Notes
0.25	0.18	1800	W56	.2518ES3EBMW56-S	\$928	RSB	24	3	0.50	66.0	14.610	208-230/460	9
0.33	0.25	1800	W56	.3318ES3EBMW56-S	\$977	RSB	26	3	0.66	68.0	14.610	208-230/460	9
0.5	0.37	1800	W56	.5018ES3EBMW56-S	\$1,105	RSB	27	3	1.00	72.0	15.004	208-230/460	9
0.75	0.55	1800	W56	.7518ES3EBMW56-S	\$1,301	RSB	38	6	1.22	75.5	15.397	208-230/460	9
1	0.75	1800	56	00118ET3EBM56-S	\$1,504	RSB	54	6	1.47	85.5	17.835	230/460	9
		1800	143T	00118ET3EBM143T-S	\$1,729	RSB	55	6	1.47	85.5	17.914	230/460	9
1.5	1.1	1800	145T	00158ET3EBM145T-S	\$1,866	RSB	56	10	2.02	86.5	17.914	230/460	9
2	1.5	1800	145T	00218ET3EBM145T-S	\$1,921	RSB	60	10	2.72	86.5	18.307	230/460	9
3	2.2	1800	182T	00318ET3EBM182T-S	\$2,117	RSB	113	15	3.81	89.5	22.992	230/460	9
5	3.7	1800	184T	00518ET3EBM184T-S	\$2,492	RSB	91	25	6.49	89.5	22.992	230/460	9
7.5	5.5	1800	213T	00718ET3EBM213T-S	\$4,563	RSB	151	35	9.07	91.7	26.457	230/460	9
10	7.5	1800	215T	01018ET3EBM215T-S	\$4,989	RSB	165	50	12.2	91.7	26.850	230/460	9
15	11	1800	254T	01518ET3EBM254T-S	\$6,985	RSB	256	75	18.2	92.4	31.220	230/460	9
20	15	1800	256T	02018ET3EBM256T-S	\$9,080	RSB	291	100	24.7	93.0	32.007	230/460	9

Please refer to back cover for description of "NOTES"

For detailed specifications, data sheets, drawings and performance curves visit <http://www.weg.net>

Data subject to change without notice.

Can't find what you are looking for? Call 1-800-ASK-4WEG (275-4934)

Three-Phase General Purpose Motors



ROLLED STEEL BRAKE MOTORS

Three-Phase
General Purpose
Motors



TEFC - C-Face - Foot Mount

HP	kW	RPM	Frame	Catalog Number	List Price	Mult Symbol	Approx. Shipping Weight (lbs)	Brake Torque (ft.lb)	FL. Amps @ High	FL. Eff (%)	"C" Dimension (in)	Volts	Notes
1	0.75	1800	56C	00118ET3EBM56C-S	\$1,542	RSB	54	6	1.47	85.5	17.835	230/460	9
		1800	143TC	00118ET3EBM143TC-S	\$1,767	RSB	55	6	1.47	85.5	17.914	230/460	9
1.5	1.1	1800	145TC	00158ET3EBM145TC-S	\$1,904	RSB	56	10	2.02	86.5	17.914	230/460	9
2	1.5	1800	145TC	00218ET3EBM145TC-S	\$1,959	RSB	60	10	2.72	86.5	18.307	230/460	9
3	2.2	1800	182TC	00318ET3EBM182TC-S	\$2,189	RSB	113	15	3.81	89.5	22.992	230/460	9
5	3.7	1800	184TC	00518ET3EBM184TC-S	\$2,564	RSB	91	25	6.49	89.5	22.992	230/460	9
7.5	5.5	1800	213TC	00718ET3EBM213TC-S	\$4,702	RSB	151	35	9.07	91.7	26.457	230/460	9
10	7.5	1800	215TC	01018ET3EBM215TC-S	\$5,128	RSB	165	50	12.2	91.7	26.850	230/460	9



TEFC - C-Face - Footless

HP	kW	RPM	Frame	Catalog Number	List Price	Mult Symbol	Approx. Shipping Weight (lbs)	Brake Torque (ft.lb)	FL. Amps @ High	FL. Eff (%)	"C" Dimension (in)	Volts	Notes
0.25	0.18	1800	W56C	.2518ES3EBMW56CFL-S	\$966	RSB	24	3	0.50	66.0	14.610	208-230/460	9
0.33	0.25	1800	W56C	.3318ES3EBMW56CFL-S	\$1,015	RSB	26	3	0.66	68.0	14.610	208-230/460	9
0.5	0.37	1800	W56C	.5018ES3EBMW56CFL-S	\$1,143	RSB	27	3	1.00	72.0	15.004	208-230/460	9
0.75	0.55	1800	W56C	.7518ES3EBMW56CFL-S	\$1,339	RSB	38	6	1.22	75.5	15.397	208-230/460	9
1	0.75	1800	56C	00118ET3EBM56CFL-S	\$1,542	RSB	54	6	1.47	85.5	17.835	230/460	9
		1800	143TC	00118ET3EBMR143TC-S	\$1,767	RSB	55	6	1.47	85.5	17.914	230/460	9
1.5	1.1	1800	145TC	00158ET3EBMR145TC-S	\$1,904	RSB	56	10	2.02	86.5	17.914	230/460	9
2	1.5	1800	145TC	00218ET3EBMR145TC-S	\$1,959	RSB	60	10	2.72	86.5	18.307	230/460	9
3	2.2	1800	182TC	00318ET3EBMR182TC-S	\$2,189	RSB	113	15	3.81	89.5	22.992	230/460	9
5	3.7	1800	184TC	00518ET3EBMR184TC-S	\$2,564	RSB	91	25	6.49	89.5	22.992	230/460	9
7.5	5.5	1800	213TC	00718ET3EBMR213TC-S	\$4,702	RSB	151	35	9.07	91.7	26.457	230/460	9
10	7.5	1800	215TC	01018ET3EBMR215TC-S	\$5,128	RSB	165	50	12.2	91.7	26.850	230/460	9

Please refer to back cover for description of "NOTES"

For detailed specifications, data sheets, drawings and performance curves visit <http://www.weg.net>



The Superior Choice for **HEAVY INDUSTRIAL** Applications



Low and Medium Voltage Motors and Drives

Large end users demand WEG products by name because they know WEG meets or exceeds the toughest specifications for Heavy Industrial applications.

Three-Phase General Purpose Motors

IEC TRU-METRIC™ - Three Phase

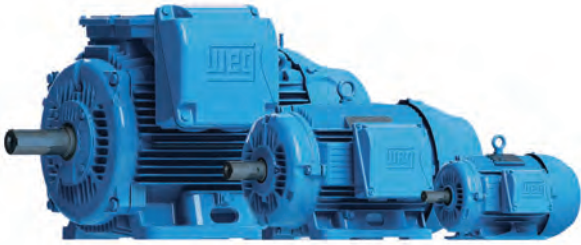

W22 Cast Iron



Aluminum

TEFC

This line is designed and built according to European IEC34 and IEC79 standards.

Standard Features:

- 60 Hz (1.15 Service Factor) and 50 Hz (1.0 Service Factor)
- Class F insulation (Impregnation Resin and Magnet wire are class H)
- F2 mounted as standard (F1 convertible)
- Stainless Steel Nameplate - Laser etched with High contrast background
- Regreasable ball bearings (Frames 160 and up)
- Gasketed conduit box
- Class I, Div. 2, Groups A, B, C & D – T3, Class II, Div 2, Groups F & G – T3C (Cast Iron Frames only)
- Suitable for WYE/Delta Start (W and Y voltage code motors)

Features that make a difference:

- 1.25 Service Factor for 60 Hz operation (IE3)
- Optimized ventilation system for cooler operation and lower noise levels
- Solid base for lower vibration levels (Cast Iron Frames)
- Frames 225 and up can easily be F1 (B3L) converted by rotating the terminal box adapter or F3 by removing it
- Aluminum frames have removable feet for easy F1, F2 and F3 (B3L, B3R, B3T) conversion
- Terminal blocks

ADDITIONAL TECHNICAL DATA

ELECTRICAL DATA: B-46

MECHANICAL DATA: B-113

*Inverter Rated:

1000:1 for variable torque

12:1 for constant torque

Excludes 660-690V

** Insulated NDE bearing housing standard on 315L and above*





Three-Phase General Purpose Motors

IEC TRU-Metric™

TEFC - Foot Mount

Three-Phase
General Purpose
Motors

HP	kW	RPM	Frame	Catalog Number	List Price	Mult. Symbol	Approx. Shipping Weight (lbs)	Service Factor	FL Amps @ High	FL Eff (%)	"C" Dimension (in)	Voltage (V)	Notes
0.25	0.18	3600//3000	63	.1836EP3EAL63-W22	\$280	T1	14	1.15	0.48	68.0	8.504	230/460//190/380	2,7
		1800//1500	63	.1818EP3EAL63-W22	\$267	T1	16	1.15	0.51	69.0	8.504	230/460//190/380	2,7
		1200//1000	71	.1812EP3EAL71-W22	\$338	T1	22	1.15	0.77	61.0	9.764	230/460//190/380	2,7
		900//750	80	.1809EP3EAL80-W22	\$540	T1	30	1.15	0.80	50.5	10.866	230/460//190/380	2,7
		900//750	80	.1809EP3WAL80-W22	\$540	T1	28	1.15	0.80	50.5	10.866	460//220-240/380-415	2,7
0.33	0.25	3600//3000	63	.2536EP3EAL63-W22	\$286	T1	16	1.15	0.62	70.0	8.504	230/460//190/380	2,7
		1800//1500	71	.2518EP3EAL71-W22	\$282	T1	24	1.15	0.68	73.0	9.764	230/460//190/380	2,7
		1200//1000	71	.2512EP3EAL71-W22	\$363	T1	24	1.15	1.00	64.0	9.764	230/460//190/380	2,7
		900//750	80	.2509EP3EAL80-W22	\$583	T1	29	1.15	0.87	57.5	10.866	230/460//190/380	2,7
		900//750	80	.2509EP3WAL80-W22	\$583	T1	32	1.15	0.87	57.5	10.866	460//220-240/380-415	2,7
0.5	0.37	3600//3000	71	.3736EP3EAL71-W22	\$309	T1	22	1.15	0.83	73.0	9.764	230/460//190/380	2,7
		1800//1500	71	.3718EP3EAL71-W22	\$290	T1	24	1.15	1.06	73.0	9.764	230/460//190/380	2,7
		1200//1000	80	.3712EP3EAL80-W22	\$378	T1	27	1.15	1.07	64.0	10.866	230/460//190/380	2,7
		900//750	90S/L	.3709EP3EAL90S-W22	\$662	T1	40	1.15	1.35	61.5	12.953	230/460//190/380	2,7
		900//750	90S/L	.3709EP3WAL90S/L-W22	\$662	T1	40	1.15	1.35	61.5	12.953	460//220-240/380-415	2,7
0.75	0.55	3600//3000	71	.5536EP3EAL71-W22	\$316	T1	23	1.15	1.14	76.0	9.764	230/460//190/380	2,7
		1800//1500	80	.5518EP3EAL80-W22	\$333	T1	28	1.15	1.25	77.0	10.866	230/460//190/380	2,7
		1200//1000	80	.5512EP3EAL80-W22	\$405	T1	32	1.15	1.63	66.0	10.866	230/460//190/380	2,7
		900//750	90S/L	.5509EP3EAL90L-W22	\$696	T1	46	1.15	2.12	62.5	12.953	230/460//190/380	2,7
		900//750	90S/L	.5509EP3WAL90S/L-W22	\$696	T1	58	1.15	2.12	62.5	12.953	460//220-240/380-415	2,7
1	0.75	3600//3000	80	.7536ET3WAL80-W22	\$397	T1	27	1.25	1.43	81.5	10.866	460//220-240/380-415	2,7
		1800//1500	90S/L	.7518ET3EAL90S/L-W22	\$420	T1	42	1.25	1.47	85.5	12.953	230/460//190/380	2,7
		1800//1500	90S/L	.7518ET3WAL90S/L-W22	\$420	T1	43	1.25	1.47	85.5	12.953	460//220-240/380-415	2,7
		1200//1000	90S/L	.7512ET3EAL90S-W22	\$537	T1	47	1.25	1.68	82.5	12.953	230/460//190/380	2,7
		1200//1000	90S/L	.7512ET3WAL90S-W22	\$537	T1	51	1.25	1.68	82.5	12.953	460//220-240/380-415	2,7
		900//750	100L	.7509ET3EAL100L-W22	\$869	T1	68	1.25	2.11	75.5	14.803	230/460//190/380	2,7
1.5	1.1	3600//3000	80	00136ET3EAL80-W22	\$444	T1	29	1.25	2.03	84.0	10.866	230/460//190/380	2,7
		3600//3000	80	00136ET3WAL80-W22	\$444	T1	30	1.25	2.03	84.0	10.866	460//220-240/380-415	2,7
		1800//1500	90S/L	00118ET3EAL90S-W22	\$470	T1	44	1.25	2.05	86.5	12.953	230/460//190/380	2,7
		1800//1500	90S/L	00118ET3WAL90S-W22	\$470	T1	44	1.25	2.05	86.5	12.953	460//220-240/380-415	2,7
		1200//1000	100L	00112ET3EAL100L-W22	\$746	T1	80	1.00	2.32	87.5	14.803	230/460//190/380	2,7
2	1.5	3600//3000	90S/L	00156ET3EAL90S-W22	\$504	T1	44	1.25	2.69	85.5	12.953	230/460//190/380	2,7
		3600//3000	90S/L	00156ET3WAL90S-W22	\$504	T1	44	1.25	2.69	85.5	12.953	460//220-240/380-415	2,7
		1800//1500	90S/L	00158ET3EAL90L-W22	\$524	T1	49	1.25	2.79	86.5	12.953	230/460//190/380	2,7
		1800//1500	90S/L	00158ET3WAL90L-W22	\$524	T1	49	1.25	2.79	86.5	12.953	460//220-240/380-415	2,7
		1200//1000	100L	00152ET3WAL100L-W22	\$812	T1	76	1.25	3.13	88.5	16.535	460//220-240/380-415	2,7
		1200//1000	112M	00152ET3EAL112M-W22	\$923	T1	93	1.25	3.08	88.5	15.472	230/460//190/380	2,7
		1200//1000	112M	00152ET3WAL112M-W22	\$923	T1	93	1.25	3.08	88.5	15.472	460//220-240/380-415	2,7
		900//750	112M	00159ET3YAL112M-W22	\$1,001	T1	90	1.25	3.50	84.0	15.472	460//380-415/660-690	2,7
3	2.2	3600//3000	90S/L	00236ET3EAL90L-W22	\$756	T1	50	1.25	3.85	86.5	12.953	230/460//190/380	2,7
		3600//3000	90S/L	00236ET3WAL90L-W22	\$756	T1	49	1.25	3.85	86.5	12.953	460//220-240/380-415	2,7
		1800//1500	100L	00218ET3EAL100L-W22	\$630	T1	66	1.25	4.11	89.5	14.803	230/460//190/380	2,7
		1800//1500	100L	00218ET3WAL100L-W22	\$630	T1	66	1.25	4.11	89.5	14.803	460//220-240/380-415	2,7
		1200//1000	132S	00212ET3EAL132S-W22	\$1,166	T1	131	1.25	4.41	89.5	19.291	230/460//190/380	2,7
		1200//1000	132S	00212ET3YAL132S-W22	\$1,166	T1	136	1.25	4.41	89.5	19.291	460//380-415/660-690	2,7
		900//750	132S	00209ET3YAL132S-W22	\$1,412	T1	145	1.25	4.75	85.5	19.291	460//380-415/660-690	2,7

continued on next page

Refer to electrical and mechanical data sections for additional technical information. Please refer to back cover for description of "NOTES"

For detailed specifications, data sheets, drawings and performance curves visit <http://www.weg.net>

Data subject to change without notice.

Can't find what you are looking for? Call 1-800-ASK-4WEG (275-4934)

A-75

Three-Phase General Purpose Motors



IEC TRU-Metric™

TEFC - Foot Mount - continued

Three-Phase
General Purpose
Motors

HP	kW	RPM	Frame	Catalog Number	List Price	Mult. Symbol	Approx. Shipping Weight (lbs)	Service Factor	FL Amps @ High	FL Eff (%)	"C" Dimension (in)	Voltage (V)	Notes
4	3	3600//3000	100L	00336ET3EAL100L-W22	\$805	T1	65	1.25	5.01	88.5	14.803	230/460//190/380	2,7
		3600//3000	100L	00336ET3WAL100L-W22	\$805	T1	65	1.25	5.01	88.5	14.803	460//220-240/380-415	2,7
		1800//1500	100L	00318ET3EAL100L-W22	\$672	T1	77	1.25	5.33	89.5	14.803	230/460//190/380	2,7
		1800//1500	100L	00318ET3WAL100L-W22	\$672	T1	77	1.25	5.33	89.5	14.803	460//220-240/380-415	2,7
		1200//1000	132M	00312ET3EAL132M-W22	\$1,247	T1	137	1.25	6.01	89.5	19.291	230/460//190/380	2,7
		1200//1000	132M	00312ET3YAL132M-W22	\$1,247	T1	147	1.25	6.01	89.5	19.291	460//380-415/660-690	2,7
		900//750	132M	00309ET3EAL132M-W22	\$1,610	T1	193	1.25	6.29	85.5	19.291	230/460//190/380	2,7
		900//750	132M	00309ET3YAL132M-W22	\$1,610	T1	156	1.25	6.29	85.5	19.291	460//380-415/660-690	2,7
5.5	4	3600//3000	112M	00436ET3EAL112M-W22	\$874	T1	86	1.25	6.67	88.5	15.472	230/460//190/380	2,7
		3600//3000	112M	00436ET3YAL112M-W22	\$874	T1	86	1.25	6.67	88.5	15.472	460//380-415/660-690	2,7
		1800//1500	112M	00418ET3EAL112M-W22	\$679	T1	93	1.25	7.28	89.5	15.472	230/460//190/380	2,7
		1800//1500	112M	00418ET3YAL112M-W22	\$679	T1	93	1.25	7.28	89.5	15.472	460//380-415/660-690	2,7
		1200//1000	132M	00412ET3EAL132M-W22	\$1,254	T1	147	1.25	7.90	89.5	19.291	230/460//190/380	2,7
		1200//1000	132M	00412ET3YAL132M-W22	\$1,254	T1	147	1.25	7.90	89.5	19.291	460//380-415/660-690	2,7
		900//750	160M	00409ET3Y160M-W22	\$1,947	T1	299	1.25	8.17	86.5	23.543	460//380-415/660-690	7
7.5	5.5	3600//3000	132S	00536ET3EAL132S-W22	\$1,144	T1	136	1.25	8.97	89.5	19.291	230/460//190/380	2,7
		3600//3000	132S	00536ET3YAL132S-W22	\$1,144	T1	136	1.25	8.97	89.5	19.291	460//380-415/660-690	2,7
		1800//1500	132S	00518ET3EAL132S-W22	\$932	T1	142	1.25	9.07	91.7	19.291	230/460//190/380	2,7
		1800//1500	132S	00518ET3YAL132S-W22	\$932	T1	142	1.25	9.07	91.7	19.291	460//380-415/660-690	2,7
		1200//1000	160M	00512ET3Y160M-W22	\$1,760	T1	291	1.25	9.48	91.0	23.543	460//380-415/660-690	7
		900//750	160M	00509ET3Y160M-W22	\$2,244	T1	306	1.25	11.1	87.5	23.543	460//380-415/660-690	7
10	7.5	3600//3000	132S	00736ET3EAL132S-W22	\$1,292	T1	148	1.25	12.3	90.2	19.291	230/460//190/380	2,7
		3600//3000	132S	00736ET3YAL132S-W22	\$1,292	T1	147	1.25	12.3	90.2	19.291	460//380-415/660-690	2,7
		1800//1500	132M	00718ET3EAL132M-W22	\$1,110	T1	159	1.25	12.2	91.7	19.291	230/460//190/380	2,7
		1800//1500	132M	00718ET3YAL132M-W22	\$1,110	T1	159	1.25	12.2	91.7	19.291	460//380-415/660-690	2,7
		1200//1000	160M	00712ET3Y160M-W22	\$2,306	T1	306	1.25	13.1	91.0	23.543	460//380-415/660-690	7
		900//750	160L	00709ET3Y160L-W22	\$2,774	T1	352	1.25	15.2	88.5	25.276	460//380-415/660-690	7
15	11	3600//3000	160M	01136ET3Y160M-W22	\$2,102	T1	304	1.25	17.9	91.7	23.543	460//380-415/660-690	7
		1800//1500	160M	01118ET3Y160M-W22	\$1,726	T1	321	1.25	18.2	92.4	23.543	460//380-415/660-690	7
		1200//1000	160L	01112ET3Y160L-W22	\$3,160	T1	354	1.25	18.8	91.7	25.276	460//380-415/660-690	7
		900//750	180L	01109ET3Y180L-W22	\$4,031	T1	419	1.25	19.5	89.5	27.638	460//380-415/660-690	7
20	15	3600//3000	160M	01536ET3Y160M-W22	\$2,413	T1	320	1.25	24.4	91.7	23.543	460//380-415/660-690	7
		1800//1500	160L	01518ET3Y160L-W22	\$2,118	T1	375	1.25	25.0	93.0	25.276	460//380-415/660-690	7
		1200//1000	180L	01512ET3Y180L-W22	\$3,884	T1	447	1.25	24.7	91.7	27.638	460//380-415/660-690	7
		900//750	200L	01509ET3Y200L-W22	\$5,158	T1	517	1.25	28.0	91.0	30.197	460//380-415/660-690	7
25	18.5	3600//3000	160L	01836ET3Y160L-W22	\$2,925	T1	353	1.25	29.9	92.4	25.276	460//380-415/660-690	7
		1800//1500	180M	01818ET3Y180M-W22	\$2,689	T1	436	1.25	30.6	93.6	26.142	460//380-415/660-690	7
		1200//1000	200L	01812ET3Y200L-W22	\$4,886	T1	552	1.25	30.8	93.0	30.197	460//380-415/660-690	7
		900//750	225S/M	01809ET3Y225S/M-W22	\$5,902	T1	830	1.25	31.6	93.0	34.882	460//380-415/660-690	7
30	22	3600//3000	180M	02236ET3Y180M-W22	\$3,492	T1	424	1.25	34.7	92.4	26.142	460//380-415/660-690	7
		1800//1500	180L	02218ET3Y180L-W22	\$3,225	T1	457	1.25	36.0	93.6	27.638	460//380-415/660-690	7
		1200//1000	200L	02212ET3Y200L-W22	\$4,924	T1	601	1.25	37.1	93.0	30.197	460//380-415/660-690	7
		900//750	225S/M	02209ET3Y225S/M-W22	\$7,506	T1	885	1.25	37.6	93.0	34.882	460//380-415/660-690	7

continued on next page

Please refer to back cover for description of "NOTES"

For detailed specifications, data sheets, drawings and performance curves visit <http://www.weg.net>



TEFC - Foot Mount - continued

Three-Phase
General Purpose
Motors

HP	kW	RPM	Frame	Catalog Number	List Price	Mult. Symbol	Approx. Shipping Weight (lbs)	Service Factor	FL Amps @ High	FL Eff (%)	"C" Dimension (in)	Voltage (V)	Notes
40	30	3600//3000	200L	03036ET3Y200L-W22	\$4,877	T1	575	1.25	47.1	93.0	30.197	460//380-415/660-690	7
		1800//1500	200L	03018ET3Y200L-W22	\$4,312	T1	580	1.25	49.4	94.1	30.197	460//380-415/660-690	7
		1200//1000	225S/M	03012ET3Y225S/M-W22	\$7,689	T1	1055	1.25	47.6	94.1	34.882	460//380-415/660-690	7
		900//750	250S/M	03009ET3Y250S/M-W22	\$8,858	T1	1078	1.25	50.9	93.6	37.992	460//380-415/660-690	7
50	37	3600//3000	200L	03736ET3Y200L-W22	\$5,487	T1	587	1.25	61.3	93.6	30.197	460//380-415/660-690	7
		1800//1500	225S/M	03718ET3Y225S/M-W22	\$6,984	T1	1041	1.25	58.5	94.5	34.882	460//380-415/660-690	7
		1200//1000	250S/M	03712ET3Y250S/M-W22	\$9,947	T1	1266	1.25	58.8	94.1	37.992	460//380-415/660-690	7
		900//750	280S/M	03709ET3Y280S/M-W22	\$11,751	T1	1481	1.25	64.1	94.1	42.165	460//380-415/660-690	7
60	45	3600//3000	225S/M	04536ET3Y225S/M-W22	\$7,961	T1	1053	1.25	66.7	94.1	33.701	460//380-415/660-690	7
		1800//1500	225S/M	04518ET3Y225S/M-W22	\$7,391	T1	1022	1.25	69.9	95.0	34.882	460//380-415/660-690	7
		1200//1000	280S/M	04512ET3Y280S/M-W22	\$11,023	T1	1681	1.25	74.7	94.5	42.165	460//380-415/660-690	7
		900//750	280S/M	04509ET3Y280S/M-W22	\$12,815	T1	1631	1.25	77.0	94.1	42.165	460//380-415/660-690	7
75	55	3600//3000	250S/M	05536ET3Y250S/M-W22	\$9,847	T1	1259	1.25	80.3	94.5	37.992	460//380-415/660-690	7
		1800//1500	250S/M	05518ET3Y250S/M-W22	\$8,961	T1	1206	1.25	85.1	95.4	37.992	460//380-415/660-690	7
		1200//1000	280S/M	05512ET3Y280S/M-W22	\$13,622	T1	1794	1.25	90.2	94.5	42.165	460//380-415/660-690	7
		900//750	315S/M	05509ET3Y315S/M-W22	\$15,379	T1	2436	1.25	93.7	94.5	50.157	460//380-415/660-690	7
100	75	3600//3000	280S/M	07536ET3Y280S/M-W22	\$12,472	T1	1776	1.25	111	94.5	42.165	460//380-415/660-690	7
		1800//1500	280S/M	07518ET3Y280S/M-W22	\$12,353	T1	1738	1.25	116	95.4	42.165	460//380-415/660-690	7
		1200//1000	315S/M	07512ET3Y315S/M-W22	\$16,479	T1	2399	1.25	122	95.0	50.157	460//380-415/660-690	7
		900//750	315S/M	07509ET3Y315S/M-W22	\$18,647	T1	2701	1.25	127	95.0	50.157	460//380-415/660-690	7
125	90	3600//3000	280S/M	09036ET3Y280S/M-W22	\$16,720	T1	1862	1.25	132	95.0	42.165	460//380-415/660-690	7
		1800//1500	280S/M	09018ET3Y280S/M-W22	\$15,220	T1	1835	1.25	139	95.4	42.165	460//380-415/660-690	7
		1200//1000	315S/M	09012ET3Y315S/M-W22	\$19,448	T1	2601	1.25	146	95.4	50.157	460//380-415/660-690	7
		900//750	315S/M	09009ET3Y315S/M-W22	\$21,288	T1	2884	1.25	152	95.0	50.157	460//380-415/660-690	7
150	110	3600//3000	315S/M	11036ET3Y315S/M-W22	\$21,018	T1	2382	1.25	163	95.0	48.976	460//380-415/660-690	7
		1800//1500	280S/M	11018ET3Y280S/M-W22	\$17,078	T1	2210	1.25	170	95.8	42.165	460//380-415/660-690	7
		1200//1000	315S/M	11012ET3Y315S/M-W22	\$22,507	T1	2730	1.25	178	95.8	50.157	460//380-415/660-690	7
		900//750	315L	11009ET3Y315L-W22	\$27,910	T1	3008	1.25	186	95.4	54.685	460//380-415/660-690	7,43
175	132	3600//3000	315S/M	13236ET3Y315S/M-W22	\$23,180	T1	2662	1.25	193	95.4	48.976	460//380-415/660-690	7
		1800//1500	315S/M	13218ET3Y315S/M-W22	\$19,732	T1	2540	1.25	203	96.2	50.157	460//380-415/660-690	7
		1200//1000	315S/M	13212ET3Y315S/M-W22	\$25,642	T1	3031	1.25	214	95.8	50.157	460//380-415/660-690	7
		900//750	315L	13209ET3Y315L-W22	\$33,687	T1	3796	1.25	223	95.4	54.685	460//380-415/660-690	7,43
200	150	3600//3000	315S/M	15036ET3Y315S/M-W22	\$26,249	T1	2682	1.25	219	95.4	48.976	460//380-415/660-690	7
		1800//1500	315S/M	15018ET3Y315S/M-W22	\$21,772	T1	2784	1.25	228	96.2	50.157	460//380-415/660-690	7
		1200//1000	315L	15012ET3Y315L-W22	\$28,298	T1	3557	1.15	240	95.8	54.685	460//380-415/660-690	7,43
250	185	3600//3000	315S/M	18536ET3Y315S/M-W22	\$26,529	T1	2900	1.25	269	95.8	48.976	460//380-415/660-690	7
		1800//1500	315S/M	18518ET3Y315S/M-W22	\$26,247	T1	2948	1.25	284	96.2	50.157	460//380-415/660-690	7
		1200//1000	355M/L	18512ET3Y355M/L-W22	\$43,876	T1	3666	1.15	311	95.8	58.346	460//380-415/660-690	7
300	220	3600//3000	315L	22036ET3Y315L-W22	\$44,212	T1	3468	1.25	315	96.2	53.268	460//380-415/660-690	7,43
		1800//1500	315L	22018ET3Y315L-W22	\$36,234	T1	3113	1.25	338	96.2	54.685	460//380-415/660-690	7,43
		1200//1000	355M/L	22012ET3Y355M/L-W22	\$46,322	T1	4507	1.15	370	95.8	58.346	460//380-415/660-690	7,43
350	260	3600//3000	355M/L	26036ET3Y355M/L-W22	\$50,637	T1	4975	1.15	373	96.2	55.591	460//380-415/660-690	7,43
		1800//1500	355M/L	26018ET3Y355M/L-W22	\$43,761	T1	4218	1.15	399	96.2	58.346	460//380-415/660-690	7,43
		1200//1000	355M/L	26012ET3Y355M/L-W22	\$53,001	T1	5075	1.15	436	95.9	58.346	460//380-415/660-690	7,43
400	300	3600//3000	355M/L	30036ET3Y355M/L-W22	\$66,321	T1	4034	1.15	315	96.2	55.591	460//380-415/660-690	7,43
		1800//1500	355M/L	30018ET3Y355M/L-W22	\$60,292	T1	4337	1.00	466	96.2	58.346	460//380-415/660-690	7,43
450	330	1800//1500	355M/L	33018ET3Y355M/L-W22	\$64,557	T1	4906	1.15	505	96.5	58.346	460//380-415/660-690	7,43

Please refer to back cover for description of "NOTES"

For detailed specifications, data sheets, drawings and performance curves visit <http://www.weg.net>

Data subject to change without notice.

Can't find what you are looking for? Call 1-800-ASK-4WEG (275-4934)

A-77

Three-Phase General Purpose Motors



IEC TRU-Metric™

TEFC – Foot Mount - FF-Face Motors

Three-Phase
General Purpose
Motors

HP	kW	RPM	Frame	Catalog Number	List Price	Mult. Symbol	Approx. Shipping Weight (lbs)	Service Factor	FL Amps @ High	FL. Eff (%)	“C” Dimension (in)	Notes
0.50	0.37	1800//1500	71	.3718EP3EAL71FF-W22	\$340	T1	26	1.15	1.06	73.0	9.764	2,7
0.75	0.55	3600//3000	71	.5536EP3EAL71FF-W22	\$366	T1	23	1.15	1.14	76.0	9.764	2,7
		1800//1500	80	.5518EP3EAL80FF-W22	\$383	T1	28	1.15	1.25	77.0	10.866	2,7
1	0.75	1800//1500	90S/L	.7518ET3WAL90S/LFF-W	\$479	T1	43	1.25	1.47	85.5	12.953	2,7
		1800//1500	90S/L	.7518ET3EAL90S/LFF-W	\$479	T1	42	1.25	1.47	85.5	12.953	2,7
2	1.5	1800//1500	90S/L	00158ET3EAL90LFF-W22	\$583	T1	49	1.25	2.79	86.5	12.953	2,7
		1800//1500	90L	00158ET3WAL90LFF-W22	\$583	T1	51	1.25	2.79	86.5	12.953	
		1200//1000	100L	00152ET3WAL100LFF-W2	\$882	T1	76	1.25	3.04	88.5	14.803	2,7
3	2.2	3600//3000	90L	00236ET3WAL90LFF-W22	\$815	T1	46	1.25	3.85	86.5	12.953	
		1800//1500	100L	00218ET3EAL100LFF-W2	\$700	T1	66	1.25	4.11	89.5	14.803	2,7
		1800//1500	100L	00218ET3WAL100LFF-W2	\$700	T1	68	1.25	4.05	87.5	14.803	
4	3	1800//1500	100L	00318ET3WAL100LFF-W2	\$742	T1	77	1.25	5.33	89.5	14.803	2,7
5.5	4	3600//3000	112M	00436ET3YAL112MFF-W2	\$944	T1	86	1.25	6.67	88.5	15.472	2,7
		1800//1500	112M	00418ET3YAL112MFF-W2	\$749	T1	93	1.25	7.28	89.5	15.472	2,7
		1200//1000	132M	00412ET3YAL132MFF-W2	\$1,333	T1	147	1.25	7.9	89.5	19.291	2,7
7.5	5.5	3600//3000	132S	00536ET3YAL132SFF-W2	\$1,223	T1	135	1.25	8.97	89.5	19.291	39
		1800//1500	132S	00518ET3YAL132SFF-W2	\$1,011	T1	142	1.25	9.07	91.7	19.291	2,7
10	7.5	3600//3000	132S	00736ET3YAL132SFF-W2	\$1,371	T1	147	1.25	12.3	90.2	19.291	2,7
		1800//1500	132M	00718ET3YAL132MFF-W2	\$1,189	T1	159	1.25	12.2	91.7	19.291	2,7
15	11	3600//3000	160M	01136ET3Y160MFF-W22	\$2,219	T1	304	1.25	17.9	91.7	23.543	7
		1800//1500	160M	01118ET3Y160MFF-W22	\$1,843	T1	304	1.25	18.2	92.4	23.543	7
20	15	1800//1500	160L	01518ET3Y160LFF-W22	\$2,235	T1	358	1.25	25.0	93.0	25.276	7
30	22	1800//1500	180L	02218ET3Y180LFF-W22	\$3,361	T1	501	1.25	36.0	93.6	27.638	7
50	37	3600//3000	200L	03736ET3Y200LFF-W22	\$5,789	T1	595	1.25	61.3	93.6	30.197	7
50	37	1800//1500	225S/M	03718ET3Y225S/MFF-W22	\$7,774	T1	1058	1.25	58.5	94.5	34.882	7

Please refer to back cover for description of “NOTES”

For detailed specifications, data sheets, drawings and performance curves visit <http://www.weg.net>

- Models in blue text are NEMA Premium Efficiency

- Models in green text are NEMA Super Premium Efficiency

Catalog Notes

1	1.0 Service Factor	31	Rating is suitable for 1.0SF @ 50Hz. Also suitable for next lower HP @ 1.15SF 50Hz
2	Aluminum Frame with Removable Feet	32	Suitable for 1.15SF @ 50°C ambient
3	Automatic Reset Thermal Overload Protector	33	Suitable for 380V 60Hz when wired as YY (double WYE)
4	Manual Reset Thermal Overload Protector	34	AEGIS® Inside
5	CCW Rotation Viewed from Shaft End - Non Reversible	35	AEGIS® ring installation reduces the available "N-W" length
6	Compressor Duty	36	Super Premium
7	F2 Mount	37	Design A
8	F3 Mount	38	TEAO - Totally Enclosed Air Over
9	Rolled Steel Frame - Cannot be modified with T Box on opposite side	39	Cannot be modified with T Box on opposite side
10	Not Thermally Protected	40	NDE shaft with 3/8" drive socket
11	Metal fan - Not suitable for division 2	41	Also rated 230/460V 50Hz 1.0 SF
12	Reduced Frame	42	Rated 50°C ambient
13	Resilient Base	43	With insulated non drive end housing
14	Roller Bearing	44	With air deflector. Flange MOD not available
15	Round Body - Drip Cover Included	45	Also rated 380V 50Hz
16	Split-Phase Motor	46	56J shaft end with dual opposed threads (7/16-20 UNF-2A R.H and 3/8-16 UNF-2A L.H)
17	TENV - Totally Enclosed Non Ventilated	47	Motor designed with copper bar rotor
18	Z-Frame; Bigger Shaft Diameter and Bearings	48	Motor suitable for safe area only
19	105K Tempature Rise; VFD service requires HP derate		
20	Round Body - Drip Cover NOT Included		
21	Stainless Steel Body		
22	Two Speed - Double Windings		
23	Two Speed - Single Winding		
24	Modified item. Usually ships in two weeks		
25	Brake rectifier suitable for 230VAC		
26	Brake rectifier suitable for 460VAC		
27	For Export Only (not to be used in the USA) due to Certification and/or Efficiency requirements.		
28	ODP Fan Cooled		
29	Standard Efficiency		
30	High Efficiency (EPACT)		