

# DATASHEET

## Circuit Breaker



### Main Features

Reference	: MPW100
Product code	: 10076552
Setting range for thermal release	: 70-90 A
Maximum rated current Ie	: 100 A
Terminal type	: Box

### Basic Data

Rated operational voltage Ue	
- IEC	: 690 V
- UL	: Not available
Rated insulation voltage Ui	
- IEC	: 1000 V
- UL	: Not available
Number of poles	: 3
Short-circuit release	: 13 x I <sub>emax</sub>
Rated operational frequency	: 50/60 Hz
Utilization category	
- IEC60947-2 (motor starter protector/circuit breaker)	: A
- IEC60947-4-1 (Motor Starters)	: AC-3
Trip test	: Yes
Overload protection	: Yes
Phase failure sensitivity	: Yes
Trip indication	: Yes
Tripping class	: 10
Maximum operating frequency (ops./h)	: 25
Mechanical lifespan	: 5000 operations
Electrical lifespan	: 25000 operations
Power dissipation per circuit breaker	: 29 W
Resistance to impact (IEC 60068-2-27)	: 25 g
Degree of protection	: IP20

### Breaking capacity (IEC 60947-2)

Voltage	I <sub>cu</sub>	I <sub>cs</sub>
220 - 240 V	100	100
380 - 415 V	75	50
440 V	50	38
460 - 500 V	12	9
630 - 690 V	6	6

### Connection

Terminal type	: Box
Screw type	: Screw Allen (4mm)
Tightening torque	: 6 N.m / 55 lb.in

### Ambient conditions

Temperature	
- Operation	-20 °C (-4 °F) ... +60 °C (140 °F)
- storage	-50 °C (-58 °F) ... +80 °C (176 °F)
Temperature compensation (IEC 60947-4-1)	-20 °C (-4 °F) ... +60 °C (140 °F)
Maximum operating altitude without changing the rated values	: 2000 m

Correction factors for altitude:

Altitude (h)	Rated operating voltage	Current reduction factor
h ≤ 2000 m	690 V	690 V
2000 m < h ≤ 3000 m	550 V	550 V
3000 m < h ≤ 4000 m	480 V	480 V
4000 m < h ≤ 5000 m	420 V	420 V

### Dimensions

Height	: 165 mm / 6.5 in
Width	: 70 mm / 2.76 in
Depth	: 171 mm / 6.73 in
Gross weight	: 2,20 kg / 4.85 lb

### Compliance/Standards

IEC/EN 60947-1, DIN VDE 0660 (part 100)  
 IEC/EN 60947-2, DIN VDE 0660 (part 101)  
 IEC/EN 60947-4-1, DIN VDE 0660 (part 102)

# DATASHEET

## Circuit Breaker



### Compliance/Standards

UL 508

### Certifications

ANCE  
BUREAU VERITAS  
CE  
PCT  
IRAM  
CS  
UL

### Notes

- 1) Reduce current for temperatures exceeding +60 °C (87% to 70 °C);
- 2) Image merely illustrative.

A

B

C

D

E

F

G

H

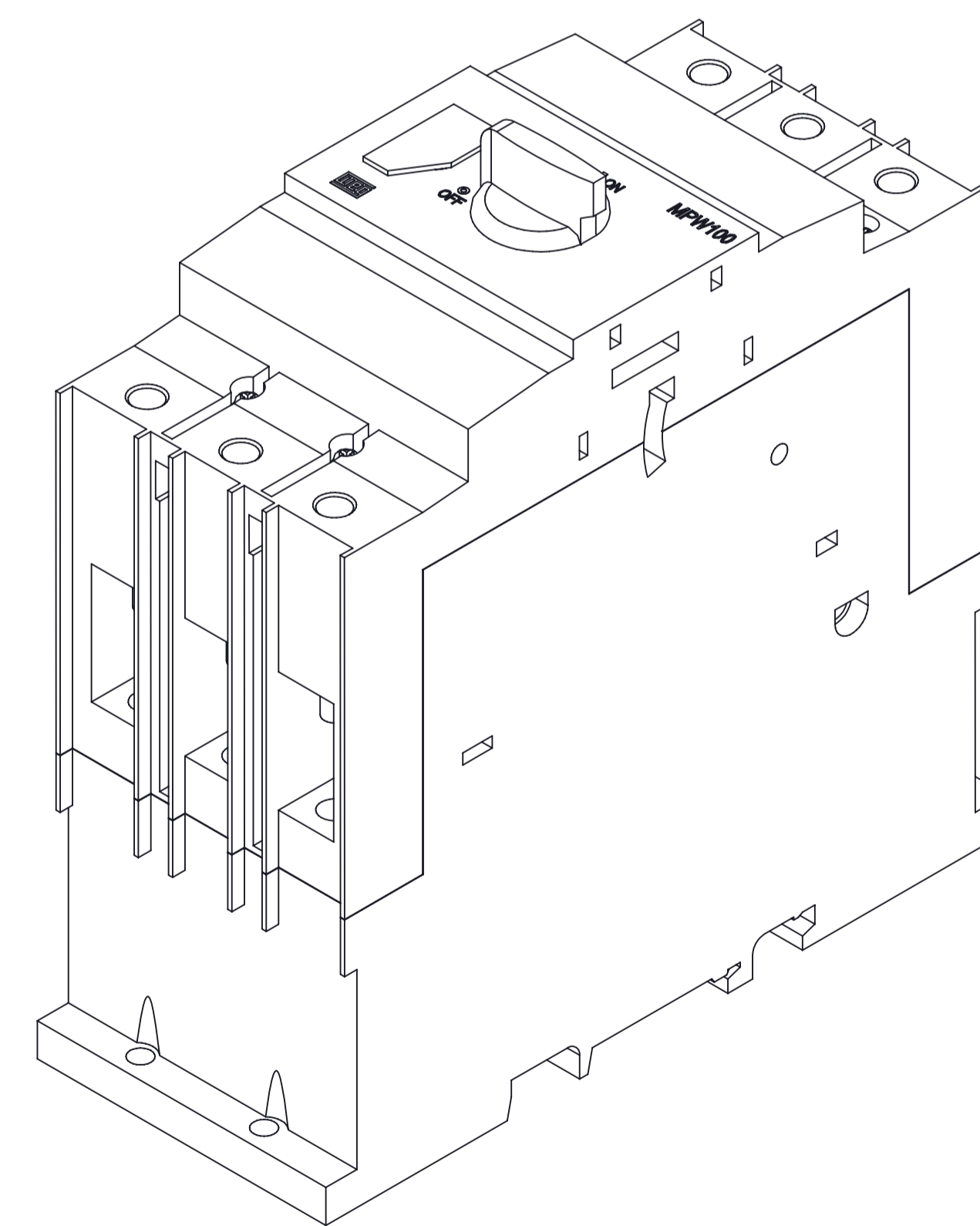
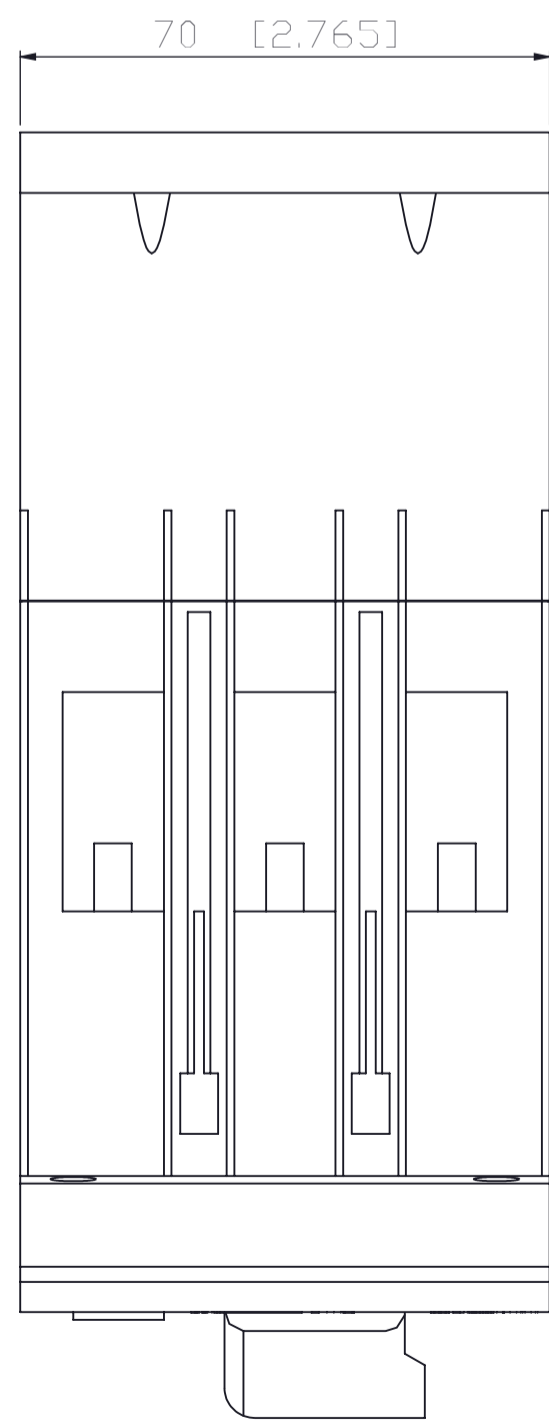
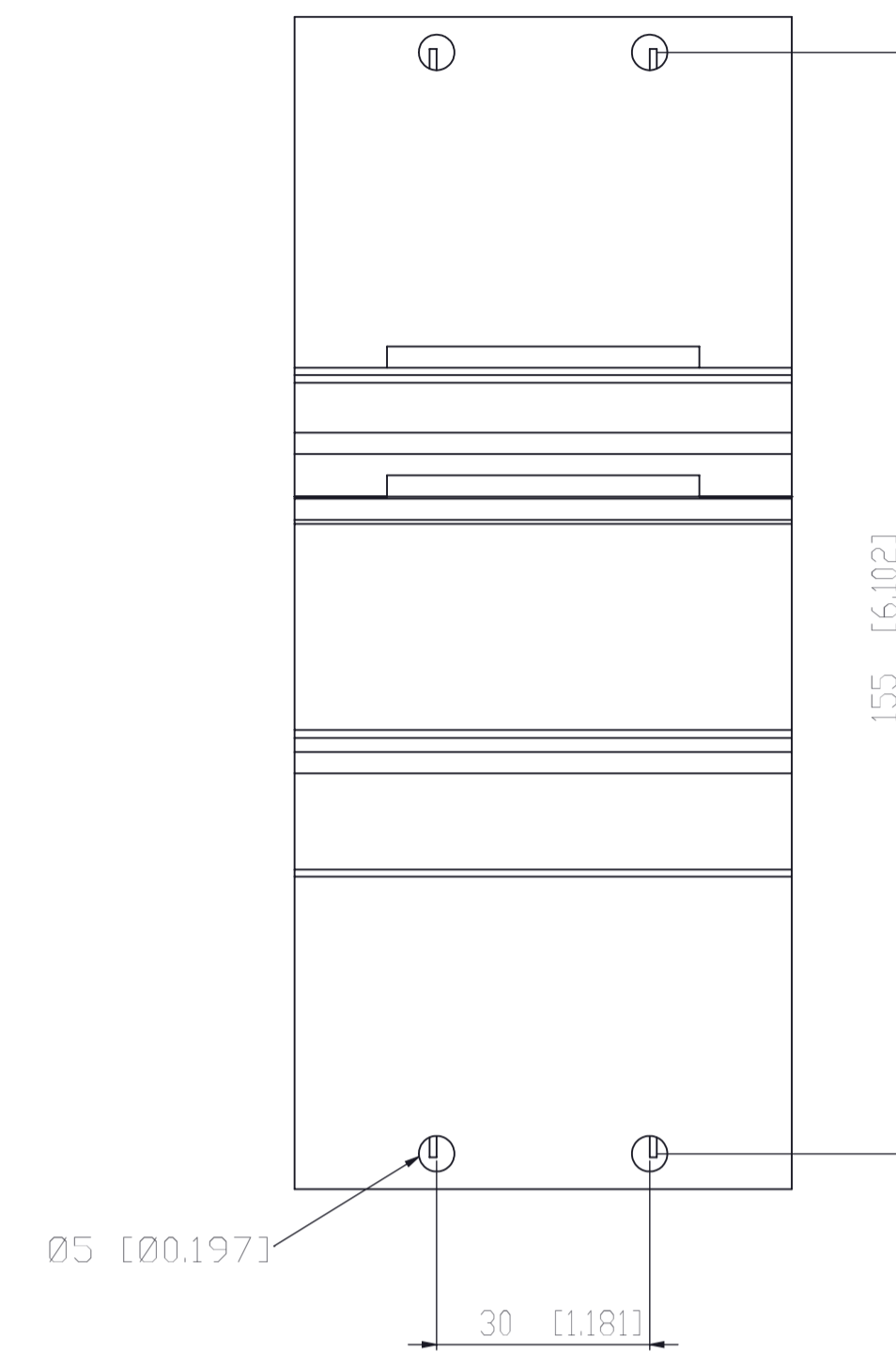
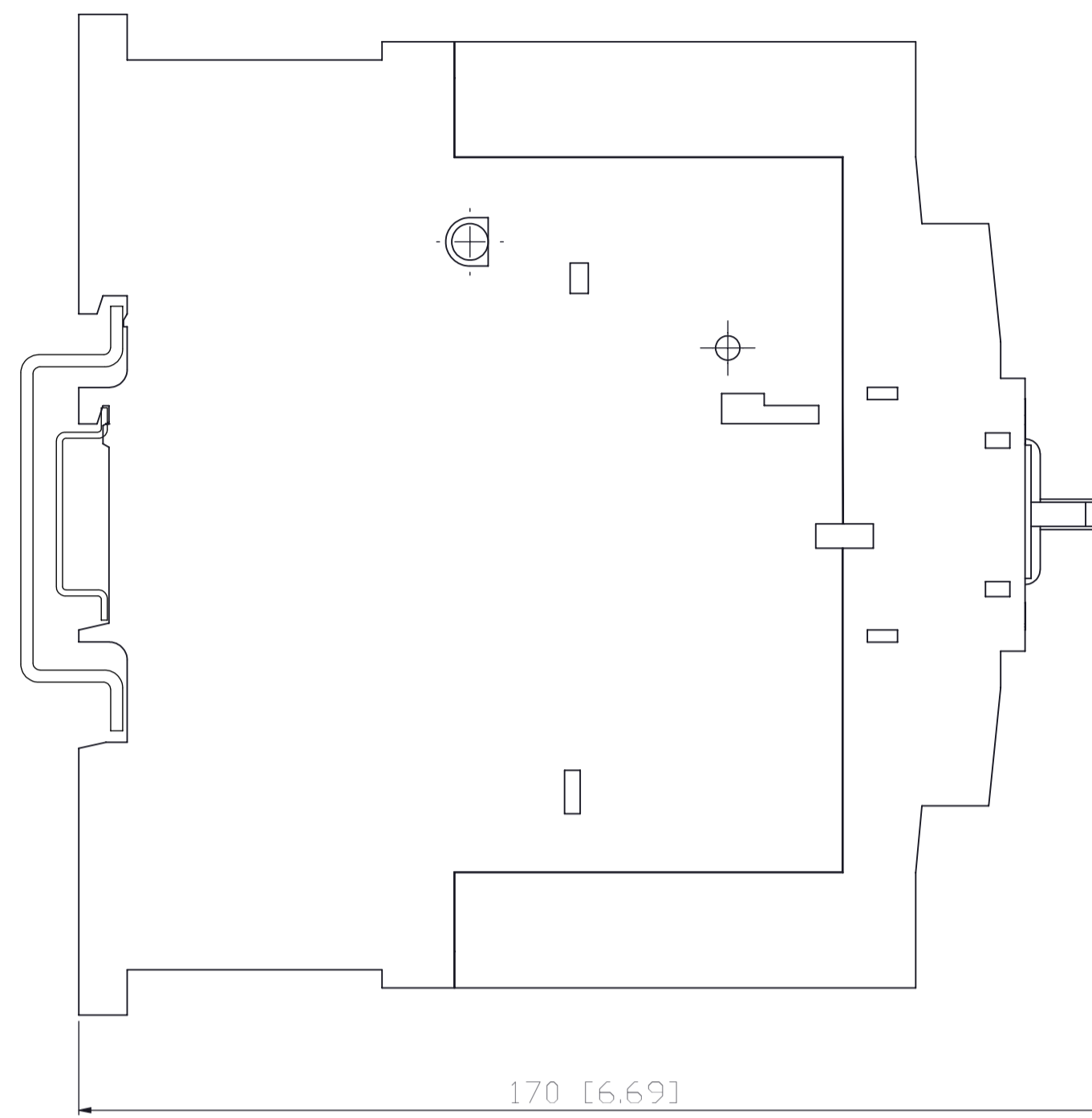
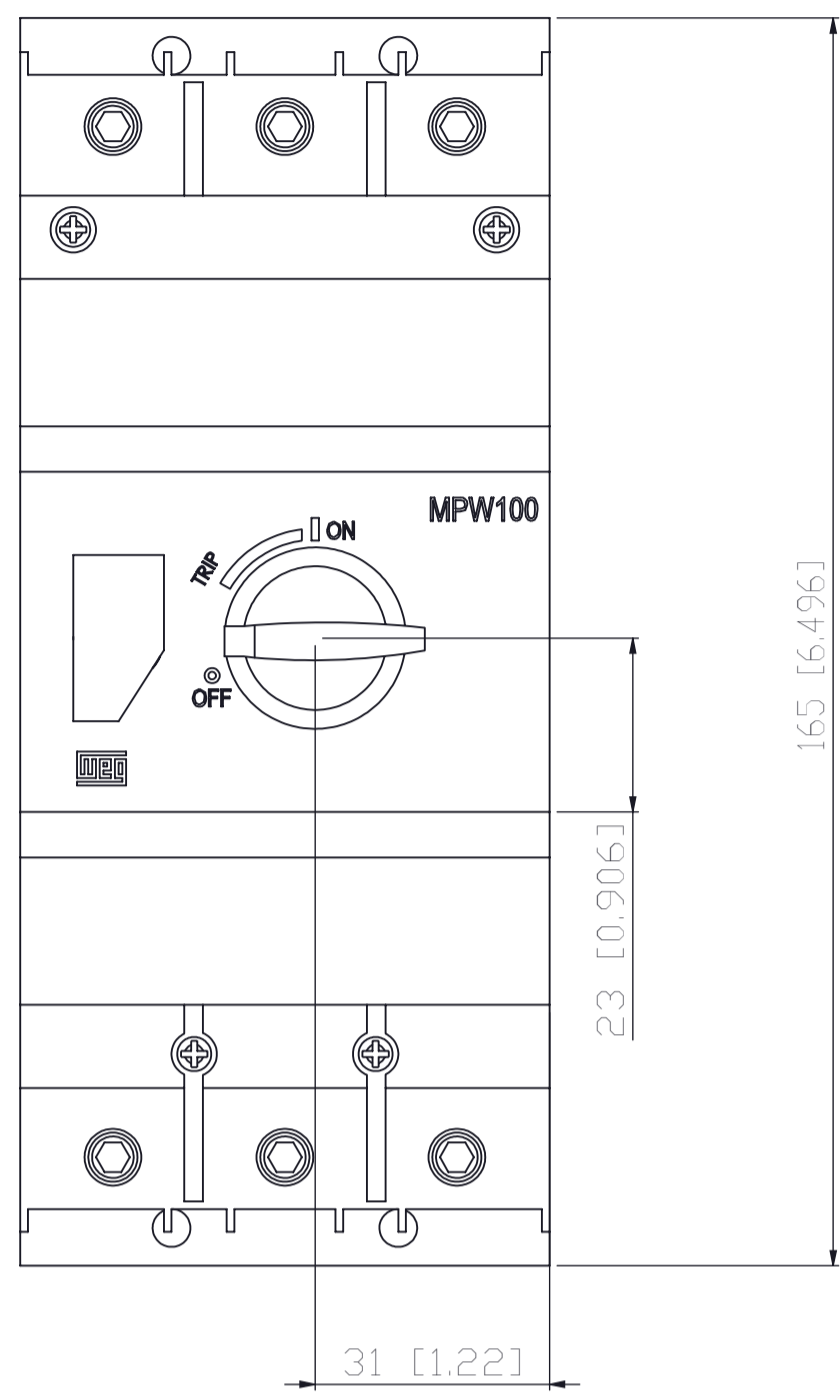

Dimensão / Dimension: mm [in]

MASSA LIQUIDA/NET WEIGHT		ESCALA/SCALE	
DATA/DATE	VER	10004159063	
FOLHSHEET 1 / 1			