

CATALOG #	TYPE	FRAME	OUTPUT		POLE	SYN. SPEED R.P.M.	VOLTAGE V.	Hz.	TIME RATING	INSULATION CLASS	SERVICE FACTOR	BEARINGS		WEIGHT LBS
			HP	KW								DE	NDE	
SPT0/34	BEGS39	48	1/3	.25	4	1800	115/208-230	60	CONT.	F	1.15	6203ZZ	6202ZZ	25

TOTALLY ENCLOSED FAN COOLED, SQUIRREL CAGE ROTOR

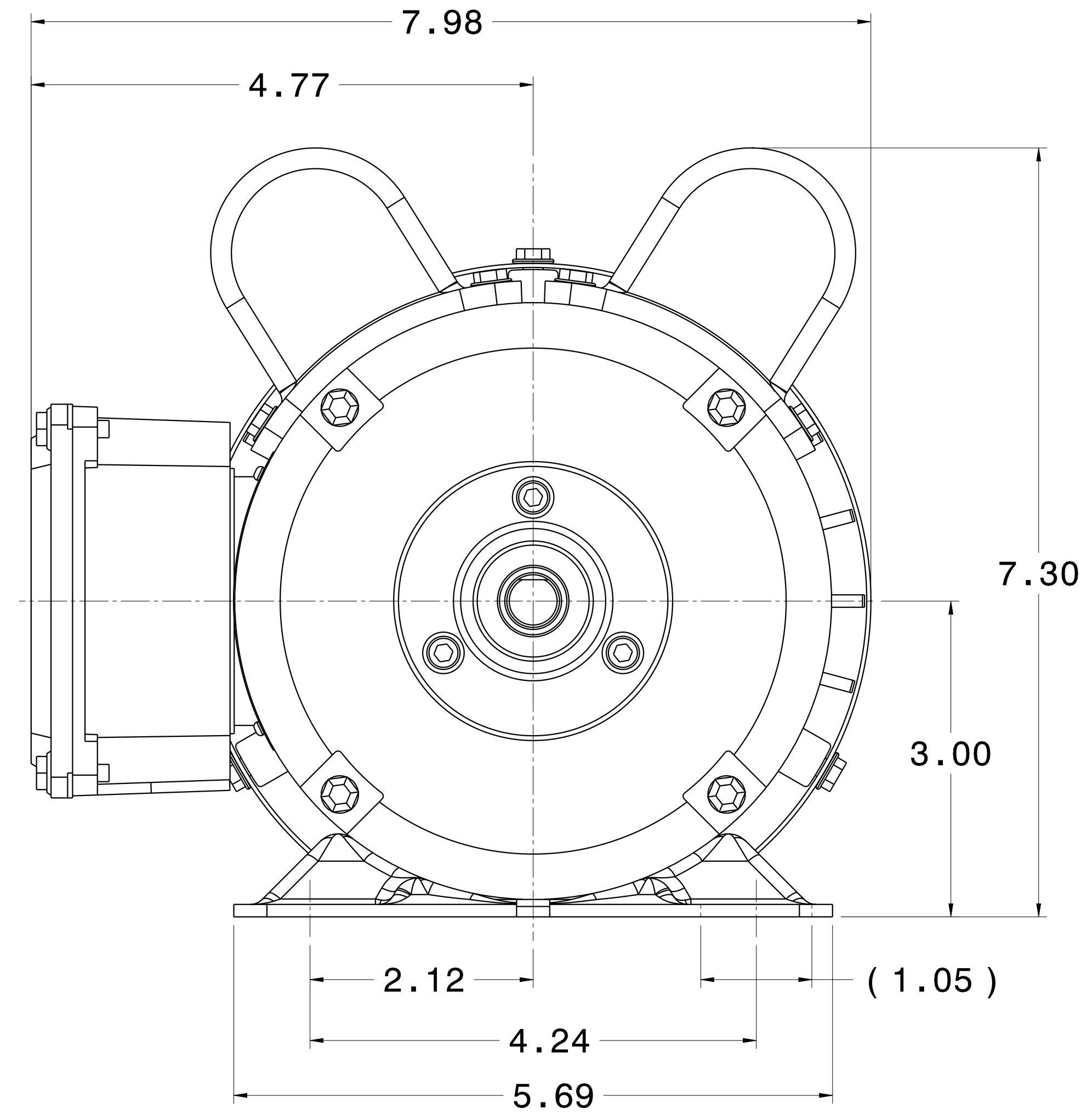

SLOT DETAIL

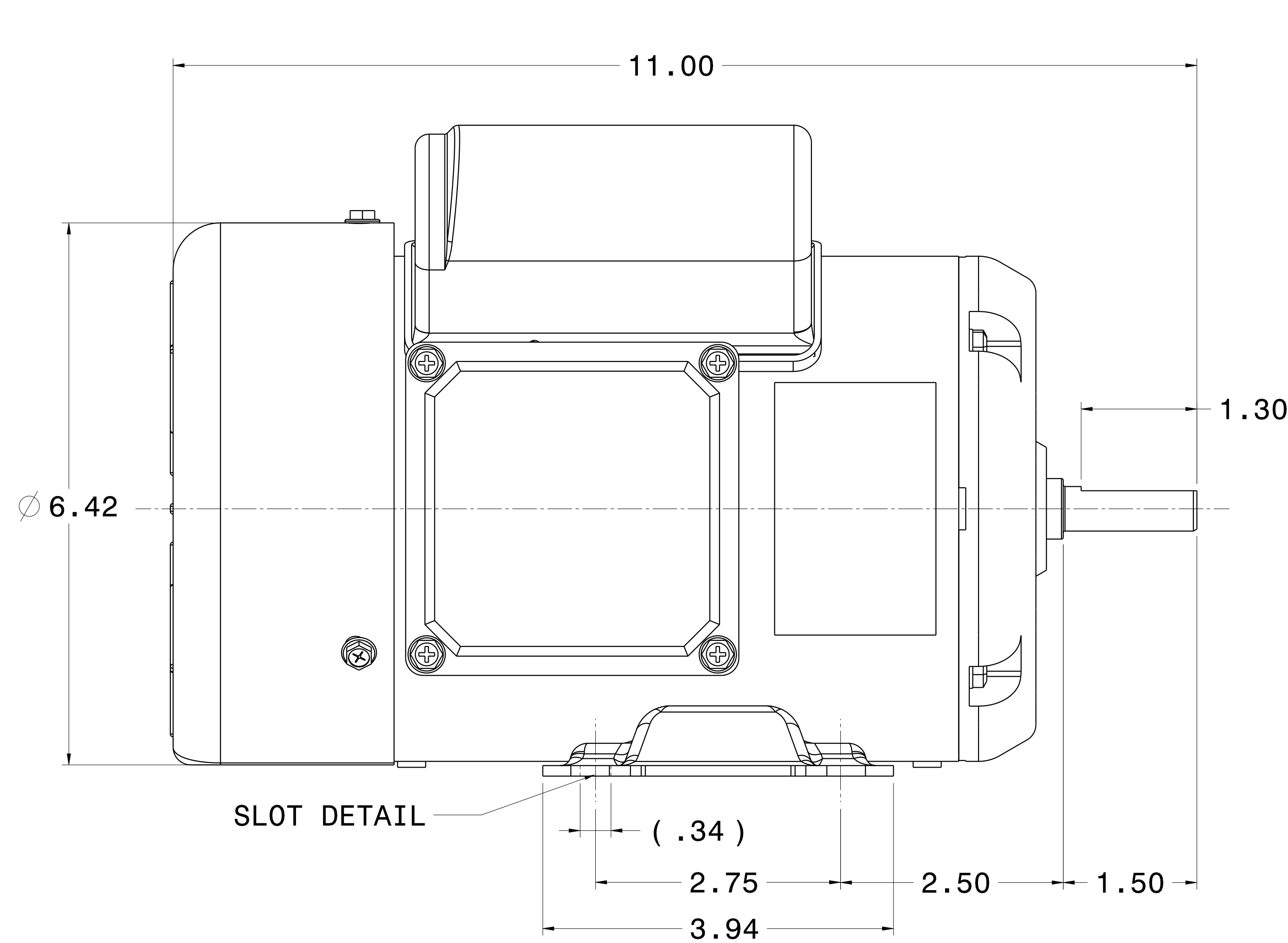
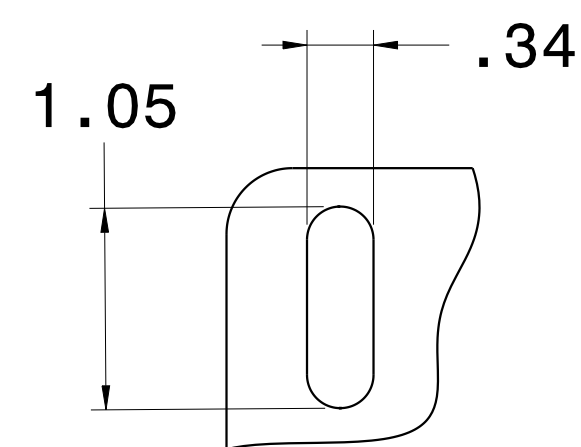

SLOT DETAIL
4X

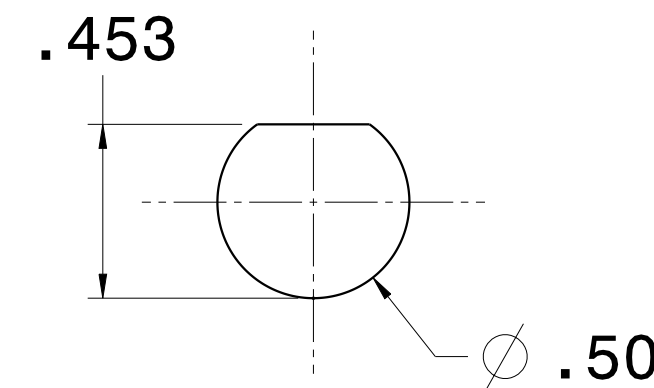

SHAFT END
(ENLARGED VIEW)

NOTES:

1. DIMENSIONS IN INCH.
2. ENCLOSURE: IP44.
3. FOR BELT SERVICE OR DIRECT COUPLING SERVICE.
4. BI-DIRECTIONAL ROTATION.

REF: 3904R33KF10A	REV. DATA			REV NO
	TECO Westinghouse			01
	HVAC SINGLE PHASE OUTLINE DIMENSIONS		DWG NO. SPT0/34	
	DWN K. MILNER	081617	APPD T. FELPS	081617
TECO-WESTINGHOUSE MOTOR COMPANY			ROUND ROCK, TEXAS USA	

TECO Westinghouse

ISSUED September 20, 2017	PERFORMANCE DATA SINGLE PHASE MOTOR	ENCLOSURE TEFC
TYPE BEGS39		CATALOG# SPT0/34

NAMEPLATE INFORMATION

OUTPUT		FRAME SIZE	POLES	VOLTAGE	HZ	RATED AMBIENT	INSULATION CLASS	TIME RATING	SERVICE FACTOR
HP	KW								
1/3	0.25	48	4	115/230	60	40°C	F	CONT.	1.15

TYPICAL PERFORMANCE

FULL LOAD RPM	EFFICIENCY				POWER FACTOR			KVA CODE
	MIN %	NOM %	3/4 LOAD %	1/2 LOAD %	F. L. %	3/4 LOAD %	1/2 LOAD %	
1735	70.3	74.0	68.0	60.0	83.0	81.0	75.0	K

CURRENTS

CAPACITORS CURRENTS

NO LOAD		FULL LOAD		LOCKED ROTOR		STARTING		RUNNING	
AT 115 VOLT	AT 230 VOLT	AT 115 VOLT	AT 230 VOLT	AT 115 VOLT	AT 230 VOLT	MFD	VOLTS	MFD	VOLTS
1.93	0.96	3.5	1.8	23	12	200	125	30	250

TORQUE

FULL LOAD lb-ft	LOCKED ROTOR %FLT	BREAK DOWN %FLT
1.01	310	260

INERTIA

ROTOR WR ² lb-ft ²
0.0261

ALLOWABLE STARTS PER HOUR

COLD	HOT
2	1

SOUND PRESSURE LEVEL @ 3 FT dB(A)

61

APPROVED:	A. GRAYSON	DRAWING NO.	31057SPT0/34	REVISION	0
-----------	-------------------	-------------	---------------------	----------	----------

MOTOR TYPE: BSGS39/BEGS39/BEGS19	CONNECTION DIAGRAM	FRAME SIZE: 48/56/56H/140T
DATE: Aug. 27, 2017	SINGLE PHASE - CAP START/CAP RUN	MODEL:

THERMAL PROTECTOR

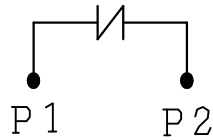

Exchange T5, T8 To
Change Rotation

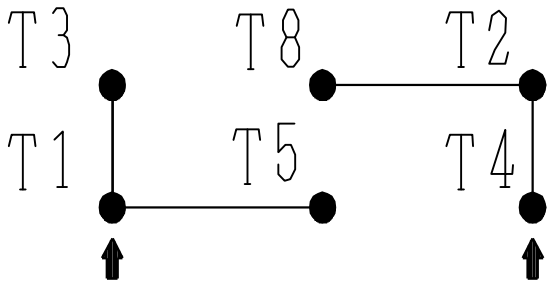

115V CW ROTATION

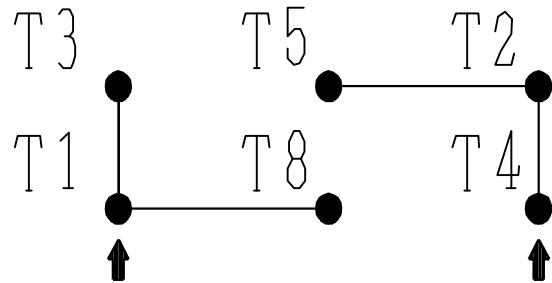

115V CCW ROTATION

Exchange T5, T8 To
Change Rotation

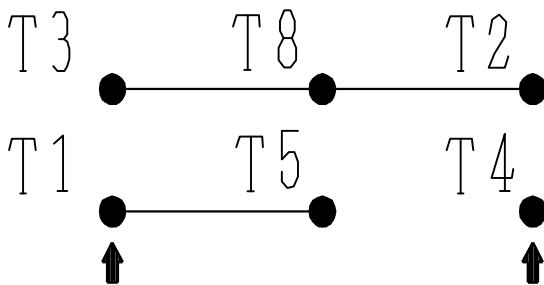

208/230V CW ROTATION

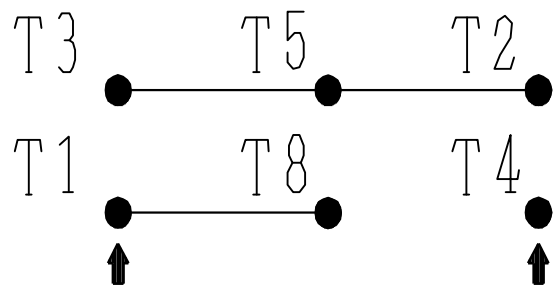

208/230V CCW ROTATION

INSTALLATION & MAINTENANCE INSTRUCTIONS





This instruction manual is for **TECHNICAL USE ONLY, NOT FOR COMMERCIAL PURPOSE**. The warranty is limited to coverage expressed in your sales contract. Documentation of storage, transportation, installation and examination, if required, shall be inquired of TECO's service center before start and maintenance.











BEFORE INSTALLATION & USE



1. Ensure nameplate data corresponds with your requirements
2. Ensure the motor is undamaged
3. Remove any shaft clamp (but refit prior to transportation)
4. Slowly rotate the shaft to ensure free movement
5. Ensure the mounting/shaft orientation design and drain hole positions are correct for the application
6. Eyebolt(s) and any other lifting means must be tight before use

WARNING

The following safety precautions must be observed :

1.  Electric rotating machinery and electricity can cause serious or fatal injury if the motor is improperly installed, operated or maintained. Responsible personnel must be fully trained to understand the hazards to themselves and others before being involved in installing, operating, maintaining and decommissioning electric motors. European Union Safety information can be obtained from such as : EN60204-1 ; EN60034 ; EN292 ; EN294 ; IEE Wiring Regulations
Particular industries and countries have further safety requirements. Refer to their trade & safety bodies.
2.  ExCB Ex n Certification Products Special Conditions For Safe Use
 - a. All terminal nuts and screws, whether used or not, shall be correctly tightened.
 - b. Supply connections shall be made with ring type terminal lugs which have insulated shanks. Clearance distances shall not be reduced when tightening connections.
 - c. On auxiliary terminals the conductor insulation shall extend to within 1 mm of the terminal throat.
 - d. There shall be no loose conductor strands on any terminal.
 - e. The drain plugs (when fitted) shall be replaced immediately after use and sealed with an appropriate sealing compound.
 - f. The brass terminal links shall be connected correctly so as not to reduce the clearance distances.
3.  When servicing, all power sources to the motor and to the accessory devices should be de-energized and disconnected and all rotating parts at standstill.
4.  Lifting means, such as eyebolts, on the motor are for lifting only the motor itself. Assemblies which are not part of the motor must be removed prior to using the motor lifting means. When more than one lifting means is provided on the motor, all must be used together, for instance by attaching a supporting chain to each, to share the load. Ensure that lifting means are fully attached to the motor before lifting.

5.  Suitable ear protection must be worn near machinery emitting high audible noise to reduce the noise reaching the ear to a safe level.
Refer to EN 60034-9 for further information on noise from rotating electrical machines.
6.  Safety guards and other protective devices must neither be bypassed nor rendered inoperative.
7.  The motor must be earthed. Refer to relevant standards such as EN60204-1, IEE Wiring Regulations etc.
8.  A suitable enclosure must be provided for the motor to prevent access to moving parts. Extra caution should be observed around a motor that is automatically started or has automatic resetting relays or is remotely started in case such starting means has not been properly disabled and the motor starts unexpectedly.
9.  Ensure all shaft keys present on moving parts are fully captive before the motor is started.
10.  Ensure adequate safeguards have been made to protect against the consequences of a brake failure, particularly on applications involving overhauling loads.
11.  TECO UL listed explosion proof motors must only be used in countries where the UL certification is recognized as being appropriate for the application. They are constructed to comply with the label service procedure manual and repairs to them must be made by TECO or a UL listed service center in order to maintain the UL listing.
12.  When using a motor in a variable speed application ensure that it will not be driven above its safe maximum speed limit. Consult TECO if in doubt. Also ensure the motor is not overloaded : It should be remembered that as speed reduces, fans driven by the main shaft do not provide as much cooling air and an auxiliary fan may be required.
13.  Protect the motor from overload, preferable by monitoring the winding temperature. TECO can fit thermostats to give indication that the winding is getting too hot and the thermostats can be connected to switchgear that will automatically trip on the signal from the thermostats.
14.  Capacitors such as in single-phase motors may remain charged even when isolated from the mains supply. Discharge capacitors and earth their terminals before handling any connections.
15.  All TECO UL listed Explosion Proof motors have temperature limiting devices in the motor enclosure to help prevent excessive external surface temperature of the motor in accordance with UL standards. Terminals (P1 · P2) of thermal protectors in these motors must be connected to the motor control equipment according to the connection diagram inside the terminal box.

16.  If regressing is to be carried out with the motor running, ensure only properly trained personnel do it and that live and moving parts are fully guarded.
17.  Dust Ignition Proof motors Ex tD or the motors with degree of protection greater than IP55 , the terminal box must be sealed with gaskets to prevent ingress of dust and water. If removed, gaskets must be glued with Loctite 330 or 596 or MXBON TB625.

Location

1. Drip proof motors are intended for use where the atmosphere is relatively clean, dry, well ventilated and non-corrosive. Refer to EN 60034: Part 5 for more detailed information on suitability of a particular enclosure rating.
2. Totally enclosed motors may be installed where dirt, moisture or dust are present and in outdoor locations. Refer to EN 60034: Part 5 for more detailed information on suitability of a particular enclosure rating.
3. Explosion proof motors have many different categories because hazardous atmospheres can consist of many different gases, which may or may not be present continuously. Individual countries/users can differ in their safety requirements so the suitability of an explosion proof motor for any particular hazardous location must be assessed against the standards and specifications in force for that location. They must not be used in hazardous locations unless it has been established that they do comply with the safety standards and specifications in force for that location.
4. Before installing, operating or carrying out maintenance services on electric motors used on hazardous locations, care must be taken on the following:
 - The standards listed in Annex A and B, applied to each case, must be studied and understood.
 - All requirements included in the applicable standards must be understood accordingly.
 - Instruction Marking as listed in Annex A and B
 - The Ambient temperature limits are as follows :
 - Ex d / Ex de do not exceed 50°C
 - Ex e does not exceed 40°C
 - Ex n and ExtD do not exceed 55°C
 - When anti-condensation heaters are fitted they are to be interlocked such that they can only be energized when the motor is de-energized.
 - The protection class and the IP-class of the cable entry devices when fitted must be at least the same as those of the terminal boxes.
 - When the motor on delivery, cable entry will be fitted with plastic plug to prevent mist and dust entering. But right after motor be installed, the surplus or unused cable entry must be plugged with ExCB certified plug (e.g. IEC Ex d , Ex e or Ex n) to the terminal box.

- The brass terminal link should be connected correctly and power supply bare wire can't bulge over the bushing nut so as not to reduce the clearance distance.

- In order to avoid bolt broken or wiring released, the nut tightening torque of terminal block and bushing must be observed according to table below

a. The motor for Ex d & Ex de

Frame size	Thread sizes	Tightening torque (Nm)
80 - 132	S7X0.8	4
132 - 180	S8X1	4
132 - 180	S10X1	6
200 - 280	S13X1	10
160 - 180	S14X1.25	10
160 - 180	S18X1.5	12.5
200 - 225	M4	1.2
200 - 280	M5	1.2
200 - 280	M6	3.5
200 - 280	M8	6

b. The motor for Ex e

Frame size	Thread sizes	Tightening torque (Nm)
71 - 112	S7X0.8	4
132 - 180	S10X1	6
200 - 225	S14X1.25	10
250	S18X1.5	12.5
280 - 315	M16	54.9 - 74.5

c. The motor for Ex n & Ex tD

Frame size	Thread sizes	Tightening torque (Nm)
63 - 71	M4	0.8 - 1.1
80 - 112	M5	1.6 - 2.2
132 - 180	M6	2.7 - 3.7
200 - 250	M8	6.7 - 8.9
280 - 315	M10	12.3 - 17.9
	M12	22.6 - 30.4
	M16	54.9 - 74.5

d. The motor for CNS Ex e, n & Ex tD

Frame size	Thread sizes	Tightening torque (Nm)
63 - 71	M4	0.8 - 1.1
80 - 112	M5	1.6 - 2.2
132 - 180	M6	2.7 - 3.7
200 - 250	M8	6.7 - 8.9
280 - 315	M10	12.3 - 17.9
	M12	22.6 - 30.4
	M16	54.9 - 74.5

- Ex d Special Conditions for Safe Use
 - a. The hexagon head bolts used in the assembly of the motors must be of minimum grade 4.6 steel in accordance with ISO 898-1(SAE 1008, SAE4137..), and grade 8.8 steel for endshields of frame size 200 and 225, and grade 12.9 steel for endshields of frame size 250 and 280.
 - b. To permit the use of the motor with variable frequency supplies up to a maximum frequency of 60Hz.
 - c. The motor is fitted with thermal protection in the form of one 150°C PTC thermistor per phase in the drive end stator winding overhang. These are to be connected to a protection circuit set so as to limit the stator temperature to 150°C; in this arrangement the Temperature Classification is T3.
 - d. When the motor is supplied with bearing insulation, the user is responsible for checking the effectiveness of such installations at appropriate intervals, e.g. by the use of a 100V insulation tester and by visual inspection to ensure that no unpainted, unearthed metal can be shorted to earth.
 - e. The assembly gap between T-cover and T-seat should be less than 0.15mm.

- Ex de Special Conditions for Safe Use
 - a. The hexagon head bolts used in the assembly of the motors must be of minimum grade 4.6 steel in accordance with ISO 898-1(SAE 1008, SAE4137..), and grade 8.8 steel for endshields of frame size 200 and 225, and grade 12.9 steel for endshields of frame size 250 and 280.
 - b. To permit the use of the motor with variable frequency supplies up to a maximum frequency of 60Hz.
 - c. The motor is fitted with thermal protection in the form of one 150°C PTC thermistor per phase in the drive end stator winding overhang. These are to be connected to a protection circuit set so as to limit the stator temperature to 150°C; in this arrangement the Temperature Classification is T3.
 - d. When the motor is supplied with bearing insulation, the user is responsible for checking the effectiveness of such installations at appropriate intervals, e.g. by the use of a 100V insulation tester and by visual inspection to ensure that no unpainted, unearthed metal can be shorted to earth.
 - e. The cable glands when installed in the increased safety terminal must provide a minimum of IP54 level of ingress protection.

- Ex e Special Conditions for Safe Use
 - a. Where 'Ex e' motors are applied as variable speed (VVVF) drives, each motor and its specified controller shall be tested as a combination unit in accordance with IEC 60079-0, IEC 60079-7, TECO test procedures and the duty cycle for each application to ensure that the limiting temperature and temperature class are not exceeded.
 - b. For 'Ex e' applications, the electrical protection shall be set in accordance with the t_E time for each motor given in the relevant drawing from the Certified Drawing list, depending on motor type as detailed in table below.

Protection	MOTOR TYPE - HORIZONTAL FOOT HORIZONTAL FOOT / FLANGE			MOTOR TYPE VERTICAL FLANGE / HORIZONTAL FLANG		
	Standard Efficiency IE1	High Efficiency IE2	Premium Efficiency IE1	Standard Efficiency IE1	High Efficiency IE2	Premium Efficiency IE1
Ex e	AEEBXE	AEHBXE	AEMBXE	AEVBXE	AEUBXE	AEMVXE
Ex nA	AEEBXJ	AEHBXJ	AEMBXJ	AEVBXJ	AEUBXJ	AEMVXJ
Ex tD	AEEBXD	AEHBXD	AEMBXD	AEVBXD	AEUBXD	AEMVXD
FRAME	71~315M	80~315M	80~315M	71~315M	80~315M	80~315M

- Ex n Special Conditions for Safe Use
 - a. Where 'Ex nA' motors are applied as variable speed (VVVF) drives, either each motor shall be type-tested for this duty in association with the specified converter and the protective devices provided or the motor temperature-rise shall be calculated in accordance with IEC 60079-0 and IEC 60079-15 for the duty required/specified to ensure that the limiting temperature and temperature class are not exceeded.
 - Ex tD Special Conditions for Safe Use
 - a. Where 'Ex tD' motors are applied as variable speed (VVVF) drives each motor shall be fitted with at least three thermistors, one in each phase having a reference temperature so as to ensure that the winding insulation is adequately protected against overheating for the insulation used, and supply is disconnected before its limiting temperature has been exceeded under the worst conditions of operation. The temperature class shall not be exceeded.
5. eG3 motors are designed according to Japanese Industrial Standard JIS C0903. In Japan, they are used in areas where certain types of ignitable concentrations of flammable gases, vapors or liquids are not likely to exist under normal operating conditions. Before using any EG3 motor in such a location, ensure that safety standards and specifications in force for that location permit its use.
6. Chemical duty enclosed motors are designed for installation in locations where they may encounter corrosive substances and/or high moisture.

Note : In all locations the surroundings must not obstruct the normal flow of ventilating air to and from the motor.

MOUNTING

1. Ensure the orientation of the frame is appropriate for the design of the motor. For instance, motors designed for B3 (horizontal shaft), may not be suitable without modification for V5 (vertical shaft) because any drain holes will be in the wrong position, additional fixings may be required to prevent the shaft sliding through the bearings and different bearings may be needed to withstand the thrust force.

Drip proof motors may not be drip proof in the wrong orientation.

Consult TECO to establish whether a motor may be safely used in an orientation different from that ordered.
2. Where the motor is to be subject to a high degree of vibration (such as on a vibrating screen), high humidity (typically above 95%), abnormal ambient temperature (typically outside the range -20 to +45°C), or high altitude (typically above 1000meter) ensure that the motor specification is appropriate.
3. When mounting the motor, ensure this is done securely using steel nuts and bolts through each of the fixing holes provided, fully tightened. Where the location is likely to cause rusting, such as in the presence of sea water, stainless steel fixing bolts may be an advantage. Where there is significant vibration, ensure there are shakeproof washers under the nuts.

4. Where the drain holes are to be left open, ensure they are guarded from access when the motor windings are connected to a power supply.
5. With a directly-coupled load ensure the motor and load shafts are accurately aligned and use a flexible coupling between them. Mounting bolts must be carefully tightened to avoid alignment changes and the alignment rechecked to ensure it is correct when the bolts are fully tight.
6. With a side-coupled load, such as a belt or gear drive, ensure the side force on the shaft will not damage the motor. Consult TECO if in doubt.

POWER SUPPLY AND CONNECTIONS

1. Wiring of the motor and its controller, overload protection and earthing should be in accordance with the current edition of the IEE wiring regulations, EN60204 and all local safety requirements.
2. Refer to the nameplate voltage, frequency and current to ensure the motor is correct for the material of wire and the power supply to which it is to be connected. Unless specified otherwise the motor may be assumed to be suitable for the nameplate voltage $\pm 5\%$ and nameplate frequency $\pm 1\%$.
3. Connection diagrams for the motor are generally supplied with it, either on the nameplate, fixed to the motor or placed in the terminal box.
4.  All TECO UL listed Explosion Proof motors have temperature limiting devices in the motor enclosure to help prevent excessive external surface temperature of the motor in accordance with UL standards. Terminals (P1, P2) of thermal protectors in these motors must be connected to the motor control equipment according to the connection diagram inside the terminal box.

Start up

1. Initially, run the motor unloaded and establish that the rotation direction is as required. If not, switch off and when rotation has stopped:
 - if the motor is a three phase motor – interchange any two phases.
 - if the motor is a single phase motor – interchange the connections to the auxiliary winding circuit, leaving the connections to the main winding unchanged.
2. Then start the motor fully loaded. If it does not start quickly and run smoothly, switch off immediately and when rotation has stopped, isolate from the power supply and examine the assembly for mechanical faults or poor connections.
3. If there is excessive vibration it could be caused by poorly-aligned couplings, loose mounting bolts, lack of rigidity in the supports, transmitted vibration from adjacent machinery etc. Excessive vibration can lead to motor damage, for instance to the bearings making them noisy, and hence vibration should be minimized.
4. Ensure the current drawn is commensurate with that shown on the nameplate and that the currents in each phase are similar.

5. If a single phase motor does not start, this may be due to the internal starting switch not closing when the rotor is stationary or a faulty starting capacitor.

Long term storage and humid environments

1. If the motor has been stored for an extensive period or subjected to adverse moisture conditions, ensure the insulation resistance is greater than 1M Ohm before switching on. Also, regrease the bearings and if they are rusty, replace them.

When the insulation resistance is not greater than 1M Ohm, dry out the motor as described below. If after drying out the insulation resistance is still not greater than 1M Ohm, the motor will need repairing.

2. Place

- (a) High and dry, well-ventilated without direct sun, dust or corrosive gas.
- (b) Not located near to a boiler or freezer.
- (c) Entirely free from vibration and easy for movements.
- (d) Motors should be put on pallets to prevent moisture.

Drying out

This may be carried out either:

1. By baking in an oven at up to 90°C. Ensure the interior and exterior of the oven are well ventilated.
2. By locking the rotor so it cannot move and connecting a low voltage to the motor windings. gradually increase the voltage from zero until the current is about one third the rating plate value. Trim the voltage as necessary so that the winding temperature remains below 90°C.

Drying out is complete when the insulation resistance stops changing.

Maintenance

Inspection

Inspect the motor at regular intervals. Ensure it is kept clean with clear ventilation openings, there is no excessive vibration and noise emitted from the motor are normal. Ensure fixings and fasteners have not loosened nor so corroded that either their strength has been reduced significantly or earthing has been impaired, Ensure also that electrical connections are tight and uncorroded and that earthing is intact.

Inspect shaft seals and terminal box gaskets to ensure they are in position and not significantly worn. Contact TECO if the seal/gasket types on the motor are unknown. Examine the paint finish and repaint if necessary to avoid excessive corrosion. Ensure that shaft couplings are fixed firmly and that shaft alignment is correct. Ensure also that there is no build up of liquid inside the motor that would adversely affect its performance and drain if there is.

Lubrication

Motors with double shielded (suffix "zz" on bearing type) bearings are lubricated for life and cannot be relubricated.

Larger frames (usually Frames 200 and above, 180 2 pole) in particular have regreasing facilities. These motors are shipped already-greased and the grease should be replaced at regular intervals. The length of the interval varies with size of motor and how it is used. The table below gives a guide to relubrication intervals. Excessive or too frequent lubrication may actually damage the motor.

If roller bearing is used, add a small quantity of grease when abnormal sound occurred from the bearings. If this sound, such as shi-shi or thru-thru, disappears temporarily after regreasing, it is normal condition and can operate as it is, as long as the temperature rise of the bearing is normal.

Rated output kW	Poles	Relubrication period		
		Standard conditions	Severe conditions	Extreme conditions
0-30	4 upwards	7 years	3 years	6 months
37-75	4 upwards	210 days	70 days	30 days
90-110	4 upwards	90 days	30 days	15 days
132-600	4 upwards	90 days	30 days	15 days
0-18.5	2	5 years	2 years	3 months
22-75	2	180 days	60 days	30 days
90-110	2	90 days	30 days	30 days
132-600	2	90 days	30 days	15 days

For other ratings please refer to TECO

Definitions

Standard conditions: 8 hour operation per day with rated or light loading in a clean low-vibration environment

Severe conditions: 24 hour operation per day with rated/light loading or in a dirty/dusty environment or where the motor is subject to vibration/light shock loading

Extreme conditions: Where there is heavy shock loading or high vibration or a very dirty/dusty environment

Regreasing operation

 If regreasing is to be carried out with the motor running, ensure it is done only by properly-trained personnel and that live and that live and moving parts are fully guarded.

Ensure the grease exit is open and the grease nipple is clean.

Attach a low pressure grease gun to the nipple and pump in grease until clean grease emerges at the grease exit.

Remove the grease gun. Fully guard live and moving parts and then run the motor for 10-30 minutes ensuring that any surplus grease is properly disposed of, and then refit any grease exit plug.

Grease Type

Ensure only the correct type of grease is used. Greases incompatible with that in the bearings can greatly reduce the bearing life. Consult TECO if you are not sure of the type supplied in your TECO motor.

TECO standard regreasable motors use MULTEMP SRL or ALVANIA RL3 grease. Information on the lubrication nameplate shall be followed as first priority.

Spares

Use only genuine TECO spares or alternatives recommended by TECO. When ordering, please give full nameplate details and in particular:

Frame Number	Type	Poles	kW	Serial Number
Quantity required				

Disposal of unserviceable and end-of life motors and parts.

The motors consist by weight, primarily of cast iron, steel, copper and aluminium alloy.

They also have some plastic material for instance, for insulation, sealing and termination of conductors and varnish for impregnation of the winding. The fan and internal baffles may be of plastic.

Typically the metals are recyclable by burning off in a furnace the non-metallic material and either breaking or melting the metals into their constituents. Ensure the gases given off during the burning do not pollute.

The furnace may need a license or evidence giving them exemption (for instance if they are small) to carry this out.

The above suggestions for recycling should be taken as guidance only. Dispose of according to the regulations in force locally.

TECO ELECTRIC & MACHINERY CO., LTD
10F, No.3-1, Yuan Cyu St. Nan-Kang Taipei 115, Taiwan
TEL : +886-2-6615-9111
FAX : +886-2-6615-2253
+886-2-6615-1220
Web : <http://www.teco.com.tw>
<http://www.tecomotor.com.tw>

31057H402E

10/15
REV.12

Annex A

Certification Marking & Number: Ex d /Ex de

Frame	Marking (note 1)		Certificate Number		Standard
	ATEX	IECEX-	ATEX	IECEX-	
80	II 2 G Ex d IIB T3-T4	Ex d IIB T3-T4	Baseefa 08ATEX-0298X	IECEX BAS08.0101X	EN 60079-0: 2006
90	II 2 G Ex de IIC T3-T4	Ex de IIC T3-T4	Baseefa 08ATEX-0299X	IECEX BAS08.0096X	EN 60079-1: 2007
100	II 2 G Ex d IIB T3-T4	Ex d IIB T3-T4	Baseefa 08ATEX-0300X	IECEX BAS08.0100X	EN 60079-7: 2007
112	II 2 G Ex de IIC T3-T4	Ex de IIC T3-T4	Baseefa 08ATEX-0301X	IECEX BAS08.0097X	IEC 60079-0: 2004
132	II 2 G Ex d IIB T3-T4	Ex d IIB T3-T4	Baseefa 07ATEX0295X	IECEX BAS09.0066X	IEC 60079-1: 2007
	II 2 G Ex de IIC T3-T4	Ex de IIC T3-T4	Baseefa 07ATEX0296X	IECEX BAS09.0067X	IEC 60079-7: 2006
160	II 2 G Ex d IIB T3-T4	Ex d IIB T3-T4	Baseefa 08ATEX-0302X	IECEX BAS08.0099X	
180	II 2 G Ex de IIC T3-T4	Ex de IIC T3-T4	Baseefa 08ATEX-0303X	IECEX BAS08.0098X	
200	II 2 G Ex d IIB T3-T4	Ex d IIB T3-T4	Baseefa 08ATEX-0113X	IECEX BAS09.0044X	
225	II 2 G Ex de IIC T3-T4	Ex de IIC T3-T4	Baseefa 08ATEX-0114X	IECEX BAS09.0045X	
250	II 2 G Ex d IIB T3-T4	Ex d IIB T3-T4	Baseefa 08ATEX-0115X	IECEX BAS09.0046X	
280	II 2 G Ex de IIC T3-T4	Ex de IIC T3-T4	Baseefa 08ATEX-0116X	IECEX BAS09.0047X	

Annex B

Certification Marking & Number: Ex e / Ex n / Ex tD

Frame	Marking			Certificate Number	Standard
	Ex e	Ex n	Ex tD	IECEX-	
71 to 250	Ex e IIC T3 Gb	Ex nA IIC T3 Gc	Ex tD A21 T135°C IP66	IECEX TSA 12.0018X	AS/NZS 60079-0: 2008 AS/NZS 60079-7: 2006 AS/NZS 60079-15: 2006
280 to 315	Ex e IIC T3 Gb	Ex nA IIC T3 Gc	Ex tD A21 T135°C IP66	IECEX TSA 12.0016X	AS/NZS 61241.0 2005 AS/NZS 61241.1 2005
315A to 355	Ex e IIC T3 Gb	Ex nA IIC T3 Gc	Ex tD A21 T135°C IP66	IECEX TSA 12.0017X	

TECO

INSTALLATION & MAINTENANCE

INSTRUCTIONS

TECO INDUCTION MOTORS UP TO 600KW



TECO Electric & Machinery Co., Ltd.

31057H402E

12/15
REV.12



TECO Electric & Machinery Co., Ltd.

10F, No.3-1, Yuan Cyu St., Nan-Kang,
Taipei 115, Taiwan

TEL:886-2-6615-9111
FAX:886-2-6615-2253

EC DECLARATION OF CONFORMITY

We, **TECO ELECTRIC & MACHINERY CO., LTD.**
11, An Tung Road, Chung Li Industrial District,
Taoyuan 320, Taiwan

Declare under our sole responsibility that the 3-phase squirrel cage induction motors :

AEEBXZ, AEVBXZ, AEHBXZ , and AEUBXZ, as listed on page 2 in this document.

to which this declaration relates, are in conformity with the following European Union Directives and standards identified in this declaration, if the motors are operated according to our "Operation & Maintenance Manual" .

EU Directives

ATEX Directive 94/9/EC

Low Voltage Directive 2006/95/EC

EMC Directive 2004/108/EC

Standards

EN60079-0:2009 Electrical apparatus for explosive gas atmospheres,
General requirements

EN60079-1:2007 Electrical apparatus for explosive gas atmospheres,
Flameproof enclosures "d"

EN60079- 7:2007 Electrical apparatus for explosive gas atmospheres,
Increased safety "e"

EN60034-1:2010 Rotating electrical machines, Rating and performance

EN61000-6-4:2007 Emission Standard for industrial environments

*Notified Body: Baseefa (1180); Rockhead Business Park, Staden Lane, Buxton,
Derbyshire SK17 9RZ, UK

Sam Huang

Director

R&D Center

6 September , 2012

ETR-DLD-021

REV.01



TECO Electric & Machinery Co., Ltd.

10F, No.3-1, Yuan Cyu St., Nan-Kang,
Taipei 115, Taiwan

TEL:886-2-6615-9111
FAX:886-2-6615-2253

Certificates: 3-phase induction motors, AEEBXZ, AEVBXZ, AEHBXZ , and AEUBXZ.

Ex d

IEC Frame Size	Group & Category Temperature Class		Certification Number	
	ATEX	IECEX	ATEX	IECEX
80	II 2 G Ex d IIB T3-T4	Ex d IIB T3-T4	Baseefa 08ATEX-0298X	IECEX BAS08.0101X
90	II 2 G Ex de IIC T3-T4	Ex de IIC T3-T4	Baseefa 08ATEX-0299X	IECEX BAS08.0096X
100	II 2 G Ex d IIB T3-T4	Ex d IIB T3-T4	Baseefa 08ATEX-0300X	IECEX BAS08.0100X
112	II 2 G Ex de IIC T3-T4	Ex de IIC T3-T4	Baseefa 08ATEX-0301X	IECEX BAS08.0097X
132	II 2 G Ex d IIB T3-T4	Ex d IIB T3-T4	Baseefa 07ATEX0295X	IECEX BAS09.0066X
	II 2 G Ex de IIC T3-T4	Ex de IIC T3-T4	Baseefa 07ATEX0296X	IECEX BAS09.0067X
160	II 2 G Ex d IIB T3-T4	Ex d IIB T3-T4	Baseefa 08ATEX-0302X	IECEX BAS08.0099X
180	II 2 G Ex de IIC T3-T4	Ex de IIC T3-T4	Baseefa 08ATEX-0303X	IECEX BAS08.0098X
200	II 2 G Ex d IIB T3-T4	Ex d IIB T3-T4	Baseefa 08ATEX-0113X	IECEX BAS09.0044X
225	II 2 G Ex de IIC T3-T4	Ex de IIC T3-T4	Baseefa 08ATEX-0114X	IECEX BAS09.0045X
250	II 2 G Ex d IIB T3-T4	Ex d IIB T3-T4	Baseefa 08ATEX-0115X	IECEX BAS09.0046X
280	II 2 G Ex de IIC T3-T4	Ex de IIC T3-T4	Baseefa 08ATEX-0116X	IECEX BAS09.0047X

ETR-DLD-021
REV.01

PRODUCT NOTE CHANGE NOTICE

DWG. NO. 31057H402E TECO'S MODEL : DANGER AND WARNING IN APPLICATION OF ELECTRIC INDUCTION MOTOR

Revision Date	VOL.	Revised or New Material
APR . 08 . ' 02	01	Revised Pages: 8 (Chang Company address and add web address)
DEC . 16 . ' 03	02	Revised Pages: 1 (Add EECS Special Conditions For Safe Use)
DEC . 18 . ' 03	03	Revised Pages: 8 (Chang Company Fax No. and web address)
JUN . 10 . ' 06	04	Revised Pages: 8 (Chang Company address and Fax No.)
OCT . 18 . ' 06	05	Revised Pages: 5 (Add 2.Place)
APR . 30 . ' 07	06	Add1:Revised Pages: 1 (This instruction manual is for TECHNICAL USE ONLY, NOT FOR COMMERCIAL PURPOSE. The warranty is limited to coverage expressed in your sales contract. Documentation of storage, transportation, installation and examination, if required, shall be inquired of TECO's service center before start and maintenance.) Add2: Revised Pages: 6 (If roller bearing is used , add a small quantity of grease when abnormal sound occurred from the bearings . If this sound , such as shi-shi or thru-thru, disappears temporarily after regreasing, it is normal condition and can operate as it is, as long as the temperature rise of the bearing is normal.) Change:Revised Pages: 7 Grease Type TECOALVANIA RL3....
JUN . 30 . ' 07	07	Change: Revised Pages: 3 (Location: 4th revises)
May. 18 . ' 09	08	Chang: Revised Pages: 1 (Baseefa Ex Certification Products Special ...) Add1:Revised Pages:3 (Instruction Marking as listed in Annex A.) Add1:Revised Pages:9 (Annex A)
May.24.'10	09	Revised Pages: 3 (Chang:c.... 150°C PTC...) Revised Pages:3 (Add:Ex d Special Conditions for Safe Use. Item .e,f,g.)
Sep.13.'10	10	Revised Pages: 1 (Chang:2. ExCB Ex n Certification...)
June.08.' 11	11	Revised Pages: 11,12 (Add:Ex d EC Declaration of Conformity)
July.03 '12	12	Add1:Revised Page:2 (17.Dust Ignition Proof...) Add2:Revised Page:3 (-Ambient temperature does not...)(-When anti-condensation heaters...)(-The protection class and the...)(-When the motor on delivery...)(-The brass terminal...)(-In order to avoid...) Add3:Revised Page:5 (Exd · Exde · Exe · Exn & ExtD special conditions for safe use) Add4:Revised Page:11 (Annex B) Change1: Revised Pages:3 (...and B...) Change2: Revised Pages:7 (...and current...the material of wire) Change3: Revised Pages:12,13 (Ex d EC Declaration of Conformity REV.01)

ST	1
TM	1
外 ₁	1
外 ₂	1
研	4
握	2
品	1
二	1
重	2

APPD.	Sam.Huang	NOV.13.'12	東元電機股份有限公司 TECO Electric & Machinery Co., Ltd. TAIWAN	DWG NO:	31057H402E
CHKD.	M.C.Tsai	NOV.12.'12		REV.12	
DWN.	P.J.Hsieh	NOV.12.'12			

31057H402E