

EQ SERIES

EQ7

High Performance, Full-Featured Drive

Constant Torque 1 - 900 hp

Variable Torque 1 - 1000 hp



Features and Benefits

State of the art engineering and robust, best-in-class performance.

CONTROL FEATURES

- Four selectable control modes – Volts/Hertz, Dynamic Torque, Sensorless Vector, Closed Loop Vector
- Provides drive solutions for today's demanding motor driven machinery

ADVANCED SPEED AND TORQUE CONTROL CAPABILITIES

- High levels of torque boost attainable
- Power loss ride through
- Torque limit adjustable features

ADVANCED TUNING FEATURES

- High level of detail and information regarding applied motors
- Motor types range from variable torque to full flux vector motors

PID LOOP CONTROL FEATURES

- Process or Dancer control
- Loss of feedback detection
- Sleep-wake mode
- High and low feedback alarms
- Wide variety of process set point signals to choose from

CLOSED LOOP SPEED CONTROL

- 100 Hz speed loop bandwidth
- Full-quadrature encoder feedback with marker pulse
- Range: 20 – 60,000 counts/ revolution
- Loss of encoder signal detection with alternative operation selection
- PI speed loop with adjustable gains and notch filtering

EXTENSIVE INPUT/ OUTPUT CAPABILITIES

- Forward and Reverse inputs plus seven assignable digital inputs
- Over 50 settings available; each assignable as normally open or normally closed state
- Three analog inputs; 0 to $\pm 10V$ or 0 to 10V, 4 to 20 ma, 0 to $\pm 10V$ signals
- Assignable frequency reference, PID set point or feedback, torque reference, torque gain plus many choices
- Two analog outputs: selectable as 0 to 10V or 4 to 20ma output, scaling, plus over a dozen configuration choices such as output frequency, current, voltage, torque plus more.
- Four transistor type outputs; over 50 settings available; each assignable as normally open or normally closed state
- Two assignable contact outputs; over 50 settings as with the transistor outputs
- Pulse train input

MONITORING AND DIAGNOSTICS

- Extensive monitoring capabilities
- Detailed status information for all recorded faults (up to 4)
- Cumulative operating time displays for component maintenance
- Output frequency reduction to avoid overload trips and transistor junction over temperature

Applications

Application Type	V/F Mode	Dynamic Torque Mode	Sensorless Vector Mode	Closed-Loop Vector Mode
Fans and Blowers	X			
Centrifugal Pumps	X	X		
Mixers	X	X		
Conveyors	X	X	X	
Hoist / Elevator		X	X	
Stamping / Punch Press		X	X	
Dynamometers			X	X
Extruders			X	X
Web / Roll Processes				X
Torque Regulation		X		
Direct Torque Control				X
Indexing Operations			X	X
Positioning *				X

* Requires External Positioning Controller Interface



Keypad Panel Functions and Operations

FEATURES:

- LED and LCD display for user-friendly monitoring
- Extensive monitoring and diagnostics
- Configuration menus including a Quick-start menu
- Stores configuration settings for easy download

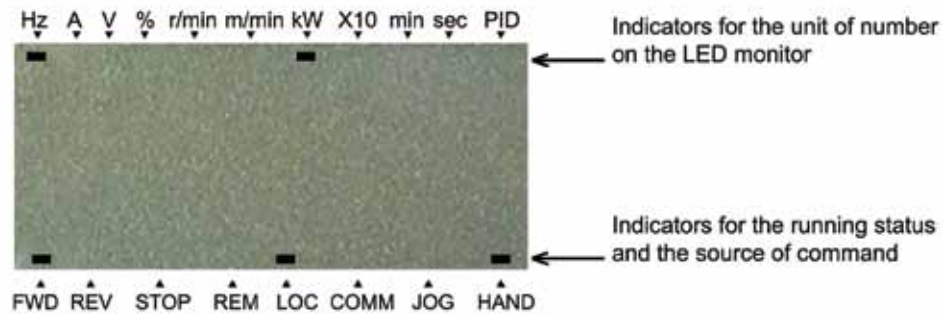
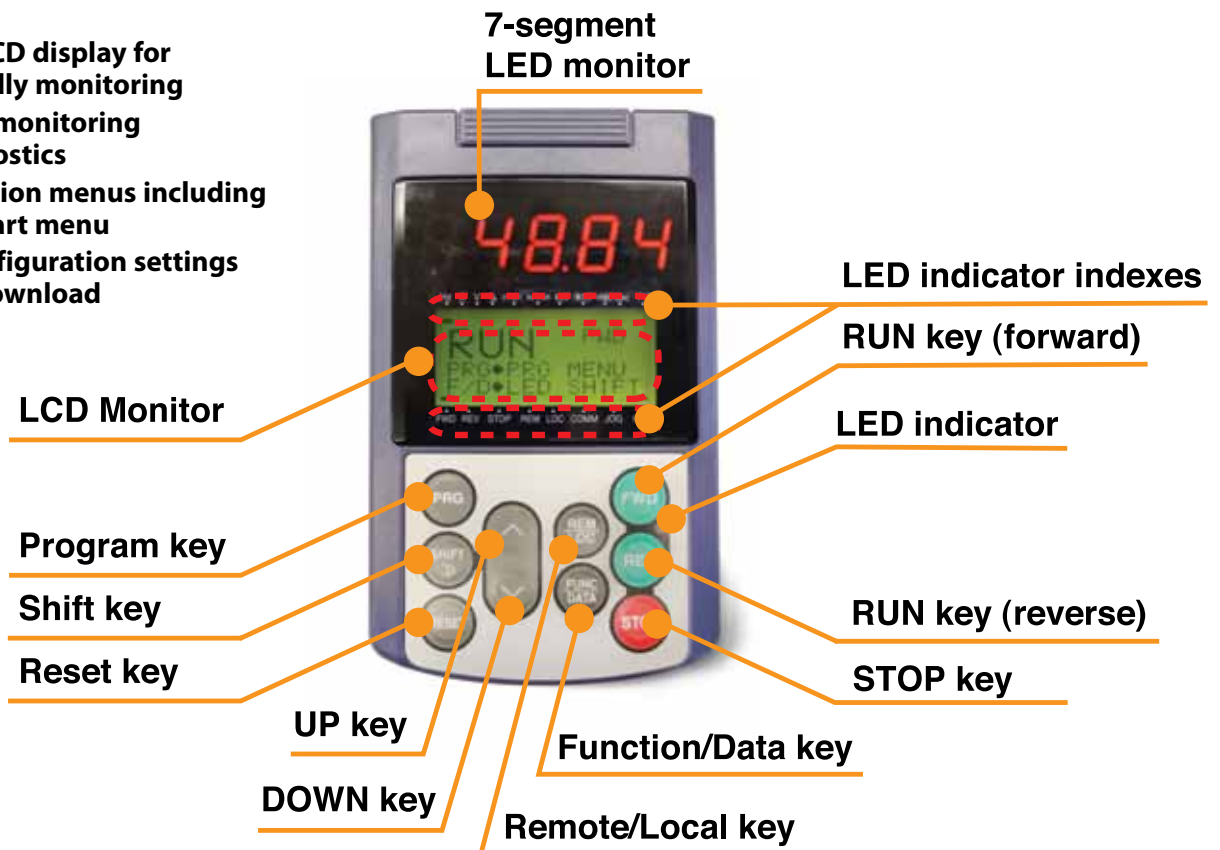

Type	Item	Description (information, condition, status)
Unit of Number Displayed on LED Monitor	Hz	Output frequency, frequency command
	A	Output current
	V	Output voltage
	%	Calculated torque, load factor, speed
	r/min	Motor speed, set motor speed, load shaft speed, set load shaft speed
	m/min	Line speed, set line speed
	kW	Input power, motor output
	X10	Data greater than 99,999
	min	Constant feeding rate time, constant feeding rate time setting
	sec	Timer
Operating Status	PID	PID process value
	FWD	Running (forward rotation)
	REV	Running (reverse rotation)
Source of Operation	STOP	No output frequency
	REM	Remote mode
	LOC	Local mode
	COMM	Communication enabled (RS-485 (standard, optional) field bus option)
	JOG	Jogging mode
	HAND	Keypad effective (lights also in local mode)

Constant Torque/ Variable Torque - 230V Series

Constant Torque

Item			Specifications																	
Model EQ7-2XXX-C			001	002	003	005	007	010	015	020	025	030	040	050	060	075	100	125	150	
Nominal applied motor hp ^{*1} for three phase input			1	2	3	5	7.5	7.5	10	15	20	25	30	40	50	60	75	100	125	
Nominal applied motor hp ^{*1} for single phase input			0.5	1	1.5	3	3	3	5	7.5	10	10	15	20	25	30	30	40	40	
Output ratings	Three phase input ^{*9}	Rated capacity ^{*2} [kVa]	2	3.2	4.4	7.2	11	11	15	20	25	30	36	47	58	72	86	113	138	
		Rated current [A]	5	8	11	18	27	27	37	49	63	76	90	119	146	180	215	283	346	
	Rated voltage ^{*3} [V]		Three-phase, 200 to 240V (with AVR function)										Three-phase 200 to 230V (with AVR function)							
	Overload Capability		150%-1 min, 200% -3.0 s																	
Input ratings	Three phase input	Voltage, frequency	Three-phase, 200 to 240V, 50/60Hz										Three-phase, 200 to 220V, 50Hz Three-phase, 200 to 230V, 60Hz							
		Voltage, frequency variations	Voltage +10 to -15% (Interphase voltage unbalance: 2% or less), ^{*5} Frequency +5 to -5%																	
		Input current with DCR	3	5.5	7.7	13	18.5	18.5	25.1	37.6	50.2	62.7	75.3	100	120	145	178	246	291	
		Input current without DCR	4.7	8.5	11.9	20	28.4	28.4	38.6	54.8	72.4	87.7	101	136	167	203	-			
		Required capacity with DCR ^{*6} [kVa]	1.2	2.2	3.1	5.2	7.4	7.4	10	15	20	25	30	40	48	58	71	98	116	
Braking	Torque ^{*7} [%]		150%	100%					20%					10 to 15%						
	Braking transistor		Built-in										-							
	Built-in braking resistor		Built-in										-							
	Braking time [s]		5 s										-							
	%ED		3	5	3	2	3	3	2	-										
DC reactor (DCR)			Option													As standard ^{*8}				
Keypad			Multi-function keypad																	
Applicable Safety Standards			UL508C, C22.2 No.14, EN61800-5-1:2007, EN61800-5-2:2007 SIL2, EN ISO13849-1:2008 PL=d Cat.3, EN954-1:1996 Cat.3																	
Enclosure (IEC60529)			IP20, UL open type, NEMA 1 (Option)										IP00, UL open type, NEMA 1 (Option)							
Cooling method			Natural Cooling					Fan cooling												
Weight/ Mass [lbs(kg)]			4.4 (2.0)	6.2 (2.8)	6.6 (3.0)	6.6 (3.0)	14.3 (6.5)	14.3 (6.5)	14.3 (6.5)	12.8 (5.8)	20.9 (9.5)	20.9 (9.5)	22 (10)	55.1 (25)	70.6 (32)	92.6 (42)	94.8 (43)	137 (62)	231 (105)	

Variable Torque mode

Item			Specifications																		
Model EQ7-2XXX-C			001	002	003	005	007	010	015	020	025	030	040	050	060	075	100	125	150		
Nominal applied motor hp ^{*1} for three phase input			1	2	3	5	7.5	10	15	20	25	30	40	50	60	75	100	125	150		
Nominal applied motor hp ^{*1} for single phase input			0.5	1	1.5	3	3	5	7.5	10	10	15	20	25	30	30	40	40	50		
Output ratings	Three phase input ^{*9}	Rated capacity ^{*2} [kVa]	2	3.2	4.4	7.2	11	13	18	24	30	35	46	58	72	86	113	138	165		
		Rated current [A] ⁴	5	8	11	18	27	31.8	46.2	59.4	74.8	88	115	146	180	215	283	346	415		
	Rated voltage ^{*3} [V]		Three-phase, 200 to 240V (with AVR function)										Three-phase 200 to 230V (with AVR function)								
	Overload Capability		150%-1 min, 200% -3.0 s					120%-1 min													
Input ratings	Three phase input	Voltage, frequency	Three-phase, 200 to 240V, 50/60Hz										Three-phase, 200 to 220V, 50Hz Three-phase, 200 to 230V, 60Hz								
		Voltage, frequency variations	Voltage +10 to -15% (Interphase voltage unbalance: 2% or less), ^{*5} Frequency +5 to -5%																		
		Input current with DCR	3	5.5	7.7	13	18.5	25.1	37.6	50.2	62.7	75.3	100	120	145	178	246	291	358		
		Input current without DCR	4.7	8.5	11.9	20	28.4	38.6	54.8	72.4	87.7	101	136	167	203	244	-				
		Required capacity with DCR ^{*6} [kVa]	1.2	2.2	3.1	5.2	7.4	10	15	20	25	30	40	48	58	71	98	116	143		
Braking	Torque ^{*7} [%]		150%	100%			70%			15%					7 to 12%						
	Braking transistor		Built-in										-								
DC reactor (DCR)			Option													As standard ^{*8}					
Keypad			Multi-function keypad																		
Applicable Safety Standards			UL508C, C22.2 No.14, EN61800-5-1:2007, EN61800-5-2:2007 SIL2, EN ISO13849-1:2008 PL=d Cat.3, EN954-1:1996 Cat.3																		
Enclosure (IEC60529)			IP20, UL open type, NEMA 1 (Option)										IP00, UL open type, NEMA 1 (Option)								
Cooling method			Natural Cooling					Fan cooling													
Weight/ Mass [lbs(kg)]			4.4 (2.0)	6.2 (2.8)	6.6 (3.0)	6.6 (3.0)	14.3 (6.5)	14.3 (6.5)	14.3 (6.5)	12.8 (5.8)	20.9 (9.5)	20.9 (9.5)	22 (10)	55.1 (25)	70.6 (32)	92.6 (42)	94.8 (43)	137 (62)	231 (105)		

(*1) 4-pole standard motor

(*2) Rated capacity is calculated by assuming the output rated voltage as 230V for 230V series and 460V for 460V series.

(*3) Output voltage cannot exceed the power supply voltage. At single-phase input use, the output voltage may be lower than three-phase input.

(*4) To use the inverter with the carrier frequency of 3 kHz or more at ambient temperature of 40°C (104°F) or higher, please consult the instruction manual for modified amp ratings at these conditions

(*5) Voltage unbalance[%] = (Max.voltage [V] - Min. voltage [V])/Three-phase average voltage [V]x67(See IEC61800-3.) If this value is 2 to 3%, use an optional AC reactor (ACR).

(*6) Required when a DC reactor (DCR) is used.

(*7) Without external braking resistor condition. Average braking torque for the motor running alone. (It varies with the efficiency of the motor.)

(*8) For inverters of 100 hp or above, the DC reactor is provided as separate standard component. be sure to connect it to those inverters.

(*9) For single-phase input installations, please consult factory.

Constant Torque - 460V Series

Constant Torque mode designed for constant torque loads

Item			Specifications															
Model EQ7-4XXX-C			001	002	003	005	007	010	015	020	025	030	040	050	060	075	100	
Nominal applied motor hp ^{*1} for three phase input			1	2	3	5	7.5	7.5	10	15	20	25	30	40	50	60	75	
Nominal applied motor hp ^{*1} for single phase input			0.5	1	1.5	3	3	3	5	7.5	10	10	15	20	25	30	30	
Output ratings	Three phase input ^{*9}	Rated capacity ^{*2} [kVa]	2	3.2	4.4	7.2	11	11	15	20	25	31	36	48	60	73	89	
		Rated current [A]	2.5	4	5.5	9	13.5	13.5	18.5	24.5	32	39	45	60	75	91	112	
	Rated voltage ^{*3} [V]		Three-phase, 380 to 480V (with AVR function)															
	Overload Capability		150%-1 min, 200% -3.0 s															
Input ratings	Three phase input	Voltage, frequency	Three-phase, 380 to 480V, 50/60Hz															
		Voltage, frequency variations	Voltage +10 to -15% (Interphase voltage unbalance: 2% or less), ^{*5} Frequency +5 to -5%															
		Input current with DCR	1.5	2.6	4	6.6	9.2	9.2	12.4	18.8	25	31	36	50	60	72	89	
		Input current without DCR	2.6	5.1	7.1	11.3	15	15	20.1	28.6	38	45.4	52.6	67.7	82	99.1	-	
		Required capacity with DCR ^{*6} [kVa]	1.2	2.1	3.2	5.3	7.4	7.4	9.9	15.0	20.0	25.0	29.0	40.0	48.0	58.0	71.0	
Braking	Torque ^{*7} [%]		150%	100%					20%					10 to 15%				
	Braking transistor		Built-in															
DC reactor (DCR)			Option															Std ^{*8}
Keypad			Multi-function keypad as standard															
Applicable Safety Standards			UL508C, C22.2 No.14, EN61800-5-1:2007, EN61800-5-2:2007 SIL2, EN ISO13849-1:2008 PL=d Cat.3, EN954-1:1996 Cat.3															
Enclosure (IEC60529)			IP20, UL open type, NEMA 1 (Option)										IP00, UL open type, NEMA 1 (Option)					
Cooling method			Natural Cooling					Fan cooling										
Weight/ Mass [lbs(kg)]			4.4 (2.0)	5.7 (2.6)	6.0 (2.7)	6.6 (3.0)	14.3 (6.5)	14.3 (6.5)	14.3 (6.5)	12.8 (5.8)	20.9 (9.5)	20.9 (9.5)	22 (10)	55.1 (25)	57.3 (26)	68.3 (31)	72.8 (33)	

Item			Specifications														
Model EQ7-4XXX-C			125	150	200	250	300	350	450	500	600	700	800	900	1000		
Nominal applied motor hp ^{*1} for three phase input			100	125/ 150	200	250	300	350	300	400/ 450	500	600	700	800	900		
Nominal applied motor hp ^{*1} for single phase input			40	150	60	60	75	100	100	125	150	150	200	250	300		
Output ratings	Three phase input ^{*9}	Rated capacity ^{*2} [kVa]	120	140	167	202	242	300	330	414	466	518	590	765	932		
		Rated current [A]	150	210 ^{*10}	253 ^{*10}	304 ^{*10}	377 ^{*10}	415 ^{*10}	465 ^{*10}	585 ^{*10}	650 ^{*10}	740 ^{*10}	840 ^{*10}	960	1170		
	Rated voltage ^{*3} [V]		Three-phase, 380 to 480V (with AVR function)														
	Overload Capability		150%-1 min, 200% -3.0 s														
Input ratings	Three phase input	Voltage frequency	Three-phase, 380 to 440V, 50Hz Three-phase, 380 to 480V, 60Hz														
		Voltage, frequency variations	Voltage +10 to -15% (Interphase voltage unbalance: 2% or less), ^{*5} Frequency +5 to -5%														
		Input current with DCR	120	143	176	207	250	311	340	436	487	547	614	767	970		
		Required capacity with DCR ^{*6} [kVa]	96	114	140	165	199	248	271	347	388	436	489	611	773		
Braking	Torque ^{*7} [%]		10 to 15%														
	Braking transistor		-														
DC reactor (DCR)			As standard ^{*8}														
Keypad			Multi-function keypad as standard														
Applicable Safety Standards			UL508C, C22.2 No.14, EN61800-5-1:2007, EN61800-5-2:2007 SIL2, EN ISO13849-1:2008 PL=d Cat.3, EN954-1:1996 Cat.3														
Enclosure (IEC60529)			IP00, UL open type, NEMA 1 (Option)														
Cooling method			Fan cooling														
Weight/ Mass [lbs(kg)]			93 (42)	137 (62)	141 (64)	207 (94)	216 (98)	284 (129)	309 (140)	540 (245)	540 (245)	805 (365)	805 (365)	1170 (530)	1170 (530)		

(*1) 4-pole standard motor

(*2) Rated capacity is calculated by assuming the output rated voltage as 230V for 230V series and 460V for 460V series.

(*3) Output voltage cannot exceed the power supply voltage. At single-phase input use, the output voltage may be lower than three-phase input.

(*5) Voltage unbalance[%] = (Max.voltage [V] - Min. voltage [V])/Three-phase average voltage [V]x67(See IEC61800-3.) If this value is 2 to 3%, use an optional AC reactor (ACR).

(*6) Required when a DC reactor (DCR) is used.

(*7) Without external braking resistor condition. Average braking torque for the motor running alone. (It varies with the efficiency of the motor.)

(*8) For inverters of 100 hp or above, the DC reactor is provided as separate standard component. Be sure to connect it to those inverters.

(*9) For single-phase input installations, please consult factory.

(*10) Please consult factory for constant torque vector control/ full load amps for these models.

Variable Torque - 460V Series

Variable Torque mode designed for variable torque load applications

Item			Specifications														
Model EQ7-4XXX-C			001	002	003	005	007	010	015	020	025	030	040	050	060	075	100
Nominal applied motor hp ^{*1} for three phase input			1	2	3	5	7.5	10	15	20	25	30	40	50	60	75	100
Nominal applied motor hp ^{*1} for single phase input			0.5	1	1.5	3	3	5	7.5	10	10	15	20	25	30	30	40
Output ratings	Three phase input ^{*9}	Rated capacity ^{*2} [kVa]	2	3.2	4.4	7.2	11	13.1	18.3	24	29	36	48	60	73	89	120
		Rated current [A]	2.5	4	5.5	9	13.5	16.5	23	30.5	37	45	60	75	91	112	150
	Rated voltage ^{*3} [V]		Three-phase, 380 to 480V (with AVR function)														
	Overload Capability		150%-1 min, 200% -3.0 s							120%-1 min							
Input ratings	Three phase input	Voltage, frequency	Three-phase, 380 to 480V, 50/60Hz														
		Voltage, frequency variations	Voltage +10 to -15% (Interphase voltage unbalance: 2% or less), ^{*5} Frequency +5 to -5%														
		Input current with DCR	1.5	2.6	4	6.6	9.2	12.5	18.8	25.1	31.3	36.3	50.2	60.2	72.7	89.1	120
		Input current without DCR	2.6	5.1	7.1	11.3	15	20.1	28.6	35	45.4	52.6	67.7	82	99.1	121	-
		Required capacity with DCR ^{*6} [kVa]	1.2	2.2	3.1	5.2	7.4	10	15	20	25	29	40	48	58	71	96
Braking	Torque ^{*7} [%]		150%	100%			70%			15			7 to 12%				
	Braking transistor		Built-in											-			
DC reactor (DCR)			Option													Std ^{*8}	
Keypad			Multi-function keypad as standard														
Applicable Safety Standards			UL508C, C22.2 No.14, EN61800-5-1:2007, EN61800-5-2:2007 SIL2, EN ISO13849-1:2008 PL=d Cat.3, EN954-1:1996 Cat.3														
Enclosure (IEC60529)			IP20, UL open type, NEMA 1 (Option)									IP00, UL open type, NEMA 1 (Option)					
Cooling method			Natural Cooling				Fan cooling										
Weight/ Mass [lbs(kg)]			4.4 (2.0)	5.7 (2.6)	6.0 (2.7)	6.6 (3.0)	14.3 (6.5)	14.3 (6.5)	14.3 (6.5)	12.8 (5.8)	20.9 (9.5)	20.9 (9.5)	22 (10)	55.1 (25)	57.3 (26)	68.3 (31)	72.8 (33)

Item			Specifications													
Model EQ7-4XXX-C			125	150	200	250	300	350	450	500	600	700	800	900	1000	
Nominal applied motor hp ^{*1} for three phase input			125	150	200	250	300	350	450	500	600	700	800	900	1000	
Nominal applied motor hp ^{*1} for single phase input			50	50	60	75	100	100	125	150	200	200	250	300	400	
Output ratings	Three phase input ^{*9}	Rated capacity ^{*2} [kVa]	140	167	202	242	300	331	414	518	590	669	765	932	1092	
		Rated current [A]	176	210	253	304	377	415	520	650	740	840	960	1170	1370	
	Rated voltage ^{*3} [V]		Three-phase, 380 to 480V (with AVR function)													
	Overload Capability		120%-1 min													
Input ratings	Three phase input	Voltage frequency	Three-phase, 380 to 440V, 50Hz Three-phase, 380 to 480V, 60Hz													
		Voltage, frequency variations	Voltage +10 to -15% (Interphase voltage unbalance: 2% or less), ^{*5} Frequency +5 to -5%													
		Input current with DCR	143	175	207	249	311	340	435	547	613	686	766	970	1093	
		Required capacity with DCR ^{*6} [kVa]	114	140	165	199	248	271	347	436	489	547	611	773	871	
Braking	Torque ^{*7} [%]		7 to 12%													
	Braking transistor		-													
DC reactor (DCR)			As standard ^{*8}													
Keypad			Multi-function keypad as standard													
Applicable Safety Standards			UL508C, C22.2 No.14, EN61800-5-1:2007, EN61800-5-2:2007 SIL2, EN ISO13849-1:2008 PL=d Cat.3, EN954-1:1996 Cat.3													
Enclosure (IEC60529)			IP00, UL open type, NEMA 1 (Option)													
Cooling method			Fan cooling													
Weight/ Mass [lbs(kg)]			93 (42)	137 (62)	141 (64)	207 (94)	216 (98)	284 (129)	309 (140)	540 (245)	540 (245)	805 (365)	805 (365)	1170 (530)	1170 (530)	

(*1) 4-pole standard motor

(*2) Rated capacity is calculated by assuming the output rated voltage as 230V for 230V series and 460V for 460V series.

(*3) Output voltage cannot exceed the power supply voltage. At single-phase input use, the output voltage may be lower than three-phase input.

(*5) Voltage unbalance[%] = (Max.voltage [V] - Min. voltage [V])/Three-phase average voltage [V]x67(See IEC61800-3). If this value is 2 to 3%, use an optional AC reactor (ACR).

(*6) Required when a DC reactor (DCR) is used.

(*7) Without external braking resistor condition. Average braking torque for the motor running alone. (It varies with the efficiency of the motor.)

(*8) For inverters of 100 hp or above, the DC reactor is provided as separate standard component. Be sure to connect it to those inverters.

(*9) For single-phase input installations, please consult factory.

Common Specifications

Variable Torque mode designed for variable torque load applications

Item		Specifications	
Output	Setting range	Maximum frequency 500 Hz (Constant Torque and dynamic torque modes) 200 Hz (CT-Vector and PG Feedback) 120 Hz (CT-Variable Torque and sensorless vector mode)	
		Base frequency 25 to 500 Hz variable setting (Variable Torque (Model EQ7-x0P5-C or above) and Constant Torque mode: 120 Hz)	
		Starting Frequency 0.1 to 60.0 Hz variable setting (sensorless vector control ^{(*)6} / vector control w/PG, 0.0Hz for ^{(*)7})	
		Carrier frequency <ul style="list-style-type: none"> • 0.75 to 16 kHz (Constant Torque: EQ7-x001-C to EQ7-x100-C, Variable Torque: EQ7-x001-C to EQ7-x040-C) • 0.75 to 10 kHz (CT-Vector: EQ7-x125-C to EQ7-x800-C, Variable Torque: EQ7-x050-C to EQ7-x100-C) • 0.75 to 2 kHz (Constant Torque V/F: EQ7-x150-C to EQ7-x800-C) • 0.75 to 6 kHz (CT-Vector: EQ7-x900-C to EQ7-x1000-C, Variable Torque: EQ7-x125-C to EQ7-x900-C) • 0.75 to 4 kHz (Variable Torque: EQ7-x1000-C) NOTE: Frequency drops automatically to protect the inverter depending on environmental temperature and output current. (This auto drop function can be cancelled)	
	Output frequency accuracy (Stability)	<ul style="list-style-type: none"> • Analog setting: $\pm 0.2\%$ of max. frequency (at $25 \pm 10^\circ\text{C}$)^{(*)1} • Digital setting: $\pm 0.01\%$ of max. frequency (at -10 to $+50^\circ\text{C}$) 	
	Setting resolution	<ul style="list-style-type: none"> • Analog setting: Analog setting: 1/3000 of max. frequency (1/1500 with V2 input) • Keypad setting: 0.01Hz (99.99Hz or less), 0.1Hz (100.0 to 500Hz) • Link setting: 1/20000 of max. frequency or 0.01 Hz (fixed) 	
Speed control accuracy	Speed control range	<ul style="list-style-type: none"> • Min. speed: Base speed 1:1500 (4P 1r/min to 1500r/min)^{(*)7} • Min speed: Base speed 1:200 (4P 7.5r/min to 1500r/min) 	
	Vector control with speed sensor	<ul style="list-style-type: none"> • Analog setting: $\pm 0.2\%$ of max. frequency (at $25 \pm 10^\circ\text{C}$) • Digital setting: $\pm 0.01\%$ of max. frequency (at -10 to $+50^\circ\text{C}$) 	
	Vector control without speed sensor	<ul style="list-style-type: none"> • Analog setting: $\pm 0.5\%$ or below of base speed (at $25 \pm 10^\circ\text{C}$) • Digital setting: $\pm 0.5\%$ or below of base speed (at -10 to $+50^\circ\text{C}$) 	
Control	Control method	<ul style="list-style-type: none"> • V/f control • Dynamic torque control • Vector control without speed sensor • Vector control with speed sensor (with an optional PG interface card mounted) 	
	Voltage/freq. characteristics	230V (460V) Series <ul style="list-style-type: none"> • Base Frequency and max. output frequency can be set to 80 to 240V (160-500V) in common. • The AVR control ON/OFF can be selected.^{(*)1} • Non-linear V/f setting (3 points) free voltage 0 to 240V (0-500V) and frequency (0 to 500Hz) can be set.^{(*)1} 	
	Torque boost	<ul style="list-style-type: none"> • Auto torque boost (for constant torque load)^{(*)1 to *2} • Manual torque boost: Desired torque boost (0.0 to 20.0%) can be set.^{(*)1} • Select application load with function code F37. (Variable torque load or constant torque load)^{(*)1} 	
	Starting torque (Constant Torque mode)	<ul style="list-style-type: none"> • EQ7-x040-C or below: 200% or higher, EQ7-x050-C or above: 180% or higher/set frequency: 0.3Hz (Base frequency 50 Hz, slip compensation and auto torque boost operation^{(*)1, only *2}) 	
	Start/ stop operation	Keypad	<ul style="list-style-type: none"> • Multi-function keypad: Start and stop with FWD, REV, and STOP keys
		External signals (digital inputs): Forward (reverse) rotation, stop command (capable of 3-wire operation), coast-to-stop command, external alarm, alarm reset, etc.	
Link operation: Operation through RS-485 or field bus (option) communications.			
Acceleration/ deceleration time	<ul style="list-style-type: none"> • Remote/Local Switching • Setting range: From 0.00 to 6000s • Switch: The four sets of accel/ decel. times can be set or selected individually (switchable during operation). • Acceleration/deceleration pattern: Linear accel./decel., S-shape accel./decel. (weak, free, strong), curvilinear accel./decel. (accel./decel. max capacity of constant output) • Deceleration mode (coast-to-stop): Coast-to-stop at the operation command OFF. • Forcible stop decel. time: Deceleration stop by the forcible stop (STOP) 		

(*1) Effective function in V/f control

(*2) Effective function in dynamic torque control

(*6) effective function in vector control without speed sensor

(*7) Effective function in vector control with speed sensor (PG option is necessary.)

(*8) This specification does not guarantee that all single fault cases are surely detected (EN954-1/EN ISO 13849-1, Cat. 3)

Common Specifications - Continued

Variable Torque mode designed for variable torque load applications

Item		Specifications
Control	Auto-restart after momentary power failure	Adjustable to restart at running speed, trip on power failure, or ride through on load inertia
	Current limit by hardware	Limiting the current by hardware to prevent overcurrent trip due to sharp load change or momentary power failure which cannot be controlled by software current limit. (This function can be cancelled.) Operation Level (20 to 200%)
	Digital Input	Forward run, reverse run, plus 7 configurable 24V DC inputs that can be set for over 50 events, both as normally open or closed.
	Transistor output	Four transistor and two relay outputs configurable to indicate over 50 possible events as both normally open or closed.
	Analog output	<ul style="list-style-type: none"> Terminals [FM1] and [FM2] Output a selected signal with analog DC voltage (0 to +10V) or analog DC current (4 to 20 mA) Selectable output to over 15 assigned parameters
Indication: Trip Mode		Trip History: Saves and displays the last 4 trip factors and their detailed description.
Other features	Communications	RS-485 COM port 1 (for keypad connection), RS-485 COM port 2 (on terminal board)
	Protection against momentary power failure	Upon detection of a momentary power failure lasting more than 15 ms, this function stops the inverter output. If restart after momentary power failure is selected, this function invokes a restart process if power is restored within a predetermined period (allowable momentary power failure time).
Environment	Installation location	Shall be free from corrosive gases, flammable gases, oil mist, dust, direct sunlight. (Pollution degree 2 (IEC60664-1)). Indoor use only.
	Ambient temperature	Open type: -10 to +50°C (14 to 122°F)
	Ambient humidity	5 to 95% RH (without condensation)
	Altitude	Lower than 3300ft (1000m)
	Atmospheric pressure	86 to 106kPa
	Storage temperature	-25 to +65°C (-13 to 149°F)
	Storage humidity	5 to 95% RH (without condensation)
Control	Enable input (Safe Torque Off (STO))	Opening the circuit between terminals [EN1] and PLC or terminals [EN2] and [PLC] stops the inverter's output transistor (Safe Torque Off: STO)
	Frequency setting	<ul style="list-style-type: none"> Keypad: can be set with UP and DOWN keys External Voltage: Can be set with external potentiometer (1 to 5kΩ 1/2W) Analog input: 0 to ±10 VDC (±5 VDC)/0 to ±100% or 0 to +10VDC (+5VDC)/ 0 to +100% (Terminals [12] and [V2]) (inverse operation via parameter) +4 to +20 mA DC/0 to 100% (or 0 to +20mA) (inverse operation via parameter) Up/DOWN operation: Frequency can be increased or decreased while the digital input signal is ON. Multi-frequency: Selectable from 16 pre-set speeds Link operation: Frequency can be set through RS-485 (standard setting) Switching frequency setting: Frequency setting can be switched (2 settings) with external signal (digital input). Auxiliary frequency setting: Terminal [12], [C1], or [V2] input can be selected respectively as an additional input Pulse train input: Pulse input = X7 terminal, rotational direction = general terminal Complementary output: Max. 100kHz, Open collector output: Max. 30kHz Pulse train input: PG interface option CW/CCW pulse, pulse + rotational direction Complementary output: Max. 100kHz, Open collector output: Max. 25kHz
	PID control	<ul style="list-style-type: none"> Terminals [FM1] and [FM2] Output a selected signal with analog DC voltage (0 to +10V) or analog DC current (4 to 20 mA) Selectable output to over 15 assigned parameters PID adjuster for process control and that for dancer control Switchable between forward and reverse operations Low liquid level stop function (pressurized operation possible before low liquid level stop) PID command: Keypad, analog input (from terminals [12], C1 V2), RS-485 communications PID feedback value: Analog input (from terminals [12], C1, V2) Alarm output (absolute value alarm, deviation alarm) PID output limiter Integration reset/hold
	Torque limiter	<ul style="list-style-type: none"> Torque limit value (±300%) Torque limiter 1/2, torque limiter enabled/disabled, analog torque limit value
Control functions		<ul style="list-style-type: none"> Analog input adjustment (gain/offset/filter time constant), frequency limiter (high and low), bias frequency, jump frequency, jogging operation, pre-excitation, switch to commercial power, commercial power switching sequence, cooling fan ON/OFF control, select motor 2 to 4, protect motor from dew condensation, universal DI, universal DO, universal AO, rotational direction limitation Overload prevention control, auto search, slip compensation, automatic deceleration (anti-regenerative control), droop control, deceleration characteristics (improving braking capability), auto energy saving function Offline tuning Life early warning, cumulative inverter run time, cumulative motor run time Light alarm, retry, command loss detection

(*1) Effective function in V/f control

(*2) Effective function in dynamic torque vector control

(*6) effective function in vector control without speed sensor

(*7) Effective function in vector control with speed sensor (PG option is necessary.)

(*8) This specification does not guarantee that all single fault cases are surely detected (EN954-1/EN ISO 13849-1, Cat. 3)

EQ7 Typical Wiring Diagram

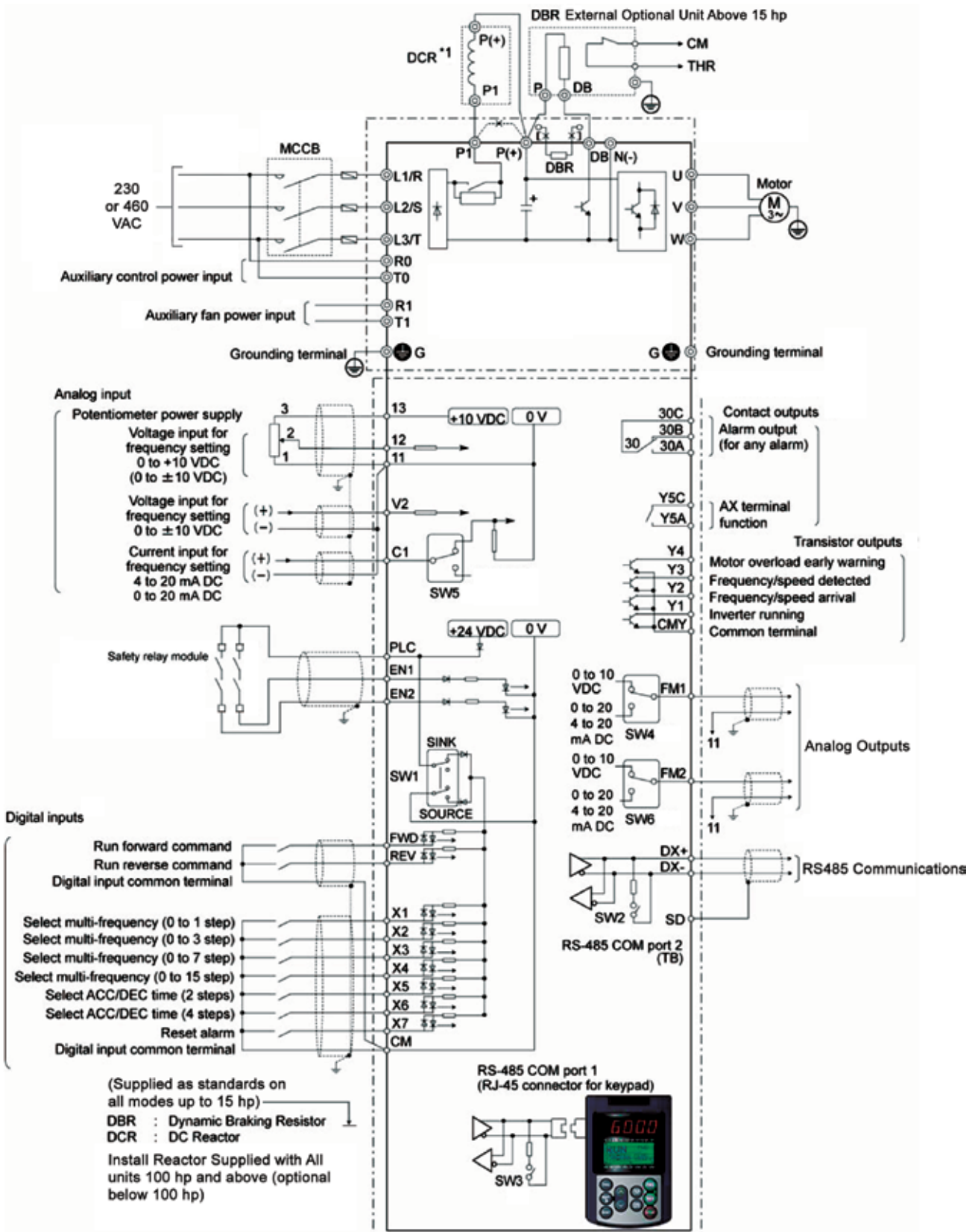

Dimensions and Weights

Inverter type EQ7-2XXX-C EQ7-4XXX-C		Dimensions inch (mm)										
230 V	460 V	W	W1	W2	H	H1	H2	D	D1	D2	D3	ØA
001	001	4.33 (110)	3.78 (96)	0.24 (6)	10.24 (260)	9.69 (246)	0.28 (7)	5.71 (145)	4.45 (113)	1.26 (32)	0.12 (3)	0.24 (6)
002	002	5.91 (150)	5.35 (136)									
003	003											
005	005	8.66 (220)	7.72 (196)	0.39 (10)	15.75 (400)	14.88 (378)	0.43 (11)	7.68 (195)	4.13 (105)	3.54 (90)	0.39 (10)	
007	007											
010	010											
015	015											
020	020	9.84 (250)	8.9 (226)	0.39 (10)	21.65 (550)	20.87 (530)	0.47 (12)	10.63 (270)	4.53 (115)	5.51 (140)	0.16 (4)	
025	025											
030	030	13.98 (355)	10.83 (275)	0.59 (15)	24.21 (615)	23.43 (595)	0.61 (15.5)	11.22 (285)	5.71 (145)	6.1 (155)	0.16 (4)	
040	040											
050	050											
	060	20.87 (530)	16.93 (430)	0.59 (15)	26.57 (675)	25.79 (655)	0.61 (15.5)	10.63 (270)	4.53 (115)	6.1 (155)	0.16 (4)	
	075											
—	100	20.87 (530)	16.93 (430)	0.59 (15)	29.13 (740)	28.35 (720)	0.61 (15.5)	11.22 (285)	5.71 (145)	5.51 (140)	0.16 (4)	
75	125											
100	125											
125	—	24.8 (630)	11.42 (290)	0.59 (15)	29.13 (740)	27.95 (710)	0.61 (15.5)	14.17 (360)	7.09 (180)	7.09 (180)	0.25 (6.4)	
150	—											
—	150	26.77 (680)	11.42 (290)	0.59 (15)	39.37 (1000)	38.19 (970)	0.61 (15.5)	14.17 (360)	7.09 (180)	7.09 (180)	0.25 (6.4)	
—	200											
—	250											
—	300											
—	350	34.65 (880)	10.24 (260)	0.59 (15)	55.12 (1400)	53.94 (1370)	0.61 (15.5)	17.32 (440)	10.24 (260)	7.35 (186.8)	0.25 (6.4)	
—	450											
—	500											
—	600	39.37 (1000)	11.81 (300)	0.59 (15)	61.02 (1550)	59.84 (1520)	0.61 (15.5)	19.69 (500)	12.33 (313.2)	7.35 (186.8)	0.25 (6.4)	
—	700											
—	800	39.37 (1000)	11.81 (300)	0.59 (15)	61.02 (1550)	59.84 (1520)	0.61 (15.5)	19.69 (500)	12.33 (313.2)	7.35 (186.8)	0.25 (6.4)	
—	900											
—	1000	39.37 (1000)	11.81 (300)	0.59 (15)	61.02 (1550)	59.84 (1520)	0.61 (15.5)	19.69 (500)	12.33 (313.2)	7.35 (186.8)	0.25 (6.4)	
—	1000											

40 HP or below

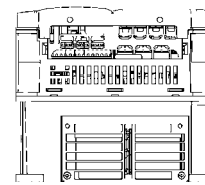
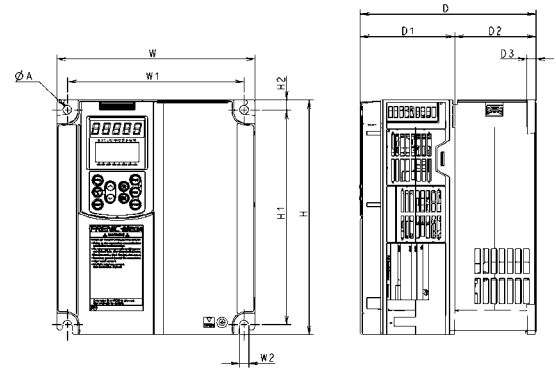

50 HP or above

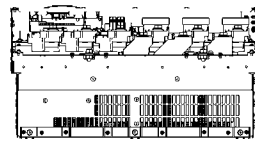
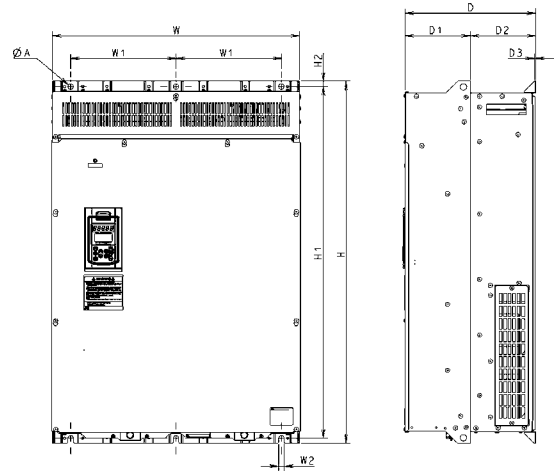

DC Reactor



DC Link reactors provide smoothing capabilities to the DC bus sections in EQ7 Drives.

All units 100 hp and above come with a separate DC Link Reactor ready for field wiring at the DC Bus Terminals

Power Supply Voltage	Inverter Type FRN ___ GIS -2U/4U	Option/Standard	Reactor	Refer to:	Dimensions in Inches (mm)									Mass lb (kg)
					W	W1	D	D1	D2	D3	H	Mounting Hole	Terminal Hole	
230 V	100	Standard	DCR2-75C	Figure A	10.04±0.39 (255±10)	8.86 (225)	4.17±0.08 (106±2)	3.39 (86)	5.71 (145)	2.09±0.04 (53±1)	5.71 (145)	M6	M12	25 (11.4)
	DCR2-90C		4.57±0.08 (116±2)				3.78 (96)	6.1 (155)	2.28±0.04 (58±1)	31 (14)				
	DCR2-110C		11.81±0.39 (300±10)		10.43 (265)	4.57±0.16 (116±4)	3.54 (90)	7.28 (185)	6.3 (160)	M8	37 (17)			

Note: 100 hp or above type comes with a CD reactor (DCR) suitable for the LD-mode use

Power Supply Voltage	Inverter Type FRN ___ GIS -2U/4U	Option/Standard	Reactor	Refer to:	Dimensions in Inches (mm)									Mass lb (kg)	
					W	W1	D	D1	D2	D3	H	Mounting Hole	Terminal hole		
460 V	100	Standard	DCR4-75C	Figure A	10.04±0.39 (255±10)	8.86 (225)	4.17±0.08 (106±2)	3.39 (86)	4.92 (125)	2.09±0.04 (53±1)	5.71 (145)	M6	M10	27 (12.4)	
	DCR4-90C		4.57±0.08 (116±2)				3.78 (96)	5.51 (140)	2.28±0.04 (58±1)	32 (14.7)					
	DCR4-110C		11.81±0.39 (300±10)				10.43 (265)	3.54 (90)	6.89 (175)	6.1 (155)				M8	41 (18.4)
	DCR4-132C		13.78±0.39 (350±10)	12.2 (310)	4.96±0.16 (126±4)	3.94 (100)	7.09 (180)	2.48±0.08 (63±2)	6.3 (160)	M12	49 (22)				
	DCR4-160C				5.16±0.16 (131±4)	4.06 (103)	2.58±0.08 (65.5±2)	7.48 (190)	56 (25.5)						
	DCR4-200C				5.55±0.16 (141±4)	4.45 (113)	2.78±0.08 (70.5±2)	7.48 (190)	65 (29.5)						
	DCR4-220C		17.52±0.39 (445±10)	15.16 (385)	5.75±0.16 (146±4)	4.65 (118)	7.87 (200)	2.87±0.08 (73±2)	9.65 (245)	M10	72 (32.5)				
	DCR4-280C				13.78±0.39 (350±10)	12.2 (310)	6.34±0.16 (161±4)	5.24 (133)			8.27 (210)	3.17±0.08 (80.5±2)	7.48 (190)	M16	79 (36)
	DCR4-355C				15.75±0.39 (400±10)	13.58 (345)	6.14±0.16 (156±4)	5.04 (128)			7.87 (200)	3.07±0.04 (78±1)	8.86 (225)	M10	104 (47)
	DCR4-400C		17.52±0.39 (445±10)	15.16 (385)	5.71±0.16 (145±4)	4.61 (117)	8.39 (213)	2.85±0.04 (72.5±1)	9.65 (245)	M10	115 (52)				
	DCR4-450C		17.32±0.39 (440±10)	15.35 (390)	5.91±0.16 (150±4)	4.8 (122)	8.46 (215)	2.95±0.08 (75±2)			18.9 (480)	M12	132 (60)		
	DCR4-500C		17.52±0.39 (445±10)	15.35 (390)	6.5±0.16 (165±4)	5.39 (137)	8.66 (220)	3.25±0.08 (82.5±2)					18.9 (480)	M12	154 (70)
	DCR4-630C		11.22±0.39 (285±10)	5.71 (145)	7.99±0.16 (203±4)	6.69 (170)	7.68 (195)	4.09±0.08 (104±2)	18.9 (480)	M12					165 (75)
	DCR4-710C		13.39±0.39 (340±10)	6.3 (160)	11.61±0.16 (295±4)	10.04 (255)	8.86 (225)	4.21±0.08 (107±2)			209 (95)				

Note: 100 hp or above type comes with a CD reactor (DCR) suitable for the LD-mode use

Figure A

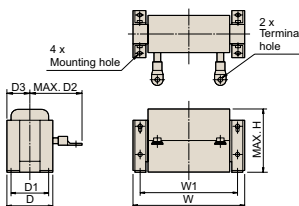

Figure B

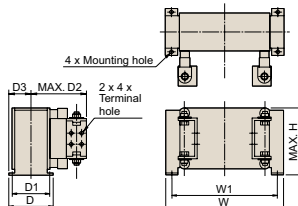
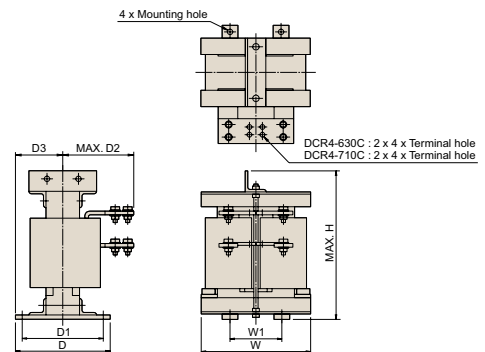

Figure C



Options - NEMA 1 Conversion Kits

Model No.	Inverter type EQ72_ / EQ74_		Dimensions inch (mm)		
	230 V	460 V	W	H	D
NEMA1-0.75G1-24	001	001	4.45 (113)	12.2 (310)	5.76 (146.3)
NEMA1-3.7G1-24	002	002	5.87 (149)		5.76 (146.2)
	003	003			
	005	005			
NEMA1-11G1-24	007	007	8.66 (220)	13.24 (336.2)	7.68 (195)
	010	010			
	015	015			
	020	020			
NEMA1-22G1-24	025	025	9.84 (250)	19.27 (490)	
	030	030		22.05 (560)	
NEMA1-22G1-2	040	—		19.27 (490)	
NEMA1-22G1-24	—	040			
NEMA1-37G1-24	050	050	12.73 (323.4)	26.97 (685)	10.04 (255)
NEMA1-75G1-24	060	—	14.11 (358.4)	29.92 (760)	10.63 (270)
NEMA1-37G1-24	—	060	12.73 (323.4)	26.97 (685)	10.04 (255)
NEMA1-75G1-24	075	—	14.11 (358.4)	34.84 (885)	10.63 (270)
	—	075		29.92 (760)	
	100	—		34.84 (885)	
	—	100		32.28 (820)	
NEMA1-75G1-2	125	—	21 (533.4)	37.8 (960)	11.22 (285)
NEMA1-75G1-24	—	125	14.11 (358.4)	34.84 (885)	10.63 (270)
NEMA1-220G1-24	150	—	26.91 (683.4)	46.46 (1180)	14.17 (360)
NEMA1-110G1-4	—	150	21 (533.4)	35.43 (900)	12.4 (315)
	—	200		49.61 (1260)	14.17 (360)
	—	250			
NEMA1-160G1-4	—	300			
NEMA1-220G1-24	—	350	26.91 (683.4)	51.18 (1300)	
	—	450			
NEMA1-315G1-4	—	500	26.94 (684.2)	63.78 (1620)	17.39 (441.6)
	—	600			
NEMA1-400G1-4	—	700	34.81 (884.2)	64.17 (1630)	
	—	800			
NEMA1-630G1-4	—	900	39.54 (1004.2)	64.57 (1640)	19.75 (501.6)
	—	1000			

40 HP or below

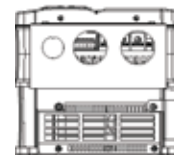
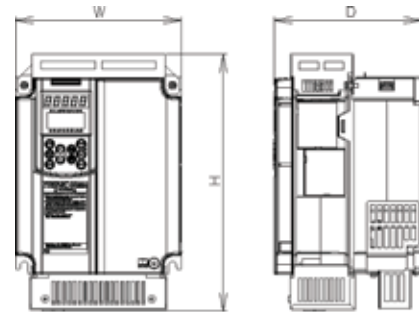

50 HP or above

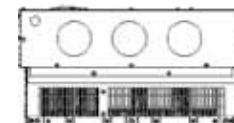
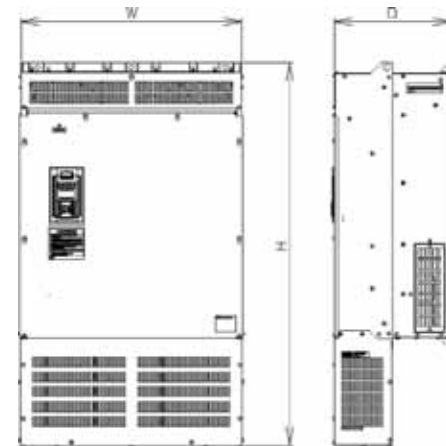

Note: Standard models with NEMA1 kit cannot employ external cooling.

Options

Parts Name	Type	Remarks
EtherNet Card	OPC-G1-ETH	The Ethernet option card allows for connectivity to various Ethernet protocols. These include: - EtherNet/IP - Modbus/TCP - BACnet/IP - Profinet-IO The card also contains an embedded web server for configuration of numerous additional functions such as alarm evaluation with email notification, dashboard GUI with multiple windows for monitoring, virtual keypad interface, and protocol configuration.
DeviceNet Card	OPC-G1-DEV	The DeviceNet option card allows for connectivity to a DeviceNet network. The card allows for control or monitoring of the inverter, monitor and change function codes, and the use of explicit messaging. The following are specifications for the DeviceNet options. - 64 Nodes, maximum, including the Master device. - Data rate (baud rate): 125 kbps, 250 kbps, 500 kbps - I/O Message: Polling and Change of State supported - Applicable Profile: AC Drive profile - Reading and writing all the function codes applicable to the EQ7 (I/O Message (User Defined Assembly Instance or Access to Function Codes Instance) and Explicit Message) This product has been tested by ODVA authorized Independent Test Lab and found to comply with ODVA's DeviceNet Conformance Test Version 20.
PROFIBUS DP Card	OPC-G1-PDP	The Profibus-DP option card allows for connectivity to a Profibus network. The card allows for control or monitoring of the inverter and for monitoring and changing of function codes. The following are specifications for the Profibus option. - PROFIBUS version: DP-V0 compliant - Transmission speed: 9,600 bps to 12 Mbps - Maximum network cable length per segment: 100 m (912 Mbps) to 1200 m (9.6kbps) - Applicable Profile: PROFIDrive V2 compliant
CANopen	OPC-G1-COP	The CANopen is the card which supports various open bus types. With this card, the following operations can be performed using PC or PLC. - Operation frequency setting - Operation command setting (FWD, REV, RET, etc.) - Data code setting for each function code - Reading trip data
PG Interface Card (Supporting 12V)	OPC-G1-PG	Having this card built-in to the inverter allows the speed control and the position control.
PG Interface Card (Supporting 5V)	OPC-G1-PG2	Having this card built-in to the inverter allows the speed control and the position control.
PG Synchronization Card	OPC-G1-PG22	Velocity synchronization card, allowing both master and slave encoder inputs.
Digital Input Interface Card	OPC-G1-DI	Using this card allows frequency setting by 8, 12, 15, and 16 bits, and by BCD code.
Digital Output Interface Card	OPC-G1-DO	The output interface card to be equipped with the EQ7, which allows monitoring frequency, output voltage, and output current with binary code.
Analog Input/Output Interface Card	OPC-G1-AIO	Using this card allows the torque limit value input, frequency and frequency ratio setting with analog input.
Relay Communication Card	OPC-G1-RY	Using this card allows relay output of the inverter general output signal (transistor output).
Dynamic Braking Kits	----	Dynamic braking resistors are available to match ratings for the entire product range. Dynamic braking transistors are available for all models above 40 hp.

Multiple system and network expansion modules are supported on a single EQ7 unit per the table below

Restrictions on mounting an optional card

Y: Available

N: Not Available

Mounting port	OPC-G1S-			
	PG, PG2, PG22	D1, D0, A10, DEV	RY	ETH, TL, COP, PDP, CCL, SX
C PORT	Y	Y	N	N
B PORT	N	Y	Y	N
A PORT	N	Y	Y	Y
Remarks	1	2	3	2

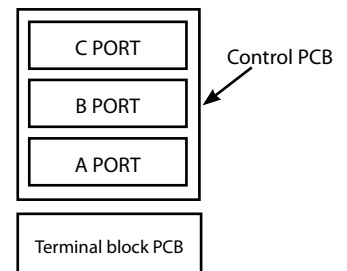

*1 Any one of the above can be mounted on only C port.

*2 Only one card can be mounted on any of A, B, or C ports.

Cards can be mounted on DI, DO, and AIO ports at the same time, however, two identical cards cannot be allowed.

*3 The cards can be mounted on both A and B ports.

Two RY cards can be mounted at the same time.

The number of RY contact points of a card is two. If three or four points are necessary, prepare two cards.

Note: There are also restrictions on mounting when using the optional communications card. Contact us for details.

Note: When mounting the IP40 option, only one optional card can be mounted. (RY card allows mounting of two cards.)

EQ7 Configured Packages

The EQ7 is available as the key unit in built-to-order packages for a variety of installations.

HVAC Packages

TECO-Westinghouse offers a complete line of packaged drives, including bypass packages for fan and pump applications.

FEATURES

- UL508A
- Packages up to 1000 hp available
- Available in multiple disconnect options
- Two or three contactor and soft start bypass
- Custom design packages
- Wide range of harmonic filters available to meet IEEE 519-1992
- NEMA 1, NEMA 12, NEMA 3R standard
- NEMA 4 & 4X available
- Duplex - multiplex packages available
- Packages designed to customer specifications

APPLICATIONS

- Fans
- Chillers
- Refrigeration
- Compressors
- Air handlers
- Pumps



Industrial Packages

TECO-Westinghouse additionally offers packaged drives to suit even robust industrial applications.

FEATURES

- NEMA 1, NEMA 12, NEMA 3R standard
- UL508A
- Packages up to 1000 hp
- Available in multiple disconnect options
- NEMA 4, 4X available
- Special Designs to meet tight spacing requirements

APPLICATIONS

- Conveyors
- Compressors
- Mixers
- Stamping/ punch press



TECO-Westinghouse Motor Company offers an extensive line of variable Speed Drives and Soft starts for your motor control applications.

We also offer a wide variety of motors that are matched with the Drives and soft Starters including vertical Hollow Shaft, Rolled steel, and NEMA Premium Efficient NEMA Motors.

From "in stock" controls to engineered systems, we can provide you the right control solution including an extensive line of TECO-Westinghouse AC Motors.

Contact us for your application and packaging needs!



Available from:



TECO-Westinghouse Motor Company

5100 N. IH-35
Round Rock, Texas 78681
1-800-279-4007

www.tecowestinghouse.com

D-EQ7 2-13