

A510

TECO   **Westinghouse**

A510

Heavy Duty AC Drive



1-100 HP (230V) • 1-400 HP (460V)
1-10 HP (575V) • 15-250 HP (690V)

Control Mode Application and Selection Guide

The A510 Heavy Duty AC Drive is an easily configured versatile drive product that will control all general applications such as fans, pumps, conveyors, and mixers. It comes standard with a simple to select preset application parameters for many commonly used applications.

A preset application menu designed to simplify start-up is provided for the following applications:

- Pump
- Exhaust
- Compressor
- Crane
- Conveyor
- HVAC
- Hoist

Despite its simple and easy approach, the A510 is loaded with features to solve tough and demanding applications such as reciprocating pumps, compressors and high torque/ high inertia loads.

Advanced algorithms allow the A510 to perform tight and precise speed control when coupled with encoder feedback on the motor being controlled.

Application Type	V/F Mode (Open-Loop)	V/F Mode with PG Feedback	SLV Sensorless Vector Mode	SV* Closed-Loop Vector Mode	PMSV* Closed-Loop Vector Mode w/ Permanent Magnet Motor
Fans and Blowers	x				
Centrifugal Pumps	x				
Mixers	x				
Conveyors	x	x	x		
Compressors	x	x	x		
Hoist/ Elevator			x	x	
Stamping/ Punch Press			x		
Dynamometers			x	x	
Extruders			x	x	
Injection Molding				x	
Web/ Roll Processes				x	x
Torque Trim				x	x
Torque Control				x	x
Indexing Operations				x	x
Positioning				x	x
Servo Functions					x
Winder/ Unwinder				x	

* Requires optional PG encoder feedback.

Intelligent LCD Keypad

A complete keypad that will control, configure, and closely monitor the A510 unit as it controls operations. LCD Operators Keypad can save the configuration file for easy upload/ download.



Display	Description
LCD Display	Monitors over 50 inverter signals, view/ edit parameters, fault/ alarm display
LED Indicators	
FAULT	LED ON when a fault or alarm is active
FWD	LED ON when inverter is running in forward direction, flashing when stopping
REV	LED ON when inverter is running in reverse direction, flashing when stopping
SEQ	LED ON when RUN command is from the external control terminals or from serial communication
REF	LED ON when Frequency reference command is from the external control terminals or from serial communication
KEYS (8)	
RUN	RUN inverter in local mode
STOP	STOP inverter
▲	Parameter navigation up, increase parameter or reference value
▼	Parameter navigation down, decrease parameter or reference value
LOC / REM	Used to switch between Local (Keypad) Operation and Remote Operation
DSP / FUN	Used to scroll to next screen Frequency screen → Function selection → Monitor parameter
◀ / RESET	Selects active seven segment digit for editing with the ▲▼ keys Used to reset fault condition
READ / ENTER	Used to read and save the value of the active parameter

Auto-Repeat Keys

Holding the ▲ UP or ▼ DOWN key for a longer period of time will initiate the auto-scroll function resulting in the value of the selected digit to automatically increase or decrease. The LCD keypad can save the configuration file for easy upload/ download.

Applications

The A510 is loaded with features to solve demanding applications and control more common ones such as fans, pumps, conveyors, and mixers. Demanding application examples are listed below.

■ Compressors

- High starting torque with sensorless vector mode
- Stable torque at low speed

■ Metals processing including industrial saws, punch press, and screw and bolt manufacturing

- Attains the high torques required by these applications
- Hardware design handles the high in-rush currents that are produced
- High braking torque and regenerative overvoltage protection

■ Machine tool operations such as grinding, milling and lathes

- Capable of output frequencies to 599 Hz
- Smooth operation and minimal ripple at any speed
- High braking torque capabilities
- High resolution analog input for demanding precision

■ Plastics and rubber process machines such as extruders and rubber compounding

- Smooth operation at low speeds
- High starting torque to produce consistent product
- Hardware design handles the high in-rush currents that are produced

■ Cranes, hoists, and materials handling

- Four quadrant operation for motoring and regenerative situations
- High torque for instant lifting
- High braking torque, precise control and operation
- Easily incorporates mechanical and safety interlocks



Features & Highlights

- Selectable Control Modes designed to cover almost all motor driven applications
 - V/F Mode with constant and variable torque settings
 - V/F Mode with PG encoder feedback to improve speed regulation
 - Sensorless Vector for more dynamic applications
 - Sensorless Vector with permanent magnet motors for more dynamic applications
 - Closed Loop Vector for the most demanding applications involving both speed and torque control
 - 1000:1 Speed control range
 - 5% Torque regulation
 - Closed Loop Vector with Permanent Magnet Motors for servo-type control
 - Sensorless vector control with dynamic control and rotational tuning
- Attains high levels of torque
 - 200% Starting torque in sensorless vector modes
 - 200% Holding torque in closed-loop vector modes
- Select matching application type for quick setting of parameter defaults
- Advanced regenerative energy handling capabilities with overvoltage suppression
 - Reduce the need for costly braking resistor units
- Extensive Monitoring and Display capabilities
 - Display over 40 different operating and status information variables including
 - Input and output frequencies
 - Output current and voltage
 - Analog and digital I/O status
 - PID related data
 - Vector PID loop control information
 - Motor operating data
 - Retains 4 most recent faults in a log
 - Operating information at instant of occurrence of most recent fault
- PLC functionality built-in to enhance application flexibility
- Advanced tuning/ motor matching capabilities
 - Control induction or permanent magnet motors
 - 5th generation tuning algorithms for optimized vector control and motor coordination
 - Dynamic tuning
 - Static tuning
- Pulse Width Modulation (PWM) technology that reduces motor noise
- 32 Bit, 100 MHz processor for extremely fast response
- Digital I/O
 - 8 configurable digital inputs
 - 24V power on board
 - Over 40 available selections per input
 - Assign each input as a normally open or closed input
 - Fast update time

Features & Highlights - Continued

- 3 digital outputs
 - 1 form C relay and 1 form A relay (3-100 HP @ 230V, 5-400 HP @ 460V, 1-10 HP @ 575V, 15-250 HP @ 690V)
 - 1 photocoupler output (Qty 2 at 1-2 HP @ 230V, 1-3 HP @ 460V)
 - All digital outputs are assignable as normally open or normally closed contacts
- Safety input contact for user's interlock circuit
- Analog I/O
 - Qty 2 analog inputs
 - One channel selectable as 0-10VDC or -10-0-10VDC, 4-20mA
 - One channel selectable as 0-10VDC or 4-20mA
 - Assignable as speed reference, PID feedback, gains, bias, and torque control-related parameters
 - Qty 1 0-10VDC analog output and Qty 1 0-10VDC/ 4-20mA output
 - Over 25 assignable selections for each channel
 - Assignable gain and bias on each channel
 - Pulse I/O
 - 1 pulse input channel capable of up to 32 kHz
 - 1 pulse output channel capable of up to 32 kHz
 - Can sync channels between A510 units for primary/ secondary configuration
 - Removable I/O terminal strip

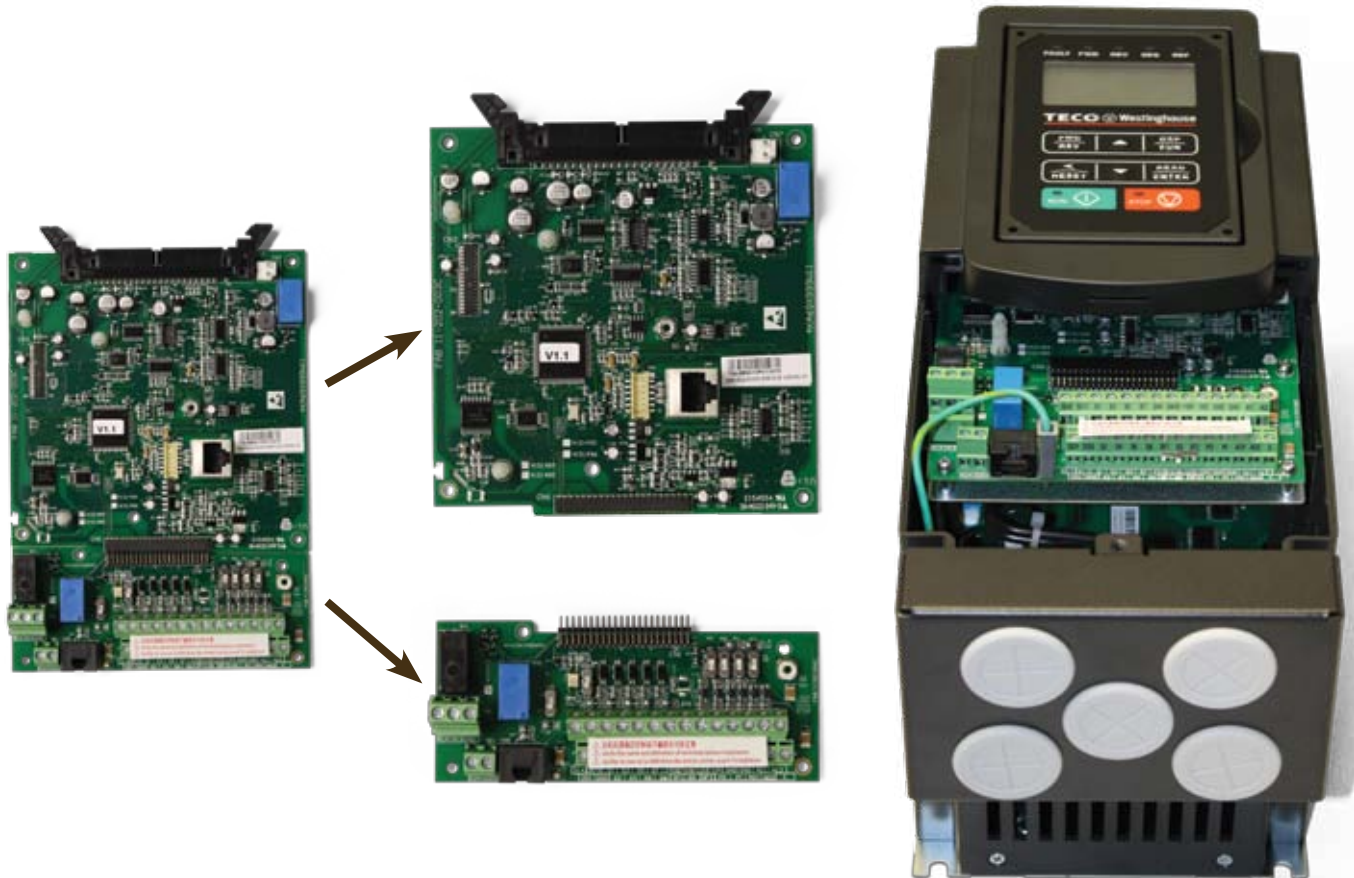

Models and Ratings

230VAC

Model No.	HP		Amps		Height	Width	Depth	Est. Weight Lbs/Kg	Diagram
	CT	VT	CT	VT	In/mm	In/mm	In/mm		
*†A510-2001-C-UE	1	1.5	5.0	6.0	9.61/244	5.12/130	5.91/150	5.5/2.5	A
*†A510-2002-C-UE	2	3	8.0	9.6	9.61/244	5.12/130	5.91/150	5.5/2.5	A
*†A510-2003-C-UE	3	3	11.0	12.0	12.40/315	5.51/140	6.97/177	8.8/4.0	A
†A510-2005-C3-UE	5	5-7.5	17.5	22.0	12.40/315	5.51/140	6.97/177	8.8/4.0	A
†A510-2008-C3-UE	7.5	10	25.0	30.0	12.40/315	5.51/140	6.97/177	8.8/4.0	A
†A510-2010-C3-UE	10	15	33.0	42.0	11.81/300	8.27/210	8.46/215	13.6/6.2	B
†A510-2015-C3-UE	15	20	47.0	56.0	14.17/360	10.43/265	8.86/225	22.0/10.0	B
†A510-2020-C3-UE	20	25	60.0	69.0	14.17/360	10.43/265	8.86/225	22.0/10.0	B
†A510-2025-C3-UE	25	30	73.0	79.0	14.17/360	10.43/265	8.86/225	22.0/10.0	B
A510-2030-C3-UE	30	40	85.0	110.0	20.67/525	11.18/284	9.92/252	66.1/30.0	C
A510-2040-C3-UE	40	50	115.0	138.0	20.67/525	11.18/284	9.92/252	66.1/30.0	C
**‡A510-2050-C3-UE	50	60	145.0	169.0	22.83/580	13.54/344	11.81/300	102.9/46.7	D
**‡A510-2060-C3-UE	60	75	180.0	200.0	22.83/580	13.54/344	11.81/300	102.9/46.7	D
**‡A510-2075-C3-UE	75	100	215.0	250.0	31.10/790	18.08/459	12.78/324.5	194.0/88.0	D
**‡A510-2100-C3-UE	100	125	283.0	312.0	31.10/790	18.08/459	12.78/324.5	194.0/88.0	D

460VAC

Model No.	HP		Amps		Height	Width	Depth	Est. Weight Lbs/Kg	Diagram
	CT	VT	CT	VT	In/mm	In/mm	In/mm		
†A510-4001-C3-UE	1	2	3.4	4.1	9.61/244	5.12/130	5.91/150	5.5/2.5	A
†A510-4002-C3-UE	2	3	4.2	5.4	9.61/244	5.12/130	5.91/150	5.5/2.5	A
†A510-4003-C3-UE	3	3	5.5	6.9	9.61/244	5.12/130	5.91/150	5.5/2.5	A
†A510-4005-C3-UE	5	5-7.5	9.2	12.1	12.40/315	5.51/140	6.97/177	8.8/4.0	A
†A510-4008-C3-UE	7.5	10	14.8	17.5	12.40/315	5.51/140	6.97/177	8.8/4.0	A
†A510-4010-C3-UE	10	15	18.0	23.0	11.81/300	8.27/210	8.46/215	13.6/6.2	B
†A510-4015-C3-UE	15	20	24.0	31.0	11.81/300	8.27/210	8.46/215	13.6/6.2	B
†A510-4020-C3-UE	20	25	31.0	38.0	11.81/300	8.27/210	8.46/215	13.6/6.2	B
†A510-4025-C3-UE	25	30	39.0	44.0	14.17/360	10.43/265	8.86/225	22.0/10.0	B
†A510-4030-C3-UE	30	40	45.0	58.0	14.17/360	10.43/265	8.86/225	22.0/10.0	B
A510-4040-C3-UE	40	50	60.0	73.0	20.67/525	11.18/284	9.92/252	66.1/30.0	C
A510-4050-C3-UE	50	60	75.0	88.0	20.67/525	11.18/284	9.92/252	66.1/30.0	C
A510-4060-C3-UE	60	75	91.0	103.0	20.67/525	11.18/284	9.92/252	66.1/30.0	C
‡A510-4075-C3-UE	75	100	118.0	145.0	20.67/525	11.18/284	9.92/252	77.1/35.0	C
**‡A510-4100-C3-UE	100	125	150.0	168.0	22.83/580	13.7/344	11.81/300	102.9/46.7	D
**‡A510-4125-C3-UE	125	150	180.0	208.0	22.83/580	13.7/344	11.81/300	102.9/46.7	D
**‡A510-4150-C3-UE	150	200	216.0	250.0	31.10/790	18.08/459	12.78/324.5	194.0/88.0	D
**‡A510-4215-C3-UE	200	250	295.0	328.0	31.10/790	18.08/459	12.78/324.5	194.0/88.0	D
**A510-4270-C3-UE	250	250	380.0	435.0	39.37/1000	27.16/690	16.14/410	405/184	E
**A510-4300-C3-UE	300	300	450.0	515.0	39.37/1000	27.16/690	16.14/410	405/184	E
**A510-4375-C3-UE	350	400	523.0	585.0	39.37/1000	27.16/690	16.14/410	405/184	E
**A510-4425-C3-UE	400	400	585.0	585.0	39.37/1000	27.16/690	16.14/410	405/184	E

575/ 690VAC

Model No.	HP		Amps		Height	Width	Depth	Est. Weight Lbs/Kg	Diagram
	CT	VT	CT	VT	In/mm	In/mm	In/mm		
***†A510-5001-C3-UE	1	2	1.7	3.0	12.40/315	5.51/140	6.97/177	8.8/4.0	A
***†A510-5002-C3-UE	2	3	3.0	4.2	12.40/315	5.51/140	6.97/177	8.8/4.0	A
***†A510-5003-C3-UE	3	4	4.2	5.8	12.40/315	5.51/140	6.97/177	8.8/4.0	A
***†A510-5005-C3-UE	5	5	6.6	8.8	11.81/300	8.27/210	8.46/215	13.6/6.2	B
***†A510-5008-C3-UE	7.5	10	9.9	12.2	11.81/300	8.27/210	8.46/215	13.6/6.2	B
***†A510-5010-C3-UE	10	10	11.4	14.5	11.81/300	8.27/210	8.46/215	13.6/6.2	B
†A510-6015-C3-UE	15	20	15.0	19.0	14.17/360	10.43/265	8.86/225	22.0/10.0	B
†A510-6020-C3-UE	20	25	19.0	22.0	14.17/360	10.43/265	8.86/225	22.0/10.0	B
†A510-6025-C3-UE	25	30	22.0	27.0	14.17/360	10.43/265	8.86/225	22.0/10.0	B
†A510-6030-C3-UE	30	40	27.0	34.0	14.17/360	10.43/265	8.86/225	22.0/10.0	B
†A510-6040-C3-UE	40	50	34.0	42.0	14.17/360	10.43/265	8.86/225	22.0/10.0	B
A510-6050-C3-UE	50	60	42.0	52.0	20.67/525	11.29/286.5	9.92/252	66.1/30.0	C
A510-6060-C3-UE	60	75	54.0	62.0	20.67/525	11.29/286.5	9.92/252	66.1/30.0	C
A510-6075-C3-UE	75	100	62.0	80.0	20.67/525	11.29/286.5	9.92/252	66.1/30.0	C
**‡A510-6100-C3-UE	100	125	86.0	99.0	22.83/580	13.54/344	11.81/300	102.9/46.7	D
**‡A510-6125-C3-UE	125	150	95.0	125.0	22.83/580	13.54/344	11.81/300	102.9/46.7	D
**‡A510-6150-C3-UE	150	175	131.0	147.0	22.83/580	13.54/344	11.81/300	102.9/46.7	D
**‡A510-6215-C3-UE	200	250	163.0	212.0	31.10/790	18.07/459	12.78/324.5	194.0/88.0	D
**‡A510-6250-C3-UE	250	270	193.0	216.0	31.10/790	18.07/459	12.78/324.5	194.0/88.0	D

† Models include built-in Braking Transistor.

‡ Models include built-in DC Link Reactor.

* Models accept single or 3-phase 230V input.

** Models are chassis-rated (IP00). NEMA 1 kits are available as options.

*** 575VAC input only

Constant Torque: 150% for 1 minute

Variable Torque: 120% for 1 minute

Diagrams referenced are on next page

Dimensional Diagrams

Diagrams refer to the chart on the previous page.

A 1-7.5 HP, 230V/ 1-7.5 HP, 460V (IP20/ NEMA 1)
1-3 HP, 575V (IP20/ NEMA 1)

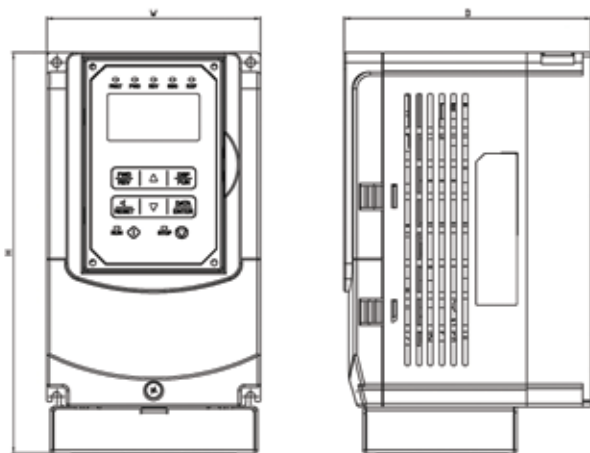

B 10-25 HP, 230V/ 10-30 HP, 460V (IP20/ NEMA 1)
5-10 HP, 575V/ 15-40 HP, 690V (IP20/ NEMA 1)

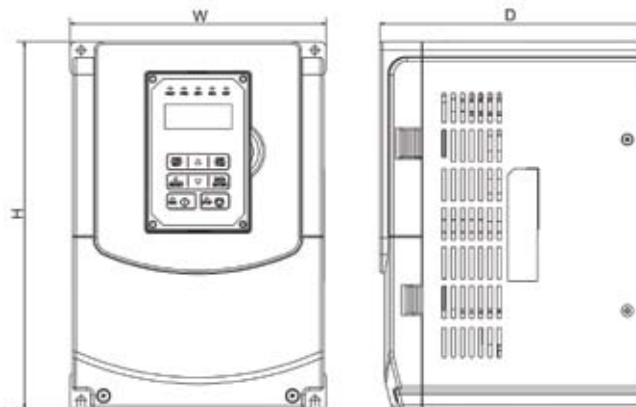

C 30-40 HP, 230V/ 40-75 HP, 460V (IP20/ NEMA 1)
50-75 HP, 690V (IP20/ NEMA 1)

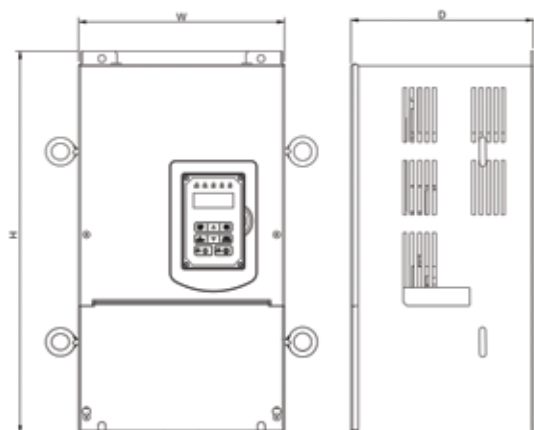

D 50-100 HP, 230V/ 100-200 HP, 460V (IP00)
100-250 HP, 690V (IP00)

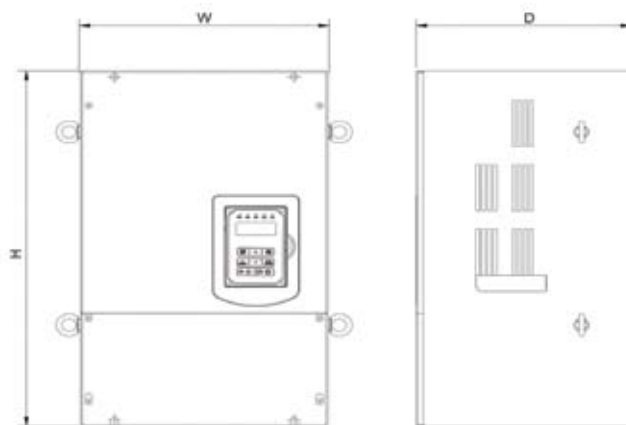

E 250-400 HP, 460V (IP20/ NEMA 1)

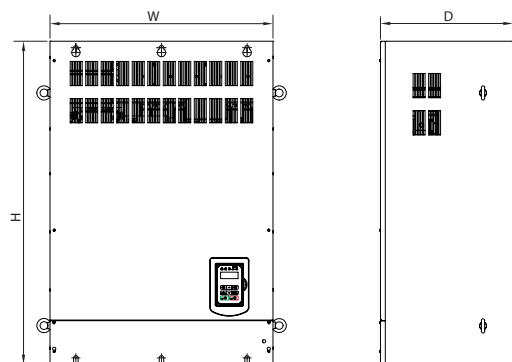

Connection Diagram

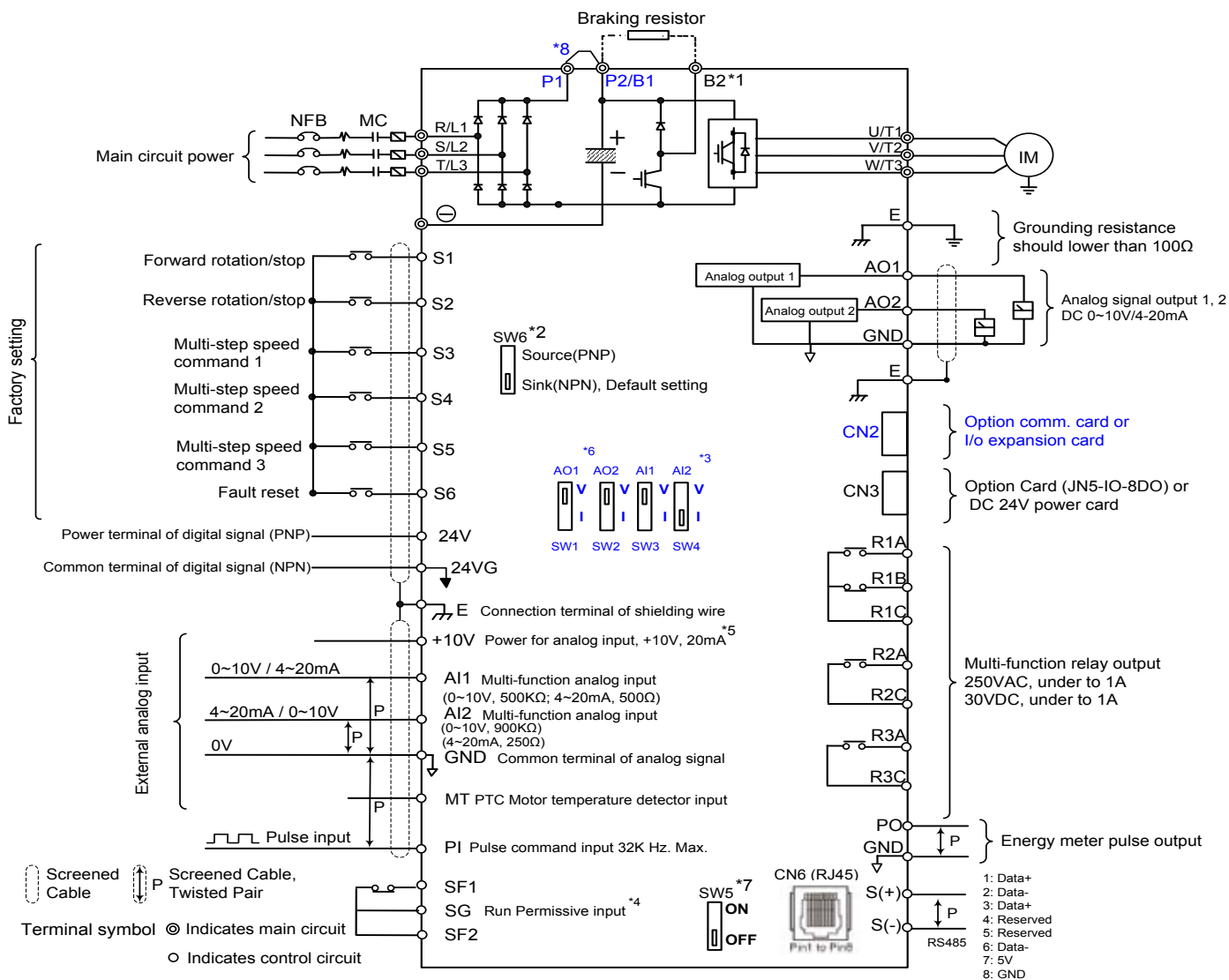

- *1 Models IP20 200V 1~30HP, 400V 1~40HP have a built-in braking transistor so that the braking resistor can be connected between terminal B1 and B2.
- *2: The multi-function digital input terminals S1~S6 can be set to Source (PNP) or Sink (NPN) mode via SW6.
- *3: Use SW3/SW4 to switch between voltage (0~10V) and current (4~20mA) input for Multi-function analog input 2 (AI2). Besides please also check parameter 04-00 for proper setting.
- *4: Run permissive input SF1 & SF2 is a normally closed input. This input should be closed to enable the inverter output. To activate this input, open the link between SF1/ SF2 and SG.
- *5: When using the open collector for pulse input, it doesn't need resistance because of built-in pull-up resistance.
- *6: AO1 / AO2 default setting is 0~+10V.
- *7: It need turn on the switch for the terminal resistor RS485 in the last inverter when many inverters in parallel connection.

Control Circuit Terminals

200V: 1-3 HP 400V: 1-3 HP

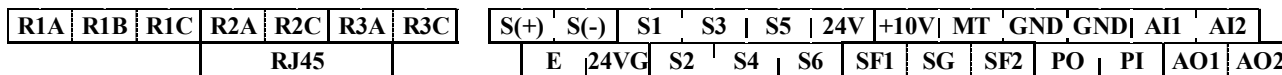

200V: 1-3 HP 400V: 1-3 HP

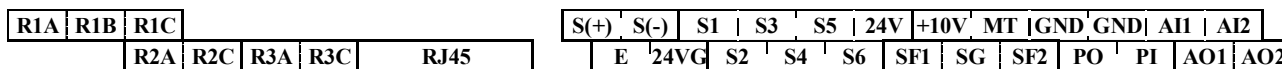

200V: 1-3 HP 400V: 1-3 HP

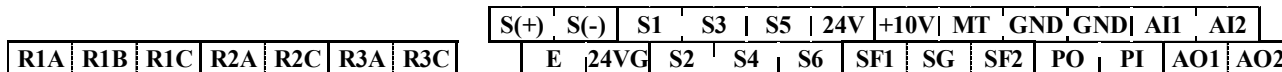

Operating Features and Characteristics

Operation Mode	LCD keypad with parameter copy function
Control mode	V/F, V/F+PG, SLV, SV, PMSV, PMSLV, SLV2
Frequency control range	0.1Hz ~ 599.99Hz
Frequency accuracy (Temperature change)	Digital references: $\pm 0.01\%$ (-10~+40°C), Analog references: $\pm 0.1\%$ (25°C $\pm 10^\circ\text{C}$)
Speed control accuracy	$\pm 0.1\%$ (closed loop vector control), $\pm 0.5\%$ (sensorless vector mode)
Frequency setting resolution	Digital references: 0.01Hz, Analog references: 0.06Hz/60Hz
Output frequency resolution	0.01Hz
Overload Tolerance rated output current	150%/1 min, 200%/2sec (CT mode), 120%/1 min (VT mode), factory setting of 150%/1 min, 200%/2 sec
Frequency setting signal	0 ~ +10VDC/4 ~ 20mA or -10VDC ~+10VDC and pulse-type frequency command
Acceleration/ deceleration time	0.0~6000.0 sec (separately set acceleration and deceleration times)
Voltage, frequency characteristics	Can set custom V/ F-curve based on parameters
Braking torque	Approx. 20%
Main control functions	Auto tuning, shaft lock, torque control, position control, droop control, soft-switching in PWM, over-voltage protection, dynamic braking, speed search, frequency traversing, instantaneous power fault restart, PID control, automatic torque compensation, slip compensation, RS-485 communication MODBUS standard, speed feedback control, simple PLC functionality, 2 sets of analog output, safety switch interlock
Additional control functions	Record of elapsed power-up and operation times, 4 most recent occurrences of faults and the most recent fault record, status, energy-saving function setting, single phasing protection, smart braking, DC braking, dwell, S-curve acceleration and deceleration, Up / Down operation, MODBUS communication type, scale pulse output, engineering unit display, Local/ remote switching keys, SINK/ SOURCE input interface options, stall protection Action: current can be set (in acceleration or constant speed state)

Operating Features and Characteristics - Continued

Operation Mode		LCD keypad with parameter copy function
Protection Features	Stall protection	Threshold current can be set (in acceleration or constant speed, it can be set separately. In deceleration, it can be set on or off)
	Instantaneous Over Current (OC) and output Short Circuit (SC) protection	Inverter shuts off when the current exceeds 200% of the inverter related current.
	Inverter Overload protection (OL2)	Inverter rated current is 150%/1 min, at 200%/2 sec, inverter stops (CT type), carrier frequency factory setting is 8~2 kHz. At 120%/1 min, inverter stops (VT type), carrier frequency factory setting is 2 kHz.
	Motor Overload (OL1) protection	Electrical overload protection curve
	Over Voltage (OV) protection	When the main circuit DC voltage exceeds 410V (230V units)/ 820V (460V units), 1,050V (575V units)/ 1,230V (690V units), the drive faults out regardless of whether it is in run mode or stopped.
	Under Voltage (UV)	When the main circuit DC voltage is under 190V (230V units)/ 380V (460V units), 546V (575V units)/ 575V (690V units), the drive faults out regardless of whether it is in run mode or stopped. The DC voltage trigger level can be adjusted.
	Automatic restart after instantaneous power fault	Power fault exceeds 15 ms. This is programmable to 2 seconds.
	Overheat protection (OH)	By direct temperature detection in the unit
	Ground Fault protection (GF)	Uses current feedback for protection
	Protection in charge state	When main circuit DC voltage exceeds 50V, the "CHARGE" LED is on.
	Output Phase Loss Protection (OPL)	Automatically stops motor rotation and faults
Environmental Specifications	Location	Indoor (protected from corrosive gases and dust)
	Ambient temperature	-10~+40°C without de-rating (IP20/NEMA1), -10~+50°C (IP00), with de-rating, its maximum operation temperature is 60°C
	Storage temperature	-20~+70°C
	Humidity	95%RH or less (no condensation)
	Altitude and vibration	Altitude of 1,000 m (3,300 ft) or lower, vibration below 5.9 m/s ² (0.6G)
Communication function	RS-485 standard with built-in (MODBUS) (RJ45)	
PLC function	Built-in	
EMI protection	The added noise filter complies with EM61800-3, 460V; 215 HP or below can be built-in.	
EMS protection	Follows EN61800-3	

Protection Features

- ASIC designed to protect transistor modules from impact of sudden or rapidly changing current
- EMC filters are available to all 460VAC rated models. Please consult factory.
- Regenerative energy control and over-voltage prevention

Conformal coating
for all models protects
against severe
environments

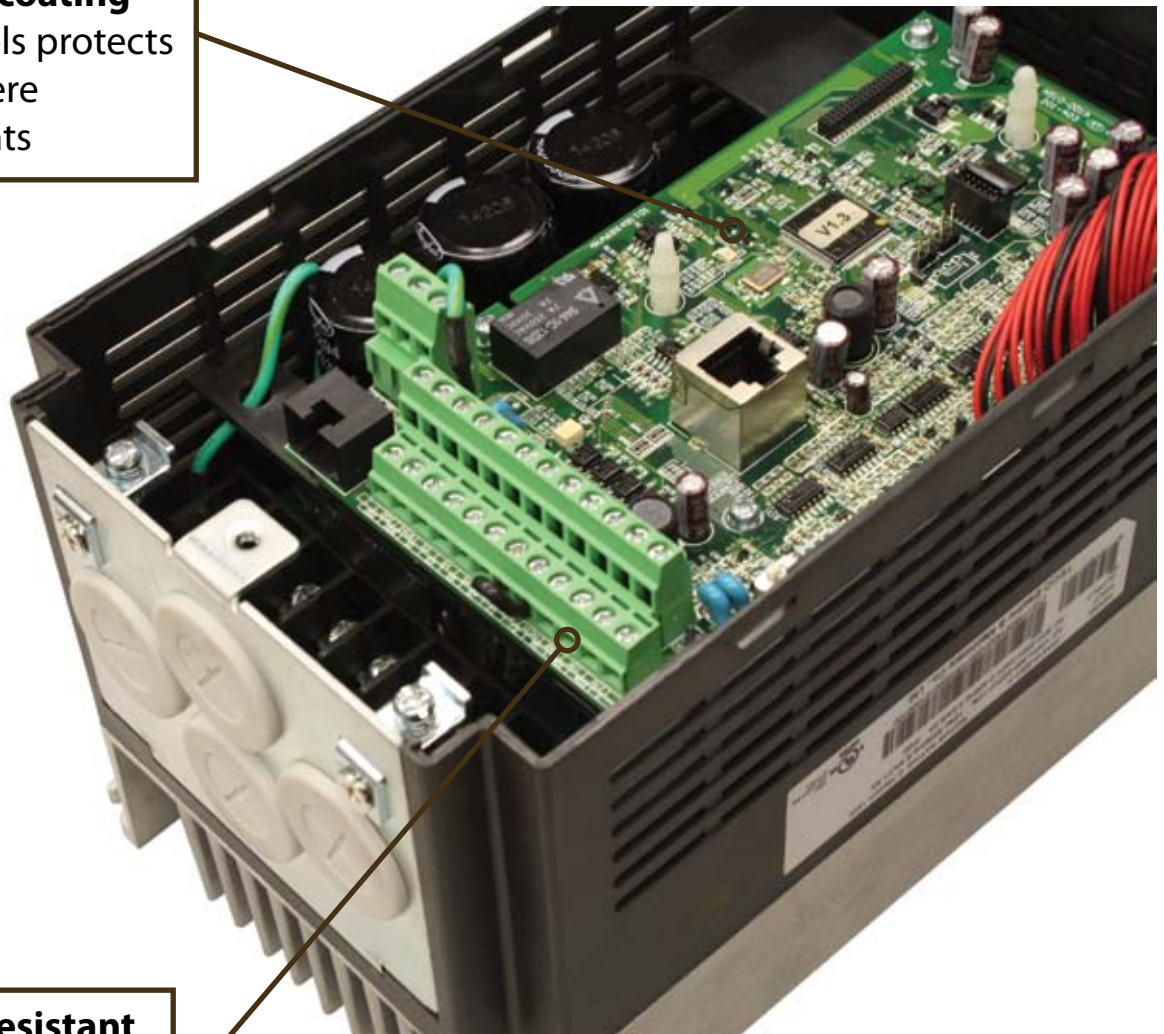

Vibration-resistant
structure reinforces
the connected part
by tenon

Programmable Logic Control (PLC) Capabilities

Applications with more demanding or complex requirements or restrictions on operation can be met with simple PLC functions used directly in the drive unit. For example, the application may be triggered by special operation sequencing or multiple independent events. Another possibility for the PLC functions is a system with permissives that cannot be adequately incorporated directly through the I/O alone.

The PLC function features many types of instruction blocks that will build a ladder logic program.

■ Software relay functions

- Input contacts
- Output coils
- Internal software coils
- Normally open, normally closed, and edge-triggered contacts

■ Numerical function blocks

- Counters (count up or count down to preset value)
- On-delay, off-delay, and on-off interval timing
- Analog comparator to trigger an event when an analog input or internal numerical value is above, below, or within range of a set value
- Operation control functions to run the driven motor
- Add/ subtract and multiply/ divide blocks for signal scaling and conditioning

Example: Relay and Timer Functions

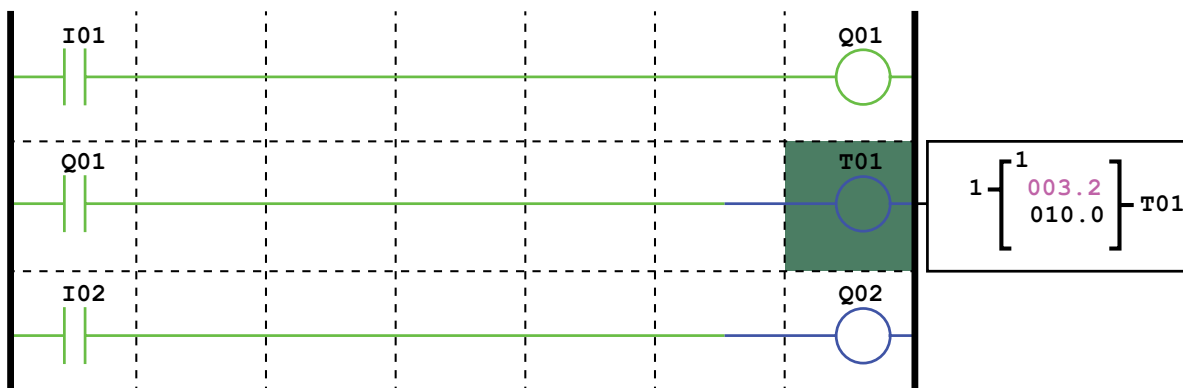

Options and Accessories

PG Encoder cards provide highly accurate speed feedback. The Encoder cards mount inside the cover of the drive for installing and wiring convenience. The following type of encoder cards are available.

JN5-PG-L	Encoder feedback card for a line driver type encoder
JN5-PG-O	Encoder feedback card for open collector or complementary type encoder



The A510 product has a standard RS485 port with RTU Modbus protocol. An optional card for Profibus Communications is available.

JN5-CM-PDP	Profibus DP Communication External Module
JN5-CMHI-PDP	Profibus DP Communication Card Plug-In
JN5-CMHI-CAN	CANopen Communication Card Plug-In
JN5-CMHI-ECAT	EtherCAT Communication Card Plug-In
JN5-IO-2DO1AI	Digital and Analog IO Expansion Card Plug-In
JN5-PS-DC24V	DC24V Power Card Plug-In

Extension cables for remote mounting of the operator's keypad. Select cables below according to the desired distance from the Drive.

JN5-CB-01M	1 Meter
JN5-CB-02M	2 Meters
JN5-CB-03M	3 Meters
JN5-CB-05M	5 Meters

The A510 product has a standard LCD operators keypad. An optional LED type keypad is also available.

JN5-OP-AO1	LED Keypad
JN5-CU	Copy module for fast uploading/ downloading of parameters to multiple drives

NEMA 1 adaptor kits are available for the larger size drives that are built as IP00 units

JN5-NK-A06	Adaptor kit for 230V 50-60 HP and 460V 100-125 HP and 690V 100-150 HP
JN5-NK-A07	Adaptor kit for 230V 75-100 HP and 460V 150-200 HP and 690V 200-250 HP
JN5-NK-A08	Adaptor kit for 460 V 250-400 HP

Configured Packages

HVAC Packages

TECO-Westinghouse offers a complete line of packaged drives, including bypass packages for fan and pump applications.

Features

- Packages up to 1000 HP available
- Available in multiple disconnect options
- Two or three contactor and soft start bypass
- Custom design packages
- Wide range of harmonic filters available to meet IEEE 519-1992
- NEMA 1, NEMA 12, NEMA 3R standard
- NEMA 4 & 4X available indoor or outdoor (custom order)
- Duplex - multiplex packages available
- Packages designed to customer specifications



Applications

- Fans
- Chillers
- Refrigeration
- Compressors
- Air handlers
- Pumps

Industrial Packages

TECO-Westinghouse additionally offers packaged drives to suit even robust industrial applications.

Features

- NEMA 1, NEMA 12, NEMA 3R standard
- Packages up to 1000 HP
- Available in multiple disconnect options
- NEMA 4, 4X indoor or outdoor available (custom order)
- Special designs to meet tight spacing requirements

Applications

- Conveyors
- Compressors
- Mixers
- Stamping/ punch press



TECO **Westinghouse**

TECO-Westinghouse Motor Company offers an extensive line of Variable Speed Drives and Soft Starters for your motor control applications.

We also offer a wide variety of motors that are matched with the Drives and Soft Starters including Vertical Hollow Shaft, Rolled Steel, and NEMA Premium Efficient motors.

From “in stock” controls to engineered systems, we can provide you the right control solution including an extensive line of TECO-Westinghouse AC Motors.



5100 N. IH-35
Round Rock, Texas 78681
1-800-279-4007

www.tecowestinghouse.com

D-A510 1-20

