

## GENERAL DATASHEET VARIABLE SPEED DRIVE

Series <b>A510</b>				MODEL# <b>A510-4001-C3-U</b>		
ISSUED <b>8/31/2016</b>				ENCLOSURE/ FRAME <b>NEMA 1 (IP20) / F1</b>		
INPUT AMPS				AC INPUT VOLTAGE	AC INPUT FREQUENCY	AC INPUT PHASE
HD (CT)		ND (VT)				
<b>3.7</b>		<b>4.5</b>		<b>380-480</b>	<b>50/60</b>	<b>3</b>
OUTPUT HP				AC OUTPUT VOLTAGE	AC OUTPUT FREQUENCY	AC OUTPUT PHASE
HD (CT)		ND (VT)				
<b>1</b>		<b>1</b>		<b>0-480</b>	<b>0-599</b>	<b>3</b>

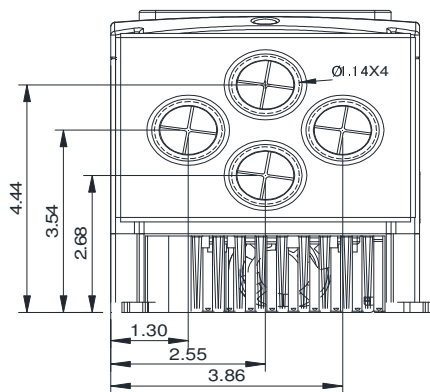
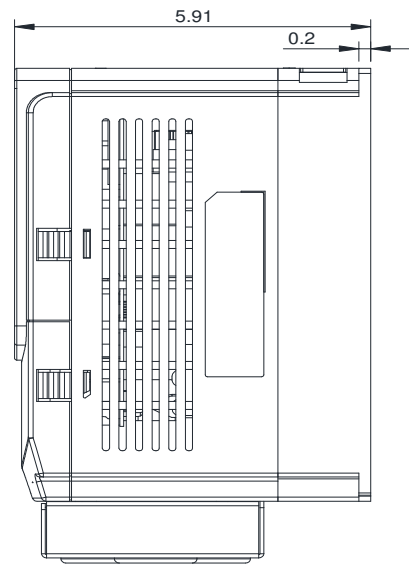
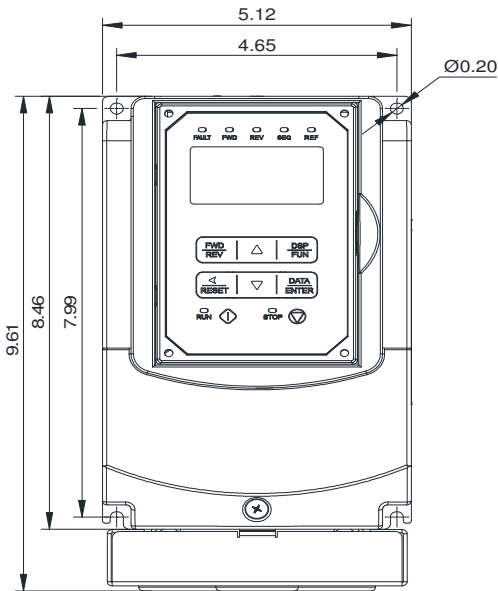

Approved By:	Brian Smith	Drawing No:	A510-460-001-F1	Revision: 0
--------------	-------------	-------------	-----------------	-------------