

# KDR Reactor Installation Guide

When installing the KDR Line Reactors on a Variable Frequency Drive (VFD), please use the following guidelines when wiring the unit:

- The KDR Line/Load Reactor is a 3-phase device and should be wired in series and positioned on the input or output side of the VFD.
- All Terminal Block connectors will be marked. A1, B1, and C1 are the input terminals where the 3 phases of incoming power are to be wired. As a result, A2, B2, and C2 are the output terminals. Units with copper bus or ring lug terminals are not marked. In these cases, either the upper terminals or lower terminals can be used as the input terminals as long as the selection is consistent. Please see website for terminal drawings. <http://www.transcoil.com/Products/KDR-Line-Reactor.htm>
- Power Wiring: Only use 75°C copper conductors unless the wire connector is marked for Al/Cu, then the use of aluminum wire is permitted.
- TCI recommends that these reactors be wired and located as close to the VFD as possible to have the greatest success in protecting sensitive equipment.
- In standard 40°C ambient or less installations, a clearance of 3 inches on all sides of the reactors and its enclosure is recommended for assisting in heat dissipation and ample wire bending space.
- This reactor should only be installed and wired by personnel trained and familiar with local codes, NEC Article 110, and/or UL 508A.

- Single-phase applications are acceptable, however, it is important to size the unit based on the single-phase Full Load Amperage of the VFD. The input and output connections should be on terminals A and C to ensure proper performance.
- These reactors are designed to be floor-mounted or wall-mounted. Large open-style devices should be panel mounted by incorporating a bracket that would act as a shelf to support the reactor and/or enclosure. When installing an open style device in an existing enclosure, the reactor should be mounted in the lower half of the cabinet to prevent hot spots or pockets of heat. Reactors with ducts are designed to be mounted vertically for proper cooling and maximum air flow.

## Product Specifications

- ▶ 3-Phase, 690/600 Volt Class as marked
- ▶ UL Listed (cULus) or UL Recognized (cURus) and CSA listed (CSA) as marked
- ▶ CE Marked
- ▶ Current-rated device
- ▶ 200% rated current for 3 minutes
- ▶ Ambient Temperature: 40°/50°C as marked

For more information on TCI line reactors, including drawings and schematics, visit: [transcoil.com/Products/KDR-Line-Reactor.htm](http://transcoil.com/Products/KDR-Line-Reactor.htm)

For product support, please contact our TCI Technical Support Team-800-824-8282.



W132 N10611 Grant Drive  
Germantown, WI 53022  
Ph: 800-TCI-8282 | [transcoil.com](http://transcoil.com)



# KDR Reactor Installation Instructions

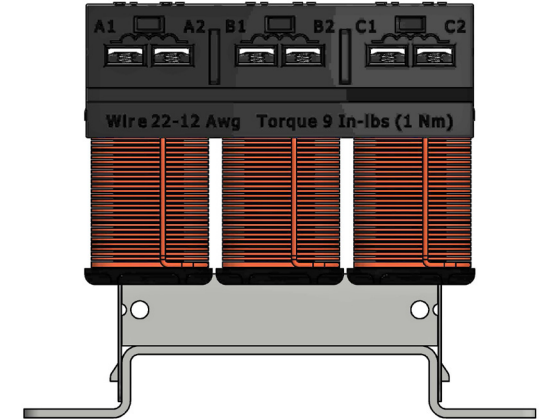

## Field Wiring Diagrams

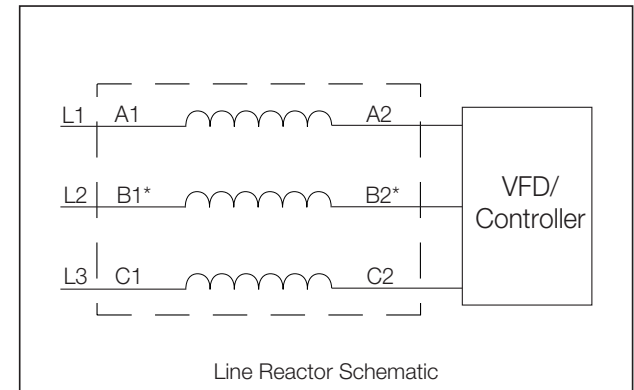

For single-phase applications, use coils A and C.  
Isolate terminals B1 and B2.

# KDR Reactor Lug Kits



Follow NEC guidelines to determine acceptable wire ampacity requirements.

Lug Kit	Figure Number	Lug Wire Range	For Lug Torque	Bolt Assembly Torque	See Website For Lug On Reactor Drawings
SLK10	1	2/0-14AWG	See Table S2/0	66 in-lb (7.5 N-m)	See Drawing (LK10-DWG)
SLK11	1	250MCM-6AWG	See Table S250	135 in-lb (15.3 N-m)	See Drawing (LK11-DWG)
SLK12	1	600MCM-4AWG	See Table S600	200 in-lb (22.6 N-m)	See Drawing (LK12-DWG)
SLK13	2	(2) 350MCM-6AWG	See Table 2S350	450 in-lb (50.8 N-m)	See Drawing (LK13-DWG)
SLK14	2	(2) 600MCM-4AWG	See Table 2S600	450 in-lb (50.8 N-m)	See Drawing (LK14-DWG)
SLK15	2	(2) 800MCM-300MCM	See Table AU-800	450 in-lb (50.8 N-m)	See Drawing (LK15-DWG)
SLK16	3	(3) 600MCM-2AWG	See Table T3A2-600N	450 in-lb (50.8 N-m)	See Drawing (LK16-DWG)
SLK17	4	(4) 600MCM-2AWG	See Table T4A4-600N	450 in-lb (50.8 N-m)	See Drawing (LK17-DWG)
SLK18	4	(4) 800MCM-300MCM	See Table T4A4-800N	450 in-lb (50.8 N-m)	See Drawing (LK18-DWG)
SLK21	1	250MCM-6AWG	See Table S250	66 in-lb (7.5N-m)	See Drawing (LK21-DWG)
SLK17-BB	5	(4) 600MCM-2AWG	See Table T4A4-600N	450 in-lb (50.8 N-m)	See Drawing (LK17-bb-DWG)
SLK18-BB	5	(4) 800MCM-300MCM	See Table T4A4-800N	450 in lb (50.8 N-m)	See Drawing (LK18-bb-DWG)

## Lug Torque Tables

Combined KDR Lug Kits-A.idw

Table S2/0 IHI Connectors				
Wire Size Copper (solid to semi-rigid stranded and metric mm <sup>2</sup> , ##)	Rating C	Wire Size FLEX Copper (#)	Wire Size Aluminum	Torque (all drive means)
N/A	90	1/0-1	N/A	75 in-lb (8.5 N-m)
N/A	90	1-4	N/A	55 in-lb (6.2 N-m)
2/0-3	90	4-8	2/0-3	50 in-lb (5.6 N-m)
4-6	90	8-10	4-6	45 in-lb (5.1 N-m)
8	90	10-14	8	40 in-lb 4.5 N-m)
10-14	90	N/A	10-12	35 in-lb (4.0 N-m)

Table S250 IHI Connectors				
Wire Size Copper (solid to semi-rigid stranded and metric mm <sup>2</sup> , ##)	Rating C	Wire Size FLEX Copper (#)	Wire Size Aluminum	Torque (all drive means)
250kcmil-2	90	3/0-2 AWG 70-50 mm <sup>2</sup>	250-2	375 in-lb (42.4 N-m)
(1),(2) 25-16 mm <sup>2</sup> (1) 35 mm <sup>2</sup>	90	2-6 AWG 35-16mm <sup>2</sup>	2-6	275 in-lb (31.1 N-m)

Table S600 IHI Connectors				
Wire Size Copper (solid to semi-rigid stranded and metric mm <sup>2</sup> , ##)	Rating C	Wire Size FLEX Copper (#)	Wire Size Aluminum	Torque (all drive means)
600kcmil-4	90	444-2	600-4	500 in-lb (56.5 N-m)

Table 2S350 IHI Connectors				
Wire Size Copper (solid to semi-rigid stranded and metric mm <sup>2</sup> , ##)	Rating C	Wire Size FLEX Copper (#)	Wire Size Aluminum	Torque (all drive means)
350kcmil-2	90	262-2	350-2	375 in-lb (42.4 N-m)
2-6	90	2-4	2-6	275 in-lb (31.1 N-m)

Table 2S600 IHI Connectors				
Wire Size Copper (solid to semi-rigid stranded and metric mm <sup>2</sup> , ##)	Rating C	Wire Size FLEX Copper (#)	Wire Size Aluminum	Torque (all drive means)
600kcmil-4	90	444-2	600-4	500 in-lb (56.5 N-m)
CSA, 200116 UL Listed 84JM ZMVV E129884 (#) FLEX-covers stranding classes within G,H,I/DLO, Metric class 5 and K/MTW,(##) mm <sup>2</sup> sizes within AWG/kcmil ranges are included.				

Table AU-800				
Item ID	Conductor Range	Bolt/Stud Size	Hex Size	Tightening Torque
AU-800	800kcmil-300kcmil	1/2	1/2	500 in-lb (56.5 N-m)

Table T3A2-600N				
Item ID	Conductor Range	Bolt/Stud Size	Hex Size	Tightening Torque
T3A2-600N	600kcmil-2AWG	1/2	1/2	500 in-lb (56.5 N-m)

Table T4A4-600N				
Item ID	Conductor Range	Bolt/Stud Size	Hex Size	Tightening Torque
T4A4-600N	600kcmil-2AWG	1/2	1/2	500 in-lb (56.5 N-m)

Table T4A4-800N				
Item ID	Conductor Range	Bolt/Stud Size	Hex Size	Tightening Torque
T4A4-800N	800kcmil-300kcmil	1/2	1/2	500 in-lb (56.5 N-m)

## DIN Rail Kits

Reactor Part Number	DIN Rail Kit
KDRMAxxxxxxx	DR01
KDRAAxxxxxxx	DR02
KDRAXxxxxxxx	DR02
KDRBxxxxxxx	DR02

Full listing available at [transcoil.com](http://transcoil.com)

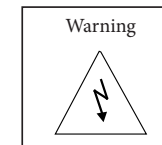

- Disconnect all power before working on the equipment. Do not attempt any work on a powered reactor.
- The reactor, VFD, motor, and other connected equipment must be properly grounded.
- The VFD terminals and connected cables are at a dangerously high voltage when power is applied to the VFD, regardless of motor operation.
- All electrical connections must be re-torqued annually.

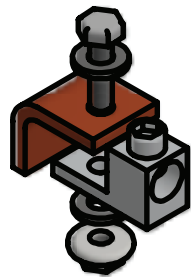

Figure 1

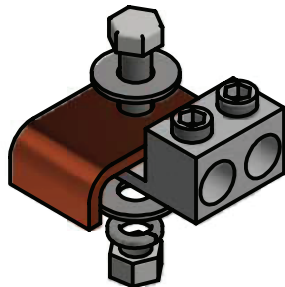

Figure 2

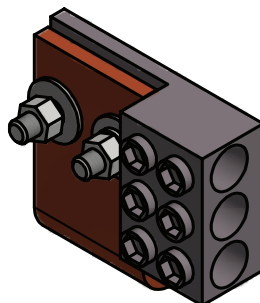

Figure 3

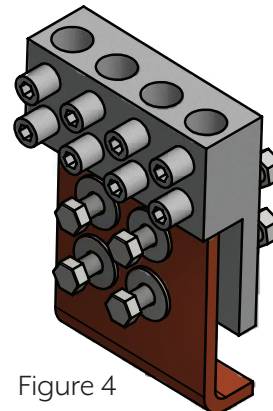

Figure 4

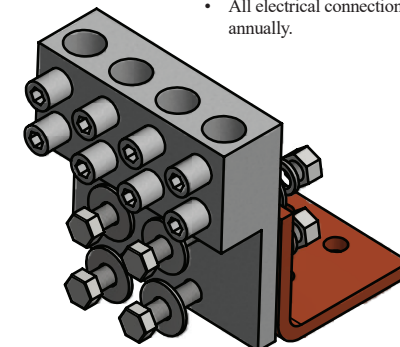

Figure 5