

DC Process

Falcon F45 Series Digital Panel Meter



- Full 4-1/2 Digit, Bright Red 0.56" (14.2mm) Display
- Broad Range Display Scaling
- Short 2.94" (74.7mm) Deep, 1/8 DIN Case
- Screw Terminal Connector for Easy Installation
- Three DC Process Ranges: 4-20mA, 1-5VDC, and 0-10VDC
- Optional Isolated 9-32VDC Power Supply
- Optional Excitation Output of 12V or 24VDC

The Falcon Series digital indicators are premium quality 1/8 DIN meters for industrial applications. All Falcon units feature jumper-selectable decimal point (internal and on the connector for remote decimal point) and display scaling, providing wide application flexibility. In addition, signal input ranges are easy to change with jumpers on the main board. The Falcon has a 0.56" bright red LED display for high visibility.

Compactly designed for applications requiring minimal rear panel depth, the Falcon fits a standard 1/8 DIN panel cutout (91.9mm x 45mm) and requires less than 3" behind the panel. A screw terminal connector is a standard feature for easy wiring of the power supply and signal input connections.

Installation and Panel Cutout

Mounting Requirements
 The Falcon series 1/8 DIN indicators require a panel cutout of 1.77" (45mm) high by 3.62" (91.9mm) wide. To install the Falcon into a panel cutout, remove the clips from the side of the meter. Slide the meter through your panel cutout, then slide the mounting clips back on the meter. Press evenly to ensure a proper fit.

Engineering Label Placement
 If replacement of the engineering unit label is required, place the tip of a ball-point pen into the small hole at the base of the engineering label in the bezel. Slide the label up until it pops out. Grasp and remove. Slide the new label half the distance in, then use the ball-point pen to slide it down into place.

Specifications

DISPLAY

Type: 7-segment, red LED
Height: 0.56" (14.2mm)
Decimal Point: 4-position programmable internally or at terminal block J112
Overrange indication: most significant digit = "1"; other digits blank
Polarity: Automatic, with "-" indication, "+" indication implied

POWER REQUIREMENTS

AC Voltages: 120 or 220VAC, ±10% 50/60Hz
DC Voltages: 9-32VDC; 9V -1% and 32+1%
Power Consumption: 2VA

ACCURACY @25°C

±0.02% of reading ±1 count

ENVIRONMENTAL

Operating Temperature: 0 to 55°C
Storage Temperature: -10 to 60°C
Relative Humidity: 0 to 85% non-condensing

Temperature Coefficient:
 (±0.05% of input ±0.1 count)/°C

Warm-up Time: Less than 15 minutes
Response Time: Less than 1 second

NOISE REJECTION

NMRR: 60dB, 50/60Hz
CMRR: (w/1kΩ unbalanced @60Hz): 90dB min.

ANALOG TO DIGITAL CONVERSION

Technique: Dual slope integration
Rate: 2.5 samples per second, nominal

MECHANICAL

Bezel: 3.78" x 1.89" x .51" (96 x 48 x 13mm)
Depth: 2.94" (74.7mm)
Panel Cut-out: 3.62" X 1.77" (91.9 x 45mm 1/8 DIN)

Case Material: 94V-1, UL rated Noryl®
Weight: 9.0oz (255.1g)

INPUTS: DC Process

Input Range	Display Resolution	Voltage Drop	Maximum Overload
4-20mA	1µA	0.2V	100mA
1-5V		(Input Impedance) >9.9MΩ	250V
0-10V	1mV	>9.9MΩ	250V

Wiring Diagram

1	2	3	4	5	6	7	8	9	10	11	12	
IN HI	IN LO	HOLD	DIG GND	DP 1	DP 2	DP 3	DP 4	+ EXC	- EXC	AC GND	AC LO	AC HI

Input Signal: Connect the signal to be monitored to the IN HI and IN LO terminals. These are terminals #1 and #2.

Supply Power: Connect the power to terminals #11 and #12. Note that if AC power is applied, terminal #11 is for neutral, and terminal #12 is for hot. If DC power is used, terminal # 11 is for -DC, and #12 is for +DC.

Display Hold: This feature allows you to hold the displayed value indefinitely. A remote switch or computer, etc. can be used to activate this feature. To activate feature, short pins 3 and 4 (HOLD and DIG GND). This connection must be kept isolated from other circuitry. To hold multiple units, separate poles of the switch must be used to maintain the isolation.



These instruments are designed for maximum safety to the operator when mounted in a panel according to instructions. They are not to be used unmounted or for exploratory measurements in unknown circuits.

Decimal Point Selection

From terminal block J112: The decimal point can be set from the rear screw terminal block J112. Connect the appropriate DP point (DP 1,2,3,4) to the DIG GND terminal. Internal jumper (J107) must be removed.

Point	Connect
1.9999	DIG GND to DP1
19.999	DIG GND to DP2
199.99	DIG GND to DP3
1999.9	DIG GND to DP4

J112												
1	2	3	4	5	6	7	8	9	10	11	12	
IN HI	IN LO	HOLD	DIG GND	DP 1	DP 2	DP 3	DP 4	+ EXC	- EXC	AC GND	AC LO	AC HI

Main Board

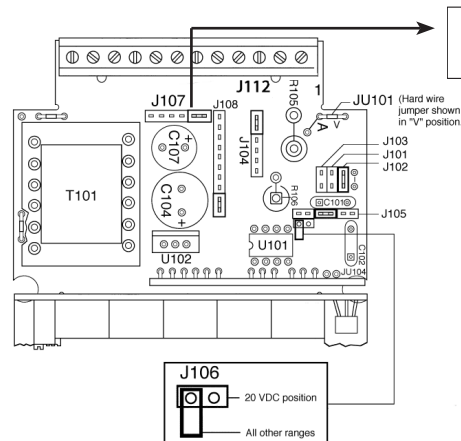

Jumper shown in 'A' position

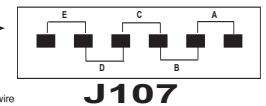

Decimal Point	Jumper Position at J107
1.9999	A (DP 1)
19.999	B (DP 2)
199.99	D (DP 3)
1999.9	E (DP 4)

Process Range Selection

All Falcon Indicators are configured initially per the customer specified part number. Range changes can easily be accomplished as follows: Disconnect power and pop the front bezel off with a small screwdriver, taking care to keep the gaskets in place. Unscrew the main board from the case with a Phillips head screwdriver, and slide the main board out.

Note: If a new range is selected, the calibration and scaling procedure must also be performed. Only perform this section if a different function or range is required.

4-20mA					
J104 Push-On Jumper			JU101* Jumper Position		
D			A		
1-5VDC or 0-10VDC					
J105 PJ	J106 PJ	J101 PJ	J102 PJ	J103 PJ	JU101* Jumper Position
B	YES	YES	NO	NO	V

Note: JU101* is a hard wire jumper and can be removed by cutting it. Resoldering the JU jumpers is not recommended. If this is required, or if a function is to be changed from volts to current, Simpson recommends returning the Falcon to the factory or an Authorized Service Center. After moving the jumpers to the desired location, put the Falcon back together and install in your panel, or proceed to calibration.

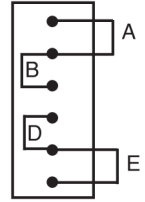
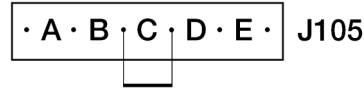

J104

Display Scaling

The Falcon display can be easily scaled to a broad range of engineering units. The meter can be scaled down to 1/2 of the input value. Remove the front bezel with a small screwdriver. The scaling procedure is performed at terminal J1 located on the left side of the display board. There are four sets of pins of J1. Each group of pins programs a particular parameter of the scaling procedure when a push-on jumper (supplied with the Falcon) is momentarily placed across a set of pins.

Before scaling the parameters, begin by disconnecting power to the Falcon. Place push-on jumper onto "SET UP" pins C and 2, then apply power. At this point, the Falcon performs a self test (scrolls LED display) and then indicates LoE, allowing you to enter the low electrical input value.

The scaling parameters for electrical low input value (LoE), electrical high input value (HiE), display low value (Lo), and display high value (Hi) are performed as follows:

Remove push-on jumper from C-2 and then replace. Numeral zero or digit of LoE value (set at the factory) and flashing decimal point are displayed at starting LED position. The digit to be entered is always to the left of the flashing decimal point. The flashing decimal point is moved one position each time the push-on jumper is momentarily placed across "SET UP" pins C and 2. Change the value at the LED position chosen by momentarily placing jumper across "UP" pins C and 3. This will increase the value by 1 for each repetition. Repeat jumper placement until the desired value is displayed. To decrease a displayed value, momentarily place jumper across "DOWN" pins C and 4.

After the desired numeric value is obtained, remove the jumper and momentarily place it across the "ENTER" pins C and 1. This will store the value in memory and move on to the next parameter. Repeat this procedure through each parameter.

After programming the last parameter (Hi) of the scaling procedure, LED will display "END" and then indicate scaled value of the electrical input to the meter. The unit is now in run mode.

Note: During programming, the flashing decimal point is considered as a cursor only. The placement of the digits in the positions 1 to 5 is important, and dependent on the set input range.

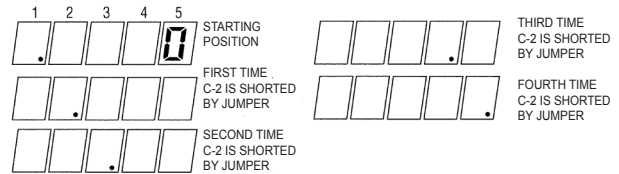

J1

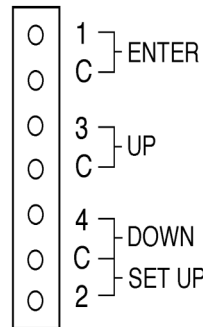

Enter-Saves digits displayed and advances to next scaling parameter when jumper makes momentary contact with pins 1 and C.

UP-Changes digit displayed to next ascending value when jumper makes momentary contact with pins 3 and C.

DOWN-Changes digit displayed to next descending value when jumper makes momentary contact with pins 4 and C.

SET UP-Starts scaling cycle of the four scaling parameters (LoE, HiE, Lo and Hi) and selects digit to be entered to the left of the flashing decimal point on display when jumper makes momentary contact with pins 2 and C.

Excitation Output

An optional feature of the Falcon is a 12 or 24 VDC output.

The Falcon is set at the factory per your order to include an excitation plug-in printed circuit board.

This PCB, located on the main board, can be reconfigured by moving push-on jumper J201 to change the excitation output.

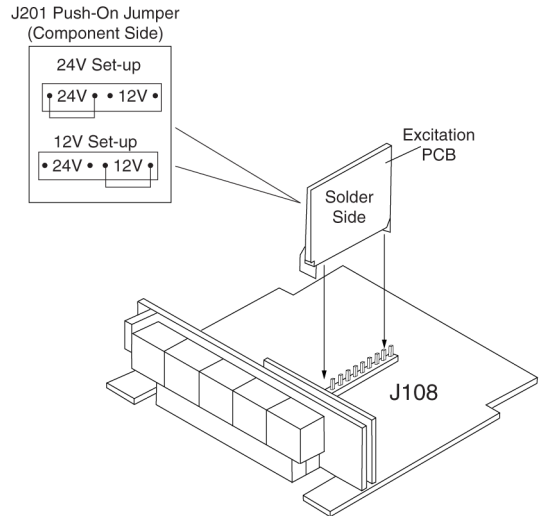

Calibration

The unit is calibrated at the factory per order. If you selected another range and moved the jumpers, your Falcon will need to be recalibrated. If parameters (HiE, etc.) are changed, scaling must be performed prior to calibration.

- 1) Remove the bezel with a small screwdriver.
- 2) Apply a full scale input signal to the instrument.
- 3) Adjust the potentiometer R1 located on the upper left-hand side of the display board until display shows the full scale voltage.
- 4) Replace bezel carefully.

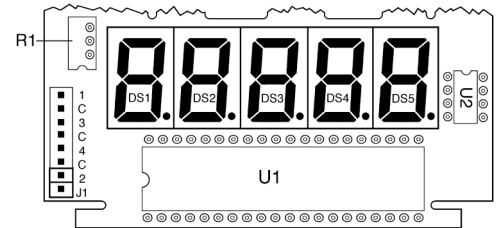

Ordering Information

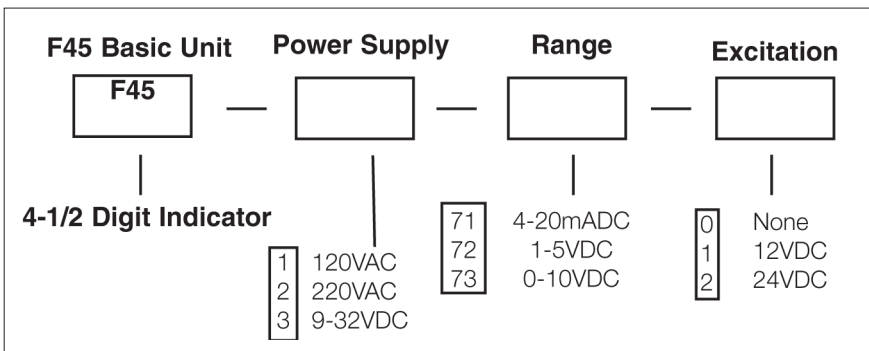

Safety Symbols



The WARNING sign denotes a hazard. It calls attention to a procedure, practice, or the like, which, if not correctly performed or adhered to, could result in personal injury.



The CAUTION sign denotes a hazard. It calls attention to an operating procedure, practice, or the like, which, if not correctly adhered to, could result in damage to or destruction of part or all the instrument.