



EN Operating instructions.pages 1 to 6
Original

Content

1 About this document

1.1 Function 1

1.2 Target group: authorised qualified personnel. 1

1.3 Explanation of the symbols used 1

1.4 Appropriate use 1

1.5 General safety instructions 1

1.6 Warning about misuse 1

1.7 Exclusion of liability 2

2 Product description

2.1 Ordering code 2

2.2 Special versions. 2

2.3 Purpose 2

2.4 Technical Data 2

2.5 Safety classification 2

3 Mounting

3.1 General mounting instructions 3

3.2 Mounting set-up 3

3.3 Dimensions 3

4 Electrical connection

4.1 General information for electrical connection. 4

4.2 Contact Options 4

5 Set-up and maintenance

5.1 Functional testing. 4

5.2 Maintenance 4

6 Disassembly and disposal

6.1 Disassembly. 4

6.2 Disposal 4

7 EU Declaration of conformity

1. About this document

1.1 Function

This operating instructions manual provides all the information you need for the mounting, set-up and commissioning to ensure the safe operation and disassembly of the safety switchgear. The operating instructions must be available in a legible condition and a complete version in the vicinity of the device.

1.2 Target group: authorised qualified personnel

All operations described in this operating instructions manual must be carried out by trained specialist personnel, authorised by the plant operator only.

Please make sure that you have read and understood these operating instructions and that you know all applicable legislations regarding occupational safety and accident prevention prior to installation and putting the component into operation.

The machine builder must carefully select the harmonised standards to be complied with as well as other technical specifications for the selection, mounting and integration of the components.

1.3 Explanation of the symbols used



Information, hint, note:

This symbol indicates useful additional information.



Caution: Failure to comply with this warning notice could lead to failures or malfunctions.

Warning: Failure to comply with this warning notice could lead to physical injury and/or damage to the machine.

1.4 Appropriate use

The Schmersal range of products is not intended for private consumers.

The products described in these operating instructions are developed to execute safety-related functions as part of an entire plant or machine. It is the responsibility of the manufacturer of a machine or plant to ensure the correct functionality of the entire machine or plant.

The safety switchgear must be exclusively used in accordance with the versions listed below or for the applications authorised by the manufacturer. Detailed information regarding the range of applications can be found in the chapter "Product description".

1.5 General safety instructions

The user must observe the safety instructions in this operating instructions manual, the country specific installation standards as well as all prevailing safety regulations and accident prevention rules.



Further technical information can be found in the Schmersal catalogues or in the online catalogue on the Internet: products.schmersal.com.

The information contained in this operating instructions manual is provided without liability and is subject to technical modifications.

There are no residual risks, provided that the safety instructions as well as the instructions regarding mounting, commissioning, operation and maintenance are observed.

1.6 Warning about misuse



In case of improper use or manipulation of the safety switchgear, personal hazards or damages to machinery or plant components cannot be excluded.

1.7 Exclusion of liability

We shall accept no liability for damages and malfunctions resulting from defective mounting or failure to comply with this operating instructions manual. The manufacturer shall accept no liability for damages resulting from the use of unauthorised spare parts or accessories.

For safety reasons, invasive work on the device as well as arbitrary repairs, conversions and modifications to the device are strictly forbidden, the manufacturer shall accept no liability for damages resulting from such invasive work, arbitrary repairs, conversions and/or modifications to the device.

2. Product description

2.1 Ordering code

This operating instructions manual applies to the following types:

ZQ 700-①

No.	Option	Description
①	11	1 NO contact/1 NC contact
	02	2 NC contacts



Only if the information described in this operating instructions manual are realised correctly, the safety function and therefore the compliance with the Machinery Directive is maintained.

2.2 Special versions

For special versions, which are not listed in the order code below 2.1, these specifications apply accordingly, provided that they correspond to the standard version.

2.3 Purpose

Pull-wire emergency stop switches are used on machinery and plants, where triggering the emergency stop command must be enabled at arbitrary points on the wire run. If the tensioned pull-wire is pulled or in case of wire breakage, the switching function of the pull-wire emergency stop switch is activated. (refer to image 1)

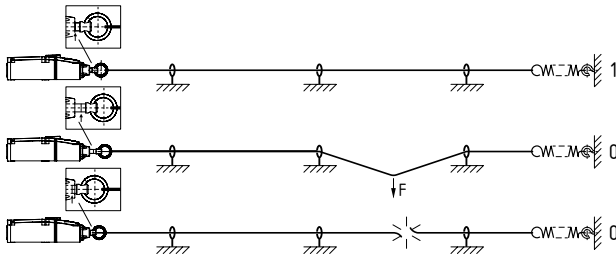

Image 1: Position indication and actuation

Design/operating principle

The pull-wire emergency stop switches of the ZQ 700 series are brought into the operational condition by the proper pre-tensioning of a maximum 10 m long wire. The inner switching element has 2 contacts; in a tensioned condition, the NC contacts are closed and the NO contacts are open.

After actuation of the emergency stop function, a latching mechanism maintains the stop command until the switch is released by pushing the blue reset button.

Prior to the reset of the emergency stop signal, the reason why the switch has been actuated must be determined. The switch can only be reset if the switch is correctly pre-tensioned (position indication in central position, refer to image 1).



The user must evaluate and design the safety chain in accordance with the relevant standards and the required safety level.



The entire concept of the control system, in which the safety component is integrated, must be validated to the relevant standards.

2.4 Technical Data

Standards:	EN 60947-5-1, EN 60947-5-5, EN ISO 13850
Enclosure:	thermoplastic
Cover:	thermoplastic
Degree of protection:	IP67 to EN 60529
Protection class:	II
Degree of pollution:	3
Contact material:	Silver
Switching system:	change-over contact with double break, 1 to 2 NC contacts, snap action with positive break NC contacts
Termination:	screw terminals
Cable section:	max. 2.5 mm ² (incl. conductor ferrules)
Cable entry:	1x M20
Utilisation category AC-15, DC-13 I _e /U _e :	4 A / 240 VAC, 4 A / 24 VDC
Rated impulse withstand voltage U _{imp} :	6 kV
Rated insulation voltage U _i :	500 V
Thermal test current I _{the} :	10 A
Short circuit resistance:	6 A gG D-fuse
Required short-circuit current:	1,000 A
Ambient temperature:	-25 °C ... +70 °C
Relative humidity:	30 ... 95%, non condensing, non icing
Wire length:	max. 10 m depending in relation to the range of ambient temperature (see image 4)
Mechanical life:	> 1 million operations



Input terminal wire size AWG: 14-22

Max. Torque: 7 Lb In

Use solid or stranded copper conductors only.

2.5 Safety classification

Standards:	EN ISO 13849-1
B _{10D} NC contact:	100,000
Mission time:	20 years

$$MTTF_D = \frac{B_{10D}}{0,1 \times n_{op}} \quad n_{op} = \frac{d_{op} \times h_{op} \times 3600 \text{ s/h}}{t_{cycle}}$$

(Determined values can vary depending on the application-specific parameters hop, dop and t_{cycle} as well as the load.)

If multiple safety components are wired in series, the Performance Level to EN ISO 13849-1 will be reduced due to the restricted error detection under certain circumstances.

3. Mounting

3.1 General mounting instructions

The installation may only be carried out by authorised personnel. The pull-wire emergency stop switch is fitted by means of four screws (distance of the drill holes 30 mm or 60 mm), so that a release by hand can be enabled without hazard. The component must be fitted so that the entire length of the wire can be viewed from the position of the switch.



In accordance with EN 60947-5-5, the maximum perpendicular traction force to be exercised on the wire in order to activate the emergency pull-wire switch is 200 N, the maximum deflection 400 mm. Sufficient space must be provided so that the required actuating deflection can be reached.

As the thimbles are subject to deformation in case of wire pull, the wire should be pulled several times after fitting. After that, the wire must be re-tensioned (see image 3).

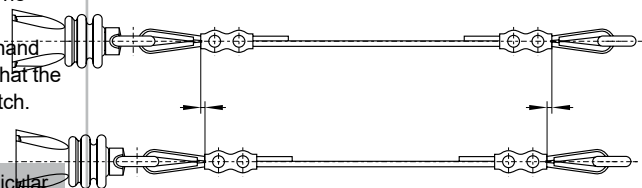

Image 3: Deformation of the wire thimbles

3.2 Mounting set-up

For tensioned span lengths up to 10 m, intermediate wire supports are required every 2 to 5 m. To avoid resonance vibrations in the wire and without an external tension spring is shown in the graph. on machines with high vibrations, it is recommended to realise the individual support length differently. Assembly: refer to image 2.

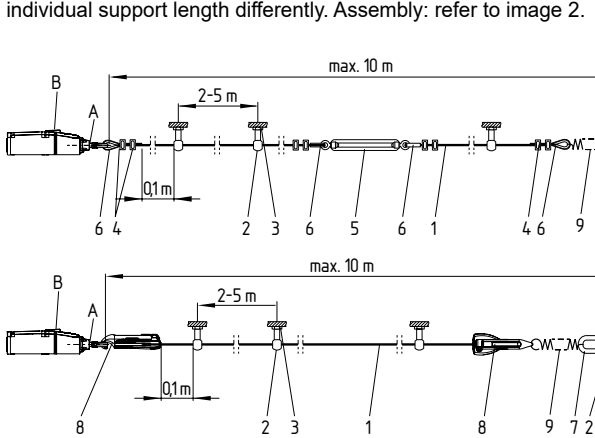

Image 2: Mounting of the components

The correct operation of the product is directly related to the data presented in the graph.

The maximum rope length depends on the temperature change to which the pull rope system is exposed. The corresponding rope length with and without an external tension spring is shown in the graph.

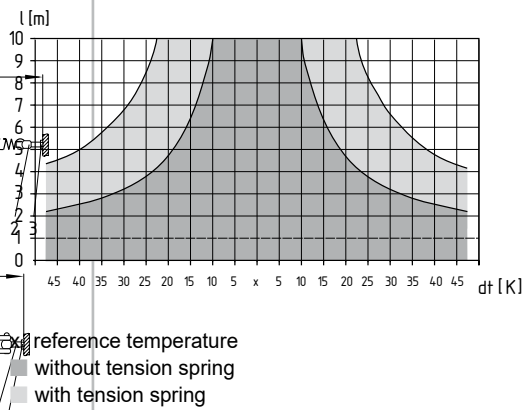

Image 4: temperature-dependent maximum length of wire with or without tension spring

Key

- 1 Pull-wire with red PVC sheath Ø 5 mm (steel core: Ø 3 mm)
- 2 Eyebolt
- 3 Nut
- 4 Wire clamp
- 5 Tensioner
- 6 Wire thimble
- 7 Shackle
- 8 S900 wire tensioner
- 9 Tension spring ACC-700-RZ173
- A Position indication
- B Reset button

The pull-wire must be fixed to the ring and then be pre-tensioned until the position indication is in the central position (refer to image 1).

3.3 Dimensions

All measurements in mm.

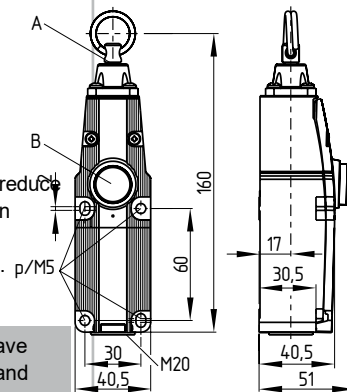

Position indication
Reset button

We recommend the use of the ACC-700-RZ173 tension spring to reduce the effects of temperature variations. Due to the thermal expansion behaviour of the wire, the maximum authorised length of wire is determined by the ambient temperature change (refer to image 4).



In order to ensure an optimal operation safety and to save time during fitting, we recommend using the wire rope and the combined fixing and tensioning system from Schmersal. Alternatively, wire thimbles and wire clamps can be used in conjunction with a tensioner. In this case, the red PVCA sheet must be removed in the clamp area prior to installing the wire rope.

4. Electrical connection

4.1 General information for electrical connection



The electrical connection may only be carried out by authorised personnel in a de-energised condition.

1. Cover screws must be loosened
2. Dust shield cap remove
3. Cable glands M20 x 1.5 with an appropriate degree of protection must be used
4. When wiring, please ensure that no cables are located within the range of the lever system and the pushbutton
5. The inside of the switch must be imperatively cleaned (e.g. removal of cable residues), considering that foreign bodies can affect the switching behaviour
6. The cover screws must be tightened uniformly (tightening torque 0.5 Nm)

Settle length x of the conductor: 6 mm

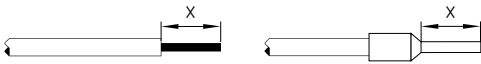

The switch with plastic enclosure is double insulated. The use of an earth wire is not authorised.

Accessories cable gland:

Ordering code: 103006013
 Authorised cable diameter: 6 - 12 mm
 Tightening torque: 4.5 Nm

4.2 Contact Options

All NC contacts have positive break \ominus .

ZQ 700-11

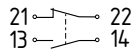

ZQ 700-02

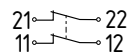

5. Set-up and maintenance

5.1 Functional testing

The safety function of the safety components must be tested. The following conditions must be previously checked and met:

1. Check the correct fitting of the pull-wire emergency stop switch
2. Check the integrity of the cable entry and connections
3. Check the switch enclosure for damage
4. Check the functionality of the switch by actuating the wire
5. Check the cable tensioning by means of the position indicator

5.2 Maintenance

A regular visual inspection and functional test, including the following steps, is recommended:

1. Check the functionality of the switch by actuating the wire
2. Check the cable entries and the wire connections
3. Remove particles of dust and soiling
4. Check the wire tension through the wire position indication and check the wire and the wire guides for damages and proper fitting



Do not open the device when live.

Damaged or defective components must be replaced.

6. Disassembly and disposal

6.1 Disassembly

The safety switchgear must be disassembled in a de-energised condition only.

6.2 Disposal

The safety switchgear must be disposed of in an appropriate manner in accordance with the national prescriptions and legislations.

7. EU Declaration of conformity

EU Declaration of conformity



Original
SCHMERSAL
Industrial Switchgear (Shanghai) Co., Ltd.
Cao Ying Road 3336
201712 Shanghai / Qingpu
P.R.CHINA
www.schmersal.com.cn

We hereby certify that the hereafter described components both in their basic design and construction conform to the applicable European Directives.

Name of the component: ZQ 700

Type: See ordering code

Description of the component: Pull-wire emergency stop switches

Relevant Directives: 2006/42/EC Machinery Directive
2011/65/EU RoHS-Directive

Applied standards: EN 60947-5-1:2017
EN 60947-5-5:1997 + A1:2005 + A11:2013 + A2:2017
EN ISO 13850:2015

Person authorised for the compilation of the technical documentation: Oliver Wacker
Möddinghofe 30
42279 Wuppertal

Place and date of issue: Shanghai, February 24, 2022

Legally binding signature
Michele Seassaro
Managing Director

SISS-ZQ700-G-EN



The currently valid declaration of conformity can be downloaded from the internet at products.schmersal.com.



K.A. Schmersal GmbH & Co. KG
Möddinghofe 30, 42279 Wuppertal
Germany
Telefon: +49 202 6474-0
Telefax: +49 202 6474-100
E-Mail: info@schmersal.com
Internet: www.schmersal.com

Production site:

SCHMERSAL

Industrial Switchgear (Shanghai) Co., Ltd.

Cao Ying Road 3336
201712 Shanghai / Qingpu, P.R.CHINA

Phone: +86 21 63758287
Fax: +86 21 69214398
E-Mail: info@schmersal.com.cn
Internet: www.schmersal.com.cn

施迈赛工业开关制造（上海）有限公司

地址：上海市青浦区漕盈路3336号
邮编：201712

电话：021 63758287
传真：021 69214398

网址：www.schmersal.com.cn