

Datasheet - BPS 260-1

Safety sensors / BNS 260 / Actuator / BPS 260



Preferred typ

• Actuator and sensor on a mounting level



(Minor differences between the printed image and the original product may exist!)

Ordering details

Product type description	BPS 260-1
Article number	101184395
EAN code	4030661321936
eCl@ss	27-27-92-17

Global Properties

Product name	Magnet
Materials	
- Material of the housings	Plastic
Weight	14.5 g
notice	Actuator and sensor on a mounting level

Mechanical data

Actuation direction	0°
---------------------	----

Dimensions

Dimensions of the actuators	
- Width of the actuator	26 mm
- Height of the actuator	36 mm
- Length of the actuator	13 mm

Images

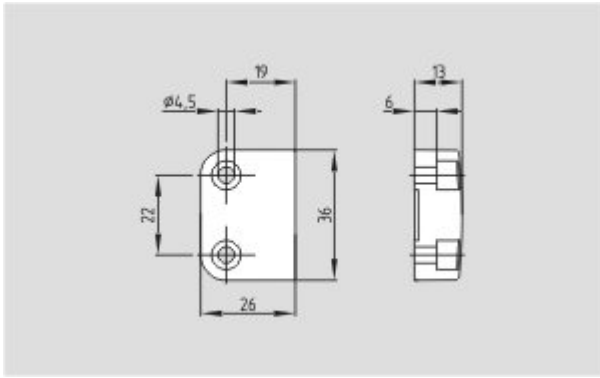

Dimensional drawing (miscellaneous)

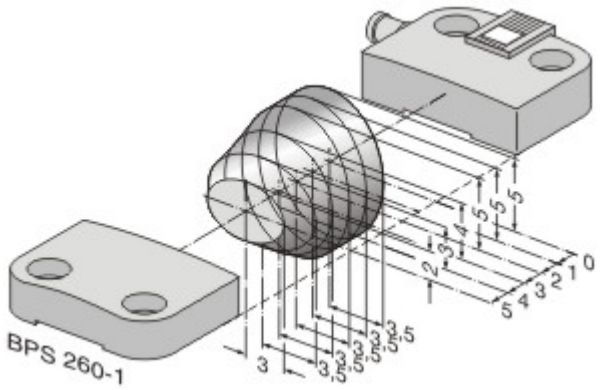

Characteristic curve

K.A. Schmersal GmbH & Co. KG, Mödinghofe 30, D-42279 Wuppertal
The data and values have been checked thoroughly. Technical modifications and errors excepted.
Generiert am 18.07.2016 - 19:06:12h Kasbase 3.2.4.F.64I