



EN Operating instructions.pages 1 to 8
Original

Content

1 About this document

1.1 Function 1

1.2 Target group: authorised qualified personnel. 1

1.3 Explanation of the symbols used 1

1.4 Appropriate use 1

1.5 General safety instructions 1

1.6 Warning about misuse 2

1.7 Exclusion of liability 2

2 Product description

2.1 Ordering code 2

2.2 Special versions. 2

2.3 Purpose 2

2.4 Technical data 2

2.5 Classification 2

3 Mounting

3.1 General mounting instructions 3

3.2 Dimensions 3

3.3 Pull wire system accessories 3

4 Electrical connection

4.1 General information for electrical connection. 4

4.2 Contact variants. 4

4.3 Indicator lamp connection 4

4.4 Accessories for cable entry 4

4.5 Installing DuplineSafe® input module 5

4.6 Accessories DuplineSafe® 5

5 Set-up and maintenance

5.1 Functional testing. 5

5.2 Maintenance 5

6 Disassembly and disposal

6.1 Disassembly. 5

6.2 Disposal 5

7 EU Declaration of conformity

1. About this document

1.1 Function

This operating instructions manual provides all the information you need for the mounting, set-up and commissioning to ensure the safe operation and disassembly of the safety switchgear. The operating instructions must be available in a legible condition and a complete version in the vicinity of the device.

1.2 Target group: authorised qualified personnel

All operations described in this operating instructions manual must be carried out by trained specialist personnel, authorised by the plant operator only.

Please make sure that you have read and understood these operating instructions and that you know all applicable legislations regarding occupational safety and accident prevention prior to installation and putting the component into operation.

The machine builder must carefully select the harmonised standards to be complied with as well as other technical specifications for the selection, mounting and integration of the components.

1.3 Explanation of the symbols used



Information, hint, note:

This symbol is used for identifying useful additional information.



Caution: Failure to comply with this warning notice could lead to failures or malfunctions.

Warning: Failure to comply with this warning notice could lead to physical injury and/or damage to the machine.

1.4 Appropriate use

The products described in these operating instructions are developed to execute safety-related functions as part of an entire plant or machine. It is the responsibility of the manufacturer of a machine or plant to ensure the correct functionality of the entire machine or plant.

The safety switchgear must be exclusively used in accordance with the versions listed below or for the applications authorised by the manufacturer. Detailed information regarding the range of applications can be found in the chapter "Product description".

1.5 General safety instructions

The user must observe the safety instructions in this operating instructions manual, the country specific installation standards as well as all prevailing safety regulations and accident prevention rules.



Further technical information can be found in the Schmersal catalogues or in the online catalogue on the Internet: www.schmersal.net.

The information contained in this operating instructions manual is provided without liability and is subject to technical modifications.

There are no residual risks, provided that the safety instructions as well as the instructions regarding mounting, commissioning, operation and maintenance are observed.

1.6 Warning about misuse



In case of improper use or manipulation of the safety switchgear, personal hazards or damages to machinery or plant components cannot be excluded.

1.7 Exclusion of liability

We shall accept no liability for damages and malfunctions resulting from defective mounting or failure to comply with this operating instructions manual. The manufacturer shall accept no liability for damages resulting from the use of unauthorised spare parts or accessories.

For safety reasons, invasive work on the device as well as arbitrary repairs, conversions and modifications to the device are strictly forbidden; the manufacturer shall accept no liability for damages resulting from such invasive work, arbitrary repairs, conversions and/or modifications to the device.

2. Product description

2.1 Ordering code

This operating instructions manual applies to the following types:

RS65①-Z22-②-③

No.	Option	Description
①	5	Grey cast iron, painted
	6	Thermosetting resin
②		without indicator lamp
	G024	Indicator lamp, red (24 V DC)
	G115	Indicator lamp, red (115 V AC)
③	G230	Indicator lamp, red (230 V AC)
		Standard version
	DS	Optionally with integrated DuplineSafe® input module



Only if the information described in this operating instructions manual are realised correctly, the safety function and therefore the compliance with the Machinery Directive is maintained.

2.2 Special versions

For special versions, which are not listed in the order code below 2.1, these specifications apply accordingly, provided that they correspond to the standard version.

2.3 Purpose

Pull-wire emergency stop switches are used wherever it must be possible to initiate the emergency stop command from any point on a machine, equipment or plant. The emergency stop command is triggered by pulling on the tensioned pull-wire.

The two-sided pull-wire emergency stop switch has pull-wire and wire-breakage monitoring. On pulling or breakage of the wire, the NC contacts are positively opened and the NO contacts are closed. Thereafter the pull-wire emergency switch can only be manually set back into an operational state. The device is suitable for harsh environmental conditions.

The version with ordering suffix -DS is equipped with a network-capable DuplineSafe® input module.

The emergency stop signal is transmitted by means of the DuplineSafe® input module via the Dupline® 2-wire installation bus to a safety relay, which safely switches off downstream devices.



After installing the DuplineSafe® input module, its technical data and safety parameters for the whole device must be observed. For details, please refer to the operating instructions of the DuplineSafe® input module in the online catalogue at www.schmersal.net.



The entire concept of the control system, in which the safety component is integrated, must be validated to the relevant standards.

2.4 Technical data

Standards:	IEC 60947-5-1, IEC 60947-5-5, ISO 13850, EN 620
Enclosure/cover:	RS655: grey cast iron, painted; RS656: thermosetting resin
Protection class:	IP66, IP67 to IEC 60529
Protection class RS655 or RS656:	I or II, <input type="checkbox"/>
Degree of pollution:	3
Contact material:	Silver
Contact type:	change-over contact with double break Zb, max. 2 NO / 2 NC contacts
Switching system:	⊖ IEC 60947-5-1 snap action, NC contacts with positive break
Connection:	Terminal block
Cable section:	0.5 mm ² ; max. 2.5 mm ² ; solid and stranded wire with conductor ferrules
Cable entry:	2 x M25
Rated impulse withstand voltage U _{imp} :	4 kV
Rated insulation voltage U _i :	300 V
Thermal test current I _{th} :	6 A
Utilisation category:	DC-13, AC-15
Rated operating current/voltage I _a /U _e :	3 A / 24 VDC 3 A / 230 VAC
Max. fuse rating:	6 A gG D-fuse
Required short-circuit current:	400 A
Actuating force:	18 N
Ambient temperature:	-40 °C to +70 °C
- with indicator lamp:	-25 °C to +60 °C
Mechanical life:	100.000 operations
Indicator lamp (optional):	LED red
	24 V DC, 115 V AC, 230 V AC
Maximum wire length:	2 x 100 m
Features:	wire pull and breakage detection

Divergent data for the Dupline® version -DS

Supply voltage:	8.2 VDC
Power consumption:	1.0 mA
Device insulation:	internal short-circuit proof
Rated impulse withstand voltage U _{imp} :	800 V
Rated insulation voltage U _i :	30 VDC
Cable section:	
- Rigid:	min. 0,2 mm ² , max. 4 mm ²
- Flexible with conductor ferrule:	min. 0,25 mm ² , max. 2,5 mm ²

2.5 Classification

Standards:	ISO 13849-1
B _{10D} (NC contact):	100,000
Mission time:	20 years

$$MTTF_D = \frac{B_{10D}}{0,1 \times n_{op}} \quad n_{op} = \frac{d_{op} \times h_{op} \times 3600 \text{ s/h}}{t_{cycle}}$$

(Determined values can vary depending on the application-specific parameters h_{op} , d_{op} and t_{cycle} as well as the load.)

If multiple safety components are wired in series, the Performance Level to ISO 13849-1 will be reduced due to the restricted error detection under certain circumstances.

3. Mounting

3.1 General mounting instructions



The installation may only be carried out with the system de-energised and by authorised personnel.

The pull-wire emergency stop switch must be fitted in the middle of the plant. Two mounting holes are available. Mount the pull-wire emergency stop switch so that the device can be unlocked and reset by hand after an emergency stop command. The pull wire must be installed according to the specifications (Fig. 1).



In accordance with IEC 60947-5-5 (EN 620), the maximum perpendicular traction force to be exercised on the wire in order to activate the emergency pull-wire switch is 200 N (125 N), the maximum deflection is 400 mm (300 mm). Sufficient space must be provided so that the required actuating deflection can be reached. It must be ensured that when tensioned, the wire rope always follows a straight course and that it remains in the correct position at all times (including at the redirection point). External influences (temperature variations, ageing) can affect the properties of the wire rope. The information in ISO 13850 must be observed.

3.2 Dimensions

All measurements in mm.

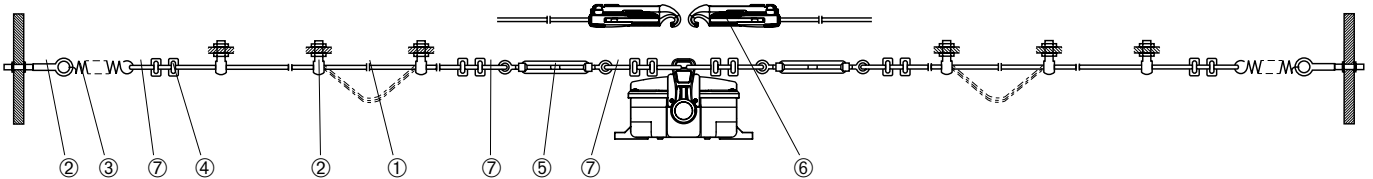
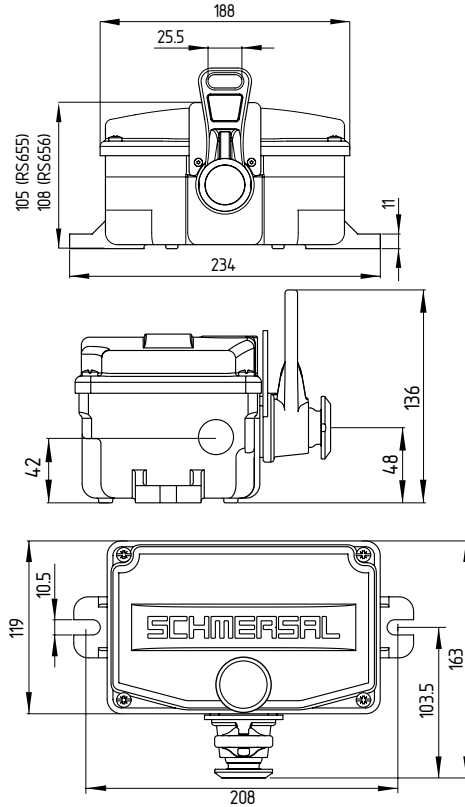

Figure 1

Equip the wire rope ① at the connection points with a thimble ⑦ and two wire clamps ④. The first wire clamp must be installed immediately behind the thimble. The PVC sheath of the pull wire must be stripped in the thimble area. Adjust the pre-tension of the springs ③ by means of the tensioning jack ⑤/ rope tensioner ⑥ so that the lever is in the middle position and the counterside triggers the emergency stop command in case of breakage of the wire rope. The tension spring contains elongation protection.



Switch travel x: max. 400 mm (300 mm to EN 620);
distance between support points L: max. 3 m

3.3 Pull wire system accessories

No.		Designation	Ordering code	Description
①	Wire rope	PWR-xM	on request	Red PVC sheath, steel core Ø 3 mm Total diameter 5 mm
②	Eyebolt (incl. nut) Anchoring hook (incl. 2 nuts and washers)	BM8X70-A2	101192471	Stainless steel,
		BM10X40	101084928	Steel, galvanised
		ACC-EBLT-M8-RVA	103031496	Stainless steel
		ACC-EBLT-M10-RVA	103031499	Stainless steel
		ACC-EBLT-M8	103031495	Galvanised steel
③	Tension spring	ACC-RS65X-TS	103032772	Galvanised steel
				Stainless steel tension spring with elongation limiter
④	Wire clamp	WIRE CLAMP 3 MM	101203477	Stainless steel
		WIRE CLAMP 5 MM	101203478	Stainless steel
⑤	Tensioning Jack	ACC-TBLE-RVA	103031494	M8 (stainless steel), 180 to 250 mm
		TENSIONER M6	101087930	M6 (steel, galvanised), 145 to 225 mm
⑥	rope tensioner	S 900	101186704	Smooth and time-saving adjustment
⑦	Wire thimble	WIRE THIMBLE 3 MM	101203472	Stainless steel
		WIRE THIMBLE 5 MM	101203476	Stainless steel

4. Electrical connection

4.1 General information for electrical connection



The electrical connection may only be carried out by authorised personnel in a de-energised condition.

Central connection terminal strip:
0.5 ... 2.5 mm²



For the cable entry, suitable cable glands with an appropriate degree of protection must be used. To protect the device against condensation caused by large temperature fluctuations, we recommend the use of a pressure compensation element. Any inlet openings not used are to be sealed with a sealing screw with suitable protection.

Once wired, fit the housing cover and tighten the screws evenly (tightening torque 3 Nm).



The series has a closed switching insert cover (see Figure 2) for the selector shaft, cams and switching contacts. The switching insert cover must be used and, in addition to the constructive cable routing, also serves as protection against dust and dirt.

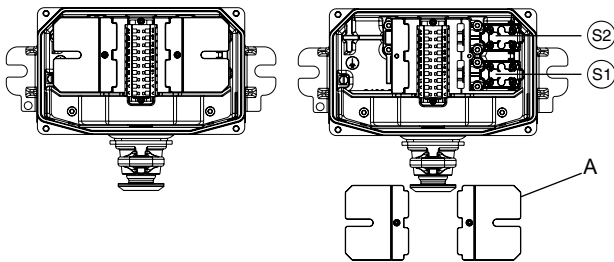

Figure 1

Figure 2

A: Switch insert covers



To prevent damage to the cable due to mechanical influences, the routing of a cable reserve in the free space under the switch insert cover is not permitted.

4.2 Contact variants

All NC contacts have positive break ⊖.

2 NO / 2 NC

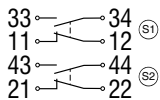

In the as-delivered condition, the two normally-closed contacts and the two normally-open contacts are positioned on one side of the central connection terminal strip. The other side of the terminal strip is for user connections.

The connection diagram for all versions with central connection terminal can be found in the cover of the switch. In addition to the switch contacts, terminals ("signal return") are also available for return of the signal lines when series-wiring is used.

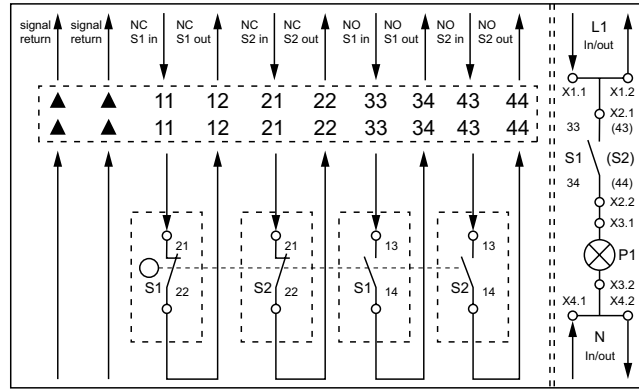

Figure 3

4.3 Indicator lamp connection

The indicator lamp must be connected to terminals X3.1 and X3.2. (see image 3). The indicator lamp is switched via the normally-open contact of switching element S1, positioned on terminals X2.1 and X2.2 (optionally via the normally-open contact of switching element S2).

The respective potential (X1/X4) can be looped to the next device via the connection on the integrated circuit board.

4.4 Accessories for cable entry

Accessories for cable entry	Ordering code	Tightening torque
Cable gland, nickel plated brass:		
ACC-CGLD-M25-MS	103006012	8 Nm
ACC-CGLD-P-M25-MS with pressure compensation element	103031489	10 Nm
Screw plug, nickel plated brass:		
ACC-BPL-M25-MS	103006010	8 Nm
Cable gland, plastic:		
ACC-CGLD-M25	103032752	10 Nm
ACC-CGLD-P-M25 with pressure compensation element	103031491	10 Nm
Screw plug, plastic:		
ACC-BPL-M25	103032753	10 Nm

4.5 Installing DuplineSafe® input module

Before the electrical installation, the DuplineSafe® input module must be addressed and parameterized according to the specifications from Dupline® (www.dupline.com). To this end, the multi-connector on the cable connector must be released and re-inserted on the connector after addressing.

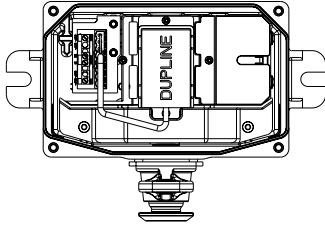

Figure 4

Connect the wires of the DuplineSafe® installation bus to the on the circuit board dedicated terminals marked with DUP+ / DUP- (tightening torque 0.6 Nm). The terminals on the opposite side marked with DUP+ / DUP- serve to connect the next Dupline® bus subscriber.

Cable Dupline®

Rigid wire: 0.2 - 4 mm²

Flexible wire: 0.25 - 2.5 mm²

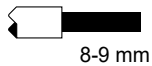

The normally-closed contact of the switch element is already prepared for the Dupline® clamp strip.

For correct operation, the installation regulations of the DuplineSafe® input module must be observed.

For supply of the DuplineSafe® input module, a channel generator as well as a DuplineSafe® safety relay are required.

4.6 Accessories DuplineSafe®

Accessories DuplineSafe®	Ordering code
DuplineSafe® configuring and testing unit GS73800080	103010115
Dupline® master channel generator SD2DUG24	103033128
DuplineSafe® safety relay GS38300143 230	103010174
Cable termination DT01	103010203

5. Set-up and maintenance

5.1 Functional testing

The safety function of the safety components must be tested.

The following conditions must be previously checked and met:

1. Check the correct fitting of the pull-wire emergency stop switch
2. Check the integrity of the cable entry and connections
3. Check the functionality of the switch by actuating the wire

5.2 Maintenance

In case of correct installation in accordance with the above-described instructions, the component requires little maintenance. For use in extreme conditions, we recommend routine maintenance including the following steps:

1. Actuate the lever to check its free movement
2. Check the correct latching after actuation of the pull-wire emergency stop switch
3. Remove particles of dust and soiling
4. Check the wire rope (and any redirection rollers) for damage and correct seating.
5. Check cable entry and connections

Damaged or defective components must be replaced.

6. Disassembly and disposal



6.1 Disassembly

The safety switchgear must be disassembled in a de-energised condition only.

6.2 Disposal

The safety switchgear must be disposed of in an appropriate manner in accordance with the national prescriptions and legislations.

7. EU Declaration of conformity

EU Declaration of conformity		
Original	SCHMERSAL Industrial Switchgear (Shanghai) Co., Ltd. Cao Ying Road 3336 201712 Shanghai / Qingpu P.R.CHINA http://www.schmersal.com.cn	
We hereby certify that the hereafter described components both in their basic design and construction conform to the applicable European Directives.		
Name of the component:	RS655 / RS656	
Type:	See ordering code	
Description of the component:	Pull-wire emergency stop switch for safety applications (optionally with integrated DuplineSafe® input model ¹⁾)	
Relevant Directives:	2006/42/EC 2014/30/EU 2011/65/EU	Machinery Directive ¹ EMC Directive RoHS-Directive
Applied standards:	EN 60947-5-1:2017 EN 60947-5-5:1997 + A1:2005 + A11:2013 + A2:2017 EN ISO 13850:2015 EN 620:2002 + A1:2010 EN ISO 13849-1:2015	
Person authorised for the compilation of the technical documentation:	Oliver Wacker Möddinghofe 30 42279 Wuppertal	
Place and date of issue:	Shanghai, July 15, 2019	
		
	Authorised signature Uwe Seeger Managing Director	

RS655-RS656-A-EN



The currently valid declaration of conformity can be downloaded from the internet at www.schmersal.net.



K.A. Schmersal GmbH & Co. KG
Möddinghofe 30, 42279 Wuppertal
Germany
Phone: +49 202 6474-0
Telefax: +49 202 6474-100
E-Mail: info@schmersal.com
Internet: www.schmersal.com

Production site:
SCHMERSAL
Industrial Switchgear (Shanghai) Co., Ltd.
Cao Ying Road 3336
201712 Shanghai / Qingpu, P.R.CHINA
Phone: +86 21 63758287
Fax: +86 21 69214398
E-Mail: info@schmersal.com.cn
Internet: www.schmersal.com.cn

施迈赛工业开关制造（上海）有限公司
地址：上海市青浦区漕盈路3336号
邮编：201712
电话：021 63758287
传真：021 69214398
网址：www.schmersal.com.cn