

Article: **FR 607**
 Description: Position switch with adjustable one-way roller

 Sheet: 15367-0-en-2.1.0
 Date: 2018/01/09
 Page: 1/3

Housing:

Polymer housing, one threaded PG 13,5 conduit entry (FR series)

General data:

 Ambient temperature: from -25°C to +80°C
 Max actuation frequency: 3600 operations cycles/hour
 Mechanical endurance: 20 million operations cycles

Contact block characteristics:

1NO+1NC slow action (B6)

Double gap and double bridge, finger-proof protection, captive screws.

Positive switch opening:

Device with positive opening conforming to IEC 60947-5-1.

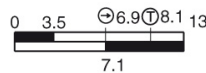
Travel diagram:

Cross section of the conductors (flexible copper wire):

 min. 1 x 0,5 mm² (1 x AWG 20)
 max. 2 x 2,5 mm² (2 x AWG 14)

- Closed contact
- Opened contact
- ⊕ Positive opening travel (IEC 60947-5-1)
- ⊖ Opening travel 2x2m (EN 81)
- R Reset device travel
- ▶ Pushing the switch
- ◀ Releasing the switch
- ⊙ Tripping mechanical point

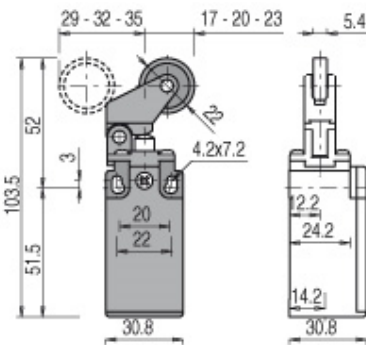
Device screw tightening torques:

 Cover screws: 0,7 ... 0,9 Nm
 Head screws: 0,5 ... 0,7 Nm
 Lever screws: 0,7 ... 0,9 Nm
 Contact blocks screws: 0,6 ... 0,8 Nm
 Plugs: 1,2 ... 1,6 Nm (M20/PG13,5)
 1 ... 1,4 Nm (M16/PG11)

In conformity with requirements requested by: Activating forces:

 Low Voltage Directive 2014/35/EU Min.: 4 N
 Electromagnetic Compatibility Directive Positive opening: 25 N
 2014/30/EU

In conformity with standards:

 IEC 60947-5-1, EN 60947-5-1, EN 60947-1, EN 50047, IEC 60204-1, EN 60204-1,
 EN ISO 14119, EN ISO 12100, IEC 60529, EN 60529, UL 508, CSA 22.2 No. 14.

Approvals:

IEC 60947-5-1, UL 508, CSA 22.2 No. 14, GB14048.5-2001.

Markings and quality marks:

Electrical data:

 Thermal current (I_{th}): 10 A
 Rated insulation voltage (U_i): 500 Vac 600 Vdc
 Rated impulse withstand voltage (U_{imp}): 6 kV
 Conditional short circuit current: 1000 A according to EN 60947-5-1
 Protection against short circuits: fuse 10 A 500 V type aM
 Pollution degree: 3

Utilization categories:

 Alternate current: AC15 (50...60 Hz)

U _e (V)	250	400	500
I _e (A)	6	4	1

 Direct current: DC13

U _e (V)	24	125	250
I _e (A)	6	1,1	0,4

Article: **FR 607**
Description: Position switch with adjustable one-way roller

Sheet: 15367-0-en-2.1.0
Date: 2018/01/09
Page: 2/3

Data type approved by IMQ.

Rated insulation voltage (Ui): 500 Vac
400 Vac (for contact blocks 2, 11, 12, 20, 21, 22, 33, 34)
Thermal current (Ith): 10 A
Protection against short circuits: fuse 10 A 500 V type aM
Rated impulse withstand voltage (Uimp): 6 kV
4 kV (for contact blocks 20, 21, 22, 33, 34)
Protection degree: IP67
MV terminals (screw clamps)
Pollution degree 3
Utilization category: AC15
Operation voltage (Ue): 400 Vac (50 Hz)
Operation current (Ie): 3 A
Forms of the contact element: Za, Zb, Za+Za, Y+Y, X+X, Y+Y+X, Y+Y+Y, Y+X+X
Positive opening of contacts on contact block 5, 6, 7, 9, 11, 13, 14, 16, 18, 20, 21, 22, 33, 34
In conformity with standards: EN 60947-1, EN 60947-5-1+ A1:2009, fundamental requirements of the Low Voltage Directive 2006/95/CE.

Data type approved by UL

Utilization categories Q300 (69 VA, 125-250 Vdc)
A600 (720 VA, 120-600 Vac)
Data of the housing type 1, 4X "indoor use only", 12, 13
For all contact blocks except 2 and 3 use 60 or 75 °C copper (Cu) conductor
and wire size No. 12-14 AWG. Terminal tightening torque of 7,1 lb in (0.8 Nm).
For contact blocks 2 and 3 use 60 or 75 °C copper (Cu) conductor and wire size No. 14 AWG. Terminal tightening torque of 12 lb in (1.4 Nm).
In conformity with standard: UL 508

Mechanical stop

In accordance with the EN ISO 14119 standard, paragraph 5.2, "the position sensors should not be used as mechanical stop".

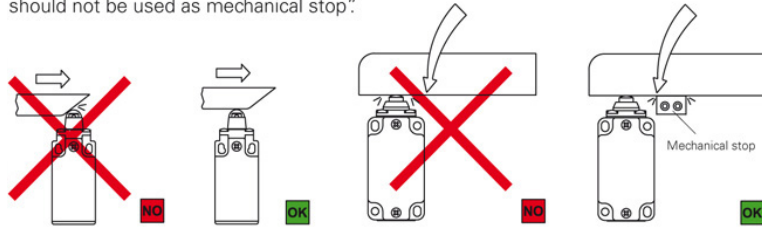

The actuator must not exceed the max. travel as indicated in the

The guard should not make a mechanical stop on the switch head.

Actuation speed

φ	Vmax (m/s)	Vmin (mm/s) L	Vmin (mm/s) R
15°	1	5	0,05
30°	0,5	2,5	0,025
45°	0,3	1,5	0,015

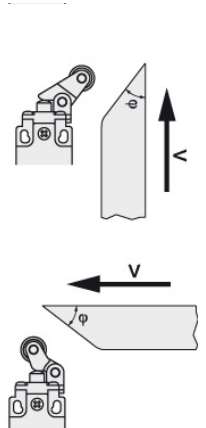

Contacts type:
R = snap action
L = slow action

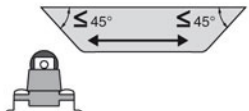
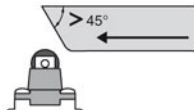
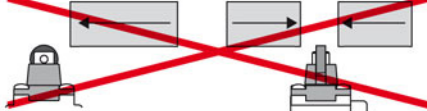

Actuation modality

Recommended application	Application to avoid	Forbidden application
	<p>Possible application but with mechanical stress for the switch higher than expected, mechanical endurance is not guaranteed</p> 	

Installation of single switches for safety applications

- Use only switches with the symbol  (see figure on the side).
- Connect the safety circuit to **the NC normally closed contacts (11-12, 21-22 or 31-32).**
- **The NO normally open contacts (13-14, 23-24, 33-34) should be used only for signalling;** these contacts are not to be connected with the safety circuit. However, if in the same protection two or more switches are used, it is possible to connect the contact NO to safety circuit. In this case at least one of the two switches must feature positive opening and a NC normally closed contacts (11-12, 21-22 or 31-32) must be connected to the safety circuit.
- **The switch must be actuated with the minimum positive opening travel** indicated in the travel diagrams with symbol .
- **The switch must be actuated with the minimum positive opening force.**
- The fixing of the device must occur in compliance with the standard EN ISO 14119.

When the machine guard has been open and during the whole opening travel, **the switch must be triggered directly** (fig. 1) **or through a rigid connection** (fig. 2).
 Only in this way the positive opening of the NC normally closed contacts (11-12, 21-22, 31-32) is guaranteed.

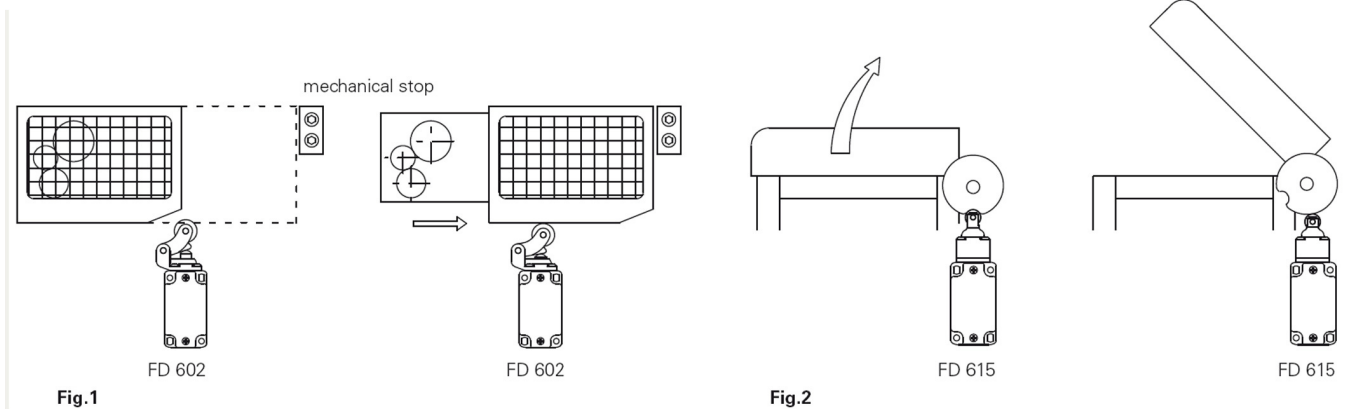

In the safety application with only one switch for each guard, the switches **should not be applied to activate by release** (fig. 3 and 4) **or through a non rigid connection** (i.e. by a spring).

