

BACK VIEW

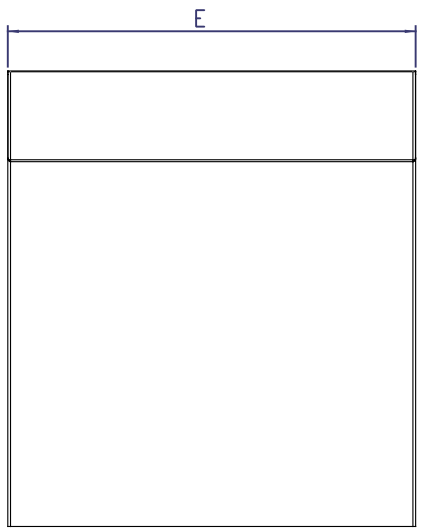

FRONT VIEW

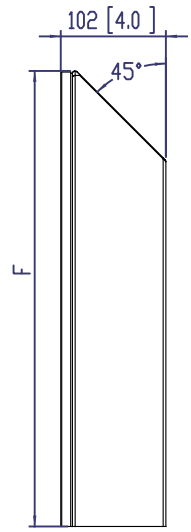

SIDE VIEW

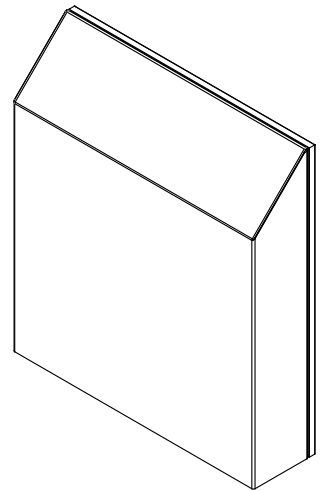





ISOMETRIC VIEW



BOTTOM VIEW

DIMENSIONAL CHART (mm)						
UNIT SIZE	A	B	C	D	E	F
PF 20000	157	151	179	129	221	265
PF 30000	214	208	236	186	276	322
PF 40000	264	258	286	236	326	372
PF 60000	328	324	354	307	394	440

ISD STANDARD REVISION LABEL ANSI STANDARD REVISION LABEL Benennung/Dimension mm (Druck)		  		Allgemeintoleranzen/ Tolerance ISD 2768-m		Mastab/ Scale 1:5		Tele-Nr. Part-No.		
Datum/Date			Name/Name			Benennung/Description PF Rain Hood General Dimensions				
Bearbeiter / Drawn by										
Geprüft / Checked by										
Geändert / Modified by										
Zust./ state		Änderung/change No.		Datum/date		Name		Urspr./source		
 							Ersf./substituted f:		Ersd./replaced by:	
<small>Schutzvermerk nach DIN 34 und ISO/BS 5466 "Hilfsrechte und Verwertungsrechte dieses Dokuments, Vervielfältigung und Verbreitung seines Inhalts sind verboten, soweit nicht ausdrücklich gestattet. Zuwiderhandlungen verpflichten zu Schadenersatz. Alle Rechte für den Fall der Patent-, Gebrauchsmuster- oder Geschmuckmustererhaltung vorbehalten."</small>							<small>Copyright reserved of DIN 34 and ISO/BS 5466 "The copying, distribution and utilization of this document as well as the communication for its contents to others without expressed authorization is prohibited. Offenders will be held liable for the payment of damages. All rights reserved in the event of the grant of a patent, utility model or ornamental design registration."</small>			

01-
REVISION
DIN A3
1 / 1
Blatt/Sheet
page/pages