

Female cordset

V11-W-BK2M-PVC-U



- Degree of protection IP68 / IP69
- UL listed for USA and Canada
- Specific design protects against loosening and inaccurate installation

Female cordset single-ended M12 angled A-coded, 3-pin, PVC cable black, UL approved



Dimensions

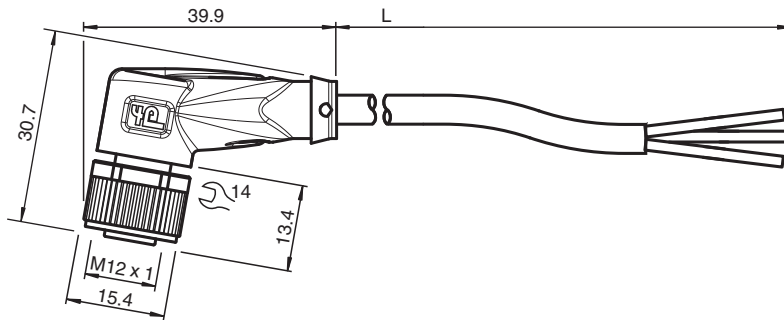

Technical Data

General specifications			
Connector 1			
Connection			socket
Construction type			M12
Style			angled
Locking			screw connection
Number of pins			3
Coding			A-coded
Connector 2			
Connection			cable end
Electrical specifications			
Operating voltage	U_B		max. 250 V AC/DC
Operating current	I_B		max. 4 A
Conformity			
Degree of protection			EN 60529
Plug connection			connector M12 x 1 : IEC 61076-2-101
Flammability			UL 1581 , IEC 60332-1-2

Release date: 2022-11-28 Date of issue: 2022-11-29 Filename: 239999-0023_eng.pdf

Refer to "General Notes Relating to Pepperl+Fuchs Product Information".

Pepperl+Fuchs Group
www.pepperl-fuchs.com

USA: +1 330 486 0001
fa-info@us.pepperl-fuchs.com

Germany: +49 621 776 1111
fa-info@de.pepperl-fuchs.com

Singapore: +65 6779 9091
fa-info@sg.pepperl-fuchs.com

PEPPERL+FUCHS

Technical Data

Approvals and certificates

UL approval	AWM STYLE 2095 AWM I/II A/B 80°C 300V FT1 (cable)
UL File Number	E231213

Ambient conditions

Ambient temperature	
Plug connector	-40 ... 90 °C (-40 ... 194 °F)
Cable, fixed	-25 ... 80 °C (-13 ... 176 °F)
Cable, flexing	-5 ... 80 °C (23 ... 176 °F)
Pollution degree	3

Mechanical specifications

Plug connector	
Tightening torque	0.6 Nm
Loosening protection	available
Tool installation	straight knurling and hexagon nut SW = 14 mm
Mating cycles	min. 100
Degree of protection	IP68 / IP69
Cable	
according to IEC/EN 60228 (DIN VDE 0295) class 5	
Sheath diameter	4.3 mm
Bending radius	> 15 x cable diameter, moving > 5 x cable diameter, fixed
Sheath stripping force	max. 50 N / 300 mm
Sheath color	black (similar to RAL 9005)
Number of cores	3
Core cross section	0.34 mm ²
Cores color	Core 1: brown Core 3: blue Core 4: black
Core construction	19 x 0.15 mm Ø
Length	L 2 m
Cable code	Li YY 3 x 0,34

Material





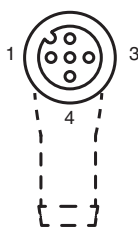

Plug connector	
Screw connection	Zinc diecast, nickel-plated
Body	TPU, black
Seal	FKM
Contact surface	gold plated (Au)
Flammability	V-2
Cable	
Sheathing	PVC
Core insulation	PVC
Flammability	FT1

Connection Assignment



1	-----	BN
3	-----	BU
4	-----	BK

Accessories

	MH V1-SCREWDRIVER	Torque screwdriver (0.6 Nm)
	MH V1-BIT M12	plug-in cap M12
	V1/V3-LABELHOLDER	Label holder
	V1/V3-LABEL	Label plate
	MH V1-Holder	Modular universal holder for M12 connectors
	V1-CLIP	Unlocking protector for M12 connector
	V1-MARKING-RING-COLOR	Marking rings for M12 connectors, various colors