



## IO-Link master (PNIO/MOD)

### ICE3-8IOL-K45P-RJ45

- Web-based configuration of module and IO-Link devices
- Integrated IODD storage for more than 100 IODDs
- Downloadable module configuration
- PROFINET IO, Modbus/TCP and OPC UA Support
- Pluggable push-in connectors

PROFINET IO IO-Link master with 8 inputs/outputs, DIN rail, push-in terminals

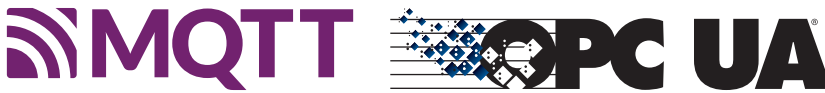

### Function

The module is a PROFINET IO fieldbus module with 8 type A IO-Link master ports according to IO-Link standard V1.1. The module serves as an interface between the controller of a PROFINET IO fieldbus system and IO-Link devices in the field level. The integrated web server and IODD interpreter enabling complete configuration of the fieldbus module and attached IO-Link devices without the need for special software tools. Information regarding the status of the module is also displayed and network parameters such as the IP address and subnet mask can be configured. The module is capable of storing all configuration enabling stand-alone usage without a higher-level PLC. MultiLink simultaneously provides data access via different communication protocols like PROFINET IO, Modbus/TCP and OPC UA to multiple controllers. A pluggable, push-in connector supplies power enabling a current rating of up to 3.7 A. The inputs and outputs are equipped with pluggable, push-in connectors. Connection to the fieldbus is achieved using a standard RJ45 Ethernet connector. Status information for each channel is displayed via LEDs as a diagnostic function.

### Dimensions

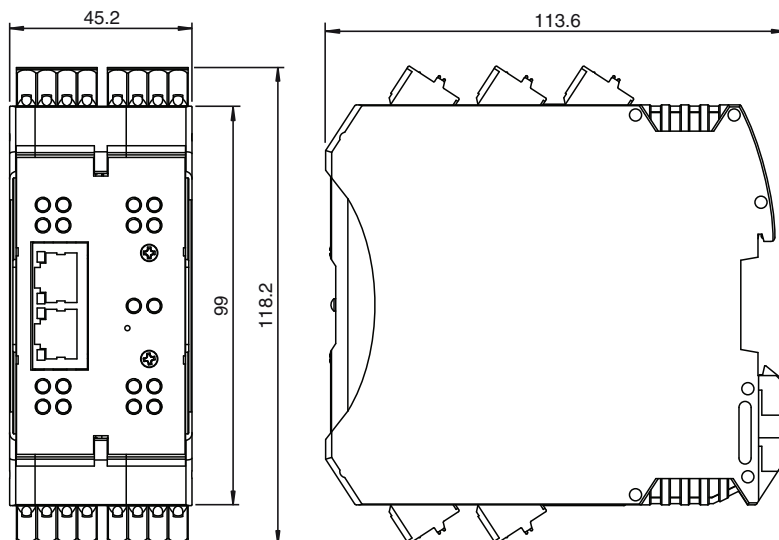

Release date: 2023-06-05 Date of issue: 2023-06-05 Filename: 70108832\_eng.pdf

Refer to "General Notes Relating to Pepperl+Fuchs Product Information".

Pepperl+Fuchs Group  
www.pepperl-fuchs.com

USA: +1 330 486 0001  
fa-info@us.pepperl-fuchs.com

Germany: +49 621 776 1111  
fa-info@de.pepperl-fuchs.com

Singapore: +65 6779 9091  
fa-info@sg.pepperl-fuchs.com

**PEPPERL+FUCHS**

## Technical Data

<b>General specifications</b>		
UL File Number		E360395
<b>Indicators/operating means</b>		
LED indication		see manual
<b>Electrical specifications</b>		
Rated operating voltage	$U_e$	18 ... 30 V DC
General information		Redundant power
Nominal voltage		24 V DC
Nominal current		3.7 A
Current consumption		typ. 155 mA
Current loading capacity		Total current 3.2 A per module
<b>Interface 1</b>		
Interface type		Industrial Ethernet
Physical		RJ45
Protocol		PROFINET IO with media redundancy protocol (MRP) + Modbus TCP + OPC UA + MQTT Modbus max PDI: 33 times / sec OPC UA max PDI update rate: 20 times / sec MQTT max PDI update rate: 10 times / sec
Transfer rate		10/100 Mbps
<b>Inputs/Outputs</b>		
Number/Type		8 x IO-Link Class A (X1 – X8) Configurable as: Max. 8 IO-Link and 8 digital inputs Max. 16 digital inputs Max. 8 digital inputs and 8 digital outputs short-circuit protected
Sensor supply		max. 200 mA per port via L+ (pin 1)
Output rated operating current	$I_e$	max. 200 mA per port Via C/Q (pin 4)
<b>Directive conformity</b>		
Electromagnetic compatibility		
Directive 2014/30/EU		EN 61000-6-2 , EN 61000-6-4
<b>Standard conformity</b>		
Degree of protection		EN 60529
Fieldbus standard		Type 1 according to IEC 61131-2, EN 61131-9
Electrical safety		CSA C22.2 No. 61010-1-12 / CSA C22.2 No. 61010-1-201 UL 61010-1 / UL 61010-1-201
Emitted interference		EN 61000-6-4, FCC Part 15 Subpart B, ICES-001, AS/NZS CISPR 11
Noise immunity		EN 61000-6-2 , EN 61131-2 , EN 61131-9
Shock resistance		EN 60068-2-27
<b>Ambient conditions</b>		
Ambient temperature		-40 ... 70 °C (-40 ... 158 °F)
Storage temperature		-40 ... 70 °C (-40 ... 158 °F)
Relative humidity		max. 95 %
Altitude		0 ... 2000 m
Shock and impact resistance		15g, 11ms, half-sine
Vibration resistance		5-8Hz, 3.5mm displacement, 8.4-150Hz, 1.0g acceleration
<b>Mechanical specifications</b>		
Housing length		113.6 mm
Housing width		45.2 mm
Housing height		118.2 mm
Degree of protection		IP20
Connection		Power Supply push-in connector Fieldbus RJ45 Inputs/Outputs push-in connectors
<b>Material</b>		
Housing		Polyamide, UL94V-0

Release date: 2023-06-05 Date of issue: 2023-06-05 Filename: 70108832\_eng.pdf

Refer to "General Notes Relating to Pepperl+Fuchs Product Information".

Pepperl+Fuchs Group  
www.pepperl-fuchs.comUSA: +1 330 486 0001  
fa-info@us.pepperl-fuchs.comGermany: +49 621 776 1111  
fa-info@de.pepperl-fuchs.comSingapore: +65 6779 9091  
fa-info@sg.pepperl-fuchs.com

**PEPPERL+FUCHS**

## Technical Data

Mass	250 g
Construction type	Cabinet module
Mounting	DIN mounting rail

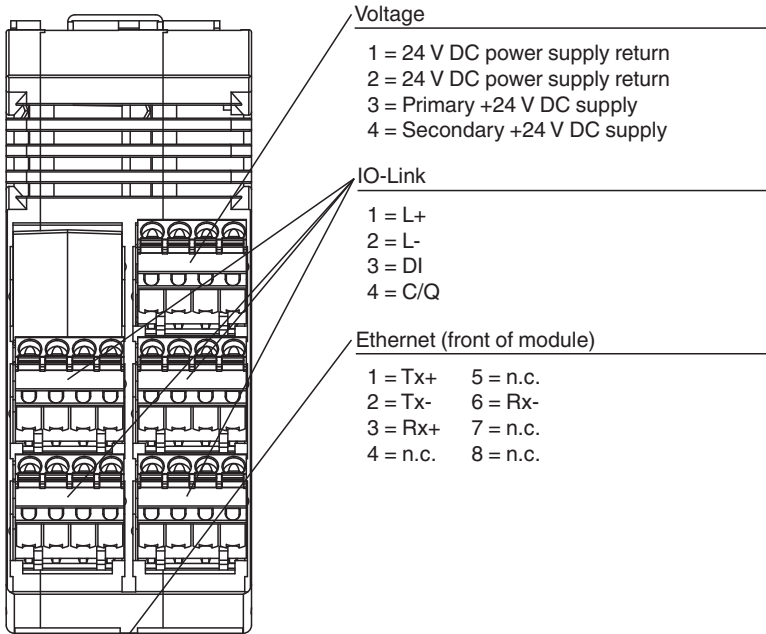

## Connection

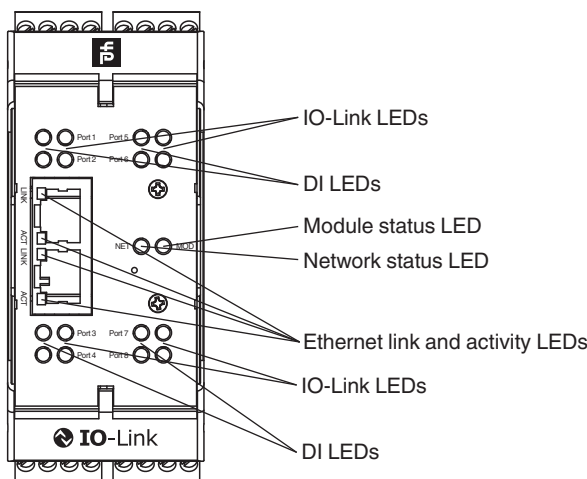

## Assembly



## Accessories

	<b>V1-G-2M-PUR</b>	Female cordset single-ended M12 straight A-coded, 4-pin, PUR cable grey
	<b>V1-G-2M-PVC</b>	Female cordset single-ended M12 straight A-coded, 4-pin, PVC cable grey

Release date: 2023-06-05 Date of issue: 2023-06-05 Filename: 70108832\_eng.pdf

Refer to "General Notes Relating to Pepperl+Fuchs Product Information".















Pepperl+Fuchs Group  
www.pepperl-fuchs.com

USA: +1 330 486 0001  
fa-info@us.pepperl-fuchs.com

Germany: +49 621 776 1111  
fa-info@de.pepperl-fuchs.com

Singapore: +65 6779 9091  
fa-info@sg.pepperl-fuchs.com

## Accessories

	<b>V1-W-2M-PUR</b>	Female cordset single-ended M12 angled A-coded, 4-pin, PUR cable grey
	<b>V1-W-2M-PVC</b>	Female cordset, M12, 4-pin, PVC cable
	<b>V31-WM-2M-PUR</b>	Female cordset single-ended M8 angled A-coded, 4-pin, PUR cable grey
	<b>V31-GM-2M-PUR</b>	Female cordset single-ended M8 straight A-coded, 4-pin, PUR cable grey
	<b>V31-GM-2M-PVC</b>	Female cordset single-ended M8 straight A-coded, 4-pin, PVC cable grey
	<b>V31-WM-2M-PVC</b>	Female cordset single-ended M8 angled A-coded, 4-pin, PVC cable grey
	<b>V45-G-C5-GN1M-PUR-E1S-V45-G</b>	Ethernet bus cable RJ45 to RJ45 PROFINET-coded, 4-pin, PUR cable green, Cat5e, shielded, UL approved, drag chain suitable
	<b>V45-G-C5-GN1M-PUR-E1S</b>	Ethernet bus cable male cordset single-ended RJ45, 4-pin, PUR cable green, Cat5e, shielded, UL approved, drag chain suitable
	<b>V1SD-G-GN2M-PUR-E1S-V45-G</b>	Ethernet bus cable M12 plug straight D-coded to RJ45 Ethernet-coded, 4-pin, PUR cable green, Cat5e, shielded, drag chain suitable
	<b>ICA-16DI-G60A-IO</b>	I/O hub with IO-Link interface for 16 digital inputs
	<b>ICA-10DI6DO-G60A-IO</b>	I/O hub with IO-Link interface for 10 digital inputs and 6 digital outputs
	<b>ICA-16DIO-G60AL-IO</b>	I/O hub with IO-Link interface for 16 digital inputs/outputs
	<b>ICA-8DIO-CB10-IO</b>	I/O hub with IO-Link interface
	<b>ICA-AI-I/U-IO-V1</b>	IO-Link converter with analog input (current/voltage)
	<b>ICA-AO-I/U-IO-V1</b>	IO-Link converter with analog output (current/voltage)