



IO-Link master (EIP/MOD) ICE2-8IOL-K45S-RJ45

- Web-based configuration of module and IO-Link devices
- Integrated IODD storage for more than 100 IODDs
- Downloadable module configuration
- Screw terminal power connector
- EtherNet/IP, Modbus/TCP and OPC UA support

EtherNet/IP IO-Link master with 8 inputs/outputs, DIN rail, screw terminal



Function

The module is an EtherNet/IP fieldbus module with 8 type A IO-Link master ports according to the IO-Link standard V1.1. The fieldbus module serves as an interface between the controller of a EtherNet/IP fieldbus system and IO-Link devices at the field level. The integrated web server and IODD interpreter enables complete configuration of the fieldbus module and attached IO-Link devices without the need for special software tools. Information regarding the status of the module is also displayed and network parameters such as the IP address and subnet mask can be configured. The module is capable of storing all configuration enabling stand-alone usage without a higher-level PLC. MultiLink simultaneously provides data access via different communication protocols like EtherNet/IP, Modbus/TCP and OPC UA to multiple controllers. A screw terminal connector is used for supplying power that enables a current rating of up to 3.7 A. The inputs and outputs are equipped with screw terminal connectors. Connection to the fieldbus is achieved using a standard RJ45 Ethernet connector. Status information for each channel is displayed via LEDs as a diagnostic function.

Dimensions

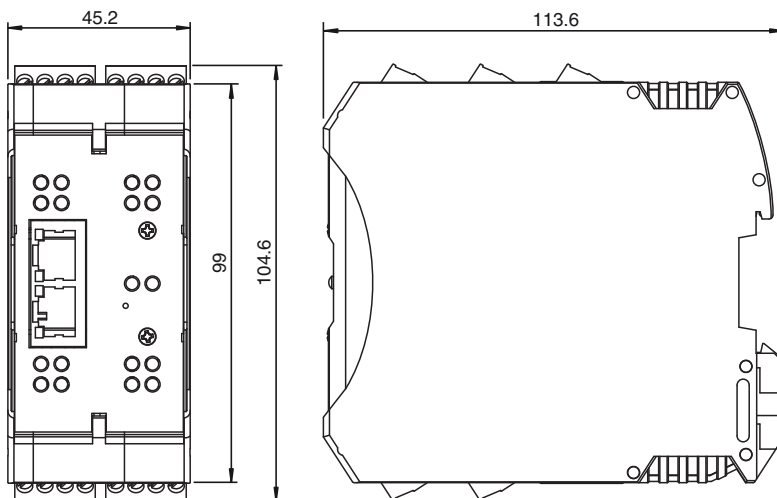

Release date: 2022-10-19 Date of issue: 2022-10-19 Filename: 70104879_eng.pdf

Refer to "General Notes Relating to Pepperl+Fuchs Product Information".

Pepperl+Fuchs Group
www.pepperl-fuchs.com

USA: +1 330 486 0001
fa-info@us.pepperl-fuchs.com

Germany: +49 621 776 1111
fa-info@de.pepperl-fuchs.com

Singapore: +65 6779 9091
fa-info@sg.pepperl-fuchs.com

PF PEPPERL+FUCHS

Technical Data

General specifications		
UL File Number		E360395
Indicators/operating means		
LED indication		see manual
Electrical specifications		
Rated operating voltage	U_e	18 ... 30 V DC
General information		Redundant power
Nominal voltage		24 V DC
Nominal current		3.7 A
Current consumption		typ. 155 mA
Current loading capacity		Total current 3.2 A per module
Interface 1		
Interface type		Industrial Ethernet
Physical		RJ45
Protocol		EtherNet/IP + Modbus TCP + OPC UA + MQTT Modbus max PDI: 33 times / sec OPC UA max PDI update rate: 20 times / sec MQTT max PDI update rate: 10 times / sec
Transfer rate		10/100 Mbps
Inputs/Outputs		
Number/Type		8 x IO-Link Class A (X1 – X8) Configurable as: Max. 8 IO-Link and 8 digital inputs Max. 16 digital inputs Max. 8 digital inputs and 8 digital outputs short-circuit protected
Sensor supply		max. 200 mA Per port Via L+ (pin 1)
Output rated operating current	I_e	max. 200 mA Per port Via C/Q (pin 4)
Directive conformity		
Electromagnetic compatibility		
Directive 2014/30/EU		EN 61000-6-2 , EN 61000-6-4
Standard conformity		
Degree of protection		EN 60529
Fieldbus standard		Type 1 according to IEC 61131-2, EN 61131-9
Electrical safety		CSA C22.2 No. 61010-1-12 / CSA C22.2 No. 61010-1-201 UL 61010-1 / UL 61010-1-201
Emitted interference		EN 61000-6-4, FCC Part 15 Subpart B, ICES-001, AS/NZS CISPR 11
Noise immunity		EN 61000-6-2 , EN 61131-2 , EN 61131-9
Shock resistance		EN 60068-2-27
Ambient conditions		
Ambient temperature		-40 ... 70 °C (-40 ... 158 °F)
Storage temperature		-40 ... 70 °C (-40 ... 158 °F)
Relative humidity		max. 95 %
Altitude		0 ... 2000 m
Shock and impact resistance		15g, 11ms, half-sine
Vibration resistance		5-8Hz, 3.5mm displacement, 8.4-150Hz, 1.0g acceleration
Mechanical specifications		
Housing length		113.6 mm
Housing width		45.2 mm
Housing height		104.6 mm
Degree of protection		IP20
Connection		Power Supply screw terminal Fieldbus RJ45 Inputs/Outputs screw terminal
Material		
Housing		Polyamide, UL94V-0
Mass		272 g

Release date: 2022-10-19 Date of issue: 2022-10-19 Filename: 70104879_eng.pdf

Refer to "General Notes Relating to Pepperl+Fuchs Product Information".

 Pepperl+Fuchs Group
www.pepperl-fuchs.com

 USA: +1 330 486 0001
fa-info@us.pepperl-fuchs.com

 Germany: +49 621 776 1111
fa-info@de.pepperl-fuchs.com

 Singapore: +65 6779 9091
fa-info@sg.pepperl-fuchs.com

 **PEPPERL+FUCHS**

Technical Data

Construction type	Cabinet module
Mounting	DIN mounting rail

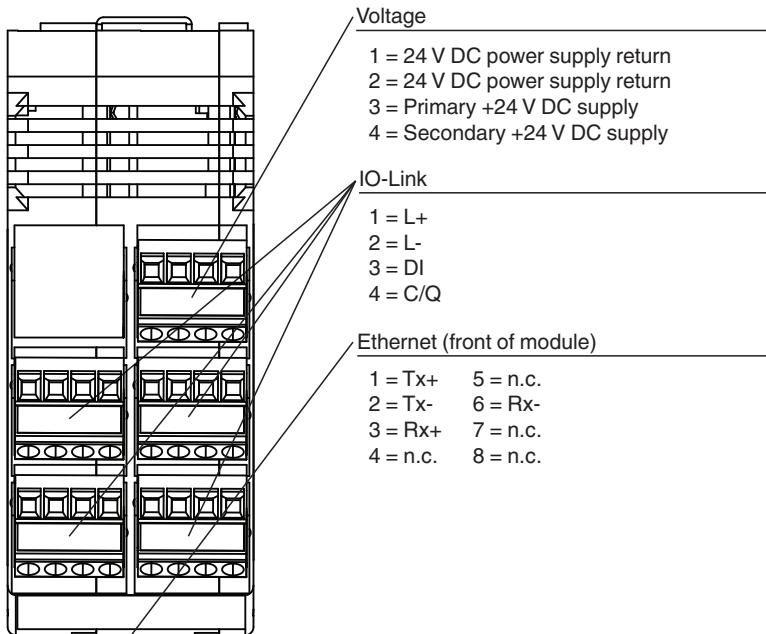

Connection

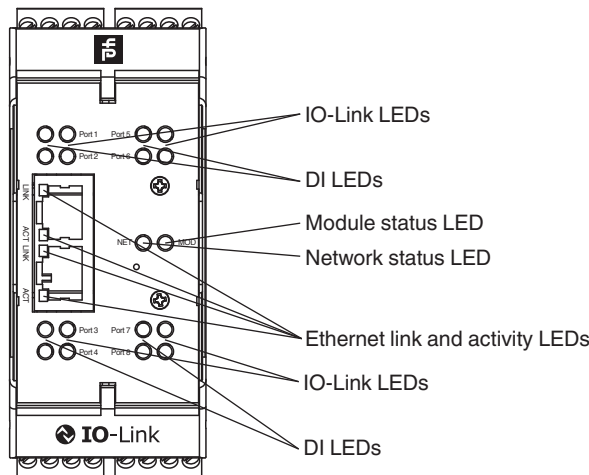

Assembly

















Accessories

	V1-G-2M-PUR	Female cordset single-ended M12 straight A-coded, 4-pin, PUR cable grey
	V1-G-2M-PVC	Female cordset single-ended M12 straight A-coded, 4-pin, PVC cable grey

Release date: 2022-10-19 Date of issue: 2022-10-19 Filename: 70104879_eng.pdf

Accessories

	V1-W-2M-PUR	Female cordset single-ended M12 angled A-coded, 4-pin, PUR cable grey
	V1-W-2M-PVC	Female cordset, M12, 4-pin, PVC cable
	V31-WM-2M-PUR	Female cordset single-ended M8 angled A-coded, 4-pin, PUR cable grey
	V31-GM-2M-PUR	Female cordset single-ended M8 straight A-coded, 4-pin, PUR cable grey
	V31-GM-2M-PVC	Female cordset single-ended M8 straight A-coded, 4-pin, PVC cable grey
	V31-WM-2M-PVC	Female cordset single-ended M8 angled A-coded, 4-pin, PVC cable grey
	V45-G-C5-GN1M-PUR-E1S-V45-G	Ethernet bus cable RJ45 to RJ45 PROFINET-coded, 4-pin, PUR cable green, Cat5e, shielded, UL approved, drag chain suitable
	V45-G-C5-GN1M-PUR-E1S	Ethernet bus cable male cordset single-ended RJ45, 4-pin, PUR cable green, Cat5e, shielded, UL approved, drag chain suitable
	V1SD-G-GN2M-PUR-E1S-V45-G	Ethernet bus cable M12 plug straight D-coded to RJ45 Ethernet-coded, 4-pin, PUR cable green, Cat5e, shielded, drag chain suitable
	ICA-16DI-G60A-IO	I/O hub with IO-Link interface for 16 digital inputs
	ICA-10DI6DO-G60A-IO	I/O hub with IO-Link interface for 10 digital inputs and 6 digital outputs
	ICA-16DIO-G60AL-IO	I/O hub with IO-Link interface for 16 digital inputs/outputs
	ICA-8DIO-CB10-IO	I/O hub with IO-Link interface
	ICA-AI-I/U-IO-V1	IO-Link converter with analog input (current/voltage)
	ICA-AO-I/U-IO-V1	IO-Link converter with analog output (current/voltage)

Release date: 2022-10-19 Date of issue: 2022-10-19 Filename: 70104879_eng.pdf

Refer to "General Notes Relating to Pepperl+Fuchs Product Information".

Pepperl+Fuchs Group
www.pepperl-fuchs.comUSA: +1 330 486 0001
fa-info@us.pepperl-fuchs.comGermany: +49 621 776 1111
fa-info@de.pepperl-fuchs.comSingapore: +65 6779 9091
fa-info@sg.pepperl-fuchs.com PEPPERL+FUCHS