

Transmitter

TYPE WDT-4LR-Z2

TYPE WDT-5LR-Z2

TYPE WDT-6LR-Z2

WD-PRO Receiver

TYPE WDR-L-Z2-PRO(-L)

TYPE WDR-LE-Z2-PRO(-L)

Instruction Manual [Web Version]

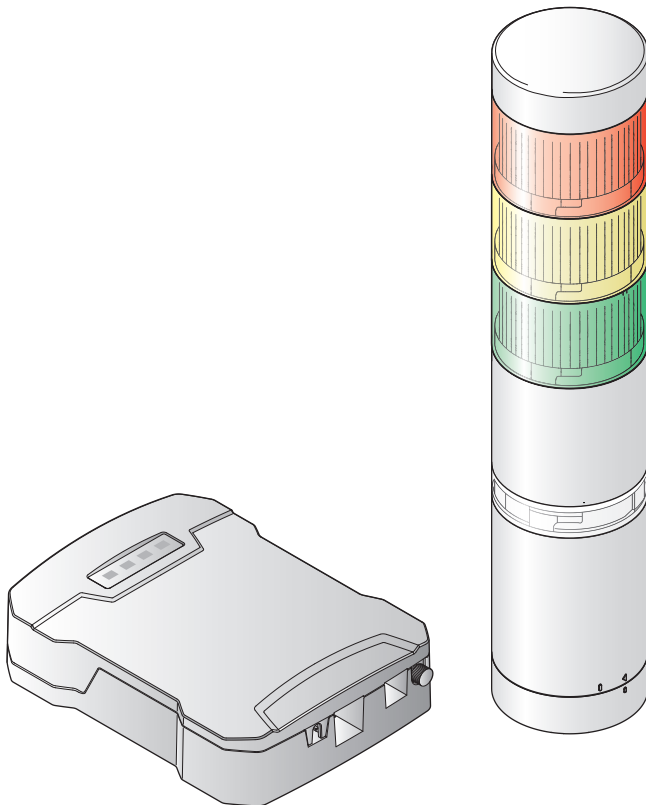

Notice to Customer

Thank for your purchasing our PATLITE products.

- The WDT-4LR-Z2, WDT-5LR-Z2 and WDT-6LR-Z2 transmitters are used exclusively with LR4/LR5/LR6 signal towers.
- Before using the WDR-L-Z2-PRO or WDR-LE-Z2-PRO, update to the latest version of the firmware. You can download the latest version of the firmware from the customer registration page.
- When using the system operation software WDS-WIN01, use version 1.04 or later.
- Request the installation and wiring be performed by a professional contractor if construction work is involved.
- Prior to installation, read this manual thoroughly before using this product to ensure correct use.
- In addition, please store this manual for future reference when performing maintenance, repairs or inspections. If there are any questions concerning this product, refer to the contact information at the end of this document and contact your nearest PATLITE Sales Representative.
- This manual describes functions supported in version 1.03 of the WDR-L-Z2-PRO and WDR-LE-Z2-PRO. Depending on the version you are using, some functions may not be available or the screen layout may differ from that shown in this manual.
- For the WDT-6LR-Z2-PRO and WDB-D80S-PRO, refer to "WDB-D80S-PRO/WDT-6LR-Z2-PRO Instruction Manual."
- For the WDT-5E-Z2 and WDT-6M-Z2, refer to "Instruction Manual [TYPE: WD-Z2]."

To the Contractor

- Prior to installation, read this manual thoroughly to ensure it is installed correctly.
- Return this manual to the customer.

1. Before you begin **7**

2. Contents **16**

3. Models **17**

4. Part Names and Dimensions **20**

5. Product Overview **22**

6. Before Use **34**

7. WDR Setup Process **49**

8. Operation **86**

9. Function Details **111**

10. Troubleshooting **123**

11. Specifications **125**

12. Replacement and Optional Parts **129**

13. Free Software License Agreement **130**

Table of Contents

- 1. Before you begin..... 7**
 - 1.1. About Safety Symbols 7
 - 1.2. Safety Precautions 8
 - 1.3. About laws and regulations in each country11
 - 1.4. Trademarks 15
- 2. Contents 16**
 - 2.1. About the Contents 16
 - 2.1.1. WDT-4LR-Z2/WDT-5LR-Z2/WDT-6LR-Z2 16
 - 2.1.2. WDR-L-Z2-PRO(-L)/WDR-LE-Z2-PRO(-L) 16
- 3. Models 17**
 - 3.1. About Models 17
 - 3.1.1. WDT (Transmitter) 17
 - 3.1.2. WDR (Receiver) 18
- 4. Part Names and Dimensions 20**
 - 4.1. About Part Names and Dimensions 20
 - 4.1.1. WDT (Transmitter) 20
 - 4.1.2. WDR (Receiver) 21
- 5. Product Overview 22**
 - 5.1. About the WD System 22
 - 5.2. System Configuration 22
 - 5.2.1. Glossary 22
 - 5.2.2. WD System Configuration at Run Time 23
 - 5.2.2.1. System Configuration Example for CSV File 23
 - 5.2.2.2. Socket Communication System Configuration Example 24
 - 5.2.2.3. Example Database Communication System Configuration 25
 - 5.2.2.4. Example Modbus/TCP Communication System Configuration 26
 - 5.2.2.5. Example System Configuration for Cloud Communication 27
 - 5.2.3. Example System Configuration When Setting Up Equipment (using the Setup Kit) 28
 - 5.3. About Application Software 29
 - 5.3.1. Pattern 1: CSV File 29
 - 5.3.2. Pattern 2: Socket Communication 29
 - 5.3.3. Pattern 3: Database Communication 30
 - 5.3.4. Pattern 4: Modbus/TCP Communication 30
 - 5.3.5. Pattern 5: Cloud Communication 30

5.4. Function List	31
5.4.1. WDT (Transmitter)	31
5.4.1.1. Wireless Data Transmission Function	31
5.4.1.2. Signal Wire Input Functions	31
5.4.2. WDR (Receiver)	32
5.4.2.1. Host Communication Function	32
5.4.2.2. Setting and Maintenance Functions	33
6. Before Use	34
6.1. WD System Basic Information	34
6.1.1. About the WD Wireless Network	34
6.1.2. About Selecting a Wireless Channel	34
6.1.3. About Grouping and ExtendedPanID	35
6.1.4. About the MAC Address (IEEE Address)	36
6.1.5. How many WDT you can connect to WDR	36
6.1.6. About Maintain Signal Tower Status	36
6.2. About the Installation Environment	37
6.2.1. Installation Environment Main Points	37
6.2.2. Distance Between Devices	37
6.2.3. About the Influence of Surrounding Radio Waves	38
6.2.4. Ensuring Line of Sight	39
6.2.5. WDR Installation Position and Obstacles	39
6.2.6. About the Signal Tower Power Supply Status	39
6.3. Installation Steps	40
6.3.1. Setup Information	40
6.3.2. Equipment Settings	43
6.3.2.1. Set Up WDT	43
6.3.2.2. Set Up WDR	44
6.3.3. Installation Steps	45
6.3.3.1. WDT Installation	45
6.3.3.2. WDR Installation	45
6.3.3.3. Check WDT and WDR Connection	46
6.3.3.4. Using WDS-WIN01 with CSV File	46
6.3.4. Maintenance	47
6.3.5. Replace WDR-L(E)-Z2	47
6.3.5.1. Set Up WDR	47
6.3.5.2. WDR Installation	48
6.3.5.3. Check WDT and WDR Connection	48

7. WDR Setup Process	49
7.1. Set Up the User Name and Password for the WDR's Web Setup Screen	49
7.2. Display WDR Web Setup Screen	51
7.3. WDR (Receiver) Web Setup Screen	53
7.4. WDR (Receiver) Various Settings	56
7.4.1. Setup Items	56
7.4.2. System Settings	58
7.4.2.1. Network Setup	58
7.4.2.2. Clock Settings	59
7.4.2.3. User Authentication Settings	62
7.4.2.4. Security Settings	63
7.4.3. Host Communication Settings	64
7.4.3.1. Socket Communication Settings	64
7.4.3.2. Database Communication Setting	66
7.4.3.3. Modbus/TCP Communication Settings	68
7.4.3.4. Cloud Communication Settings	69
7.4.4. WD Wireless Settings	72
7.4.4.1. Receiver Wireless Settings	72
7.4.4.2. Wireless Settings List	73
7.4.4.3. Wireless Connection Diagnosis	76
7.4.4.4. Status Check	78
7.4.4.5. Register Transmitter User Name	79
7.4.5. Administration	81
7.4.5.1. Main Unit Information	81
7.4.5.2. Update Firmware	82
7.4.5.3. Initialize	83
7.4.5.4. Reboot	85
8. Operation	86
8.1. How to Use the WDT	86
8.1.1. WDR Wiring Method	86
8.1.2. Attaching and Detaching the WDT	87
8.1.2.1. Installing to and Removing from LR Series Signal Tower	88
8.1.2.2. Attaching the LED Unit and Buzzer Unit	90
8.1.3. Setting up the WDT Main Unit	91
8.1.3.1. Setup Process	91
8.1.3.2. Setup Items	91
8.1.3.3. Required Equipment.....	92

8.1.4. WDT DIP Switch Operations	93
8.1.5. Checking Operations with WDT-PRO Indicator	94
8.1.6. Initializing the WDT	95
8.2. How to Use the WDR	96
8.2.1. WDR Mounting Method	96
8.2.2. WDR Wiring Method	98
8.2.2.1. USB Cable Wiring Method	98
8.2.2.2. LAN Cable Wiring Method	99
8.2.2.3. Power Supply Wiring Method	99
8.2.3. Setting up the WDR Main Unit	101
8.2.3.1. Setup Process	101
8.2.3.2. Setup Items	101
8.2.3.3. Required Equipment.....	103
8.2.4. WDR DIP Switch Operations.....	104
8.2.5. Checking the WDR Status Lamp	105
8.2.6. Initializing the WDR.....	107
8.2.7. Rebooting WDR	110
9. Function Details	111
9.1. WDT Functions	111
9.1.1. Wireless Data Transmission Function	111
9.1.1.1. Transmit Signal Tower Information.....	111
9.1.1.2. Select Format of Signal Tower Information	111
9.1.1.3. About Periodic Transmissions.....	112
9.1.1.4. Mesh Network Transmission	112
9.1.1.5. Simple Counter Function	113
9.1.2. Signal Tower Input Functions.....	114
9.1.2.1. Determine Signal Tower Input.....	114
9.2. WDR Functions	117
9.2.1. Host Communication Function	117
9.2.1.1. Socket Communication	117
9.2.1.2. Database Communication	118
9.2.1.3. Modbus/TCP Communication.....	119
9.2.1.4. USB Communication	119
9.2.1.5. Cloud Communication	120
9.2.2. Self Diagnosis Function	121
10. Troubleshooting	123
10.1. Troubleshooting	123



10.1.1. WDT (Transmitter).....	123
10.1.2. WDR (Receiver).....	124
11. Specifications	125
11.1. WDT (Transmitter)	125
11.2. WDR (Receiver)	126
11.2.1. General Specifications	126
11.2.2. Communication Specifications	127
11.3. Supported Countries and Regions	128
11.3.1. WDT (Transmitter).....	128
11.3.2. WDR (Receiver).....	128
12. Replacement and Optional Parts	129
12.1. Replacement Parts	129
12.1.1. WDT (Transmitter).....	129
12.1.2. WDR (Receiver).....	129
12.2. Optional Parts	129
13. Free Software License Agreement	130
13.1. GNU GENERAL PUBLIC LICENSE	130
13.1.1. Version 1.0	130
13.1.2. Version 2.0	134
13.1.3. Version 3.0	139
13.2. GNU LIBRARY GENERAL PUBLIC LICENSE	149
13.2.1. Version 2.1	149
13.2.2. Version 3.0	156
13.3. BSD License	159
13.3.1. 2-Clause	159
13.3.2. 3-Clause	159
13.3.3. 4-Clause	160
13.4. Python Software Foundation License	161
13.5. PHP License, version 3.01	165
13.6. OpenSSL License	166
13.7. Boost Software License	168
13.8. Open Software Licence 3.0.....	168
13.9. MIT License	171
13.10. SIL OPEN FONT LICENSE	171

1. Before you begin



1.1. About Safety Symbols

In order to prevent any damage to the user and other personnel or to assets, note the following.



- The degree of harm and damage that will occur when misuse is made by ignoring the contents of the icons indicated is explained below.

 WARNING	This symbol indicates, "Failure to follow the instructions may lead to death or serious injury."
 CAUTION	This symbol indicates, "Failure to follow the instructions may lead to injury or property damage."

- The following symbols classify and describe the content of associated messages.

 Prohibited	This symbol identifies "Prohibited" operations that should never be carried out.
 Mandatory	This symbol identifies "Mandatory" instructions that should always be carried out.
	This symbol identifies general "Caution" related information.

1.2. Safety Precautions

 WARNING	
 Prohibited	<ul style="list-style-type: none"> ● This product is intended to be installed onto a compatible PATLITE signal tower for the purpose of wireless data transmission. Do not use this product for any other purpose. ● Please do not use a heart pace pay car and other medical-application electrical machinery and apparatus nearby.Do not use cardiac pacemakers or other medical electrical equipment nearby.Radio waves may have an adverse affect on medical electrical equipment. ● Do not use or install the receiver in locations where liquids such as water is present, oil will splatter, or locations that are humid or dusty. Failure to follow these instructions could result in fire, electric shock or product failure. ● To prevent accidents or injuries, use this product only for its intended purpose, and be sure to follow the guidelines outlined in this User’s Manual. ● This product is not intended for use in applications where life is at risk, such as medical equipment, atomic energy equipment and machinery, aviation and aerospace, transportation, and control of other equipment. If this system is used for these applications, we cannot be held responsible in the event of injury, death, or property damage. ● Do not modify or disassemble this product. Failure to follow these instructions could result in fire or electric shock. ● Do not use this product when there is condensation. Failure to follow these instructions could result in fire or electric shock. ● Do not allow liquids to enter the receiver, and do not allow it to have contact with metallic objects. Failure to follow these instructions could result in fire or electric shock.
 Mandatory	<ul style="list-style-type: none"> ● Request the installation and wiring to be accompanied by a professional contractor. If installation is done improperly, it may result in fire, electric shock, falling, or malfunction. ● Before installing and wiring this product, be sure that it is disconnected from the power source. Failure to comply may result in fire, electrocution or product malfunction ● Always use a power supply within the operating voltage range. Failure to follow this instruction could result in fire or product failure. ● Turn this product off while in airplanes, hospitals, or other places where radio waves may interfere with surrounding equipment or where wireless devices are prohibited. ● PATLITE can not predict all circumstances of hazards while using this product. Therefore, not all safety hazards are listed in this manual. In order to prevent accidents that may not be mentioned in this manual, please be sure to follow the provided guidelines while performing maintenance or operating this product. ● If you notice smoke, odor, or other abnormalities while this product is in operation, immediately stop supplying power to this product. Continuing to use this product under such conditions may result in fire or electric shock. ● Take the following precautions to prevent electric shock, short-circuit, or damage. ● Disconnect the power before wiring, repairs, or replacing a fuse. <ul style="list-style-type: none"> • Use this product only while in its proper state. (If the body or a unit is damaged, replace it.)



CAUTION



Prohibited

- Do not install this product near other electrical appliances. If you install this product near a facsimile, personal computer, television, microwave oven, or equipment using a motor, this product may not operate properly.
- Do not operate this product with the O-ring removed. Waterproof performance will drop and may damage the product. (Transmitter only).
- Do not use this product in applications that require a high-degree of reliability or real-time performance. If there are communication problems, this product cannot retrieve accurate data.
- Do not use this product near fire, in hot or humid environments, or where corrosive or flammable gas is present. Failure to follow this instruction could result in product malfunction.
- Do not use or store this product in the following locations. Failure to follow this instruction could result in product malfunction or failure.
 - Environments with poor breathability and ventilation.
 - Near equipment that generates strong electrical or magnetic fields
 - Places exposed to direct sunlight.
 - Locations subject to shock and vibration.
 - Near heating appliances.
 - Environments where dust or iron powder is present.
 - Locations from where the product may fall off.
 - Locations exposed to salty sea air.



Mandatory

- Operate this product only after thorough testing in the customer environment.
- If you need to secure this product against unauthorized access from external devices over the Internet or internal infrastructure network, the customer must take measures to prevent the unauthorized access.
- Pay close attention to the polarity of the power supply before connection. Connecting the power supply incorrectly could result in product failure.
- Use a soft cloth, etc., dampened with water to wipe the product. Do not use cleaners containing thinner benzene gasoline, oil, Chemicals, etc., to wipe with. It may result in discoloration and deterioration.
- In order to maintain this product's IP rating, be sure to attach each unit and head cover onto the signal tower properly. will drop and may damage the product.
- When removing covers or packing from equipment with the transmitter attached, be careful not to snag the product. Failure to follow this instruction could result in product failure.

CAUTION



- Although this product has a high level of security, there is the potential for third-parties to intercept communications as this product uses radio waves.
- When using this product, pay close attention to the following:
 - Due to the nature of radio waves, communication can be disabled even over insignificant distances as a result of noise or other environmental factors.
 - Do not use this product near chemicals. This product could melt or become deformed if exposed to chemicals.
 - To prevent static shock, make sure your body is discharged of static electricity. (You can discharge static electricity by touching grounded metal objects.)
 - Perform daily inspections.
 - As a precaution, use this product in conjunction with other equipment to handle potential problems.
- Operation under the following conditions could cause the wireless communication distance to become shorter than specified, and increase reaction times:
 - Metal obstructions, such as steel doors or reinforced concrete, are between the transmitter and receiver.
 - Transmitter or receiver is mounted on a metal surface.
 - Powerful radio waves are nearby, such as those emitted by broadcasting stations.
 - Power lines or other high-voltage lines are nearby.
- About the Operating Environment
 - We tested the product with out of the box computers in a normal operating environment. However, depending on your operating environment, which includes the computer main unit, peripheral devices and applications in use, there may be cases where this product will not run properly.
- The software copyrights are held by our company. Do not use this software in other products, or duplicate or modify a portion or all the software without prior written permission.
- Disposing this product
 - When disposing of this product, follow the rules and regulations on how to handle recyclable materials as outlined in your community.
- About this manual
 - The contents of this manual are subject to change without notice.
 - Images in this manual are for illustration purposes only, and may appear different from the actual product. Additionally, for ease of explanation, the illustration may hide a portion of the product.
 - This manual is copyrighted. No part of the manual, including drawings or technical information, can be copied or duplicated in any manner, without prior consent.
 - When transferring ownership of this product, include the instruction manual (digest version).
 - If you have any questions or need further information, contact your nearest PATLITE sales representative.

- We cannot warrant against breakdowns caused by disassembling this product, natural disasters, or handling of this product that is contrary to any warnings or precautions contained herein. Avoid using this product in ways other than those described in this manual.
- We cannot be held responsible for damages and injuries caused by failing to pay attention, or failing to follow precautions, during operation and maintenance.

1.3. About laws and regulations in each country

For Customers in U.S.A

• WDT-4LR-Z2/WDT-5LR-Z2/WDT-6LR-Z2

● FCC notation requirement

This device complies with part 15 of the FCC Rules. Operation is subject to the following two conditions:

(1) This device may not cause harmful interference, and (2) this device must accept any interference received, including interference that may cause undesired operation.

◆ FCC CAUTION

Note: Changes or modifications not expressly approved by the party responsible for compliance could void the user's authority to operate the equipment.

This equipment has been tested and found to comply with the limits for a Class B digital device, pursuant to part 15 of the FCC Rules. These limits are designed to provide reasonable protection against harmful interference in a residential installation. This equipment generates, uses and can radiate radio frequency energy and, if not installed and used in accordance with the instructions, may cause harmful interference to radio communications. However, there is no guarantee that interference will not occur in a particular installation. If this equipment does cause harmful interference to radio or television reception, which can be determined by turning the equipment off and on, the user is encouraged to try to correct the interference by one or more of the following measures:

- Reorient or relocate the receiving antenna.
- Increase the separation between the equipment and receiver.
- Connect the equipment into an outlet on a circuit different from that to which the receiver is connected.
- Consult the dealer or an experienced radio/ TV technician for help.

PATLITE(U.S.A)Corporation
20130 S. Western Ave. Torrance, CA90501, U.S.A
www.patlite.com

• WDR-L(E)-Z2-PRO(-L)

● FCC notation requirement

This device complies with part 15 of the FCC Rules. Operation is subject to the following two conditions:

(1) This device may not cause harmful interference, and (2) this device must accept any interference received, including interference that may cause undesired operation.

◆ FCC CAUTION

Note: Changes or modifications not expressly approved by the party responsible for compliance could void the user's authority to operate the equipment.

This equipment has been tested and found to comply with the limits for a Class A digital device, pursuant to Part 15 of the FCC Rules. These limits are designed to provide reasonable protection against harmful interference when the equipment is operated in a commercial environment. The equipment generates, uses, and can radiate radio frequency energy and, if not installed and used in accordance with the instruction manual, may cause harmful interference to radio communications. Operation of this equipment in a residential area is likely to cause harmful interference in which case the user will be required to correct the interference at his own expense.

(Responsible party in U.S.A.) PATLITE U.S.A. Corporation, R20130 S. Western Ave. Torrance, CA90501, U.S.A.
www.patlite.com

For Customers in Europe

• WDT-4LR-Z2/WDT-5LR-Z2/WDT-6LR-Z2



■ EU Declaration of Conformity

We PATLITE Corporation, 4-1-3, Kyutaromachi, Chuo-ku, Osaka-shi, Osaka 541-0056 JAPAN declare under our sole responsibility that the product described below is in compliance the following directives.

- Product Name: Wireless Data Acquisition System
- Company Logo: **PATLITE**
- Communication Frequency: 2405 to 2480 MHz (16 channels)
- Transmission Output: Maximum 3 mW or less (at the antenna feed point)
- Directive: Electromagnetic Compatibility Directive(EMC): 2014/30/EU
RoHS Directive: 2011/65/EU
Radio Equipment Directive: 2014/53/EU
Low Voltage Directive (LVD): 2014/35/EU

Visit our homepage at www.patlite.com/ce/wd_07539.html to download "EU Declaration of Conformity".

• WDR-L(E)-Z2-PRO(-L)



● EU Declaration of Conformity

This product conforms to EN standards and shows the CE Marking. This product has been tested and found to comply with the limits for a Class A device, pursuant to EMC DIRECTIVE. These limits are designed to provide reasonable protection against harmful interference when the equipment is operated in a commercial environment. This product must not be used in residential areas.

We PATLITE Corporation, 4-1-3, Kyutaromachi, Chuo-ku, Osaka-shi, Osaka 541-0056 JAPAN declare under our sole responsibility that the product described below is in compliance the following directives.

- Product Name: Wireless Data Acquisition System WD PRO Receiver
- Company Logo: **PATLITE**
- Communication Frequency: 2405 to 2480 MHz (16 channels)
- Transmission Output: Maximum 3 mW or less (at the antenna feed point)
- Directive: Electromagnetic Compatibility Directive(EMC): 2014/30/EU
RoHS Directive: 2011/65/EU
Radio Equipment Directive: 2014/53/EU
Low Voltage Directive (LVD): 2014/35/EU

Visit our homepage at www.patlite.com/ce/wd_07539.html to download "EU Declaration of Conformity".

For Customers in Thailand

• WDT-4LR-Z2/WDT-5LR-Z2/WDT-6LR-Z2/WDR-LE-Z2-PRO(-L)

This telecommunication equipment conforms to the technical standards or requirements of NBTC



For Customers in Canada

• WDT-4LR-Z2/WDT-5LR-Z2/WDT-6LR-Z2/WDR-LE-Z2-PRO(-L)

Canada, Innovation, Science and Economic Development Canada (ISED) Notices

This device contains licence-exempt transmitter(s)/receiver(s) that comply with Innovation, Science and Economic Development Canada's licence-exempt RSS(s). Operation is subject to the following two conditions:

- (1) This device may not cause interference.
- (2) This device must accept any interference, including interference that may cause undesired operation of the device.

Radio Frequency (RF) Exposure Information

The radiated output power of the Wireless Device is below the Innovation, Science and Economic Development Canada (ISED) radio frequency exposure limits. The Wireless Device should be used in such a manner such that the potential for human contact during normal operation is minimized.

This device has also been evaluated and shown compliant with the ISED RF Exposure limits under mobile exposure conditions. (antennas are greater than 20cm from a person's body).

Avis du Canada, Innovation, Sciences et Développement économique Canada (ISED)

L'émetteur/récepteur exempt de licence contenu dans le présent appareil est conforme aux CNR d'Innovation, Sciences et Développement économique Canada applicables aux appareils radio exempts de licence. L'exploitation est autorisée aux deux conditions suivantes :

- (1) L'appareil ne doit pas produire de brouillage;
- (2) L'appareil doit accepter tout brouillage radioélectrique subi, même si le brouillage est susceptible d'en compromettre le fonctionnement.

Informations concernant l'exposition aux fréquences radio (RF)

La puissance de sortie rayonnée du dispositif sans fil est inférieure aux limites d'exposition aux radiofréquences d'Innovation, Sciences et Développement économique Canada (ISED). Le dispositif sans fil doit être utilisé de manière à minimiser le potentiel de contact humain pendant le fonctionnement normal.

Cet appareil a également été évalué et montré conforme aux limites d'exposition RF ISED dans des conditions d'exposition mobiles. (Les antennes sont à plus de 20 cm du corps d'une personne).

For Customers in Taiwan

• WDT-4LR-Z2/WDT-5LR-Z2/WDT-6LR-Z2/WDR-LE-Z2-PRO(-L)

◆第十二條 經型式認證合格之低功率射頻電機，非經許可，公司、商號或使用者均不得擅自變更頻率、加大功率或變更原設計之特性及功能。

◆第十四條 低功率射頻電機之使用不得影響飛航安全及干擾合法通信；經發現有干擾現象時，應立即停用，並改善至無干擾時方得繼續使用。

前項合法通信，指依電信法規定作業之無線電通信。低功率射頻電機須忍受合法通信或工業、科學及醫療用電波輻射性電機設備之干擾。

For Customers in Mexico

• WDT-4LR-Z2/WDT-5LR-Z2/WDT-6LR-Z2/WDR-LE-Z2-PRO(-L)



La operación de este equipo está sujeta a las siguientes dos condiciones:

(1) es posible que este equipo o dispositivo no cause interferencia perjudicial y

(2) este equipo o dispositivo debe aceptar cualquier interferencia, incluyendo la que pueda causar su operación no deseada.

For Customers in Singapore

• WDT-4LR-Z2/WDT-5LR-Z2/WDT-6LR-Z2/WDR-LE-Z2-PRO(-L)

Complies with
IMDA Standards
DA106138

1.4. Trademarks

MySQL is a trademark or registered trademark of Oracle Corporation and its subsidiaries in the United States and other countries.

Modbus is a registered trademark of Modicon Inc. (Schneider Automation International).

Google Chrome is a trademark or registered trademark of Google LLC.

Microsoft Edge and Internet Explorer are trademarks or registered trademarks of Microsoft Corporation in the United States and other countries.

Siemens and MindSphere are trademarks or registered trademarks of Siemens AG.

2. Contents

2.1. About the Contents

2.1.1. WDT-4LR-Z2/WDT-5LR-Z2/WDT-6LR-Z2

Main Unit: 1

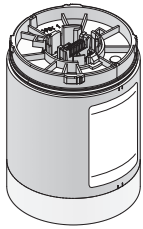

User's Manual: 1

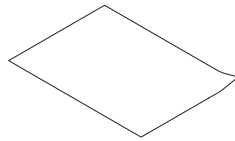

2.1.2. WDR-L-Z2-PRO(-L)/WDR-LE-Z2-PRO(-L)

Main Unit: 1

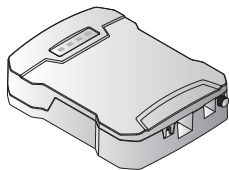

Instruction Manual: 1

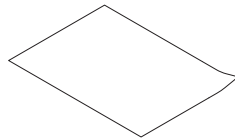

Accessory		
<p>Cable fixing plate</p> <p style="text-align: right;">1</p>	<p>Cable tie</p> <p style="text-align: right;">1</p>	<p>AC Adaptor (WDR-L-Z2-PRO(-L) only)</p> <p style="text-align: right;">1</p>

3. Models

3.1. About Models

3.1.1. WDT (Transmitter)

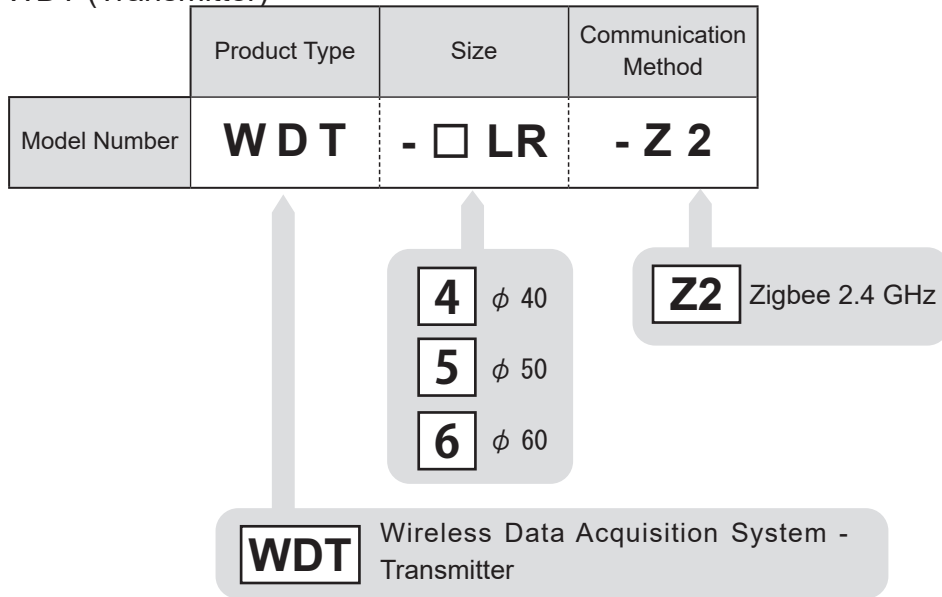

The types of LR Signal Towers applicable to each WDT (transmitter) are as follows.

WDT (transmitter)	LR Signal Tower		
Model	Model	Size	Rated Voltage
WDT-4LR-Z2	LR4- □ -02	φ 40	24 VDC
	LR4- □ -M02		100 to 240 VAC
WDT-5LR-Z2	LR5- □ -01	φ 50	12 VDC
	LR5- □ -02		24 VDC
WDT-6LR-Z2	LR6- □ -02	φ 60	24 VDC
	LR6- □ -M2		100 to 240 VAC

3.1.2. WDR (Receiver)

	Product Type	Specifications	Communication Method	Model	Software specifications
Model Number	WDR	- □	- Z 2	-PRO	□

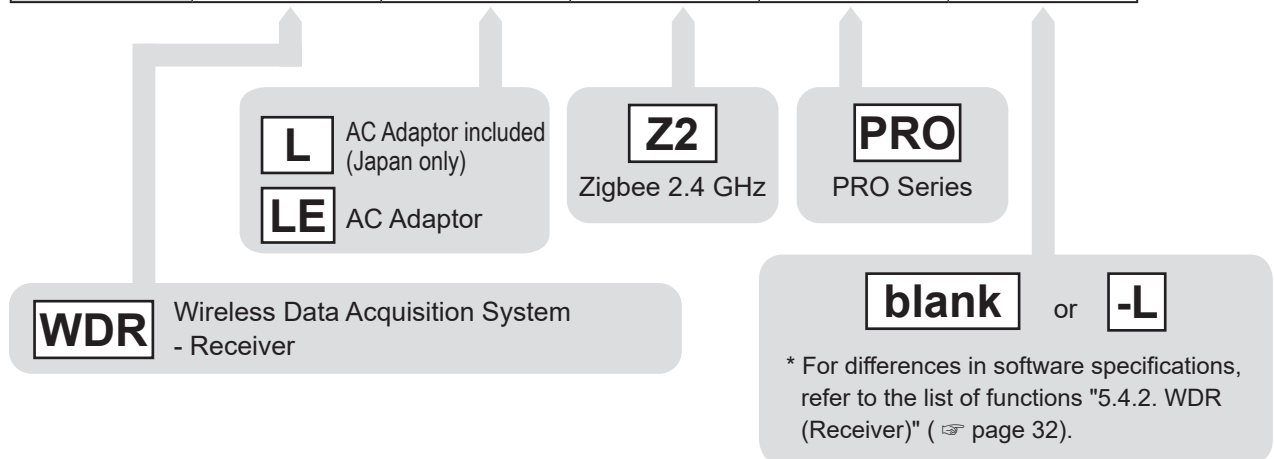

By checking the nameplate affixed to the product, you can identify products due to their differences in software specifications.

WDR-L-Z2-PRO (When software specification is **Blank)**



WDR-L-Z2-PRO-L (When software specification is **-L)**

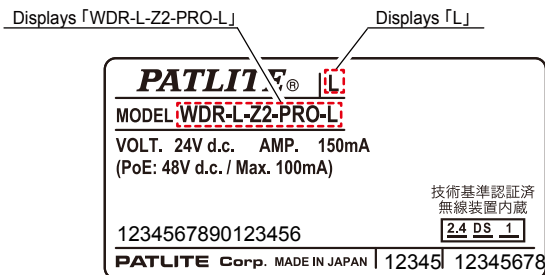

WDR-LE-Z2-PRO (When software specification is **Blank)**

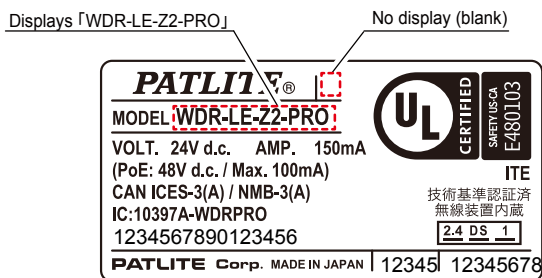

WDR-LE-Z2-PRO-L (When software specification is **-L)**

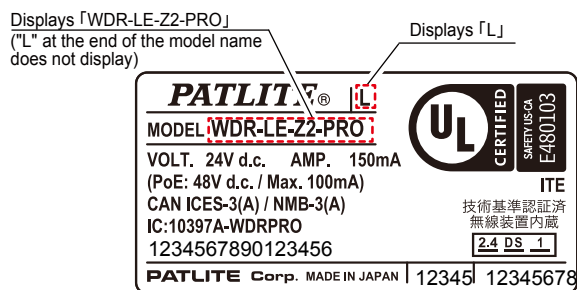

4. Part Names and Dimensions

4.1. About Part Names and Dimensions

4.1.1. WDT (Transmitter)

● For WDT-4LR-Z2

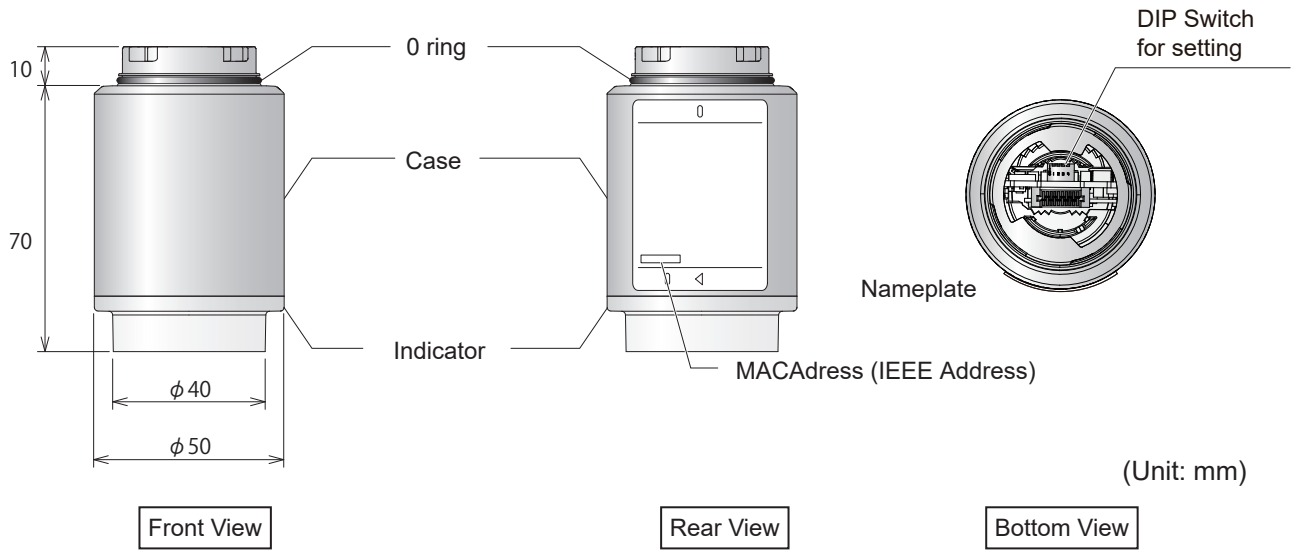

● For WDT-5LR-Z2 and WDT-6LR-Z2

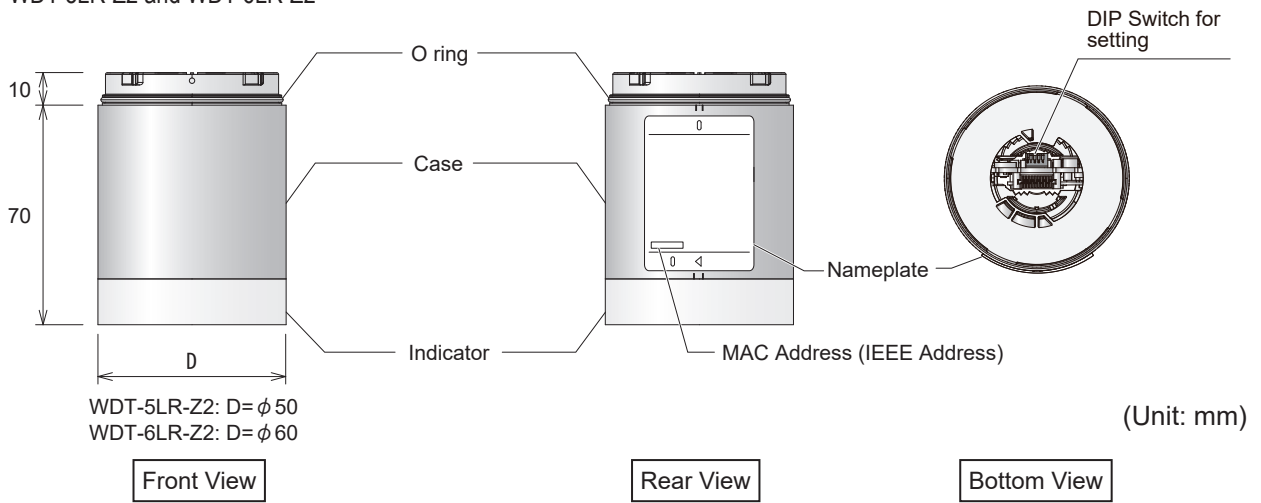

4.1.2. WDR (Receiver)

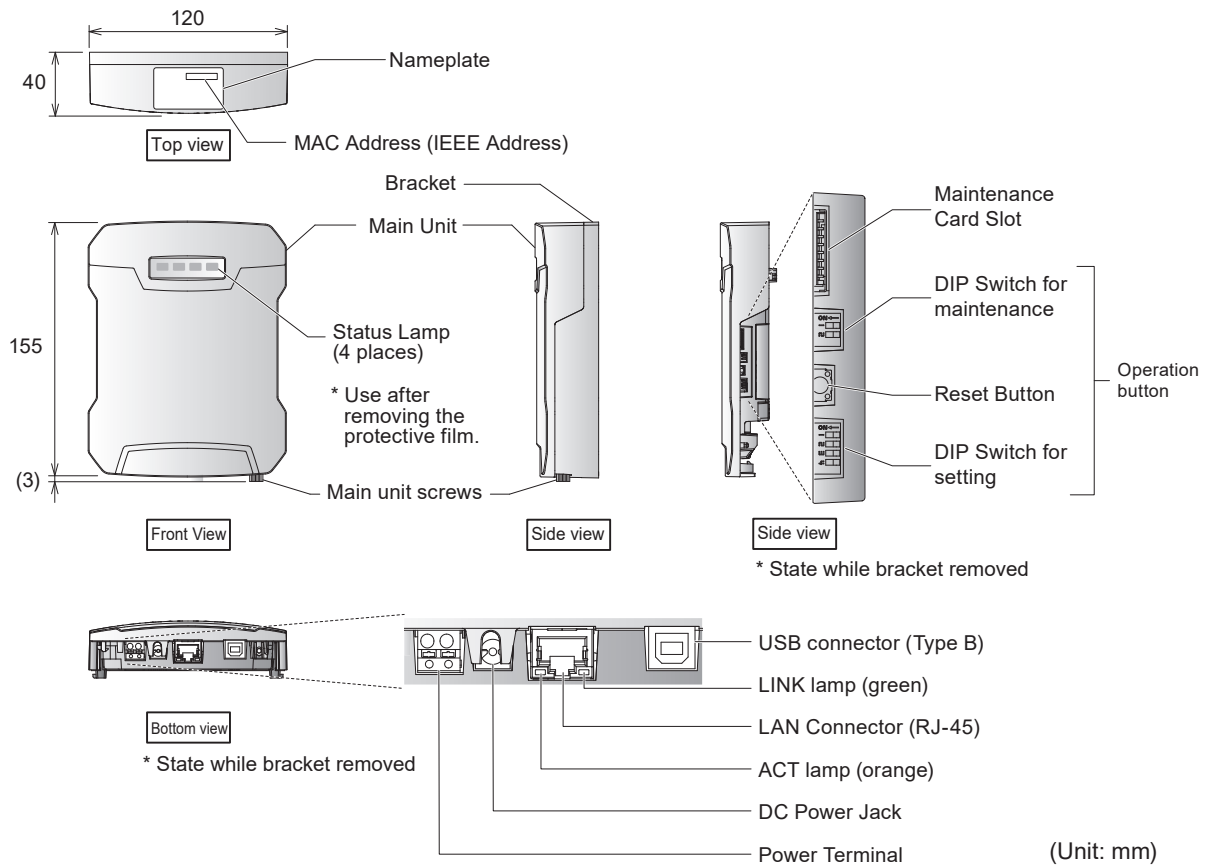

5. Product Overview

5.1. About the WD System

To collect data available on equipment in your facility, the WD system transmits associated information (such as equipment operation data) to a host computer over the WD wireless network. By using visualization application software, you can use collected information to accurately view the capacity utilization rate, trigger improvement activities, and optimize operations. This application is not limited to production facilities and can be applied to other areas.

5.2. System Configuration

5.2.1. Glossary

Term	Description
WD System	Name for the system as a whole. Can include multiple WD wireless networks and hosts.
WD wireless network	A part of the wireless network that consists of one WDR and multiple WDT (up to 30 units).
WDR	Receiver on a WD wireless network. Receives information from multiple WDT and transmits to the host. Models: WDR-L-Z2-PRO, WDR-L-Z2-PRO-L, WDR-LE-Z2-PRO, WDR-LE-Z2-PRO-L
WDS	Application software for WDT and WDR settings, and for collecting Signal Tower information in the WD system as CSV log data. Model: WDS-WIN01
WDT	Transmitter on a WD wireless network. Collects various information from a Signal Tower and transmits the information wirelessly to WDR. Models: WDT-5E-Z2, WDT-6M-Z2, WDT-4LR-Z2, WDT-5LR-Z2, WDT-6LR-Z2
Signal Tower Input Information	Input information of the Signal Tower collected by the WD system.
Host	Equipment for operation of the WD system.
Application Software*	Application software installed on the host PC. Use this application to display information collected by the WD system in a gantt chart or graph. Must be provided by the customer.
Maintenance PC	At maintenance, personal computer for setting up the WDT and WDR.

*For application software, refer to "5.3. About Application Software" ( page 29).

5.2.2. WD System Configuration at Run Time

5.2.2.1. System Configuration Example for CSV File

- Configuration diagram

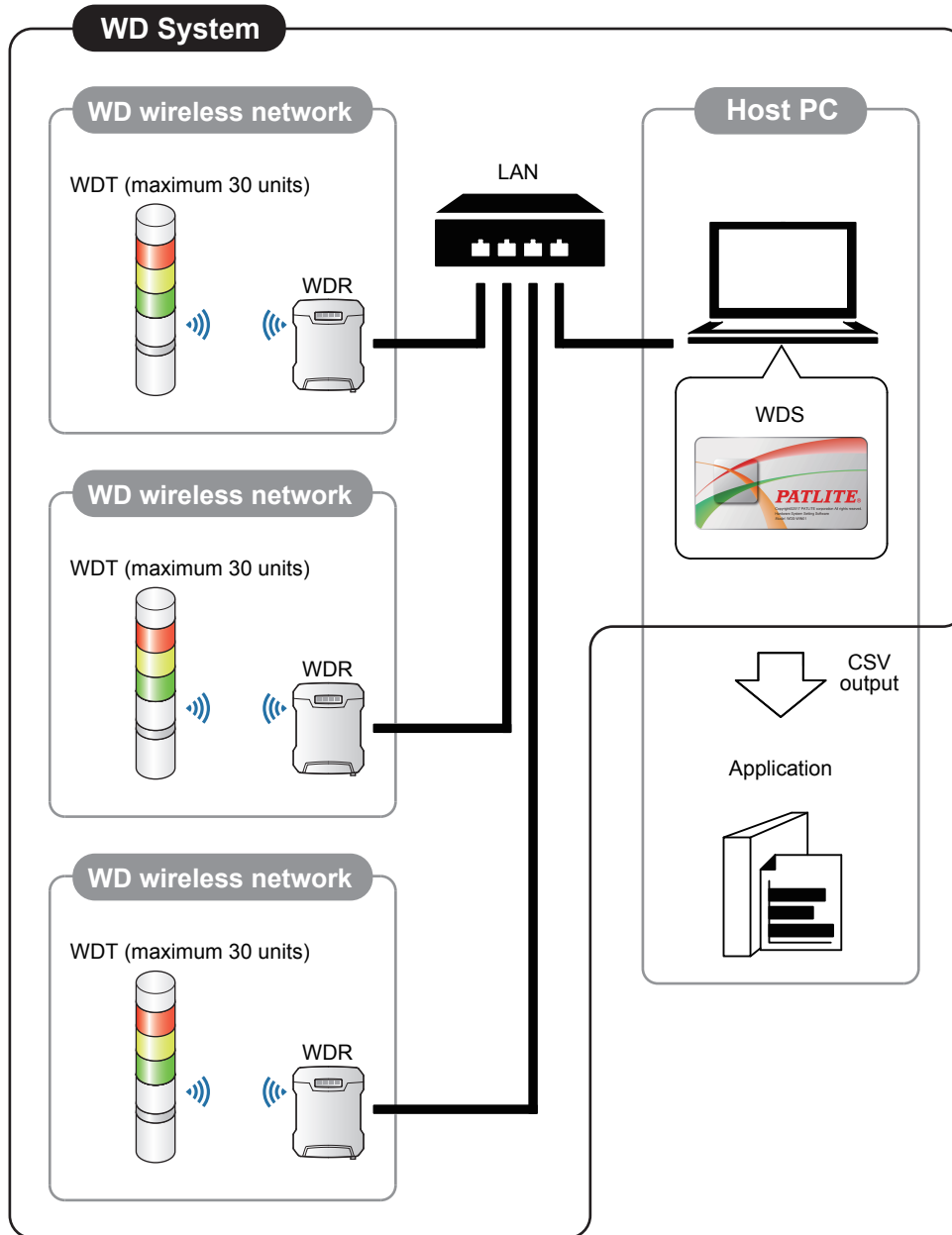

- Configuration

Item	Number of configuration items	Models
WDT	1 to 30 units* ¹ per receiver	WDT-5E-Z2 / WDT-6M-Z2 / WDT-4LR-Z2 / WDT-5LR-Z2 / WDT-6LR-Z2 / WDT-6LR-Z2-PRO
WDR	1 to 20 units* ²	WDR-L-Z2-PRO(-L)/WDR-LE-Z2-PRO(-L)
WDS	1	WDS-WIN01 *Version 1.04 or later
Host PC	1 unit	-

*1 For information, refer to "6.1.5. How many WDT you can connect to WDR" (☞ page 36).

*2 When collecting CSV log data with WDS-WIN01.

5.2.2.2. Socket Communication System Configuration Example

- Configuration diagram

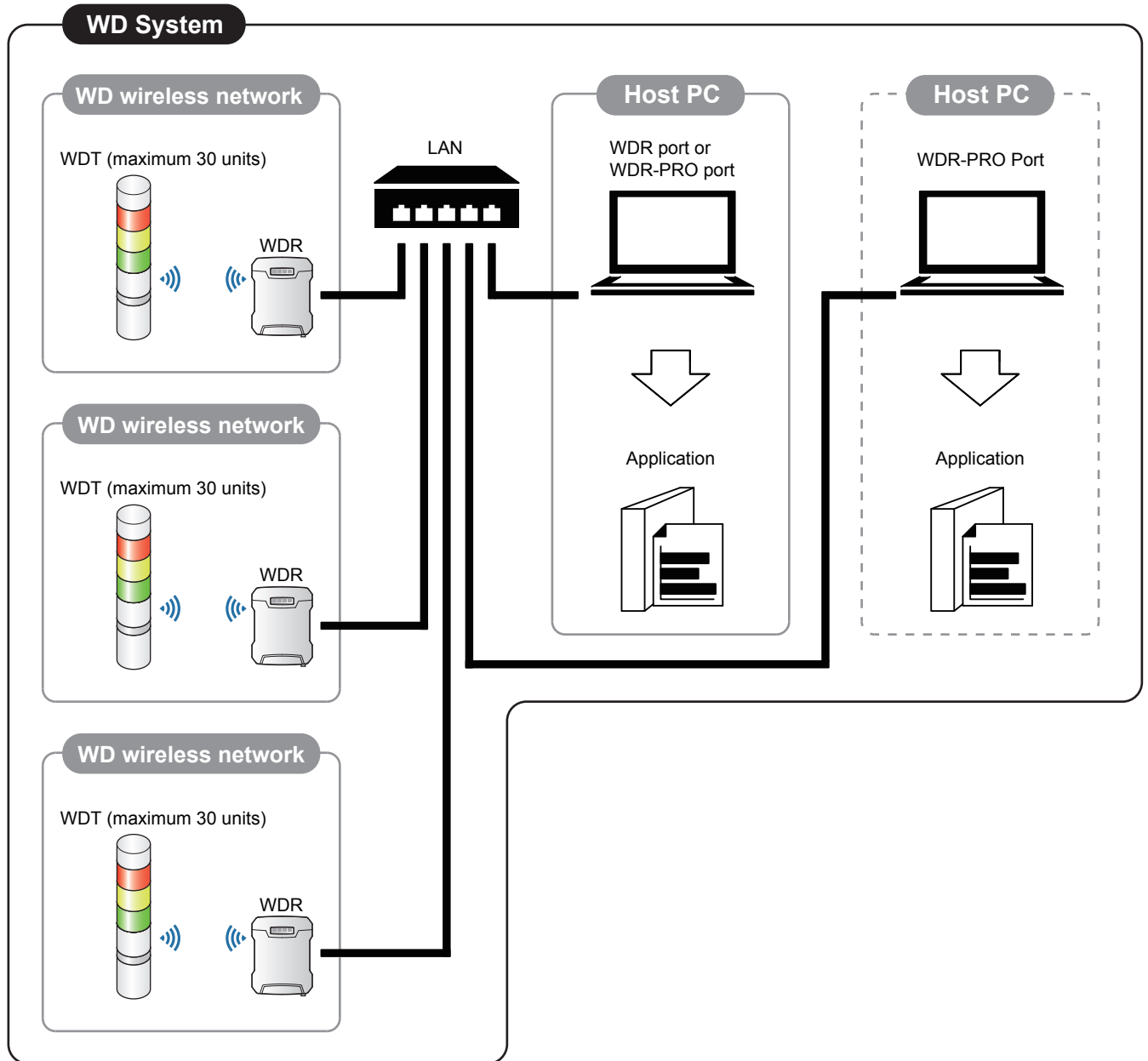

- Configuration

Item	Number of configuration items	Models
WDT	1 to 30 units* ¹ per receiver	WDT-5E-Z2 / WDT-6M-Z2 / WDT-4LR-Z2 WDT-5LR-Z2 / WDT-6LR-Z2 / WDT-6LR-Z2-PRO
WDR	1+ units	WDR-L-Z2-PRO(-L)/WDR-LE-Z2-PRO(-L)* ³
Host PC	1 to 2 units* ²	-

*1 For information, refer to "6.1.5. How many WDT you can connect to WDR" (☞ page 36).

*2 For WDR Port and WDR-PRO Port information, refer to "9.2.1.1. Socket Communication" (☞ page 117).

*3 The WDR port is the only port you can use on the WDR-L-Z2-PRO-L and WDR-LE-Z2-PRO-L .

5.2.2.3. Example Database Communication System Configuration

- Configuration diagram

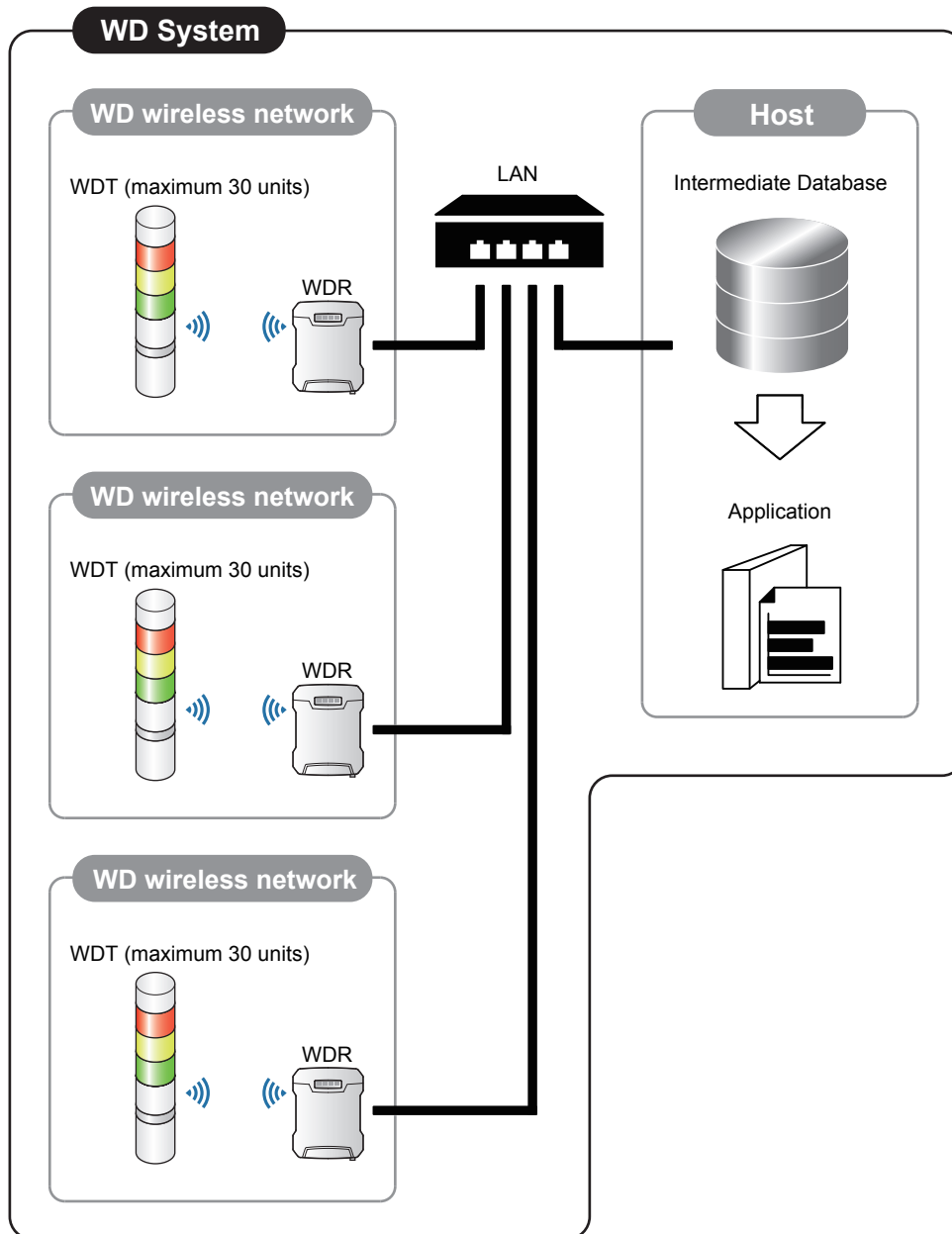

- Configuration

Item	Number of configuration items	Models
WDT	1 to 30 units* ¹ per receiver	WDT-5E-Z2 / WDT-6M-Z2 / WDT-4LR-Z2 WDT-5LR-Z2 / WDT-6LR-Z2 / WDT-6LR-Z2-PRO
WDR	1+ unit	WDR-L-Z2-PRO/WDR-LE-Z2-PRO* ²
Intermediate Database	1 unit	—

*1 For information, refer to "6.1.5. How many WDT you can connect to WDR" ( page 36).

*2 WDR-L-Z2-PRO-L and WDR-LE-Z2-PRO-L cannot use database communication.

5.2.2.4. Example Modbus/TCP Communication System Configuration

- Configuration diagram

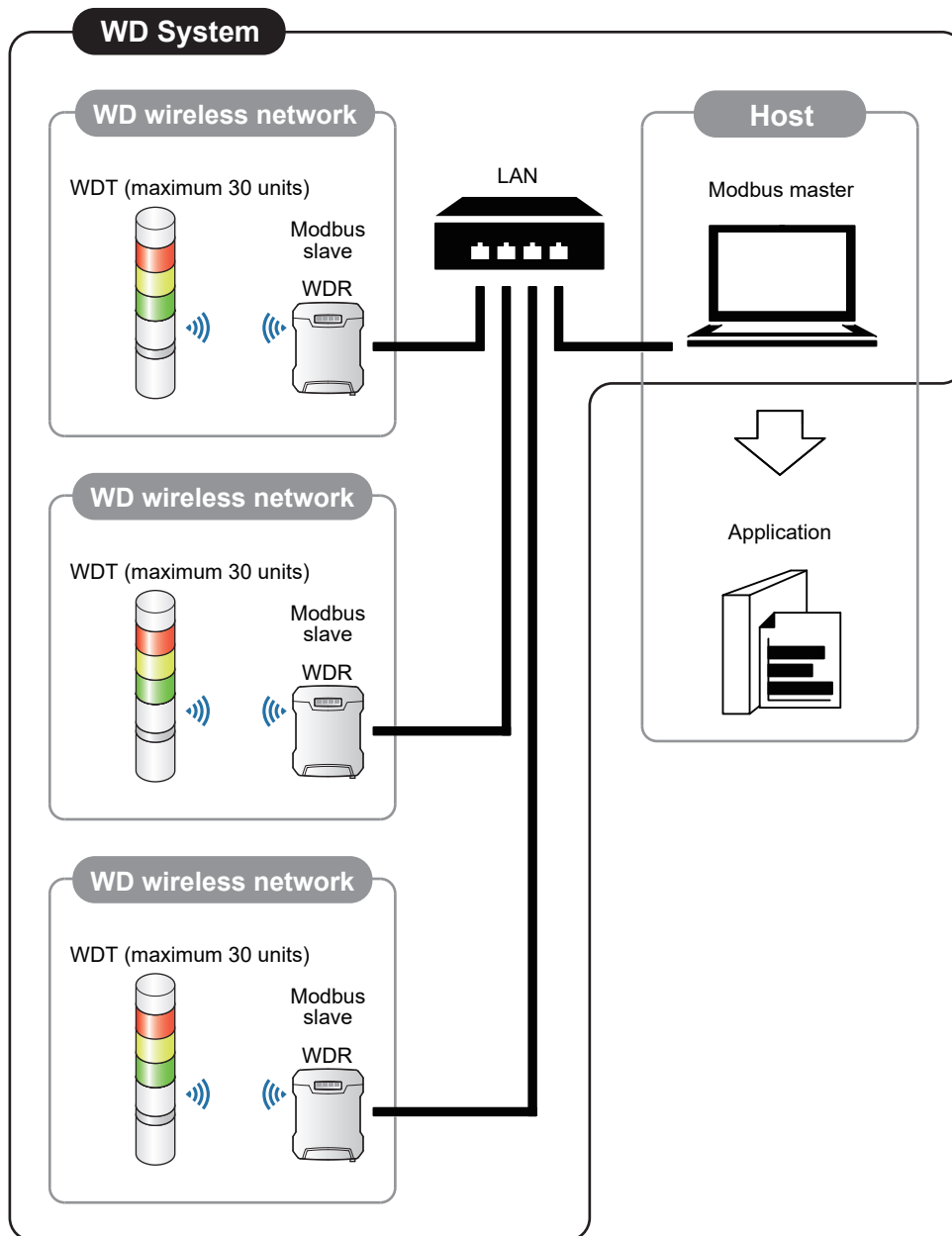

- Configuration

Item	Number of configuration items	Models
WDT	1 to 30 units* ¹ per receiver	WDT-5E-Z2 / WDT-6M-Z2 / WDT-4LR-Z2 WDT-5LR-Z2 / WDT-6LR-Z2 / WDT-6LR-Z2-PRO
WDR	1+ units	WDR-L-Z2-PRO/WDR-LE-Z2-PRO* ²
Modbus master	1 unit	—

*1 For information, refer to "6.1.5. How many WDT you can connect to WDR" (page 36).

*2 WDR-L-Z2-PRO-L and WDR-LE-Z2-PRO-L cannot use Modbus/TCP communication.

5.2.2.5. Example System Configuration for Cloud Communication

- Configuration diagram

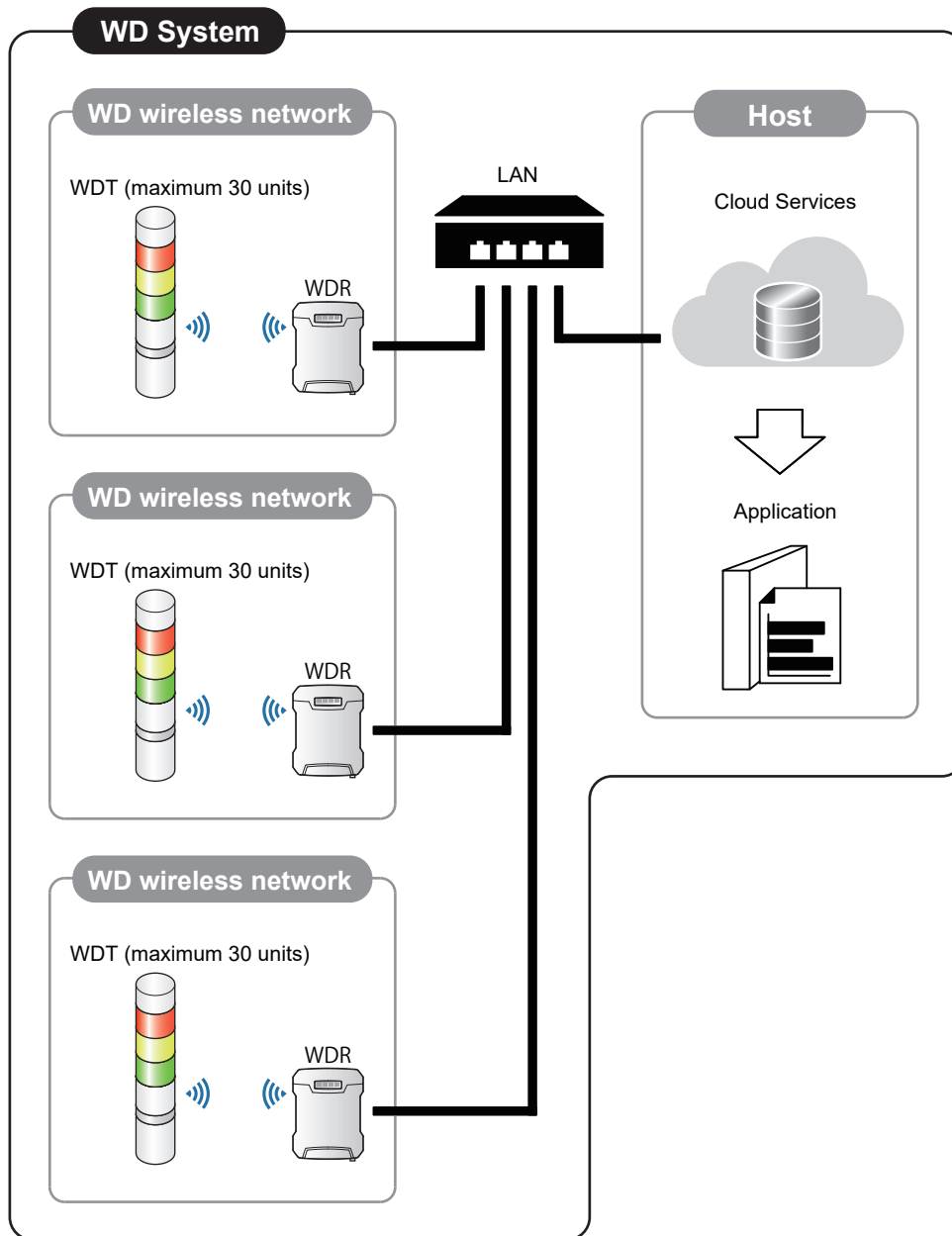

- Configuration

Item	Number of configuration items	Models
WDT	1 to 30 units* ¹ per receiver	WDT-5E-Z2 / WDT-6M-Z2 / WDT-4LR-Z2 WDT-5LR-Z2 / WDT-6LR-Z2 / WDT-6LR-Z2-PRO
WDR	1+ units	WDR-L-Z2-PRO/WDR-LE-Z2-PRO* ²
Cloud Service	1 unit	Siemens MindSphere

*1 For information, refer to "6.1.5. How many WDT you can connect to WDR" (☞ page 36).

*2 WDR-L-Z2-PRO-L and WDR-LE-Z2-PRO-L cannot use Cloud Communication.

5.2.3. Example System Configuration When Setting Up Equipment (using the Setup Kit)

• Configuration diagram

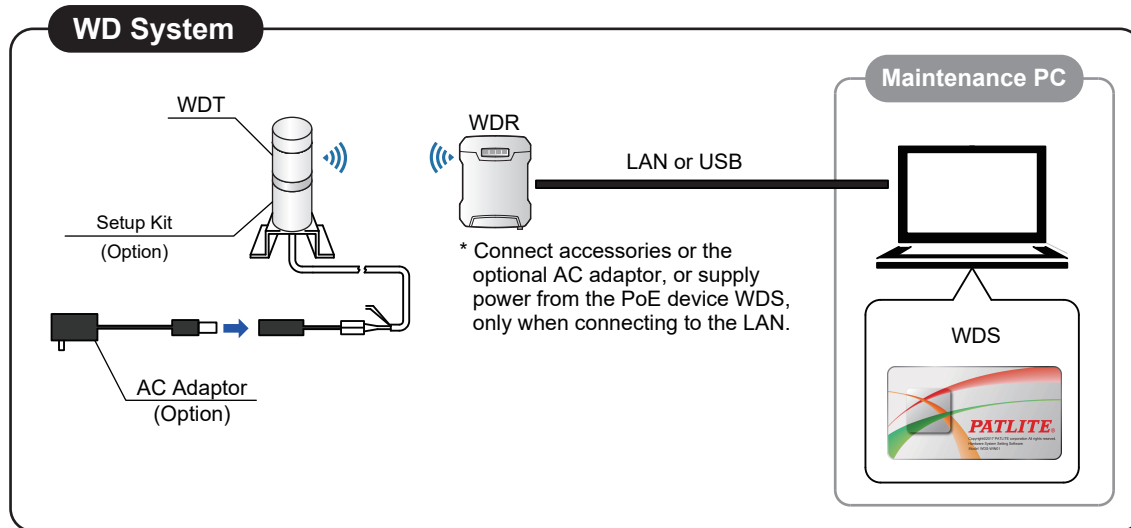

• Configuration

Item	Number of configuration items	Models
WDT	Units as required	WDT-4LR-Z2 WDT-5LR-Z2 WDT-6LR-Z2
Setup Kit (option)	1 unit	WDX-4LRB WDX-5LRB WDX-6LRB
AC Adaptor (option)	1 unit	ADP-001
WDR	1 unit	WDR-L-Z2-PRO(-L) WDR-LE-Z2-PRO(-L)
WDS	1	WDS-WIN01 *Version 1.04 or later
Maintenance PC	1 unit	-
LAN Cable* ¹	1	-
USB Cable* ² * ³	1	-

*1 When configuring the WDR settings, connect with a LAN cable.

*2 Use a USB cable 3 m or shorter.

*3 Do not connect LAN and USB cables at the same time.

⚠ CAUTION

❗ When setting WDR, make sure the LAN cable is connected. You cannot set the WDR when a USB cable is connected.

5.3. About Application Software

! CAUTION

- ⚠ The customer needs to provide the application software.
- ⚠ Select a visualization application software suitable for customer visualization requirements.
- ⚠ There are five ways the WD system passes collected information to the application software: CSV File, Socket Communication, Database Communication, Modbus/TCP Communication, and Cloud Communication.

5.3.1. Pattern 1: CSV File

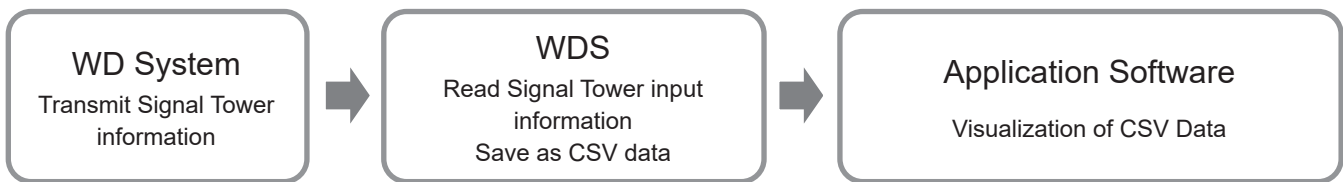

No.	Application Software Preparation	References
1	When using software packages from PATLITE partners that support the WD system	☞ Please contact our sales office.
2	When customer develops their own solution	Refer to ☞ this manual Refer to ☞ "WDS-WIN01 Instruction Manual"

5.3.2. Pattern 2: Socket Communication



No.	Application Software Preparation	References
1	When using software packages from PATLITE partners that support the WD system	☞ Please contact our sales office.
2	When customer develops their own solution	Refer to ☞ this manual Refer to ☞ "Application Notes for WD PRO Receiver"

*For information, contact your nearest PATLITE sales representative.

5.3.3. Pattern 3: Database Communication

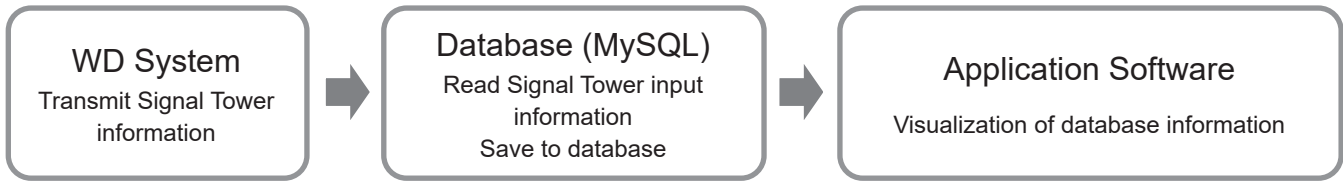

No.	Application Software Preparation	References
1	When using software packages from PATLITE partners that support the WD system	☞ Please contact our sales office.
2	When customer develops their own solution	Refer to ☞ this manual Refer to ☞ "Application Notes for WD PRO Receiver"

*For information, contact your nearest PATLITE sales representative.

5.3.4. Pattern 4: Modbus/TCP Communication



No.	Application Software Preparation	References
1	When using software packages from PATLITE partners that support the WD system	☞ Please contact our sales office.
2	When customer develops their own solution	Refer to ☞ this manual Refer to ☞ "Application Notes for WD PRO Receiver"

*For information, contact your nearest PATLITE sales representative.

5.3.5. Pattern 5: Cloud Communication

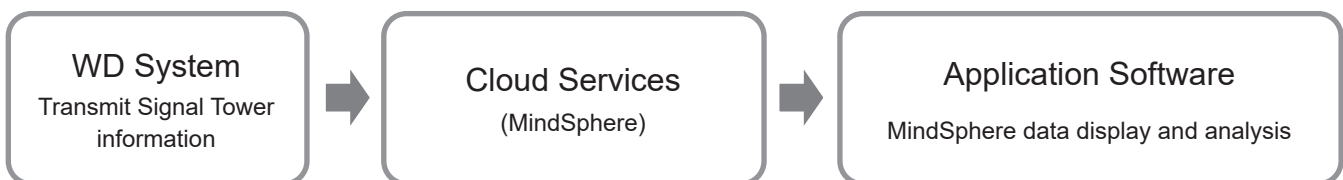

No.	Application Software Preparation	References
1	When using software packages from PATLITE partners that support the WD system	☞ Please contact our sales office.
2	When customer develops their own solution	

5.4. Function List

5.4.1. WDT (Transmitter)

5.4.1.1. Wireless Data Transmission Function

Function	Description	References
Signal Tower Transmission Information	Function whereby the WDT transmits the status of the Signal Tower control line wirelessly to the WDR.	☞ "9.1.1.1. Transmit Signal Tower Information" (page 111)
Select Format of Signal Tower Information	This function is for selecting one of two types of signal tower information, extended format or standard format.	☞ "9.1.1.2. Select Format of Signal Tower Information" (page 111)
About Periodic Transmissions	Function where every 10 seconds the WDT transmits the current status of the Signal Tower control line.	☞ "9.1.1.3. About Periodic Transmissions" (page 112)
Mesh Network Transmission	Function that interconnects the WDT and transmits information to the WDR over the optimum communication route.	☞ "9.1.1.4. Mesh Network Transmission" (page 112)
Simple Counter Function	WDT function for saving the accumulated value (counter value) of pulse inputs (incremented 1 at a time) on a Signal Tower control line.	☞ "9.1.1.5. Simple Counter Function" (page 113)

5.4.1.2. Signal Wire Input Functions

Function	Description	References
Determine Signal Tower Control Input	Function for determining the input status of the Signal Tower control line. There are two settings, normal and flashing. Set up in WDS-WIN01. This function cannot determine the input status of the Signal Tower control line used in a simple counter function.	☞ "9.1.2.1. Determine Signal Tower Input" (page 114)

5.4.2. WDR (Receiver)

5.4.2.1. Host Communication Function

Function	Description	Support		References
		WDR-L(E)-Z2-PRO	WDR-L(E)-Z2-PRO-L	
LAN Communication	Based on LAN communication, using socket communication, database communication, and Modbus/TCP communication, you can communicate with the host at the same time.	-	-	-
Socket Communication	Function for communicating with applications on the host via the TCP socket.	○	△ (Cannot use WDR-PRO port)	☞ "9.2.1.1. Socket Communication" (page 117)
Database Communication	As a MySQL client, function for connecting to the host database and outputting data.	○	x (Cannot use)	☞ "9.2.1.2. Database Communication" (page 118)
Modbus/TCP Communication	Function for operating as a Modbus slave.	○	x (Cannot use)	☞ "9.2.1.3. Modbus/TCP Communication" (page 119)
Cloud Communication	Function for collaborating with MindSphere.	○	x (Cannot use)	☞ "7.4.3.4. Cloud Communication Settings" (page 69)
USB Communication	Data collected from a transmitter is output to the host via USB communication.	○	○	☞ "9.2.1.4. USB Communication" (page 119)

5.4.2.2. Setting and Maintenance Functions

Function	Description	Support		References
		WDR-L(E)-Z2-PRO	WDR-L(E)-Z2-PRO-L	
Receiver Wireless Settings Function	Function to set WDR wireless settings from the Web setup screen.	○	x (Cannot use)	☞ "7.4.5.1. Main Unit Information" (page 81)
Transmitter Setting Function	Function to set WDT from the Web setup screen.	○ (Not all WDB-D80S-PRO and WDT-6LR-Z2-PRO settings can be set up on the Web Setup Screen)	x (Cannot use)	☞ "7.4.4.2. Wireless Settings List" (page 73)
Self Diagnosis Function	Function for self-diagnosis of the WD system's wireless environment.	○	○	☞ "9.2.2. Self Diagnosis Function" (page 121)
Status Check Function	Function for checking, from a Web browser, the input status of the WDT Signal Tower Control Line.	○	x (Cannot use)	☞ "7.4.4.4. Status Check" (page 78)

6. Before Use

6.1. WD System Basic Information

6.1.1. About the WD Wireless Network

- The WD wireless network operates on the IEEE802.15.4. (ZigBee) compliant 2.4 GHz frequency. Although it runs on the same 2.4 GHz frequency as a wireless LAN (Wi-Fi), because it conforms to IEEE802.15.4, the WD wireless network can operate without a wireless LAN. However, if the frequencies you use overlap, the WD wireless network could experience transmission delays and other communication issues.
- The wireless communication is encrypted. The encryption standard used is AES-CCM (Advanced Encryption Standard-Counter with CBC-MAC), with an encryption key of 128 bits.

6.1.2. About Selecting a Wireless Channel

- The WD wireless network uses 16 wireless channels (CH11 to CH26).
- Select a wireless channel to avoid conflict with the frequency band of the LAN wireless channels in your installation environment.
- The relationship between frequency bands of channels on the WD wireless network and on the wireless LAN is as follows.

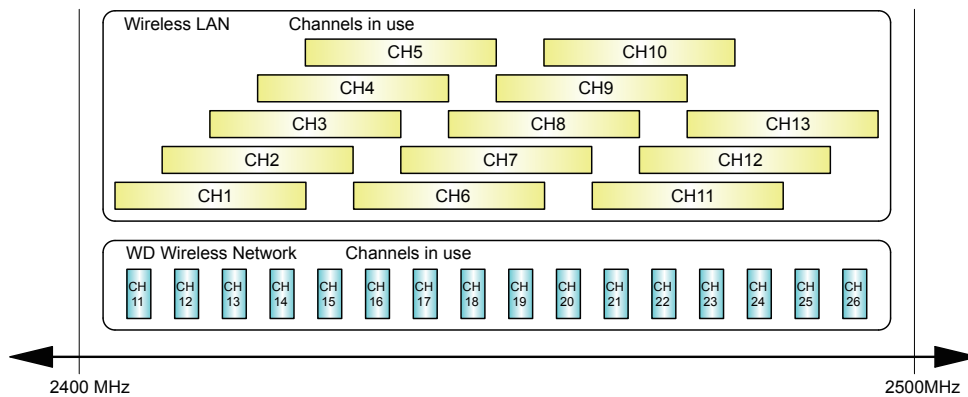

- The frequency of each channel on the WD wireless network is as follows.

Channel	Mid-range frequency (MHz)	Bandwidth (MHz)	Channel	Mid-range frequency (MHz)	Bandwidth (MHz)
CH11	2,405	2	CH19	2,445	2
CH12	2,410	2	CH20	2,450	2
CH13	2,415	2	CH21	2,455	2
CH14	2,420	2	CH22	2,460	2
CH15	2,425	2	CH23	2,465	2
CH16	2,430	2	CH24	2,470	2
CH17	2,435	2	CH25	2,475	2
CH18	2,440	2	CH26	2,480	2

- When the wireless LAN uses three channels (CH1, CH6, and CH11), select either CH15, CH20, CH25, or CH26.
- In most cases, selecting CH25 or CH26 will enable you to avoid the wireless LAN channels.

6.1.3. About Grouping and ExtendedPanID

- The WD system requires using [ExtendedPanID] to group each WD wireless network (one WDR with multiple connected WDT). The ExtendedPanID consists of 16 single-byte, alphanumeric characters. Setup range: 0000 0000 0000 0000 to FFFF FFFF FFFF FFFE.
- You can use any combination of WDT-5E-Z2, WDT-6M-Z2, WDT-4LR-Z2, WDT-5LR-Z2, WDT-6LR-Z2, and WDT-6LR-Z2-PRO.
- The following illustrate how you can set the ExtendedPanID and wireless channels for devices in multiple groups.

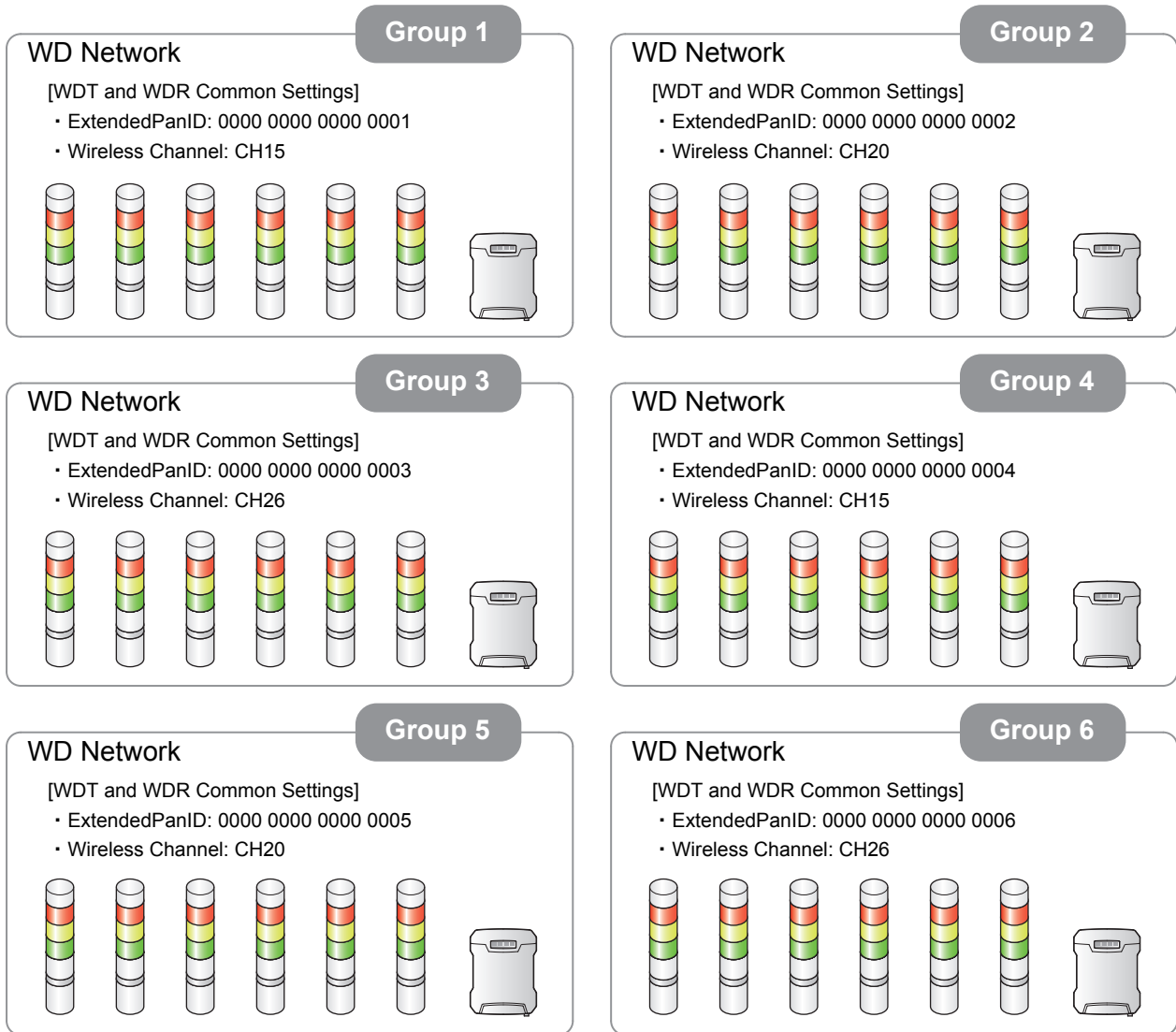

- If there are multiple channels available for selection, you should use separate wireless channels for each group. By distributing groups over multiple channels, you can reduce the load concentrated on a single wireless channel.

⚠ CAUTION

- ⊘ When there are multiple WDR in your system, do not use the same value for the ExtendedPanID. The product may not operate properly.
- ⓘ When the WDT ExtendedPanID is 0000 0000 0000 0000 (default value), regardless of the ExtendedPanID setting all the WDR may be grouped together. In this scenario, because the grouped wireless network is not stable, set any value other than 0000 0000 0000 0000 during configuration.
- ⚠ When the WDR ExtendedPanID is 0000 0000 0000 0000 (default value), the WDR MAC address (IEEE address) operates as ExtendedPanID. In this scenario, because ExtendedPanID operates with a value that is different from its set value, it is recommended to set any value other than 0000 0000 0000 0000 (default value) during configuration.

6.1.4. About the MAC Address (IEEE Address)

- Static addresses assigned to WDT and WDR for identification. This address is called a MAC address (IEEE address).
- The MAC address (IEEE Address) is printed on a nameplate on the back of the WDT.

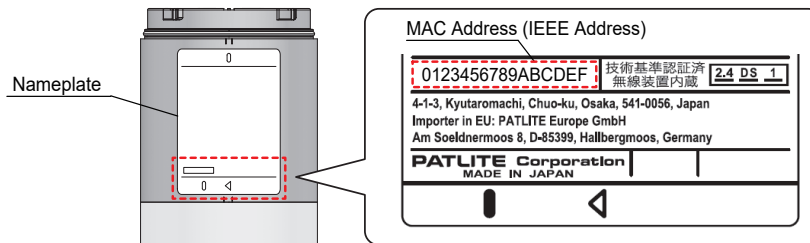

- The MAC address (IEEE Address) is printed on a nameplate on the top of the WDR.
(This is different from the MAC address used for LAN communication. You can see the MAC address used for LAN communication from the Web Setup Screen. For information, refer to "7.4.5.1. Main Unit Information" (☞ page 81).)

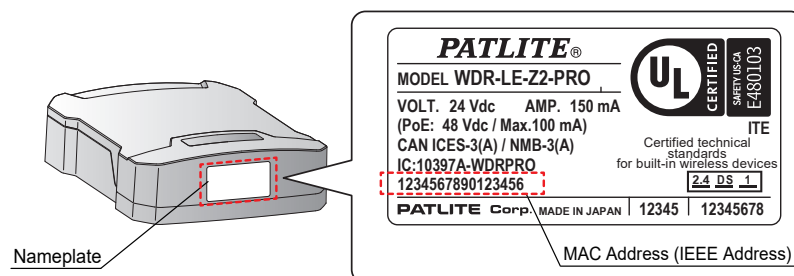

6.1.5. How many WDT you can connect to WDR

The number of WDT units you can connect to a WDR is limited by the frequency of information sent to the WDR. The average of all transmissions from all WDT connected to the WDR is limited to 240 or less per minute (transmission interval of 0.25 seconds or longer). To satisfy this condition, use the following table as a guide and determine the number of connected units.

WDT connection limit	Estimated number of Signal Tower information transmissions / 1 WDT
30 unit	8 times per minute
20 unit	12 times per minute
10 unit	24 times per minute
5 unit	48 times per minute
1 unit	240 times per minute

6.1.6. About Maintain Signal Tower Status

Both the WDT and WDR can temporarily save information internally. Temporarily saved information is transmitted from WDT to WDR, and from WDR to host, in order from oldest to newest. The maximum amount of Information that can be saved temporarily is 32 for WDT, and up to 1000 for WDR connected to WDT.

Point

- When the maximum number of information is exceeded, information is deleted beginning with the oldest.
- When power on the WDT or WDR is shut down, the information is deleted.

6.2. About the Installation Environment

6.2.1. Installation Environment Main Points

There are five essential points to consider at installation.

No.	Description	References
1	There is no influence in radio waves at the installation site. Also, the radio waves at the installation site do not change over time.	☞ "6.2.3. About the Influence of Surrounding Radio Waves" (page 38)
2	The distance between devices (WDR, WDT) does not exceed recommendations. The recommended distance between all WDT and WDR is within line of sight.	☞ "6.2.2. Distance Between Devices" (page 37)
3	Each device (WDR and WDT) is in line of sight. To ensure good line of sight, the location should not be cluttered and should be free of any obstacles.	☞ "6.2.4. Ensuring Line of Sight" (page 39)
4	Placement of WDR is appropriate. <ul style="list-style-type: none"> • Install in a location as high as possible. • Install away from obstacles that could disrupt radio waves. 	☞ "6.2.5. WDR Installation Position and Obstacles" (page 39)
5	Each device is always powered, and the mesh network is always available. If power is not available for one of the WDT, the communication path could get interrupted and information may not be transmitted.	-

6.2.2. Distance Between Devices

Place the WDT within a 20 m radius (recommended line-of-site distance) of the WDR. If more distance is required, add another WDT to act as a relay.

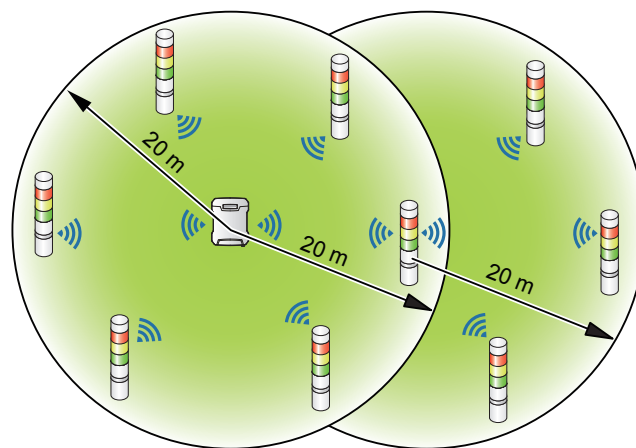

6.2.3. About the Influence of Surrounding Radio Waves

If the WD wireless network is affected by radio interference from electronics, microwave ovens, or other manufacturing equipment, normal operation may not be possible. Check the radio wave environment before installation and confirm there is no radio interference on the wireless radio bands you are planning to use.

Causes of Radio Interference	Description
Other wireless devices	Wireless devices using the same frequency or frequencies in the same neighborhood.
Noise from other equipment	Noise caused by power supply circuits, electronic circuits, or oscillators.
Noise from the surroundings	<ul style="list-style-type: none"> ▪ Noise from motors and engine equipment ▪ Noise from transmission lines, power supply equipment, and industrial equipment. ▪ Noise from microwave ovens and fluorescent lamps.
Surrounding obstacles*	Interference caused by phasing with own radio waves.

*Various obstacles (wall, floor, ceiling, pillar, equipment) may exist in the installation environment. The reception of radio waves changes depending on the relationship between the position of each device (WDR, WDT), obstacles, and the surrounding environment. As shown in the figure below, radio waves transmitted from a single point are delivered to each device (WDR, WDT) from multiple directions, such as when radio waves travel in a direct line, and when radio waves reflect off obstacles. Radio wave interference could be caused by this scenario, and operation may not be possible due to canceling radio waves.

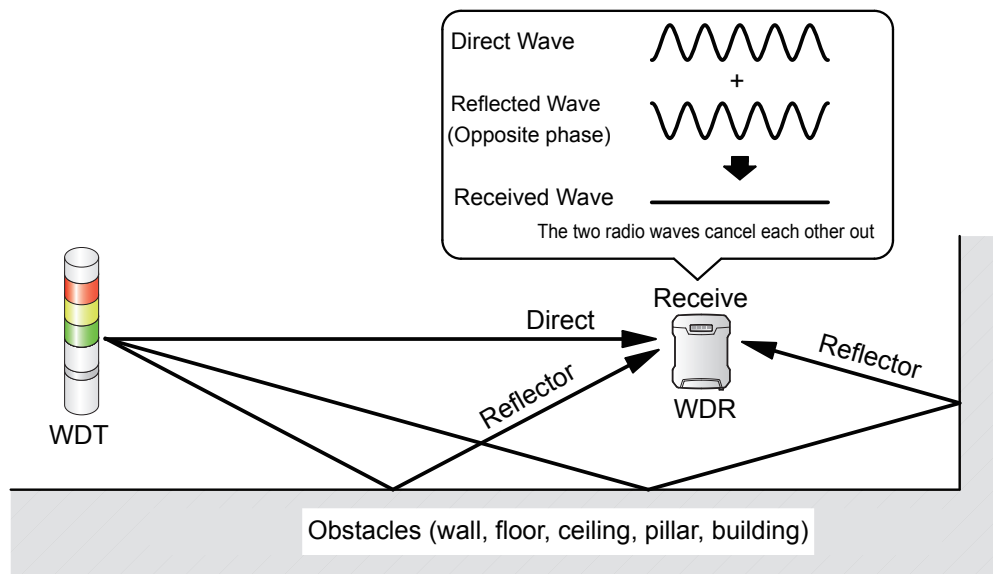

When wireless LAN and in-house PHS access points are installed in the surrounding environment, install WDR so they are 5 to 10 m or more away from access points.

6.2.4. Ensuring Line of Sight

- Good line of sight for each device (WDR, WDT) and free of any obstacles – hereafter referred to as the Fresnel Zone – is required. The Fresnel zone is a three-dimensional space, whose size is estimated as shown in the following illustration.
- If you cannot establish the Fresnel zone, sometimes the available communication distance may be shorter than usual due to obstacles inhibiting communication.

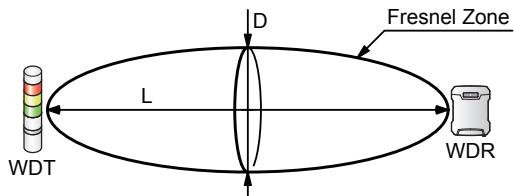

Figure 1

L	D
Line of sight distance	Fresnel zone diameter
20m	1.6m
10m	1.2m

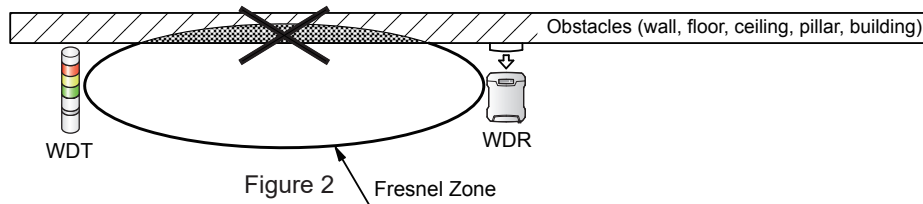

Figure 2

⚠ CAUTION

⚠ When installing on a metal plate or concrete wall, install the devices in the Fresnel zone so they are free of any obstacles.

6.2.5. WDR Installation Position and Obstacles

- When onto a pillar such as the I-beam in a building, install the WDR in a direction that promotes the propagation of radio waves.
- When using the WDR in a box, use a resin box with radio wave permeability.

6.2.6. About the Signal Tower Power Supply Status

To operate this product, you need to constantly supply power to the LR series signal tower's power line. For information, refer to "8.1.1. WDR Wiring Method" (👉 page 86).

6.3. Installation Steps

This section describes the steps for setting up and installing equipment. Refer to this manual as well as instruction manuals of related products.

6.3.1. Setup Information

Have the information for the settings below prepared beforehand.

Information required	Description		References
Information about the equipment to connect	Equipment name and other equipment identification information		-
Information about the Signal Tower	Model, power supply specifications, operation information		-
WDT and WDR common settings	Wireless settings	ExtendedPanID	☞ "6.1.3. About Grouping and ExtendedPanID" (page 35)
		Wireless channels	☞ "6.1.1. About the WD Wireless Network" (page 34)
WDT settings	Run time settings	Determine Signal Tower Input	☞ "9.1.2.1. Determine Signal Tower Input" (page 114)
		Power Supply Settings	*1
		Simple Counter Settings	☞ "9.1.1.5. Simple Counter Function" (page 113)
		Transmission Mode	☞ "9.1.1. Wireless Data Transmission Function" (page 111)

Information required	Description		References
WDR setup information	Network Setup	IP Address Configuration	☞ "7.4.2.1. Network Setup" (page 58)
		IP address* ²	
		Subnet Mask	
		Default Gateway	
		DNS Server Address	
		Host Name	
	Clock Settings	NTP Server Address	☞ "7.4.2.2. Clock Settings" (page 59)
		Correction Interval (minutes)	
		Timezone	
	User Authentication Settings	User Name	☞ "7.4.2.3. User Authentication Settings" (page 62)
		Password	
	Security Settings	Communication Method	☞ "7.4.2.4. Security Settings" (page 63)
	Socket Communication Setting* ³	Setting Port	☞ "7.4.3.1. Socket Communication Settings" (page 64)
		WDR-PRO Port 1	
WDR-PRO Port 2			
WDR Port			

Information required	Description		References
WDR setup information	Database Communication Setting* ³	Database Communication Function	☞ "7.4.3.2. Database Communication Setting" (page 66)
		Database Address	
		Database Port Number	
		Database Name	
		User Name	
		Password	
	Modbus/TCP Communication Setting* ³	Port Number	☞ "7.4.3.3. Modbus/TCP Communication Settings" (page 68)
	Cloud Communication Settings* ³	Cloud Communication Function	☞ "7.4.3.4. Cloud Communication Settings" (page 69)
		Region	
		Region Identifier	
		Domain	
		Client ID	
		Client Secret	
		Root Certificate 1	
		Root Certificate 2	
Select Information			
Receiver Wireless Settings	ExtendedPanID	☞ "7.4.4.1. Receiver Wireless Settings" (page 72)	
	Frequency Channel		
	Network Startup Method* ⁴		

*1 For information, refer to ☞ "WDS-WIN01 Instruction Manual".

*2 When not using DHCP, prepare beforehand the number of IP addresses required for use with the WDR.

*3 Set up the Socket Communication Setting, Database Communication Setting, Modbus/TCP Communication Setting, and Cloud Communication Settings only when they are used.

*4 For network startup method, use [Auto Start (Recommended)].

6.3.2. Equipment Settings

Using the setup information in "6.3.1. Setup Information", prepare the equipment. For system configuration when setting up equipment, refer to "5.2.3. Example System Configuration When Setting Up Equipment (using the Setup Kit)" (☞ page 28).

6.3.2.1. Set Up WDT

- Use the WDT system configuration software WDS-WIN01. Install WDS-WIN01 on the maintenance PC and set up the equipment. For using WDS-WIN01, refer to ☞ "WDS-WIN01 Instruction Manual".
- The setup procedure is as follows.

STEP 1 Prepare required equipment and create maintenance environment

This manual

"5.2.3. Example System Configuration When Setting Up Equipment (using the Setup Kit)" (☞ page 28)

STEP 2 Turn ON the WDR

This manual

"8.2.5. Checking the WDR Status Lamp" (☞ page 105)



After power is turned on, the WDR takes approximately 50 seconds to complete startup. Check the WDR status lamp to confirm startup is complete.

STEP 3 Set the network between the WDR and maintenance PC

WDS-WIN01 Instruction Manual

"6.1.1. WDR Network Settings"



When connecting to the WDR for the first time via LAN, set the IP address of the maintenance PC to 192.168.10.* (value other than 1).

STEP 4 Start WDS-WIN01 on the maintenance PC

WDS-WIN01 Instruction Manual

"5.3. Starting WDS-WIN01"

STEP 5 Turn ON the WDT and check the WDT wireless status with its indicator

This manual

"8.1.5. Checking Operations with WDT-PRO Indicator" (☞ page 94)

STEP 6 Set up WDT

This manual

"7.4.4.2. Wireless Settings List" (☞ page 73)

"8.1.3.2. Setup Items" (☞ page 91)

"8.1.3. Setting up the WDT Main Unit" (☞ page 91)

WDS-WIN01 Instruction Manual

"6.1.2. Set Up WDT"



To configure WDT, WDT and WDR must have a wireless connection. When the WDT and WDR are not connected wirelessly, initialize the WDT. For information, refer to "8.1.6. Initializing the WDT" (☞ page 95).

6.3.2.2. Set Up WDR

- Use the WDR Web setup screen for the WDR device settings.
- The setup procedure is as follows.

! CAUTION

! When configuring the WDR settings, connect with a LAN cable.

STEP 1 Turn ON the WDR

This manual

"8.2.5. Checking the WDR Status Lamp" (☞ page 105)



After power is turned on, the WDR takes approximately 50 seconds to complete startup. Check the WDR status lamp to confirm startup is complete.

STEP 2 Set up WDR User Authentication

This manual

"7.1. Set Up the User Name and Password for the WDR's Web Setup Screen" (☞ page 49)



After setting up user authentication, to log in again start from step 3. If user authentication is not set up, you cannot proceed to the login screen.

STEP 3 Log in to the WDR Web Setup Screen

This manual

"7.2. Display WDR Web Setup Screen" (☞ page 51)

STEP 4 Set the WDR network*, time, and user authentication

This manual

"7.4.2. System Settings" (☞ page 58)

*Set the IP address last.

STEP 5 Set WDR Wireless Settings

This manual

"7.4.4.1. Receiver Wireless Settings" (☞ page 72)

*Set up also possible with system configuration software WDS-WIN01. For using WDS-WIN01, refer to ☞ "WDS-WIN01 Instruction Manual".

*For WDR-L(E)-Z2-PRO-L, set with system configuration software WDS-WIN01.

STEP 6 Set WDR Host Communication Settings

When Run Using Socket Communication

This manual

"7.4.3.1. Socket Communication Settings" (☞ page 64)

When Run Using Database Communication

This manual

"7.4.3.2. Database Communication Setting" (☞ page 66)

When Run Using Modbus/TCP Communication

This manual

"7.4.3.3. Modbus/TCP Communication Settings" (☞ page 68)

When Run Using Cloud Communication

This manual

"7.4.3.4. Cloud Communication Settings" (☞ page 69)

6.3.3. Installation Steps

CAUTION

- ❗ When deciding the installation location of each device, carefully review the following procedure regarding installation location. The installation location could cause problems such as unstable operation or communication failure.
- ❗ Install devices only after equipment setup is complete.

6.3.3.1. WDT Installation

STEP 1 Wire the LR Signal Tower

This manual

"8.1.1. WDR Wiring Method" ( page 86)

STEP 2 Attach WDT to the LR Signal Tower

This manual

"8.1.2.1. Installing to and Removing from LR Series Signal Tower" ( page 88)

STEP 3 Attach LED Unit and Buzzer Unit to LR Signal Tower

This manual

"8.1.2.2. Attaching the LED Unit and Buzzer Unit" ( page 90)

6.3.3.2. WDR Installation

STEP 1 Install WDR to the mounting surface

This manual

"8.2.1. WDR Mounting Method" ( page 96)

STEP 2 Wire the WDR

This manual

"8.2.2. WDR Wiring Method" ( page 98)

6.3.3.3. Check WDT and WDR Connection

Construct the operation environment. For information, refer to "5.2.2. WD System Configuration at Run Time" (☞ page 23).

STEP 1 Turn ON the WDT and WDR

This manual

"8.2.5. Checking the WDR Status Lamp" (☞ page 105)



After power is turned on, the WDR takes approximately 50 seconds to complete startup. Check the WDR status lamp to confirm startup is complete.

STEP 2 Check the WDT wireless status with its indicator

This manual

"8.1.5. Checking Operations with WDT-PRO Indicator" (☞ page 94)

6.3.3.4. Using WDS-WIN01 with CSV File

STEP 1 Use WDS-WIN01 to set the data save destination

WDS-WIN01 Instruction Manual

"6.2.2. Data Save Destination and CSV File Format Settings"

STEP 2 Use WDS-WIN01 to set the CSV file format

WDS-WIN01 Instruction Manual

"6.2.2. Data Save Destination and CSV File Format Settings"

STEP 3 Use WDS-WIN01 to start collecting

WDS-WIN01 Instruction Manual

"6.2.4. WDR Registration and Starting Collection"

6.3.4. Maintenance

While in operation, you can check things such as the wireless environment for the WDT and WDR, and the WDT input status.

Check the wireless environment when installed

This manual

"7.4.4.3. Wireless Connection Diagnosis" ([☞](#) page 76)
"9.2.2. Self Diagnosis Function" ([☞](#) page 121)

Function for checking the input status of the WDT Signal Tower Control Line

This manual

"7.4.4.4. Status Check" ([☞](#) page 78)

6.3.5. Replace WDR-L(E)-Z2

When replacing the WDR-L(E)-Z2, follow the steps below.

6.3.5.1. Set Up WDR

STEP 1 Prepare required equipment and create maintenance environment

This manual

"5.2.2.2. Socket Communication System Configuration Example" ([☞](#) page 24)



- When setting up only the WDR, WDT preparation is not required.



- When configuring the WDR settings, connect with a LAN cable. You cannot set the WDR when a USB cable is connected.

STEP 2 Set up the maintenance PC network



The default IP address is different on WDR-L(E)-Z2 and WDR-L(E)-Z2-PRO (-L).

- WDR-L(E)-Z2: 192.168.0.1
- WDR-L(E)-Z2-PRO(-L): 192.168.10.1

STEP 3 Turn ON the WDR

This manual

"8.2.5. Checking the WDR Status Lamp" ([☞](#) page 105)



After power is turned on, the WDR takes approximately 50 seconds to complete startup. Check the WDR status lamp to confirm startup is complete.

STEP 4 Log in to the WDR Web browser screen

This manual

"7.1. Set Up the User Name and Password for the WDR's Web Setup Screen" ([☞](#) page 49)

"7.2. Display WDR Web Setup Screen" ([☞](#) page 51)

STEP 5 Set the WDR network*, time, and user authentication

This manual

"7.4.2. System Settings" ([☞](#) page 58)

*Set the IP address last.

STEP 6 Set WDR Wireless Settings

This manual

"7.4.4.1. Receiver Wireless Settings" ([☞](#) page 72)

*For WDR-L(E)-Z2-PRO-L, set with system configuration software WDS-WIN01.

6.3.5.2. WDR Installation

STEP 1 Remove the existing WDR-L(E)-Z2

STEP 2 Install WDR to the mounting surface

This manual

"8.2.1. WDR Mounting Method" ( page 96)

STEP 3 Wire the WDR

This manual

"8.2.2. WDR Wiring Method" ( page 98)



When using an AC Adaptor, make sure you use the AC Adaptor that comes with WDR-L-Z2-PRO(-L) or the AC Adaptor optional part, not the AC Adaptor that comes with WDR-L-Z2.

6.3.5.3. Check WDT and WDR Connection

STEP 1 Turn ON the WDT and WDR

This manual

"8.2.5. Checking the WDR Status Lamp" ( page 105)



After power is turned on, the WDR takes approximately 50 seconds to complete startup. Check the WDR status lamp to confirm startup is complete.

STEP 2 Check the WDT wireless status with its indicator

This manual

"8.1.5. Checking Operations with WDT-PRO Indicator" ( page 94)

7. WDR Setup Process

To specify the various settings on this product, a user name and password are required.

After purchase, the first time you open the Web browser the [User Authentication Settings] screen appears. Set up the user name and password.

7.1. Set Up the User Name and Password for the WDR's Web Setup Screen

When the user name and password are not set up, the [User Authentication Settings] screen will appear. Set up the user name and password. After the user name and password are set up, the login screen will appear when opening the Web browser.

⚠ CAUTION

❗ Do not forget the user name and password. If you cannot remember either one, login will not be possible. In the unlikely event you cannot remember the user name and password, run initialization and set up the user name and password again.

After turning on the power and startup is complete, refer to "7.2. Display WDR Web Setup Screen" (📖 page 51) and start the web browser.

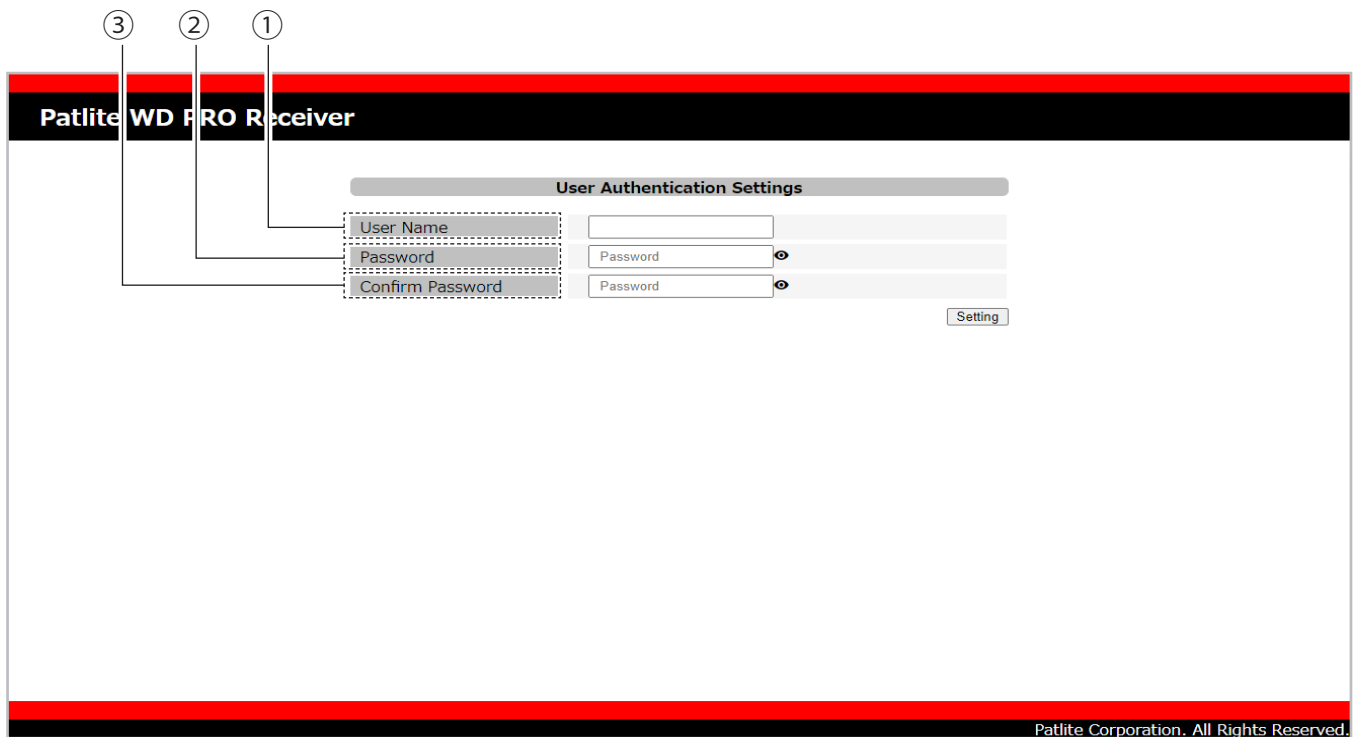

No.	Item	Description	Default Value	Input range	Setup optional
①	User Name	Set a User Name.	(Blank)	Up to 16 single-byte alphanumeric characters and symbols	x
②	Password	Set a Password.	(Blank)	Up to 16 single-byte alphanumeric characters and symbols	x
③	Confirm Pasword	Set a Password. (for confirmation)	(Blank)	Up to 16 single-byte alphanumeric characters and symbols	x

- 1** In the [User Name] field, enter the desired user name.
- 2** In the [Password] field, enter the desired password.
- 3** In the [Confirm Password] field, enter the password again.
- 4** Click [Setting] to update with the defined settings.

Note: When logging in, use the set user name and password.

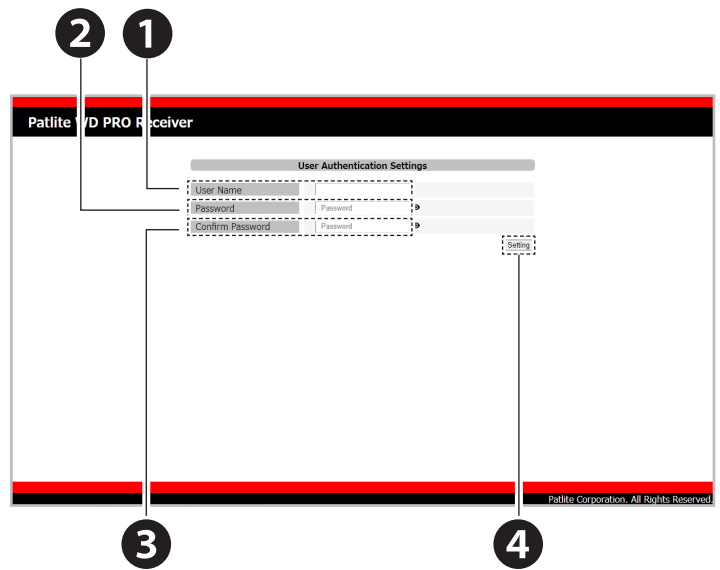

7.2. Display WDR Web Setup Screen

For the various settings of this product, log in from a Web browser.

Supported browsers are Google Chrome, Microsoft Edge, and Internet Explorer 11.

After turning on the power and startup is complete, start the Web browser and in the address bar enter the IP address of this product. The default address for this product is **192.168.10.1**.

CAUTION

- When using WDR with USB communication, you cannot view the Web Setup Screen. Make sure you use LAN communication.

Point

- If the login screen does not appear or does not display correctly, refer to "10.1. Troubleshooting" ( page 123).
- If characters are garbled on the screen and do not display correctly, change the Web browser character encoding to Unicode (UTF-8).
- To prevent set up from multiple locations, this product prevents double login. (When you try to log in simultaneously from different locations, the [Check Login Screen] below appears.)

Check Login Screen

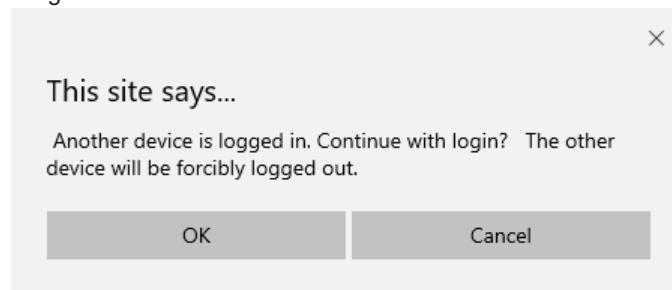

- You can use a pull-down menu from the top-right corner of the login screen to select the display language. You can select from three languages: [Japanese], [English], and [Simplified Chinese]. [English] is the default setting.

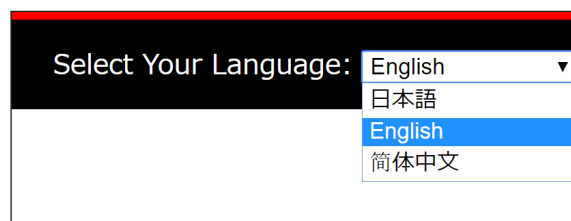

1 In the Web browser address bar, enter the IP address set for this product.

2 Enter the user name.*

*The default user name is patlite. Change to prevent unauthorized operation.

3 Enter the password*, and log in.

The default password is patlite. Change to prevent unauthorized operation.

The screenshot shows the login interface for the Patlite WDR PRO Receiver. At the top, there is a black navigation bar with the product name 'Patlite WDR PRO Receiver' on the left and a language selection dropdown set to 'English' on the right. The main content area is white and features a login form. The form includes two input fields: 'User Name' and 'Password'. The 'Password' field has a small eye icon to its right for toggling visibility. Below the input fields is a 'login' button. A dashed rectangular box encloses the 'User Name' and 'Password' fields. A vertical line with a horizontal branch at the top points to this dashed box, with the number '2' above it. To the right of this line, the number '3' is placed above the 'Password' field, indicating the steps for entering the user name and password.

7.3. WDR (Receiver) Web Setup Screen

After login, go to the WDR Web Setup Screen.

⚠ CAUTION

- ❗ [Database Communication], [Modbus/TCP Communication], [Cloud Communication], [Receiver Wireless Settings], [Wireless Settings List], [Status Check], and [Transmitter Username Registration] do not display on WDR-L(E)-Z2-PRO-L.
- ❗ After completing setup, either reboot or cycle the power.
- ⚠ Do not use the [Back] button in your browser. An error screen may display or the settings may not be applied properly. Operate with buttons on the Web Setup screen.

Point

- To view each setting, click the item you want to set. The selected set up screen is displayed.
- If you want to move from one of the various setting screens to another setting screen, click the item you want to set.

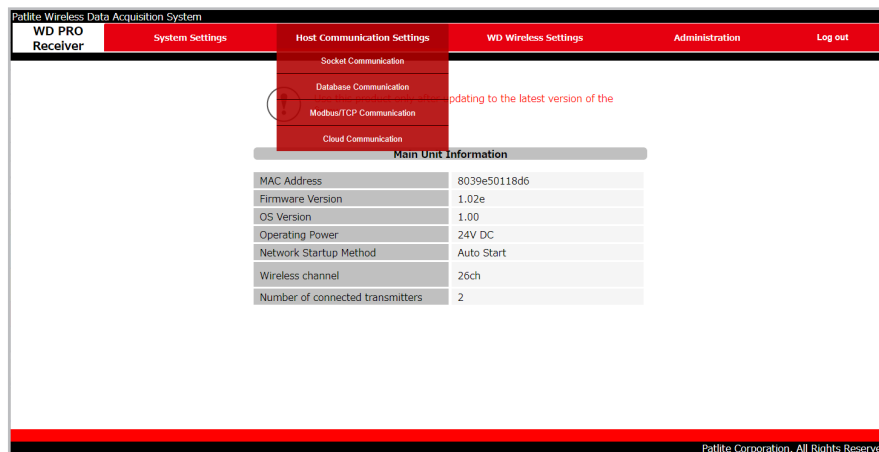

- To log out from the Web Setup Screen, in the Logout Screen click [Logout].

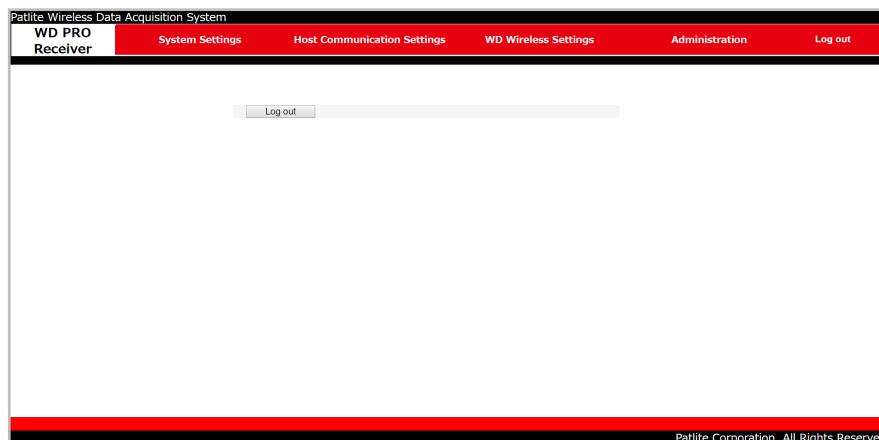

Point

- If a value cannot be set or an incorrect operation is performed, an error screen as shown below will display.

Error Screen Example

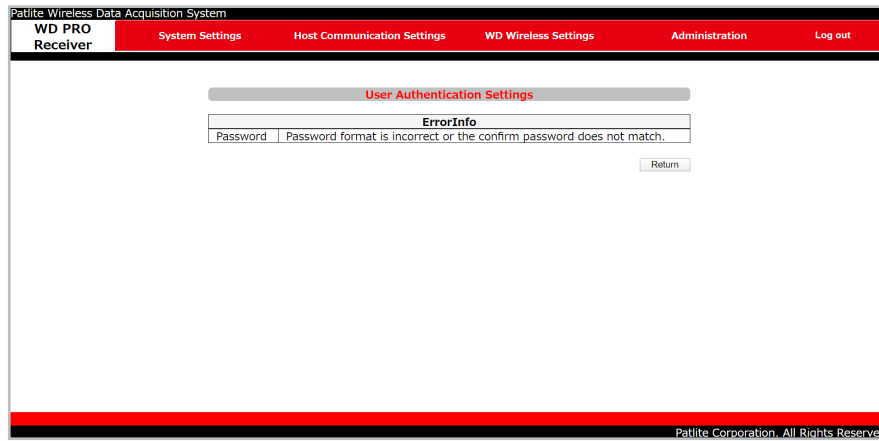

- You can enter the following symbols in locations that accept symbols.

Hyphen*	-
Period*	.
Sharp*	#
Percent	%

Comma	,
Asterisk	*
Plus	+
Underscore	_

*Cannot use as the first character.

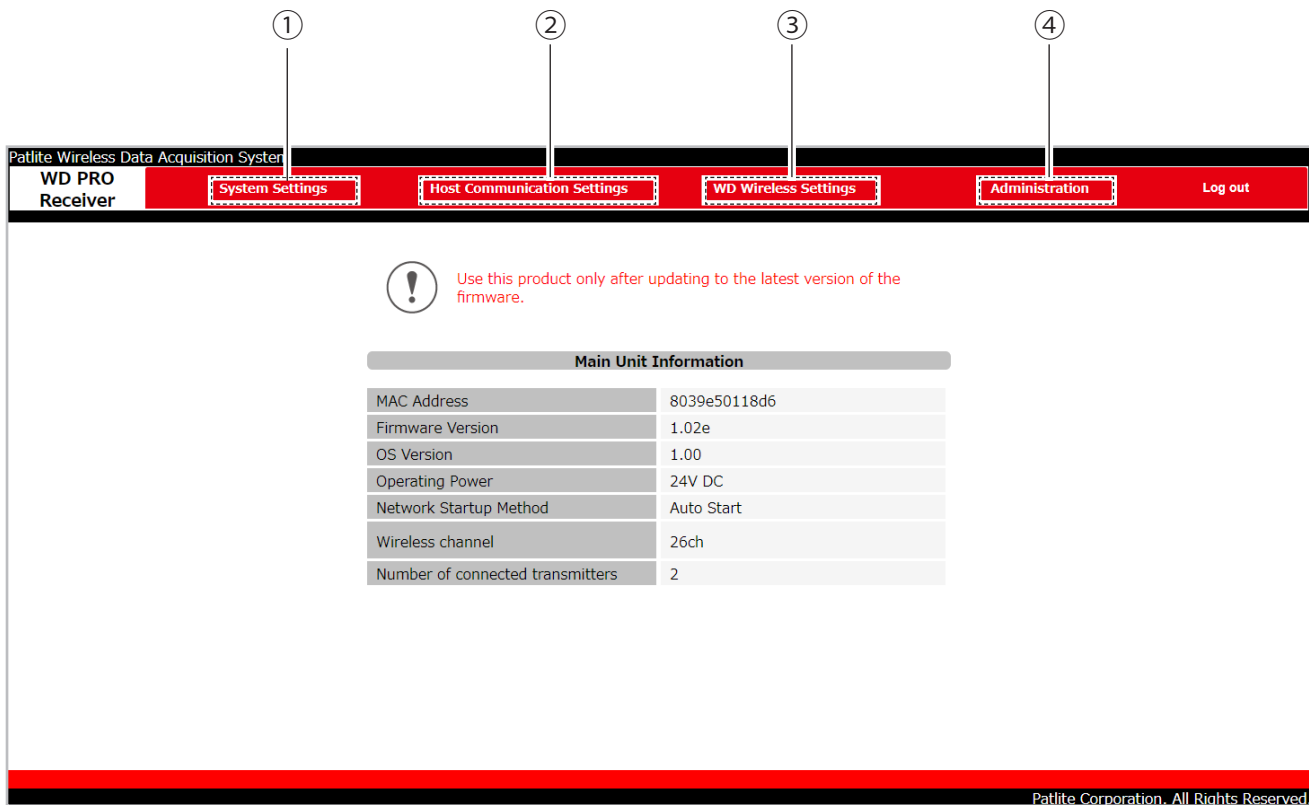

No.	Item	Description	References
①	System Settings	You can change the [Network Setup], [Clock Settings], [User Authentication Settings], and [Security Settings].	☞ "7.4.2. System Settings" (page 58)
②	Host Communication Settings	Configure various settings for [Socket Communication], [Database Communication], [Modbus/TCP Communication], and [Cloud Communication].	☞ "7.4.3. Host Communication Settings" (page 64)
③	WD Wireless Settings	Configure various settings and displays for [Receiver Wireless Settings], [Display Wireless Settings List], [Wireless Connection Diagnosis], [Check Status], and [Register Transmitter User Name].	☞ "7.4.4. WD Wireless Settings" (page 72)
④	Administration	Run various operations and displays for [Main Unit Information], [Update Firmware], [Initialize], and [Reboot].	☞ "7.4.5. Administration" (page 81)

7.4. WDR (Receiver) Various Settings

7.4.1. Setup Items

Setup items are as follows.

Setup Item		Default Value	References
System Settings	Network Setup	IP Address Configuration	Set up manually
		IP Address	192.168.10.1
		Subnet Mask	255.255.255.0
		Default Gateway	0.0.0.0
		DNS Server Address	0.0.0.0
		Host Name	wdr-pro
	Clock Settings	NTP Server Address	0.0.0.0
		Correction Interval (minutes)	60
		Timezone	UTC+9
	User Authentication Settings	User Name	patlite
		Password	patlite
	Security Settings	Communication Method	HTTP
Host Communication Settings	Socket Communication* ¹	Setting Port	10000
		WDR-PRO Port 1* ²	10002
		WDR-PRO Port 2* ²	10003
		WDR Port	10001
	Database Communication Setting* ¹	Database Communication Function* ²	Do not use
		Database Address* ²	(None)
		Database Port Number* ²	3306
		Database Name* ²	(None)
		User Name* ²	(None)
	Modbus/TCP Communication Setting* ¹	Password* ²	(None)
		Port Number* ²	502
	Cloud Communication Settings* ¹	Cloud Communication Function* ²	Do not use
		Region* ²	Europe 1
		Region identifier* ²	eu1
		Domain* ²	mindsphere.io
		Client ID* ²	(None)
Client Secret* ²		(None)	
Root Certificate 1* ²		Not set	
Root Certificate 2* ²		Not set	
Select Information* ²	Select all		

Setup Item		Default Value	References
WD Wireless Settings	Receiver Wireless Settings	ExtendedPanID	0000 0000 0000 0000
		Frequency Channel	Select all
		Network Startup Method	Auto Start (Recommended)
			☞ "7.4.4.1. Receiver Wireless Settings" (page 72)

*1 Set up the Socket Communication Setting, Database Communication Setting, Modbus/TCP Communication Setting, and Cloud Communication Settings only when they are used.

*2 Cannot set on the WDR-L-Z2-PRO-L or WDR-LE-Z2-PRO-L.

7.4.2. System Settings

7.4.2.1. Network Setup

In the Network Setup screen, change the network settings.

⚠ CAUTION

⚠ If the IP Address Configuration is set to the [Get automatically] option but access to the DHCP server is unavailable, the product starts up with the factory default network settings. With the [Get automatically] option, the DHCP function is enabled on rebooting the WDR.

Point

- After entering the network settings, click [Set] to update with the defined settings. Click [Set] to automatically reboot the network.

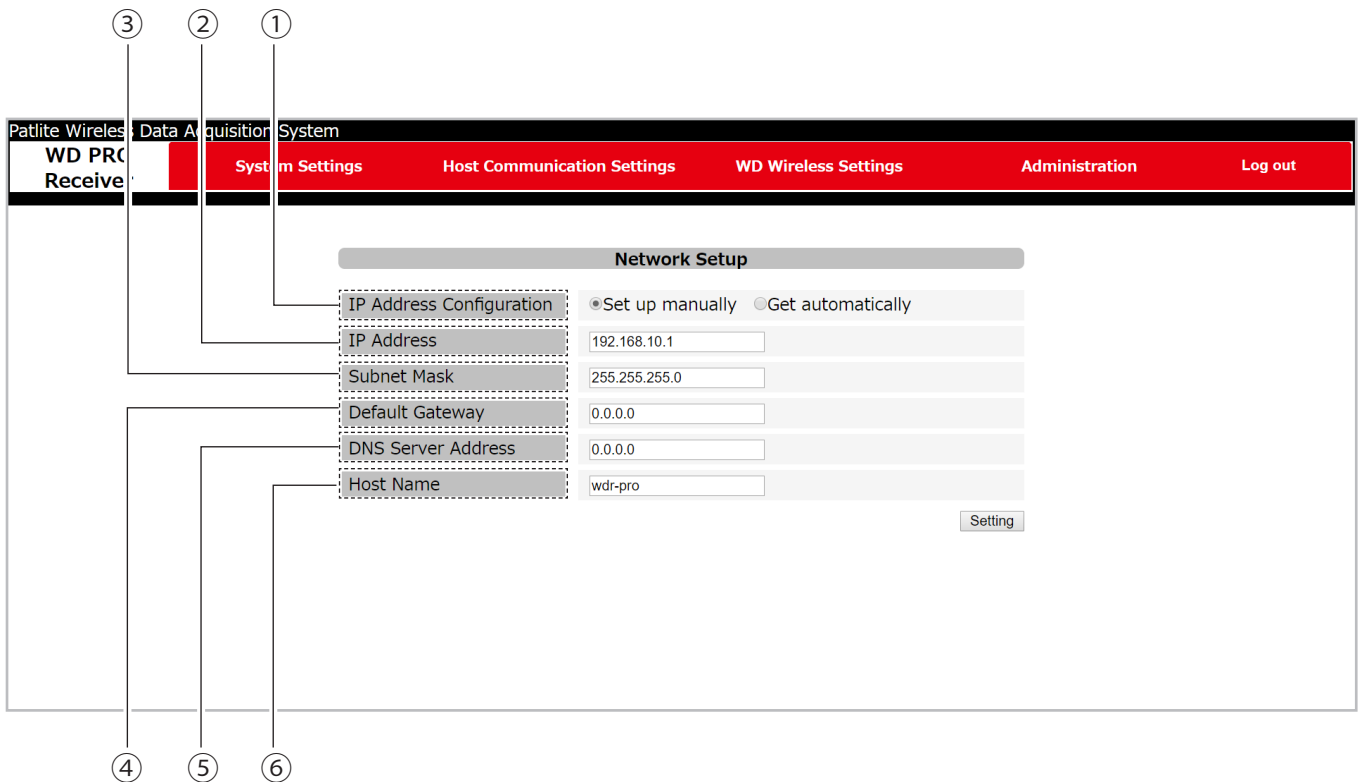

No.	Item	Default Value	Input range	Description
①	IP Address Configuration	Set up manually	Set up manually / Set up automatically	When using the DHCP function to get network information, select [Get automatically].
②	IP Address	192.168.10.1	IP address format	Cannot set when the IP Address Configuration is [Get automatically].
③	Subnet Mask	255.255.255.0		
④	Default Gateway	0.0.0.0		
⑤	DNS Server Address	0.0.0.0		
⑥	Host Name	wdr-pro	63 single-byte alphanumeric characters	Enter the product's host name.

7.4.2.2. Clock Settings

Set the clock on this product. There are two ways to set the clock on the product.

Host Computer Clock: Displays the time set on the computer.

Receiver Clock: Displays the time set on the product.

Patlite Wireless Data Acquisition System

WD PRO Receiver

System Settings Host Communication Settings WD Wireless Settings Administration Log out

Clock Settings

Receiver Clock 2020/1/9 19:15:48

Host Computer Clock 2020/1/9 19:16:21

PC Set Time

NTP Server Address 0.0.0.0

Correction Interval (10-1440 minutes) 60

Timezone UTC+9

NTP Settings

Patlite Corporation. All Rights Reserved

① ② ③

No.	Item	Description	Default Value	Input range	Setup optional
①	NTP Server Address	Set the NTP server address.*	0.0.0.0	IP address format, or host name up to 63 characters	○
②	Correction Interval (minutes)	Set the interval for NTP server communication.	60	10 to 1440	x
③	Timezone	Set the timezone.	UTC+9	All time zones, from [UTC-12] to [+14]	x

* When you do not use a NTP server, leave the NTP server address either blank or set to 0.0.0.0.

Show the time of the logged-in PC on this product

- 1 Click [PC Set Time].

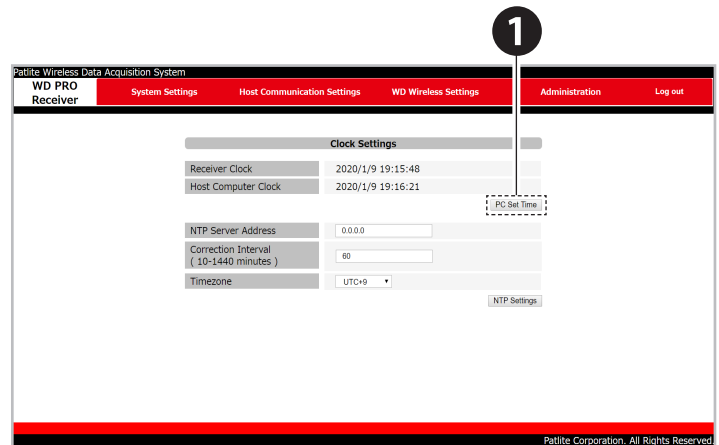
**⚠ CAUTION**

- ⚠ When basing the time on the PC clock, the time may be off by several seconds from the actual PC clock.
- ❗ If you do not use a NTP server, periodically check and correct the time on the product.
- ⚠ This product uses a capacitor to back up time information.
- ❗ If there is no power for about half a day, the defined time may shift or it may be reset depending on the charge on the capacitor. When operating in an environment that requires accurate time information, set the time before you begin operations.
- ⚠ If the backup expires and the clock is reset, it will show January 1, 1970.

Communicate with NTP server and adjust the time on this product

- 1 In the [NTP Server Address] field, enter either the NTP server address or its host name.
 - 2 In the [Correction Interval (minutes)] field, enter the interval of NTP server communications.
 - 3 Set the timezone*.
- *For timezone settings, refer to the table below.
- 4 Click the [NTP Settings] button to update with the defined setting.

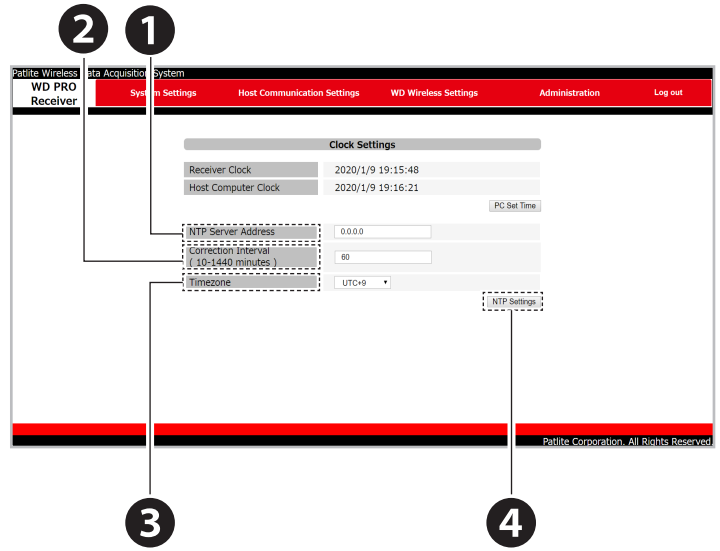

The relationship between the timezone setting and representative cities is as follows. Refer to the table for settings.

Setting	Name of representative city
UTC-12	Baker Island
UTC-11	Midway Island
UTC-10	Honolulu
UTC-9	Anchorage
UTC-8	Los Angeles
UTC-7	Denver
UTC-6	Chicago / Mexico City
UTC-5	New York / Ottawa
UTC-4	Santo Domingo
UTC-3	Rio de Janeiro
UTC-2	Fernando de Noronha
UTC-1	Azores
UTC	London

Setting	Name of representative city
UTC+1	Paris / Berlin
UTC+2	Cairo
UTC+3	Jeddah
UTC+4	Dubai
UTC+5	Karachi
UTC+6	Dhaka
UTC+7	Bangkok / Jakarta / Hanoi
UTC+8	Beijing / Taipei / Singapore / Manila / Kuala Lumpur
UTC+9	Tokyo / Seoul
UTC+10	Sydney
UTC+11	Nouméa
UTC+12	Wellington
UTC+13	Nuku'alofa
UTC+14	Christmas Island

⚠ CAUTION

⊘ Regardless of the timezone setting, do not use this product outside of supported countries and regions.

7.4.2.3. User Authentication Settings

You can set user names and passwords for logging in to the WDR Web Setup Screen. After completing setup, you can use the new user names and passwords from the next login.

CAUTION

! Change the user name and password to prevent unauthorized operation.

No.	Item	Description	Default Value	Input range	Setup optional
①	User Name	Set the new user name.	(Displays the currently set user name)	Up to 16 single-byte alphanumeric characters and symbols	x
②	Password	Set a new password.	(Blank)	Up to 16 single-byte alphanumeric characters and symbols	x
③	Confirm Password	Set a new password. (for confirmation)	(Blank)	Up to 16 single-byte alphanumeric characters and symbols	x

- 1** In the [User Name] field, enter the user name you would like to use.
- 2** In the [Password] field, enter the password you would like to change.
- 3** In the [Confirm Password] field, again enter the password you would like to change.
- 4** Click [Setting] to update with the defined settings.

Note: The next time you log in, log in with the new user name and password.

7.4.2.4. Security Settings

You can select the protocol used for the WDR Web Setup Screen and communication.

⚠ CAUTION

⚠ If you select https communication, when you access the Web Setup Screen or display a pop-up, sometimes an error screen with a message such as "This site is not secure" or "This connection does not protect privacy" will appear. In the browser, click the [Details] link then click [Go to Web page] to access the Web Setup Screen. (The displayed text differs depending on your browser and browser version.)

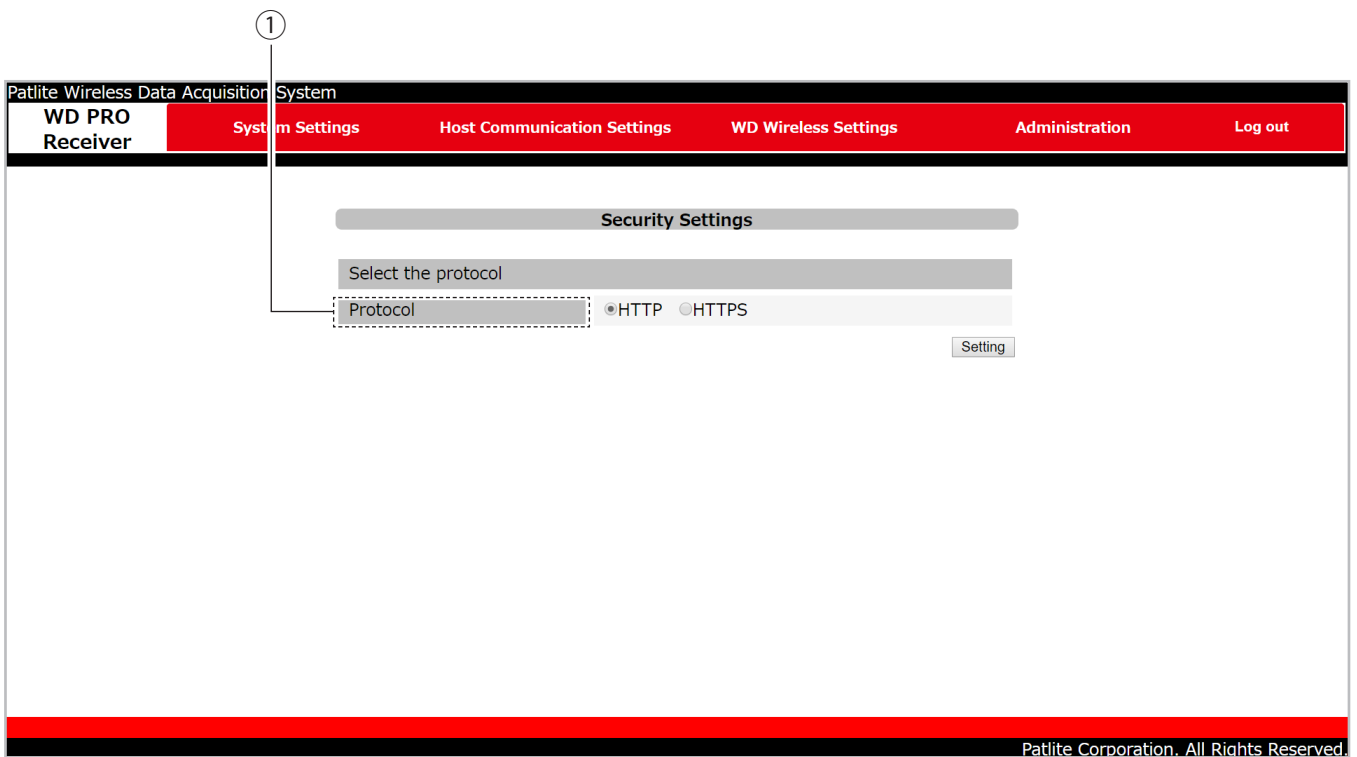

No.	Item	Description
①	Protocol*	Select either [HTTP] or [HTTPS] communication.

*The default communication method is [HTTP].

*To download the SSL server certificate, click the [Download] button.

- 1** Select either [HTTP] or [HTTPS] communication.
- 2** Click [Setting] to update with the defined settings.

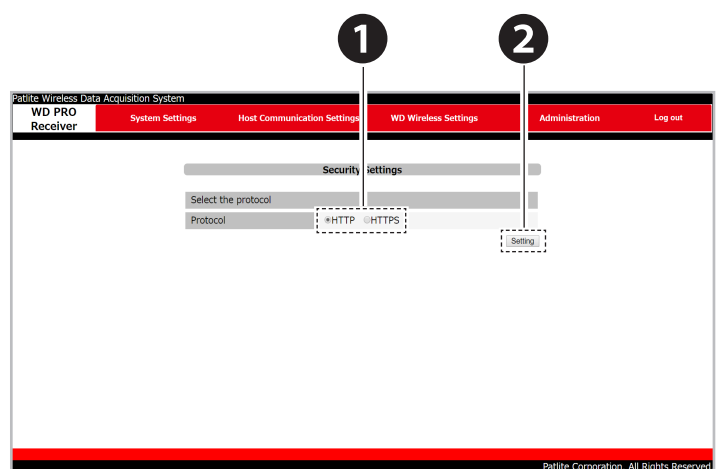

7.4.3. Host Communication Settings

7.4.3.1. Socket Communication Settings

Set the socket communication port number used for Host Communication. For information about the function, refer to "9.2.1.1. Socket Communication" (page 117).

⚠ CAUTION

- ❗ Set up only after checking port numbers in the [Socket Communication] and [Modbus/TCP Communication] settings are not duplicated. If port numbers are duplicated, an error screen will appear.
- ⚠ While using Cloud Communication, you cannot use WDR-PRO Port 1, WDR-PRO Port 2, and the WDR Port.
- ⚠ When you want to use the Settings port, select the Settings port's [Use] option.

Point

- When using WDS-WIN01, use the WDR port. While the WDR port is in use and you only need to use WDS-WIN01 for setup, you could use the Setting Port.

The screenshot shows the 'Socket Communication' configuration page. It features a navigation bar at the top with 'System Settings', 'Host Communication Settings', 'WD Wireless Settings', 'Administration', and 'Log out'. The main content area has four input fields, each with a radio button for 'Do not use' and 'Use'. Callouts 1 through 4 point to these fields: 1 points to 'Settings Port' (10000), 2 points to 'WDR-PRO Port 1' (10002), 3 points to 'WDR-PRO Port 2' (10003), and 4 points to 'WDR Port' (10001). 'Initialize' and 'Setting' buttons are at the bottom right.

No.	Item	Description	Default Value	Input range	Setup optional
①	Setting Port	Display and set the WDS-WIN01 setting port number.	10000	1024 to 65535	x
②	WDR-PRO Port 1*	Display and set the port number for the first WDR-PRO Port.	10002	1024 to 65535	x
③	WDR-PRO Port 2*	Display and set the port number for the second WDR-PRO Port.	10003	1024 to 65535	x
④	WDR Port	Display and set the port number for the WDR Port.	10001	1024 to 65535	x

*Cannot input on WDR-L-Z2-PRO-L and WDR-LE-Z2-PRO-L.

1 Enter the port number to use for the [Setting Port], [WDR-PRO Port 1], [WDR-PRO Port 2], and [WDR Port].

*Click the [Initialize] button to enter the default values for each port.

2 Click [Setting] to update with the defined settings.

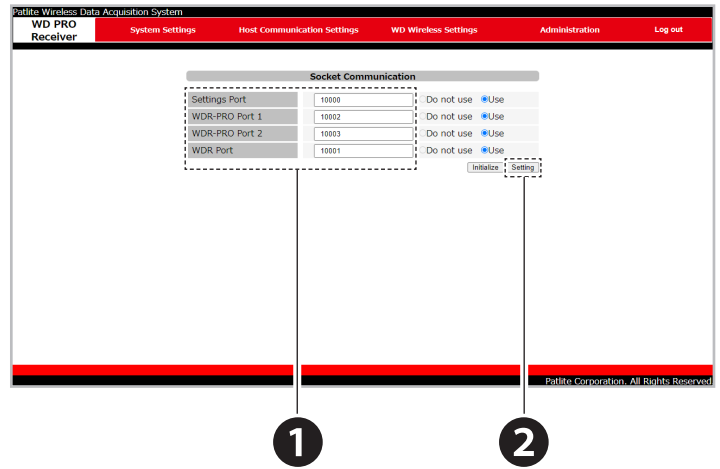

7.4.3.2. Database Communication Setting

Set the database to link. Using the set value, you can check the connection to the database. For information about the function, refer to "9.2.1.2. Database Communication" (page 118).

⚠ CAUTION

⚠ Cannot set up on WDR-L-Z2-PRO-L and WDR-LE-Z2-PRO-L.

⚠ While using cloud communication, you cannot use database communication.

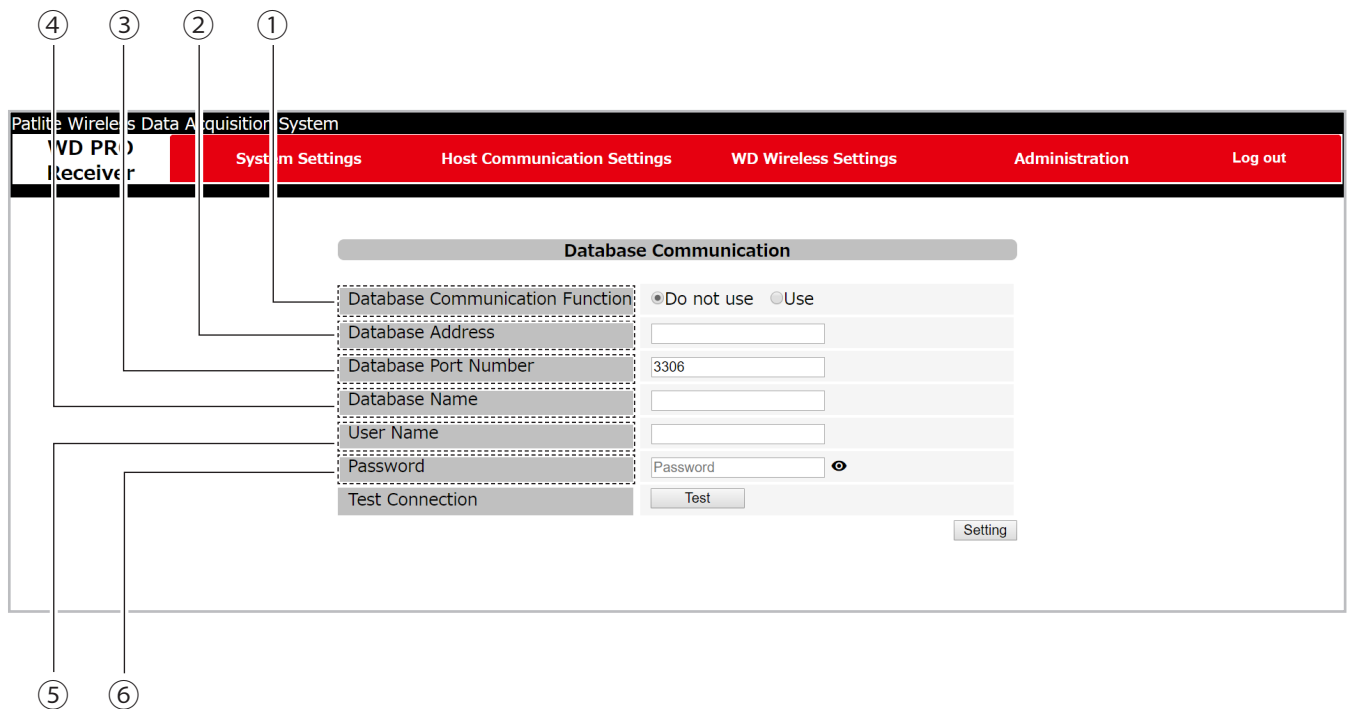

No.	Item	Description	Default Value	Input range	Setup optional
①	Database Communication Function	Select whether to use the Database Communication Function.	Do not use	Do not use / Use	x
②	Database Address	Display and set the database address.	(Blank)	IP address format, or host name up to 63 characters	x
③	Database Port Number	Display and set the database port number.	3306	1024 to 65535	x
④	Database Name	Display and set the database name.	(Blank)	Up to 16 single-byte alphanumeric characters and symbols	x
⑤	User Name	Display and set the database user name.	(Blank)	Up to 16 single-byte alphanumeric characters and symbols	x
⑥	Password	Display and set the database password.	(Blank)	Up to 16 single-byte alphanumeric characters and symbols	x

- 1 To use the Database Communication, select [Use].
- 2 In 1, if [Use] is selected, enter the [Database Address], [Database Port Number], [Database Name], [User Name], and [Password].
- 3 To run a Test Connection on the database, under [Test Connection] click the [Test] button and confirm it can connect to the database.
- 4 Click [Setting] to update with the defined settings.

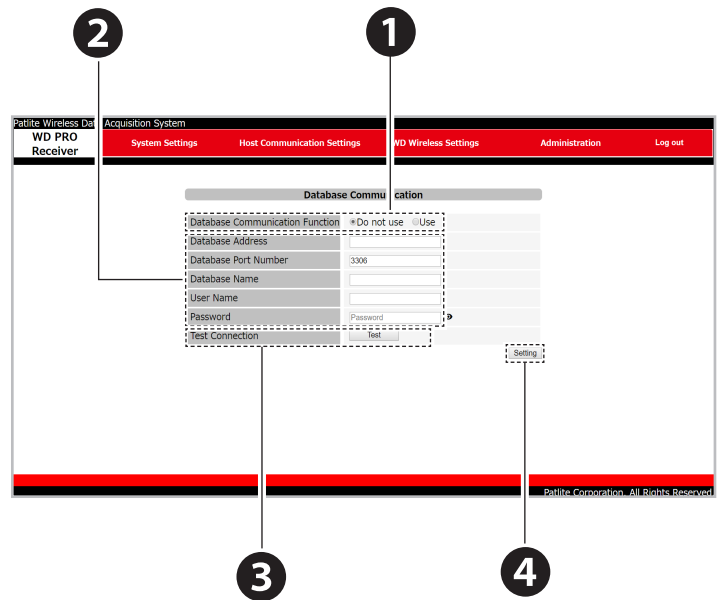

Point

- Under [Test Connection], by clicking the [Test] button you can confirm you can connect to the database with the set value. The check result appears on a pop-up screen.

7.4.3.3. Modbus/TCP Communication Settings

Set the port number used for Modbus/TCP.

⚠ CAUTION

- ⚠ Cannot set up on WDR-L-Z2-PRO-L and WDR-LE-Z2-PRO-L.
- ⚠ While using cloud communication, you cannot use Modbus/TCP communication.
- ⚠ Set up only after checking port numbers in the [Socket Communication] and [Modbus/TCP Communication] settings are not duplicated. If port numbers are duplicated, an error screen will appear.
- ⚠ In Modbus/TCP communication, only transmitters with registered Transmitter User Names can get data. On registering transmitter user names, refer to "7.4.4.5. Register Transmitter User Name" (page 79).

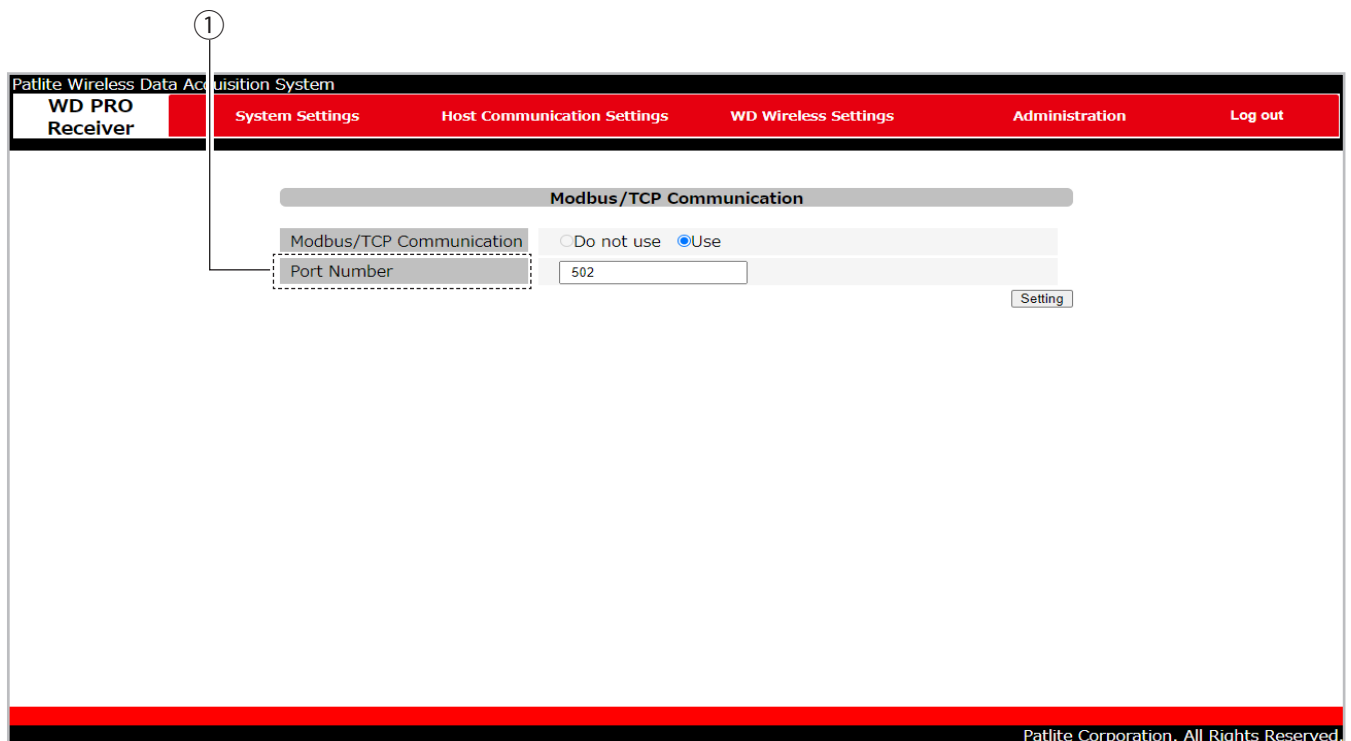

No.	Item	Description	Default Value	Input range	Setup optional
①	Port Number	Enter the port number to use for Modbus/TCP.	502	502, 1024 to 65535	x

- 1** In the [Port Number] field, enter the port to use.
- 2** Click [Setting] to update with the defined settings.

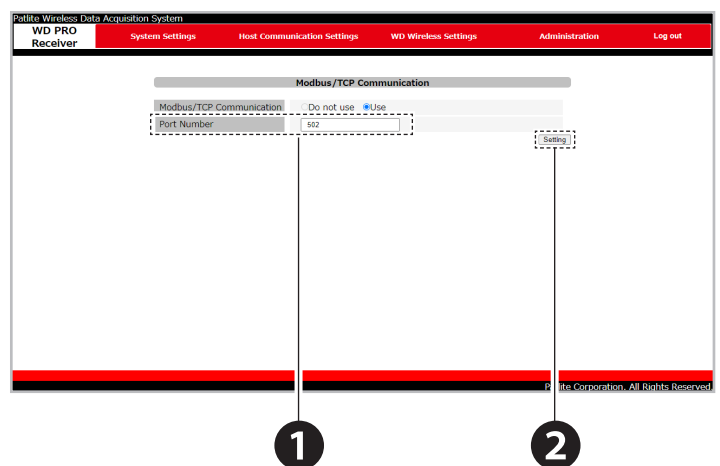

7.4.3.4. Cloud Communication Settings

When using with Cloud Communication, set the following.

⚠ CAUTION

- ⚠ Cannot set up on WDR-L-Z2-PRO-L and WDR-LE-Z2-PRO-L.
- ⚠ When using Cloud Communication, you cannot run [Socket Communication Settings], [Database Communication Settings], or [Modbus/TCP Communication Settings] at the same time.
- ❗ While using Cloud Communication, set up WDS-WIN01 only after setting the [Socket Communication] Settings Port to [Enable].
- ⚠ To run MindSphere Communication, a separate MindSphere license is required. For information, contact your nearest PATLITE sales representative.

Patlite Wireless Data Acquisition System

WD PRO Receiver

System Settings Host Communication Settings WD Wireless Settings Administration Log out

Cloud Communication

Cloud Communication Function	<input type="radio"/> Do not use <input checked="" type="radio"/> MindSphere
Region	Europe 1
Region identifier	eu1
Domain	mindsphere.io
ClientID	
Client Secret	
Root Certificate1	Not configured <input type="button" value="Choose File"/> No file chosen
Root Certificate2	Not configured <input type="button" value="Choose File"/> No file chosen
Select Information	<input checked="" type="checkbox"/> Signal Tower Information <input checked="" type="checkbox"/> External Input Information <input checked="" type="checkbox"/> Serial Information <input checked="" type="checkbox"/> Count Information <input checked="" type="checkbox"/> Signal Tower Control Information
MindSphere Communication Status	-

Patlite Corporation. All Rights Reserved.

No.	Item	Description	Default Value	Input range	Setup optional
①	Cloud Communication Function	Select whether to use or not to use the Cloud Communication function.	Do not use	Do not use / MindSphere	x
②	Region Information	Select the MindSphere region licensed by the user.	Europe1	Europe1 / Europe2 / China1	x
	Region Identifier Value	Automatically set when the Region Information is selected. Do not change.	eu1	Up to 20 single-byte alphanumeric characters and symbols	x
	Domain	Automatically set when the Region Information is selected. Do not change.	mindsphere.io	Up to 20 single-byte alphanumeric characters and symbols	x
③	Client ID* ¹	ID that is issued when MindSphere is licensed.	(Blank)	Up to 100 single-byte alphanumeric characters and symbols	x
④	Client Secret** ¹	Key that is issued when MindSphere is licensed.	(Blank)	Up to 50 single-byte alphanumeric characters and symbols	x
⑤	Root Certificate 1* ¹ * ²	Root certificate setup status for MindSphere communication via HTTPS.	Not set	Only legitimate certificate data is valid (text format)	x
⑥	Root Certificate 2* ¹ * ²	Root certificate (application) setup status for MindSphere communication via HTTPS.	Not set	Only legitimate certificate data is valid (text format)	○
⑦	Select Information	Select the information for MindSphere communication.	(Select all)	Signal Tower Information / External Input Information / Serial Information / Count Information / Signal Tower Control Information	x
⑧	MindSphere Communication Status	Displays the connection status with MindSphere.	-	Communication normal / Communication error	-

*1 Set up the required information as described in the materials and instructions provided when MindSphere is licensed. Operations will not work if settings are incorrect.

*2 When assigning file names, set a different file name for Root Certificate 1 and Root Certificate 2.

1 When using the Cloud Communication Function select [MindSphere]; when not using the Cloud Communication Function, select [Do not use].

2 When [MindSphere] is selected in step **1**, set the [Region], [Client ID], [Client Secret], [Root Certificate], and [Select Information].

*The following are things you can do when [MindSphere] is selected.

Select Information Items	Description	Limitations
Signal Tower Information	Select when uploading to the cloud.	-
External Input Information		WDT-PRO only
Serial Information		
Count Information		-
Signal Tower Control Information	Select when controlling the signal tower over the cloud.	WDT-PRO only

3 Click [Setting] to update with the defined settings.

- Note:
- Client ID, Client Secret, and Root Certificate are all information provided by Mindsphere. For information, contact your nearest PATLITE sales representative.
 - If you cannot upload data to MindSphere, check the MindSphere communication status. When there is a communication error, review settings for missing or incorrect setting values, an expired certificate, and so on, and if the problem continues, contact our sales office.

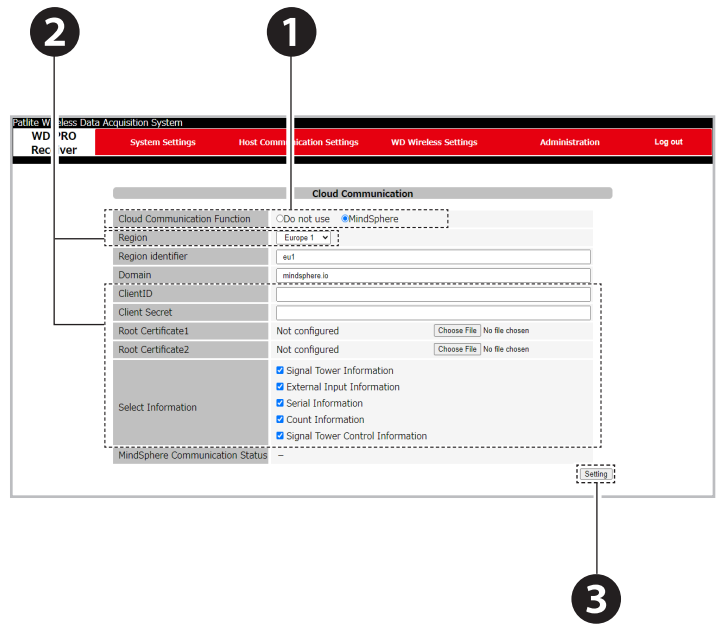

7.4.4. WD Wireless Settings

7.4.4.1. Receiver Wireless Settings

Set up the WDR wireless settings.

⚠ CAUTION

- ⚠ Cannot select on WDR-L-Z2-PRO-L and WDR-LE-Z2-PRO-L. Set WDR wireless settings with system configuration software WDS-WIN01.
- ⚠ When ExtendedPanID is 0000 0000 0000 0000, the WDR MAC address (IEEE address) is used as ExtendedPanID.
- ❗ Select at least one frequency channel. Additionally, select CH values that include the CH set up on the WDT.
- ❗ For the [Network Startup Method], select [Auto Start (Recommended)].

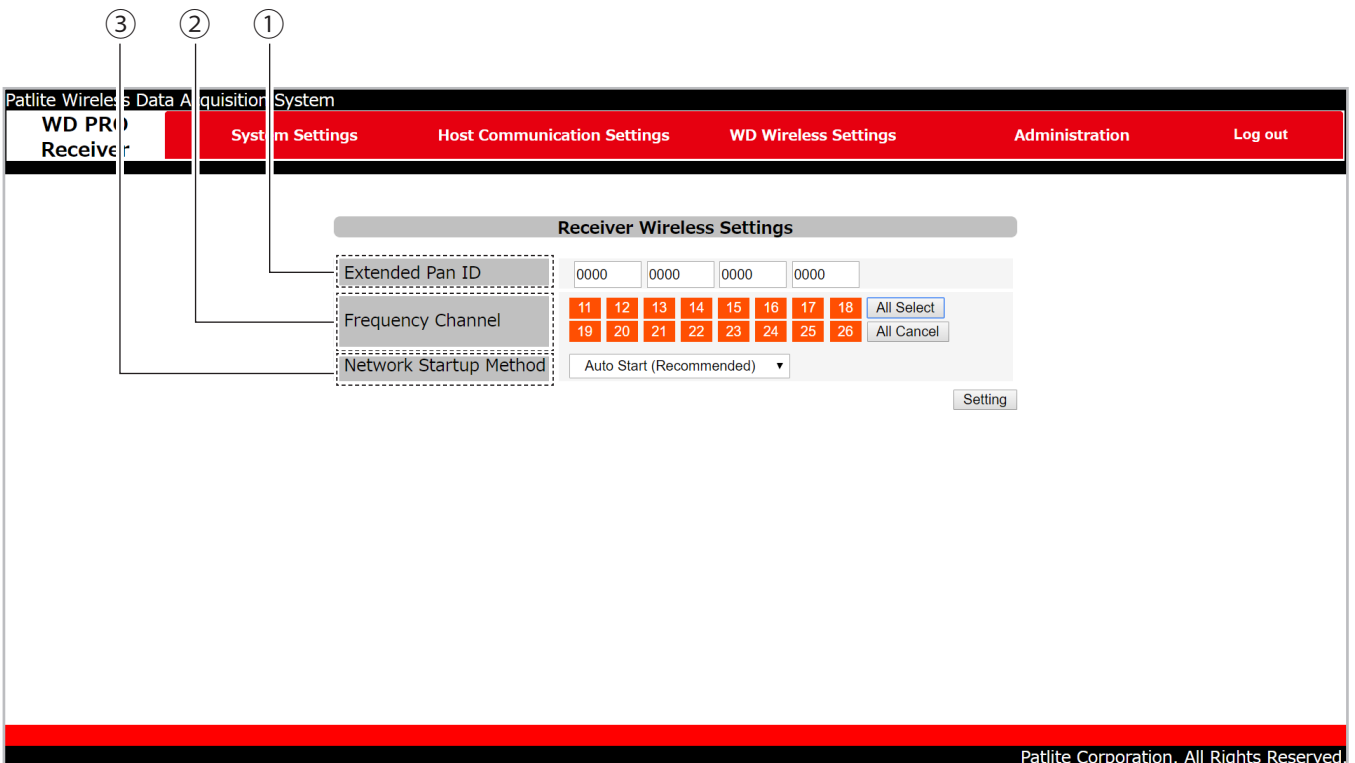

No.	Item	Description	Default Value	Input range	Setup optional
①	ExtendedPanID*	Enter the ID for grouping the WDT. For information, refer to "6.1.3. About Grouping and ExtendedPanID" (page 35).	0000 0000 0000 0000	Enter single-byte alphanumeric characters (0 to 9 and A to F)	x
②	Frequency Channel	Select the wireless frequency band for the WD system. For information, refer to "6.1.1. About the WD Wireless Network" (page 34).	(Select all)	CH11 / CH12 / CH13 / CH14 / CH15 / CH16 / CH17 / CH18 / CH19 / CH20 / CH21 / CH22 / CH23 / CH24 / CH25 / CH26	x
③	Network Startup Method	Select the [Network Startup Method] for when the WDR is powered on.	Auto Start (Recommended)	Auto Start (Recommended) / Manual Start	x

*Setup range is 0000 0000 0000 0000 to FFFF FFFF FFFF FFFE.

- 1** Enter the [ExtendedPanID].
- 2** Select* the [Frequency Channel].
*Click [All Select] to select all frequency channels. Click [All Cancel] to clear selection of all frequency channels.
- 3** Selects* the [Network Startup Method].
*If there is no particular reason otherwise, select [Auto Start (Recommended)].
- 4** Click [Setting] to update with the defined settings.

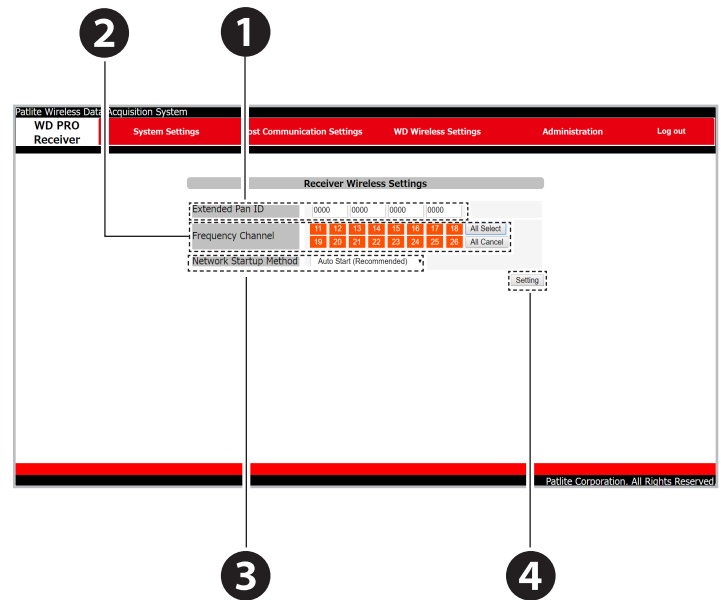

7.4.4.2. Wireless Settings List

Check or set the WDT currently connected to the WDR.

⚠ CAUTION

- ⚠ Cannot select on WDR-L-Z2-PRO-L and WDR-LE-Z2-PRO-L.
- ⚠ The blue button for the call transmitter does not work on WDT-5E/6M-Z2.
- ❗ When the WDT ExtendedPanID is 0000 0000 0000 0000 (default value), regardless of the ExtendedPanID setting all the WDR may be grouped together. In this scenario, because the grouped wireless network is not stable, set any value other than 0000 0000 0000 0000 during configuration.
- ❗ Set the same frequency channel as the WDR you want to group.
- ❗ Depending on the WDT model, the selection is different for the [Power Supply Settings].
 - WDT-4LR-Z2/WDT-5LR-Z2/WDT-6LR-Z2: Select [Power Supply Wire].
 - WDT-5E-Z2/WDT-6M-Z2: Select the wire that is supplying power, either [Red] or [White].
- ⚠ The set value for Counter Settings is for WDT-4LR-Z2/WDT-5LR-Z2/WDT-6LR-Z2 (ver3.06 or later). You cannot set a buzzer for WDT-5E-Z2/WDT-6M-Z2.
- ⚠ When DIP switch No.2. is ON, the set value for Counter Settings on the WDT-5LR-Z2/WDT-6LR-Z2 is [DIP Switch (Blue)]. For information, refer to "8.1.4. WDT DIP Switch Operations" (☞ page 93).
- ❗ For the [Counter Settings], even if you select [Do not use], the accumulated counter value in the WDT is not cleared. To clear the counter, use one of the following methods. Then, edit the [Counter Settings] to [Do not use].
 - In WDS-WIN01, clear the counter value. For information, refer to ☞ "WDS-WIN01 Instruction Manual".
 - Turn off the power supply on the WDT main unit.
- ❗ Not all WDB-D80S-PRO and WDT-6LR-Z2-PRO settings can be set up on the Web Setup Screen. Set up in WDS-WIN01. For information, refer to ☞ "WDS-WIN01 Instruction Manual".

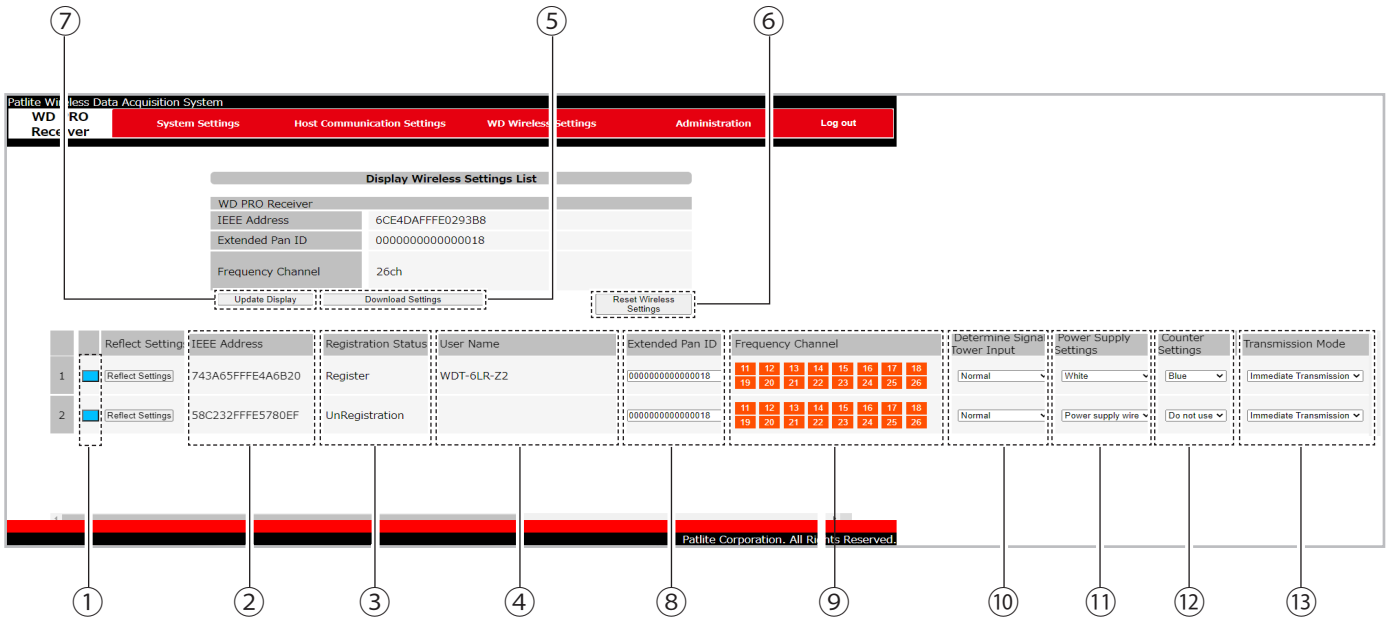

No.	Item	Description								
①	Call Transmitter	Click the blue button and the indicator for the associated WDT flashes blue for about 10 seconds. For information, refer to "8.1.5. Checking Operations with WDT-PRO Indicator" (☞ page 94).								
②	IEEE Address	Displays the WDT MAC address (IEEE address). For information, refer to "6.1.4. About the MAC Address (IEEE Address)" (☞ page 36).								
③	Registration Status	If the WDT has its IEEE Address registered in [Register Transmitter User Name], "Registered" is displayed. If the WDT does not have its IEEE Address registered, "Not registered" is displayed. For information, refer to "7.4.4.5. Register Transmitter User Name" (☞ page 79).								
④	User Name	Displays the WDT user name registered in [Register Transmitter User Name]. For information, refer to "7.4.4.5. Register Transmitter User Name" (☞ page 79).								
⑤	Download Settings	Click to download the settings file. <table border="1" style="width: 100%;"> <tr> <td>File name</td> <td>TransmitterList.csv</td> </tr> <tr> <td>Character code</td> <td>UTF-8</td> </tr> <tr> <td>Linebreak code</td> <td>CR+LF</td> </tr> <tr> <td>CSV file structure*</td> <td>IEEE Address, User Name, ExtendedPanID, Frequency Channel, Determine Signal Tower Input, Power Supply Settings, Counter Settings, Transmission Mode</td> </tr> </table>	File name	TransmitterList.csv	Character code	UTF-8	Linebreak code	CR+LF	CSV file structure*	IEEE Address, User Name, ExtendedPanID, Frequency Channel, Determine Signal Tower Input, Power Supply Settings, Counter Settings, Transmission Mode
File name	TransmitterList.csv									
Character code	UTF-8									
Linebreak code	CR+LF									
CSV file structure*	IEEE Address, User Name, ExtendedPanID, Frequency Channel, Determine Signal Tower Input, Power Supply Settings, Counter Settings, Transmission Mode									
⑥	Reset Wireless Settings	Click to send a disconnect request to all connected WDT.								
⑦	Update Display	Click to update the WDT connection status.								

*Example CSV File Structure

```

IEEE Address,User Name,Extended Pan Id,Frequency Channel,Determine Signal Tower Input,Power Supply Settings,Counter Settings,Transmission Mode
1234:5678:abcd:ef01,WDT01,0123:4567:89ab:cdef,26ch,Normal,Power Supply Wire,Do not use,Immediate Transmission
1234:5678:abcd:ef02,WDT02,0123:4567:89ab:cdef,26ch,Flashing(medium),Red,Red,Request Transmission
:
:
    
```

No.	Item	Description	Input range	Setup optional
⑧	ExtendedPanID	Enter the ID for grouping the WDR. For information, refer to "6.1.3. About Grouping and ExtendedPanID" (☞ page 35).	Enter single-byte alphanumeric characters (0 to 9 and A to F)	x
⑨	Frequency Channel	Select the wireless frequency band for the WD system. For information, refer to "6.1.1. About the WD Wireless Network" (☞ page 34).	CH11 / CH12 / CH13 / CH14 / CH15 / CH16 / CH17 / CH18 / CH19 / CH20 / CH21 / CH22 / CH23 / CH24 / CH25 / CH26	x
⑩	Determine Signal Tower Input	Select the process used to determine the signal tower input status. For information, refer to "9.1.2.1. Determine Signal Tower Input" (☞ page 114).	Normal / Flashing (short) / Flashing (medium) / Flashing (long)	x
⑪	Power Supply Settings	Select the signal wire for the power supply.	Power supply wire: Red, yellow, green, blue, or white	x
⑫	Counter Settings	Select the signal wire for the Simple Counter Function. For information, refer to "9.1.1.5. Simple Counter Function" (☞ page 113).	Do not use, red, amber, green, blue, white or buzzer	x
⑬	Transmission Mode	Select the type of transmission operation for the signal tower status. For information, refer to "9.1.1.1. Transmit Signal Tower Information" (☞ page 111).	Immediate transmission or Request transmission	x

- 1 Enter the [ExtendedPanID].
- 2 Select the [Frequency Channel].
- 3 Select [Determine Signal Tower Input], [Power Supply Settings], [Counter Settings], and [Transmission Mode].
- 4 Click [Reflect Settings] to update with the defined settings.

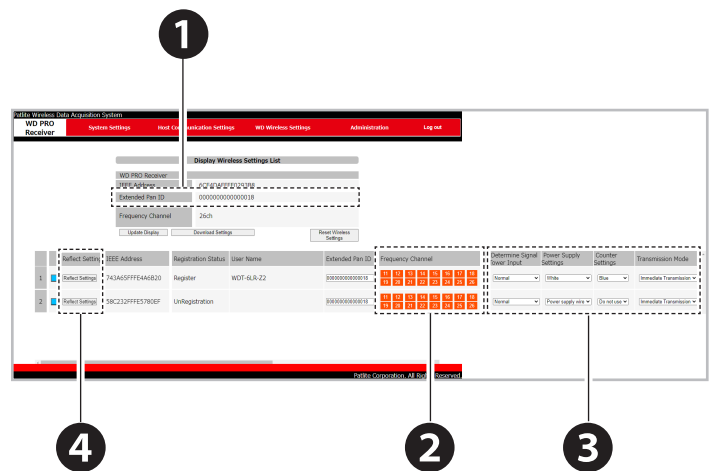

7.4.4.3. Wireless Connection Diagnosis

You can analyze WD system's wireless environment and check the WDR status. To analyze the current wireless environment, select [Current status]. To analyze the wireless environment periodically for a specified period, select [Set Period].

For information on wireless connection diagnosis, refer to "9.2.2. Self Diagnosis Function" (☞ page 121).

⚠ CAUTION

⚠ If you run Wireless Connection Diagnosis while the WDT is disconnected, download and diagnosis results cannot be displayed.

No.	Item	Description								
①	Interval	Set the period for the wireless connection diagnosis. Select either [Current Status] or [Set Period]. *When [Set period] is selected, you can enter a diagnosis period from 1 to 72 hours.								
②	Diagnosis	[Start] begins diagnosis of the wireless environment. [Stop] interrupts diagnosis of the wireless environment.								
③	Diagnosis Result	<p>Displays the diagnosis status of the wireless environment.</p> <ul style="list-style-type: none"> • Stop: Wireless connection diagnosis is not executed. • Diagnosis in progress: Wireless connection diagnosis is running. • Diagnosis complete: Wireless connection diagnosis is complete. • Error *1: Wireless connection diagnosis is not operating normally. <p>• When there is a wireless connection diagnosis result, you can download the diagnosis result in CSV file format.</p> <table border="1" style="width: 100%;"> <tr> <td>File name</td> <td>WirelessDiagnosisInformation.csv</td> </tr> <tr> <td>Character code</td> <td>UTF-8</td> </tr> <tr> <td>Linebreak code</td> <td>CR+LF</td> </tr> <tr> <td>CSV file structure</td> <td>date and time, User name, IEEE address, diagnosis result</td> </tr> </table> <p>•Example CSV File Structure</p> <pre style="border: 1px solid black; padding: 5px;"> 2019/11/14 12:00, WDT01 ,1234:5678:abce:ef01,A 2019/11/14 12:00, WDT02 ,1234:5678:abce:ef02,B 2019/11/14 12:10, WDT01 ,1234:5678:abce:ef01,B 2019/11/14 12:10, WDT02 ,1234:5678:abce:ef02,C : : </pre> <p>Click [Diagnosis Result] to display diagnostic results in a pop-up screen.</p>	File name	WirelessDiagnosisInformation.csv	Character code	UTF-8	Linebreak code	CR+LF	CSV file structure	date and time, User name, IEEE address, diagnosis result
File name	WirelessDiagnosisInformation.csv									
Character code	UTF-8									
Linebreak code	CR+LF									
CSV file structure	date and time, User name, IEEE address, diagnosis result									

*1 When the Wireless Connection Diagnosis results display "Error", refer to "10.1. Troubleshooting" (☞ page 123).

1 For the diagnosis timing, select whether to diagnose the [Current Status] or via a [Set Period].

- When [Set period] is selected, you can enter a diagnosis period from 1 to 72 hours.

2 Click the [Start] button to start wireless connection diagnosis.

- While the diagnosis is in progress, the diagnosis result column displays the text "Diagnosis in progress".
- While the diagnosis is in progress, the entered diagnosis time* is displayed.

* For [Current Status], "0 hours" is displayed.

- Click the [Stop] button to interrupt the wireless diagnosis.

3 After completing a diagnosis of the wireless environment, click the [Download] button to download the diagnosis results.

- Even if the wireless connection diagnosis is interrupted, if there is a diagnosis result you can download the CSV file.
- Diagnosis results are ranked in five levels: A, B, C, D, and E. For information, refer to "9.2.2. Self Diagnosis Function" (page 121).
- After completing diagnosis of the wireless environment, click [Display Diagnosis Result] to pop up the diagnosis result screen.

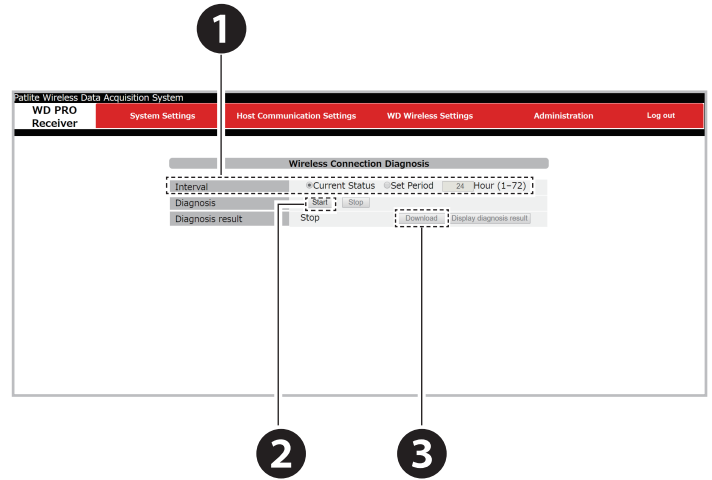

Pop-up screen

User Name	IEEE Address	2011/11/19											
		11:00		12:00		13:00		14:00		15:00		16:00	
WDT03	0025-SCFF-FEBA-8EAC	A	B	B	B	B	B	B	B	B	B	B	B
WDT02	6C84-DAFF-FE01-9C48	A	B	B	B	B	B	B	B	B	B	B	B
WDT01	743A-65FF-FE4A-6B25	A	B	B	B	B	B	B	B	B	B	B	B

Area3 ranking diagnosis results

Rank	Description
A	The transmitter communicates stably with the receiver with sufficient quality.
B	There are no issues with the propagation environment.
C	Although the transmitter does not communicate with sufficient quality for direct communication with the receiver, the transmitter can communicate with sufficient quality using communication paths (communication hopping) with other transmitters. There are no issues with the propagation environment.
D	Although the transmitter does not communicate stably with the receiver, the transmitter can communicate with sufficient quality using communication paths (communication hopping) with other transmitters. As long as the other transmitters act as intermediate relays to connect, there are no issues with the propagation environment.
E	The quality of the communication path deteriorates and becomes a trouble.
	Although communication is currently possible, it is recommended to adjust the propagation environment as communication paths are lost at any time.
	The receiver does not communicate with the transmitter.
	The propagation environment must be changed.

- Click the call transmitter's blue button and the indicator for the associated WDT flashes blue for about 10 seconds. For information, refer to "8.1.5. Checking Operations with WDT-PRO Indicator" (page 94).

Point

- The wireless environment diagnosis results are saved until you run the wireless connection diagnosis again, WDR is turned off, WDR is initialized, or WDR is rebooted.

7.4.4.4. Status Check

Lists the Signal Tower Control Line input status for each WDT. Every 8 seconds, get the latest input status for the Signal Tower control line and update the screen. The Status Check displays in a pop-up screen.

⚠ CAUTION

- ⚠ Cannot select on WDR-L-Z2-PRO-L and WDR-LE-Z2-PRO-L.
- ⚠ While the screen is updating (about 8 seconds), multiple changes to the Signal Tower Control Line input status do not display.

Point

- You can display up to 30 units.
- Function that displays the input status of the Signal Tower Control Line. To analyze equipment operations such as "accurately view capacity utilization rate", prepare the application software separately. For application software, refer to "5.3. About Application Software" (📖 page 29) and contact our sales office.
- WDT registered with user names are displayed first. (In order of registration)



Buzzer status

- → Buzzer on
- → Buzzer off

* Gets the buzzer status only when the WDT is setup to be able to get the buzzer status. (Cannot get using WDT-5E-Z2 or WDT-6M-Z2.)

WDT name

- Transmitter User Name
- If registered → Display transmitter user name
- If not registered → Display MAC address (IEEE address)

Call Transmitter button

- Click the call transmitter button and the indicator for the associated WDT flashes blue for about 10 seconds.
- * Does not display on WDT-5E-Z2 or WDT-6M-Z2.
- Also does not display when WDT is not connected.

Frame: WDT status

- → Display connection status
- → Disconnected status (Displays only WDT with registered transmitter user names.)

Status of Signal Tower Control Line

• Red		:	
• Amber		:	
• Green		:	
• Blue		:	
• White		:	

Light on / Flashing* Light off

* Displays when [Determine Signal Tower Input] is [Flashing].

7.4.4.5. Register Transmitter User Name

You can register a name (user name) for the WDT.

By using a CSV file, you can register everything in one step, or output everything to a file in one step.

⚠ CAUTION

- ⚠ Cannot set up on WDR-L(E)-Z2-PRO-L.
- ⚠ If the CSV file includes information on more than 30 WDT, only the first 30 units are recorded.
- ⚠ If you register a file that cannot be read, an error screen appears.
- ⚠ You can register a maximum 20 characters for Transmitter User Names. If you register with more characters, only up to the twentieth character is saved.

Point

- When a user name is registered, the status of "7.4.4.2. Wireless Settings List" changes from "Not registered" to "Registered".
- Modbus/TCP Communication unit identifiers are assigned, in order, from the top of the CSV file used for registration.

Register Transmitter User Name

1 Click the [Choose File] button and select the CSV file*.

*CSV files you can select are as follows.

Character code	UTF-8
Linebreak code	CR+LF
CSV file structure	IEEE address, user name

● CSV file configuration example
(when registering user names for 20 transmitters)

```
00255CFFFEABDDC, Line ○○ Transmitter 1 ← Modbus/TCP Communication unit identifier "01H"
00255CFFFEABDDD, Line △△ Transmitter 2 ← Modbus/TCP Communication unit identifier "02H"
:
:
00255CFFFEABDDF, Line ×× Transmitter 20 ← Modbus/TCP Communication unit identifier "14H"
```

Enter the MAC Address (IEEE Address) of the associated transmitter

Enter the user name to set

Enter a comma ","

Enter the line feed code "CR+LF"

2 Click the [Register] button.

*Upload of selected CSV files begins, WDT user names are written at once, and displayed in a list.

Note: If you register a CSV file with a different structure than shown above, or if you register a CSV file with two or more of the same transmitter MAC addresses (IEEE address), an error screen will appear.

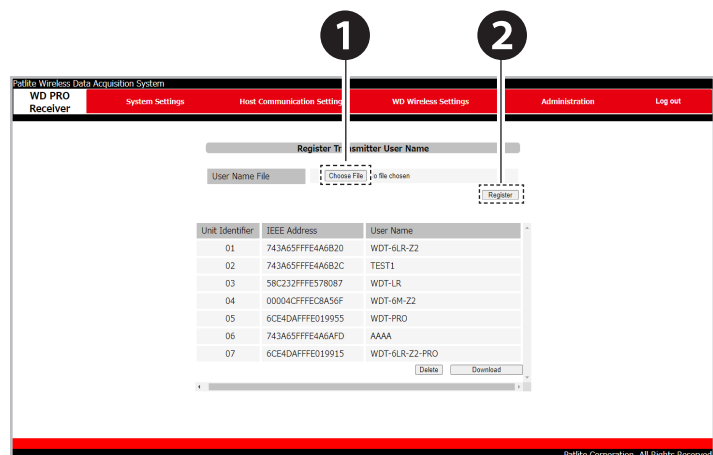

Download Transmitter User Name

1 Click the [Download] button.

2 Specify the save destination and save.

*The file format for the saved file is as follows.

Character code	UTF-8
Linebreak code	CR+LF
CSV file structure	IEEE address, user name

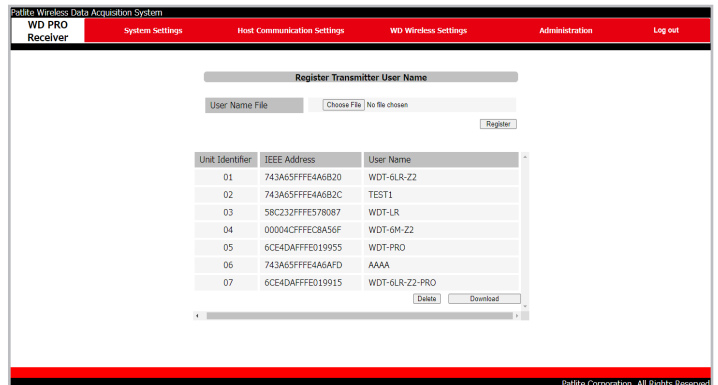

Delete Transmitter User Name

1 Click the [Delete] button.

*Clicking the [Delete] button will also delete the transmitter user name list from the displayed list.

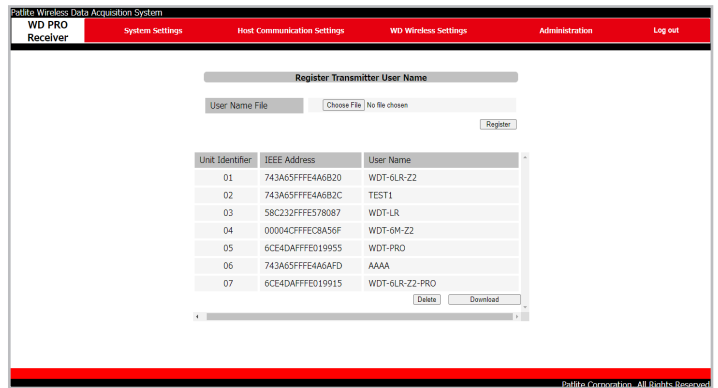

7.4.5. Administration

7.4.5.1. Main Unit Information

You can check the information of connected WDR.

No.	Item	Description	References
①	MAC Address	Displays the WDR LAN MAC address.	-
②	Firmware Version	Displays the version of the WDR firmware.	-
③	OS Version	Displays the version of the WDR operating system.	-
④	Operating Power*	Displays the power being supplied to the WDR. When operating with power from the AC Adaptor or power terminal block, displays "24V DC", and when operating with PoE, displays "PoE".	-
⑤	Network Startup Method	Displays the [Network Startup Method] for when the WDR is powered on. Displays either [Auto start] or [Manual start].	☞ "7.4.4.1. Receiver Wireless Settings" (page 72)
⑥	Wireless channel	Displays the wireless channel currently used by WDR.	-
⑦	Number of connected transmitters	Displays the number of WDT connected to the WDR.	-

No.	Item	Description	References
①	MAC Address	Displays the WDR LAN MAC address.	-
②	Firmware Version	Displays the version of the WDR firmware.	-
③	OS Version	Displays the version of the WDR operating system.	-
④	Operating Power*	Displays the power being supplied to the WDR. When operating with power from the AC Adaptor or power terminal block, displays "24V DC", and when operating with PoE, displays "PoE".	-
⑤	Network Startup Method	Displays the [Network Startup Method] for when the WDR is powered on. Displays either [Auto start] or [Manual start].	☞ "7.4.4.1. Receiver Wireless Settings" (page 72)
⑥	Wireless channel	Displays the wireless channel currently used by WDR.	-
⑦	Number of connected transmitters	Displays the number of WDT connected to the WDR.	-

*When both the PoE power supply and 24 VDC power supply (AC adaptor or power terminal) are connected, PoE takes priority.

7.4.5.2. Update Firmware

You can update the WDR firmware. After the firmware is updated, the unit reboots.

⚠ CAUTION

- ⊘ Do not turn off the power or disconnect the LAN cable while updating. Failure to follow this instruction could result in product failure.
- ❗ If you downgrade the firmware, make sure you initialize the product.

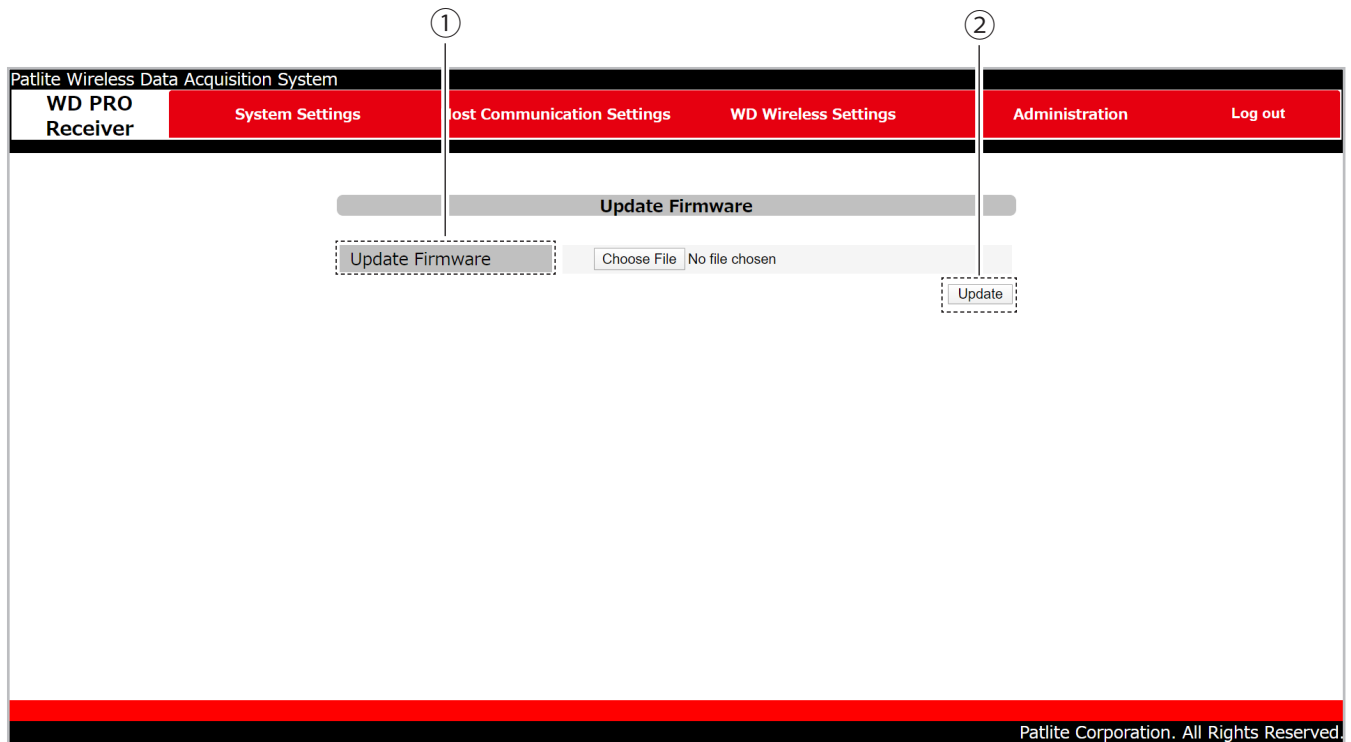

No.	Item	Description
①	Update Firmware	Click button and specify the firmware to write to the WDR.
②	Update	Click [Update] to start updating the firmware.

- 1** Click [Choose File] button and specify the firmware to write to the WDR.
- 2** Click [Update] to start updating the firmware.

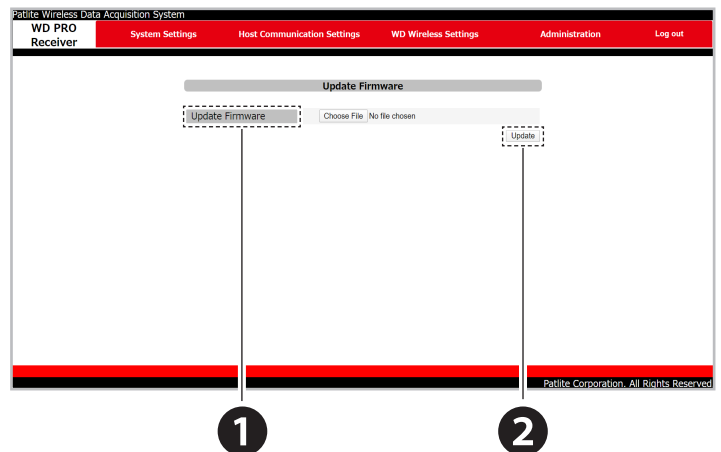

7.4.5.3. Initialize

Initializes the WDR settings. You can select the items that you want to initialize.

⚠ CAUTION

! When network settings are initialized, the IP address is reset to the factory default. Make sure you set up the network again.

! When initialization is run, the Signal Tower information, wireless quality information, counter information, and various log data are also initialized.

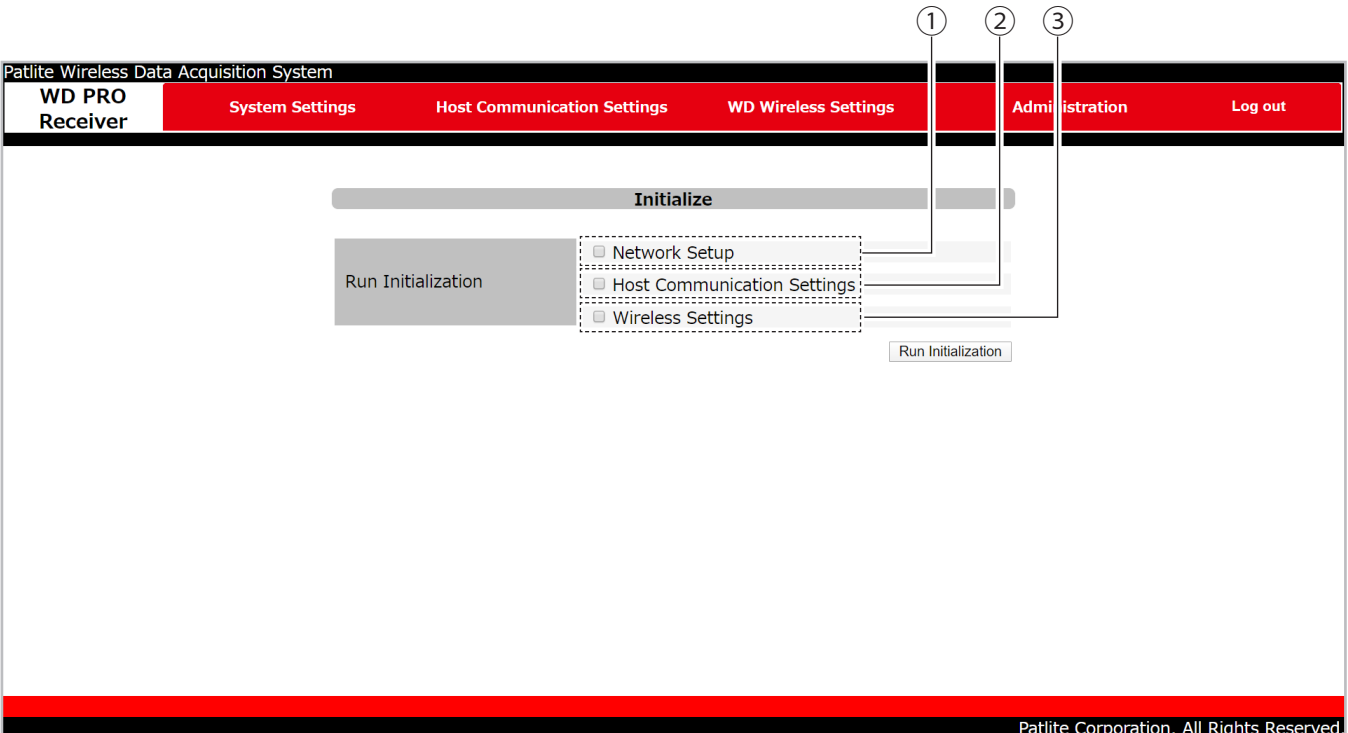

Patlite Corporation. All Rights Reserved.

No.	Initialization Items	Initialization Setting	References
①	Network Setup	Settings in the Network Setup screen are initialized.	☞ "7.4.2.1. Network Setup" (page 58)
②	Host Communication Settings	Settings in the Socket Communication screen, Database Communication screen, Modbus/TCP Communication screen, and Cloud Communication Settings screen are initialized.	☞ "7.4.3.1. Socket Communication Settings" (page 64) ☞ "7.4.3.2. Database Communication Setting" (page 66) ☞ "7.4.3.3. Modbus/TCP Communication Settings" (page 68) ☞ "7.4.3.4. Cloud Communication Settings" (page 69)
③	Wireless Settings	Settings in the Receiver Wireless Settings screen are initialized.	☞ "7.4.4.1. Receiver Wireless Settings" (page 72)

1 Select the settings to initialize* from the list of initialization items.

*You can select multiple items.

2 Click the [Run Initialization] button.

3 WDR is automatically rebooted.

Note: • Check the WDR status lamp to check the reboot status. For information, refer to "8.2.5. Checking the WDR Status Lamp" ([page 105](#)).

• For information on initialization items, refer to "8.2.6. Initializing the WDR" ([page 107](#)).

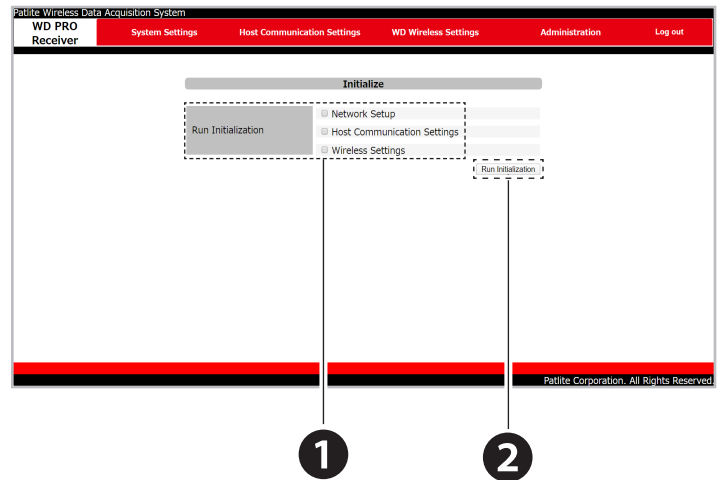

7.4.5.4. Reboot

This product is rebooted when you click the [Reboot] button.

⚠ CAUTION

⚠ When rebooting, the Signal Tower information, wireless quality information, counter information, and various log data are initialized.

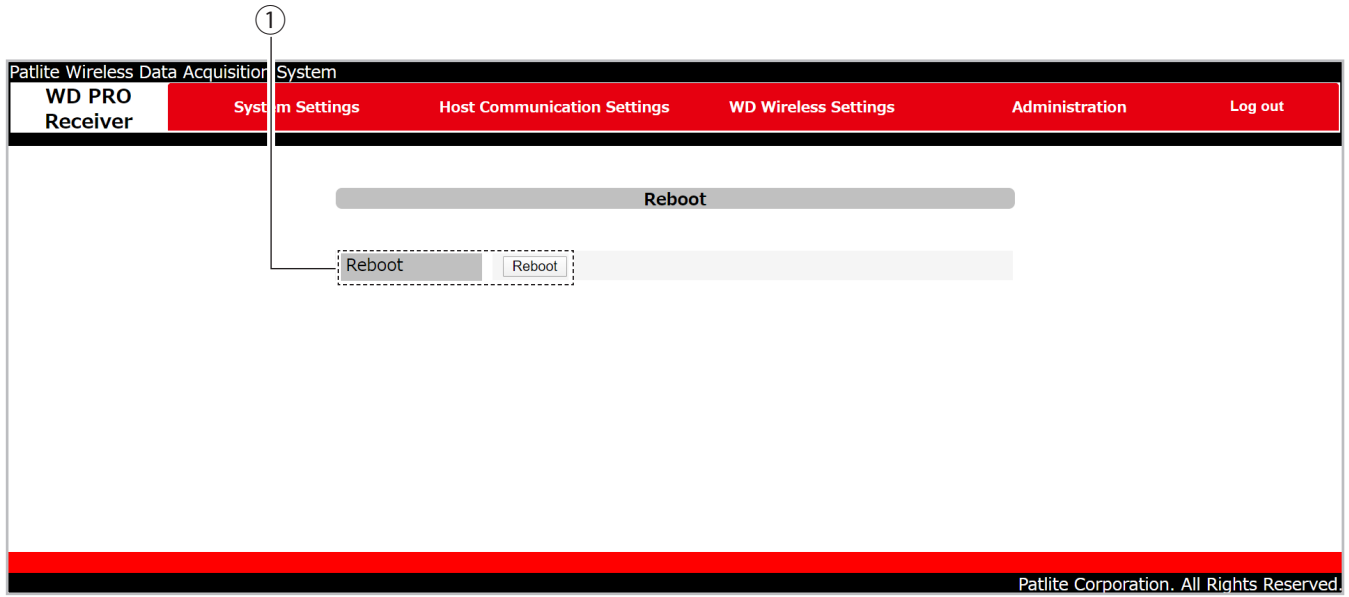

No.	Item	Description
①	Reboot	Reboots this product.

1 Click the [Reboot] button.

*A confirmation for reboot displays in a pop-up screen.

2 Click* [OK].

*Reboot is started (reboot is complete after about 50 seconds).

*While rebooting, the WDR status lamp remains lit as normal. For information, refer to "8.2.5. Checking the WDR Status Lamp" (page 105).

3 After reboot is complete, log in to the WDR Setup Screen

(refer "7.2. Display WDR Web Setup Screen" (page 51))

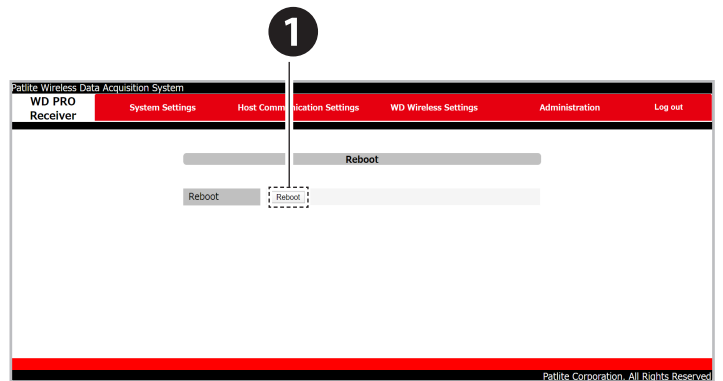

Pop-up Screen

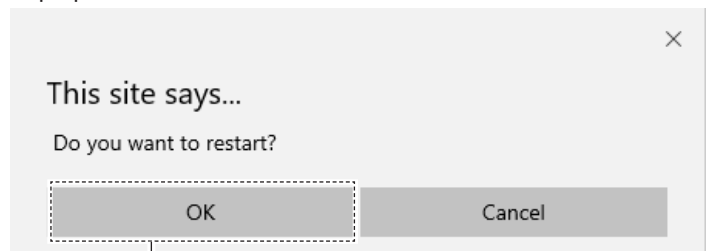

8. Operation

8.1. How to Use the WDT

8.1.1. WDR Wiring Method

For the wiring method, carefully read and follow the instructions in the LR Series Instruction Manual.

! WARNING

- ⊘ Before any wiring or fuse replacement, disconnect the power. Failure to follow this instruction could result in a short-circuit and product damage.
- ⊘ Supply only the correct power, direct current or alternating current, and use the proper voltage. Failure to follow this instruction could result in fire.

! CAUTION

- ! To operate the WDT, you need to constantly supply power to the LR series signal tower's power line. The voltage for the target models are as follows.

- Applicable models:

LR □ - □ 01/LR □ - □ 02

- Signal tower rated voltage: 12 to 24 VDC

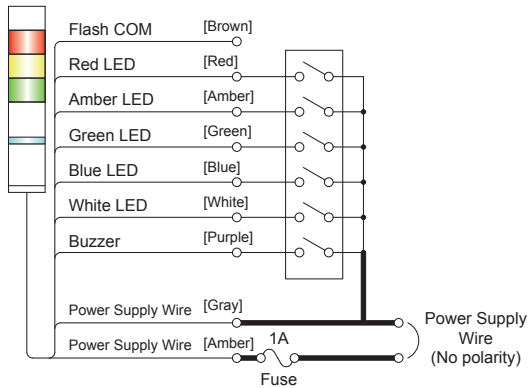

- Applicable models: LR □ - □ M2

- Signal tower rated voltage: 100 to 240 VAC

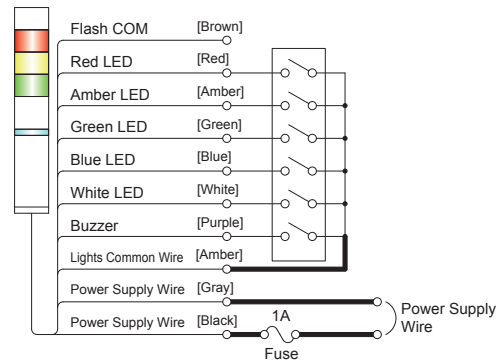

- ! To protect external equipment, install a fuse on the power supply side.

- Recommended fuse: 250 V / 1 A 5x20 mm Fast-blow glass tube fuse

*When the signal tower rated voltage is 100 to 240 VAC, use the following parts.

- If you are not using a regulated power supply, use a fuse that meets or exceeds Class CC.
- Use a fuse holder with UL Standards certification.

- ! Insulate the leads of unused signal tower control wires, one by one. Failure to follow this instruction could result in a short-circuit and product damage.

8.1.2. Attaching and Detaching the WDT

! WARNING

- ⊘ Before installing and wiring this product, be sure that it is disconnected from the power source. Failure to comply may result in fire, electrocution or product malfunction.

! CAUTION

- ❗ The maximum number of attachment units per Signal Tower is: 5 LED units + 1 buzzer unit + this product (transmitter unit). Do not exceed this maximum.
- ⊘ Do not apply excessive force onto this product or the body unit. Doing so may damage the product.
- ⊘ Do not touch the connectors of the units, or the LED bulbs on the LED unit. Doing so may damage the product.
- ⊘ During assembly, be sure to securely lock each unit into place. If any units are loose, it may result in product damage.
- ⊘ **When** attaching or detaching units (transmitter, LED unit, or buzzer unit) to and from the body unit or the transmitter, attach or detach units one at a time. Failure to follow these instructions could result in equipment damage.
- ⚠ If you are having difficulty attaching/detaching the units, try with the body unit of the LR Signal Tower secured, or with work gloves on..
- ⚠ In order to maintain waterproofing, the WDT-4LR-Z2 is designed to be tightly secured onto the Signal Tower. Be sure to tightly lock each unit into place

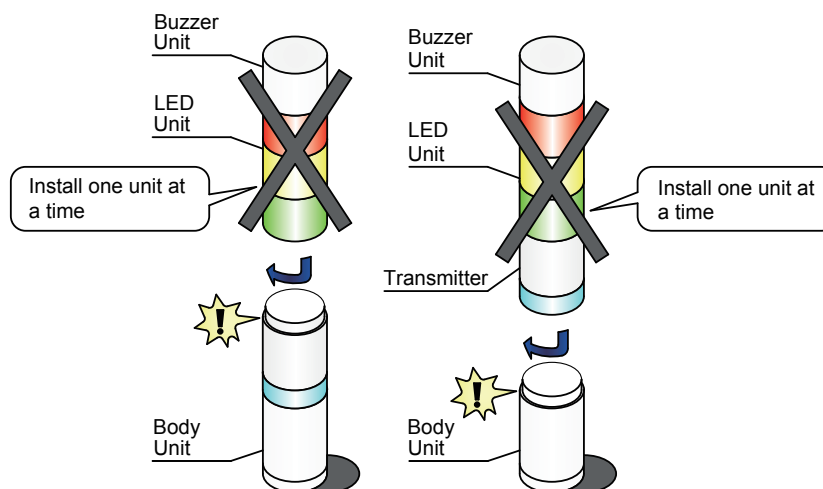

8.1.2.1. Installing to and Removing from LR Series Signal Tower

When installing or removing WDT, follow the instructions below to attach and detach parts (such as the LED unit and buzzer unit) from the LR Signal Tower.

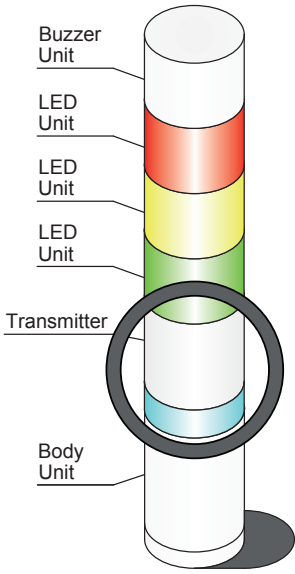

CAUTION

⊘ This product is to be installed right above the body unit of the LR Signal Tower. If it is installed above the LED units, it will be difficult to see the indicator lights on the transmitter..

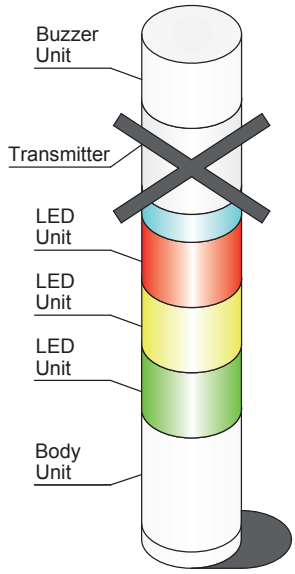

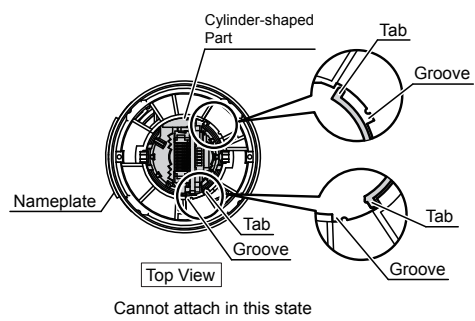

❗ If the transmitter does not attach properly to the body unit, confirm the tab of the cylinder-shaped part at the top of the transmitter is fitted correctly into the groove. If the tab is outside the groove as shown in the figure (right), refer to the figure below on how to reposition it. Additionally, depending on how the transmitter is removed, the tab may come out of the groove (as shown in Figure 1) when detaching from the body unit. Attaching while the tab is still in this state may cause damage.



⚠ If you are having difficulty attaching/detaching the units, try with the body unit of the LR Signal Tower secured, or with work gloves on.

⚠ In order to maintain waterproofing, the WDT-4LR-Z2 is designed to be tightly secured onto the Signal Tower. Be sure to tightly lock each unit into place

Point

● If the transmitter does not attach properly to the body unit, in the center of the underside of the product, turn the cylinder-shaped part counter-clockwise. Next, turn the cylinder-shaped part until it snaps into place, then attach it to the body unit.

● For WDT-4LR-Z2

<p>■ Attach</p> <p>Align this product with the positioning mark on the body unit and turn clockwise to lock.</p>	<p>■ Detach</p> <p>While holding the body unit, turn the product counterclockwise to release the lock, then lift up.</p>	<p>■ Positioning Mark</p> <p><Locked> This Product Body Unit Indication when locked</p> <p><Unlocked> This Product Body Unit Indication when unlocked</p>
--	--	---

● For WDT-5LR-Z2/WDT-6LR-Z2

<p>■ Attach</p> <p>Align this product with the positioning mark on the body unit and turn clockwise to lock.</p>	<p>■ Detach</p> <p>While holding the body unit, turn the product counterclockwise to release the lock, then lift up.</p>	<p>■ Positioning Mark</p> <p><Locked> This Product Body Unit Indication when locked</p> <p><Unlocked> This Product Body Unit Indication when unlocked</p>
--	--	---

8.1.2.2. Attaching the LED Unit and Buzzer Unit

⚠ CAUTION

- ❗ Attach or detach units one at a time.
- ⚠ In order to maintain waterproofing, the WDT-4LR-Z2 is designed to be tightly secured onto the Signal Tower. Be sure to tightly lock each unit into place.
- ⚠ If you are having difficulty attaching/detaching the units, try with the body unit of the LR Signal Tower secured, or with work gloves on.

Attach 1 unit at a time

Attach 1 unit at a time

Order of Attaching/Detaching Units

Attach and detach units in the following order.

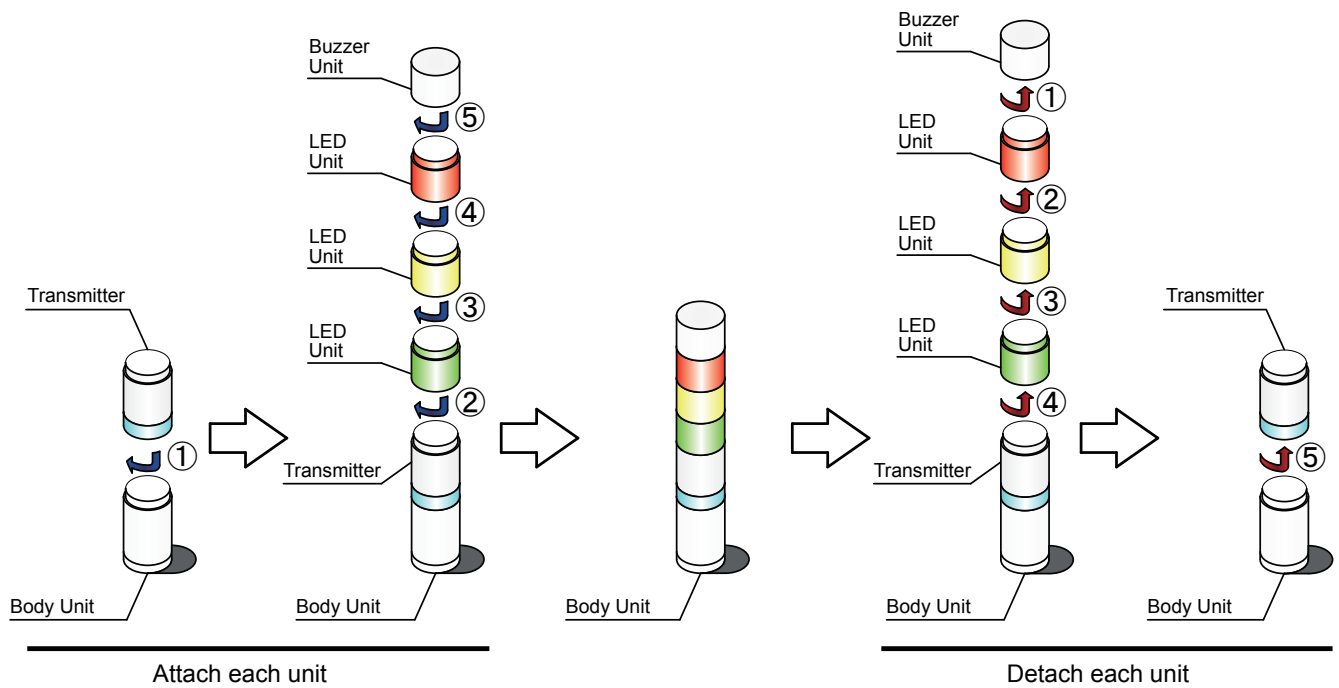

8.1.3. Setting up the WDT Main Unit

8.1.3.1. Setup Process

- For WDT setup, use the system configuration software WDS-WIN01.
- Download WDS-WIN01 from our website, and install on the computer that will be used to set up and configure the system. (Customer registration is required for downloading from the home page)
For information about usage and setup, refer to [☞ "WDS-WIN01 Instruction Manual"](#).
- For the set up process of the WDR Web Setup screen, refer to "7. WDR Setup Process" ([☞ page 49](#)).
- When using WDT-5E/6M-Z2 or 4LR / 5LR / 6LR-Z2, you can also set up on the WDR Web Setup Screen.
For information, refer to "7.4.4.2. Wireless Settings List" ([☞ page 73](#)).

8.1.3.2. Setup Items

Setup items are as follows.

Setup Item		WDS-WIN01 Setup Items	Default Value	References
Wireless Settings	ExtendedPanID Settings	ExtendedPanID	0000 0000 0000 0000	☞ "6.1.3. About Grouping and ExtendedPanID" (page 35)
	Frequency Channel Settings	Frequency Channel	Select all	☞ "6.1.1. About the WD Wireless Network" (page 34)
Operation Settings	Determine Signal Tower Input Setting	Determine Signal Tower Input	Flashing (medium)	☞ "9.1.2.1. Determine Signal Tower Input" (page 114)
	Power Supply Settings	Power Supply Settings	Power Supply Wire	*
	Simple Counter Settings	Counter Settings	Do not use	☞ "9.1.1.5. Simple Counter Function" (page 113)
	Input Information Transmission Timing Setting	Transmission Mode	Immediate Transmission	☞ "9.1.1.1. Transmit Signal Tower Information" (page 111)

*For this product's settings, select [Power Supply Wire]. For information, refer to [☞ "WDS-WIN01 Instruction Manual"](#).

8.1.3.3. Required Equipment

- For system configuration when setting up WDT equipment, refer to "5.2.3. Example System Configuration When Setting Up Equipment (using the Setup Kit)" (☞ page 28). For setting up a WDT device, use the system configuration software WDS-WIN01.
- Install WDS-WIN01 on the maintenance PC and set up the equipment.
For information about using WDS-WIN01, refer to ☞ "WDS-WIN01 Instruction Manual".
- The setup procedure is as follows.

STEP 1 Prepare required equipment and create maintenance environment

This manual

"5.2.3. Example System Configuration When Setting Up Equipment (using the Setup Kit)" (☞ page 28)

STEP 2 Turn ON the WDR

This manual

"8.2.5. Checking the WDR Status Lamp" (☞ page 105)



After power is turned on, the WDR takes approximately 50 seconds to complete startup. Check the WDR status lamp to confirm startup is complete.

STEP 3 Set the network between the WDR and maintenance PC

WDS-WIN01 Instruction Manual

"6.1.1. WDR Network Settings"



When connecting to the WDR for the first time via LAN, set the IP address of the maintenance PC to 192.168.10.* (value other than 1).

STEP 4 Start WDS-WIN01 on the maintenance PC

WDS-WIN01 Instruction Manual

"5.3. Starting WDS-WIN01"

STEP 5 Turn ON the WDR and using the WDT indicator check the wireless status

This manual

"8.1.5. Checking Operations with WDT-PRO Indicator" (☞ page 94)

STEP 6 Set up WDT

This manual

"7.4.4.2. Wireless Settings List" (☞ page 73)

"8.1.3.2. Setup Items" (☞ page 91)

"8.1.3. Setting up the WDT Main Unit" (☞ page 91)

WDS-WIN01 Instruction Manual

"6.1.2. Set Up WDT"



To configure WDT, WDT and WDR must have a wireless connection. When the WDT and WDR are not connected wirelessly, initialize the WDT. For information, refer to "8.1.6. Initializing the WDT" (☞ page 95).

8.1.4. WDT DIP Switch Operations

! CAUTION

- ⊘ Do not use excessive force on this product. Failure to follow this instruction could result in deformed frame and product damage.
- ⊘ Do not use sharp tipped objects with this product. Operation may become impossible as scratches develop on switches and switch contacts are interfered with.

WDT dip switches are on the bottom of the main unit.

For WDT-4LR-Z2

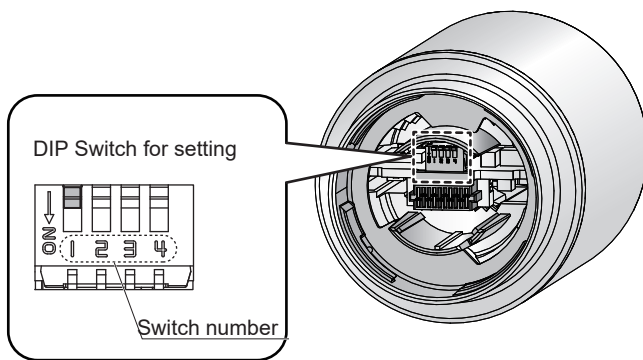

For WDT-5LR-Z2 and WDT-6LR-Z2

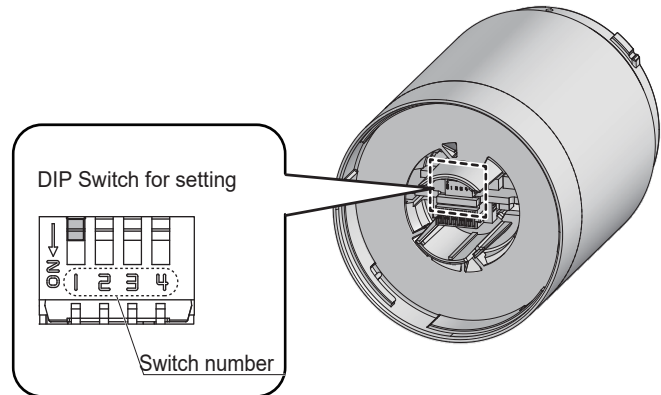

●DIP Switch Settings

Switch number	Description	Initial Settings	References
1	Initialize setting values <ul style="list-style-type: none"> • OFF: Normally use with this setting OFF. • ON: Initializes the value for various settings. 	OFF	☞ "8.1.6. Initializing the WDT" (page 95)
2	Methods for defining Count Input signal wire <ul style="list-style-type: none"> • OFF: Define with the WDS-WIN01 simple counter settings. • ON: Use blue Signal Tower control wire (fixed). 	OFF	☞ "9.1.1.5. Simple Counter Function" (page 113)
3	Select format of Signal Tower information <ul style="list-style-type: none"> • OFF: Send in standard format. • ON: Send in extended format. 	OFF	☞ "9.1.1.2. Select Format of Signal Tower Information" (page 111)
4	Periodic Transmission <ul style="list-style-type: none"> • OFF: Normally use with this setting OFF. • ON: Send transmissions at regular intervals. 	OFF	☞ "9.1.1.3. About Periodic Transmissions" (page 112)

8.1.5. Checking Operations with WDT-PRO Indicator

Check using the indicator on the main unit.

For WDT-4LR-Z2

For WDT-5LR-Z2 and WDT-6LR-Z2

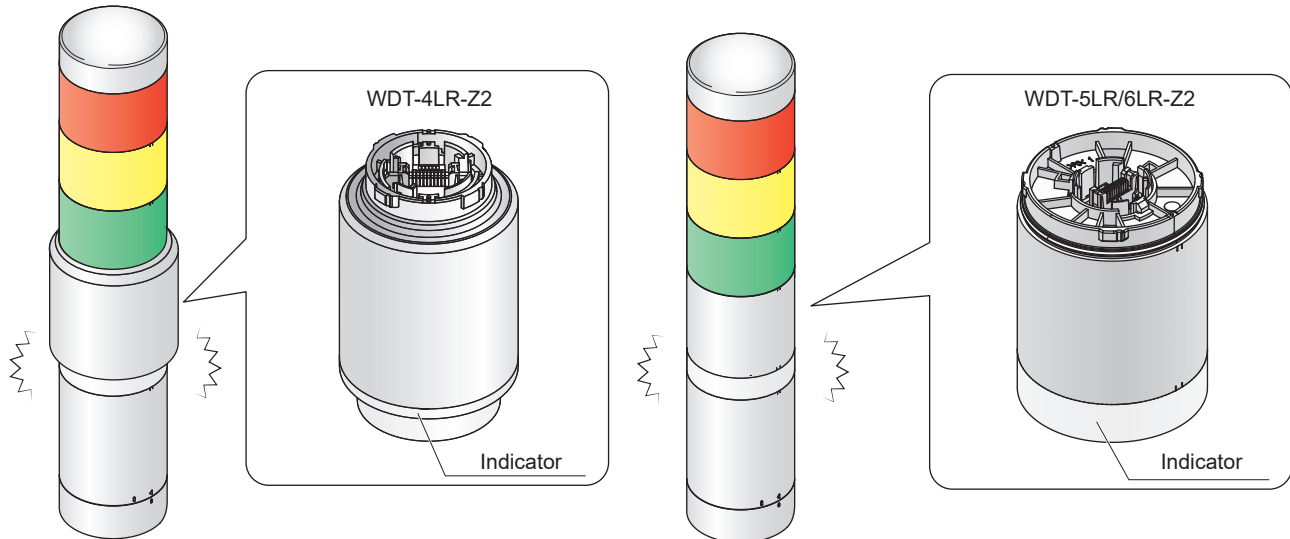

●Indicator Light Status

Status	Indicator Light	Status
Wireless Communication Quality Display	Green pulse* ¹	Indicates a good status. This status indicates the product can communicate directly with the WDR without relying on other WDT. (If the WDT and WDR are close together (within tens of centimeters), WDT may display a red pulse. For an accurate display, use units with a separation of about 1 m.)
	Amber pulse* ¹	Direct wireless connection with the WDR is not good, but the connection with nearby WDT is good. If nearby WDT have a green pulse, that WDT is used as a repeater for communication.
	Red pulse* ¹	Connection is not good with any WDR or WDT in the WD wireless network.
	Red light on	Product is waiting to join the WD Network.
Operation Status	Flashing blue	When the WDT receives a specific command from the host, flashes blue for approximately 10 seconds.
	Alternating Red→Green→Red→Green	Operating in initialization mode.
Error Status* ²	Flashing red	Error has occurred in WDT.

*1 Pulse is where the lamp fades between bright and dark repeatedly.

*2 When the indicator light shows an error status, refer to "10.1. Troubleshooting" (□ page 123).

8.1.6. Initializing the WDT

Follow the steps below to run initialization.

- 1** Turn on DIP switch 1 on WDT.
- 2** Attach the WDT to the LR series signal tower, and turn it ON.
 - After a few seconds, the indicator repeatedly alternates between red and green. At this time, initialization is complete.
- 3** Turn OFF, and detach the WDT from the LR series signal tower.
- 4** Turn off DIP switch 1 on WDT.
 - For setup items that are initialized, refer to "8.1.3.2. Setup Items" (☞ page 91).

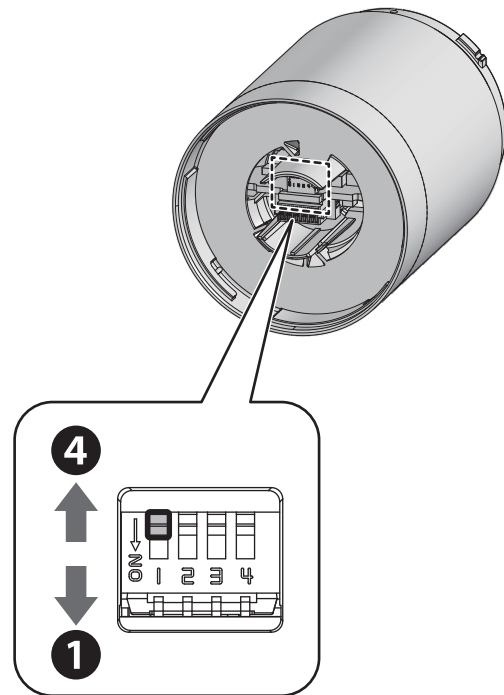

8.2. How to Use the WDR

8.2.1. WDR Mounting Method

! WARNING

- ❗ Before any work is done, make sure power is disconnected.
- ❗ Affix the product to the bracket before supplying power to the product.

! CAUTION

- ❗ The mounting location should satisfy the following conditions.
 - Minimal vibration
 - Sufficient strength
 - Flat

- 1** Remove the main unit screws from the product.
 Note: ▪Be careful not to drop the mounting screws.
- 2** Slide the main unit up and detach from the bracket.
- 3** Use screws to secure the bracket to the mounting surface.

Recommended Torque	1.4 N · m
--------------------	-----------

- Note: ▪ Screws to affix the bracket are not included. Please provide your own. (bracket thickness: 6 mm)
- Center with the mounting hole, and affix screws at two or more locations.

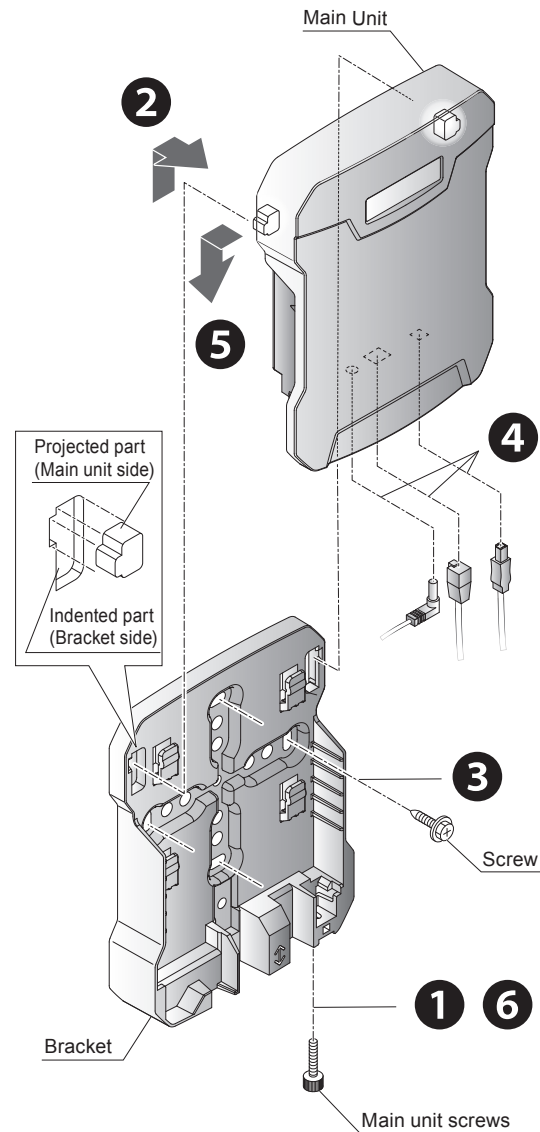
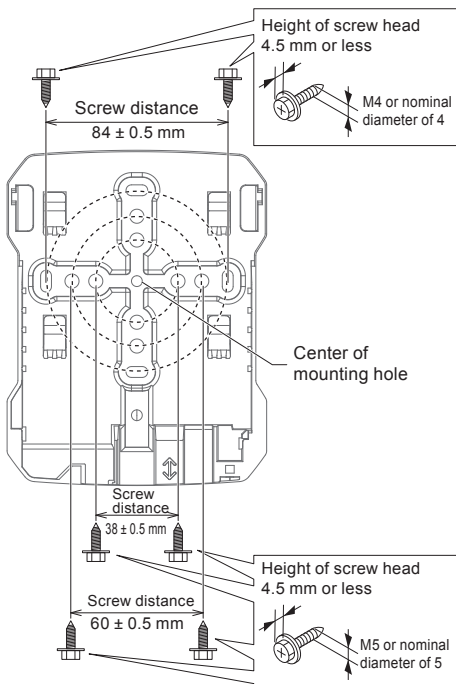

- 4** Connect a USB or LAN cable to the main unit, and connect the lead wires to the AC Adaptor or power terminal.

(☞ "8.2.2. WDR Wiring Method" (page 98))

- 5** Line up the indented part of the main unit with the projected part of the bracket, then slide the main unit down to attach to the bracket.

Note: •When attaching the main unit to the bracket, take care not to pinch the cable.

- Confirm the left and right sides of the projected/indented parts line up.
- Slide the main unit until it clicks.

- 6** Use the main unit screws to secure the main unit to the bracket.

Note: •Use the main unit screws to securely attach the main unit and bracket.

- Do not tighten the main unit screws more than necessary. Failure to follow these instructions could result in equipment damage.
- Be careful not to drop the mounting screws.

CAUTION

- !** When installing the product in a wall, install with the wiring side down. If the wiring side is up, dust and other intrusions may enter the product and cause a malfunction.

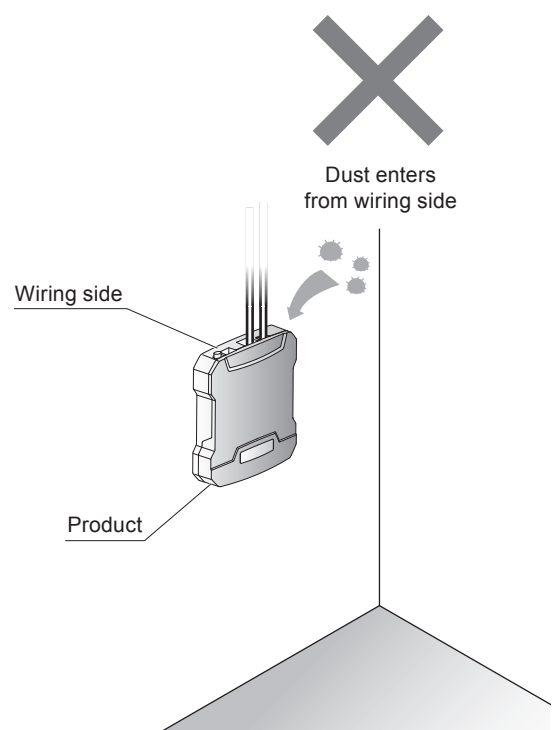
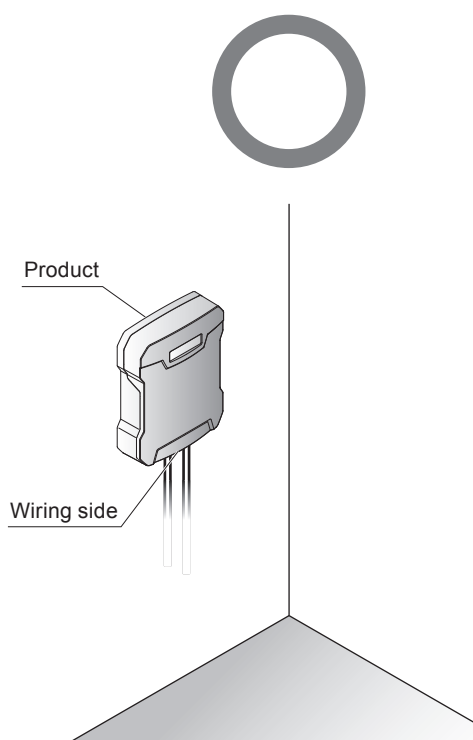

8.2.2. WDR Wiring Method

This product does not include the USB cable, LAN cable, and lead wires. Please provide your own.

! WARNING

! Wire the LAN cable, AC Adaptor, or lead wires without supplying power, and affix the product to the bracket before supplying power to the product.

! CAUTION

! Input power from either the power terminal or the AC Adaptor. (Power input is not required when connecting either a USB cable or LAN cable with PoE.)

NOTICE

- Use only IEEE802.3af compliant products with the PoE power supply.
- When both the PoE power supply and 24 VDC power supply are connected, PoE takes priority.

8.2.2.1. USB Cable Wiring Method

To prevent the USB connector from disconnecting, secure the USB cable to the cable fixing plate, included.

! CAUTION

- !** Use the supplied cable tie.
- !** Use a USB cable 3 m or shorter.
- !** When the USB connector is connected, LAN communication is not possible. Only connect the cables that will be used.
- !** For the USB cable connector that connects to the main unit, select one that satisfies the shape and dimensions shown in the figure to the right.

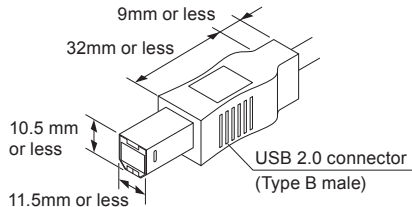

USB 2.0 connector
(Type B male)

1 Attach the cable fixing plate to the main unit.

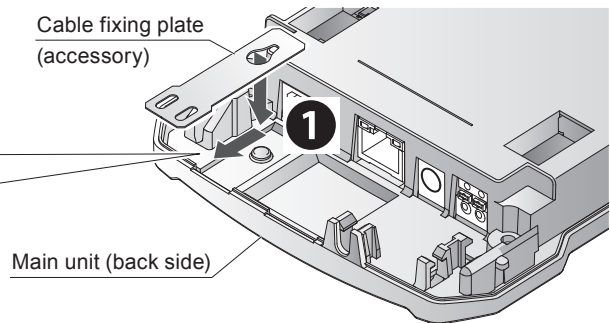
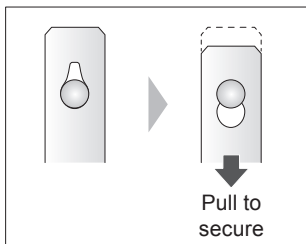

2 Attach a cable tie to the cable fixing plate.

3 Insert the USB cable into the main unit's USB connector.

4 Secure the USB cable with the cable ties.

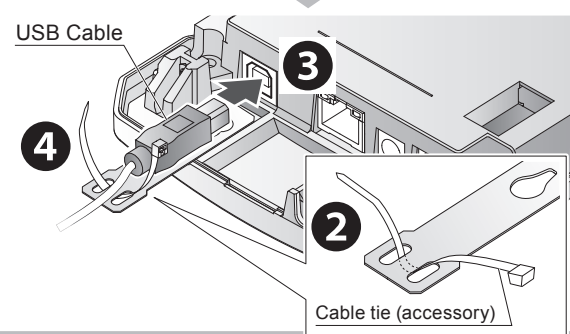

Note: Use nippers to cut any excess from cable ties.

8.2.2.2. LAN Cable Wiring Method

⚠ CAUTION

- ⊘ Do not run the LAN cable outdoors. Failure to follow this instruction could result in equipment damage as a result of lightning.
- ❗ The LAN cable should be rated for Category 5e or higher (Category 6 or higher recommended).
(You can use either straight cable or cross cable.)
- ❗ For the LAN cable RJ-45 connector that connects to the main unit, select one that satisfies the shape and dimensions shown in the figure to the right.
- ⊘ When the LAN cable is connected, do not also connect a USB cable.
- ❗ When using PoE as a power supply, use a LAN cable 50 m or shorter.

RJ-45 connector

- 1** Insert the LAN cable into the main unit's LAN port.

Note: Push in the LAN cable until it clicks.

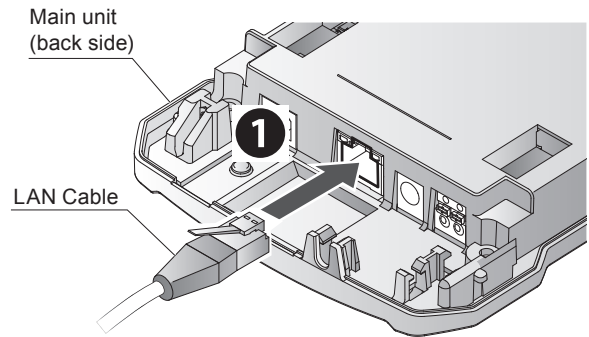

8.2.2.3. Power Supply Wiring Method

There are three different power supplies for this product: AC adaptor, power terminal and PoE.

When power is supplied from a PoE device, power is not required from an AC adaptor or power terminal.

When AC Adaptor Power Supply

⚠ CAUTION

- ❗ You can only use the supplied AC Adaptor or ADP-001 (option) in the main unit's DC power jack.

- 1** Insert the plug of the AC Adaptor (accessory or option) into the main unit's DC power jack.
- 2** Pass the AC Adaptor cord along the guides.

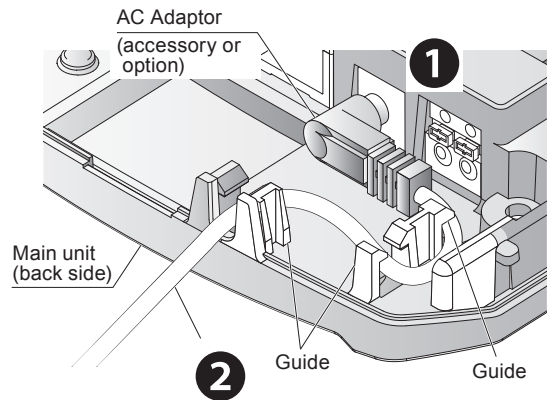

When Using Power Terminal Power Supply

! WARNING

- ❗ Be careful you insert the lead wires in the correct slots. Failure to follow this instruction could result in short-circuit and fire.
- ❗ After connecting the lead wires, confirm none of the live parts are exposed. If the live parts are exposed, a short circuit between the lead wires could result in burnout or fire.
- ⊘ Do not use a power supply of 100 W or more. Failure to follow this instruction could result in fire or electric shock.

●Power Terminal Pin Arrangement

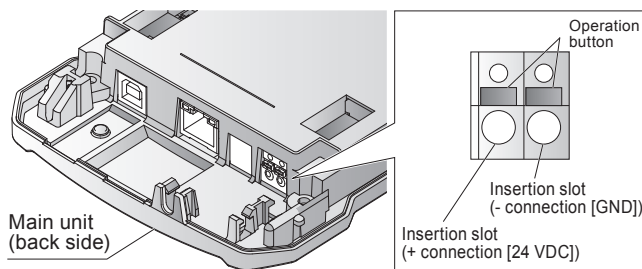

●Recommended lead wire specifications

Wire Type	UL1007/UL1430
Wire Gauge (Stranded Wire)	φ 0.51 to 1.29 mm (AWG24 to 16)

Use wire with temperature rating of 75°C or higher, and copper wire conductors.

●Power Terminal Wiring Method

- 1** Press a flat-blade screwdriver on the push button of the power terminal and push.
- 2** Insert the stripped lead wire into the insertion slot.
Note: Insert the lead wire straight in.
- 3** Pull out the screwdriver from the push button.
Note: Check if the lead wire is locked into place.
- 4** As illustrated, pass the lead wires along the guides.

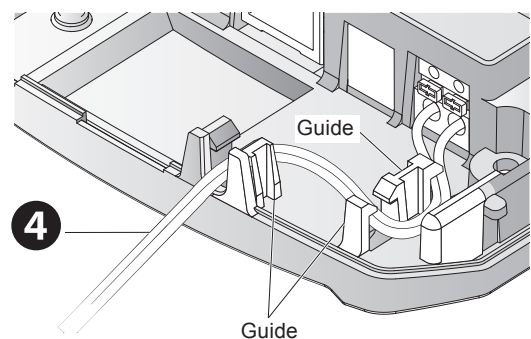
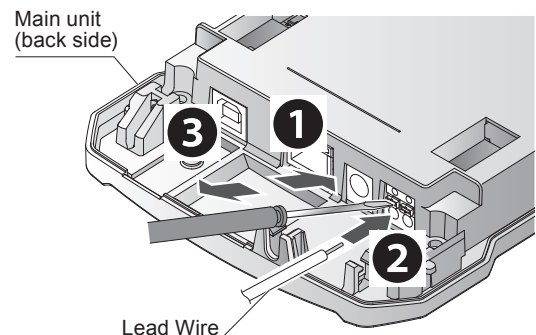
**Point**

- Use a slotted screwdriver with a blade width of 3 mm or less, and blade thickness of 0.6 mm or less. (Or equivalent)
- Do not press the push button harder than necessary with the screwdriver. Failure to follow this instruction could result in equipment damage.
- Strip 6 to 7 mm of insulation from the lead wire.
- When removing the lead wire, do not simply pull the wire to remove it. (Make sure you first press the push button down with a flat-blade screwdriver to release the lock.)

8.2.3. Setting up the WDR Main Unit

8.2.3.1. Setup Process

Use the WDR Web setup screen for WDR settings.

For the set up process of the Web Setup screen, refer to "7. WDR Setup Process" (☞ page 49).

8.2.3.2. Setup Items

	Setting	Default Value	References
Network Setup	IP Address Configuration	Set up manually	☞ "7.4.2.1. Network Setup" (page 58)
	IP Address	192.168.10.1	
	Subnet Mask	255.255.255.0	
	Default Gateway	0.0.0.0	
	DNS Server Address	0.0.0.0	
	Host Name	wdr-pro	
Clock Settings	NTP Server Address	0.0.0.0	☞ "7.4.2.2. Clock Settings" (page 59)
	Correction Interval (minutes)	60	
	Timezone	UTC+9	
User Authentication Settings	User Name	patlite	☞ "7.4.2.3. User Authentication Settings" (page 62)
	Password	patlite	
Security Settings	Communication Method	HTTP	☞ "7.4.2.4. Security Settings" (page 63)
Socket Communication Settings* ¹	Setting Port	10000	☞ "7.4.3.1. Socket Communication Settings" (page 64)
	WDR-PRO Port 1* ²	10002	
	WDR-PRO Port 2* ²	10003	
	WDR Port	10001	
Database Communication Setting* ¹	Database Communication Function* ²	Do not use	☞ "7.4.3.2. Database Communication Setting" (page 66)
	Database Address* ²	(None)	
	Database Port Number* ²	3306	
	Database Name* ²	(None)	
	User Name* ²	(None)	
	Password* ²	(None)	
Modbus/TCP Communication Setting* ¹	Port Number* ²	502	☞ "7.4.3.3. Modbus/TCP Communication Settings" (page 68)

Setting		Default Value	References
Cloud Communication Settings* ¹	Cloud Communication Function* ²	Do not use	☞ "7.4.3.4. Cloud Communication Settings" (page 69)
	Region* ²	Europe 1	
	Region Identifier* ²	eu1	
	Domain* ²	mindsphere.io	
	Client ID* ²	(None)	
	Client Secret* ²	(None)	
	Root Certificate 1* ²	Not set	
	Root Certificate 2* ²	Not set	
Select Information* ²	Select all		
Receiver Wireless Settings* ³	ExtendedPanID	0000 0000 0000 0000	☞ "7.4.4.1. Receiver Wireless Settings" (page 72)
	Frequency Channel	Select all	
	Network Startup Method	Auto Start (Recommended)	

*1 Set up the Socket Communication Setting, Database Communication Setting, Modbus/TCP Communication Setting, and Cloud Communication Settings only when they are used.

*2 Cannot set on the WDR-L-Z2-PRO-L or WDR-LE-Z2-PRO-L.

*3 Set WDR-L-Z2-PRO-L and WDR-LE-Z2-PRO-L in WDS-WIN01.

8.2.3.3. Required Equipment

- For system configuration when setting up WDR equipment, refer to "5.2.3. Example System Configuration When Setting Up Equipment (using the Setup Kit)" (☞ page 28).
- Use the WDR Web setup screen for the WDR device settings.
- The setup procedure is as follows.

STEP 1 Turn ON the WDR

This manual

"8.2.5. Checking the WDR Status Lamp" (☞ page 105)



After power is turned on, the WDR takes approximately 50 seconds to complete startup. Check the WDR status lamp to confirm startup is complete.

STEP 2 Set up WDR User Authentication

This manual

"7.1. Set Up the User Name and Password for the WDR's Web Setup Screen" (☞ page 49)



After setting up user authentication, to log in again start from step 3. If user authentication is not set up, you cannot proceed to the login screen.

STEP 3 Log in to the WDR Web Setup Screen

This manual

"7.2. Display WDR Web Setup Screen" (☞ page 51)

STEP 4 Set the WDR network*, time, and user authentication

This manual

"7.4.2. System Settings" (☞ page 58)

*Set the IP address last.

STEP 5 Set WDR Wireless Settings

This manual

"7.4.4.1. Receiver Wireless Settings" (☞ page 72)

*Set up also possible with system configuration software WDS-WIN01. For using WDS-WIN01, refer to ☞ "WDS-WIN01 Instruction Manual".

*For WDR-L(E)-Z2-PRO-L, set with system configuration software WDS-WIN01.

STEP 6 Set WDR Host Communication Settings

This manual

"7.4.3.1. Socket Communication Settings" (☞ page 64)

When Run Using Socket Communication

This manual

"7.4.3.2. Database Communication Setting" (☞ page 66)

When Run Using Database Communication

This manual

"7.4.3.3. Modbus/TCP Communication Settings" (☞ page 68)

When Run Using Modbus/TCP Communication

This manual

"7.4.3.4. Cloud Communication Settings" (☞ page 69)

When Run Using Cloud Communication

8.2.4. WDR DIP Switch Operations

⚠ WARNING

❗ Before installing and wiring this product, be sure that it is disconnected from the power source. Failure to comply may result in fire, electrocution or product malfunction..

⚠ CAUTION

- ⊘ Do not use excessive force on this product. Failure to follow this instruction could result in deformed frame and product damage.
- ⊘ Do not use sharp tipped objects with this product. Operation may become impossible as scratches develop on switches and switch contacts are interfered with.
- ⊘ The initial setting for the maintenance DIP switch is OFF. Do not set ON.
- ⊘ Do not insert anything into the maintenance card slot.

The product's DIP switches are located where you detach the direct mount bracket.

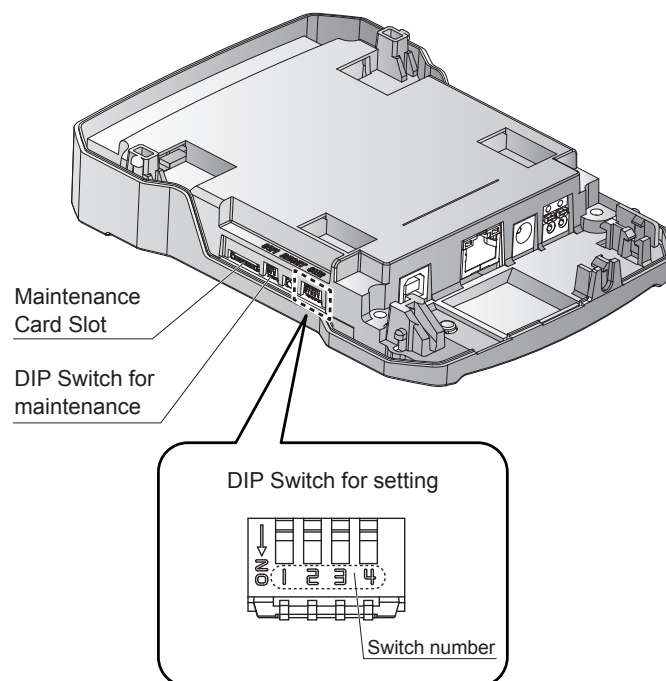

●DIP Switch Settings

Switch number*				Description
1	2	3	4	
OFF	OFF	OFF	OFF	Runs normal operations.
ON	OFF	OFF	OFF	Initializes Network Setup and User Settings. ☞ "8.2.6. Initializing the WDR" (page 107)
ON	ON	OFF	OFF	User authentication settings (user name and password) are initialized. ☞ "8.2.6. Initializing the WDR" (page 107)
ON	ON	ON	ON	Initializes all the settings. ☞ "8.2.6. Initializing the WDR" (page 107)

*The initial settings are all OFF.

8.2.5. Checking the WDR Status Lamp

Use the lights on the main unit's status lamp to check the operation.

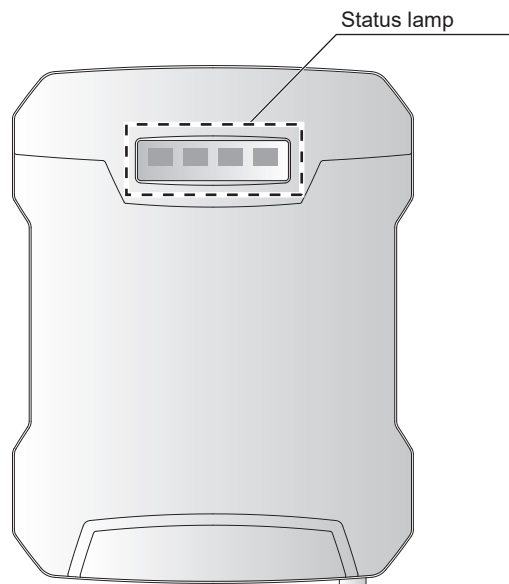

• Normal Status

- From powering-on to completing startup, lights are as follows.

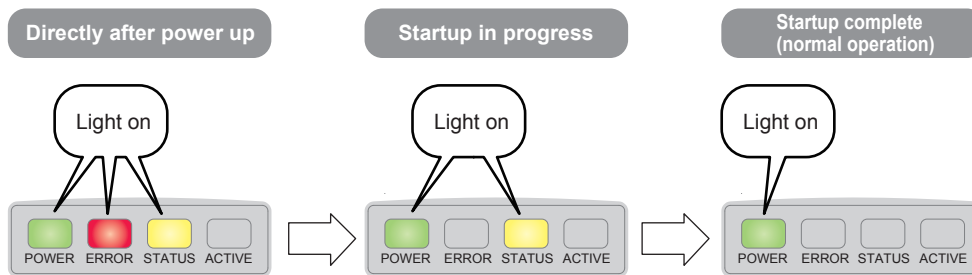

- The ACTIVE lamp lights up when there is WDT wireless data communication.

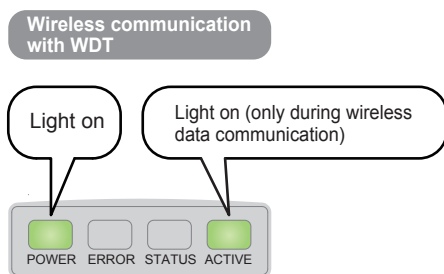

● Initialization Status

- When initializing with the Setting DIP switch, lights up as follows.

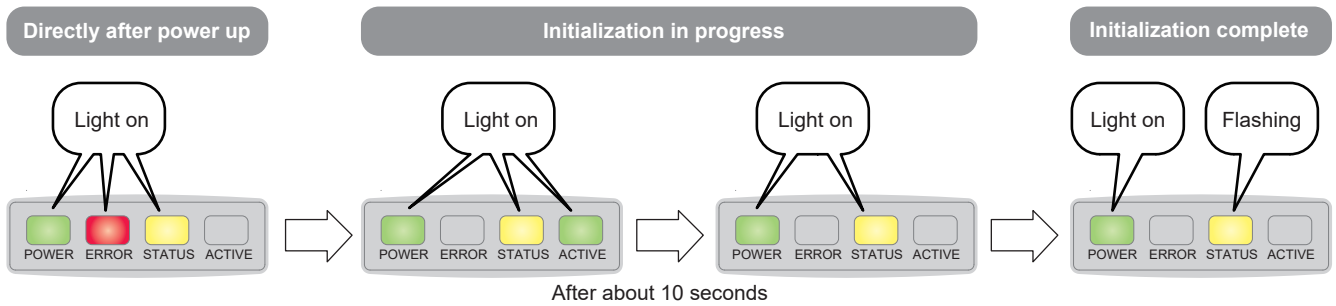

- When initializing with the Web Setup Screen, lights up the same as the normal status.

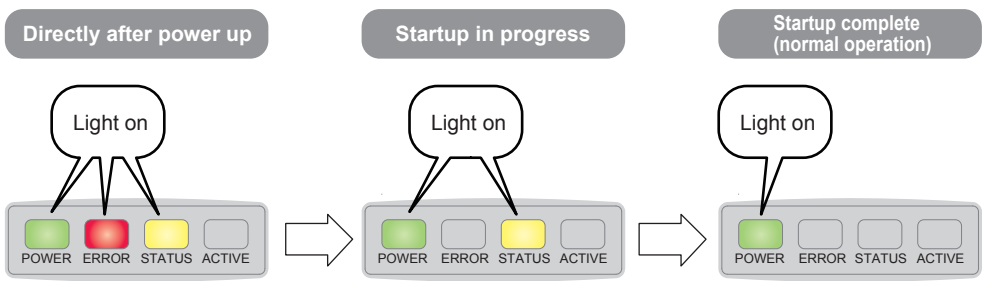

● Error Status*

- When an error occurs, the ERROR lamp either lights up or flashes.

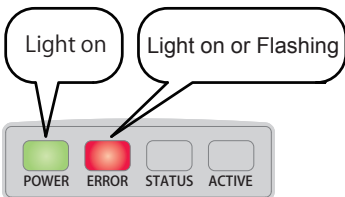

*When the status lamp indicates an error status, refer to "10.1. Troubleshooting" (page 123).

8.2.6. Initializing the WDR

To initialize the WDR, there are 2 patterns*, either use dip switches or the Web Setup Screen. Different items are initialized with each method.

Initialization Items		Initialize from the Web Setup Screen			Initialize from DIP Switches			
		Network Setup	Host Communication Settings	Wireless Settings	Network Setup/User Authentication Settings	User Authentication Settings	All Settings	
System Settings	Network Setup	IP Address Configuration	•			•		•
		IP Address	•			•		•
		Subnet Mask	•			•		•
		Default Gateway	•			•		•
		DNS Server Address	•			•		•
		Host Name	•			•		•
	Clock Settings	NTP Server Address						•
		Correction Interval (minutes)						•
		Timezone						•
	User Authentication Settings	User Name				•	•	•
Password					•	•	•	
Security Settings	Communication Method						•	
Host Communication Settings	Socket Communication Settings	Setting Port		•				•
		WDR-PRO Port 1		•				•
		WDR-PRO Port 2		•				•
		WDR Port		•				•
	Database Communication Settings	Database Communication Function		•				•
		Database Address		•				•
		Database Port Number		•				•
		Database Name		•				•
		User Name		•				•
	Password		•				•	
Modbus/TCP Communication Settings	Port Number		•				•	

Initialization Items		Initialize from the Web Setup Screen			Initialize from DIP Switches		
		Network Setup	Host Communication Settings	Wireless Settings	Network Setup/User Authentication Settings	User Authentication Settings	All Settings
Cloud Communication Settings	Cloud Communication Function		•				•
	Region		•				•
	Region identifier		•				•
	Domain		•				•
	Client ID		•				•
	Client Secret		•				•
	Root Certificate 1		•				•
	Root Certificate 2		•				•
	Select Information		•				•
	Receiver Wireless Settings	ExtendedPanID			•		
Frequency Channel				•			•
Network Startup Method				•			•
Register Transmitter User Name	Transmitter User Name						•
Language settings							

*When any pattern is initialized, the Signal Tower information, wireless quality information, counter information, and various log data are also initialized.

Initialize with Setting DIP Switch

- 1** Set ON the WDR Setting DIP switch.
 - When initializing the Network Setup and User Authentication Settings, set [1] to ON.
 - When initializing the User Authentication Settings, set [1], and [2] to ON.
 - When initializing all the settings, set [1], [2], [3], and [4] to ON.
- 2** Power up the WDR.
 - Check the WDR status lamp to check the initialization status. For information, refer to "8.2.5. Checking the WDR Status Lamp" (☞ page 105).
- 3** Power down the WDR.
- 4** Set OFF WDR Setting DIP switches [1], [2], [3], and [4].

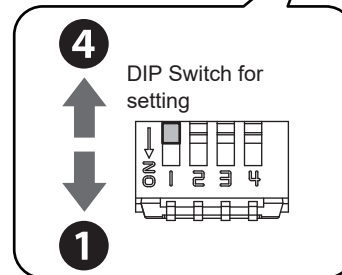
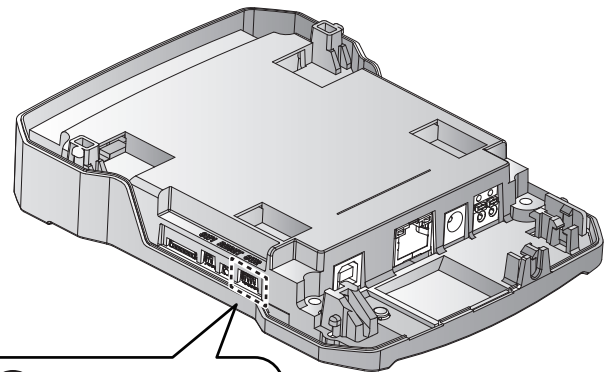

Initialize from the Web Setup Screen



For information, refer to "7.4.5.3. Initialize" (☞ page 83).

8.2.7. Rebooting WDR

To reboot the WDR, there are two patterns, either use the reset switch or the Web Setup Screen.

Using Reset Switch

CAUTION

-  Do not use excessive force on this product. Failure to follow this instruction could result in deformed frame and product damage.
-  Do not use sharp tipped objects with this product. Operation may become impossible as scratches develop on switches and switch contacts are interfered with.

1 While the WDR status indicates startup complete, press the reset switch.

- Check the WDR status lamp to check the reboot status. For information, refer to "8.2.5. Checking the WDR Status Lamp" ( page 105).

2 After about 50 seconds, the [STATUS] lamp turns off and reboot is complete.

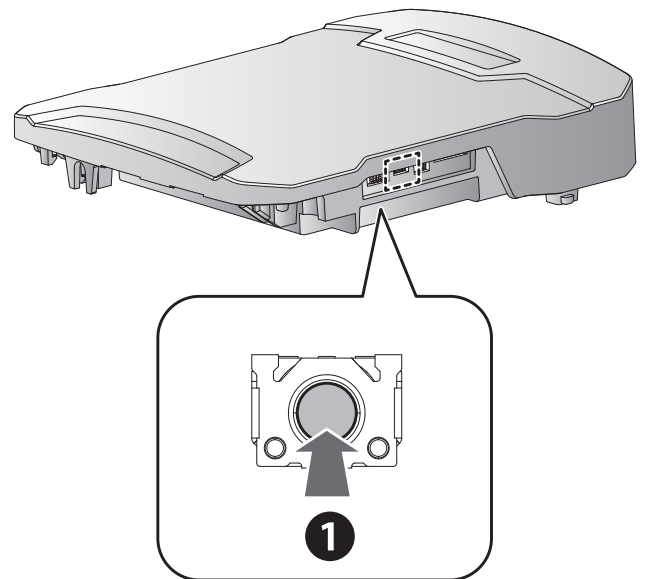

Reboot from the Web Setup Screen

For information, refer to "7.4.5.4. Reboot" ( page 85).

9. Function Details

9.1. WDT Functions

9.1.1. Wireless Data Transmission Function

9.1.1.1. Transmit Signal Tower Information

- Function whereby the WDT transmits the status of the Signal Tower control line wirelessly to the WDR. For the timing of transmissions, you can select from the following two types of settings.

Setting*	Description
Immediate Transmission	Send immediately after the status of the signal tower control line changes.
Request Transmission	Send only after receiving a request from the host PC.

*Select the setting in WDS-WIN01 or the WDR Web Setup Screen.

*The initial setting is [Immediate Transmission].

- Signal tower information transmitted by the WDT is as follows.

Item	Description					
Description	Signal display					Buzzer*
	Red	Amber	Green	Blue	White	
Status	Light on, Flashing, Light off					Buzzer on, Buzzer off

*Only when extended format is selected.

- Relationship between the units and wiring

Regardless of the number and whether each unit (LED Unit, Buzzer Unit) connected to the WDT Signal Tower exists, the Signal Tower transmits information input to the signal tower control line.

9.1.1.2. Select Format of Signal Tower Information

Function for selecting the format of signal tower information transmitted by the WDT. You can select the following two types of formats.

Setting*	Description
Extended Format	Can set up six types of signal tower control lines (red, amber, green, blue, white, and buzzer).
Standard Format	<ul style="list-style-type: none"> Format compatible with WDT-5E-Z2 and WDT-6M-Z2. From five types (red, amber, green, blue, and white), can set up four signal tower control lines.

*Select using the Setting DIP switches. For information, refer to "8.1.4. WDT DIP Switch Operations" (☞ page 93).

*The initial setting is [Standard Format].

9.1.1.3. About Periodic Transmissions

- WDT can be set up to automatically transmit information at defined intervals. When Periodic Transmission is enabled, information is transmitted at about 10 second intervals.
- If the number of information transmissions is as low as a few times per hour, the communication is more stable if you set [Enable]. With this setting, you can select from the following 2 types.

Setting*	Description
None	Periodic transmissions are not performed.
Yes	Send transmissions at regular intervals.

*Select using the Setting DIP switches. For information, refer to "8.1.4. WDT DIP Switch Operations" (☞ page 93).

*The initial setting is [Disable].

9.1.1.4. Mesh Network Transmission

Function that interconnects the WDT and transmits information to the WDR over the optimum communication route. A dense mesh status increases communication redundancy. The following is an illustration showing the mesh status.

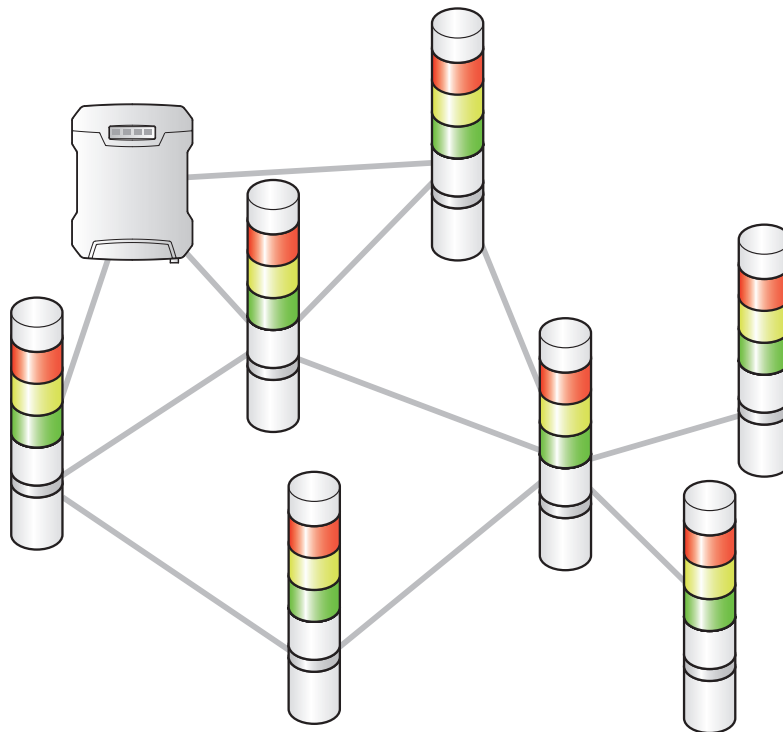

9.1.1.5. Simple Counter Function

- WDT function for saving the accumulated value (counter value) of pulse inputs (incremented 1 at a time) on a Signal Tower control line.
- At startup the counter value is 0 (initial value).
- The value range of the counter is 0 to 4,294,967,295.
- Pulse inputs are determined using the following criteria.

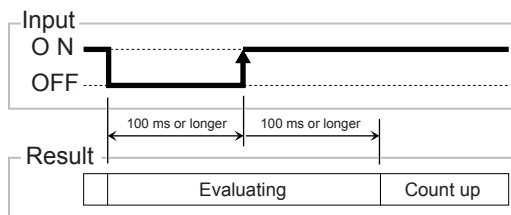

Point

- When counting up exceeds the upper limit, the counter value returns to 1.
- When the power is shut down, the counter value is cleared to 0.
- In WDS-WIN01, you can reset the counter value to 0 (initial value).
- Regardless of changes in states, the Signal Tower information in the counter settings is not transmitted. The Signal Tower information is treated as if the light is off and buzzer is off.

*Select the Signal Tower control line for the simple counter in WDS-WIN01 or with DIP switches on the WDT main unit. For information, refer to "8.1.4. WDT DIP Switch Operations" (📖 page 93)

*When set with the WDT Setting DIP switch, it is fixed to blue. When set in WDS-WIN01 or WDR Web Setup Screen, you can select from red, yellow, green, blue, white, and buzzer.

*The default setting for the simple counter is [Do not use].

9.1.2. Signal Tower Input Functions

9.1.2.1. Determine Signal Tower Input

- There are two types for determining Signal Tower control line inputs, [Normal] and [Flashing]. Select in WDS-WIN01 or the WDR Web Setup Screen. If there is no flashing state to get, use [Normal].

Setting* ¹	Determination	Description
Normal	Light on	When the Signal Tower control line input status changes OFF→ON, the result is "light on" and the information is transmitted.
	Light off	When the Signal Tower control line input status changes ON→OFF, the result is "light off" and the information is transmitted.
Flashing Determination* ² * ³	Flashing	When the Signal Tower control line input status repeatedly alternates ON→OFF→ON→OFF..., the result is "flashing" and the information is transmitted. Select from the following 3 determination speeds. • Flashing (short) • Flashing (medium) • Flashing (long)
	Light on	When the Signal Tower control line input status changes OFF→ON, the result is "light on" and the information is transmitted.
	Light off	When the Signal Tower control line input status changes ON→OFF, the result is "light off" and the information is transmitted.

*1 The initial setting is [Flashing (medium)].

*2 Flashing is determined when there are two status changes within a defined period. This period is called "SS seconds". You can select "SS seconds" from three different time periods.

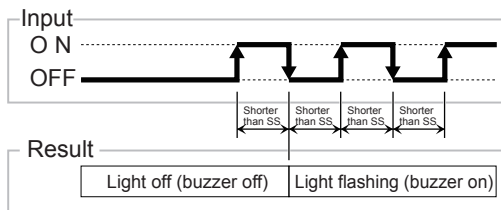

- Flashing (short): SS seconds = 0.7. seconds
- Flashing (medium): SS seconds = 1.5. seconds
- Flashing (long): SS seconds = 2.5. seconds

*3 There is not [Flashing] status in the buzzer signal. When determined as flashing, the buzzer on information is transmitted.

- The status and determination operations are as follows. Information in brackets "()" represent buzzer operation.

Setting	Determination	Description	
		Change in state	Operation result
Normal	Light on	Light off → light on	
	Light off	Light on → light off	

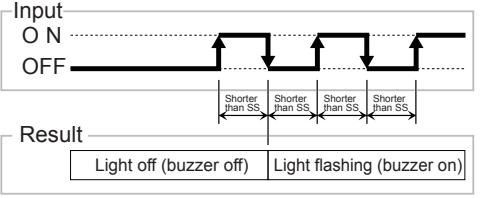
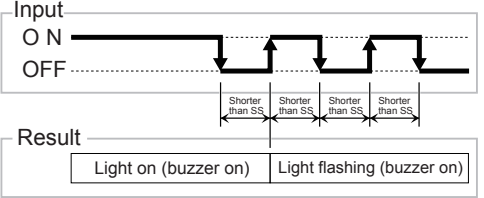
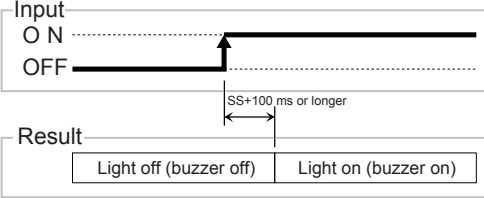
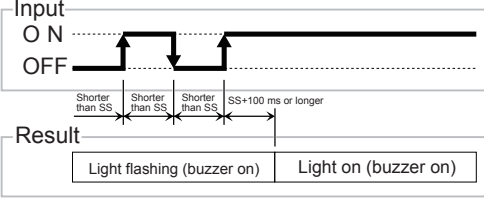
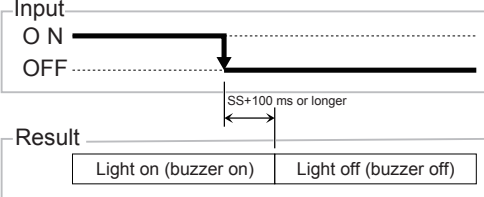
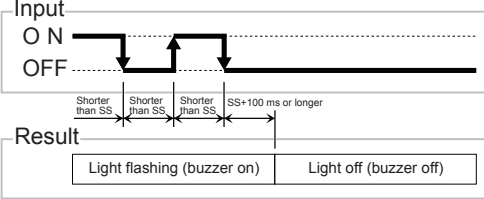
Setting	Determination	Description	
		Change in state	Operation result
Flashing Determination	Flashing	Light off → flashing	
		Light on → flashing	
	Light on	Light off → light on	
		Flashing → Light on	
	Light off	Light on → light off	
		Flashing → light off	

! CAUTION

- ❗ Input a signal based on the above timing for the determination operation. Determination may not be possible using any other timing than the above determination operation.
- ❗ When using normal determination and you need to change the input state of multiple signal tower control lines at the same time, the interval between these state changes need to be within 20 ms.

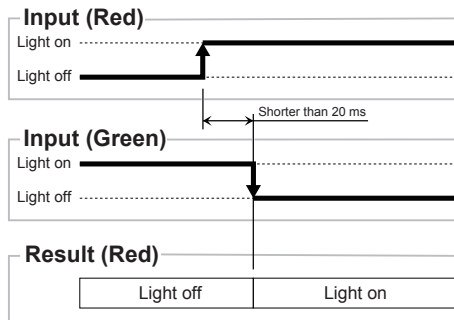

- ❗ When using normal determination and you do not need to change the input state of multiple signal tower control lines at the same time, the interval between these state changes need to be 100 ms or longer.

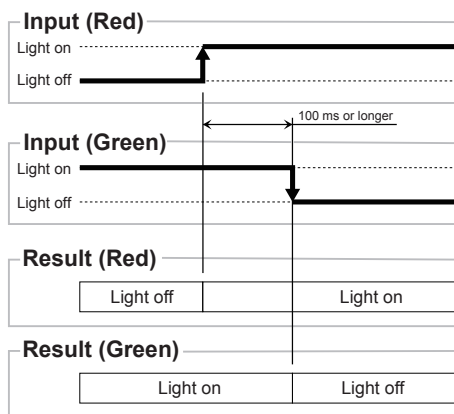

9.2. WDR Functions

9.2.1. Host Communication Function

9.2.1.1. Socket Communication

- Function for communicating with applications on the host via the TCP socket. WDR operates as a TCP server and listens for connection requests from host applications.
- The following four ports can be set for socket communication. For setup, refer to "7.4.3.1. Socket Communication Settings" (☞ page 64).
- When using WDS-WIN01 with CSV File, use the WDR port. When the WDR port is in use and you only need to use WDS-WIN01 for setup, use the Setting Port.
- For information on the WD PRO port, refer to ☞ "Application Notes for WD PRO Receiver".

Item	Description
Setting Port	Settings port on the WDR and WDT. Receives only setting-related commands from the host.
WDR-PRO Port 1	<ul style="list-style-type: none"> • Port for collecting WDT information. Cannot set WDR or WDT. • You can independently use port 1 and port 2 at the same time.
WDR-PRO Port 2	
WDR Port	Port for collecting WDT information, and for setting WDR and WDT.

⚠ CAUTION

⚠ Cannot use WDR-PRO Port 1 and 2 on the WDR-L-Z2-PRO-L or WDR-LE-Z2-PRO-L.

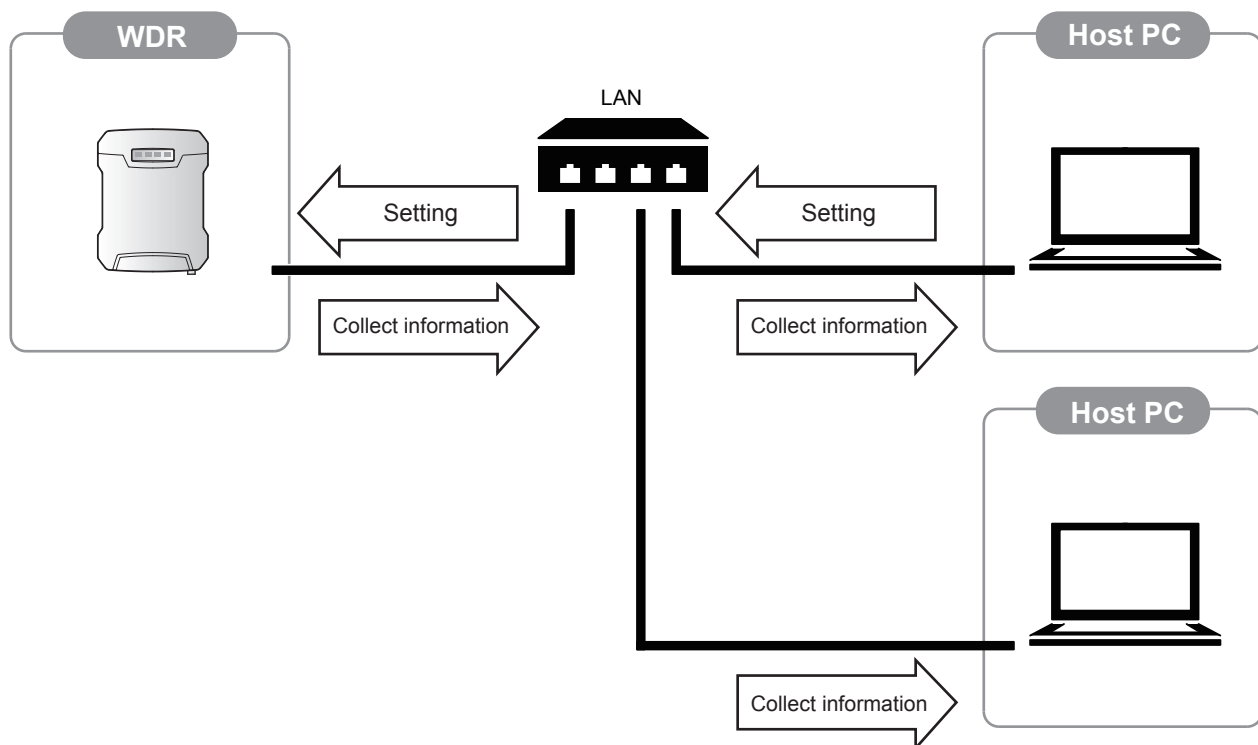

9.2.1.2. Database Communication

As a MySQL client, function for connecting to the database and outputting data. Update to the database occurs immediately after changing the Signal Tower information. For setup, refer to "7.4.3.2. Database Communication Setting" (☞ page 66).

Supported Databases	MySQL 5.6 or later
SQL Command	<ul style="list-style-type: none"> • INSERT (record insertion) • UPDATE (simple counter only)

⚠ CAUTION

⚠ Cannot use this function on the WDR-L-Z2-PRO-L or WDR-LE-Z2-PRO-L.

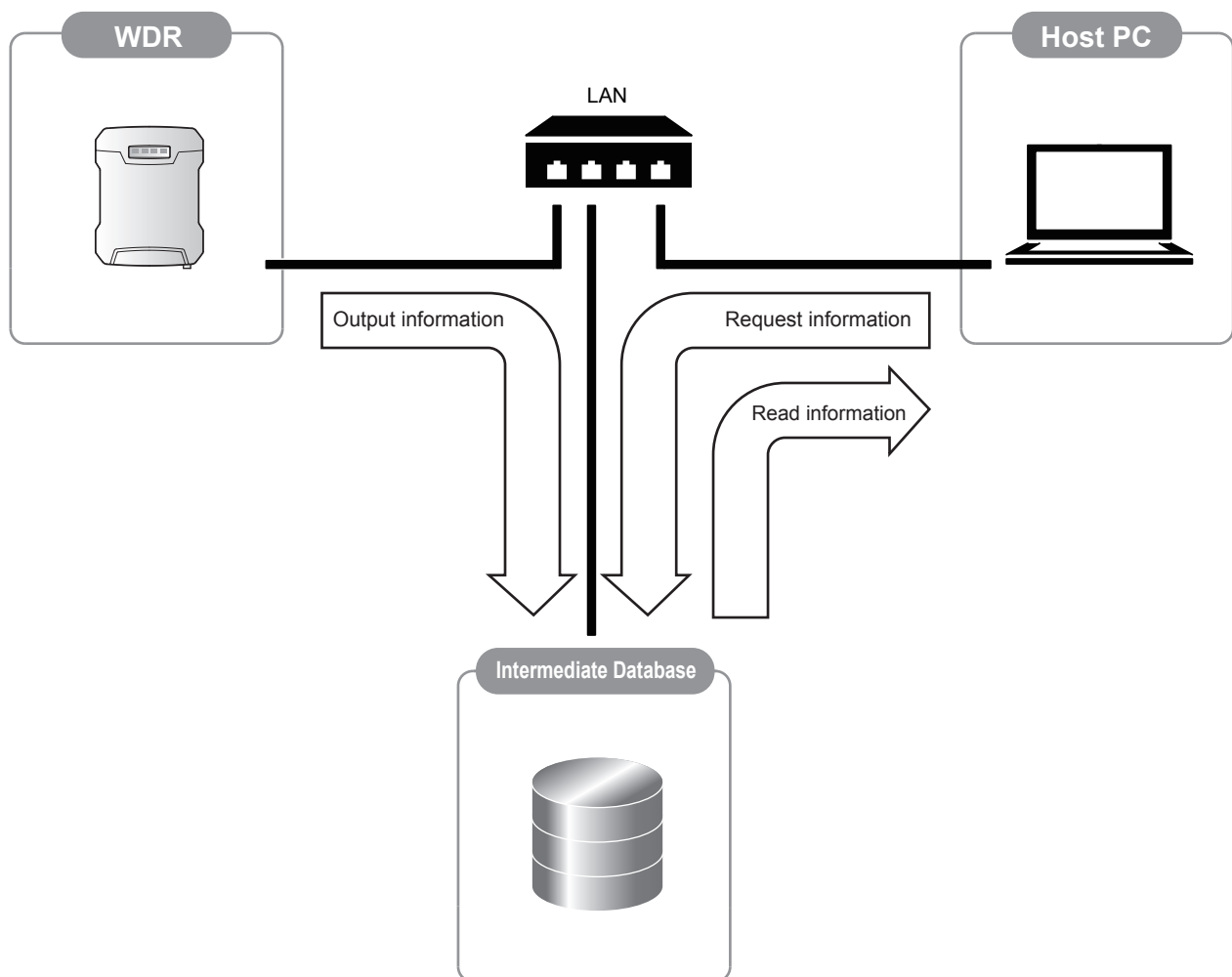

9.2.1.3. Modbus/TCP Communication

Operating as a Modbus slave, transmits the current WDT status in response to data requests from the Modbus master. For setup, refer to "7.4.3.3. Modbus/TCP Communication Settings" (☞ page 68).

⚠ CAUTION

⚠ Cannot use this function on the WDR-L-Z2-PRO-L or WDR-LE-Z2-PRO-L.
 ⚠ Cannot get the WDT status change history.

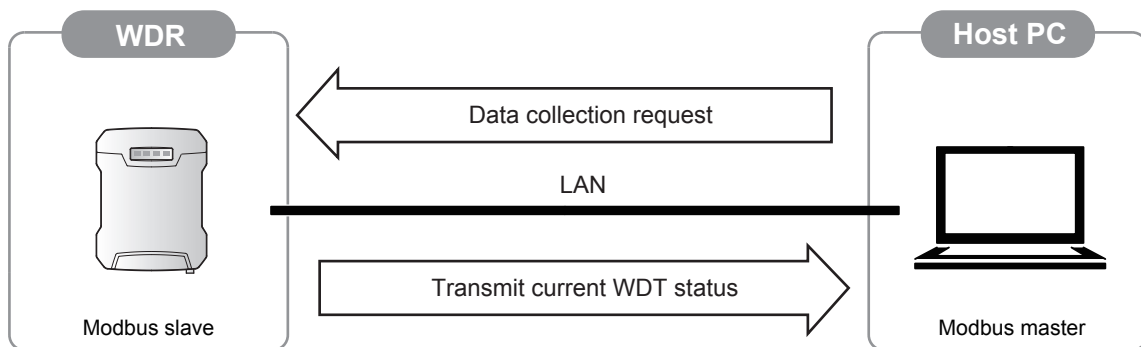

Point

- Only transmitters with registered Transmitter User Names can get data. For information, refer to "7.4.4.5. Register Transmitter User Name" (☞ page 79).

9.2.1.4. USB Communication

Data collected from a transmitter is output to the host via USB communication.

⚠ CAUTION

⚠ When connected via USB, you cannot access the Web browser screen.
 ⓧ During LAN communication, do not connect to USB.

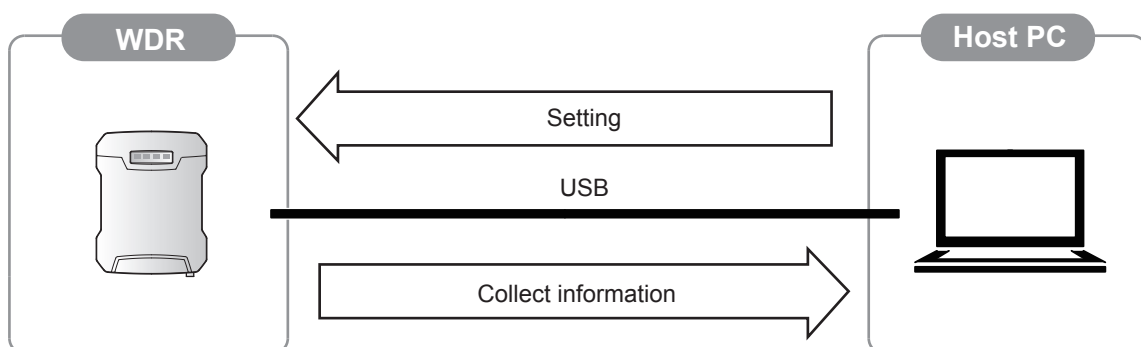

9.2.1.5. Cloud Communication

You can select MindSphere as a cloud service.

By linking with MindSphere, you can upload the WDT status and partially control WDT. For the set up process, refer to "7.4.3.4. Cloud Communication Settings" (page 69).





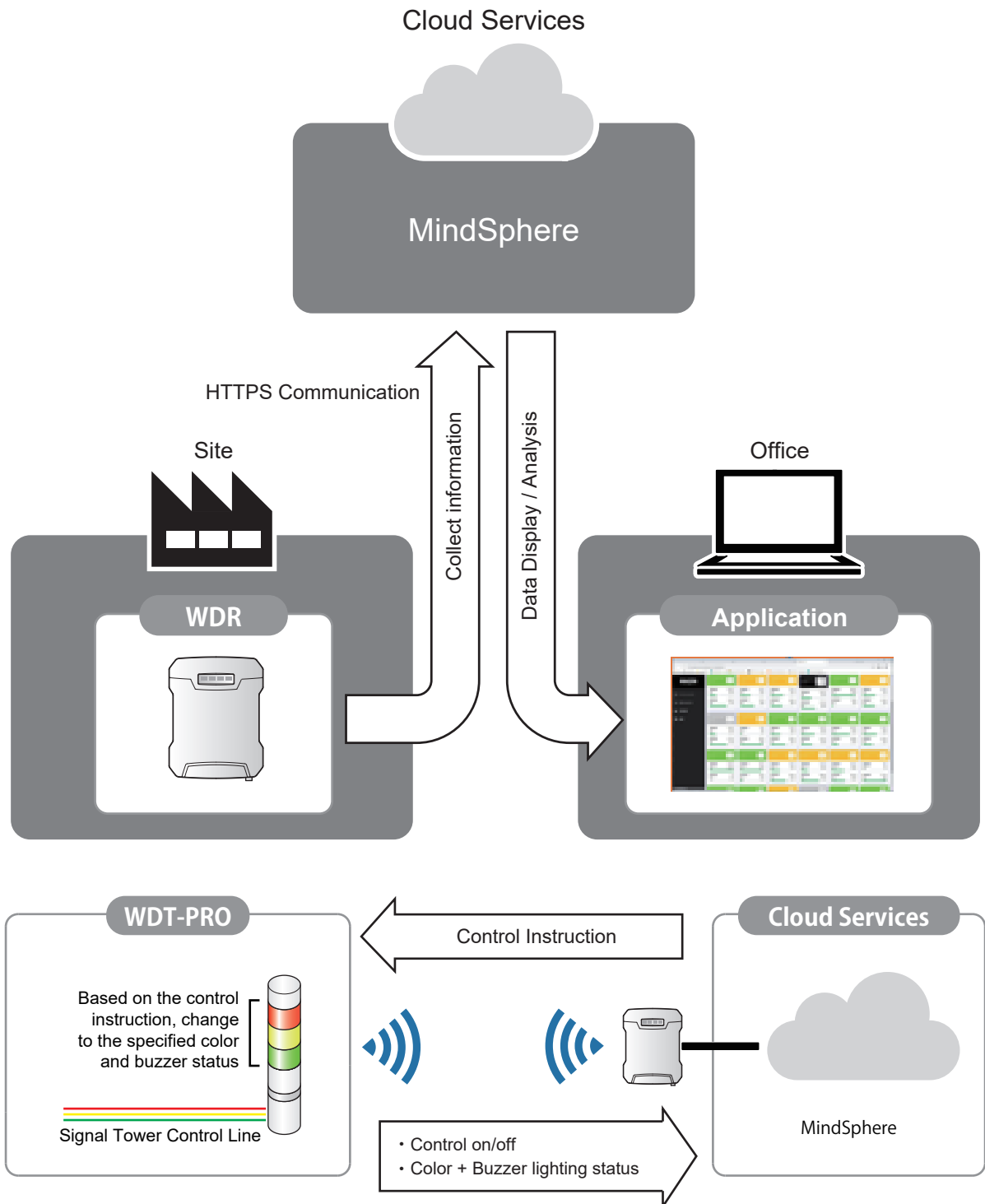

⚠ CAUTION

⚠ You cannot use this function on WDR-L-Z2-PRO-L or WDR-LE-Z2-PRO-L.



9.2.2. Self Diagnosis Function

- This function evaluates the communication quality of the WDT on the WD system. You can either diagnose the current wireless environment, or diagnose the wireless environment continuously for a specified period. For setup and operation, refer to "7.4.4.3. Wireless Connection Diagnosis" ( page 76).

 CAUTION	
	The evaluation result from this function is only a prediction of results and does not guarantee the transmitter's communication quality.
	Since evaluation results are largely affected by the installation environment, evaluation results may differ each time it is run.
	Evaluation results are predicted based on changes in radio field intensity, which is affected by communication distance and obstacles. Therefore, evaluation results do not include the effects of noise that could completely block radio waves.
	During the diagnosis period, a large amount of data is transmitted and received via wireless communication, which could significantly delay Signal tower information, or be lost altogether.
	If the WDT and WDR are close together (within tens of centimeters), a diagnosis of rank D may occur. For an accurate diagnosis, use with a separation of about 1 m.

- For each WDT, diagnosis results are ranked in five levels: A, B, C, D, and E.

Rank	Description
A	WDT communicates directly with the WDR with sufficient quality. There are no issues with the installation environment.
B	Although the WDT does not communicate with sufficient quality for direct communication with the WDR, the WDT can communicate with sufficient quality using communication paths (communication hopping) using other WDT. There are no issues with the installation environment.
C	Although the WDT does not communicate directly with the WDR, the WDT can communicate with sufficient quality using communication paths (communication hopping) using other WDT. As long as the other WDT acting as intermediaries continue to operate, there are no issues with the installation environment.
D	The quality of the communication path between WDT and WDR is insufficient. Although communication is currently possible, it is recommended to adjust the installation environment as communication can be lost at any time.
E*	WDT cannot communicate with the WDR. The installation environment must be changed.

*Rank E will not appear for WDT that have not had their transmitter user name registered on the WDR Web Setup Screen.

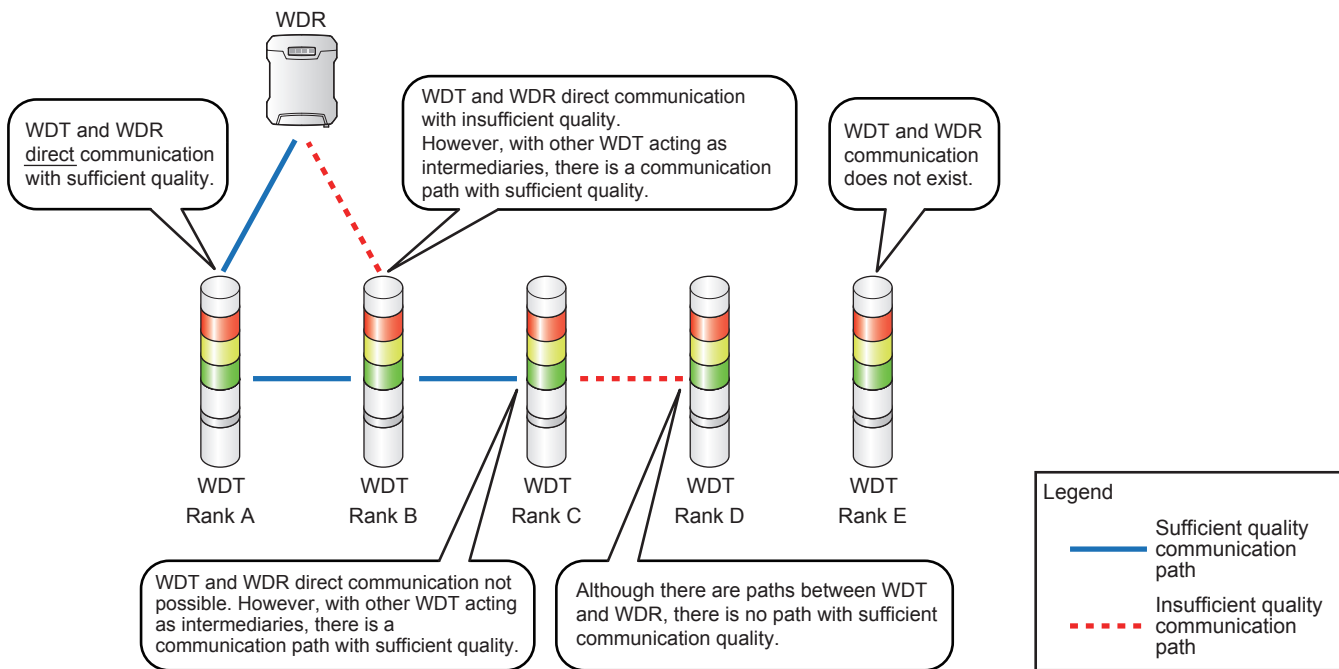

- Changes to the installation environment are recommended for diagnosis results of rank D or E. Communication quality is greatly affected by conditions in the installation environment, try the following .

No.	Method	Effect
1	Adjust the position, height, and orientation of WDR and WDT.	Nearby objects interfere with and reflect radio waves from wireless communication. Communication may improve by moving, even as little as 1 m, the position or height of WDR and WDT.
2	To reduce their impact on wireless communication, move metal objects out of the way.	If there is a large metal object in the installation environment, there may be spots where radio waves cannot reach. Communication may improve by moving metal objects out of the way.
3	Add WDT to the WD wireless network to act as a repeater and enable communication hopping.	Adding a WDT to the WD wireless network increases the choice of communication paths. Even adding a WDT near the WDR could improve communication quality of the entire WD wireless network.

10. Troubleshooting

10.1. Troubleshooting

10.1.1. WDT (Transmitter)

Issue	Checklist
Indicator does not light up.	Check if the unit is installed correctly.
	Check if wiring for the power supply is correct.
The indicator is flashing red. (not pulsing)	Turn off the power on the WDT and turn on again. If it continues to flash red, it may be an indication that the settings are corrupted. Initialize the product and set up again.
The indicator does not change from a red light to a red pulse.	Wireless connection with WDR is in progress. <ul style="list-style-type: none"> • Depending on the radio wave environment, it may take some time to complete the connection. Check the indicator again after about 5 minutes. • Check if the WDR is working properly. • The ExtendedPanID in the WDR must match the wireless channel setting for a connection. Make sure the settings are correct. • Check for any sources of noise (such as microwave ovens) in the surrounding area that could impede wireless communication.
The indicator flashes blue.	When the host sends a call command to the WDT, the indicator flashes blue for a short period of time.
The indicator flashes alternating between green and red.	Starting up in initialization mode. If operations are normal, turn off DIP switch 1 on the product.
The host cannot determine if the WDT is available.	If a wireless connection cannot be completed, the host cannot check if the WDT is available. Check if the indicator on the target WDT is pulsing, to indicate connection is complete.
Cannot get the buzzer input information.	When Signal Tower information format is [Standard Format], cannot get buzzer input information. Set [Extended Format].
Counter value is not increasing.	Use Setting DIP switches or WDS-WIN01 to select the Signal Tower control line to use with the simple counter.

10.1.2. WDR (Receiver)

Issue	Checklist
Login screen does not display.	Check if the LAN cable is connected properly.
	Check if the IP address settings on the product are incorrect.
	Check if the IP address settings on the PC are incorrect.
	For IP address settings, refer to "7.4.2.1. Network Setup" (☞ page 58).
Login screen does not display correctly.	Update the browser information.
	In the browser settings, enable Javascript and automatic page loading.
The POWER status lamp does not turn on.	When using the DC power jack, connect only the supplied AC Adaptor.
	When using a screwless terminal block, check the polarity (+/-) of the power lines and turn on the power supply.
	When power is supplied from an USB cable, do not use a hub. Normal operation may not be possible as the current may be insufficient.
	When supplying power over a LAN cable (PoE), connect the product to the PoE power supply.
The ERROR status lamp is red.	Turn off the power on the WDR and turn on again. If it continues to display red, it may be an indication that the WDR may have failed. Please contact your local sales representative.
The STATUS lamp is yellow.	The lamp is yellow while WDR is starting up, or in initialization mode and starting up. If it is starting up, wait awhile for startup to complete and the lamp will turn off. When starting up from initialization mode, set OFF all Setting DIP switches then turn the power back on.
The STATUS lamp is flashing yellow.	After the WDR is initialized, the lamp flashes yellow. Set all Setting DIP switches OFF before turning the power back on.
The ACTIVE status lamp turns green irregularly.	While the WDR uses wireless communication, the lamp turns green at irregular intervals.
Connected to the host via USB, but cannot communicate.	After selecting the correct port, connect the COM port. Operation when connecting via a hub has not been confirmed. Use this product by connecting directly to the USB port.
Connected to the host via LAN, but cannot communicate.	The default is 192.168.10.1. If you changed the IP address, set that IP address and connect. If you do not know the IP address anymore, initialize the LAN communication settings and check the communication again.
There is no notice on the host that the WDR has powered down.	WDR disconnect notices from the 30th unit and beyond are not output.
Wireless Connection Diagnosis result is showing "Error".	Run Wireless Connection Diagnosis again. If "Error" continues to display, restart the WDR unit and run Wireless Connection Diagnosis again. If "Error" still continues to display, it may be an indication that the WDR has failed. Please contact your local sales representative.
Popup does not display.	Make sure your browser settings are not blocking pop-ups.
While using a cloud connection (MindSphere), the MindSphere communication status on the cloud connection screen shows a communication error.	Normal communication may not be possible due to an error in the settings or an issue with the connection to MindSphere. <ul style="list-style-type: none"> • Confirm the settings for Region Information, Client ID, Client Secret, and Root Certificate 1 and 2, and also confirm the certificate has not expired. • Confirm the LAN cable is connected properly.

11. Specifications

11.1. WDT (Transmitter)

Item	Description		
	WDT-4LR-Z2	WDT-5LR-Z2	WDT-6LR-Z2
Connected Model	LR4 Series Signal Tower body unit top attachment	LR5 Series Signal Tower body unit top attachment	LR6 Series Signal Tower body unit top attachment
Rated Voltage*	24 VDC		
Operating Voltage Range*	19.0 to 26.4 VDC		
Rated Current Consumption*	Maximum 55 mA		
Operating Ambient Temperature	-10 °C to +50 °C		
Operating Ambient Humidity	85% RH or less, no condensation		
Storage Ambient Temperature	-20 °C to +60 °C		
Storage Ambient Humidity	85% RH or less, no condensation		
Mounting Location	Indoors		
Mounting Method	Upright		
Protection Rating	IP65 (IEC 60529), NEMA TYPE 4X,13		
Mass	70 g	74 g	85 g
Telecommunication Protocols	IEEE 802.15.4. (wireless communication)		
Communication Frequency	2405 MHz to 2480 MHz (16 channels)		
Communication Distance	Approximately 30 m from source (reference value)		
External Contact Input	Control Signal Input		
Number of Contacts	6 contacts (red, amber, green, blue, white, and buzzer)		
Input Reaction Time	100 ms or longer		
Display Unit	Indicator for monitoring the status		
Operation Unit	DIP Switch for setting		

* These values are specifications for the transmitter unit. Specifications may change without prior notice.

11.2. WDR (Receiver)

11.2.1. General Specifications

Item		Description	
		WDR-L-Z2-PRO(-L)	WDR-LE-Z2-PRO(-L)
Rated Voltage	Power Terminal DC power jack	24 VDC	
	PoE power supply	48 VDC	
	USB bus power	5 VDC	
	AC Adaptor accessory	100 - 240 VAC 50/60Hz	-
Operating Voltage Range	Power Terminal DC power jack	21.6. to 26.4 VDC	
	PoE power supply	43 to 57 VDC	
	USB bus power	4.75 to 5.25 VDC	
	AC Adaptor accessory	90 - 264 VAC	-
Rated Current Consumption	Standard	100 mA (at 24 VDC) 70 mA (PoE: at 48 VDC) 300 mA (USB: at 5 VDC)	
	Maximum	150 mA (at 24 VDC) 100 mA (PoE: at 48 VDC) 500 mA (USB: at 5 VDC)	
Rated Power Consumption	Standard	3.0 W (AC Adaptor accessory: at 100 VAC)	-
	Maximum	4.5 W (AC Adaptor accessory: at 100 VAC)	-
Power Supply Input	Power Terminal	Screwless Terminal Block	
	DC Power Jack	AC Adaptor DC power jack	
	USB	USB Type B (USB bus power compatible)	
	LAN (PoE)	LAN Connector (IEEE802.3af Class0 compliant)	
Ambient Operating Temperature	Main Unit	-10°C to 50°C	
	AC Adaptor accessory	0°C to 40°C	-
Ambient Operating Humidity		85% RH or less, no condensation, no freezing	
Storage Ambient Temperature	Main Unit	-20°C to 60°C	
	AC Adaptor accessory	-10°C to 70°C	-
Storage Ambient Humidity		85% RH or less, no condensation, no freezing	
Mounting Location / Mounting Method		Indoor/Horizontal installation Wall mounting Ceiling mounting	
Protection Rating		IP20	
Mass		300 g ± 10% (except AC Adaptor accessory)	
Status lamp		Status display LED x 4	
Operation		Setting DIP switch, Maintenance DIP switch, Reset switch	
Accessory	Cable tie x 1, cable fixing plate x 1		
	AC Adaptor x 1		-

11.2.2. Communication Specifications

Item		Description
		WDR-L(E)-Z2-PRO(-L)
Wireless Connection Specification	Transmitter Options	WDT-4LR-Z2, WDT-5LR-Z2, WDT-6LR-Z2, WDT-6LR-Z2-PRO, WDT-5E-Z2 WDT-6M-Z2 (mixed use possible)
	Communication Standard	IEEE 802.15.4. compliant
	Communication Frequency	2405 MHz to 2480 MHz (16 channels)
	Transmission Method	Direct Sequence Spread Spectrum (DSSS)
	Wireless Communication method	Compliant with ZigBee standard
	Number of connected transmitters	Maximum 30 units* ¹
	Transmission Output	Maximum 3 mW (at the antenna feed)
	Communication Distance	Approximately 30 m from source (reference value)* ²
Interface Specifications	Network Communication Format	Ethernet IEEE802.3. compliant 10BASE-T/100BASE-TX/1000BASE-T (Auto-MDI/MDIX compatible)
	USB connection	Type-B connector, USB 1.1/USB 2.0 full speed compatible
References		<p>*1 Because of the characteristics of radio waves, the actual number may vary depending on the installation location, communication environment, and communication frequency.</p> <p>*2 Because of the characteristics of radio waves, the actual number may vary depending on the installation location and communication environment.</p>

11.3. Supported Countries and Regions

11.3.1. WDT (Transmitter)

Model	Supported Countries and Regions
WDT-4LR-Z2 WDT-5LR-Z2 WDT-6LR-Z2	Japan, USA, Europe, Korea, Taiwan, Thailand, China, Mexico, Philippines, Vietnam, Canada, Malaysia, Singapore

* Do not use outside of supported countries and regions. Failure to do so may come into conflict with the law.

11.3.2. WDR (Receiver)

Model	Supported Countries and Regions
WDR-L-Z2-PRO(-L)	Japan only
WDR-LE-Z2-PRO(-L)	Japan, USA, Europe, Korea, Taiwan, Thailand, China, Mexico, Philippines, Vietnam, Canada, Malaysia, Singapore

* Do not use outside of supported countries and regions. Failure to do so may come into conflict with the law.

12. Replacement and Optional Parts

12.1. Replacement Parts

Various parts are available to the customer for exchange or replacement.

12.1.1. WDT (Transmitter)

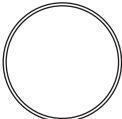
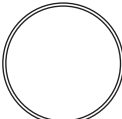
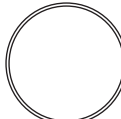
O-ring 40	O-ring 50	O-ring 60
WDT-4LR replacement parts	WDT-5LR replacement parts	WDT-6LR replacement parts
		
5 pieces	5 pieces	5 pieces

12.1.2. WDR (Receiver)

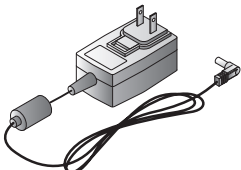
AC Adaptor
WDR-L-Z2-PRO(-L) replacement parts
5pieces 

12.2. Optional Parts

This product includes the following related products and optional parts.

●Related products

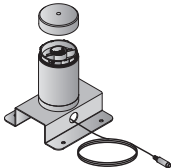
Software	Setup Kit		
WDS-WIN01	WDX-4LRB	WDX-5LRB	WDX-6LRB
			

●Optional parts

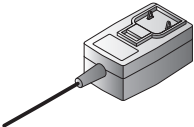
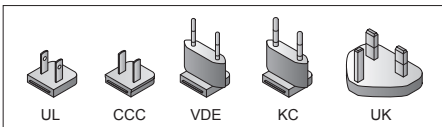
AC Adaptor
ADP-001
 

13. Free Software License Agreement

This chapter clarifies the license for the free software used in WDR.

13.1. GNU GENERAL PUBLIC LICENSE

13.1.1. Version 1.0

GNU GENERAL PUBLIC LICENSE Version 1, February 1989

Copyright (C) 1989 Free Software Foundation, Inc.
51 Franklin St, Fifth Floor, Boston, MA 02110-1301 USA

Everyone is permitted to copy and distribute verbatim copies of this license document, but changing it is not allowed.

Preamble

The license agreements of most software companies try to keep users at the mercy of those companies. By contrast, our General Public License is intended to guarantee your freedom to share and change free software--to make sure the software is free for all its users. The General Public License applies to the Free Software Foundation's software and to any other program whose authors commit to using it. You can use it for your programs, too.

When we speak of free software, we are referring to freedom, not price. Specifically, the General Public License is designed to make sure that you have the freedom to give away or sell copies of free software, that you receive source code or can get it if you want it, that you can change the software or use pieces of it in new free programs; and that you know you can do these things.

To protect your rights, we need to make restrictions that forbid anyone to deny you these rights or to ask you to surrender the rights. These restrictions translate to certain responsibilities for you if you distribute copies of the software, or if you modify it.

For example, if you distribute copies of a such a program, whether gratis or for a fee, you must give the recipients all the rights that you have. You must make sure that they, too, receive or can get the source code. And you must tell them their rights.

We protect your rights with two steps: (1) copyright the software, and (2) offer you this license which gives you legal permission to copy, distribute and/or modify the software.

Also, for each author's protection and ours, we want to make certain that everyone understands that there is no warranty for this free software. If the software is modified by someone else and passed on, we want its recipients to know that what they have is not the original, so that any problems introduced by others will not reflect on the original authors' reputations.

The precise terms and conditions for copying, distribution and modification follow.

GNU GENERAL PUBLIC LICENSE TERMS AND CONDITIONS FOR COPYING, DISTRIBUTION AND MODIFICATION

0. This License Agreement applies to any program or other work which contains a notice placed by the copyright holder saying it may be distributed under the terms of this General Public License. The "Program", below, refers to any such program or work, and a "work based on the Program" means either the Program or any work containing the Program or a portion of it, either verbatim or with modifications. Each licensee is addressed as "you".
1. You may copy and distribute verbatim copies of the Program's source code as you receive it, in any medium, provided that you conspicuously and appropriately publish on each copy an appropriate copyright notice and disclaimer of warranty; keep intact all the notices that refer to this General Public License and to the absence of any warranty; and give any other recipients of the Program a copy of this General Public License along with the Program. You may charge a fee for the physical act of transferring a copy.
2. You may modify your copy or copies of the Program or any portion of it, and copy and distribute such modifications under the terms of Paragraph 1 above, provided that you also do the following:
 - a) cause the modified files to carry prominent notices stating that you changed the files and the date of any change; and
 - b) cause the whole of any work that you distribute or publish, that in whole or in part contains the Program or any part thereof, either with or without modifications, to be licensed at no charge to all third parties under the terms of this General Public License (except that you may choose to grant warranty protection to some or all third parties, at your option).
 - c) If the modified program normally reads commands interactively when run, you must cause it, when started running for such interactive use in the simplest and most usual way, to print or display an announcement including an appropriate copyright notice and a notice that there is no warranty (or else, saying that you provide a warranty) and that users may redistribute the program under these conditions, and telling the user how to view a copy of this General Public License.
 - d) You may charge a fee for the physical act of transferring a copy, and you may at your option offer warranty protection in exchange for a fee.

Mere aggregation of another independent work with the Program (or its derivative) on a volume of a storage or distribution medium does not bring the other work under the scope of these terms.

3. You may copy and distribute the Program (or a portion or derivative of it, under Paragraph 2) in object code or executable form under the terms of Paragraphs 1 and 2 above provided that you also do one of the following:
 - a) accompany it with the complete corresponding machine-readable source code, which must be distributed under the terms of Paragraphs 1 and 2 above; or,
 - b) accompany it with a written offer, valid for at least three years, to give any third party free (except for a nominal charge for the cost of distribution) a complete machine-readable copy of the corresponding source code, to be distributed under the terms of Paragraphs 1 and 2 above; or,
 - c) accompany it with the information you received as to where the corresponding source code may be obtained. (This alternative is allowed only for noncommercial distribution and only if you received the program in object code or executable form alone.)

Source code for a work means the preferred form of the work for making modifications to it. For an executable file, complete source code means all the source code for all modules it contains; but, as a special exception, it need not include source code for modules which are standard libraries that accompany the operating system on which the executable file runs, or for standard header files or definitions files that accompany that operating system.

4. You may not copy, modify, sublicense, distribute or transfer the Program except as expressly provided under this General Public License. Any attempt otherwise to copy, modify, sublicense, distribute or transfer the Program is void, and will automatically terminate your rights to use the Program under this License. However, parties who have received copies, or rights to use copies, from you under this General Public License will not have their licenses terminated so long as such parties remain in full compliance.
5. By copying, distributing or modifying the Program (or any work based on the Program) you indicate your acceptance of this license to do so, and all its terms and conditions.
6. Each time you redistribute the Program (or any work based on the Program), the recipient automatically receives a license from the original licensor to copy, distribute or modify the Program subject to these terms and conditions. You may not impose any further restrictions on the recipients' exercise of the rights granted herein.
7. The Free Software Foundation may publish revised and/or new versions of the General Public License from time to time. Such new versions will be similar in spirit to the present version, but may differ in detail to address new problems or concerns.

Each version is given a distinguishing version number. If the Program specifies a version number of the license which applies to it and "any later version", you have the option of following the terms and conditions either of that version or of any later version published by the Free Software Foundation. If the Program does not specify a version number of the license, you may choose any version ever published by the Free Software Foundation.

8. If you wish to incorporate parts of the Program into other free programs whose distribution conditions are different, write to the author to ask for permission. For software which is copyrighted by the Free Software Foundation, write to the Free Software Foundation; we sometimes make exceptions for this. Our decision will be guided by the two goals of preserving the free status of all derivatives of our free software and of promoting the sharing and reuse of software generally.

NO WARRANTY

9. BECAUSE THE PROGRAM IS LICENSED FREE OF CHARGE, THERE IS NO WARRANTY FOR THE PROGRAM, TO THE EXTENT PERMITTED BY APPLICABLE LAW. EXCEPT WHEN OTHERWISE STATED IN WRITING THE COPYRIGHT HOLDERS AND/OR OTHER PARTIES PROVIDE THE PROGRAM "AS IS" WITHOUT WARRANTY OF ANY KIND, EITHER EXPRESSED OR IMPLIED, INCLUDING, BUT NOT LIMITED TO, THE IMPLIED WARRANTIES OF MERCHANTABILITY AND FITNESS FOR A PARTICULAR PURPOSE. THE ENTIRE RISK AS TO THE QUALITY AND PERFORMANCE OF THE PROGRAM IS WITH YOU. SHOULD THE PROGRAM PROVE DEFECTIVE, YOU ASSUME THE COST OF ALL NECESSARY SERVICING, REPAIR OR CORRECTION.
10. IN NO EVENT UNLESS REQUIRED BY APPLICABLE LAW OR AGREED TO IN WRITING WILL ANY COPYRIGHT HOLDER, OR ANY OTHER PARTY WHO MAY MODIFY AND/OR REDISTRIBUTE THE PROGRAM AS PERMITTED ABOVE, BE LIABLE TO YOU FOR DAMAGES, INCLUDING ANY GENERAL, SPECIAL, INCIDENTAL OR CONSEQUENTIAL DAMAGES ARISING OUT OF THE USE OR INABILITY TO USE THE PROGRAM (INCLUDING BUT NOT LIMITED TO LOSS OF DATA OR DATA BEING RENDERED INACCURATE OR LOSSES SUSTAINED BY YOU OR THIRD PARTIES OR A FAILURE OF THE PROGRAM TO OPERATE WITH ANY OTHER PROGRAMS), EVEN IF SUCH HOLDER OR OTHER PARTY HAS BEEN ADVISED OF THE POSSIBILITY OF SUCH DAMAGES.

END OF TERMS AND CONDITIONS

Appendix: How to Apply These Terms to Your New Programs

If you develop a new program, and you want it to be of the greatest possible use to humanity, the best way to achieve this is to make it free software which everyone can redistribute and change under these terms.

To do so, attach the following notices to the program. It is safest to attach them to the start of each source file to most effectively convey the exclusion of warranty; and each file should have at least the "copyright" line and a pointer to where the full notice is found.

```
<one line to give the program's name and a brief idea of what it does.>  
Copyright (C) 19yy <name of author>
```

This program is free software; you can redistribute it and/or modify it under the terms of the GNU General Public License as published by the Free Software Foundation; either version 1, or (at your option) any later version.

This program is distributed in the hope that it will be useful, but WITHOUT ANY WARRANTY; without even the implied warranty of MERCHANTABILITY or FITNESS FOR A PARTICULAR PURPOSE. See the GNU General Public License for more details.

You should have received a copy of the GNU General Public License along with this program; if not, write to the Free Software Foundation, Inc., 51 Franklin Street, Fifth Floor, Boston MA 02110-1301 USA

Also add information on how to contact you by electronic and paper mail.

If the program is interactive, make it output a short notice like this when it starts in an interactive mode:

```
Gnomovision version 69, Copyright (C) 19xx name of author  
Gnomovision comes with ABSOLUTELY NO WARRANTY; for details type `show w'.  
This is free software, and you are welcome to redistribute it under certain conditions;  
type `show c' for details.
```

The hypothetical commands `show w' and `show c' should show the appropriate parts of the General Public License. Of course, the commands you use may be called something other than `show w' and `show c'; they could even be mouse-clicks or menu items--whatever suits your program.

You should also get your employer (if you work as a programmer) or your school, if any, to sign a "copyright disclaimer" for the program, if necessary. Here a sample; alter the names:

```
Yoyodyne, Inc., hereby disclaims all copyright interest in the program `Gnomovision' (a  
program to direct compilers to make passes at assemblers) written by James Hacker.
```

```
<signature of Ty Coon>, 1 April 1989  
Ty Coon, President of Vice
```

That's all there is to it!

13.1.2. Version 2.0

GNU GENERAL PUBLIC LICENSE Version 2, June 1991

Copyright (C) 1989, 1991 Free Software Foundation, Inc., 51 Franklin Street, Fifth Floor, Boston, MA 02110-1301 USA

Everyone is permitted to copy and distribute verbatim copies of this license document, but changing it is not allowed.

Preamble

The licenses for most software are designed to take away your freedom to share and change it. By contrast, the GNU General Public License is intended to guarantee your freedom to share and change free software--to make sure the software is free for all its users. This General Public License applies to most of the Free Software Foundation's software and to any other program whose authors commit to using it. (Some other Free Software Foundation software is covered by the GNU Lesser General Public License instead.) You can apply it to your programs, too.

When we speak of free software, we are referring to freedom, not price. Our General Public Licenses are designed to make sure that you have the freedom to distribute copies of free software (and charge for this service if you wish), that you receive source code or can get it if you want it, that you can change the software or use pieces of it in new free programs; and that you know you can do these things.

To protect your rights, we need to make restrictions that forbid anyone to deny you these rights or to ask you to surrender the rights. These restrictions translate to certain responsibilities for you if you distribute copies of the software, or if you modify it.

For example, if you distribute copies of such a program, whether gratis or for a fee, you must give the recipients all the rights that you have. You must make sure that they, too, receive or can get the source code. And you must show them these terms so they know their rights.

We protect your rights with two steps: (1) copyright the software, and (2) offer you this license which gives you legal permission to copy, distribute and/or modify the software.

Also, for each author's protection and ours, we want to make certain that everyone understands that there is no warranty for this free software. If the software is modified by someone else and passed on, we want its recipients to know that what they have is not the original, so that any problems introduced by others will not reflect on the original authors' reputations.

Finally, any free program is threatened constantly by software patents. We wish to avoid the danger that redistributors of a free program will individually obtain patent licenses, in effect making the program proprietary. To prevent this, we have made it clear that any patent must be licensed for everyone's free use or not licensed at all.

The precise terms and conditions for copying, distribution and modification follow.

GNU GENERAL PUBLIC LICENSE TERMS AND CONDITIONS FOR COPYING, DISTRIBUTION AND MODIFICATION

0. This License applies to any program or other work which contains a notice placed by the copyright holder saying it may be distributed under the terms of this General Public License. The "Program", below, refers to any such program or work, and a "work based on the Program" means either the Program or any derivative work under copyright law: that is to say, a work containing the Program or a portion of it, either verbatim or with modifications and/or translated into another language. (Hereinafter, translation is included without limitation in the term "modification".) Each licensee is addressed as "you".

Activities other than copying, distribution and modification are not covered by this License; they are outside its scope. The act of running the Program is not restricted, and the output from the Program is covered only if its contents constitute a work based on the Program (independent of having been made by running the Program). Whether that is true depends on what the Program does.

1. You may copy and distribute verbatim copies of the Program's source code as you receive it, in any medium, provided that you conspicuously and appropriately publish on each copy an appropriate copyright notice and disclaimer of warranty; keep intact all the notices that refer to this License and to the absence of any warranty; and give any other recipients of the Program a copy of this License along with the Program.

You may charge a fee for the physical act of transferring a copy, and you may at your option offer warranty protection in exchange for a fee.

2. You may modify your copy or copies of the Program or any portion of it, thus forming a work based on the Program, and copy and distribute such modifications or work under the terms of Section 1 above, provided that you also meet all of these conditions:

- a) You must cause the modified files to carry prominent notices stating that you changed the files and the date of any change.
- b) You must cause any work that you distribute or publish, that in whole or in part contains or is derived from the Program or any part thereof, to be licensed as a whole at no charge to all third parties under the terms of this License.
- c) If the modified program normally reads commands interactively when run, you must cause it, when started running for such interactive use in the most ordinary way, to print or display an announcement including an appropriate copyright notice and a notice that there is no warranty (or else, saying that you provide a warranty) and that users may redistribute the program under these conditions, and telling the user how to view a copy of this License. (Exception: if the Program itself is interactive but does not normally print such an announcement, your work based on the Program is not required to print an announcement.)

These requirements apply to the modified work as a whole. If identifiable sections of that work are not derived from the Program, and can be reasonably considered independent and separate works in themselves, then this License, and its terms, do not apply to those sections when you distribute them as separate works. But when you distribute the same sections as part of a whole which is a work based on the Program, the distribution of the whole must be on the terms of this License, whose permissions for other licensees extend to the entire whole, and thus to each and every part regardless of who wrote it.

Thus, it is not the intent of this section to claim rights or contest your rights to work written entirely by you; rather, the intent is to exercise the right to control the distribution of derivative or collective works based on the Program.

In addition, mere aggregation of another work not based on the Program with the Program (or with a work based on the Program) on a volume of a storage or distribution medium does not bring the other work under the scope of this License.

3. You may copy and distribute the Program (or a work based on it, under Section 2) in object code or executable form under the terms of Sections 1 and 2 above provided that you also do one of the following:
 - a) Accompany it with the complete corresponding machine-readable source code, which must be distributed under the terms of Sections 1 and 2 above on a medium customarily used for software interchange; or,
 - b) Accompany it with a written offer, valid for at least three years, to give any third party, for a charge no more than your cost of physically performing source distribution, a complete machine-readable copy of the corresponding source code, to be distributed under the terms of Sections 1 and 2 above on a medium customarily used for software interchange; or,
 - c) Accompany it with the information you received as to the offer to distribute corresponding source code. (This alternative is allowed only for noncommercial distribution and only if you received the program in object code or executable form with such an offer, in accord with Subsection b above.)

The source code for a work means the preferred form of the work for making modifications to it. For an executable work, complete source code means all the source code for all modules it contains, plus any associated interface definition files, plus the scripts used to control compilation and installation of the executable. However, as a special exception, the source code distributed need not include anything that is normally distributed (in either source or binary form) with the major components (compiler, kernel, and so on) of the operating system on which the executable runs, unless that component itself accompanies the executable.

If distribution of executable or object code is made by offering access to copy from a designated place, then offering equivalent access to copy the source code from the same place counts as distribution of the source code, even though third parties are not compelled to copy the source along with the object code.

4. You may not copy, modify, sublicense, or distribute the Program except as expressly provided under this License. Any attempt otherwise to copy, modify, sublicense or distribute the Program is void, and will automatically terminate your rights under this License. However, parties who have received copies, or rights, from you under this License will not have their licenses terminated so long as such parties remain in full compliance.
5. You are not required to accept this License, since you have not signed it. However, nothing else grants you permission to modify or distribute the Program or its derivative works. These actions are prohibited by law if you do not accept this License. Therefore, by modifying or distributing the Program (or any work based on the Program), you indicate your acceptance of this License to do so, and all its terms and conditions for copying, distributing or modifying the Program or works based on it.
6. Each time you redistribute the Program (or any work based on the Program), the recipient automatically receives a license from the original licensor to copy, distribute or modify the Program subject to these terms and conditions. You may not impose any further restrictions on the recipients' exercise of the rights granted herein. You are not responsible for enforcing compliance by third parties to this License.

7. If, as a consequence of a court judgment or allegation of patent infringement or for any other reason (not limited to patent issues), conditions are imposed on you (whether by court order, agreement or otherwise) that contradict the conditions of this License, they do not excuse you from the conditions of this License. If you cannot distribute so as to satisfy simultaneously your obligations under this License and any other pertinent obligations, then as a consequence you may not distribute the Program at all. For example, if a patent license would not permit royalty-free redistribution of the Program by all those who receive copies directly or indirectly through you, then the only way you could satisfy both it and this License would be to refrain entirely from distribution of the Program.

If any portion of this section is held invalid or unenforceable under any particular circumstance, the balance of the section is intended to apply and the section as a whole is intended to apply in other circumstances.

It is not the purpose of this section to induce you to infringe any patents or other property right claims or to contest validity of any such claims; this section has the sole purpose of protecting the integrity of the free software distribution system, which is implemented by public license practices. Many people have made generous contributions to the wide range of software distributed through that system in reliance on consistent application of that system; it is up to the author/donor to decide if he or she is willing to distribute software through any other system and a licensee cannot impose that choice.

This section is intended to make thoroughly clear what is believed to be a consequence of the rest of this License.

8. If the distribution and/or use of the Program is restricted in certain countries either by patents or by copyrighted interfaces, the original copyright holder who places the Program under this License may add an explicit geographical distribution limitation excluding those countries, so that distribution is permitted only in or among countries not thus excluded. In such case, this License incorporates the limitation as if written in the body of this License.
9. The Free Software Foundation may publish revised and/or new versions of the General Public License from time to time. Such new versions will be similar in spirit to the present version, but may differ in detail to address new problems or concerns.

Each version is given a distinguishing version number. If the Program specifies a version number of this License which applies to it and "any later version", you have the option of following the terms and conditions either of that version or of any later version published by the Free Software Foundation. If the Program does not specify a version number of this License, you may choose any version ever published by the Free Software Foundation.

10. If you wish to incorporate parts of the Program into other free programs whose distribution conditions are different, write to the author to ask for permission. For software which is copyrighted by the Free Software Foundation, write to the Free Software Foundation; we sometimes make exceptions for this. Our decision will be guided by the two goals of preserving the free status of all derivatives of our free software and of promoting the sharing and reuse of software generally.

NO WARRANTY

11. BECAUSE THE PROGRAM IS LICENSED FREE OF CHARGE, THERE IS NO WARRANTY FOR THE PROGRAM, TO THE EXTENT PERMITTED BY APPLICABLE LAW. EXCEPT WHEN OTHERWISE STATED IN WRITING THE COPYRIGHT HOLDERS AND/OR OTHER PARTIES PROVIDE THE PROGRAM "AS IS" WITHOUT WARRANTY OF ANY KIND, EITHER EXPRESSED OR IMPLIED, INCLUDING, BUT NOT LIMITED TO, THE IMPLIED WARRANTIES OF MERCHANTABILITY AND FITNESS FOR A PARTICULAR PURPOSE. THE ENTIRE RISK AS TO THE QUALITY AND PERFORMANCE OF THE PROGRAM IS WITH YOU. SHOULD THE PROGRAM PROVE DEFECTIVE, YOU ASSUME THE COST OF ALL NECESSARY SERVICING, REPAIR OR CORRECTION.

12. IN NO EVENT UNLESS REQUIRED BY APPLICABLE LAW OR AGREED TO IN WRITING WILL ANY COPYRIGHT HOLDER, OR ANY OTHER PARTY WHO MAY MODIFY AND/OR REDISTRIBUTE THE PROGRAM AS PERMITTED ABOVE, BE LIABLE TO YOU FOR DAMAGES, INCLUDING ANY GENERAL, SPECIAL, INCIDENTAL OR CONSEQUENTIAL DAMAGES ARISING OUT OF THE USE OR INABILITY TO USE THE PROGRAM (INCLUDING BUT NOT LIMITED TO LOSS OF DATA OR DATA BEING RENDERED INACCURATE OR LOSSES SUSTAINED BY YOU OR THIRD PARTIES OR A FAILURE OF THE PROGRAM TO OPERATE WITH ANY OTHER PROGRAMS), EVEN IF SUCH HOLDER OR OTHER PARTY HAS BEEN ADVISED OF THE POSSIBILITY OF SUCH DAMAGES.

END OF TERMS AND CONDITIONS

How to Apply These Terms to Your New Programs

If you develop a new program, and you want it to be of the greatest possible use to the public, the best way to achieve this is to make it free software which everyone can redistribute and change under these terms.

To do so, attach the following notices to the program. It is safest to attach them to the start of each source file to most effectively convey the exclusion of warranty; and each file should have at least the "copyright" line and a pointer to where the full notice is found.

```
<one line to give the program's name and a brief idea of what it does.>
Copyright (C) <year> <name of author>
```

This program is free software; you can redistribute it and/or modify it under the terms of the GNU General Public License as published by the Free Software Foundation; either version 2 of the License, or (at your option) any later version.

This program is distributed in the hope that it will be useful, but WITHOUT ANY WARRANTY; without even the implied warranty of MERCHANTABILITY or FITNESS FOR A PARTICULAR PURPOSE. See the GNU General Public License for more details.

You should have received a copy of the GNU General Public License along with this program; if not, write to the Free Software Foundation, Inc., 51 Franklin Street, Fifth Floor, Boston, MA 02110-1301 USA.

Also add information on how to contact you by electronic and paper mail.

If the program is interactive, make it output a short notice like this when it starts in an interactive mode:

```
Gnomovision version 69, Copyright (C) year name of author Gnomovision comes with ABSO-
LUTELY NO WARRANTY; for details type `show w'. This is free software, and you are wel-
come to redistribute it under certain conditions; type `show c' for details.
```

The hypothetical commands `show w' and `show c' should show the appropriate parts of the General Public License. Of course, the commands you use may be called something other than `show w' and `show c'; they could even be mouse-clicks or menu items--whatever suits your program.

You should also get your employer (if you work as a programmer) or your school, if any, to sign a "copyright disclaimer" for the program, if necessary. Here is a sample; alter the names:

```
Yoyodyne, Inc., hereby disclaims all copyright interest in the program `Gnomovision' (which
makes passes at compilers) written by James Hacker.
```

```
<signature of Ty Coon>, 1 April 1989
Ty Coon, President of Vice
```

This General Public License does not permit incorporating your program into proprietary programs. If your program is a subroutine library, you may consider it more useful to permit linking proprietary applications with the library. If this is what you want to do, use the GNU Lesser General Public License instead of this License.

13.1.3. Version 3.0

GNU GENERAL PUBLIC LICENSE Version 3, 29 June 2007

Copyright (C) 2007 Free Software Foundation, Inc. <<https://fsf.org/>>
Everyone is permitted to copy and distribute verbatim copies of this license document, but changing it is not allowed.

Preamble

The GNU General Public License is a free, copyleft license for software and other kinds of works.

The licenses for most software and other practical works are designed to take away your freedom to share and change the works. By contrast, the GNU General Public License is intended to guarantee your freedom to share and change all versions of a program--to make sure it remains free software for all its users. We, the Free Software Foundation, use the GNU General Public License for most of our software; it applies also to any other work released this way by its authors. You can apply it to your programs, too.

When we speak of free software, we are referring to freedom, not price. Our General Public Licenses are designed to make sure that you have the freedom to distribute copies of free software (and charge for them if you wish), that you receive source code or can get it if you want it, that you can change the software or use pieces of it in new free programs, and that you know you can do these things.

To protect your rights, we need to prevent others from denying you these rights or asking you to surrender the rights. Therefore, you have certain responsibilities if you distribute copies of the software, or if you modify it: responsibilities to respect the freedom of others.

For example, if you distribute copies of such a program, whether gratis or for a fee, you must pass on to the recipients the same freedoms that you received. You must make sure that they, too, receive or can get the source code. And you must show them these terms so they know their rights.

Developers that use the GNU GPL protect your rights with two steps: (1) assert copyright on the software, and (2) offer you this License giving you legal permission to copy, distribute and/or modify it.

For the developers' and authors' protection, the GPL clearly explains that there is no warranty for this free software. For both users' and authors' sake, the GPL requires that modified versions be marked as changed, so that their problems will not be attributed erroneously to authors of previous versions.

Some devices are designed to deny users access to install or run modified versions of the software inside them, although the manufacturer can do so. This is fundamentally incompatible with the aim of protecting users' freedom to change the software. The systematic pattern of such abuse occurs in the area of products for individuals to use, which is precisely where it is most unacceptable. Therefore, we have designed this version of the GPL to prohibit the practice for those products. If such problems arise substantially in other domains, we stand ready to extend this provision to those domains in future versions of the GPL, as needed to protect the freedom of users.

Finally, every program is threatened constantly by software patents. States should not allow patents to restrict development and use of software on general-purpose computers, but in those that do, we wish to avoid the special danger that patents applied to a free program could make it effectively proprietary. To prevent this, the GPL assures that patents cannot be used to render the program non-free.

The precise terms and conditions for copying, distribution and modification follow.

TERMS AND CONDITIONS

0. Definitions.

"This License" refers to version 3 of the GNU General Public License.

"Copyright" also means copyright-like laws that apply to other kinds of works, such as semiconductor masks.

"The Program" refers to any copyrightable work licensed under this License. Each licensee is addressed as "you". "Licensees" and "recipients" may be individuals or organizations.

To "modify" a work means to copy from or adapt all or part of the work in a fashion requiring copyright permission, other than the making of an exact copy. The resulting work is called a "modified version" of the earlier work or a work "based on" the earlier work.

A "covered work" means either the unmodified Program or a work based on the Program.

To "propagate" a work means to do anything with it that, without permission, would make you directly or secondarily liable for infringement under applicable copyright law, except executing it on a computer or modifying a private copy. Propagation includes copying, distribution (with or without modification), making available to the public, and in some countries other activities as well.

To "convey" a work means any kind of propagation that enables other parties to make or receive copies. Mere interaction with a user through a computer network, with no transfer of a copy, is not conveying.

An interactive user interface displays "Appropriate Legal Notices" to the extent that it includes a convenient and prominently visible feature that (1) displays an appropriate copyright notice, and (2) tells the user that there is no warranty for the work (except to the extent that warranties are provided), that licensees may convey the work under this License, and how to view a copy of this License. If the interface presents a list of user commands or options, such as a menu, a prominent item in the list meets this criterion.

1. Source Code.

The "source code" for a work means the preferred form of the work for making modifications to it. "Object code" means any non-source form of a work.

A "Standard Interface" means an interface that either is an official standard defined by a recognized standards body, or, in the case of interfaces specified for a particular programming language, one that is widely used among developers working in that language.

The "System Libraries" of an executable work include anything, other than the work as a whole, that (a) is included in the normal form of packaging a Major Component, but which is not part of that Major Component, and (b) serves only to enable use of the work with that Major Component, or to implement a Standard Interface for which an implementation is available to the public in source code form. A "Major Component", in this context, means a major essential component (kernel, window system, and so on) of the specific operating system (if any) on which the executable work runs, or a compiler used to produce the work, or an object code interpreter used to run it.

The "Corresponding Source" for a work in object code form means all the source code needed to generate, install, and (for an executable work) run the object code and to modify the work, including scripts to control those activities. However, it does not include the work's System Libraries, or general-purpose tools or generally available free programs which are used unmodified in performing those activities but which are not part of the work. For example, Corresponding Source includes interface definition files associated with source files for the work, and the source code for shared libraries and dynamically linked subprograms that the work is specifically designed to require, such as by intimate data communication or control flow between those subprograms and other parts of the work.

The Corresponding Source need not include anything that users can regenerate automatically from other parts of the Corresponding Source.

The Corresponding Source for a work in source code form is that same work.

2. Basic Permissions.

All rights granted under this License are granted for the term of copyright on the Program, and are irrevocable provided the stated conditions are met. This License explicitly affirms your unlimited permission to run the unmodified Program. The output from running a covered work is covered by this License only if the output, given its content, constitutes a covered work. This License acknowledges your rights of fair use or other equivalent, as provided by copyright law.

You may make, run and propagate covered works that you do not convey, without conditions so long as your license otherwise remains in force. You may convey covered works to others for the sole purpose of having them make modifications exclusively for you, or provide you with facilities for running those works, provided that you comply with the terms of this License in conveying all material for which you do not control copyright. Those thus making or running the covered works for you must do so exclusively on your behalf, under your direction and control, on terms that prohibit them from making any copies of your copyrighted material outside their relationship with you.

Conveying under any other circumstances is permitted solely under the conditions stated below. Sublicensing is not allowed; section 10 makes it unnecessary.

3. Protecting Users' Legal Rights From Anti-Circumvention Law.

No covered work shall be deemed part of an effective technological measure under any applicable law fulfilling obligations under article 11 of the WIPO copyright treaty adopted on 20 December 1996, or similar laws prohibiting or restricting circumvention of such measures.

When you convey a covered work, you waive any legal power to forbid circumvention of technological measures to the extent such circumvention is effected by exercising rights under this License with respect to the covered work, and you disclaim any intention to limit operation or modification of the work as a means of enforcing, against the work's users, your or third parties' legal rights to forbid circumvention of technological measures.

4. Conveying Verbatim Copies.

You may convey verbatim copies of the Program's source code as you receive it, in any medium, provided that you conspicuously and appropriately publish on each copy an appropriate copyright notice; keep intact all notices stating that this License and any non-permissive terms added in accord with section 7 apply to the code; keep intact all notices of the absence of any warranty; and give all recipients a copy of this License along with the Program.

You may charge any price or no price for each copy that you convey, and you may offer support or warranty protection for a fee.

5. Conveying Modified Source Versions.

You may convey a work based on the Program, or the modifications to produce it from the Program, in the form of source code under the terms of section 4, provided that you also meet all of these conditions:

- a) The work must carry prominent notices stating that you modified it, and giving a relevant date.
- b) The work must carry prominent notices stating that it is released under this License and any conditions added under section 7. This requirement modifies the requirement in section 4 to "keep intact all notices".
- c) You must license the entire work, as a whole, under this License to anyone who comes into possession of a copy. This License will therefore apply, along with any applicable section 7 additional terms, to the whole of the work, and all its parts, regardless of how they are packaged. This License gives no permission to license the work in any other way, but it does not invalidate such permission if you have separately received it.
- d) If the work has interactive user interfaces, each must display Appropriate Legal Notices; however, if the Program has interactive interfaces that do not display Appropriate Legal Notices, your work need not make them do so.

A compilation of a covered work with other separate and independent works, which are not by their nature extensions of the covered work, and which are not combined with it such as to form a larger program, in or on a volume of a storage or distribution medium, is called an "aggregate" if the compilation and its resulting copyright are not used to limit the access or legal rights of the compilation's users beyond what the individual works permit. Inclusion of a covered work in an aggregate does not cause this License to apply to the other parts of the aggregate.

6. Conveying Non-Source Forms.

You may convey a covered work in object code form under the terms of sections 4 and 5, provided that you also convey the machine-readable Corresponding Source under the terms of this License, in one of these ways:

- a) Convey the object code in, or embodied in, a physical product (including a physical distribution medium), accompanied by the Corresponding Source fixed on a durable physical medium customarily used for software interchange.
- b) Convey the object code in, or embodied in, a physical product (including a physical distribution medium), accompanied by a written offer, valid for at least three years and valid for as long as you offer spare parts or customer support for that product model, to give anyone who possesses the object code either (1) a copy of the Corresponding Source for all the software in the product that is covered by this License, on a durable physical medium customarily used for software interchange, for a price no more than your reasonable cost of physically performing this conveying of source, or (2) access to copy the Corresponding Source from a network server at no charge.

- c) Convey individual copies of the object code with a copy of the written offer to provide the Corresponding Source. This alternative is allowed only occasionally and noncommercially, and only if you received the object code with such an offer, in accord with subsection 6b.
- d) Convey the object code by offering access from a designated place (gratis or for a charge), and offer equivalent access to the Corresponding Source in the same way through the same place at no further charge. You need not require recipients to copy the Corresponding Source along with the object code. If the place to copy the object code is a network server, the Corresponding Source may be on a different server (operated by you or a third party) that supports equivalent copying facilities, provided you maintain clear directions next to the object code saying where to find the Corresponding Source. Regardless of what server hosts the Corresponding Source, you remain obligated to ensure that it is available for as long as needed to satisfy these requirements.
- e) Convey the object code using peer-to-peer transmission, provided you inform other peers where the object code and Corresponding Source of the work are being offered to the general public at no charge under subsection 6d.

A separable portion of the object code, whose source code is excluded from the Corresponding Source as a System Library, need not be included in conveying the object code work.

A "User Product" is either (1) a "consumer product", which means any tangible personal property which is normally used for personal, family, or household purposes, or (2) anything designed or sold for incorporation into a dwelling. In determining whether a product is a consumer product, doubtful cases shall be resolved in favor of coverage. For a particular product received by a particular user, "normally used" refers to a typical or common use of that class of product, regardless of the status of the particular user or of the way in which the particular user actually uses, or expects or is expected to use, the product. A product is a consumer product regardless of whether the product has substantial commercial, industrial or non-consumer uses, unless such uses represent the only significant mode of use of the product.

"Installation Information" for a User Product means any methods, procedures, authorization keys, or other information required to install and execute modified versions of a covered work in that User Product from a modified version of its Corresponding Source. The information must suffice to ensure that the continued functioning of the modified object code is in no case prevented or interfered with solely because modification has been made.

If you convey an object code work under this section in, or with, or specifically for use in, a User Product, and the conveying occurs as part of a transaction in which the right of possession and use of the User Product is transferred to the recipient in perpetuity or for a fixed term (regardless of how the transaction is characterized), the Corresponding Source conveyed under this section must be accompanied by the Installation Information. But this requirement does not apply if neither you nor any third party retains the ability to install modified object code on the User Product (for example, the work has been installed in ROM).

The requirement to provide Installation Information does not include a requirement to continue to provide support service, warranty, or updates for a work that has been modified or installed by the recipient, or for the User Product in which it has been modified or installed. Access to a network may be denied when the modification itself materially and adversely affects the operation of the network or violates the rules and protocols for communication across the network.

Corresponding Source conveyed, and Installation Information provided, in accord with this section must be in a format that is publicly documented (and with an implementation available to the public in source code form), and must require no special password or key for unpacking, reading or copying.

7. Additional Terms.

"Additional permissions" are terms that supplement the terms of this License by making exceptions from one or more of its conditions. Additional permissions that are applicable to the entire Program shall be treated as though they were included in this License, to the extent that they are valid under applicable law. If additional permissions apply only to part of the Program, that part may be used separately under those permissions, but the entire Program remains governed by this License without regard to the additional permissions.

When you convey a copy of a covered work, you may at your option remove any additional permissions from that copy, or from any part of it. (Additional permissions may be written to require their own removal in certain cases when you modify the work.) You may place additional permissions on material, added by you to a covered work, for which you have or can give appropriate copyright permission.

Notwithstanding any other provision of this License, for material you add to a covered work, you may (if authorized by the copyright holders of that material) supplement the terms of this License with terms:

- a) Disclaiming warranty or limiting liability differently from the terms of sections 15 and 16 of this License; or
- b) Requiring preservation of specified reasonable legal notices or author attributions in that material or in the Appropriate Legal Notices displayed by works containing it; or
- c) Prohibiting misrepresentation of the origin of that material, or requiring that modified versions of such material be marked in reasonable ways as different from the original version; or
- d) Limiting the use for publicity purposes of names of licensors or authors of the material; or
- e) Declining to grant rights under trademark law for use of some trade names, trademarks, or service marks; or
- f) Requiring indemnification of licensors and authors of that material by anyone who conveys the material (or modified versions of it) with contractual assumptions of liability to the recipient, for any liability that these contractual assumptions directly impose on those licensors and authors.

All other non-permissive additional terms are considered "further restrictions" within the meaning of section 10. If the Program as you received it, or any part of it, contains a notice stating that it is governed by this License along with a term that is a further restriction, you may remove that term. If a license document contains a further restriction but permits relicensing or conveying under this License, you may add to a covered work material governed by the terms of that license document, provided that the further restriction does not survive such relicensing or conveying.

If you add terms to a covered work in accord with this section, you must place, in the relevant source files, a statement of the additional terms that apply to those files, or a notice indicating where to find the applicable terms.

Additional terms, permissive or non-permissive, may be stated in the form of a separately written license, or stated as exceptions; the above requirements apply either way.

8. Termination.

You may not propagate or modify a covered work except as expressly provided under this License. Any attempt otherwise to propagate or modify it is void, and will automatically terminate your rights under this License (including any patent licenses granted under the third paragraph of section 11).

However, if you cease all violation of this License, then your license from a particular copyright holder is reinstated (a) provisionally, unless and until the copyright holder explicitly and finally terminates your license, and (b) permanently, if the copyright holder fails to notify you of the violation by some reasonable means prior to 60 days after the cessation.

Moreover, your license from a particular copyright holder is reinstated permanently if the copyright holder notifies you of the violation by some reasonable means, this is the first time you have received notice of violation of this License (for any work) from that copyright holder, and you cure the violation prior to 30 days after your receipt of the notice.

Termination of your rights under this section does not terminate the licenses of parties who have received copies or rights from you under this License. If your rights have been terminated and not permanently reinstated, you do not qualify to receive new licenses for the same material under section 10.

9. Acceptance Not Required for Having Copies.

You are not required to accept this License in order to receive or run a copy of the Program. Ancillary propagation of a covered work occurring solely as a consequence of using peer-to-peer transmission to receive a copy likewise does not require acceptance. However, nothing other than this License grants you permission to propagate or modify any covered work. These actions infringe copyright if you do not accept this License. Therefore, by modifying or propagating a covered work, you indicate your acceptance of this License to do so.

10. Automatic Licensing of Downstream Recipients.

Each time you convey a covered work, the recipient automatically receives a license from the original licensors, to run, modify and propagate that work, subject to this License. You are not responsible for enforcing compliance by third parties with this License.

An "entity transaction" is a transaction transferring control of an organization, or substantially all assets of one, or subdividing an organization, or merging organizations. If propagation of a covered work results from an entity transaction, each party to that transaction who receives a copy of the work also receives whatever licenses to the work the party's predecessor in interest had or could give under the previous paragraph, plus a right to possession of the Corresponding Source of the work from the predecessor in interest, if the predecessor has it or can get it with reasonable efforts.

You may not impose any further restrictions on the exercise of the rights granted or affirmed under this License. For example, you may not impose a license fee, royalty, or other charge for exercise of rights granted under this License, and you may not initiate litigation (including a cross-claim or counterclaim in a lawsuit) alleging that any patent claim is infringed by making, using, selling, offering for sale, or importing the Program or any portion of it.

11. Patents.

A "contributor" is a copyright holder who authorizes use under this License of the Program or a work on which the Program is based. The work thus licensed is called the contributor's "contributor version".

A contributor's "essential patent claims" are all patent claims owned or controlled by the contributor, whether already acquired or hereafter acquired, that would be infringed by some manner, permitted by this License, of making, using, or selling its contributor version, but do not include claims that would be infringed only as a consequence of further modification of the contributor version. For purposes of this definition, "control" includes the right to grant patent sublicenses in a manner consistent with the requirements of this License.

Each contributor grants you a non-exclusive, worldwide, royalty-free patent license under the contributor's essential patent claims, to make, use, sell, offer for sale, import and otherwise run, modify and propagate the contents of its contributor version.

In the following three paragraphs, a "patent license" is any express agreement or commitment, however denominated, not to enforce a patent (such as an express permission to practice a patent or covenant not to sue for patent infringement). To "grant" such a patent license to a party means to make such an agreement or commitment not to enforce a patent against the party.

If you convey a covered work, knowingly relying on a patent license, and the Corresponding Source of the work is not available for anyone to copy, free of charge and under the terms of this License, through a publicly available network server or other readily accessible means, then you must either (1) cause the Corresponding Source to be so available, or (2) arrange to deprive yourself of the benefit of the patent license for this particular work, or (3) arrange, in a manner consistent with the requirements of this License, to extend the patent license to downstream recipients. "Knowingly relying" means you have actual knowledge that, but for the patent license, your conveying the covered work in a country, or your recipient's use of the covered work in a country, would infringe one or more identifiable patents in that country that you have reason to believe are valid.

If, pursuant to or in connection with a single transaction or arrangement, you convey, or propagate by procuring conveyance of, a covered work, and grant a patent license to some of the parties receiving the covered work authorizing them to use, propagate, modify or convey a specific copy of the covered work, then the patent license you grant is automatically extended to all recipients of the covered work and works based on it.

A patent license is "discriminatory" if it does not include within the scope of its coverage, prohibits the exercise of, or is conditioned on the non-exercise of one or more of the rights that are specifically granted under this License. You may not convey a covered work if you are a party to an arrangement with a third party that is in the business of distributing software, under which you make payment to the third party based on the extent of your activity of conveying the work, and under which the third party grants, to any of the parties who would receive the covered work from you, a discriminatory patent license (a) in connection with copies of the covered work conveyed by you (or copies made from those copies), or (b) primarily for and in connection with specific products or compilations that contain the covered work, unless you entered into that arrangement, or that patent license was granted, prior to 28 March 2007.

Nothing in this License shall be construed as excluding or limiting any implied license or other defenses to infringement that may otherwise be available to you under applicable patent law.

12. No Surrender of Others' Freedom.

If conditions are imposed on you (whether by court order, agreement or otherwise) that contradict the conditions of this License, they do not excuse you from the conditions of this License. If you cannot convey a covered work so as to satisfy simultaneously your obligations under this License and any other pertinent obligations, then as a consequence you may not convey it at all. For example, if you agree to terms that obligate you to collect a royalty for further conveying from those to whom you convey the Program, the only way you could satisfy both those terms and this License would be to refrain entirely from conveying the Program.

13. Use with the GNU Affero General Public License.

Notwithstanding any other provision of this License, you have permission to link or combine any covered work with a work licensed under version 3 of the GNU Affero General Public License into a single combined work, and to convey the resulting work. The terms of this License will continue to apply to the part which is the covered work, but the special requirements of the GNU Affero General Public License, section 13, concerning interaction through a network will apply to the combination as such.

14. Revised Versions of this License.

The Free Software Foundation may publish revised and/or new versions of the GNU General Public License from time to time. Such new versions will be similar in spirit to the present version, but may differ in detail to address new problems or concerns.

Each version is given a distinguishing version number. If the Program specifies that a certain numbered version of the GNU General Public License "or any later version" applies to it, you have the option of following the terms and conditions either of that numbered version or of any later version published by the Free Software Foundation. If the Program does not specify a version number of the GNU General Public License, you may choose any version ever published by the Free Software Foundation.

If the Program specifies that a proxy can decide which future versions of the GNU General Public License can be used, that proxy's public statement of acceptance of a version permanently authorizes you to choose that version for the Program.

Later license versions may give you additional or different permissions. However, no additional obligations are imposed on any author or copyright holder as a result of your choosing to follow a later version.

15. Disclaimer of Warranty.

THERE IS NO WARRANTY FOR THE PROGRAM, TO THE EXTENT PERMITTED BY APPLICABLE LAW. EXCEPT WHEN OTHERWISE STATED IN WRITING THE COPYRIGHT HOLDERS AND/OR OTHER PARTIES PROVIDE THE PROGRAM "AS IS" WITHOUT WARRANTY OF ANY KIND, EITHER EXPRESSED OR IMPLIED, INCLUDING, BUT NOT LIMITED TO, THE IMPLIED WARRANTIES OF MERCHANTABILITY AND FITNESS FOR A PARTICULAR PURPOSE. THE ENTIRE RISK AS TO THE QUALITY AND PERFORMANCE OF THE PROGRAM IS WITH YOU. SHOULD THE PROGRAM PROVE DEFECTIVE, YOU ASSUME THE COST OF ALL NECESSARY SERVICING, REPAIR OR CORRECTION.

16. Limitation of Liability.

IN NO EVENT UNLESS REQUIRED BY APPLICABLE LAW OR AGREED TO IN WRITING WILL ANY COPYRIGHT HOLDER, OR ANY OTHER PARTY WHO MODIFIES AND/OR CONVEYS THE PROGRAM AS PERMITTED ABOVE, BE LIABLE TO YOU FOR DAMAGES, INCLUDING ANY GENERAL, SPECIAL, INCIDENTAL OR CONSEQUENTIAL DAMAGES ARISING OUT OF THE USE OR INABILITY TO USE THE PROGRAM (INCLUDING BUT NOT LIMITED TO LOSS OF DATA OR DATA BEING RENDERED INACCURATE OR LOSSES SUSTAINED BY YOU OR THIRD PARTIES OR A FAILURE OF THE PROGRAM TO OPERATE WITH ANY OTHER PROGRAMS), EVEN IF SUCH HOLDER OR OTHER PARTY HAS BEEN ADVISED OF THE POSSIBILITY OF SUCH DAMAGES.

17. Interpretation of Sections 15 and 16.

If the disclaimer of warranty and limitation of liability provided above cannot be given local legal effect according to their terms, reviewing courts shall apply local law that most closely approximates an absolute waiver of all civil liability in connection with the Program, unless a warranty or assumption of liability accompanies a copy of the Program in return for a fee.

END OF TERMS AND CONDITIONS

How to Apply These Terms to Your New Programs

If you develop a new program, and you want it to be of the greatest possible use to the public, the best way to achieve this is to make it free software which everyone can redistribute and change under these terms.

To do so, attach the following notices to the program. It is safest to attach them to the start of each source file to most effectively state the exclusion of warranty; and each file should have at least the "copyright" line and a pointer to where the full notice is found.

```
<one line to give the program's name and a brief idea of what it does.>  
Copyright (C) <year> <name of author>
```

This program is free software: you can redistribute it and/or modify it under the terms of the GNU General Public License as published by the Free Software Foundation, either version 3 of the License, or (at your option) any later version.

This program is distributed in the hope that it will be useful, but WITHOUT ANY WARRANTY; without even the implied warranty of MERCHANTABILITY or FITNESS FOR A PARTICULAR PURPOSE. See the GNU General Public License for more details.

You should have received a copy of the GNU General Public License along with this program. If not, see [<https://www.gnu.org/licenses/>](https://www.gnu.org/licenses/).

Also add information on how to contact you by electronic and paper mail.

If the program does terminal interaction, make it output a short notice like this when it starts in an interactive mode:

```
<program> Copyright (C) <year> <name of author>  
This program comes with ABSOLUTELY NO WARRANTY; for details type `show w'. This is  
free software, and you are welcome to redistribute it under certain conditions; type `show c'  
for details.
```

The hypothetical commands `show w' and `show c' should show the appropriate parts of the General Public License. Of course, your program's commands might be different; for a GUI interface, you would use an "about box".

You should also get your employer (if you work as a programmer) or school, if any, to sign a "copyright disclaimer" for the program, if necessary. For more information on this, and how to apply and follow the GNU GPL, see [<https://www.gnu.org/licenses/>](https://www.gnu.org/licenses/).

The GNU General Public License does not permit incorporating your program into proprietary programs. If your program is a subroutine library, you may consider it more useful to permit linking proprietary applications with the library. If this is what you want to do, use the GNU Lesser General Public License instead of this License. But first, please read [<https://www.gnu.org/licenses/why-not-lgpl.html>](https://www.gnu.org/licenses/why-not-lgpl.html).

13.2. GNU LIBRARY GENERAL PUBLIC LICENSE

13.2.1. Version 2.1

GNU LESSER GENERAL PUBLIC LICENSE Version 2.1, February 1999

Copyright (C) 1991, 1999 Free Software Foundation, Inc.
51 Franklin Street, Fifth Floor, Boston, MA 02110-1301 USA
Everyone is permitted to copy and distribute verbatim copies of this license document, but changing it is not allowed.

[This is the first released version of the Lesser GPL. It also counts as the successor of the GNU Library Public License, version 2, hence the version number 2.1.]

Preamble

The licenses for most software are designed to take away your freedom to share and change it. By contrast, the GNU General Public Licenses are intended to guarantee your freedom to share and change free software--to make sure the software is free for all its users.

This license, the Lesser General Public License, applies to some specially designated software packages--typically libraries--of the Free Software Foundation and other authors who decide to use it. You can use it too, but we suggest you first think carefully about whether this license or the ordinary General Public License is the better strategy to use in any particular case, based on the explanations below.

When we speak of free software, we are referring to freedom of use, not price. Our General Public Licenses are designed to make sure that you have the freedom to distribute copies of free software (and charge for this service if you wish); that you receive source code or can get it if you want it; that you can change the software and use pieces of it in new free programs; and that you are informed that you can do these things.

To protect your rights, we need to make restrictions that forbid distributors to deny you these rights or to ask you to surrender these rights. These restrictions translate to certain responsibilities for you if you distribute copies of the library or if you modify it.

For example, if you distribute copies of the library, whether gratis or for a fee, you must give the recipients all the rights that we gave you. You must make sure that they, too, receive or can get the source code. If you link other code with the library, you must provide complete object files to the recipients, so that they can relink them with the library after making changes to the library and recompiling it. And you must show them these terms so they know their rights.

We protect your rights with a two-step method: (1) we copyright the library, and (2) we offer you this license, which gives you legal permission to copy, distribute and/or modify the library.

To protect each distributor, we want to make it very clear that there is no warranty for the free library. Also, if the library is modified by someone else and passed on, the recipients should know that what they have is not the original version, so that the original author's reputation will not be affected by problems that might be introduced by others.

Finally, software patents pose a constant threat to the existence of any free program. We wish to make sure that a company cannot effectively restrict the users of a free program by obtaining a restrictive license from a patent holder. Therefore, we insist that any patent license obtained for a version of the library must be consistent with the full freedom of use specified in this license.

Most GNU software, including some libraries, is covered by the ordinary GNU General Public License. This license, the GNU Lesser General Public License, applies to certain designated libraries, and is quite different from the ordinary General Public License. We use this license for certain libraries in order to permit linking those libraries into non-free programs.

When a program is linked with a library, whether statically or using a shared library, the combination of the two is legally speaking a combined work, a derivative of the original library. The ordinary General Public License therefore permits such linking only if the entire combination fits its criteria of freedom. The Lesser General Public License permits more lax criteria for linking other code with the library.

We call this license the "Lesser" General Public License because it does Less to protect the user's freedom than the ordinary General Public License. It also provides other free software developers Less of an advantage over competing non-free programs. These disadvantages are the reason we use the ordinary General Public License for many libraries. However, the Lesser license provides advantages in certain special circumstances.

For example, on rare occasions, there may be a special need to encourage the widest possible use of a certain library, so that it becomes a de-facto standard. To achieve this, non-free programs must be allowed to use the library. A more frequent case is that a free library does the same job as widely used non-free libraries. In this case, there is little to gain by limiting the free library to free software only, so we use the Lesser General Public License.

In other cases, permission to use a particular library in non-free programs enables a greater number of people to use a large body of free software. For example, permission to use the GNU C Library in non-free programs enables many more people to use the whole GNU operating system, as well as its variant, the GNU/Linux operating system.

Although the Lesser General Public License is Less protective of the users' freedom, it does ensure that the user of a program that is linked with the Library has the freedom and the wherewithal to run that program using a modified version of the Library.

The precise terms and conditions for copying, distribution and modification follow. Pay close attention to the difference between a "work based on the library" and a "work that uses the library". The former contains code derived from the library, whereas the latter must be combined with the library in order to run.

GNU LESSER GENERAL PUBLIC LICENSE TERMS AND CONDITIONS FOR COPYING, DISTRIBUTION AND MODIFICATION

0. This License Agreement applies to any software library or other program which contains a notice placed by the copyright holder or other authorized party saying it may be distributed under the terms of this Lesser General Public License (also called "this License"). Each licensee is addressed as "you".

A "library" means a collection of software functions and/or data prepared so as to be conveniently linked with application programs (which use some of those functions and data) to form executables.

The "Library", below, refers to any such software library or work which has been distributed under these terms. A "work based on the Library" means either the Library or any derivative work under copyright law: that is to say, a work containing the Library or a portion of it, either verbatim or with modifications and/or translated straightforwardly into another language. (Hereinafter, translation is included without limitation in the term "modification".)

"Source code" for a work means the preferred form of the work for making modifications to it. For a library, complete source code means all the source code for all modules it contains, plus any associated interface definition files, plus the scripts used to control compilation and installation of the library.

Activities other than copying, distribution and modification are not covered by this License; they are outside its scope. The act of running a program using the Library is not restricted, and output from such a program is covered only if its contents constitute a work based on the Library (independent of the use of the Library in a tool for writing it). Whether that is true depends on what the Library does and what the program that uses the Library does.

1. You may copy and distribute verbatim copies of the Library's complete source code as you receive it, in any medium, provided that you conspicuously and appropriately publish on each copy an appropriate copyright notice and disclaimer of warranty; keep intact all the notices that refer to this License and to the absence of any warranty; and distribute a copy of this License along with the Library.

You may charge a fee for the physical act of transferring a copy, and you may at your option offer warranty protection in exchange for a fee.

2. You may modify your copy or copies of the Library or any portion of it, thus forming a work based on the Library, and copy and distribute such modifications or work under the terms of Section 1 above, provided that you also meet all of these conditions:
 - a) The modified work must itself be a software library.
 - b) You must cause the files modified to carry prominent notices stating that you changed the files and the date of any change.
 - c) You must cause the whole of the work to be licensed at no charge to all third parties under the terms of this License.
 - d) If a facility in the modified Library refers to a function or a table of data to be supplied by an application program that uses the facility, other than as an argument passed when the facility is invoked, then you must make a good faith effort to ensure that, in the event an application does not supply such function or table, the facility still operates, and performs whatever part of its purpose remains meaningful. (For example, a function in a library to compute square roots has a purpose that is entirely well-defined independent of the application. Therefore, Subsection 2d requires that any application-supplied function or table used by this function must be optional: if the application does not supply it, the square root function must still compute square roots.)

These requirements apply to the modified work as a whole. If identifiable sections of that work are not derived from the Library, and can be reasonably considered independent and separate works in themselves, then this License, and its terms, do not apply to those sections when you distribute them as separate works. But when you distribute the same sections as part of a whole which is a work based on the Library, the distribution of the whole must be on the terms of this License, whose permissions for other licensees extend to the entire whole, and thus to each and every part regardless of who wrote it.

Thus, it is not the intent of this section to claim rights or contest your rights to work written entirely by you; rather, the intent is to exercise the right to control the distribution of derivative or collective works based on the Library.

In addition, mere aggregation of another work not based on the Library with the Library (or with a work based on the Library) on a volume of a storage or distribution medium does not bring the other work under the scope of this License.

3. You may opt to apply the terms of the ordinary GNU General Public License instead of this License to a given copy of the Library. To do this, you must alter all the notices that refer to this License, so that they refer to the ordinary GNU General Public License, version 2, instead of to this License. (If a newer version than version 2 of the ordinary GNU General Public License has appeared, then you can specify that version instead if you wish.) Do not make any other change in these notices.

Once this change is made in a given copy, it is irreversible for that copy, so the ordinary GNU General Public License applies to all subsequent copies and derivative works made from that copy.

This option is useful when you wish to copy part of the code of the Library into a program that is not a library.

4. You may copy and distribute the Library (or a portion or derivative of it, under Section 2) in object code or executable form under the terms of Sections 1 and 2 above provided that you accompany it with the complete corresponding machine-readable source code, which must be distributed under the terms of Sections 1 and 2 above on a medium customarily used for software interchange.

If distribution of object code is made by offering access to copy from a designated place, then offering equivalent access to copy the source code from the same place satisfies the requirement to distribute the source code, even though third parties are not compelled to copy the source along with the object code.

5. A program that contains no derivative of any portion of the Library, but is designed to work with the Library by being compiled or linked with it, is called a "work that uses the Library". Such a work, in isolation, is not a derivative work of the Library, and therefore falls outside the scope of this License.

However, linking a "work that uses the Library" with the Library creates an executable that is a derivative of the Library (because it contains portions of the Library), rather than a "work that uses the library". The executable is therefore covered by this License. Section 6 states terms for distribution of such executables.

When a "work that uses the Library" uses material from a header file that is part of the Library, the object code for the work may be a derivative work of the Library even though the source code is not. Whether this is true is especially significant if the work can be linked without the Library, or if the work is itself a library. The threshold for this to be true is not precisely defined by law.

If such an object file uses only numerical parameters, data structure layouts and accessors, and small macros and small inline functions (ten lines or less in length), then the use of the object file is unrestricted, regardless of whether it is legally a derivative work. (Executables containing this object code plus portions of the Library will still fall under Section 6.)

Otherwise, if the work is a derivative of the Library, you may distribute the object code for the work under the terms of Section 6. Any executables containing that work also fall under Section 6, whether or not they are linked directly with the Library itself.

6. As an exception to the Sections above, you may also combine or link a "work that uses the Library" with the Library to produce a work containing portions of the Library, and distribute that work under terms of your choice, provided that the terms permit modification of the work for the customer's own use and reverse engineering for debugging such modifications.

You must give prominent notice with each copy of the work that the Library is used in it and that the Library and its use are covered by this License. You must supply a copy of this License. If the work during execution displays copyright notices, you must include the copyright notice for the Library among them, as well as a reference directing the user to the copy of this License. Also, you must do one of these things:

- a) Accompany the work with the complete corresponding machine-readable source code for the Library including whatever changes were used in the work (which must be distributed under Sections 1 and 2 above); and, if the work is an executable linked with the Library, with the complete machine-readable "work that uses the Library", as object code and/or source code, so that the user can modify the Library and then relink to produce a modified executable containing the modified Library. (It is understood that the user who changes the contents of definitions files in the Library will not necessarily be able to recompile the application to use the modified definitions.)
- b) Use a suitable shared library mechanism for linking with the Library. A suitable mechanism is one that (1) uses at run time a copy of the library already present on the user's computer system, rather than copying library functions into the executable, and (2) will operate properly with a modified version of the library, if the user installs one, as long as the modified version is interface-compatible with the version that the work was made with.
- c) Accompany the work with a written offer, valid for at least three years, to give the same user the materials specified in Subsection 6a, above, for a charge no more than the cost of performing this distribution.
- d) If distribution of the work is made by offering access to copy from a designated place, offer equivalent access to copy the above specified materials from the same place.
- e) Verify that the user has already received a copy of these materials or that you have already sent this user a copy.

For an executable, the required form of the "work that uses the Library" must include any data and utility programs needed for reproducing the executable from it. However, as a special exception, the materials to be distributed need not include anything that is normally distributed (in either source or binary form) with the major components (compiler, kernel, and so on) of the operating system on which the executable runs, unless that component itself accompanies the executable.

It may happen that this requirement contradicts the license restrictions of other proprietary libraries that do not normally accompany the operating system. Such a contradiction means you cannot use both them and the Library together in an executable that you distribute.

7. You may place library facilities that are a work based on the Library side-by-side in a single library together with other library facilities not covered by this License, and distribute such a combined library, provided that the separate distribution of the work based on the Library and of the other library facilities is otherwise permitted, and provided that you do these two things:
 - a) Accompany the combined library with a copy of the same work based on the Library, uncombined with any other library facilities. This must be distributed under the terms of the Sections above.
 - b) Give prominent notice with the combined library of the fact that part of it is a work based on the Library, and explaining where to find the accompanying uncombined form of the same work.
8. You may not copy, modify, sublicense, link with, or distribute the Library except as expressly provided under this License. Any attempt otherwise to copy, modify, sublicense, link with, or distribute the Library is void, and will automatically terminate your rights under this License. However, parties who have received copies, or rights, from you under this License will not have their licenses terminated so long as such parties remain in full compliance.

9. You are not required to accept this License, since you have not signed it. However, nothing else grants you permission to modify or distribute the Library or its derivative works. These actions are prohibited by law if you do not accept this License. Therefore, by modifying or distributing the Library (or any work based on the Library), you indicate your acceptance of this License to do so, and all its terms and conditions for copying, distributing or modifying the Library or works based on it.
10. Each time you redistribute the Library (or any work based on the Library), the recipient automatically receives a license from the original licensor to copy, distribute, link with or modify the Library subject to these terms and conditions. You may not impose any further restrictions on the recipients' exercise of the rights granted herein. You are not responsible for enforcing compliance by third parties with this License.
11. If, as a consequence of a court judgment or allegation of patent infringement or for any other reason (not limited to patent issues), conditions are imposed on you (whether by court order, agreement or otherwise) that contradict the conditions of this License, they do not excuse you from the conditions of this License. If you cannot distribute so as to satisfy simultaneously your obligations under this License and any other pertinent obligations, then as a consequence you may not distribute the Library at all. For example, if a patent license would not permit royalty-free redistribution of the Library by all those who receive copies directly or indirectly through you, then the only way you could satisfy both it and this License would be to refrain entirely from distribution of the Library.

If any portion of this section is held invalid or unenforceable under any particular circumstance, the balance of the section is intended to apply, and the section as a whole is intended to apply in other circumstances.

It is not the purpose of this section to induce you to infringe any patents or other property right claims or to contest validity of any such claims; this section has the sole purpose of protecting the integrity of the free software distribution system which is implemented by public license practices. Many people have made generous contributions to the wide range of software distributed through that system in reliance on consistent application of that system; it is up to the author/donor to decide if he or she is willing to distribute software through any other system and a licensee cannot impose that choice.

This section is intended to make thoroughly clear what is believed to be a consequence of the rest of this License.

12. If the distribution and/or use of the Library is restricted in certain countries either by patents or by copyrighted interfaces, the original copyright holder who places the Library under this License may add an explicit geographical distribution limitation excluding those countries, so that distribution is permitted only in or among countries not thus excluded. In such case, this License incorporates the limitation as if written in the body of this License.
13. The Free Software Foundation may publish revised and/or new versions of the Lesser General Public License from time to time. Such new versions will be similar in spirit to the present version, but may differ in detail to address new problems or concerns.

Each version is given a distinguishing version number. If the Library specifies a version number of this License which applies to it and "any later version", you have the option of following the terms and conditions either of that version or of any later version published by the Free Software Foundation. If the Library does not specify a license version number, you may choose any version ever published by the Free Software Foundation.

14. If you wish to incorporate parts of the Library into other free programs whose distribution conditions are incompatible with these, write to the author to ask for permission. For software which is copyrighted by the Free Software Foundation, write to the Free Software Foundation; we sometimes make exceptions for this. Our decision will be guided by the two goals of preserving the free status of all derivatives of our free software and of promoting the sharing and reuse of software generally.

NO WARRANTY

15. BECAUSE THE LIBRARY IS LICENSED FREE OF CHARGE, THERE IS NO WARRANTY FOR THE LIBRARY, TO THE EXTENT PERMITTED BY APPLICABLE LAW. EXCEPT WHEN OTHERWISE STATED IN WRITING THE COPYRIGHT HOLDERS AND/OR OTHER PARTIES PROVIDE THE LIBRARY "AS IS" WITHOUT WARRANTY OF ANY KIND, EITHER EXPRESSED OR IMPLIED, INCLUDING, BUT NOT LIMITED TO, THE IMPLIED WARRANTIES OF MERCHANTABILITY AND FITNESS FOR A PARTICULAR PURPOSE. THE ENTIRE RISK AS TO THE QUALITY AND PERFORMANCE OF THE LIBRARY IS WITH YOU. SHOULD THE LIBRARY PROVE DEFECTIVE, YOU ASSUME THE COST OF ALL NECESSARY SERVICING, REPAIR OR CORRECTION.
16. IN NO EVENT UNLESS REQUIRED BY APPLICABLE LAW OR AGREED TO IN WRITING WILL ANY COPYRIGHT HOLDER, OR ANY OTHER PARTY WHO MAY MODIFY AND / OR REDISTRIBUTE THE LIBRARY AS PERMITTED ABOVE, BE LIABLE TO YOU FOR DAMAGES, INCLUDING ANY GENERAL, SPECIAL, INCIDENTAL OR CONSEQUENTIAL DAMAGES ARISING OUT OF THE USE OR INABILITY TO USE THE LIBRARY (INCLUDING BUT NOT LIMITED TO LOSS OF DATA OR DATA BEING RENDERED INACCURATE OR LOSSES SUSTAINED BY YOU OR THIRD PARTIES OR A FAILURE OF THE LIBRARY TO OPERATE WITH ANY OTHER SOFTWARE), EVEN IF SUCH HOLDER OR OTHER PARTY HAS BEEN ADVISED OF THE POSSIBILITY OF SUCH DAMAGES.

END OF TERMS AND CONDITIONS

How to Apply These Terms to Your New Libraries

If you develop a new library, and you want it to be of the greatest possible use to the public, we recommend making it free software that everyone can redistribute and change. You can do so by permitting redistribution under these terms (or, alternatively, under the terms of the ordinary General Public License).

To apply these terms, attach the following notices to the library. It is safest to attach them to the start of each source file to most effectively convey the exclusion of warranty; and each file should have at least the "copyright" line and a pointer to where the full notice is found.

```
<one line to give the library's name and a brief idea of what it does.>
Copyright (C) <year> <name of author>
```

This library is free software; you can redistribute it and/or modify it under the terms of the GNU Lesser General Public License as published by the Free Software Foundation; either version 2.1. of the License, or (at your option) any later version.

This library is distributed in the hope that it will be useful, but WITHOUT ANY WARRANTY; without even the implied warranty of MERCHANTABILITY or FITNESS FOR A PARTICULAR PURPOSE. See the GNU Lesser General Public License for more details.

You should have received a copy of the GNU Lesser General Public License along with this library; if not, write to the Free Software Foundation, Inc., 51 Franklin Street, Fifth Floor, Boston, MA 02110-1301 USA

Also add information on how to contact you by electronic and paper mail.

You should also get your employer (if you work as a programmer) or your school, if any, to sign a "copyright disclaimer" for the library, if necessary. Here is a sample; alter the names:

```
Yoyodyne, Inc., hereby disclaims all copyright interest in the library `Frob' (a library for
tweaking knobs) written by James Random Hacker.
```

```
<signature of Ty Coon>, 1 April 1990
Ty Coon, President of Vice
```

That's all there is to it!

13.2.2. Version 3.0

GNU LESSER GENERAL PUBLIC LICENSE Version 3, 29 June 2007

Copyright (C) 2007 Free Software Foundation, Inc. <<https://fsf.org/>>

Everyone is permitted to copy and distribute verbatim copies of this license document, but changing it is not allowed.

This version of the GNU Lesser General Public License incorporates the terms and conditions of version 3 of the GNU General Public License, supplemented by the additional permissions listed below.

0. Additional Definitions.

As used herein, "this License" refers to version 3 of the GNU Lesser General Public License, and the "GNU GPL" refers to version 3 of the GNU General Public License.

"The Library" refers to a covered work governed by this License, other than an Application or a Combined Work as defined below.

An "Application" is any work that makes use of an interface provided by the Library, but which is not otherwise based on the Library. Defining a subclass of a class defined by the Library is deemed a mode of using an interface provided by the Library.

A "Combined Work" is a work produced by combining or linking an Application with the Library. The particular version of the Library with which the Combined Work was made is also called the "Linked Version".

The "Minimal Corresponding Source" for a Combined Work means the Corresponding Source for the Combined Work, excluding any source code for portions of the Combined Work that, considered in isolation, are based on the Application, and not on the Linked Version.

The "Corresponding Application Code" for a Combined Work means the object code and/or source code for the Application, including any data and utility programs needed for reproducing the Combined Work from the Application, but excluding the System Libraries of the Combined Work.

1. Exception to Section 3 of the GNU GPL.

You may convey a covered work under sections 3 and 4 of this License without being bound by section 3 of the GNU GPL.

2. Conveying Modified Versions.

If you modify a copy of the Library, and, in your modifications, a facility refers to a function or data to be supplied by an Application that uses the facility (other than as an argument passed when the facility is invoked), then you may convey a copy of the modified version:

- a) under this License, provided that you make a good faith effort to ensure that, in the event an Application does not supply the function or data, the facility still operates, and performs whatever part of its purpose remains meaningful, or
- b) under the GNU GPL, with none of the additional permissions of this License applicable to that copy.

3. Object Code Incorporating Material from Library Header Files.

The object code form of an Application may incorporate material from a header file that is part of the Library. You may convey such object code under terms of your choice, provided that, if the incorporated material is not limited to numerical parameters, data structure layouts and accessors, or small macros, inline functions and templates (ten or fewer lines in length), you do both of the following:

- a) Give prominent notice with each copy of the object code that the Library is used in it and that the Library and its use are covered by this License.
- b) Accompany the object code with a copy of the GNU GPL and this license document.

4. Combined Works.

You may convey a Combined Work under terms of your choice that, taken together, effectively do not restrict modification of the portions of the Library contained in the Combined Work and reverse engineering for debugging such modifications, if you also do each of the following:

- a) Give prominent notice with each copy of the Combined Work that the Library is used in it and that the Library and its use are covered by this License.
- b) Accompany the Combined Work with a copy of the GNU GPL and this license document.
- c) For a Combined Work that displays copyright notices during execution, include the copyright notice for the Library among these notices, as well as a reference directing the user to the copies of the GNU GPL and this license document.
- d) Do one of the following:
 - 0) Convey the Minimal Corresponding Source under the terms of this License, and the Corresponding Application Code in a form suitable for, and under terms that permit, the user to recombine or relink the Application with a modified version of the Linked Version to produce a modified Combined Work, in the manner specified by section 6 of the GNU GPL for conveying Corresponding Source.
 - 1) Use a suitable shared library mechanism for linking with the Library. A suitable mechanism is one that (a) uses at run time a copy of the Library already present on the user's computer system, and (b) will operate properly with a modified version of the Library that is interface-compatible with the Linked Version.
- e) Provide Installation Information, but only if you would otherwise be required to provide such information under section 6 of the GNU GPL, and only to the extent that such information is necessary to install and execute a modified version of the Combined Work produced by recombining or relinking the Application with a modified version of the Linked Version. (If you use option 4d0, the Installation Information must accompany the Minimal Corresponding Source and Corresponding Application Code. If you use option 4d1, you must provide the Installation Information in the manner specified by section 6 of the GNU GPL for conveying Corresponding Source.)

5. Combined Libraries.

You may place library facilities that are a work based on the Library side by side in a single library together with other library facilities that are not Applications and are not covered by this License, and convey such a combined library under terms of your choice, if you do both of the following:

- a) Accompany the combined library with a copy of the same work based on the Library, uncombined with any other library facilities, conveyed under the terms of this License.
- b) Give prominent notice with the combined library that part of it is a work based on the Library, and explaining where to find the accompanying uncombined form of the same work.

6. Revised Versions of the GNU Lesser General Public License.

The Free Software Foundation may publish revised and/or new versions of the GNU Lesser General Public License from time to time. Such new versions will be similar in spirit to the present version, but may differ in detail to address new problems or concerns.

Each version is given a distinguishing version number. If the Library as you received it specifies that a certain numbered version of the GNU Lesser General Public License "or any later version" applies to it, you have the option of following the terms and conditions either of that published version or of any later version published by the Free Software Foundation. If the Library as you received it does not specify a version number of the GNU Lesser General Public License, you may choose any version of the GNU Lesser General Public License ever published by the Free Software Foundation.

If the Library as you received it specifies that a proxy can decide whether future versions of the GNU Lesser General Public License shall apply, that proxy's public statement of acceptance of any version is permanent authorization for you to choose that version for the Library.

13.3. BSD License

13.3.1. 2-Clause

Redistribution and use in source and binary forms, with or without modification, are permitted provided that the following conditions are met:

1. Redistributions of source code must retain the above copyright notice, this list of conditions and the following disclaimer.
2. Redistributions in binary form must reproduce the above copyright notice, this list of conditions and the following disclaimer in the documentation and/or other materials provided with the distribution.

THIS SOFTWARE IS PROVIDED BY THE COPYRIGHT HOLDERS AND CONTRIBUTORS "AS IS" AND ANY EXPRESS OR IMPLIED WARRANTIES, INCLUDING, BUT NOT LIMITED TO, THE IMPLIED WARRANTIES OF MERCHANTABILITY AND FITNESS FOR A PARTICULAR PURPOSE ARE DISCLAIMED. IN NO EVENT SHALL THE COPYRIGHT HOLDER OR CONTRIBUTORS BE LIABLE FOR ANY DIRECT, INDIRECT, INCIDENTAL, SPECIAL, EXEMPLARY, OR CONSEQUENTIAL DAMAGES (INCLUDING, BUT NOT LIMITED TO, PROCUREMENT OF SUBSTITUTE GOODS OR SERVICES; LOSS OF USE, DATA, OR PROFITS; OR BUSINESS INTERRUPTION) HOWEVER CAUSED AND ON ANY THEORY OF LIABILITY, WHETHER IN CONTRACT, STRICT LIABILITY, OR TORT (INCLUDING NEGLIGENCE OR OTHERWISE) ARISING IN ANY WAY OUT OF THE USE OF THIS SOFTWARE, EVEN IF ADVISED OF THE POSSIBILITY OF SUCH DAMAGE.

13.3.2. 3-Clause

Redistribution and use in source and binary forms, with or without modification, are permitted provided that the following conditions are met:

1. Redistributions of source code must retain the above copyright notice, this list of conditions and the following disclaimer.
2. Redistributions in binary form must reproduce the above copyright notice, this list of conditions and the following disclaimer in the documentation and/or other materials provided with the distribution.
3. Neither the name of the copyright holder nor the names of its contributors may be used to endorse or promote products derived from this software without specific prior written permission.

THIS SOFTWARE IS PROVIDED BY THE COPYRIGHT HOLDERS AND CONTRIBUTORS "AS IS" AND ANY EXPRESS OR IMPLIED WARRANTIES, INCLUDING, BUT NOT LIMITED TO, THE IMPLIED WARRANTIES OF MERCHANTABILITY AND FITNESS FOR A PARTICULAR PURPOSE ARE DISCLAIMED. IN NO EVENT SHALL THE COPYRIGHT HOLDER OR CONTRIBUTORS BE LIABLE FOR ANY DIRECT, INDIRECT, INCIDENTAL, SPECIAL, EXEMPLARY, OR CONSEQUENTIAL DAMAGES (INCLUDING, BUT NOT LIMITED TO, PROCUREMENT OF SUBSTITUTE GOODS OR SERVICES; LOSS OF USE, DATA, OR PROFITS; OR BUSINESS INTERRUPTION) HOWEVER CAUSED AND ON ANY THEORY OF LIABILITY, WHETHER IN CONTRACT, STRICT LIABILITY, OR TORT (INCLUDING NEGLIGENCE OR OTHERWISE) ARISING IN ANY WAY OUT OF THE USE OF THIS SOFTWARE, EVEN IF ADVISED OF THE POSSIBILITY OF SUCH DAMAGE.

13.3.3. 4-Clause

Redistribution and use in source and binary forms, with or without modification, are permitted provided that the following conditions are met:

1. Redistributions of source code must retain the above copyright notice, this list of conditions and the following disclaimer.
2. Redistributions in binary form must reproduce the above copyright notice, this list of conditions and the following disclaimer in the documentation and/or other materials provided with the distribution.
3. All advertising materials mentioning features or use of this software must display the following acknowledgement:
This product includes software developed by the <organization>.
4. Neither the name of the <organization> nor the names of its contributors may be used to endorse or promote products derived from this software without specific prior written permission.

THIS SOFTWARE IS PROVIDED BY <COPYRIGHT HOLDER> "AS IS" AND ANY EXPRESS OR IMPLIED WARRANTIES, INCLUDING, BUT NOT LIMITED TO, THE IMPLIED WARRANTIES OF MERCHANTABILITY AND FITNESS FOR A PARTICULAR PURPOSE ARE DISCLAIMED. IN NO EVENT SHALL <COPYRIGHT HOLDER> BE LIABLE FOR ANY DIRECT, INDIRECT, INCIDENTAL, SPECIAL, EXEMPLARY, OR CONSEQUENTIAL DAMAGES (INCLUDING, BUT NOT LIMITED TO, PROCUREMENT OF SUBSTITUTE GOODS OR SERVICES; LOSS OF USE, DATA, OR PROFITS; OR BUSINESS INTERRUPTION) HOWEVER CAUSED AND ON ANY THEORY OF LIABILITY, WHETHER IN CONTRACT, STRICT LIABILITY, OR TORT (INCLUDING NEGLIGENCE OR OTHERWISE) ARISING IN ANY WAY OUT OF THE USE OF THIS SOFTWARE, EVEN IF ADVISED OF THE POSSIBILITY OF SUCH DAMAGE.

13.4. Python Software Foundation License

A. HISTORY OF THE SOFTWARE

Python was created in the early 1990s by Guido van Rossum at Stichting Mathematisch Centrum (CWI, see <http://www.cwi.nl>) in the Netherlands as a successor of a language called ABC. Guido remains Python's principal author, although it includes many contributions from others.

In 1995, Guido continued his work on Python at the Corporation for National Research Initiatives (CNRI, see <http://www.cnri.reston.va.us>) in Reston, Virginia where he released several versions of the software.

In May 2000, Guido and the Python core development team moved to BeOpen.com to form the BeOpen PythonLabs team. In October of the same year, the PythonLabs team moved to Digital Creations, which became Zope Corporation. In 2001, the Python Software Foundation (PSF, see <https://www.python.org/psf/>) was formed, a non-profit organization created specifically to own Python-related Intellectual Property. Zope Corporation was a sponsoring member of the PSF.

All Python releases are Open Source (see <http://www.opensource.org> for the Open Source Definition). Historically, most, but not all, Python releases have also been GPL-compatible; the table below summarizes the various releases.

Release	Derived from	Year	Owner	GPL-compatible? (1)
0.9.0 thru 1.2.		1991-1995	CWI	yes
1.3. thru 1.5.2	1.2	1995-1999	CNRI	yes
1.6	1.5.2	2000	CNRI	no
2.0	1.6	2000	BeOpen.com	no
1.6.1	1.6	2001	CNRI	yes (2)
2.1	2.0+1.6.1	2001	PSF	no
2.0.1	2.0+1.6.1	2001	PSF	yes
2.1.1	2.1+2.0.1	2001	PSF	yes
2.1.2	2.1.1	2002	PSF	yes
2.1.3	2.1.2	2002	PSF	yes
2.2. and above	2.1.1	2001-now	PSF	yes

Footnotes:

- (1) GPL-compatible doesn't mean that we're distributing Python under the GPL. All Python licenses, unlike the GPL, let you distribute a modified version without making your changes open source. The GPL-compatible licenses make it possible to combine Python with other software that is released under the GPL; the others don't.
- (2) According to Richard Stallman, 1.6.1. is not GPL-compatible, because its license has a choice of law clause. According to CNRI, however, Stallman's lawyer has told CNRI's lawyer that 1.6.1. is "not incompatible" with the GPL.

Thanks to the many outside volunteers who have worked under Guido's direction to make these releases possible.

B. TERMS AND CONDITIONS FOR ACCESSING OR OTHERWISE USING PYTHON

PYTHON SOFTWARE FOUNDATION LICENSE VERSION 2

1. This LICENSE AGREEMENT is between the Python Software Foundation ("PSF"), and the Individual or Organization ("Licensee") accessing and otherwise using this software ("Python") in source or binary form and its associated documentation.
2. Subject to the terms and conditions of this License Agreement, PSF hereby grants Licensee a nonexclusive, royalty-free, world-wide license to reproduce, analyze, test, perform and/or display publicly, prepare derivative works, distribute, and otherwise use Python alone or in any derivative version, provided, however, that PSF's License Agreement and PSF's notice of copyright, i.e., "Copyright (c) 2001, 2002, 2003, 2004, 2005, 2006, 2007, 2008, 2009, 2010, 2011, 2012, 2013, 2014, 2015, 2016, 2017 Python Software Foundation; All Rights Reserved" are retained in Python alone or in any derivative version prepared by Licensee.
3. In the event Licensee prepares a derivative work that is based on or incorporates Python or any part thereof, and wants to make the derivative work available to others as provided herein, then Licensee hereby agrees to include in any such work a brief summary of the changes made to Python.
4. PSF is making Python available to Licensee on an "AS IS" basis. PSF MAKES NO REPRESENTATIONS OR WARRANTIES, EXPRESS OR IMPLIED. BY WAY OF EXAMPLE, BUT NOT LIMITATION, PSF MAKES NO AND DISCLAIMS ANY REPRESENTATION OR WARRANTY OF MERCHANTABILITY OR FITNESS FOR ANY PARTICULAR PURPOSE OR THAT THE USE OF PYTHON WILL NOT INFRINGE ANY THIRD PARTY RIGHTS.
5. PSF SHALL NOT BE LIABLE TO LICENSEE OR ANY OTHER USERS OF PYTHON FOR ANY INCIDENTAL, SPECIAL, OR CONSEQUENTIAL DAMAGES OR LOSS AS A RESULT OF MODIFYING, DISTRIBUTING, OR OTHERWISE USING PYTHON, OR ANY DERIVATIVE THEREOF, EVEN IF ADVISED OF THE POSSIBILITY THEREOF.
6. This License Agreement will automatically terminate upon a material breach of its terms and conditions.
7. Nothing in this License Agreement shall be deemed to create any relationship of agency, partnership, or joint venture between PSF and Licensee. This License Agreement does not grant permission to use PSF trademarks or trade name in a trademark sense to endorse or promote products or services of Licensee, or any third party.
8. By copying, installing or otherwise using Python, Licensee agrees to be bound by the terms and conditions of this License Agreement.

BEOPEN.COM LICENSE AGREEMENT FOR PYTHON 2.0

BEOPEN PYTHON OPEN SOURCE LICENSE AGREEMENT VERSION 1

1. This LICENSE AGREEMENT is between BeOpen.com ("BeOpen"), having an office at 160 Saratoga Avenue, Santa Clara, CA 95051, and the Individual or Organization ("Licensee") accessing and otherwise using this software in source or binary form and its associated documentation ("the Software").
2. Subject to the terms and conditions of this BeOpen Python License Agreement, BeOpen hereby grants Licensee a non-exclusive, royalty-free, world-wide license to reproduce, analyze, test, perform and/or display publicly, prepare derivative works, distribute, and otherwise use the Software alone or in any derivative version, provided, however, that the BeOpen Python License is retained in the Software, alone or in any derivative version prepared by Licensee.

3. BeOpen is making the Software available to Licensee on an "AS IS" basis. BEOPEN MAKES NO REPRESENTATIONS OR WARRANTIES, EXPRESS OR IMPLIED. BY WAY OF EXAMPLE, BUT NOT LIMITATION, BEOPEN MAKES NO AND DISCLAIMS ANY REPRESENTATION OR WARRANTY OF MERCHANTABILITY OR FITNESS FOR ANY PARTICULAR PURPOSE OR THAT THE USE OF THE SOFTWARE WILL NOT INFRINGE ANY THIRD PARTY RIGHTS.
4. BEOPEN SHALL NOT BE LIABLE TO LICENSEE OR ANY OTHER USERS OF THE SOFTWARE FOR ANY INCIDENTAL, SPECIAL, OR CONSEQUENTIAL DAMAGES OR LOSS AS A RESULT OF USING, MODIFYING OR DISTRIBUTING THE SOFTWARE, OR ANY DERIVATIVE THEREOF, EVEN IF ADVISED OF THE POSSIBILITY THEREOF.
5. This License Agreement will automatically terminate upon a material breach of its terms and conditions.
6. This License Agreement shall be governed by and interpreted in all respects by the law of the State of California, excluding conflict of law provisions. Nothing in this License Agreement shall be deemed to create any relationship of agency, partnership, or joint venture between BeOpen and Licensee. This License Agreement does not grant permission to use BeOpen trademarks or trade names in a trademark sense to endorse or promote products or services of Licensee, or any third party. As an exception, the "BeOpen Python" logos available at <http://www.pythonlabs.com/logos.html> may be used according to the permissions granted on that web page.
7. By copying, installing or otherwise using the software, Licensee agrees to be bound by the terms and conditions of this License Agreement.

CNRI LICENSE AGREEMENT FOR PYTHON 1.6.1

1. This LICENSE AGREEMENT is between the Corporation for National Research Initiatives, having an office at 1895 Preston White Drive, Reston, VA 20191 ("CNRI"), and the Individual or Organization ("Licensee") accessing and otherwise using Python 1.6.1. software in source or binary form and its associated documentation.
2. Subject to the terms and conditions of this License Agreement, CNRI hereby grants Licensee a nonexclusive, royalty-free, world-wide license to reproduce, analyze, test, perform and/or display publicly, prepare derivative works, distribute, and otherwise use Python 1.6.1. alone or in any derivative version, provided, however, that CNRI's License Agreement and CNRI's notice of copyright, i.e., "Copyright (c) 1995-2001 Corporation for National Research Initiatives; All Rights Reserved" are retained in Python 1.6.1. alone or in any derivative version prepared by Licensee. Alternately, in lieu of CNRI's License Agreement, Licensee may substitute the following text (omitting the quotes): "Python 1.6.1. is made available subject to the terms and conditions in CNRI's License Agreement. This Agreement together with Python 1.6.1. may be located on the Internet using the following unique, persistent identifier (known as a handle): 1895.22/1013. This Agreement may also be obtained from a proxy server on the Internet using the following URL: <http://hdl.handle.net/1895.22/1013>".
3. In the event Licensee prepares a derivative work that is based on or incorporates Python 1.6.1. or any part thereof, and wants to make the derivative work available to others as provided herein, then Licensee hereby agrees to include in any such work a brief summary of the changes made to Python 1.6.1.
4. CNRI is making Python 1.6.1. available to Licensee on an "AS IS" basis. CNRI MAKES NO REPRESENTATIONS OR WARRANTIES, EXPRESS OR IMPLIED. BY WAY OF EXAMPLE, BUT NOT LIMITATION, CNRI MAKES NO AND DISCLAIMS ANY REPRESENTATION OR WARRANTY OF MERCHANTABILITY OR FITNESS FOR ANY PARTICULAR PURPOSE OR THAT THE USE OF PYTHON 1.6.1. WILL NOT INFRINGE ANY THIRD PARTY RIGHTS.

5. CNRI SHALL NOT BE LIABLE TO LICENSEE OR ANY OTHER USERS OF PYTHON 1.6.1. FOR ANY INCIDENTAL, SPECIAL, OR CONSEQUENTIAL DAMAGES OR LOSS AS A RESULT OF MODIFYING, DISTRIBUTING, OR OTHERWISE USING PYTHON 1.6.1, OR ANY DERIVATIVE THEREOF, EVEN IF ADVISED OF THE POSSIBILITY THEREOF.
6. This License Agreement will automatically terminate upon a material breach of its terms and conditions.
7. This License Agreement shall be governed by the federal intellectual property law of the United States, including without limitation the federal copyright law, and, to the extent such U.S. federal law does not apply, by the law of the Commonwealth of Virginia, excluding Virginia's conflict of law provisions. Notwithstanding the foregoing, with regard to derivative works based on Python 1.6.1. that incorporate non-separable material that was previously distributed under the GNU General Public License (GPL), the law of the Commonwealth of Virginia shall govern this License Agreement only as to issues arising under or with respect to Paragraphs 4, 5, and 7 of this License Agreement. Nothing in this License Agreement shall be deemed to create any relationship of agency, partnership, or joint venture between CNRI and Licensee. This License Agreement does not grant permission to use CNRI trademarks or trade name in a trademark sense to endorse or promote products or services of Licensee, or any third party.
8. By clicking on the "ACCEPT" button where indicated, or by copying, installing or otherwise using Python 1.6.1, Licensee agrees to be bound by the terms and conditions of this License Agreement.

ACCEPT

CWI LICENSE AGREEMENT FOR PYTHON 0.9.0 THROUGH 1.2

Copyright (c) 1991 - 1995, Stichting Mathematisch Centrum Amsterdam, The Netherlands. All rights reserved.

Permission to use, copy, modify, and distribute this software and its documentation for any purpose and without fee is hereby granted, provided that the above copyright notice appear in all copies and that both that copyright notice and this permission notice appear in supporting documentation, and that the name of Stichting Mathematisch Centrum or CWI not be used in advertising or publicity pertaining to distribution of the software without specific, written prior permission.

STICHTING MATHEMATISCH CENTRUM DISCLAIMS ALL WARRANTIES WITH REGARD TO THIS SOFTWARE, INCLUDING ALL IMPLIED WARRANTIES OF MERCHANTABILITY AND FITNESS, IN NO EVENT SHALL STICHTING MATHEMATISCH CENTRUM BE LIABLE FOR ANY SPECIAL, INDIRECT OR CONSEQUENTIAL DAMAGES OR ANY DAMAGES WHATSOEVER RESULTING FROM LOSS OF USE, DATA OR PROFITS, WHETHER IN AN ACTION OF CONTRACT, NEGLIGENCE OR OTHER TORTIOUS ACTION, ARISING OUT OF OR IN CONNECTION WITH THE USE OR PERFORMANCE OF THIS SOFTWARE.

13.5.PHP License, version 3.01

The PHP License, version 3.01
Copyright (c) 1999 - 2016 The PHP Group. All rights reserved.

Redistribution and use in source and binary forms, with or without modification, is permitted provided that the following conditions are met:

1. Redistributions of source code must retain the above copyright notice, this list of conditions and the following disclaimer.
2. Redistributions in binary form must reproduce the above copyright notice, this list of conditions and the following disclaimer in the documentation and/or other materials provided with the distribution.
3. The name "PHP" must not be used to endorse or promote products derived from this software without prior written permission. For written permission, please contact group@php.net.
4. Products derived from this software may not be called "PHP", nor may "PHP" appear in their name, without prior written permission from group@php.net. You may indicate that your software works in conjunction with PHP by saying "Foo for PHP" instead of calling it "PHP Foo" or "phpfoo"
5. The PHP Group may publish revised and/or new versions of the license from time to time. Each version will be given a distinguishing version number. Once covered code has been published under a particular version of the license, you may always continue to use it under the terms of that version. You may also choose to use such covered code under the terms of any subsequent version of the license published by the PHP Group. No one other than the PHP Group has the right to modify the terms applicable to covered code created under this License.
6. Redistributions of any form whatsoever must retain the following acknowledgment: "This product includes PHP software, freely available from [<http://www.php.net/software/>](http://www.php.net/software/)".

THIS SOFTWARE IS PROVIDED BY THE PHP DEVELOPMENT TEAM ``AS IS" AND ANY EXPRESSED OR IMPLIED WARRANTIES, INCLUDING, BUT NOT LIMITED TO, THE IMPLIED WARRANTIES OF MERCHANTABILITY AND FITNESS FOR A PARTICULAR PURPOSE ARE DISCLAIMED. IN NO EVENT SHALL THE PHP DEVELOPMENT TEAM OR ITS CONTRIBUTORS BE LIABLE FOR ANY DIRECT, INDIRECT, INCIDENTAL, SPECIAL, EXEMPLARY, OR CONSEQUENTIAL DAMAGES (INCLUDING, BUT NOT LIMITED TO, PROCUREMENT OF SUBSTITUTE GOODS OR SERVICES; LOSS OF USE, DATA, OR PROFITS; OR BUSINESS INTERRUPTION) HOWEVER CAUSED AND ON ANY THEORY OF LIABILITY, WHETHER IN CONTRACT, STRICT LIABILITY, OR TORT (INCLUDING NEGLIGENCE OR OTHERWISE) ARISING IN ANY WAY OUT OF THE USE OF THIS SOFTWARE, EVEN IF ADVISED OF THE POSSIBILITY OF SUCH DAMAGE.

This software consists of voluntary contributions made by many individuals on behalf of the PHP Group.

The PHP Group can be contacted via Email at group@php.net.

For more information on the PHP Group and the PHP project, please see [<http://www.php.net>](http://www.php.net).

PHP includes the Zend Engine, freely available at [<http://www.zend.com>](http://www.zend.com).

13.6. OpenSSL License

LICENSE ISSUES

The OpenSSL toolkit stays under a double license, i.e. both the conditions of the OpenSSL License and the original SSLeay license apply to the toolkit. See below for the actual license texts. Actually both licenses are BSD-style Open Source licenses. In case of any license issues related to OpenSSL please contact openssl-core@openssl.org.

OpenSSL License

Copyright (c) 1998-2018 The OpenSSL Project. All rights reserved.

Redistribution and use in source and binary forms, with or without modification, are permitted provided that the following conditions are met:

1. Redistributions of source code must retain the above copyright notice, this list of conditions and the following disclaimer.
2. Redistributions in binary form must reproduce the above copyright notice, this list of conditions and the following disclaimer in the documentation and/or other materials provided with the distribution.
3. All advertising materials mentioning features or use of this software must display the following acknowledgment: "This product includes software developed by the OpenSSL Project for use in the OpenSSL Toolkit. (<http://www.openssl.org/>)"
4. The names "OpenSSL Toolkit" and "OpenSSL Project" must not be used to endorse or promote products derived from this software without prior written permission. For written permission, please contact openssl-core@openssl.org.
5. Products derived from this software may not be called "OpenSSL" nor may "OpenSSL" appear in their names without prior written permission of the OpenSSL Project.
6. Redistributions of any form whatsoever must retain the following acknowledgment: "This product includes software developed by the OpenSSL Project for use in the OpenSSL Toolkit (<http://www.openssl.org/>)"

THIS SOFTWARE IS PROVIDED BY THE OpenSSL PROJECT "AS IS" AND ANY EXPRESSED OR IMPLIED WARRANTIES, INCLUDING, BUT NOT LIMITED TO, THE IMPLIED WARRANTIES OF MERCHANTABILITY AND FITNESS FOR A PARTICULAR PURPOSE ARE DISCLAIMED. IN NO EVENT SHALL THE OpenSSL PROJECT OR ITS CONTRIBUTORS BE LIABLE FOR ANY DIRECT, INDIRECT, INCIDENTAL, SPECIAL, EXEMPLARY, OR CONSEQUENTIAL DAMAGES (INCLUDING, BUT NOT LIMITED TO, PROCUREMENT OF SUBSTITUTE GOODS OR SERVICES; LOSS OF USE, DATA, OR PROFITS; OR BUSINESS INTERRUPTION) HOWEVER CAUSED AND ON ANY THEORY OF LIABILITY, WHETHER IN CONTRACT, STRICT LIABILITY, OR TORT (INCLUDING NEGLIGENCE OR OTHERWISE) ARISING IN ANY WAY OUT OF THE USE OF THIS SOFTWARE, EVEN IF ADVISED OF THE POSSIBILITY OF SUCH DAMAGE.

This product includes cryptographic software written by Eric Young (eay@cryptsoft.com). This product includes software written by Tim Hudson (tjh@cryptsoft.com).

Original SSLeay License

Copyright (C) 1995-1998 Eric Young (eay@cryptsoft.com) All rights reserved.

This package is an SSL implementation written by Eric Young (eay@cryptsoft.com). The implementation was written so as to conform with Netscapes SSL.

This library is free for commercial and non-commercial use as long as the following conditions are aheared to. The following conditions apply to all code found in this distribution, be it the RC4, RSA, lhash, DES, etc., code; not just the SSL code. The SSL documentation included with this distribution is covered by the same copyright terms except that the holder is Tim Hudson (tjh@cryptsoft.com).

Copyright remains Eric Young's, and as such any Copyright notices in the code are not to be removed. If this package is used in a product, Eric Young should be given attribution as the author of the parts of the library used. This can be in the form of a textual message at program startup or in documentation (online or textual) provided with the package.

Redistribution and use in source and binary forms, with or without modification, are permitted provided that the following conditions are met:

1. Redistributions of source code must retain the copyright notice, this list of conditions and the following disclaimer.
2. Redistributions in binary form must reproduce the above copyright notice, this list of conditions and the following disclaimer in the documentation and/or other materials provided with the distribution.
3. All advertising materials mentioning features or use of this software must display the following acknowledgement: "This product includes cryptographic software written by Eric Young (eay@cryptsoft.com)" The word 'cryptographic' can be left out if the rouines from the library being used are not cryptographic related :-).
4. If you include any Windows specific code (or a derivative thereof) from the apps directory (application code) you must include an acknowledgement: "This product includes software written by Tim Hudson (tjh@cryptsoft.com)"

THIS SOFTWARE IS PROVIDED BY ERIC YOUNG ``AS IS" AND ANY EXPRESS OR IMPLIED WARRANTIES, INCLUDING, BUT NOT LIMITED TO, THE IMPLIED WARRANTIES OF MERCHANTABILITY AND FITNESS FOR A PARTICULAR PURPOSE ARE DISCLAIMED. IN NO EVENT SHALL THE AUTHOR OR CONTRIBUTORS BE LIABLE FOR ANY DIRECT, INDIRECT, INCIDENTAL, SPECIAL, EXEMPLARY, OR CONSEQUENTIAL DAMAGES (INCLUDING, BUT NOT LIMITED TO, PROCUREMENT OF SUBSTITUTE GOODS OR SERVICES; LOSS OF USE, DATA, OR PROFITS; OR BUSINESS INTERRUPTION) HOWEVER CAUSED AND ON ANY THEORY OF LIABILITY, WHETHER IN CONTRACT, STRICT LIABILITY, OR TORT (INCLUDING NEGLIGENCE OR OTHERWISE) ARISING IN ANY WAY OUT OF THE USE OF THIS SOFTWARE, EVEN IF ADVISED OF THE POSSIBILITY OF SUCH DAMAGE.

The licence and distribution terms for any publically available version or derivative of this code cannot be changed. i.e. this code cannot simply be copied and put under another distribution licence [including the GNU Public Licence.]

13.7. Boost Software License

Boost Software License - Version 1.0 - August 17th, 2003

Permission is hereby granted, free of charge, to any person or organization obtaining a copy of the software and accompanying documentation covered by this license (the "Software") to use, reproduce, display, distribute, execute, and transmit the Software, and to prepare derivative works of the Software, and to permit third-parties to whom the Software is furnished to do so, all subject to the following:

The copyright notices in the Software and this entire statement, including the above license grant, this restriction and the following disclaimer, must be included in all copies of the Software, in whole or in part, and all derivative works of the Software, unless such copies or derivative works are solely in the form of machine-executable object code generated by a source language processor.

THE SOFTWARE IS PROVIDED "AS IS", WITHOUT WARRANTY OF ANY KIND, EXPRESS OR IMPLIED, INCLUDING BUT NOT LIMITED TO THE WARRANTIES OF MERCHANTABILITY, FITNESS FOR A PARTICULAR PURPOSE, TITLE AND NON-INFRINGEMENT. IN NO EVENT SHALL THE COPYRIGHT HOLDERS OR ANYONE DISTRIBUTING THE SOFTWARE BE LIABLE FOR ANY DAMAGES OR OTHER LIABILITY, WHETHER IN CONTRACT, TORT OR OTHERWISE, ARISING FROM, OUT OF OR IN CONNECTION WITH THE SOFTWARE OR THE USE OR OTHER DEALINGS IN THE SOFTWARE.

13.8. Open Software Licence 3.0

Open Software License ("OSL") v. 3.0

This Open Software License (the "License") applies to any original work of authorship (the "Original Work") whose owner (the "Licensor") has placed the following licensing notice adjacent to the copyright notice for the Original Work:

Licensed under the Open Software License version 3.0

- 1) Grant of Copyright License. Licensor grants You a worldwide, royalty-free, non-exclusive, sublicensable license, for the duration of the copyright, to do the following:
 - a) to reproduce the Original Work in copies, either alone or as part of a collective work;
 - b) to translate, adapt, alter, transform, modify, or arrange the Original Work, thereby creating derivative works ("Derivative Works") based upon the Original Work;
 - c) to distribute or communicate copies of the Original Work and Derivative Works to the public, with the proviso that copies of Original Work or Derivative Works that You distribute or communicate shall be licensed under this Open Software License;
 - d) to perform the Original Work publicly; and
 - e) to display the Original Work publicly.
- 2) Grant of Patent License. Licensor grants You a worldwide, royalty-free, non-exclusive, sublicensable license, under patent claims owned or controlled by the Licensor that are embodied in the Original Work as furnished by the Licensor, for the duration of the patents, to make, use, sell, offer for sale, have made, and import the Original Work and Derivative Works.

- 3) **Grant of Source Code License.** The term "Source Code" means the preferred form of the Original Work for making modifications to it and all available documentation describing how to modify the Original Work. Licensor agrees to provide a machine-readable copy of the Source Code of the Original Work along with each copy of the Original Work that Licensor distributes. Licensor reserves the right to satisfy this obligation by placing a machine-readable copy of the Source Code in an information repository reasonably calculated to permit inexpensive and convenient access by You for as long as Licensor continues to distribute the Original Work.
- 4) **Exclusions From License Grant.** Neither the names of Licensor, nor the names of any contributors to the Original Work, nor any of their trademarks or service marks, may be used to endorse or promote products derived from this Original Work without express prior permission of the Licensor. Except as expressly stated herein, nothing in this License grants any license to Licensor's trademarks, copyrights, patents, trade secrets or any other intellectual property. No patent license is granted to make, use, sell, offer for sale, have made, or import embodiments of any patent claims other than the licensed claims defined in Section 2. No license is granted to the trademarks of Licensor even if such marks are included in the Original Work. Nothing in this License shall be interpreted to prohibit Licensor from licensing under terms different from this License any Original Work that Licensor otherwise would have a right to license.
- 5) **External Deployment.** The term "External Deployment" means the use, distribution, or communication of the Original Work or Derivative Works in any way such that the Original Work or Derivative Works may be used by anyone other than You, whether those works are distributed or communicated to those persons or made available as an application intended for use over a network. As an express condition for the grants of license hereunder, You must treat any External Deployment by You of the Original Work or a Derivative Work as a distribution under section 1(c).
- 6) **Attribution Rights.** You must retain, in the Source Code of any Derivative Works that You create, all copyright, patent, or trademark notices from the Source Code of the Original Work, as well as any notices of licensing and any descriptive text identified therein as an "Attribution Notice." You must cause the Source Code for any Derivative Works that You create to carry a prominent Attribution Notice reasonably calculated to inform recipients that You have modified the Original Work.
- 7) **Warranty of Provenance and Disclaimer of Warranty.** Licensor warrants that the copyright in and to the Original Work and the patent rights granted herein by Licensor are owned by the Licensor or are sublicensed to You under the terms of this License with the permission of the contributor(s) of those copyrights and patent rights. Except as expressly stated in the immediately preceding sentence, the Original Work is provided under this License on an "AS IS" BASIS and WITHOUT WARRANTY, either express or implied, including, without limitation, the warranties of non-infringement, merchantability or fitness for a particular purpose. THE ENTIRE RISK AS TO THE QUALITY OF THE ORIGINAL WORK IS WITH YOU. This DISCLAIMER OF WARRANTY constitutes an essential part of this License. No license to the Original Work is granted by this License except under this disclaimer.
- 8) **Limitation of Liability.** Under no circumstances and under no legal theory, whether in tort (including negligence), contract, or otherwise, shall the Licensor be liable to anyone for any indirect, special, incidental, or consequential damages of any character arising as a result of this License or the use of the Original Work including, without limitation, damages for loss of goodwill, work stoppage, computer failure or malfunction, or any and all other commercial damages or losses. This limitation of liability shall not apply to the extent applicable law prohibits such limitation.
- 9) **Acceptance and Termination.** If, at any time, You expressly assented to this License, that assent indicates your clear and irrevocable acceptance of this License and all of its terms and conditions. If You distribute or communicate copies of the Original Work or a Derivative Work, You must make a reasonable effort under the circumstances to obtain the express

assent of recipients to the terms of this License. This License conditions your rights to undertake the activities listed in Section 1, including your right to create Derivative Works based upon the Original Work, and doing so without honoring these terms and conditions is prohibited by copyright law and international treaty. Nothing in this License is intended to affect copyright exceptions and limitations (including "fair use" or "fair dealing"). This License shall terminate immediately and You may no longer exercise any of the rights granted to You by this License upon your failure to honor the conditions in Section 1(c).

- 10) Termination for Patent Action. This License shall terminate automatically and You may no longer exercise any of the rights granted to You by this License as of the date You commence an action, including a cross-claim or counterclaim, against Licensor or any licensee alleging that the Original Work infringes a patent. This termination provision shall not apply for an action alleging patent infringement by combinations of the Original Work with other software or hardware.
- 11) Jurisdiction, Venue and Governing Law. Any action or suit relating to this License may be brought only in the courts of a jurisdiction wherein the Licensor resides or in which Licensor conducts its primary business, and under the laws of that jurisdiction excluding its conflict-of-law provisions. The application of the United Nations Convention on Contracts for the International Sale of Goods is expressly excluded. Any use of the Original Work outside the scope of this License or after its termination shall be subject to the requirements and penalties of copyright or patent law in the appropriate jurisdiction. This section shall survive the termination of this License.
- 12) Attorneys' Fees. In any action to enforce the terms of this License or seeking damages relating thereto, the prevailing party shall be entitled to recover its costs and expenses, including, without limitation, reasonable attorneys' fees and costs incurred in connection with such action, including any appeal of such action. This section shall survive the termination of this License.
- 13) Miscellaneous. If any provision of this License is held to be unenforceable, such provision shall be reformed only to the extent necessary to make it enforceable.
- 14) Definition of "You" in This License. "You" throughout this License, whether in upper or lower case, means an individual or a legal entity exercising rights under, and complying with all of the terms of, this License. For legal entities, "You" includes any entity that controls, is controlled by, or is under common control with you. For purposes of this definition, "control" means (i) the power, direct or indirect, to cause the direction or management of such entity, whether by contract or otherwise, or (ii) ownership of fifty percent (50%) or more of the outstanding shares, or (iii) beneficial ownership of such entity.
- 15) Right to Use. You may use the Original Work in all ways not otherwise restricted or conditioned by this License or by law, and Licensor promises not to interfere with or be responsible for such uses by You.
- 16) Modification of This License. This License is Copyright (c) 2005 Lawrence Rosen. Permission is granted to copy, distribute, or communicate this License without modification. Nothing in this License permits You to modify this License as applied to the Original Work or to Derivative Works. However, You may modify the text of this License and copy, distribute or communicate your modified version (the "Modified License") and apply it to other original works of authorship subject to the following conditions: (i) You may not indicate in any way that your Modified License is the "Open Software License" or "OSL" and you may not use those names in the name of your Modified License; (ii) You must replace the notice specified in the first paragraph above with the notice "Licensed under <insert your license name here>" or with a notice of your own that is not confusingly similar to the notice in this License; and (iii) You may not claim that your original works are open source software unless your Modified License has been approved by Open Source Initiative (OSI) and You comply with its license review and certification process.

13.9. MIT License

Permission is hereby granted, free of charge, to any person obtaining a copy of this software and associated documentation files (the "Software"), to deal in the Software without restriction, including without limitation the rights to use, copy, modify, merge, publish, distribute, sublicense, and/or sell copies of the Software, and to permit persons to whom the Software is furnished to do so, subject to the following conditions:

The above copyright notice and this permission notice shall be included in all copies or substantial portions of the Software.

THE SOFTWARE IS PROVIDED "AS IS", WITHOUT WARRANTY OF ANY KIND, EXPRESS OR IMPLIED, INCLUDING BUT NOT LIMITED TO THE WARRANTIES OF MERCHANTABILITY, FITNESS FOR A PARTICULAR PURPOSE AND NONINFRINGEMENT. IN NO EVENT SHALL THE AUTHORS OR COPYRIGHT HOLDERS BE LIABLE FOR ANY CLAIM, DAMAGES OR OTHER LIABILITY, WHETHER IN AN ACTION OF CONTRACT, TORT OR OTHERWISE, ARISING FROM, OUT OF OR IN CONNECTION WITH THE SOFTWARE OR THE USE OR OTHER DEALINGS IN THE SOFTWARE.

13.10. SIL OPEN FONT LICENSE

 SIL OPEN FONT LICENSE Version 1.1 - 26 February 2007

PREAMBLE

The goals of the Open Font License (OFL) are to stimulate worldwide development of collaborative font projects, to support the font creation efforts of academic and linguistic communities, and to provide a free and open framework in which fonts may be shared and improved in partnership with others.

The OFL allows the licensed fonts to be used, studied, modified and redistributed freely as long as they are not sold by themselves. The fonts, including any derivative works, can be bundled, embedded, redistributed and/or sold with any software provided that any reserved names are not used by derivative works. The fonts and derivatives, however, cannot be released under any other type of license. The requirement for fonts to remain under this license does not apply to any document created using the fonts or their derivatives.

DEFINITIONS

"Font Software" refers to the set of files released by the Copyright Holder(s) under this license and clearly marked as such. This may include source files, build scripts and documentation.

"Reserved Font Name" refers to any names specified as such after the copyright statement(s).

"Original Version" refers to the collection of Font Software components as distributed by the Copyright Holder(s).

"Modified Version" refers to any derivative made by adding to, deleting, or substituting -- in part or in whole -- any of the components of the Original Version, by changing formats or by porting the Font Software to a new environment.

"Author" refers to any designer, engineer, programmer, technical writer or other person who contributed to the Font Software.

PERMISSION & CONDITIONS

Permission is hereby granted, free of charge, to any person obtaining a copy of the Font Software, to use, study, copy, merge, embed, modify, redistribute, and sell modified and unmodified copies of the Font Software, subject to the following conditions:

- 1) Neither the Font Software nor any of its individual components, in Original or Modified Versions, may be sold by itself.
- 2) Original or Modified Versions of the Font Software may be bundled, redistributed and/or sold with any software, provided that each copy contains the above copyright notice and this license. These can be included either as stand-alone text files, human-readable headers or in the appropriate machine-readable metadata fields within text or binary files as long as those fields can be easily viewed by the user.
- 3) No Modified Version of the Font Software may use the Reserved Font Name(s) unless explicit written permission is granted by the corresponding Copyright Holder. This restriction only applies to the primary font name as presented to the users.
- 4) The name(s) of the Copyright Holder(s) or the Author(s) of the Font Software shall not be used to promote, endorse or advertise any Modified Version, except to acknowledge the contribution(s) of the Copyright Holder(s) and the Author(s) or with their explicit written permission.
- 5) The Font Software, modified or unmodified, in part or in whole, must be distributed entirely under this license, and must not be distributed under any other license. The requirement for fonts to remain under this license does not apply to any document created using the Font Software.

TERMINATION

This license becomes null and void if any of the above conditions are not met.

DISCLAIMER

THE FONT SOFTWARE IS PROVIDED "AS IS", WITHOUT WARRANTY OF ANY KIND, EXPRESS OR IMPLIED, INCLUDING BUT NOT LIMITED TO ANY WARRANTIES OF MERCHANTABILITY, FITNESS FOR A PARTICULAR PURPOSE AND NONINFRINGEMENT OF COPYRIGHT, PATENT, TRADEMARK, OR OTHER RIGHT. IN NO EVENT SHALL THE COPYRIGHT HOLDER BE LIABLE FOR ANY CLAIM, DAMAGES OR OTHER LIABILITY, INCLUDING ANY GENERAL, SPECIAL, INDIRECT, INCIDENTAL, OR CONSEQUENTIAL DAMAGES, WHETHER IN AN ACTION OF CONTRACT, TORT OR OTHERWISE, ARISING FROM, OUT OF THE USE OR INABILITY TO USE THE FONT SOFTWARE OR FROM OTHER DEALINGS IN THE FONT SOFTWARE.

PATLITE Corporation G2J

PATLITE Corporation ※Head office	■ www.patlite.com/
PATLITE (U.S.A.) Corporation	■ www.patlite.com/
PATLITE Europe GmbH ※Germany	■ www.patlite.eu/
PATLITE (SINGAPORE) PTE LTD	■ www.patlite-ap.com/
PATLITE (CHINA) Corporation	■ www.patlite.cn/
PATLITE KOREA CO., LTD.	■ www.patlite.co.kr/
PATLITE TAIWAN CO., LTD.	■ www.patlite.tw/
PATLITE (THAILAND) CO., LTD.	■ www.patlite.co.th/
PATLITE MEXICO S.A. de C.V.	■ www.patlite.com.mx/