

Wiring example for Base unit

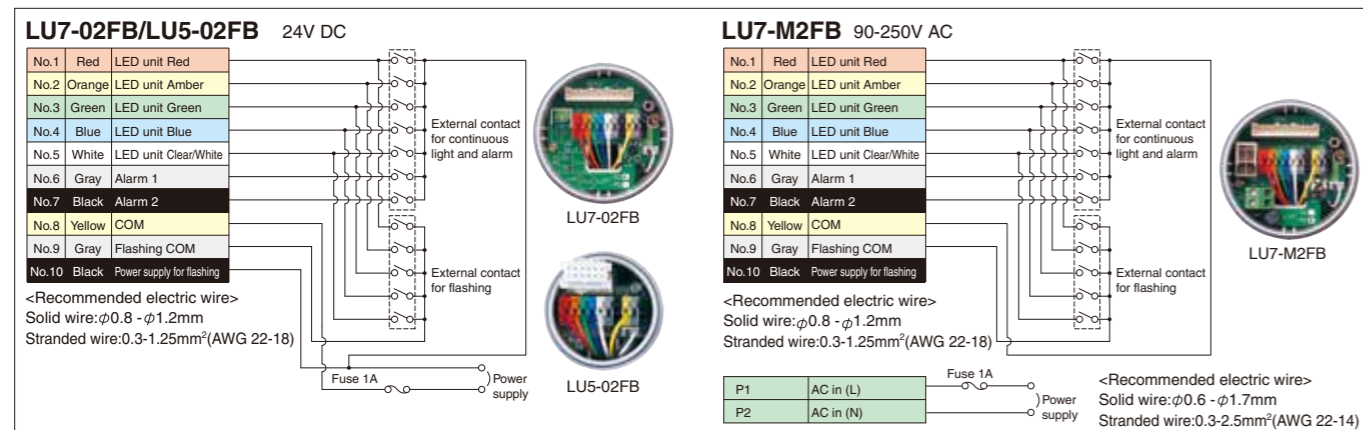

【External contact capacity】

Voltage specs		24V DC	90~250V AC
LED unit	Current consumption	Red · Amber : 52mA Green · Blue · Clear/White : 42mA	
[1-Light]	Contact capacity	$I_s \geq 100\text{mA}$, $V_s \geq 35\text{V AC}$	
Alarm	Current consumption	50mA	
	Inrush current	100mA	
	Contact capacity	$I_s \geq 100\text{mA}$, $V_s \geq 35\text{V AC}$	
Power supply	Current consumption	360mA	40mA (250V) ~ 110mA (90V)
	Contact capacity	$I_s \geq 500\text{mA}$ $V_s \geq 35\text{V AC}$	9A (90V) ~ 25A (250V) $V_s \geq 250\text{V AC}$

※ I_s : Current capacity V_s : Withstand voltage

【External contact fuse】

Voltage	Amperage rating of fuse
All model	250V 1A

※ Use a fuse conforming to the rated current of the machine on which you install product.
(Example: UL class J type fuse)

Dimensions

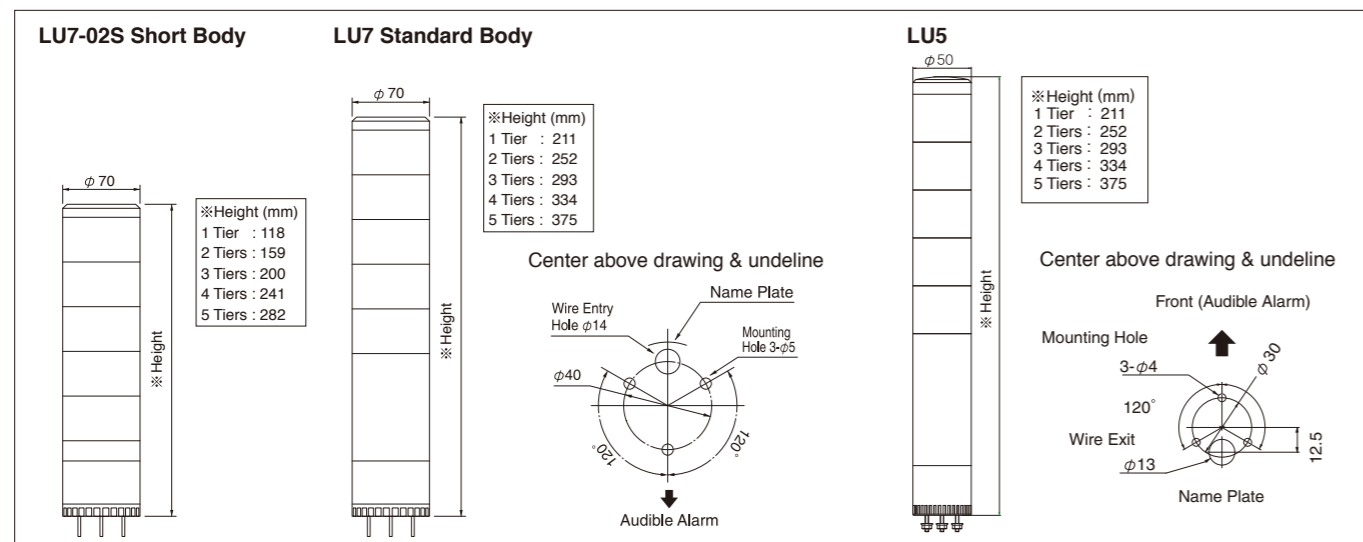

PATLITE Corporation

Inaba Building 4-11-14 Itachibori Nishi-ku Osaka 550-0012 Japan TEL.+81-6-7688-5400 FAX.+81-6-7688-5401

PATLITE (U.S.A.) Corporation
20130 S. Western Ave., Torrance, CA 90501, U.S.A. TEL.+1-310-328-3222 FAX.+1-310-328-2676

PATLITE Europe GmbH
Am Soeldnermoos 8, D-85399 Hallbergmoos, Germany TEL.+49-811-9981-9770-0 FAX.+49-811-9981-9770-9

PATLITE (SINGAPORE) PTE LTD
No.2 Leng Kee Road, #05-01 Thye Hong Centre, Singapore 159086 TEL.+65-6226-1111 FAX.+65-6324-1411

PATLITE (CHINA) Corporation
Post Code: 200072 Room 512, Jufeng Business Building, Lingshi Road, Shanghai City, China TEL.+86-21-66308969 FAX.+86-21-66308938

PATLITE KOREA CO., LTD.
A-2603, Daesung D-POLIS, 543-1 Gasan-dong, Geumcheon-gu, Seoul, 153-719 TEL.+82-2-523-6636 FAX.+82-2-861-9919

PATLITE TAIWAN CO., LTD.
7F, No. 91, Huayin St, Datong District Taipei, Taiwan R.O.C TEL.+886-2-2555-1611 FAX.+886-2-2555-1621



ISO14001:2004 Certified
Headquarters/Sanda Plant/Techno Center

CAUTION To ensure correct use of these products, read the Instruction Manual prior to use. Failure to follow all safeguards can result in fire, electric shock, or other accidents. Specifications are subject to change without notice.

<http://www.patlite.com> E-mail: overseas@patlite.co.jp



For the benefit of mankind and the earth, Patlite is committed to developing environmentally friendly products.



1211A 0809J(J)/J(TS)A

PATLITE®

New Frontiers for Safety, Security and Comfort.

Modular LED Signal Tower LU5/LU7 Series



LU5 series
50mm dia.

LU7 series
70mm dia.

PATLITE Corporation

www.patlite.com

PATLITE's LU5 & LU7 Series signal towers deliver the advantages of superior LED technology, innovative design, and the convenience of modular assembly with only 9 basic modular components to meet just about every indicating need.

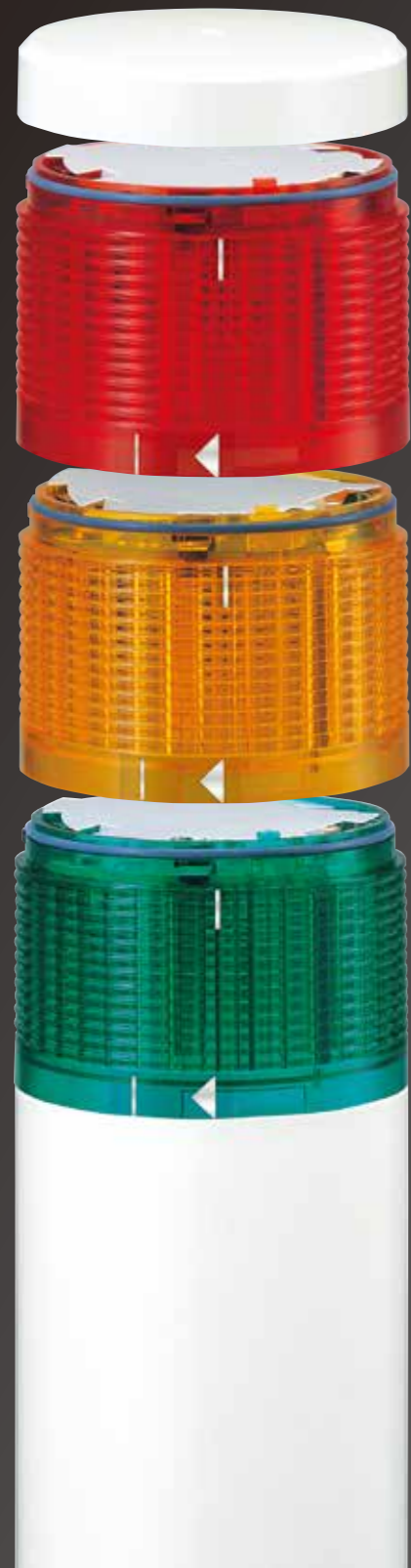

Ultra Bright LEDs combined with an Innovative Prism Lens Design

Allows the light emitted from the signal tower to be seen from greater distances. This also allows for use of a smaller diameter light, reducing the cost of the light tower.



Color-coordinated & Spring-loaded Terminal Block

Makes wiring easy and more reliable compared to screw-type connections. Each color corresponds to the color of the LED module to be used.

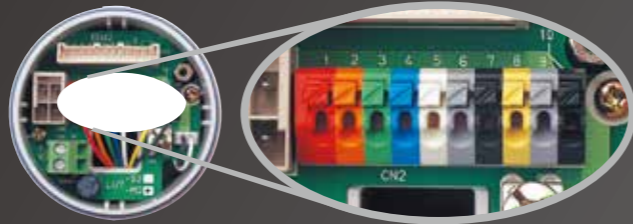

Wiring Terminals

Two user-selectable Alarms Integrated in the Base Module

Allows sound to enhance the critical nature of a visual signal, bringing more attention to certain conditions. Also, since the modules are built into the base, up to 5 LED modules can be used on the light tower.



Delivers Sounds up to 90dB at 1 m.

Alarm can be easily heard over ambient noise.

Modular Design

Makes it easy to configure and assemble a light tower. Modules can be put away before shipping the machine, reducing shipping and crate costs.



Modular Construction

O-rings

Seal out liquids so that the tower achieves an IP65 rating allowing the tower to be used in wet conditions.



IP65 Protection

IP65 & IP66 with Optional Cable Gland

The O-rings seal the tower from liquids so that an IP65 rating can be achieved to allow the tower to be used in wet environments. Adding a Cable Gland (user supplied) the tower's IP rating is increased to IP66.



LU7 Series 70mm diameter
Modular LED Signal Tower



USB Base Module

USB powered Base Unit with Integrated Alarms (LU7-02S-USB)

- Power over USB - no power supply needed
- DLL Operable
- Supports a maximum of five tiers where three tiers can be lighted simultaneously
- Complies with CE/RoHS/FCC/KC Standards
- IP65 Protection rating
- Adjustable Alarm Frequency
- 2 levels of adjustable alarm sound
- Sound pressure is a maximum of 80dB
- Control Program downloadable from PATLITE website
- Four kind of flashing patterns
- 13 variations of alarm frequency and 5 patterns of alarm sound
- Strip to secure USB cable included
- Supported OS: Windows 7, Windows 8

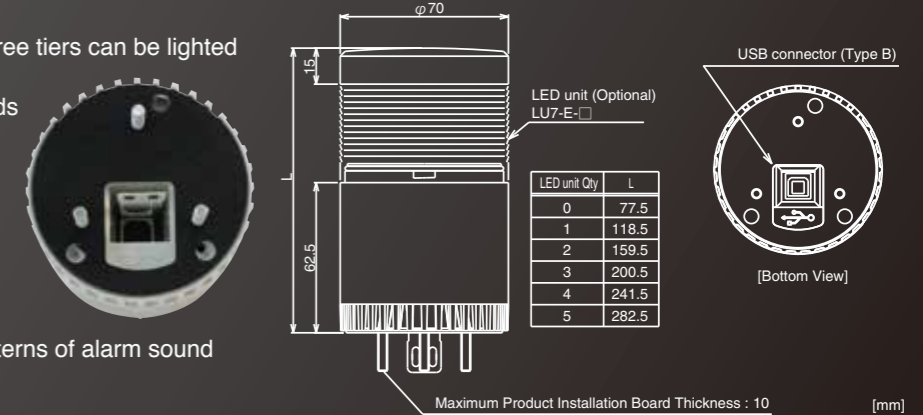

NEW

Omni-directional Sound Module

Loud, multi-sound Module (LU7-LB)

- Loud sound pressure up to 100dB (±5dB)
- Four kinds of alarm sounds can be selected with a DIP switch for a wider alarm sound range
- IP40 Protection rating
- Complies with CE/RoHS/FCC Standards
- Can be used with LU7-02(FB), LU7-M2(FB), and LU7-02SB
- Alarm can be set to sound with a specific LED module for simultaneous control

4 Alarm sound Patterns

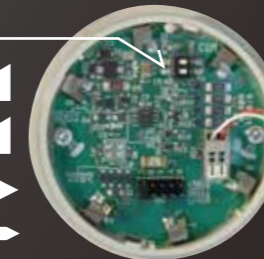
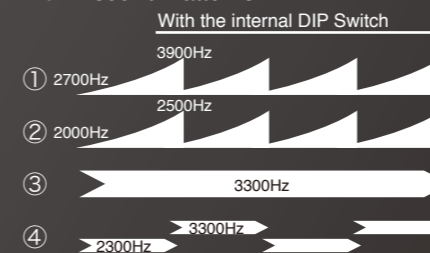

NEW

Stackable audible alarm

- Can be used with LU7-02(FB), LU7-M2(FB), and LU7-02S(B).
- Easily mounted at the top of the light stack.

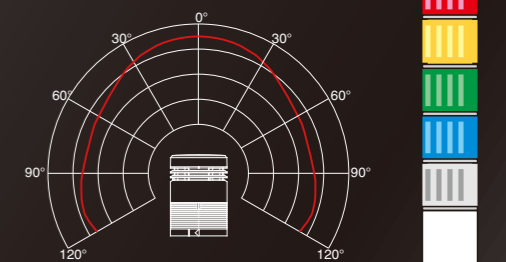

Diagram 1. Sound Direction



Head cover is supplied with the base unit.

Omni-directional MP3 Smart Alert Module (LU7-V1)

- Volume adjustable from 9dB to 80dB at 1m (depends on type of sound or message)
- High quality MP3 supported voice and sound module replays up to 4 alarms or messages with 32 seconds of total program time
- Playback sound selected by the position of internal jumper pin
- MP3 data is recorded before shipment of order
- CE compliant

Selectable playback sound

- The jumper position determines the sound

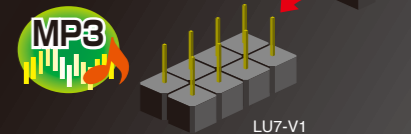

LU7-V1

Model	Type	Rated Voltage	Rated Current Consumption	Power Consumption	Mass
LU7-LB	Alarm Sound	24V DC	150mA	-	140g
LU7-V1	MP3 Smart Alert	24V DC	-	3.5W	170g

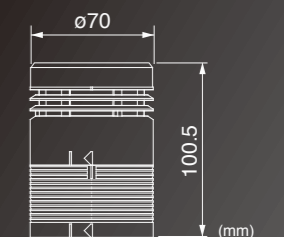

LU7 Series

70mm diameter

Modular LED Signal Tower



US LISTED

IP65 Environment Protection

Voice and Sound Module

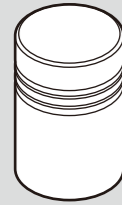

Model	NEW LU7-LB	NEW LU7-V1
Type	Alarm Sound	MP3 Smart Alert
Rated Voltage	DC 24V	DC 24V
Rated Current Consumption	150mA	-
Power Consumption	-	3.5W
Mass (±10%)	140g	170g

LED Units

Model	LU7-E-R	LU7-E-Y	LU7-E-G	LU7-E-B	LU7-E-C
Unit Color	Red	Yellow	Green	Blue	White
Rated Voltage	DC 24V				
Operating Voltage Range	DC 21.6 ~ 26.4V				
Current/Power Consumption	52mA/1.25W		42mA/1.0W		
Operating Temperature Range	-30°C ~ +60°C				
Mass (±10%)	60g				

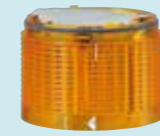

LED Strobe Module

Model	LU7-XE-R	LU7-XE-Y	LU7-XE-G	LU7-XE-B	LU7-XE-C
Unit Color	Red	Yellow	Green	Blue	White
Rated Voltage	DC 24V				
Power Consumption	290mA	290mA	140mA	270mA	280mA
Mass (±10%)	70g				

BASE Units

Model	LU7-02S	LU7-02	NEW LU7-02SB	NEW LU7-02FB	LU7-02S-USB	LU7-M2	LU7-M2FB
Color	White	White	White	White	White	Black	Black
Standard Body/Short Body	Short	Standard	Short	Standard	Short	Standard	Standard
Rated Voltage	DC 24V				DC 5V (USB bus power)	AC 100~240V (50/60Hz)	
Operating Voltage Range	DC 21.6 ~ 26.4V				DC 4.75 ~ 5.25V※	AC 90~250V (50/60Hz)	
Alarm	-	-	*Alarm 1	*Alarm 2	5 Patterns	-	*Alarm 1
Current Consumption	-	-	50±10mA	24±10mA	Max 500mA	-	50±10mA
Power Consumption	-	-	1.2±0.25W	0.58±0.25W	-	-	1.8±0.25W : 1.3±0.25W
Sound Level	-	-	Max:90±5dB (at 1m)		80±5dB (at 1m)	-	Max:90±5dB (at 1m)
Flashing Cycle	-	-	60±12 flashes per minute		-	-	60±12 flashes per minute
Operating Temperature Range	-30°C ~ +60°C				-20°C ~ +60°C	-25°C ~ +55°C	
Mounting Direction	Upright, Indoor only				Upright, Indoor only	Upright, Indoor only	
Protection Rating	IP65 (IP66 with Cable Gland supplied by user) ※Excludes LU7-USB						
Mass (±10%)	150g	250g	250g	280g	160g	310g	340g
Open Collector Type	PNP/NPN					NPN	

※ Based on USB 2.0 Standard

Pre-assembled

SZ-22Q+O0103

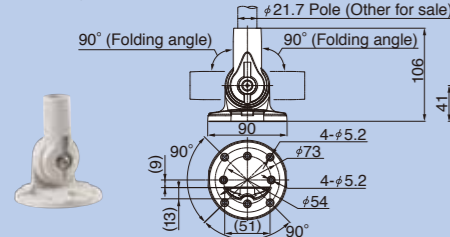

SZ-50T

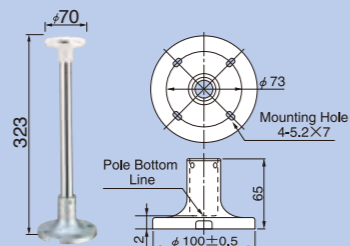

SZ-50L

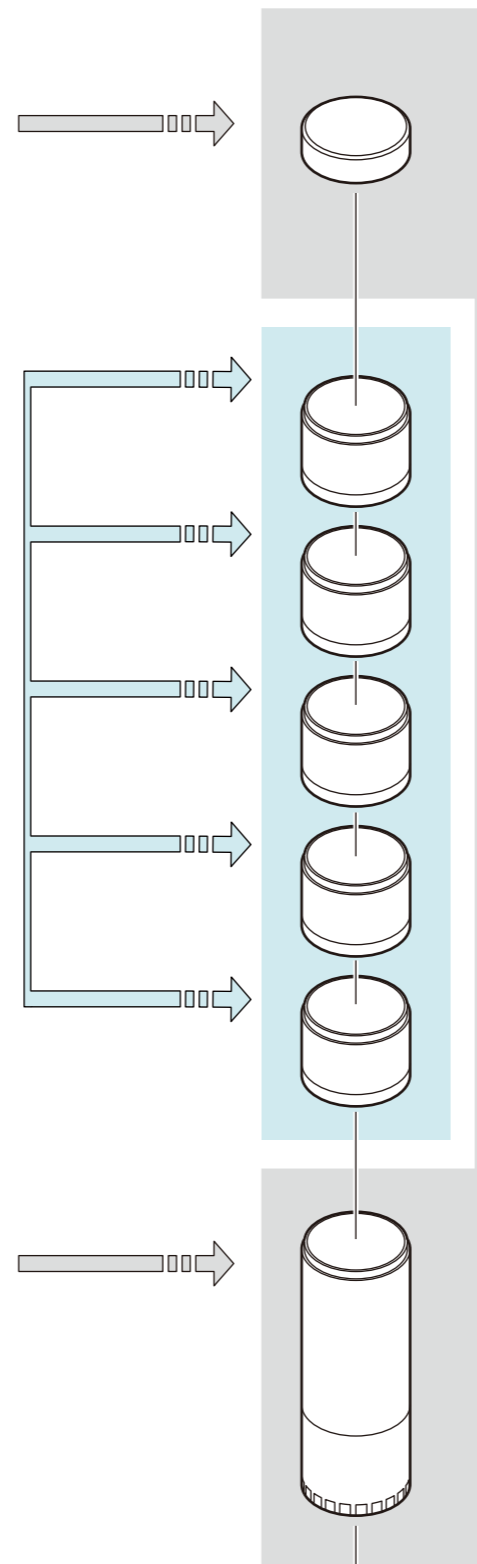
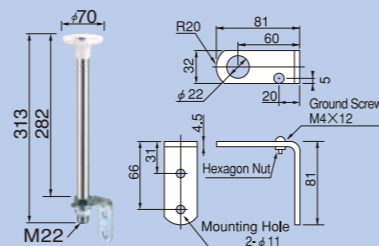

Optional Parts

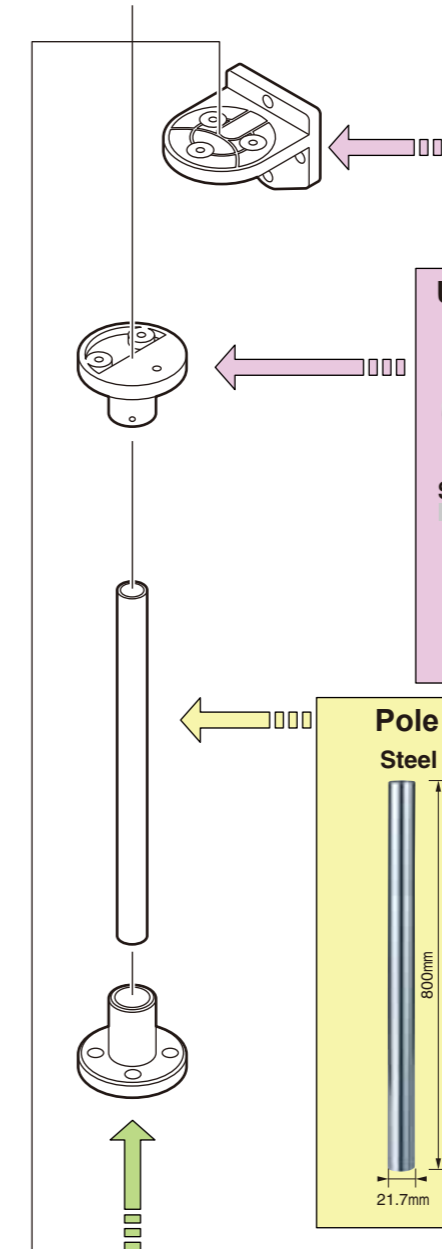

Wall Mount Bracket

SZ-018U Silver Color
SZ-018 Ivory White
SZ-018K Black

Upper Bracket (For φ21.7mm Pole)

SZ-50-U Ivory White
SZ-50-U-U Silver Color
SZ-50K-U Black
SZ-50NPT (For 1/2" NPT Pole)

Pole

Steel Pole
800mm : POLE-800S21
300mm : POLE-300S21
100mm : POLE-100S21

Aluminum Pole
800mm : POLE-800A21
800mm : POLE-800A21K
300mm : POLE-300A21
300mm : POLE-300A21K
100mm : POLE-100A21
100mm : POLE-100A21K

Mounting Bracket

SZ-016A
SZ-016KA+FO030 (For φ21.7mm Pole)
SZ-70-B (For φ21.7mm Aluminum Pole Only)
SZ-020 (For φ21.7mm Pole)
SZ-017 (For φ21.7mm Pole)

Wall Mount Bracket

Optional Parts

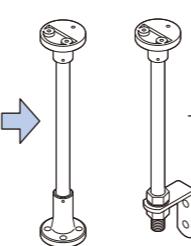

LU5 Series

50mm diameter

Modular LED Signal Tower

LED Units

Model	LU5-E-R	LU5-E-Y	LU5-E-G	LU5-E-B	LU5-E-C
Unit Color					
Rated Voltage	DC 24V				
Operating Voltage Range	DC 21.6 ~ 26.4V				
Current/Power Consumption	52mA/1.25W		42mA/1.0W		
Operating Temperature Range	-30°C ~ +60°C				
Mass (±10%)	44g				

RED AMBER GREEN BLUE CLEAR/WHITE



LU5-E-R
LED unit RED



LU5-E-Y
LED unit AMBER



LU5-E-G
LED unit GREEN



LU5-E-B
LED unit BLUE



LU5-E-C
LED unit CLEAR/WHITE

BASE Units

Model	LU5-02	LU5-02FB
Color		
Body Style	Standard	
Rated Voltage	DC 24V	
Operating Voltage Range	DC 21.6 ~ 26.4V	
Alarm		*Alarm 1 **Alarm 2
Current Consumption		50±10mA 24±10mA
Power Consumption		1.2±0.25W 0.58±0.25W
Sound Level	Max: 85±5dB (at 1m)	
Flashing Cycle	60±12 flashes per minutes	
Operating Temperature Range	-30°C ~ +60°C	
Mounting Direction	Upright, indoor only	
Protection Rating	IP65	
Mass (±10%)	182g	200g
Open Collector	PNP/NPN	

* Alarm 1 : Continuous Sound **Alarm 2 : Intermittent Sound

Unit Color Variation

Ivory White Silver Black



LU5-02
LU5-02FB



LU5-02U
LU5-02UFB



LU5-02+FB200
LU5-02FB+FB200

Pre-assembled

SZ-22Q+O0103

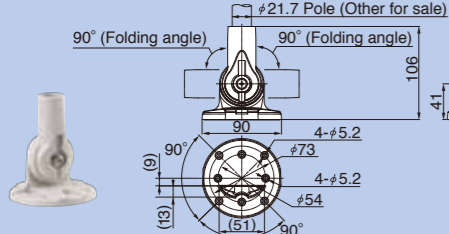

SZ-60T

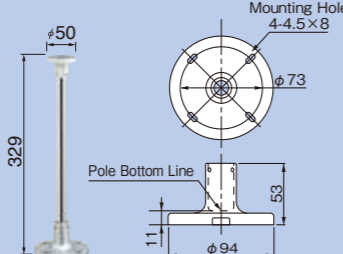

SZ-60L

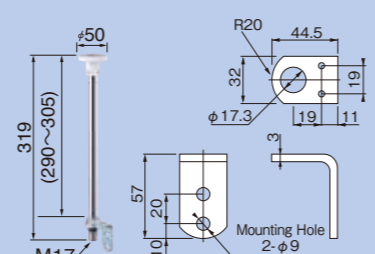

US LISTED **IP65 Environment Protection**

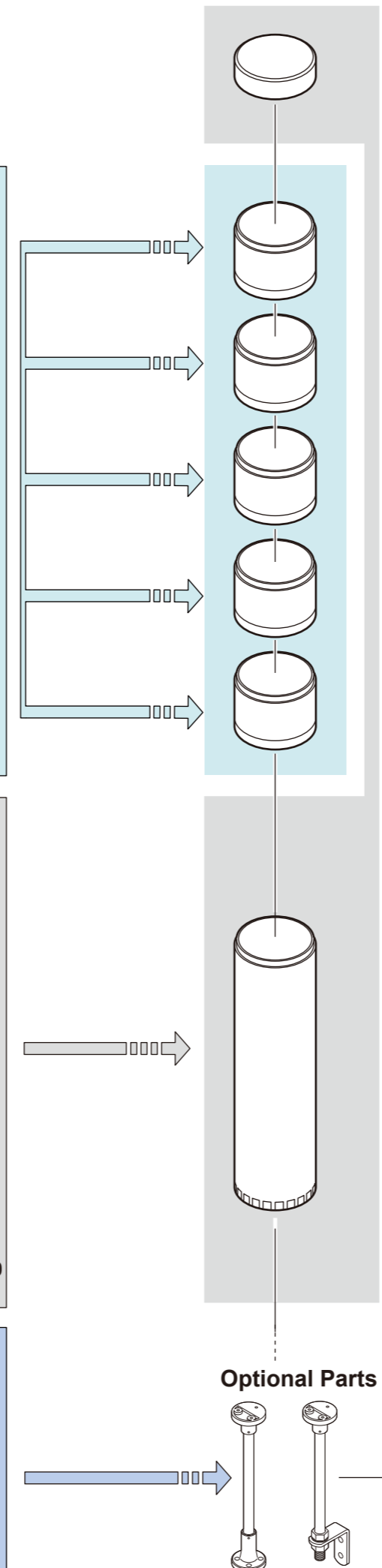

Optional Parts

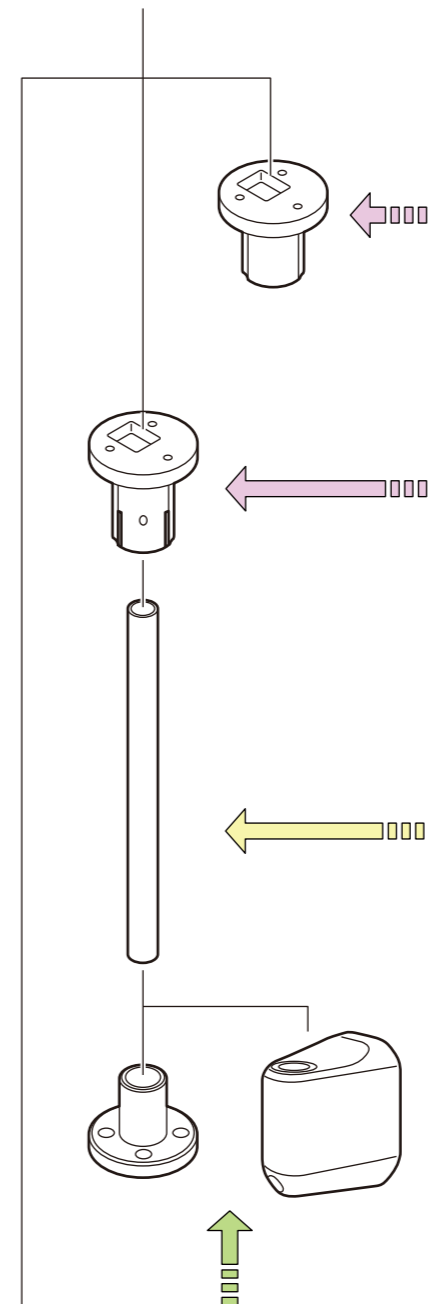

Upper Bracket

SZ-60-U (For φ21.7mm Pole)

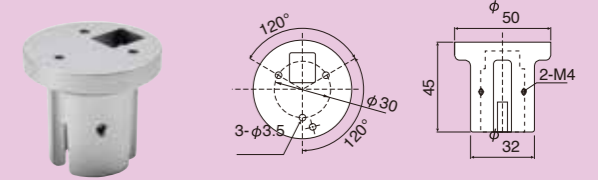

Upper Bracket

SZ-60NPT (For 1/2" NPT Pole)

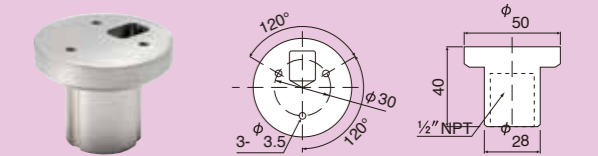

Pole

Steel Pole

Aluminum Pole

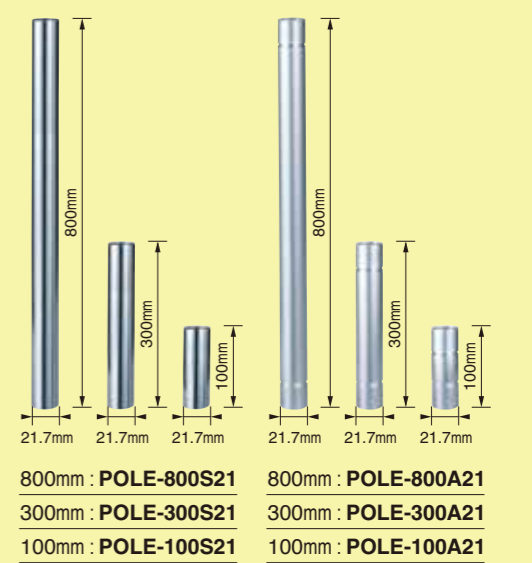

Mounting Bracket

SZ-016A (For φ21.7mm Pole)



SZ-70-B (For φ21.7mm Aluminum Pole Only)



Wall Mount Bracket

SZ-020 (For φ21.7mm Pole)



SZ-017 (For φ21.7mm Pole)

