

PATLITE[®]

Horn Type Annunciator

Complete Operation Manual

[TYPE : EHV/EHS]

PATLITE Corporation

Table of Contents

INTRODUCTION	EHV EHS	6
1.1.	REGARDING SYMBOLS USED IN THIS BOOK EHV EHS	6
1.2.	CAUTION ON COPYRIGHT EHV EHS	7
1.2.1.	CAUTIONARY NOTE WHEN REWRITING MP3 DATA EHV	7
1.2.2.	CAUTIONARY NOTE OF THE BUILT-IN ALARM/MELODY EHS	7
2. PRODUCT SUMMARY	EHV EHS	8
3. SAFETY PRECAUTIONS	EHV EHS	9
3.1.	FOR SAFE APPLICATION, OBSERVE THE FOLLOWING: EHV EHS	9
4. MODEL NUMBER CONFIGURATION	EHV EHS	11
5. PART NAME, FUNCTION AND OUTSIDE APPEARANCE	EHV EHS	12
5.1.	OUTSIDE APPEARANCE EHV EHS	12
5.2.	INSIDE APPEARANCE EHV EHS	13
5.3.	MODE SWITCH EHV EHS	15
5.3.1.	FEATURES COMMON TO BOTH MODELS EHV EHS	15
5.3.2.	EHV TYPE EHV	16
5.3.3.	EHSTYPE EHS	17
6. INSTALLATION	EHV EHS	18
6.1.	COVER REMOVAL EHV EHS	20
7. WIRING	EHV EHS	21
8. CONTROLLING THE VOLUME	EHV EHS	25
8.1.	VOLUME ADJUSTMENT EHV EHS	25
8.2.	SOUND REDUCTION FUNCTION EHV EHS	26
8.2.1.	WITH FORCED PLAYBACK OFF EHV EHS	26

8.2.2.	FORCED PLAYBACK ON MODE	EHV EHS	28
--------	-------------------------	---------	----

9. VARIOUS FUNCTIONS EHV EHS **29**

9.1.	FACTORY SETTINGS	EHV EHS	29
9.1.1.	MODE SWITCH	EHV EHS	29
9.1.2.	ASSIGNING CHANNEL FUNCTIONS	EHV	29
9.2.	SOUND GROUP	EHV EHS	30
9.3.	CHANNEL INPUT METHOD	EHV EHS	31
9.4.	PLAYBACK MODE	EHV	32
9.5.	SOUND MODE	EHV EHS	33
9.6.	MP3 SETUP	EHV	34
9.7.	FORCED PLAYBACK	EHV EHS	35
9.8.	ASSIGNING CHANNEL FUNCTIONS	EHV	36
9.8.1.	PLAYBACK	EHV	38
9.8.2.	SOUND REDUCTION	EHV	38
9.8.3.	STOP	EHV	38
9.8.4.	CLEAR	EHV	38

10. DATA REWRITING EHV **39**

10.1.	NECESSARY ITEMS	EHV	39
10.2.	DATA CREATION	EHV	40
10.2.1.	WHEN USING PATLITE PLAYLIST EDITOR 2	EHV	40
10.2.2.	WHEN NOT USING PATLITE PLAYLIST EDITOR 2	EHV	41
10.2.3.	CONVERTING A PLAYLIST (SLP FILE)	EHV	41
10.3.	DATA ARRANGEMENT	EHV	42
10.4.	DATA REWRITING PROCESS	EHV	43

11. SOUND COMBINATION METHOD EHS **44**

11.1.	NECESSARY ITEMS	EHS	44
11.2.	DATA CREATION	EHS	45

12. PLEASE ENTER AND SAVE THE SOUND NUMBER (REFER TO PAGE 73 "1 **47**

12.1.	DATA REWRITING PROCESS	EHS	48
-------	------------------------	-----	----

13. TIME CHART	EHV EHS	49
13.1.	SIGNAL LINE CHANNEL INPUT TIME CHART EHV EHS	50
13.2.	POWER SUPPLY START-UP TIME CHART EHV EHS	50
13.3.	CHANNEL INPUT MODE TIME CHART EHV EHS	51
13.3.1.	BIT INPUT TIME CHART EHV EHS	51
13.3.2.	BINARY INPUT TIME CHART EHV EHS	51
13.4.	TIME CHART FOR DIFFERENT PLAYBACK MODES EHV	52
13.4.1.	NORMAL PLAYBACK TIME CHART EHV	52
13.4.2.	INPUT PRIORITY PLAYBACK TIME CHART EHV	53
13.4.3.	HOLD PLAYBACK TIME CHART EHV	54
13.4.4.	MEMORY PLAYBACK TIME CHART EHV	55
13.5.	CHANNEL FUNCTION TIME CHART EHV	56
13.5.1.	PLAYBACK FUNCTION TIME CHART EHV	56
13.5.2.	SOUND REDUCTION FUNCTION TIME CHART EHV	56
13.5.3.	STOP FUNCTION TIME CHART EHV	57
13.5.4.	CLEAR FUNCTION TIME CHART EHV	58
13.6.	SOUND REDUCTION TIME CHART EHV EHS	59
13.6.1.	FORCED PLAYBACK OFF MODE EHS	59
13.6.2.	FORCED PLAYBACK ON MODE EHV EHS	60
14. ERROR ALARM	EHV EHS	61
15. BINARY CONVERSION TABLE	EHV EHS	62
16. OPTIONAL PARTS	EHV EHS	64
17. REPLACEMENT PARTS	EHV EHS	65
18. BEFORE REQUESTING REPAIR	EHV EHS	66

19. SPECIFICATIONS EHV EHS **68**

19.1.	COMMON SPECIFICATIONS	EHV EHS	68
19.2.	SPECIFIC MODEL SPECIFICATIONS	EHV EHS	68
19.3.	SIGNAL INPUT SPECIFICATION	EHV EHS	70
19.4.	MP3 SPECIFICATIONS	EHV	71
19.5.	OUTSIDE DIMENSIONS	EHV EHS	71

20. SOUND LIST EHV EHS **72**

20.1.	TYPE A	EHS	72
20.2.	TYPE C	EHS	72
20.3.	TYPE D	EHS	73
20.4.	TYPE E	EHS	73
20.5.	TYPE F	EHV	74
20.6.	TYPE G	EHV	75

1. Introduction EHV EHS

Thank you for purchasing Patlite's horn type annunciator. Please read this comprehensive operation manual thoroughly before use. In addition, please store this manual for future reference when performing maintenance, repairs or inspections. When performing maintenance and repairs, etc., please be sure to reread this book. If there are any questions concerning this product, please refer to the information on the last page to ask your nearest PATLITE Sales Representative.

1.1.Regarding Symbols used in this book EHV EHS

- This book is an operation manual which covers the EHV model for playback of alarm/melody sounds with MP3 data; and the EHS model which can only play back an alarm sound. This book covers operation functions which are common to both models, as well as their specific functions. For simplicity, an icon is displayed in this book for each model to distinguish when giving explanation about the EHV model or the EHS model.
- The standard playback notation (EHV) for MP3 data is at a continuous bit rate of 64 kbits per second. Playback time will vary if the bit rates are different, or two or more different MP3 data is played back.
- SDV-2GP or SDV-128P is the recommended option for an SD Card. Using other SD cards is not guaranteed for proper operation.
- When formatting the SD card, use FAT16 or FAT32. The product will not recognize the SD card if formatted in anything other than indicated above.
- Terms used in this book

Terminology	Models Affected		Description
	EHV	EHS	
"Message No."	○	○	If an MP3 message does not play back, the mentioned tone number and message No. correspond to a Sound table by a 1 to 1 ratio.
	○	X	A maximum of 16 MP3 data collections based on the playlist created by the PATLITE Playlist Editor 2 is expressed as each channel input corresponding to each message No. by a 1 to 1 ratio. For details, please refer to the PATLITE Playlist Editor 2 help.
"PATLITE Playlist Editor 2"	○	X	PATLITE Playlist Editor 2 is an application for Windows ^R which assigns a combination of functions with MP3 data for alarm and melody sounds to be assigned to the channel signal lines. Please refer to page 64 "B) Voice Rewriting Tool (Free Version) " for details.
"Playlist Package"	○	X	It is a compilation of data saved with a combination of MP3 data, alarms, melodies and the functions assigned to their channel signal lines. It is created with the PATLITE Playlist Editor 2. It is used in case of MP3 data rewriting. Data Rewriting EHV Please refer to page 39 "10Data Rewriting EHV " for details.

- Windows^R is a registered trademark of the U.S. Microsoft Corporation in the U.S. and other countries.
- MPEG Layer-3 audio coding technology licensed from Fraunhofer IIS and Thomson Licensing.
- PATLITE Incorporated is a member of the SD Card Association.

1.2. Caution on Copyright EHV EHS

1.2.1. Cautionary note when rewriting MP3 data EHV

Work that was recorded or copied from music CDs or other media used in public places may infringe upon copyrights and law enforcement may be imposed. When using a work that was recorded or copied from music CDs or other media, be sure to obtain permission from the author.

In addition, copyright of audio/music data distributed or sold by the PATLITE Corporation belongs to PATLITE. It is strictly prohibited to copy/reprint whole or partial contents of audio/music data belonging to PATLITE Corporation, or to transfer/sell such material on computer networks etc., without permission of the rightful holder.

1.2.2. Cautionary note of the built-in Alarm/Melody EHS

Although copyright licensing in Japan for the A, C, D type melodies have been obtained for the EHS-□□□ and EHV-□□□ (F type) at our company, since copyright licensing for other countries outside Japan has not been acquired, it is recommended the customer acquires it.

However, the melodies in the EHS-□□E (E type) and EHV-□□G□ (G type) do not require copyright consent, therefore it is the recommended Sound to use in countries other than Japan.

2. Product Summary EHV EHS

This product is a horn type MP3 playback (EHV) / electronic sound (EHS) annunciator. The built-in alarm melody sound is reproduced by implementing a maximum of 4 chords which improves sound quality in comparison with conventional products. Since the MP3 protocol (EHV) is used as compressed data, it is possible to reproduce a high-quality sound voice message in comparison to ADPCM, by using the MPEG1-Audio Layer III (MP3). In addition, the MP3 data registry can be rewritten freely.

● **Loud Sound**

EHV EHS

A maximum of 105 dB (1m distance from the front and a 1 kHz at -6dB sinusoidal wave played back) for MP3 data ; and maximum of 110 dB (1m distance from the front and a specific alarm played back) for alarm and melody can be generated at the time of playback.

● **High-quality sound playback**

EHV EHS

The alarm melody is reproduced with an implementation of 4 chords for a richer sound.

EHV

The MP3 data can be registered into the onboard memory of the Main Unit for a total of 220 seconds.

(Bit rate 64kbit/s from one continuous MP3 data file)

● **MP3 data rewriting function**

EHV

An SD card can be used to freely rewrite MP3 data.

● **Playback corresponding to various applications**

EHV EHS

The input can be selected between "Binary Input" and "Bit Input".

The sound reduction can be controlled from a signal input and reduced with a designated sound reduction value.

EHV

Four kind of playback modes can be combined with playback messages for different kinds of applications.



EHS

The SD card can be used for freely combining customized Sounds.

3. Safety Precautions EHV EHS

In order to prevent any damage to the user and other personnel or to assets, note the following:

- The following symbols classifies the following precautions into two categories and explains the level of harm inflicted when caution is disregarded while using this product.

 Warning	Indicates an immediately dangerous condition: failure to follow the instructions may lead to death or serious injury.
 Caution	Indicates a potentially dangerous condition: failure to follow the instructions may lead to slight injury or property damage.

3.1. For safe application, observe the following: EHV EHS

Warning

- Prior to attaching wiring and the product, the power supply should be turned off at any cost. More important, perform proper insulation of the cable connection when using for outdoor applications. Failure to comply may result in electric shock.
- Be sure the wiring is correct. If an error is made in wiring, the internal circuit will be damaged and may cause a fire.
- Be sure the power source is in the voltage tolerance when using it. Failure to comply may result in malfunction or fire.
- Do not modify or disassemble the product. Possibility of fire or electric shock may occur. Refer to page 66 "Before Requesting Repair EHV EHS" section, or ask for technical consultation from the addresses indicated in this manual for repair, etc. of this product.
- Be sure to request the installation and wiring be performed by a professional contractor. There is a risk of an electric shock, fire, or falling.

Caution

- Be sure to attach the cover in its proper position with the appointed torque value. Failure to comply may result in water and dust entering and causing damage. (Recommended Torque: 0.7 N-m)
- Do not install this product in a location where vibrations exceed the specifications. Failure to comply may result in the prevention of the product detaching and falling, causing injury to a passer-by, etc.

Contrary to Warnings and Cautions indicated in this document, product failure due to mishandling, disassembly, modifications or natural disasters, etc. is not covered by any Warranty. Moreover, avoid any applications outside those indicated in this document.

Please	Indicates something to observe before using this product. The disregard to this indication may lead to product malfunction or failure.
Note	Indicates a notice regarding supplementary information or convenient explanation of this product.

Please

- Connect an external fuse for protection of the internal circuit of the Main Unit and the power supply circuitry.
- Do not use in an environment exposed to strong radio waves or inductance noise. Failure to comply may result in noise interference coming out from the product.
- Do not use in an environment where corrosive gas is present. Possible cause of failure may occur.
- Discharge any static electricity from the body before handling static sensitive parts, such as the SD Card. To prevent damage from static electricity, touch hands or other body parts to metals or an earth ground to discharge the body from static charge.
- Attach all parts with the recommended torque values.
- Do not lose parts and beware of replacing the cover, waterproofing gland, etc. when performing work.
- When this product is used for security purposes, it should be inspected daily and it is recommended this product should be used together with other security products in case a malfunction should occur.

Note

- This operation manual should be stored in a safe location and it is recommended to be periodically read before maintenance is performed.

4. Model Number Configuration EHV EHS

● EHV Type

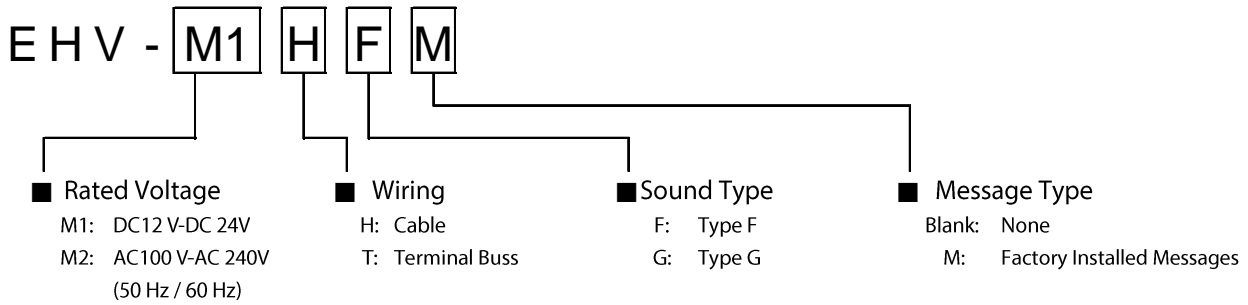

● EHS Type

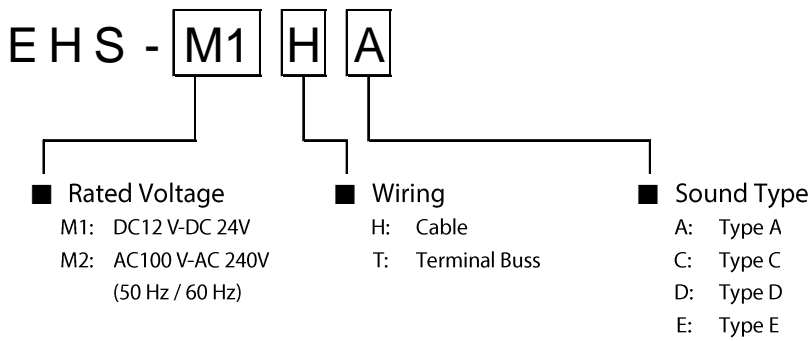

5. Part Name, Function and Outside Appearance EHV EHS

5.1. Outside Appearance EHV EHS

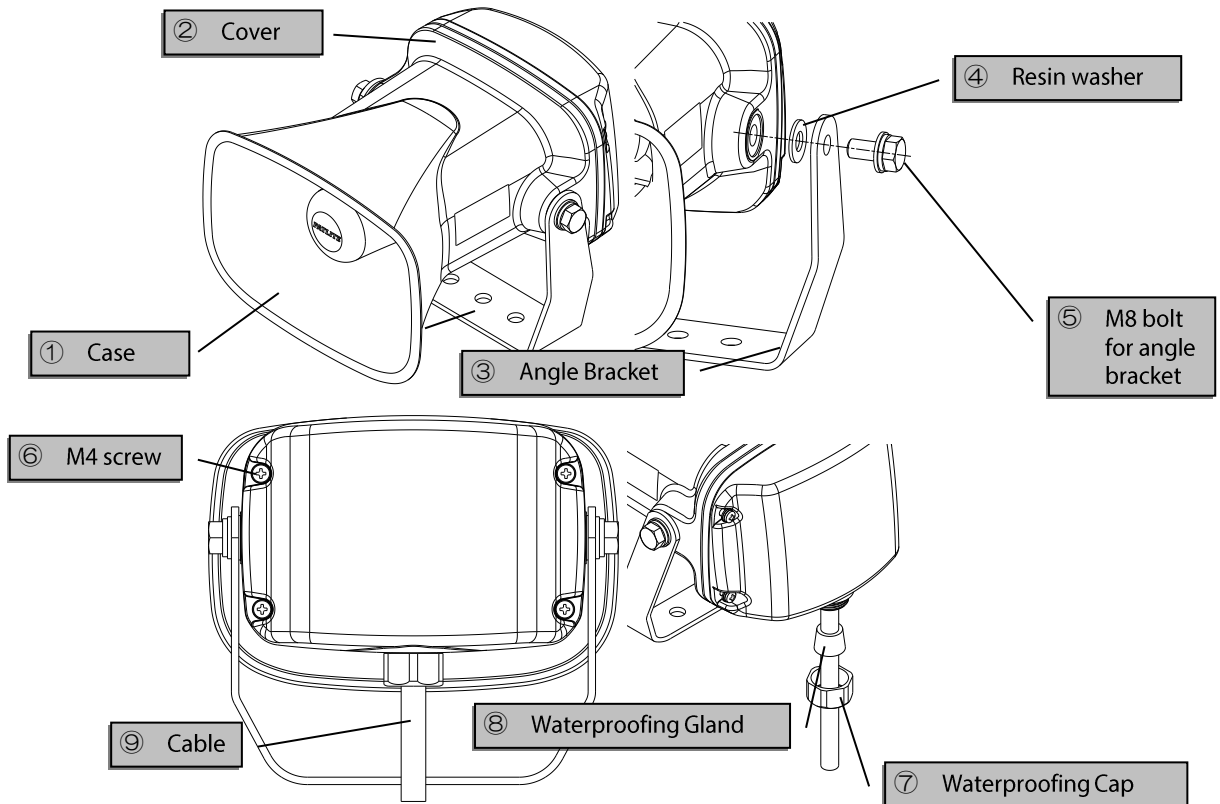

Case

Sound is reproduced from a horn from the frontal direction.

Cover

Inside the cover contains the volume, Mode Switch, and SD card slot.

Angle Bracket

The Angle Bracket is used when installing the product.

Resin washer

The resin washer is inserted so the angle bracket can rotate smoothly.

M8 bolt for angle bracket

The M8 bolts are used to set the up-and-down angle of the product. It is loosely tightened at the time of factory shipment.

M4 screw

The M4 screws are included with the cover.

Waterproofing Cap

The waterproofing gland prevents water intrusion inside the main unit.

Waterproofing Gland

The waterproofing rubber helps prevent water intrusion when the waterproofing gland is used.

Cable

The cable is used for wiring. It is used when the product is ordered with a cable.

5.2. Inside Appearance EHV EHS

● EH□-□H□ (Cable Type)

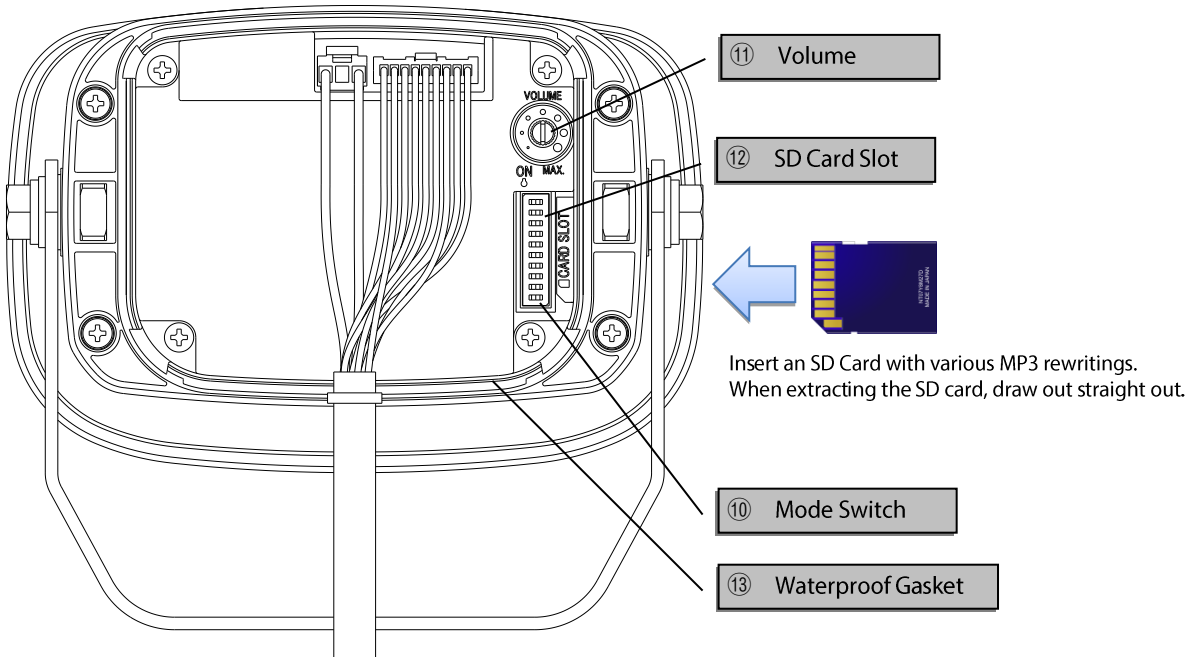

Mode Switch

Switches are used to set up various functions.

Volume

The volume is adjustable.

SD Card Slot

Insert an SD Card with various MP3 rewritings.

Waterproof Gasket

The waterproof gasket is required in order to maintain the waterproof performance of the product. Do not remove.

Caution

- Beware of the direction when inserting the SD card in the SD card slot. Don't forcibly insert the SD card into the card slot. Failure to comply may result in the damage of the SD card or the card slot.

● **EH□-□T□ (Terminal Buss Type)**

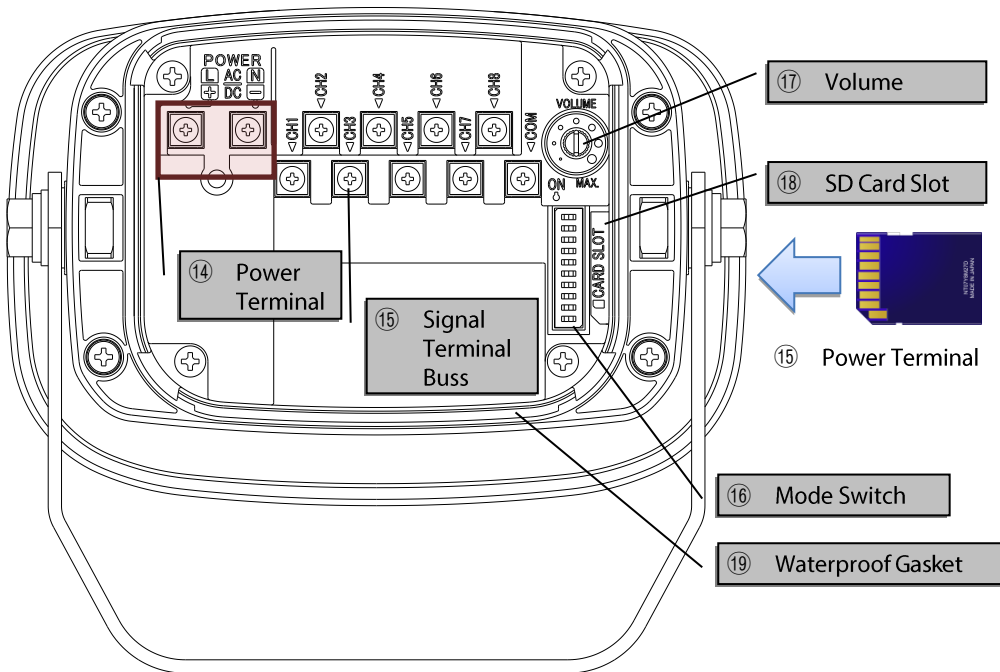

Power Terminal

It is the Terminals which connects the Power Source.

Signal Terminal Buss

It is the Terminal Buss which connects the signal lines.

Mode Switch

Switches are used to set up various functions.

Volume

The volume is adjustable.

SD Card Slot

Insert an SD Card with various MP3 rewritings.

Waterproof Gasket

Waterproofing packing is required in order to maintain the waterproof performance of the product. Do not remove.

Caution

- Beware of the direction when inserting the SD card in the SD card slot. Don't forcibly insert the SD card into the card slot. Failure to comply may result in the damage of the SD card or the card slot.

5.3. Mode Switch EHV EHS

The Mode Switch can change the contents according to the product model or applied mode. The following page explains the features according to the model.

5.3.1. Features Common to Both Models EHV EHS

- When selecting the mode switch position, be sure to slide all the way to both ends where ON/OFF is, and use a tool with a thin tip.

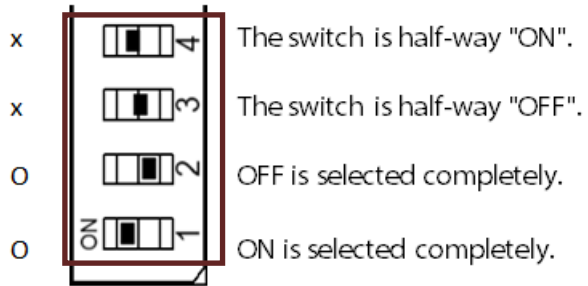
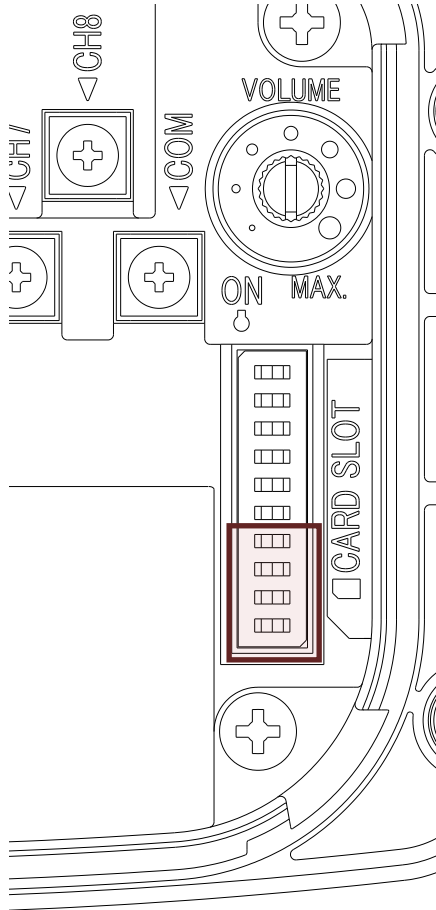

- Unassigned Mode Switches labeled as "Open" should be left in the "OFF" position.

5.3.2. EHV type EHV

The EHV type can select for an "MP3 setup" or "Forced Playback", by changing the Mode Switch positions.

Table 1: EHV Mode Switch Function List

Function Name	Setting Index	Details
(1) Sound Group	Groups A-P	Page 29 "9.2 Sound group" EHV EHS
(2) Channel Input Method	Binary / Bit	Page 30 "9.3 channel input method" EHV EHS
(3) Playback Mode	Normal Playback/Input Priority Playback/Hold Playback/Memory Playback	Page 32 "9.4 Playback Mode" EHV "
(4) Sound Mode	Signal / Information	Page 32 "9.5 Sound Mode" EHV EHS
(5) MP3 Setup	MP3 ON / OFF	Page 34 "9.6.MP3 Setup" EHV
(6) Forced Playback	Forced Playback ON/OFF	Page 34 "9.7 Forced Playback" EHV EHS
(7) Sound Selection	1-63	Page 34 "9.7 Forced Playback" EHV EHS

Table 2: EHV Mode Switch Assigned Functions

	When "(6) Forced Playback" is OFF	When "(6) Forced Playback" is ON
When "(5) MP3 setup" is OFF		
When "(5) MP3 setup" is ON		

Please

- The EHV modes that are initiated at power supply start-up are modes "(2) channel input method", "(3) playback mode", and "(5) MP3 setup". To initiate the required setup while the power supply is still on; turn it OFF once, then turn it ON again for the changes to take effect. The other mode switch functions will be reflected shortly after changing the settings.

5.3.3. EHS Type EHS

The EHS Mode Switch changes the contents in the "Forced Playback" state.

Table 3: EHS Mode Switch Function List

Function Name	Setting Index	Details
(1) Sound Group	Groups A-H	Page 29 "9.2 Sound group" EHV EHS
(2) Channel Input Method	Binary / Bit	Page 30 "9.3 channel input method" EHV EHS
(3) Sound Reduction	No sound reduction /-10dB /-20dB /-30dB	Page 25 "8.2 Sound reduction function" EHV EHS
(4) Sound Mode	Signal / Information	Page 32 "9.5 Sound Mode" EHV EHS
(5) Forced Playback	Forced Playback ON/OFF	Page 34 "9.7 Forced Playback" EHV EHS
(6) Sound Selection	1-32	Page 34 "9.7 Forced Playback" EHV EHS

Table 4: EHS Mode Switch Assigned Functions

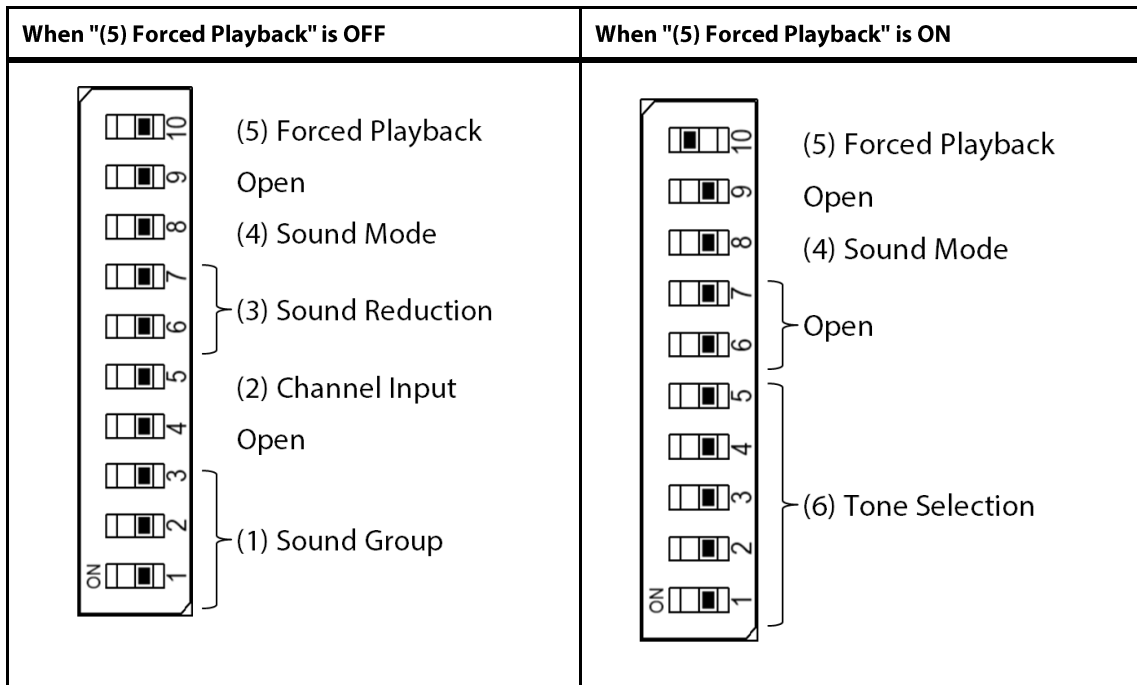

Note

- The EHS mode switch functions will be reflected shortly after changing the settings, even when the power supply is ON.

6. Installation EHV EHS

The M8 bolt for the angle bracket is loosely tightened at the time of shipment. Tighten the M8 bolts after the horn angle position is fixed. (Recommended Torque: 6.0 N-m)

Please affix the angle bracket onto a sturdy surface with three M8 bolts at the time of installation. When installing in a place where particularly large vibrations are present, please ensure that the product is secure enough that it does not fall. Since the M8 bolts are not included, it is up to the customer to provide the necessary parts.

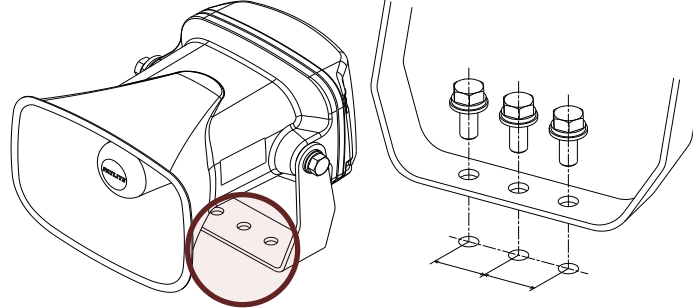

● Installation Precautions

	<p>Please install on a level surface with the horn in a downward direction. Failure to do so may result in water collecting, causing damage.</p>
	<p>It is recommended for outdoor attachment to install at a 45 degree angle from under an eave to protect from direct exposure to strong wind and rain.</p>
	<p>The cable should have extra slack and any exposed wires should be properly shielded for proper waterproofing management.</p>

Warning

- The product should be turned off and the power supply disconnected prior to installation. Failure to comply may result in electric shock.

Caution

- Please install on a level surface with the horn in a downward direction. Failure to do so may result in water collecting, causing damage.
- Ensure the installation surface is sufficient enough to handle the weight of the product, and where there is less vibration. Do not use the product in a place where vibrations exceeds the specifications. Failure to comply may result in the prevention of the product detaching and falling, causing injury to a passer-by, etc.
- Be sure to install with the recommended torque for the M8 angle bolts. Failure to comply may result in the prevention of the product detaching and falling, causing injury to a passer-by, etc.

Please

- If installed in a place exposed to large vibrations, the periodical tightening of screws and bolts should be increased to prevent any dangers.
- Use the resin washers included for the angle bracket.
- When installing in high places, choose a location which is accessible by a scaffold, ladder, etc., for repairs.
- If the product is directly connected and controlled only by the power supply, include a switch between the power supply and product in an easy-access location to turn it off for safety.
- Please install in a place in which the cover can be removed for rewriting or other setup functions.

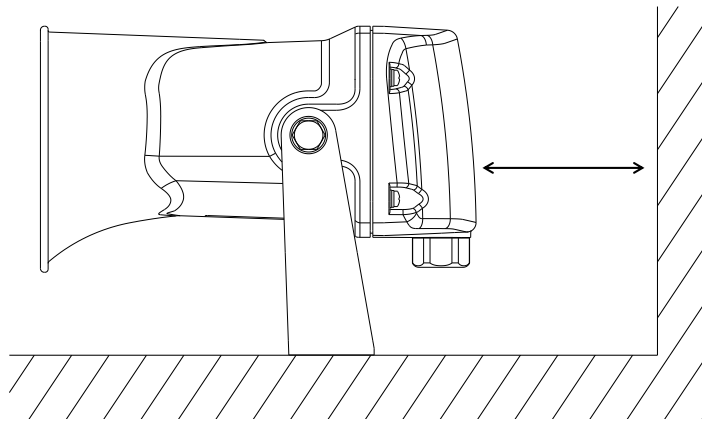

6.1. Cover Removal EHV EHS

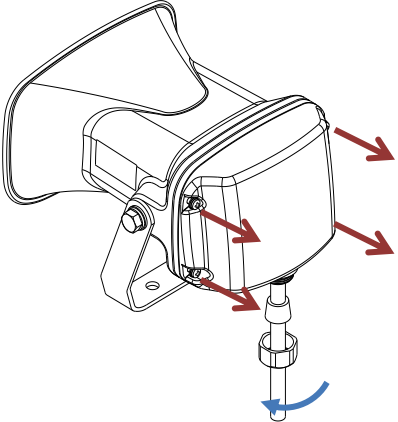
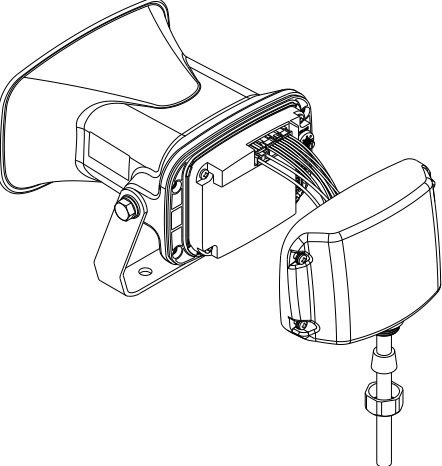
	<p>Remove the waterproofing gland and loosen the waterproof rubber before loosening the M4 screws. Even if the M4 screws are loosened, it will not fall.</p>
	<p>Remove the cover. Be careful not to exert excessive force to the cable used for wiring at this time.</p>

When attaching the cover, please install in the reverse steps for removing the cover. Be sure to bolt the M4 screws with the recommended torque value (Recommended Torque: 0.7 N-m). Be sure to attach the waterproof rubber and waterproofing gland when using it in an environment which needs waterproofing performance and protection against dust.

Caution

- Be careful not to exert excessive force when pulling on the cable used for wiring. Failure to comply will result in damage to the product.

Please

- Discharge any static electricity from the body before handling static sensitive parts, such as the SD Card. To prevent damage from static electricity, touch hands or other body parts to metals or an earth ground to discharge the body from static charge.
- Tighten all parts with the recommended torque values.
- The cover and waterproofing gland should not be allowed to come loose.

7. Wiring EHV EHS

Use external contact circuits, such as relay switches or transistor circuits (NPN/PNP type) for control. Refer to contact capacity diagrams 5 to 7.

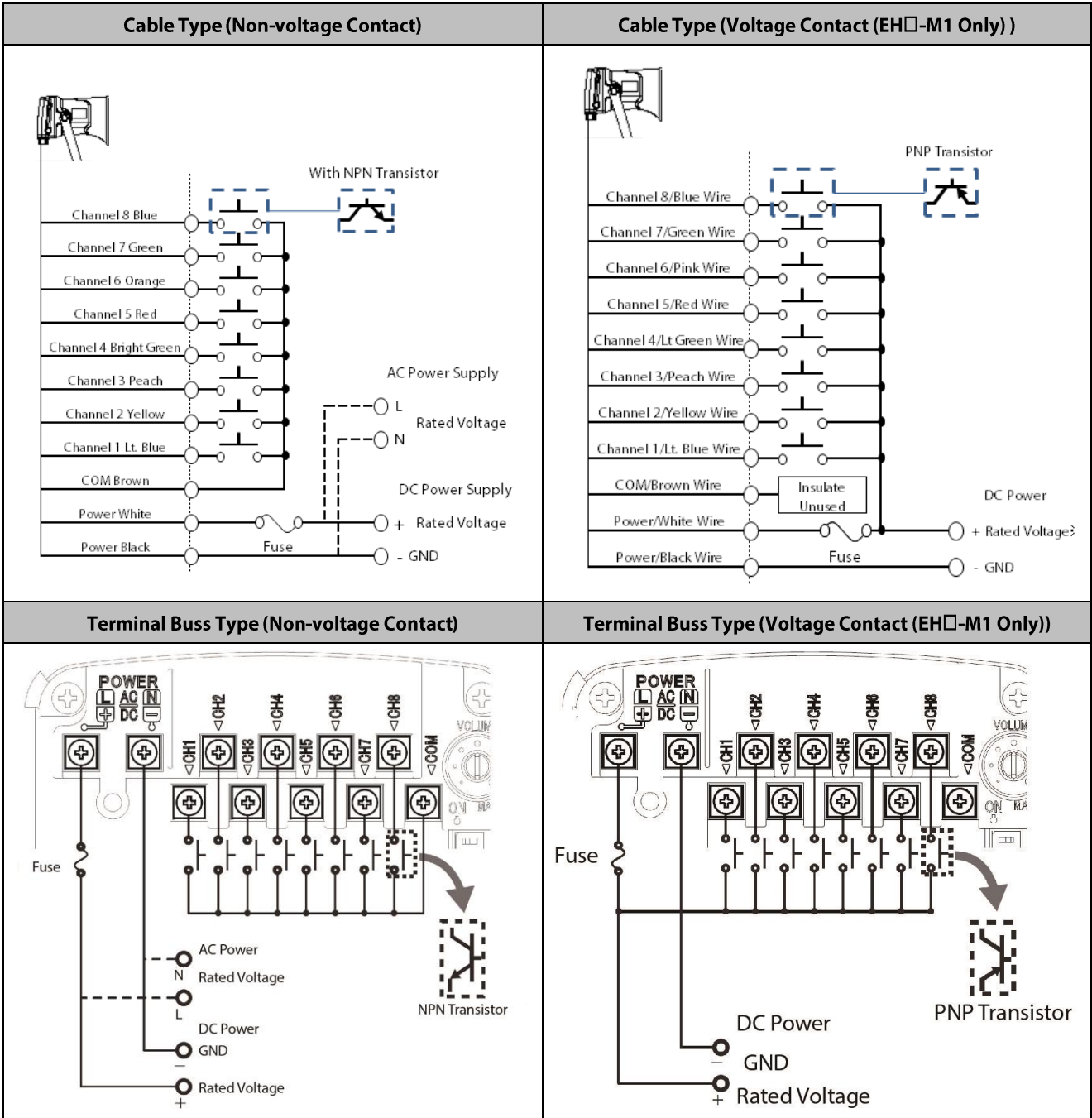

* Voltage contact input should be in the range of DC10.8 V to DC31.6 V.

- The following parts are recommended when wiring to the Terminal Buss.
 - Diameter: ϕ 8.5mm to ϕ 10.5mm
 - Terminal : M3 Round terminals with insulated coating (RoHS Compliant)

! Caution

- When connecting a Source-type PLC, be sure to insert a diode as indicated in the drawing below. Failure to insert a diode will lead to possible malfunction.

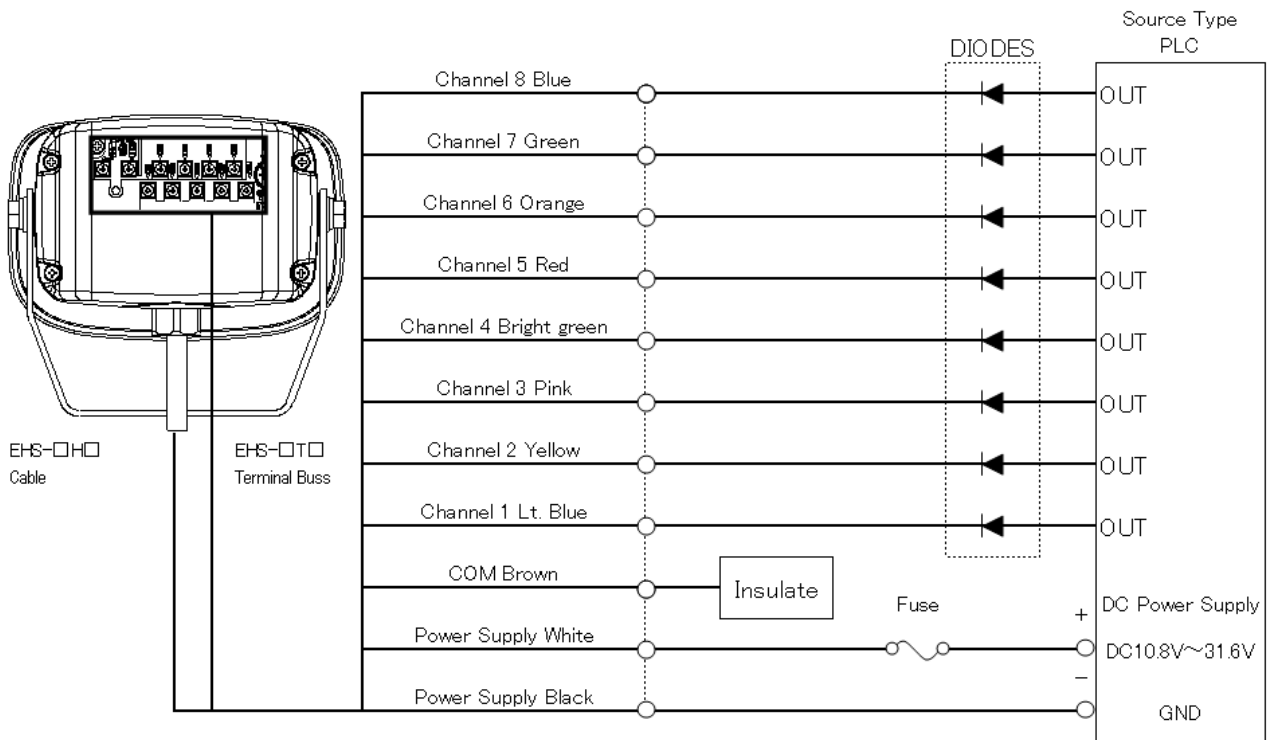

※ Select a diode with ratings indicated below.

Forward Current	50mA or more
Reverse Voltage	50V or more

Table 5: Signal Contact Capacity

	Non-voltage Contact	Voltage Contact (EH□-M1) Applied Voltage Below 26.4 V	Voltage Contact (EH□-M1) Applied voltage 26.4 V or greater
Current Capacity	10mA or more	10mA or more	15mA or more
Withstand Voltage	DC35 V or more		
Leakage Current	0.1mA or less		
ON Voltage (Vsat)	1V or less		

Table 6: Recommended Fuse

	Rated Voltage	Rated Current	Fusion Type
EH□-M1	250 V	500 mA	Normal Blow, PSE Class A
EH□-M2	250 V	800 mA	Normal Blow, PSE Class A

Table 7: Power Supply Inrush Current

EH□-M1	12.5 A
EH□-M2	23 A

 **Warning**

- Be sure of proper wiring. Failure to conform may result in product damage, resulting in damage to the circuitry or fire.
- The power supply should be turned off prior to wiring, at any cost. Failure to comply may result in electric shock.
- Tighten the terminal screws with the appointed torque value when wiring to the Terminal Buss. If the wiring separates from the terminal, short-circuit or electric shock may result. (Recommended Torque: 0.3 N-m)

 **Caution**

- Be sure to attach the cover in its proper position with the appointed torque value. Failure to comply can result in water and dust entering and causing product damage. (Recommendation torque value 0.7 N-m).
- When installing in an environment containing a lot of water and dust, it is recommended to use a cable with a diameter in the range between 8.5mm to 10.5 mm, and attach the waterproofing gland and waterproofing rubber. The protection rating value cannot be assured in such environments, and a risk of failure may occur.

Please

- Connect an external fuse to protect the power supply and internal circuitry.
- Be sure to check for proper wiring before connecting the power.
- To counter against noise, shorten all wiring as much as possible, and use shielded wire when possible. In addition, separate any signal lines which pass along high voltage cables or is susceptible to receive induction noises.
- The cable which is not used should be insulated individually after wiring. Failure to comply may result in malfunction.
- If a non-voltage contact, such as a relay or switch etc., is used for the power supply line, consider inrush current capacity when selecting the contact. Contact welding and malfunction will occur if current capacity is insufficient.
- The common or signal lines to our products, other than EHV/EHS, cannot share the same common connections when used together with our products (Since there are differences in signal voltages for each product, circuitry break-down may occur). Please be sure to use a switch or relay with two circuit contacts to separate the circuits.
- Use the same power source as the product when applying voltage to a voltage-contact signal line. Applying a voltage outside the power source used for the product may result in malfunction or damage to the product. (EH□-M1 only)

Note

- Even when a power supply or a signal input are entered at the same time by two or more units, no synchronization will occur in playback.

8. Controlling the Volume EHV EHS

8.1. Volume Adjustment EHV EHS

The volume is adjustable. Adjust the volume lightly, using a finger, or a precision flat-head driver with a thickness of 1.0mm or less. The "O" indicator refers to the increase in volume according to the increase size of the indicator.

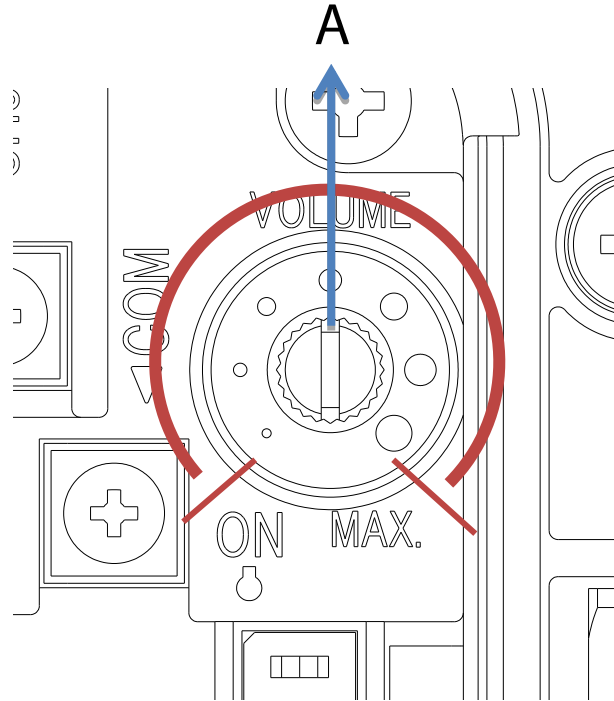

- Prior to shipment, the volume is set at position "A" in the figure above.

Caution

- Turn the volume lightly. Torque larger than 0.1 N-m applied may cause damage.
- Do not apply strong shock against the volume or suppress it. Possible cause of failure may occur.

Note

- If volume is greatly increased, sound distortion may occur from a sound.
- Depending on the environment, even with the volume set as the minimum, it may still be audible.

8.2. Sound Reduction Function EHV EHS

The sound reduction function is a function which lowers playback volume with a signal input. Directions for Forced Playback depends on the setup.

8.2.1. With Forced Playback OFF EHV EHS

EHV

Once the sound reduction is set up for an EHV, as soon as there is a signal input, the playback volume will drop. In order to use this function, it is channel functional assignment beforehand (See page 35 "9.8 channel function assignment"). The signal line assigned to the sound reduction becomes 1 to 2 inputs. After 300ms of a signal line input, the sound reduction takes effect. The following setup describes the procedure to activate the sound reduction function.

Table 8: EHV Sound Reduction Activation



Setting Index	Mode Switch Status
MP3 Setup	 ON (MP3 setting ON)
Forced Playback	 OFF (Forced Playback OFF)

Table 9: EHV Sound Reduction Amount (2 Inputs)

"Sound Reduction 1"	"Sound Reduction 2"	Sound Reduction Values
x	x	0 dB (None)
O	x	-10 dB
x	O	-20 dB
O	O	-30 dB

Table 10: EHV Sound Reduction Amount (1 Input)

"Sound Reduction 1"	Sound Reduction Values
x	0 dB (None)
O	-10 dB

With input -- O With no input -- x

Note

- To use the sound reduction function, the sound reduction function has to first be assigned to a signal line using the PATLITE Playlist Editor 2, then to transmit the created Playlist Package to this product. Refer to page 36 "9.8. Assigning Channel Functions EHV" on how to assign a signal line for sound reduction, and refer to page 39 "10. Data Rewriting EHV" for the transfer method of a Playlist Package.
- Once the signal line is assigned as a sound reduction function, it is not able to be used as a channel playback signal line.
- This function is activated shortly after the MP3 data is written to this machine to transmit the channel function assignment.
- Refer to the page 56 "12.5.2 Sound Reduction Function Time Chart EHV" for the time chart.

EHS

The Sound Reduction setup for the EHS type is by using the Mode Switch and an input on the channel 8 signal line for the volume to drop. The value of sound reduction for the EHS type can be selected by the Mode Switch. After 300ms of a signal line input, the sound reduction takes effect.

Table 11: EHS Sound Reduction amount

Mode Switch				
Sound Reduction Values	0 dB (None)	-10 dB	-20 dB	-30 dB

Note

- When the sound reduction setup is activated by the Mode Switch, the channel 8 signal line is not able to be used for playback. When the sound reduction is setup when the channel input is in the bit input mode, the number of message inputs will be set to seven. When the sound reduction is setup when the channel input is in the binary input mode, there is no decrease in the number of message inputs.
- This setup function is immediately activated, even while the power supply is ON.
- Refer to page 59 "12.6 Sound Reduction Time Chart (EHV, EHS)" for the time chart.

● Wiring Example

In this example with the EHV, the "Sound Reduction" is assigned signal line channels 4 and 8, using the PATLITE Playlist Editor 2 software.

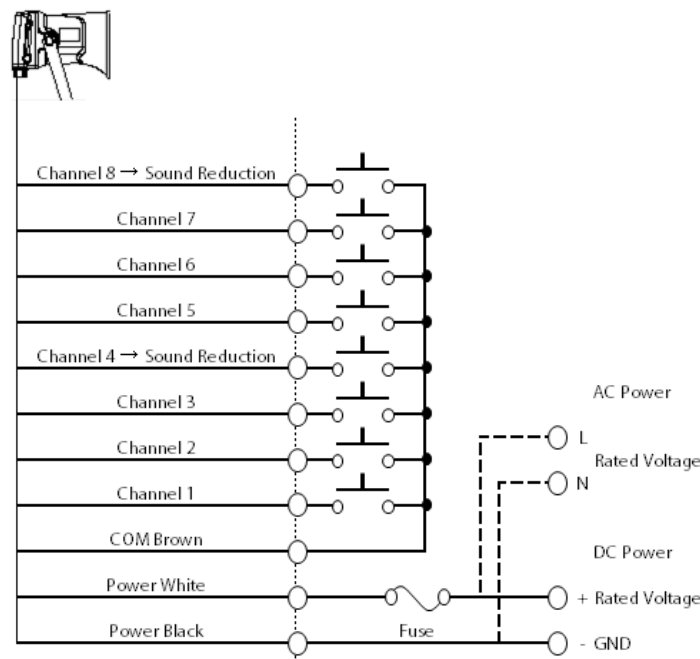

8.2.2. Forced Playback ON Mode EHV EHS

When the Forced Playback is ON, signal line channels 1, 2, and 3 are assigned as sound reduction. Sound reduction occurs during playback when an input is on Channel 1, Channel 2 or Channel 3. Priority is given to the higher channel, which is from Channel 3 to Channel 1, in case two or more signal inputs are entered.

Table 12: Forced Playback ON Sound Reduction Amount

Signal Line Channel Input	Sound Reduction Values
None	0 dB (None)
CH1	-10 dB
CH2	-20 dB
CH3	-30 dB

Please

- Insulate any signal lines not used for the sound reduction function.

9. Various Functions EHV EHS

This section explains the Mode Switch, which controls the various functions for this product.

9.1. Factory Settings EHV EHS

9.1.1. Mode Switch EHV EHS

EHV-□□□M		EHV-□□□	EHS-□□□
8 Messages or less	9 Messages or more		
<ul style="list-style-type: none"> ● Channel Input Method (Bit) ● Normal Playback Mode ● MP3 setup ON 	<ul style="list-style-type: none"> ● Channel Input Method (Binary) ● Normal Playback Mode ● MP3 setup ON 	<ul style="list-style-type: none"> ● Channel Input Method (Bit) ● MP3 setup OFF EHV 	

9.1.2. Assigning Channel Functions EHV

All of the EHV channel function assignments are set as "Playback" at the time of shipment.

9.2. Sound Group EHV EHS

This product can select sound groups from A-P (EHV) to group A-H (EHS). When the Mode Switch is selected in the positions in Table 13, the selected sound group becomes active.

Table 13: Mode Switch Sound Group Settings



Setting Index	Mode Switch Status
Forced Playback	 OFF (Forced Playback OFF)
MP3 Setup EHV	 OFF (MP3 setting OFF)
Channel Input Method	 OFF (Bit Input)

Table 14: Sound Group Setup List

Mode Switch	Sound Group	Mode Switch	Sound Group	Mode Switch	Sound Group	Mode Switch	Sound Group
	Group A		Group E		Group I		Group M
	Group B		Group F		Group J		Group N
	Group C		Group G		Group K		Group O
	Group D		Group H		Group L		Group P

Note

- Group I-P is for the EHV only, for the EHS, keep the 4th Mode Switch in the OFF position.
- This setup function is immediately activated, even while the power supply is ON.
- Refer to page 72 "19 Sound List EHV EHS" for the sounds contained in each group.

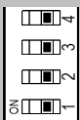
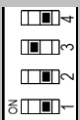
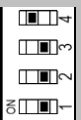
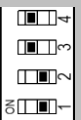
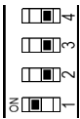
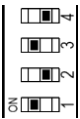
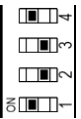
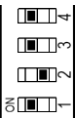
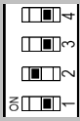
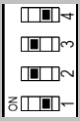
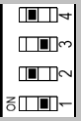
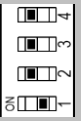
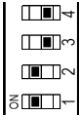
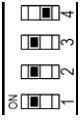
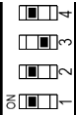
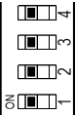
9.3. Channel Input Method EHV EHS

This product has two kind of channel signal line input modes, bit input and binary input. The following setup describes the method on how to activate the different channel input modes.

Table 15: "Active" Channel Input Mode Switch Method

Setting Index	Mode Switch Status
Forced Playback	 OFF (Forced Playback OFF)

Table 16: Channel Input Method Explanation

Mode Switch	Input Method	Description	Available Messages
	Bit Input	The sound number and message No. correspond to the Sound Table by a 1 to 1 ratio. It is can be used in cases where the playback messages are eight or less. Messages are played back by the selection of two or more signal lines. It can be used in cases where the playback messages are nine or more. Refer to page 62 "14 Binary Conversion Table EHV EHS " for the signal line inputs necessary to play back the desired message number.	EHV 8 EHS 8
	Binary Input		EHV 63 EHS 32

Please

- When using this product in the binary input mode, be sure that the signal line input is changed within 10ms. If the changing time exceeds 10ms, another sound may be reproduced if the conversion takes too long.

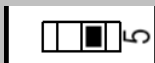
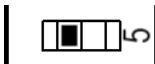
Note

- EHV If this function is changed while the power is on, it will be activated at power supply start-up. To initiate the required setup while the power supply is still on; turn it OFF once, then turn it ON again for the changes to take effect.
- EHS This setup function is immediately activated, even while the power supply is ON.
- The number of message playback may be decreased if other functions are assigned to a signal line, such as enabling the sound reduction function with the Mode Switch. For more details, refer to page 36 "9.8 Assigning Channel Functions EHV" and page 26 "8.2.1 With Forced Playback OFF EHV EHS".
- Refer to page 51 "12.3 Channel Input Mode Time Chart EHV EHS" for the time chart.

9.4. Playback Mode EHV

The EHV can select among four kind of playback modes. This section describes the setups for activating each playback mode.

Table 17: "Active" Playback Mode Switch Settings



Setting Index	Mode Switch Status
Forced Playback	 OFF (Forced Playback OFF)
MP3 Setup	 ON (MP3 setting ON)

Table 18: Playback Mode List

Mode Switch	Playback Mode	Description
	Normal Playback	MP3 data is reproduced in correspondence to an input. Playback is repeated when the input is maintained.
	Input Priority Playback	During an MP3 message playback, the message will stop when a different channel input is entered and the message will continue after the previous channel's message has ended.
	Hold Playback	The message will only play back while the input is held on and repeat until the input is removed. Playback is stopped as soon as the input is removed.
	Memory Playback	During playback, when a channel input is entered, the message number corresponding to the input is put into memory. When the previous message playback is terminated, the message number entered afterward into the memory will be played next.

Please

- If this function is changed while the power is on, it will be activated at power supply start-up. To initiate the required setup while the power supply is still on; turn it OFF once, then turn it ON again for the changes to take effect.

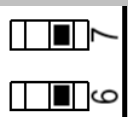
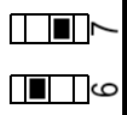
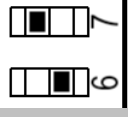
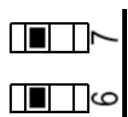
Note

- When turning the MP3 setup OFF, the function is the same as the Hold Playback.
- Refer to page 52 "12.4 Time Chart for different Playback Modes EHV" for the timing.

9.5. Sound Mode EHV EHS

This product contains a feature to reproduce two kind of waves. This feature is to be used in accordance with the customer's application and surrounding environment. The Sound Mode feature only becomes active when an alarm/melody is being played back.

EHV This function setup is not available for MP3 data.

Table 19: List of Sound Modes

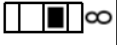
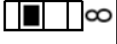
Mode Switch	Selective Condition	Description
	Factory	The audible sound is suitable for large areas.
	Public Address	The audible sound is suitable for public announcements.



Note

- Depending on the sound, a significant difference may not be noticed when the sound is played back for this function.
- With the "Factory" mode, the sound is made to seem louder than the "Public Address" mode.
- This setup function is immediately activated, even while the power supply is ON.
- When the setup of this function is changed during a signal input for playback, the tone being played back starts again from the beginning.

9.6. MP3 Setup EHV

With the EHV Type, a mode is available to switch the MP3 function off and only allow the alarm and melody sounds to playback.

Table 20: MP3 Setup Mode List

Mode Switch	Setup Condition	MP3	Alarm/Melody	Description
	MP3 setting OFF	x	O	In this mode, only alarm and melody sounds can be played. Select this function if MP3 data does not need to be played back.
	MP3 setting ON	O	O	This mode allows the combination of registered MP3 data and alarm/melody sounds to be played back. Select this function if MP3 data needs to be played back.

Please

- If this function is changed while the power is on, it will be activated at power supply start-up. To initiate the required setup while the power supply is still on; turn it OFF once, then turn it ON again for the changes to take effect.

Note

- It is necessary to use the PATLITE Playlist Editor 2 to set up MP3 data in combination with alarm/melody sounds. Refer to the help section of the PATLITE Playlist Editor 2 on how to put together a play list with the PATLITE Playlist Editor 2.

9.7. Forced Playback EHV EHS

This function allows a designated sound to be played back without a signal input. When this function is enabled with the Mode Switch, the sound played back is dependent upon the group setting and only one sound is played.

Table 21: Forced Playback Explanation

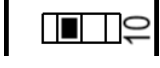
Mode Switch	Setup Condition	Description
	Forced Playback OFF	<p>By entering a signal line input, the message number to that input will play back.</p> <p>If there are two or more messages to be played back, or if the playback of the product is to be controlled by the inputs with the power supply constantly ON, select this function.</p>
	Forced Playback ON	<p>The message is selected with the Mode Switch for repeated playback while the product power supply is ON. If there is only one message to be played back and the product is to be controlled by the ON/OFF of the power supply, select this function.</p> <p>Refer to "Diagram 14: Binary Conversion" for the message number selection.</p>

Note

- This setup function is immediately activated, even while the power supply is ON.
- This function can also be used in combination with other available features, such as sound reduction to control the volume.

9.8. Assigning Channel Functions EHV

The EHV can be programmed to select playback, sound reduction, stop and clear function from a signal line input. In order to set up this function, the PATLITE Playlist Editor 2, in combination with a Playlist Package, is used to assign the functions and transmitting it to the product using an SD card. All channels operate within 300ms after a channel signal input is detected. Channel function assignments are active with the following setup from the table below.

Table 22: Mode Switch settings for channel functions



Setting Index	Mode Switch Status
Forced Playback	 OFF (Forced Playback OFF)
MP3 Setup	 ON (MP3 setting ON)

Table 23: Channel Function List

Channel Function	Outline
Playback	The message number corresponding to the channel signal line input is played back.
Sound Reduction	The volume of sound being played back is decreased. Sound reduction can be assigned to a maximum of two signal lines.
Stop	The message being played back is stopped. When the playback mode is in memory playback, the message played back is halted and the next message in memory is played.
Clear	The message being played back is stopped. When the playback mode is in memory playback, the message played back will be halted and all messages in the memory is cleared. In other playback modes outside memory playback, the same operation as the stop function occurs.

Note

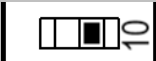
- The setup of this function is activated immediately after the Playlist Package data from an SD card is transmitted.
- When the signal lines are assigned to functions other than playback, be aware of the message numbers when assigning channels. Refer to the following page for details.
- If the PATLITE Playlist Editor 2 is not used when rewriting MP3 data, all channel function assignments will be set as playback.
- Refer to page 56 "12.5 Channel Function Time Chart EHV" for the time chart of each channel function.

● Channel Function Assignment and Playback Examples

The following table shows examples of channel function assignments and available signal inputs for message playback. Channel function assignments are shown in combination with channel playback inputs and modes. Refer to the sound list and binary conversion table when assigning signal line functions with message numbers.

Table 24: Channel Function Assignment Example

	Assigned Channel Functions								Available Messages	
	CH1	CH2	CH3	CH4	CH5	CH6	CH7	CH8	Bit	Binary
Example 1	Playback	Playback	Playback	Playback	Playback	Playback	Playback	Playback	8	63
Example 2	Playback	Playback	Playback	Playback	Playback	Playback	Sound Reduction	Sound Reduction	6	63
Example 3	Playback	Playback	Playback	Playback	Stop	Clear	Sound Reduction	Sound Reduction	4	15
Example 4	Stop	Clear	Sound Reduction	Sound Reduction	Playback	Playback	Playback	Playback	4	3

Channels 7 and 8 are not used for binary input (refer to page 62 "14 Binary Conversion Table (EHV EHS)"). In Examples 3 and 4, although the assigned playback signal lines are the same number, since playback is assigned to channels 7 and 8, the available number of messages for binary input is decreased. Referring to Table 25, when channel functions like Example 4 are assigned, playback can be possible by selecting a binary input for the channel input method to play the message combinations.

Table 25: Example 4 message playback input combinations

Message No.	Input Channel							
	1	2	3	4	5	6	7	8
16					0			
32						0		
48					0	0		

Note

- When combining, refer to page 61 "14 Binary Conversion Table (EHV EHS)".
- If a desired alarm/melody is unreproducible, use the PATLITE Playlist Editor 2 to program the combination of channel function assignments with the sound group to play the desired alarm/melody. For details, please refer to the PATLITE Playlist Editor 2 for help.

9.8.1. Playback EHV

When a signal input is entered for the channel function assigned to play back, the corresponding message will be reproduced.

9.8.2. Sound Reduction EHV

The playback volume is lowered while the input on the signal line is entered when the channel function is assigned to sound reduction. Sound reduction can be assigned to a maximum of two signal lines. Channel priority can be used to assign the channels for "sound reduction 1" and "sound reduction 2". When the signal line is only assigned to one sound reduction, "sound reduction 1" is assigned. If the signal line for sound reduction is assigned to three or more, the input of the signal line assigned from the third sound reduction becomes invalid (Playback is also inactive).

Note

- For further details on the sound reduction function, refer to page 26 "8.2 Sound Reduction Function EHV EHS".

9.8.3. Stop EHV

When a signal input is entered for the channel function assigned to stop a message from playback, the corresponding message will be halted.

When a signal input is entered while the playback mode is memory playback, the message currently played back will be stopped. When the signal line input is released, then the next message in memory will be played back. Also, while the input of the signal line assigned to the stop is maintained, any signal line designated as a message playback that is entered will be stored in the playback memory.

9.8.4. Clear EHV

When a signal input is entered for the channel function assigned to clear a message, the corresponding message will be stopped. When a signal input is entered while the playback mode is memory playback, the message currently played back will be stopped and the memory will be cleared. Also, while the input of the signal line assigned to clear is maintained, any signal line designated as a message playback that is entered will be stored in the playback memory. However, upon release of the input signal line assigned as "clear" will cause the message entered into memory to be played back next.

Note

- Other playback modes using the signal line assigned as clear (excluding memory playback) will be the same operation as the stop function.

10. Data Rewriting EHV

An SD Card can be used for the MP3 data to be saved on the Main Unit memory to control the channel function assignments.

10.1. Necessary Items EHV

- An SD Card to save the data onto for rewriting (Recommended Parts :SDV-2GP or SDV-128P Option, refer to the "Help" section in the PATLITE Playlist Editor 2 on how to create the data.)
- Personal Computer (In a condition which all hardware operates normally)
- SD card reader/writer (For personal computers which don't have a built in card reader/writer)
- Application Software (PATLITE Playlist Editor 2)
- Supported OS (Windows[®] XP, Windows Vista[™] 32 bits/64 bit, and Windows[®]7 32 bit/64 bit, and Windows[®]8 32 bit/64 bits)
 * Even if the PC doesn't use it, data rewriting can be done, but some functions have restrictions. Please refer to page 40 "10.2 Data Creation EHV" for details.

Table 26: Corresponding Application Software

Application Software	Application	Outline
PATLITE Playlist Editor 2	○	This is a newer version of the PATLITE Playlist Editor. A playlist package can be created and the MP3 data and channel function assignment for the product can be rewritten.
FV-Win	×	This product is not compatible with the playlist created by FV-Win or the PATLITE Playlist Editor. However, the playlist can be changed into a playlist package using the PATLITE Playlist Editor 2.
PATLITE Playlist Editor	×	

Warning

- When rewriting data, be careful not to touch the wiring with the hand when inserting the SD Card. Failure to comply may result in electric shock.

Caution

- When inserting the SD Card, Do not attach the cover. Failure to comply may result in the damage of the SD card or the card slot.

Please

- It is recommended to format the SD Card before rewriting data. If the SD Card is used without formatting, it may take a longer time than usual to be read or written onto.

● **SD Card Formatting Method**

Open the "My Computer" window to select the drive containing the SD Card and right-click the drive to select "format". The format form should be selected as FAT16, FAT32, or FAT.

Executing a format command will eliminate all data on the SD Card.

10.2. Data Creation EHV

Rewriting MP3 data has two methods, using PATLITE Playlist Editor 2, or manually entering data onto an SD Card. Refer to the table below for each method.

Table 27: Comparison to application software use and disuse

Item	When to Use Application	When not necessary to use application
Number of MP3 Data per message	A maximum of 16 data files (It is combined freely and can playback in order)	One piece of data
Individual MP3 data settings are made	When setting up sound volume, end of playback blank-time, and Repeat Playback.	Cannot set up manually.
Assigning Channel function	When setting up to choose "playback", "sound reduction", "stop", and "clear".	All are assigned for "playback".

- For more details, refer to the help section in the PATLITE Playlist Editor 2 application software.

10.2.1. When using PATLITE Playlist Editor 2 EHV

Data can be created by using PATLITE Playlist Editor 2. For more details, refer to the help section in the PATLITE Playlist Editor 2 application software for the method to create the data.

Note

- Neither FV-Win nor PATLITE Playlist Editor can be used. When using the messages attached to FV-Win, read the messages registered in the FV-Win CD with PATLITE Playlist Editor 2 to rewrite.

10.2.2. When not using PATLITE Playlist Editor 2 EHV

Arbitrary message Numbers can be assigned by changing the MP3 data file name as followed:

0 1 2 . m p 3

Assign message numbers to three digits in the range between 001 to 063. (half-characters)

Example 1) 002.mp3 -- MP3 data which can be assigned to message No.2

Example 2) 013.mp3 -- MP3 data which can be assigned to message No.13

- The file name can use either upper case or lower case letters.

Please

- If an MP3 tag is contained in the MP3 data, it may not play back properly. Be sure to remove any MP3 tags beforehand. Also, if the MP3 data is set as read-only, it can prevent from automatically attaching an MP3 tag to the MP3 data.

10.2.3. Converting a Playlist (SLP File) EHV

If a playlist (PLAYLIST.SLP) was created using FV-Win and the PATLITE Playlist Editor, it is possible to use PATLITE Playlist Editor 2 to change it into a playlist package. For details, please refer to the PATLITE Playlist Editor 2 help.

10.3. Data Arrangement EHV

Preparation of data rewriting is done by creating a route folder in the SD Card, explained in "10.2 Data Creation". If data created from the application software is mixed with data created manually, the data made from the application software will take priority when it is rewritten.

● **When using PATLITE Playlist Editor 2**

Be sure to arrange the file to "playlist.pkg" (upper case or lower case letters are ok).

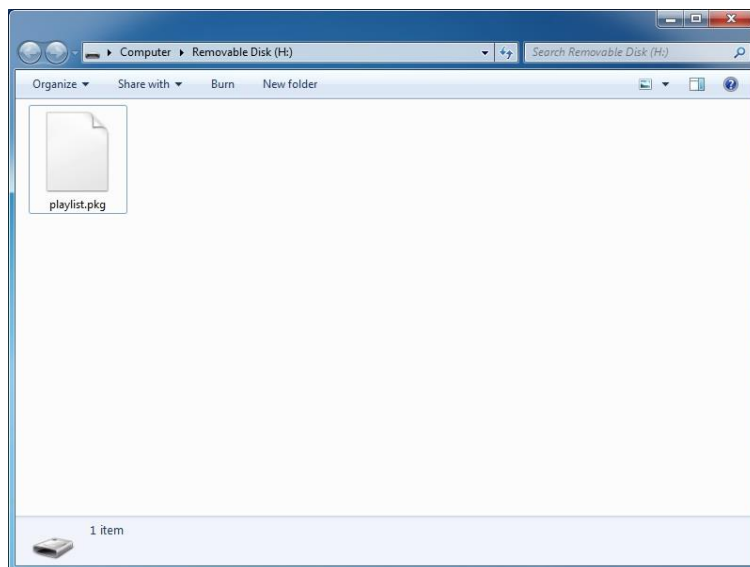

● **When not using PATLITE Playlist Editor 2**

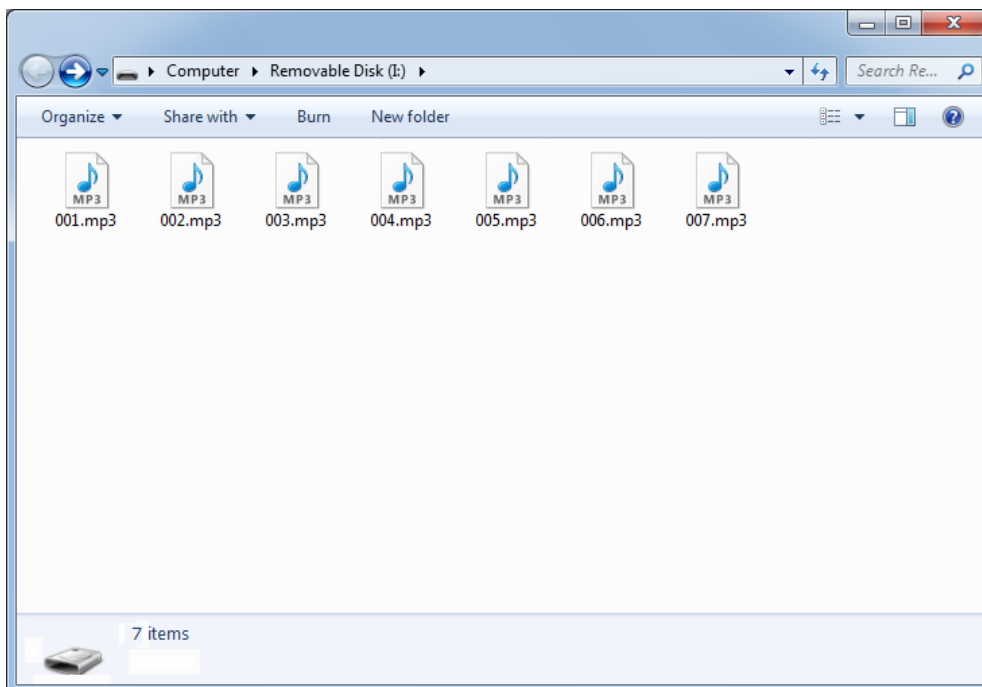

10.4. Data Rewriting Process EHV

A) Place the product into a standby status

Do not enter a signal wire, and turn OFF any forced inputs before turning on the power source.

B) Insert the SD card into the SD card slot

Insert the SD card with the saved data for rewriting into the SD Card slot. Data rewriting starts automatically.

- An alarm sound "beep" will announce that the data rewriting process has started.
When a short beep sound is heard, it indicates the rewriting sequence is complete and the SD Card can be removed from the slot, and when there is an error, the alarm will sound in combination with the contents of the error.
- Data rewriting takes a maximum of 60 seconds.
- If the power is turned off during data rewriting or the SD card is extracted, rewriting will not be completed normally. Redo the process from the beginning to rewrite again.
- Rewriting will eliminate all the current MP3 data written into the product memory.

C) Check that data is rewritten properly

Verify that the MP3 data was rewritten normally by playing back the data.

When data is created using PATLITE Playlist Editor 2, check that the channel function assignment is correct, and adjust accordingly if necessary.

Please

- Rewriting may be impossible when using some SD Cards, except the SDV-2GP or SDV-128P SD card.
- When formatting an SD card, only use FAT16 or FAT32. The SD card will not be recognized if its format is in any form outside the appointed format. The SD card will not be recognized if its format is in any form outside the appointed format. Refer to page 39 "10.1 Necessary Items EHV" for the SD card format method.

11. Sound Combination Method EHS

An SD card can be used for rewriting the combination to Sound Group H.

11.1. Necessary Items EHS

- An SD Card to save the data onto for rewriting (Recommended Parts : SDV-2GP or SDV-128P Option)
- Personal Computer (In a condition which all hardware operates normally)
- SD card reader/writer (For personal computers which don't have a built in card reader/writer)

Warning

- When making a sound combination, be careful not to touch the wiring with the hand when inserting the SD Card. Failure to comply may result in electric shock.

Caution

- When inserting the SD Card, Do not attach the cover. Failure to comply may result in the damage of the SD card or the card slot.

Please

- It is recommended to format the SD card before assigning sound combinations. If the SD Card is used without formatting, it may take a longer time than usual to be read or written onto.

● **SD Card Formatting Method**

Open the "My Computer" window to select the drive containing the SD Card and right-click the drive to select "format". The format form should be selected as FAT16, FAT32, or FAT.

Executing a format command will eliminate all data on the SD Card.

11.2. Data Creation EHS

Data for sound combinations can be created using text editors, such as a memo pad.

A) Insert an SD card in the SD card reader/writer

Connect an SD card reader/writer to a personal computer and insert the SD card into the SD card reader/writer.

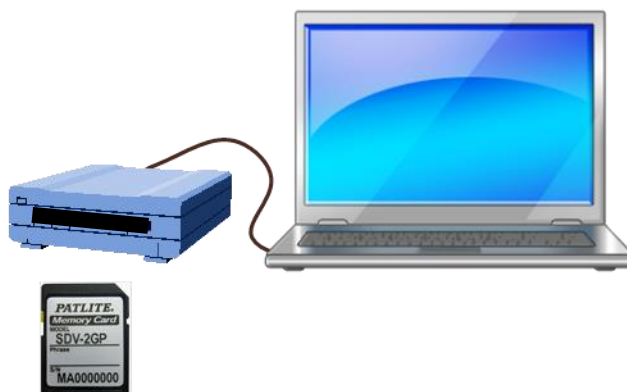

B) Open the SD card

Open the drive which shows the SD card inserted from the "My Computer" file in the personal computer.

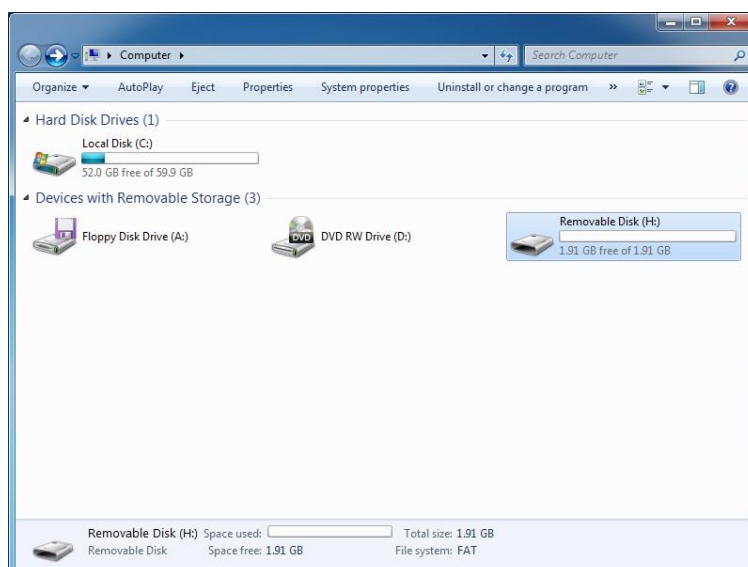

C) **Create a text document**

Right-click the mouse to open a window to select "text document" from "create new".

* File names may vary according to OS versions.

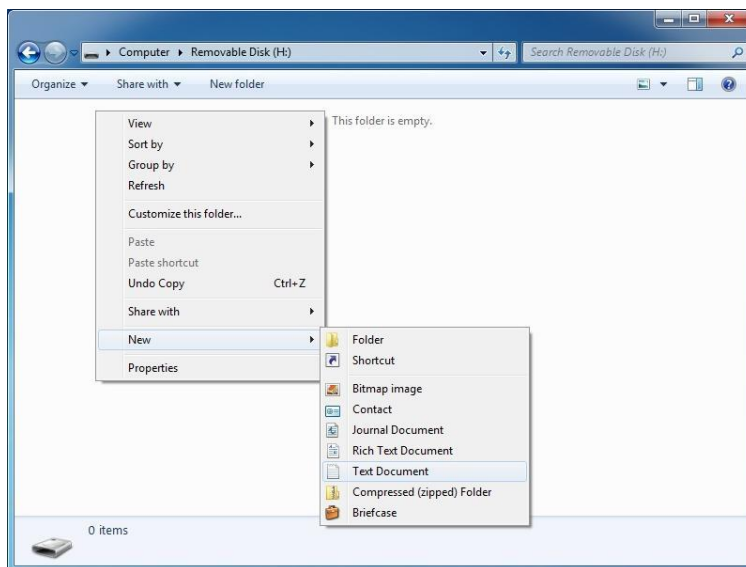

D) **Change the file name to OTO-LIST.txt**

Change the file name of the created text document into [OTO-LIST.txt]. Enter the file name in half-width characters. Both capital and small letters can be used.

While creating the text document, if the '.txt' is not displayed on the end, make the file name into [OTO-LIST].

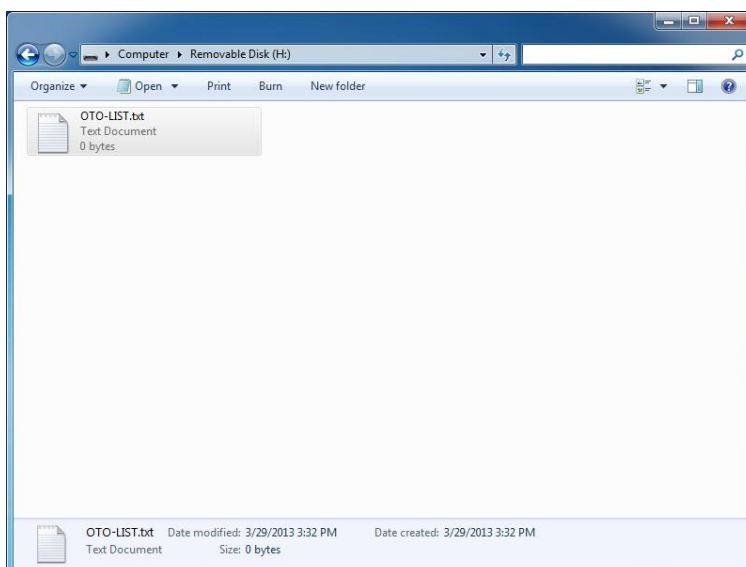

E) Enter a sound number.

Please enter and save the sound number (refer to page 72 "0

Sound List (EHV (EHS ") as described in (4) to created a text document. Use half-width characters for the sound number file name and enter a total of 16 figures.

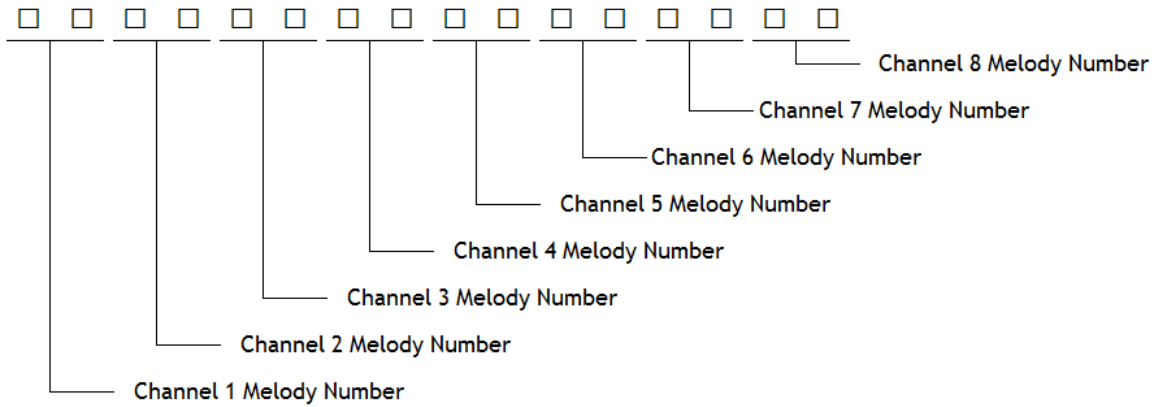

■ Data Creation Example

The following example is created for an EHS-□□E (Type E)

Table 28: Data Creation Example

Channel	Sound Number	Sound
1	1	Beep
2	25	Annie Laurie
3	7	Synthesized Piano
4	31	Ave Maria
5	20	Two Tone
6	2	Stutter
7	21	Alarm Clock
8	19	Ringing Phone

Enter the following numbers as a text document and save the file.

[0125073120022119]

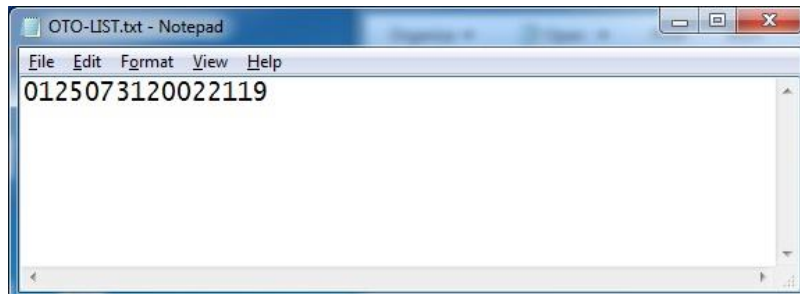

11.3. Data Rewriting Process EHS

A) Place the product into a standby status

Do not enter a signal wire, and turn OFF any forced inputs before turning on the power source.

B) Insert the SD card into the SD card slot





Insert the SD card with the saved data for rewriting into the SD Card slot. Data rewriting starts automatically.

- Data rewriting is completed in about 1 second. A short "beep" and alarm sound indicates it was rewritten properly.
- If a "beepbeepbeepbeep-beep" and alarm sound are reproduced, or nothing at all occurs, a rewriting error has occurred. Re-check the data contents and start at the beginning to redo the procedure. Most important, make sure the volume is at an audible level so the alarm sounds for rewriting completion may be heard.

C) Verify the sound combination was programmed correctly.

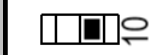
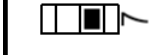
Set the Mode Switch as follows and check the sound combination when entering a signal line input.

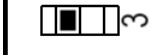
Table 29: Sound Combination Mode Switch

Setting Index	Mode Switch Status
Forced Playback	 OFF (Forced Playback OFF)
Sound Reduction	  No Sound Reduction
Channel Input Method	 Bit
Sound Group	  Group H 

Please

- Rewriting may be impossible when using some SD Cards, except the SDV-2GP or SDV-128P SD card.
- When formatting an SD card, only use FAT16 or FAT32. The SD card will not be recognized if its format is in any form outside the appointed format. Refer to page 44 "11.1 Necessary Items EHS" for the SD card format method.

12. Time Chart EHV EHS

A signal line input and a playback message is shown in the time chart. Although a typical signal line is shown a time chart, sometimes an operation is also shown with the signal line.

● Notations and how to read a Time Chart

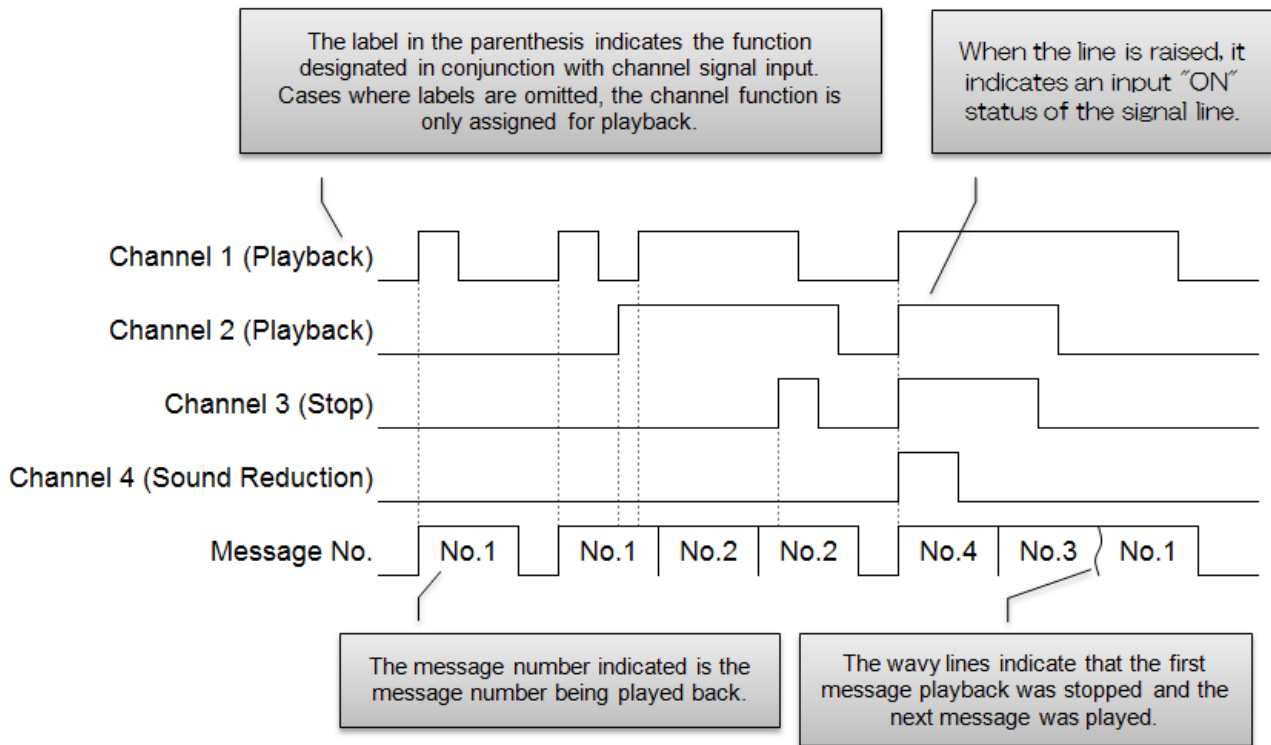

12.1. Signal Line Channel Input Time Chart EHV EHS

With the Forced Playback OFF and MP3 setting OFF (EHV), a message will be played back when a channel signal line input is present. Playback starts within 300ms after a channel signal line input occurs. In addition, playback is stopped within 300ms after the input to the channel signal line is removed.

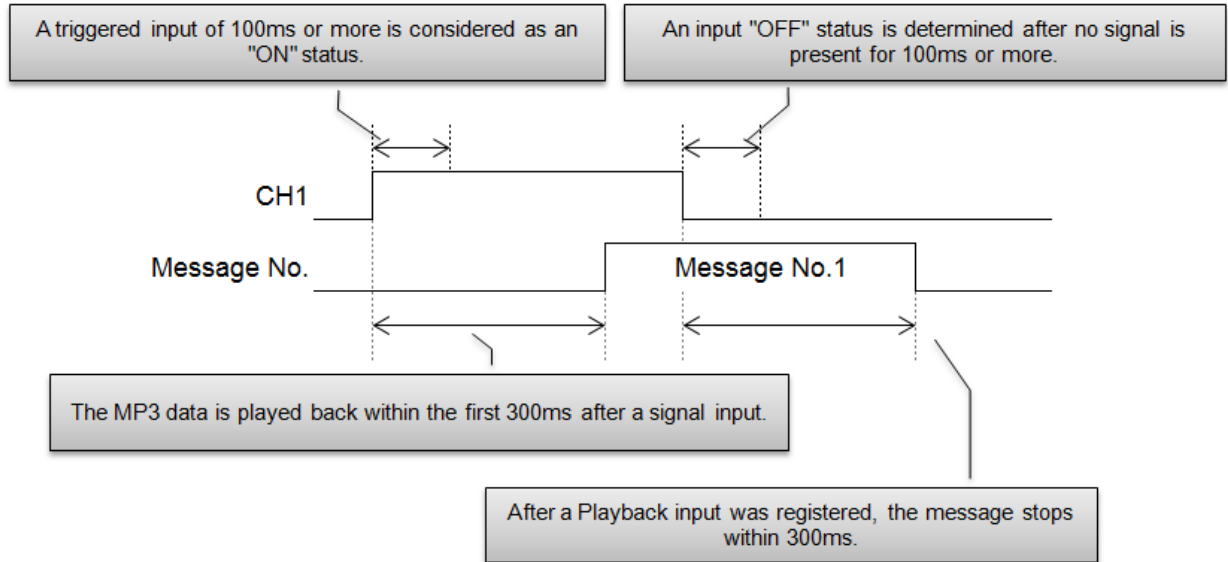

Note

- EHV For the "MP3 setting ON" function, refer to page 52 "12.4 Time Chart for different Playback Modes EHV".

12.2. Power Supply Start-up Time Chart EHV EHS

In most cases, the "Forced Playback ON" function plays messages at power supply start-up. This product starts playback within 300ms after power supply start-up.

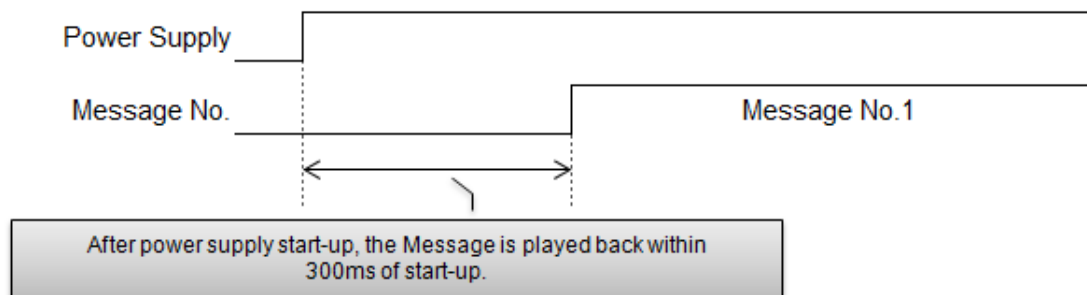

12.3. Channel Input Mode Time Chart EHV EHS

Two kind of modes can be selected from the channel signal line, bit input and binary input.

12.3.1. Bit Input Time Chart EHV EHS

Playback Messages are a one-on-one to signal line inputs, therefore what channel you enter is what message is played back.

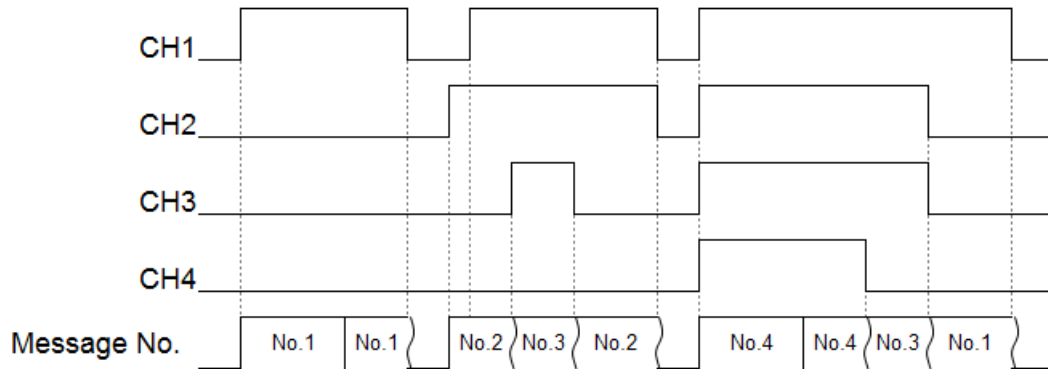

12.3.2. Binary Input Time Chart EHV EHS

This input method requires two or more signals to select messages in a binary format.

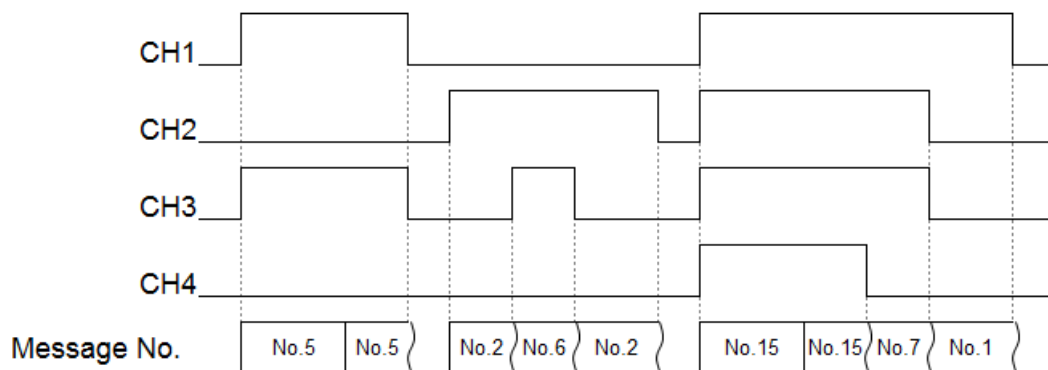

12.4. Time Chart for different Playback Modes EHV

The following playback functions are available when the "MP3 setting ON" is activated in the EHV models.

12.4.1. Normal Playback Time Chart EHV

Normal Playback reproduces Messages within 300ms from an input. If the entered signal line is held ON, then once playback of a message is completed, the same message will repeat.

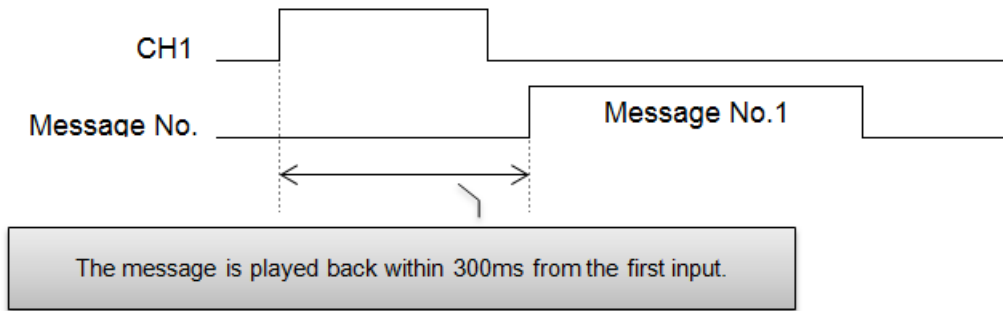

● Bit Inputs

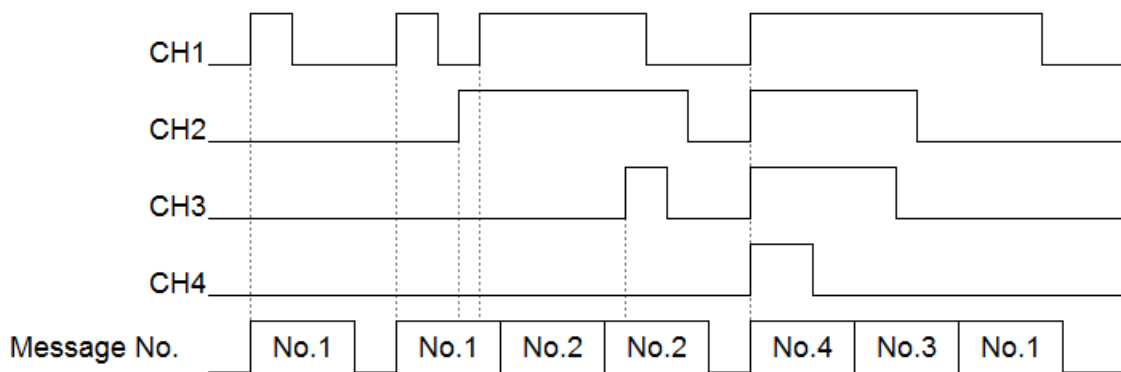

● Binary Inputs

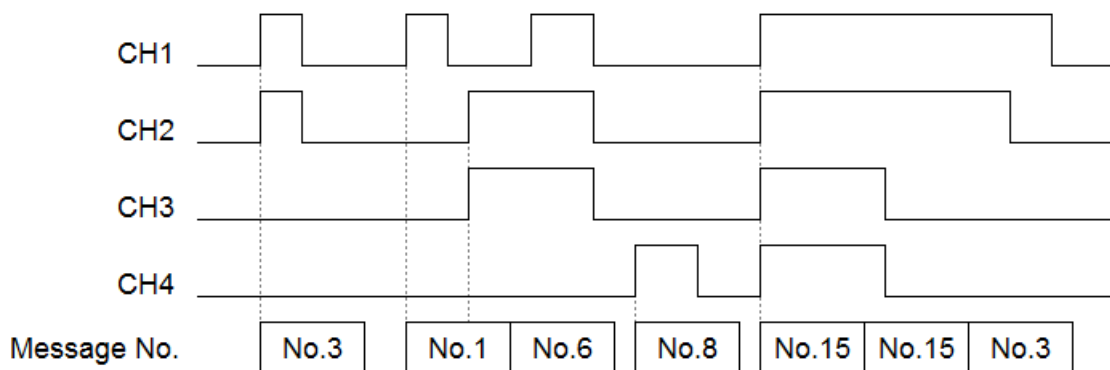

12.4.2. Input Priority Playback Time Chart EHV

Input priority playback stops a message in playback to allow a higher-priority message to play back, then plays the previous message once the priority message is complete. Even with the input held ON, playback is halted at once.

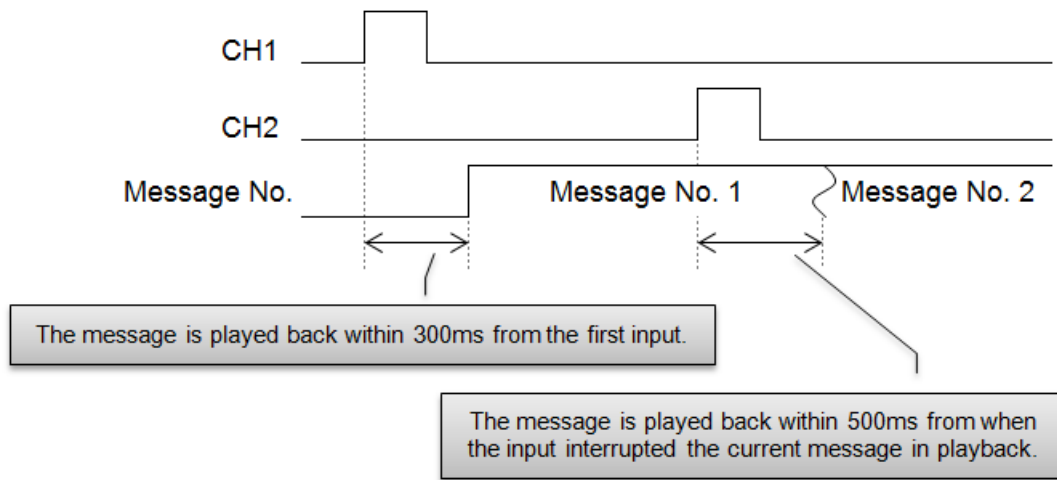

● **Bit Inputs**

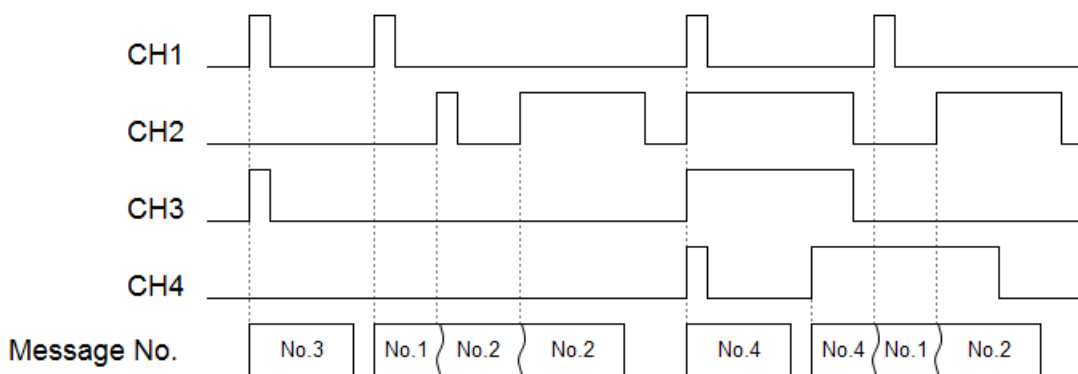

● **Binary Inputs**

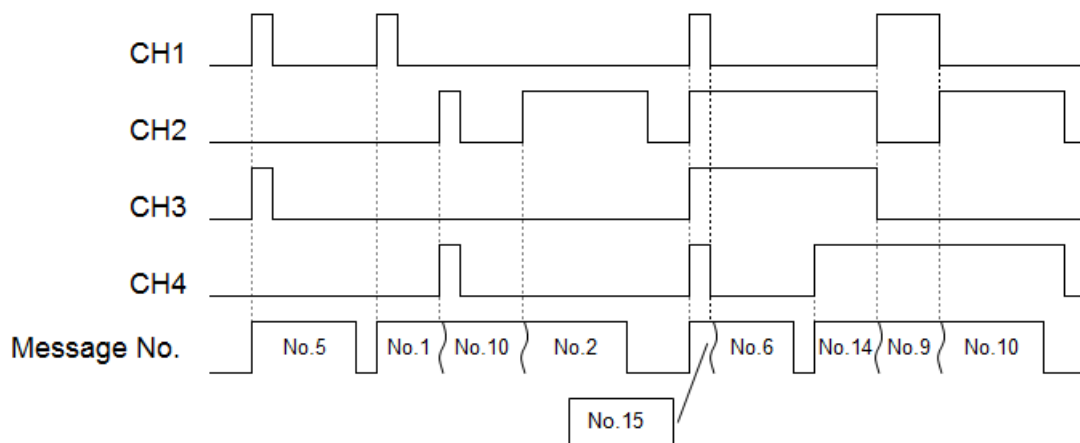

12.4.3. Hold Playback Time Chart EHV

Hold playback will reproduce messages repetitiously as long as the input is held ON. Once the input is removed, playback will be stopped.

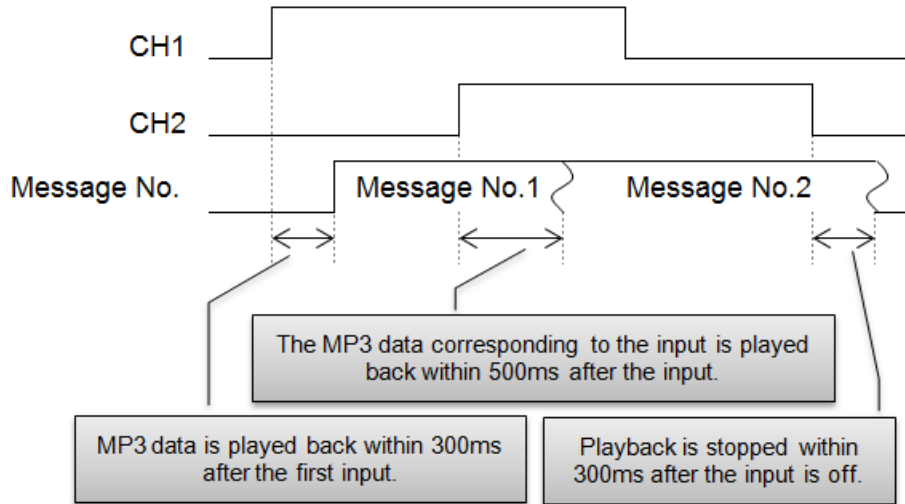

● **Bit Inputs**

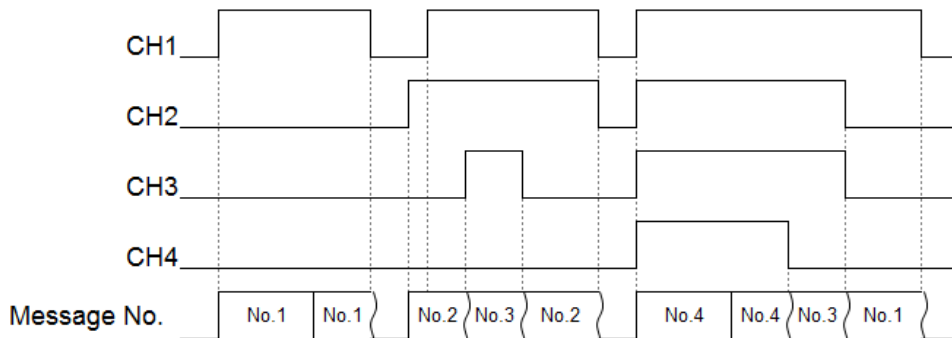

● **Binary Inputs**

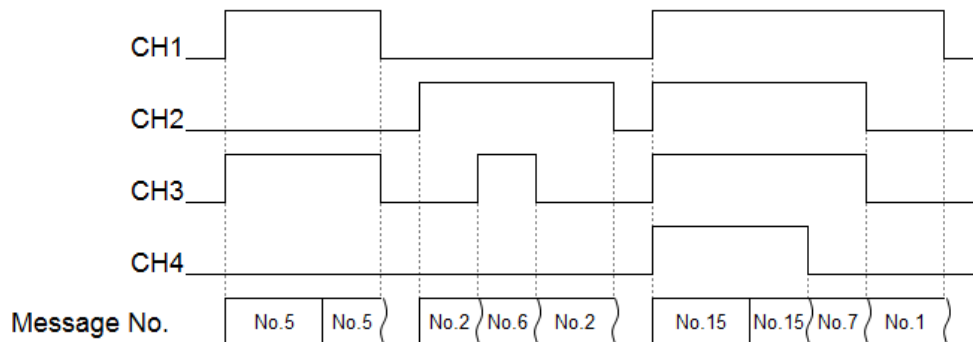

12.4.4. Memory Playback Time Chart EHV

Memory playback retains memory of up to five input signals pertaining to messages while a channel input is in playback. Messages stored in memory will be played back one after the other until the last message in memory was played. Even if an input is held, playback is only played once.

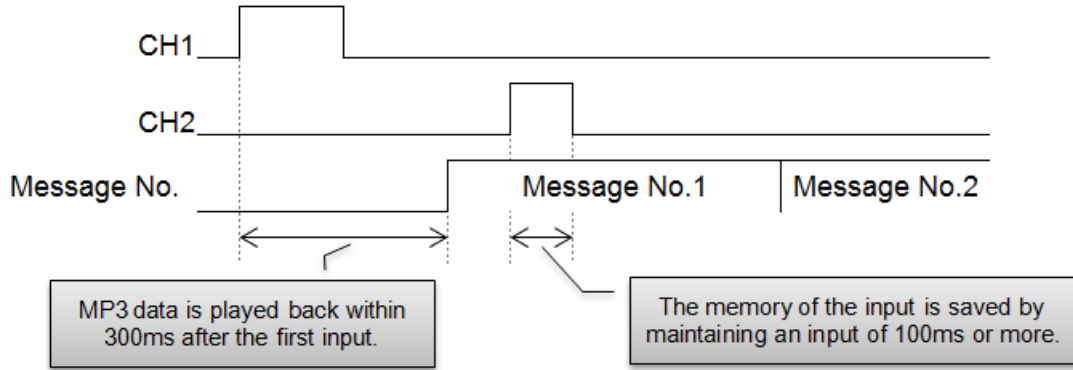

● **Bit Inputs**

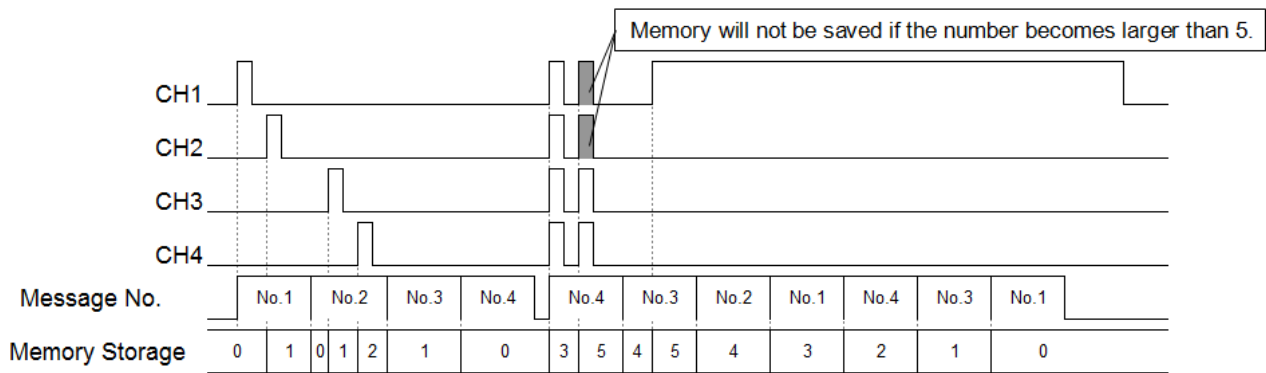

● **Binary Inputs**

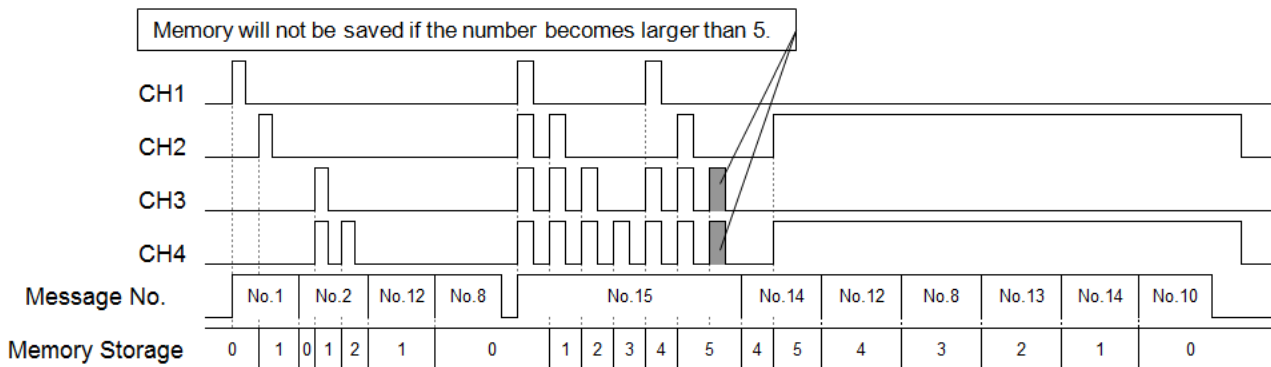

12.5. Channel Function Time Chart EHV

For the EHV model with the "Forced Playback OFF" and "MP3 setting ON", the channel signal line input functions can change the operation. All channels operate within 300ms after a channel signal input is detected.

12.5.1. Playback Function Time Chart EHV

In the assigned channel playback function, the messages corresponding to the signal line is played back.

Refer to page 52 "12.4 Time Chart for different Playback Modes EHV" for the operation in conjunction with assigning playback functions.

12.5.2. Sound Reduction Function Time Chart EHV

With the sound reduction assigned to a channel function, the playback volume is lowered when the assigned signal line input is entered.

● Bit Input / Normal Playback

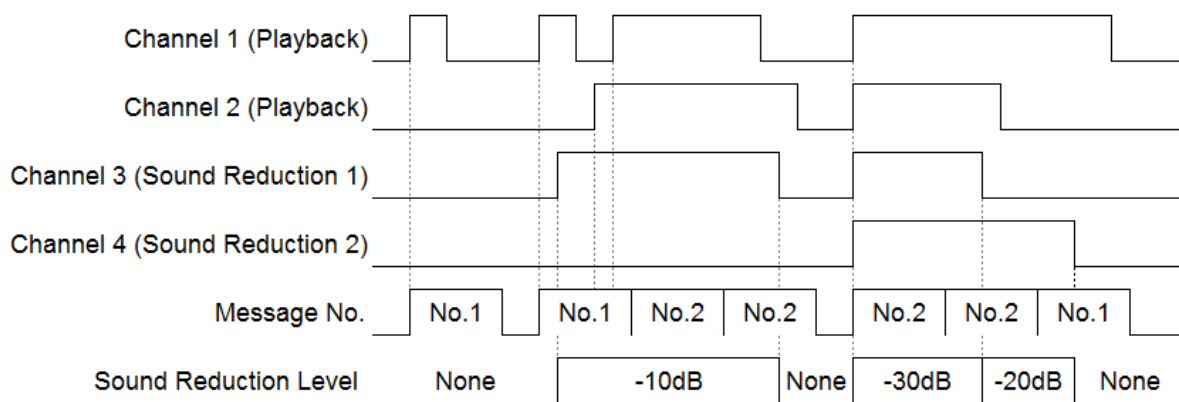

● Binary Input / Normal Playback

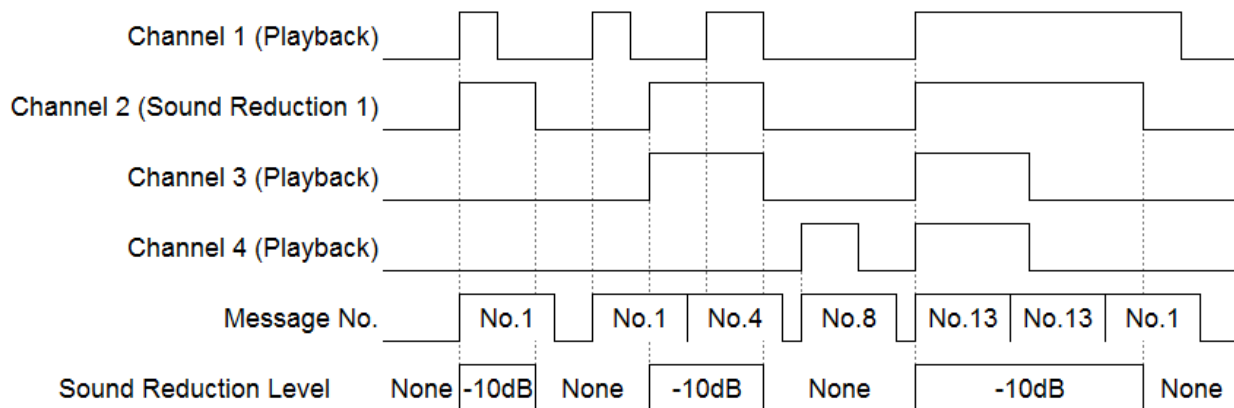

Note

- Refer to page 60 "12.6.2 Forced Playback ON Mode EHV EHS" for the sound reduction function in the "Forced Playback ON" mode.

12.5.3. Stop Function Time Chart EHV

When "Stop" is assigned to channel function, when the signal line assigned to stop is entered during a message playback, the message will be stopped. (The time charts below are examples of the "Stop" functions for every mode)

● Bit Input / Memory Playback

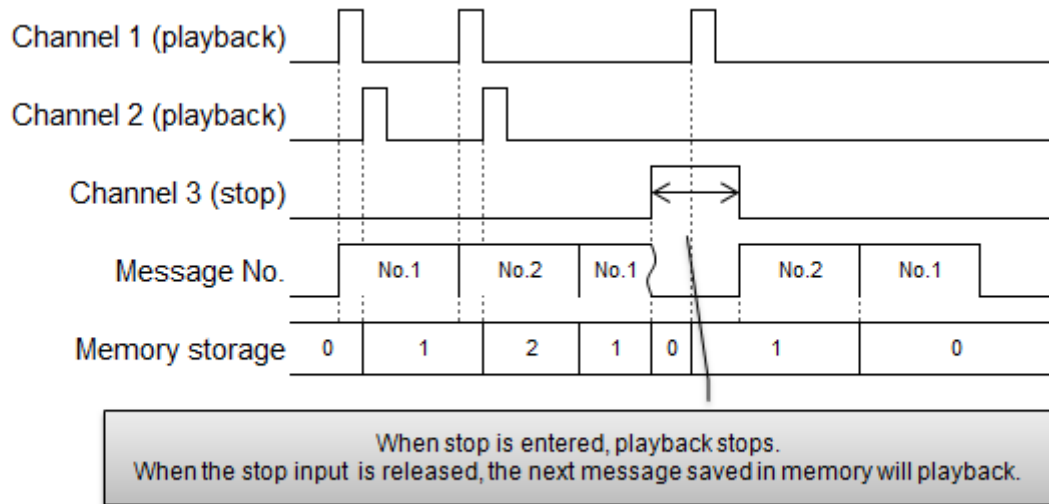

● Binary Input / Normal Playback

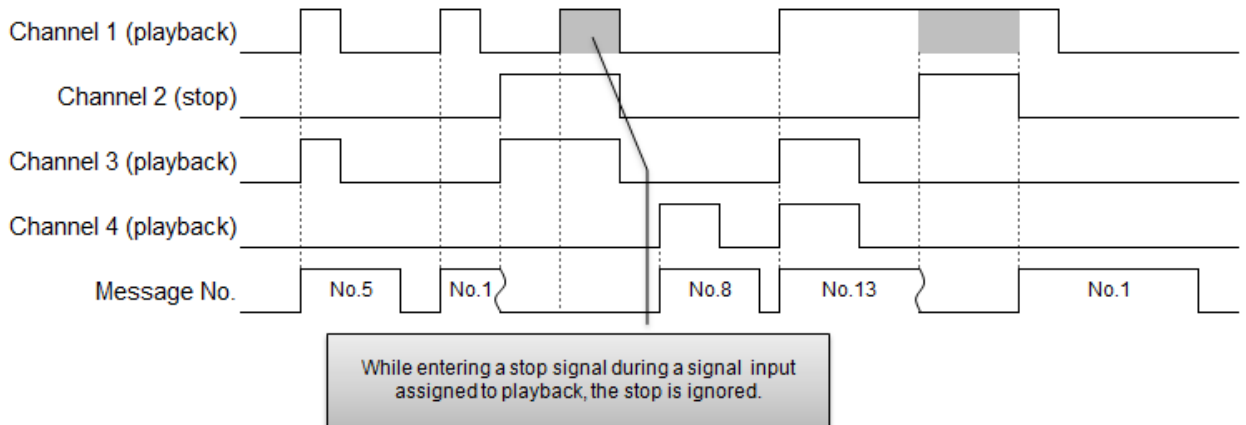

12.5.4. Clear Function Time Chart EHV

When a signal input is entered for the channel function assigned to clear a message, the corresponding message will be stopped. When the playback mode is in memory playback, the message currently played back will be stopped and the memory will be cleared.

● Bit Input / Memory Playback

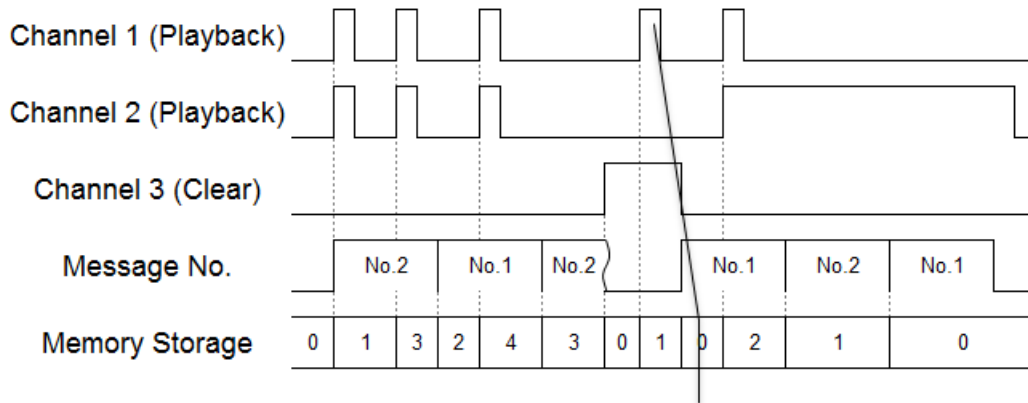

If a signal input assigned to a channel function for playback is entered while the Clear input is entered, the memory will save the message to that channel playback function.

● Binary Input / Memory Playback

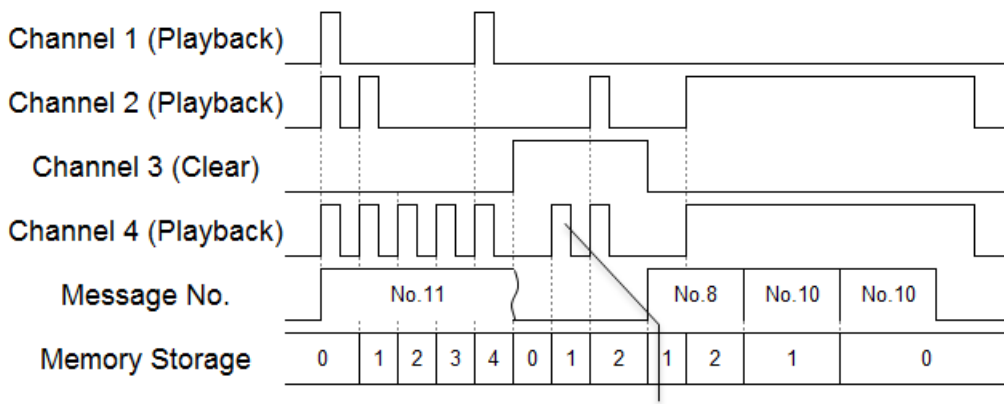

If a signal input assigned to a channel function for playback is entered while the Clear input is entered, the memory will save the message to that channel playback function.

12.6. Sound Reduction Time Chart EHV EHS

The sound reduction function is a function which lowers playback volume with a signal input. Directions for Forced Playback depends on the setup.

12.6.1. Forced Playback OFF Mode EHS

When a signal line input is on channel 8 with the Forced Playback in the OFF mode, the playback volume will decrease. Refer to page 56 "12.5.2 Sound Reduction Function Time Chart EHV" for the sound reduction time chart using the EHV for channel function assignment.

● Bit Inputs

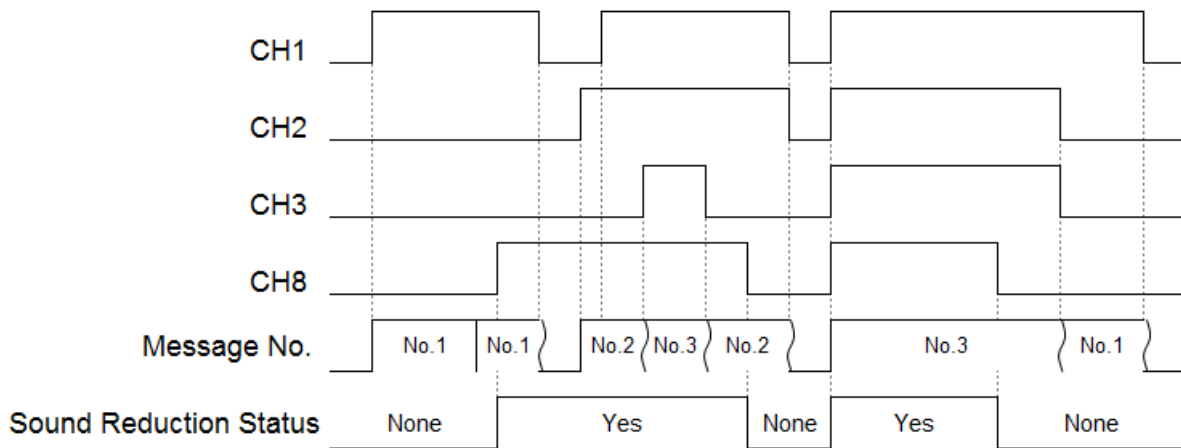

● Binary Inputs

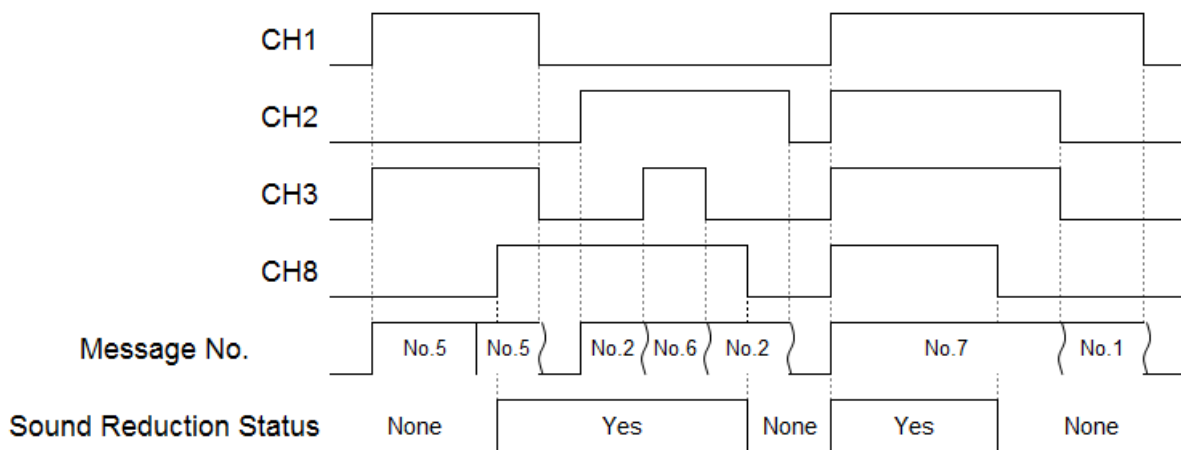

12.6.2. Forced Playback ON Mode EHV EHS

In the Forced Playback ON mode, if channel 1 through 3 signal line inputs are entered, the playback volume will drop.

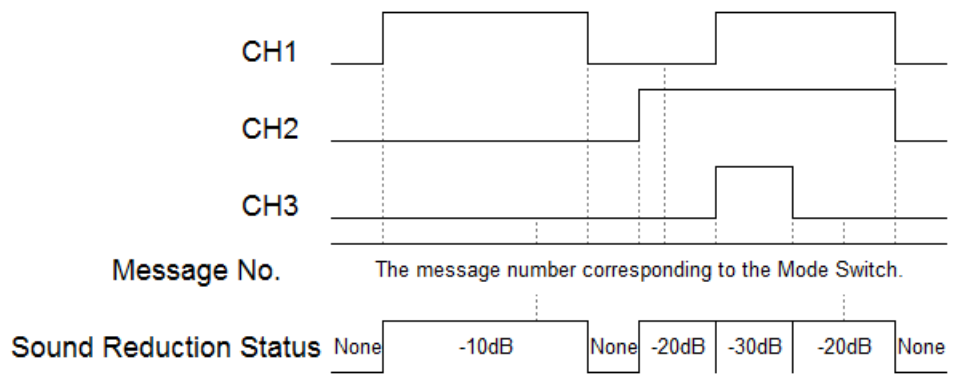

13. Error Alarm EHV EHS

An error will generate an alarm sound. Refer to the following table when an error occurs:

The alarm will sound in accordance to the error occurring.

Error Sound	Error Name	Models Affected		What to do
		EHV	EHS	
3 short consecutive beeps (beepbeep-beepbeep-beep beep-)	Hardware Error	O	X	<ul style="list-style-type: none"> ● SD card may have lost its connection. Reinsert the SD card. ● The contents of the SD card may not have been read. Reformat the SD card using FAT16 or FAT32 and write again. ● Check whether data is properly saved and written on the SD card. (Refer to page 40 "10.2 Data Creation EHV")
3 long consecutive beeps (beep-beep-beep)	Exceeded Memory Size Error	O	X	<ul style="list-style-type: none"> ● The memory capacity for the Playlist Package or MP3 data may be exceeded. Rewrite the MP3 data again within the memory capacity. When using the PATLITE Playlist Editor 2 application when rewriting data, check the bar displaying the memory size activity ratio viewable in the PATLITE Playlist Editor 2.
4 short and 1 long beep (beepbeepbeepbeep beep-)	Hardware Error	X	O	<ul style="list-style-type: none"> ● SD card may have lost its connection. Reinsert the SD card. ● The contents of the SD card may not have been read. Reformat the SD card using FAT16 or FAT32 and write again. ● Check whether data is properly saved and written on the SD card.

14. Binary Conversion Table EHV EHS

When selecting the binary input mode, the input combination will vary with the activation of the Forced Playback mode, in which in the "OFF" mode will play back the corresponding message with a combination of signal line inputs, and with the Forced Playback mode selected, a combination of Mode Switch positions can playback the corresponding message.

The EHV can enter messages from 1-63, the EHS can enter messages from 1-32. Any other inputs will only play message No.1.

Any combination of inputs that are not in the binary conversion mode will only play message No.1. When no input is on a signal line, no message will play back.

● Signal Line Input Binary Conversion Diagram

Message No.	Input Channel								Message No.	Input Channel							
	1	2	3	4	5	6	7	8		1	2	3	4	5	6	7	8
1	0								33	0					0		
2		0							34		0				0		
3	0	0							35	0	0				0		
4			0						36			0			0		
5	0		0						37	0		0			0		
6		0	0						38		0	0			0		
7	0	0	0						39	0	0	0			0		
8				0					40				0		0		
9	0			0					41	0			0		0		
10		0		0					42		0		0		0		
11	0	0		0					43	0	0		0		0		
12			0	0					44			0	0		0		
13	0		0	0					45	0		0	0		0		
14		0	0	0					46		0	0	0		0		
15	0	0	0	0					47	0	0	0	0		0		
16					0				48					0	0		
17	0				0				49	0				0	0		
18		0			0				50		0			0	0		
19	0	0			0				51	0	0			0	0		
20			0		0				52			0		0	0		
21	0		0		0				53	0		0		0	0		
22		0	0		0				54		0	0		0	0		
23	0	0	0		0				55	0	0	0		0	0		
24				0	0				56				0	0	0		
25	0			0	0				57	0			0	0	0		
26		0		0	0				58		0		0	0	0		
27	0	0		0	0				59	0	0		0	0	0		
28			0	0	0				60			0	0	0	0		
29	0		0	0	0				61	0		0	0	0	0		
30		0	0	0	0				62		0	0	0	0	0		
31	0	0	0	0	0				63	0	0	0	0	0	0		
32						0											

O -- Input Channel

Note

- EHV With the MP3 setting ON, if no MP3, alarm or melody message is registered with the channel, nothing is going to be played back.

● **Forced Playback Binary Conversion Diagram**

Message No.	Mode Switch						Message No.	Mode Switch					
	1	2	3	4	5	6		1	2	3	4	5	6
1							33						0
2	0						34	0					0
3		0					35		0				0
4	0	0					36	0	0				0
5			0				37			0			0
6	0		0				38	0		0			0
7		0	0				39		0	0			0
8	0	0	0				40	0	0	0			0
9				0			41				0		0
10	0			0			42	0			0		0
11		0		0			43		0		0		0
12	0	0		0			44	0	0		0		0
13			0	0			45			0	0		0
14	0		0	0			46	0		0	0		0
15		0	0	0			47		0	0	0		0
16	0	0	0	0			48	0	0	0	0		0
17					0		49					0	0
18	0				0		50	0				0	0
19		0			0		51		0			0	0
20	0	0			0		52	0	0			0	0
21			0		0		53			0		0	0
22	0		0		0		54	0		0		0	0
23		0	0		0		55		0	0		0	0
24	0	0	0		0		56	0	0	0		0	0
25				0	0		57				0	0	0
26	0			0	0		58	0			0	0	0
27		0		0	0		59		0		0	0	0
28	0	0		0	0		60	0	0		0	0	0
29			0	0	0		61			0	0	0	0
30	0		0	0	0		62	0		0	0	0	0
31		0	0	0	0		63		0	0	0	0	0
32	0	0	0	0	0								

O -- Mode Switch ON

Note

- If the EHS is used in Forced Playback mode, be sure to keep Mode Switch 6 in the OFF position.

15. Optional Parts EHV EHS

A) SD card (including MP3 voice messages)

[Form :SDV -2GP-□□□]

The number of registration phrases for the requested voice message is entered in the boxes in units of 64.

Number of Phrase Registrations	Model
None	SDV -2GP
1-64	SDV -2GP -064
65-128	SDV -2GP -128
129-192	SDV -2GP -192
-	-
-	-
-	-

※ Special orders on studio recordings will have an extra charge added.

- MP3 data written for the EHV is limited to 2Mb. If it exceeds the limit, an error will occur.
- A request for voice messages can be registered on the SD card and shipped.
- A maximum of 16 phrases can be registered for each playback channel.
- Depending on the allowable data, MP3 conversion and registration is also accepted. However, recording from works, such as CD requires an author's permission (certificate of JASRAC, etc.).

B) Voice Rewriting Tool (Free Version)

[PATLITE Playlist Editor 2]

This is a newer version of the PATLITE Playlist Editor.

(Supported OS: Windows[®] XP, Windows Vista[®] 32 bit/64 bit, Windows[®]7 32 bit/64 bit and Windows[®]8 32 bit/64 bit)

- Beware that the EHV cannot use the PATLITE Playlist Editor, so it is recommended to use the PATLITE Playlist Editor 2.
- Download URL: <http://www.patlite.com/oto/index0910.html>

16. Replacement Parts EHV EHS

Several kinds of parts are available for the customer to change or replace.

Part Name	Part Number
Cable	V13100076-F1
Cover	V21100522-F1

17. Before Requesting Repair EHV EHS

Be sure to review the troubleshooting list on the "What to do" for the model before requesting repair. Even after proper installation, if it does not operate, please contact your nearest PATLITE Sales Representative or contact us with the information found on the last page of this book.

Problem	Mode Affected		What to do
	EHV	EHS	
No Sound	○	○	<ul style="list-style-type: none"> ● Check whether the source line polarity is correct, or the voltage tolerance is within range. (Refer to page 21 "7 Wiring EHV EHS") ● Check whether the signal line input is wired correctly. (Refer to page 21 "7 Wiring EHV EHS") ● Check the volume. (Refer to page 25 "8.1 Volume Adjustment EHV EHS")
	○	✕	<ul style="list-style-type: none"> ● Check whether the appropriate playback mode is set up correctly. (Refer to page 32 "9.4 Playback Mode EHV") ● Check whether there is any input held on the "stop" or "clear" signal lines. (Refer to page 36 "9.8 Assigning Channel Functions EHV") ● Check whether the channel function assignment was set up as something other than playback by the PATLITE Playlist Editor 2. (Refer to page 36 "9.8 Assigning Channel Functions EHV") ● Check whether the contents of the SD card is correct. (Refer to page 39 "10 Data Rewriting EHV") ● Check whether MP3 tags were attached to the MP3 data. (Refer to page 41 "10.2.2 When not using PATLITE Playlist Editor 2 EHV")
A different message is played back.	○	○	<ul style="list-style-type: none"> ● Check whether the signal line input is wired correctly. (Refer to page 21 "7 Wiring EHV EHS") ● Check whether the expected channel input is correct. (Refer to page 62 "14 Binary Conversion Table EHV EHS") ● Check whether the Mode Switch is set correctly. (Refer to page 30 "9.2 Sound Group EHV EHS" and page 31 "9.3 Channel Input Method EHV EHS")
	○	✕	<ul style="list-style-type: none"> ● Check whether the contents of the SD card is correct. (Refer to page 39 "10 Data Rewriting EHV") ● Check whether the Mode Switch is set correctly. (Refer to page 32 "9.4 Playback Mode EHV" and page 34 "9.6 MP3 Setup EHV") ● Check whether the channel function assignment was set up as something other than playback by the PATLITE Playlist Editor 2. (Refer to page 36 "9.8 Assigning Channel Functions EHV")
	✕	○	<ul style="list-style-type: none"> ● Check whether the contents of the SD card is correct. (Refer to page 44 "11 Sound Combination Method EHS")
Sound is small.	○	○	<ul style="list-style-type: none"> ● Check whether the sound reduction function is active and whether an input is on the sound reduction signal line. (Refer to page 26 "8.2 Sound Reduction Function EHV EHS") ● Check the volume. (-> Refer to page 25 "8.1 Volume Adjustment EHV EHS")
	○	✕	<ul style="list-style-type: none"> ● Check whether the contents of the SD card is correct. (Refer to page 39 "10 Data Rewriting EHV") ● Check the loudness of the MP3 data sound level. Refer to the technical book for the editing/confirmation method of the MP3 data.
Could not rewrite the MP3 data.	○	✕	<ul style="list-style-type: none"> ● Check whether the contents of the SD card is correct. (Refer to page 39 "10 Data Rewriting EHV") ● Check whether data size exceeded 2 MB. ● Check that the SD card format is for FAT16 or FAT32.

No sound combination is made.	X	O	<ul style="list-style-type: none"> ● Check whether the contents of the SD card is correct. (Refer to page 44 "11 Sound Combination Method (EHS)") ● Check that the SD card format is for FAT16 or FAT32.
Sound reduction does not activate. Sound reduction does not become inactive.	O	X	<ul style="list-style-type: none"> ● Check whether the contents of the SD card is correct. (Refer to page 39 "10 Data Rewriting (EHV)") ● Check that the SD card format is for FAT16 or FAT32. ● Check that the sound reduction function is assigned to the correct signal line. (Refer to page 26 "8.2 Sound Reduction Function (EHV (EHS))")
	X	O	<ul style="list-style-type: none"> ● Check whether the Mode Switch is set correctly. (Refer to page 26 "8.2 Sound Reduction Function (EHV (EHS))")
The playback mode does not operate as designated.	O	X	<ul style="list-style-type: none"> ● Check whether the Mode Switch is set correctly. (Refer to page 32 "9.4 Playback Mode (EHV)")
SD card is not being read.	O	O	<ul style="list-style-type: none"> ● Check that the SD card format is for FAT16 or FAT32. ● It is not read, even the SD card specified by Patlite.
MP3 data is not being reproduced correctly.	O	X	<ul style="list-style-type: none"> ● Check the bit rate and sampling frequency of the MP3 data. ● Check whether MP3 tags were attached to the MP3 data. (Refer to page 41 "10.2.2 When not using PATLITE Playlist Editor 2 (EHV)")

18. Specifications EHV EHS

18.1. Common Specifications EHV EHS

Model	EH□-M1		EH□-M2	
Rated Voltage	DC12 V-DC24 V		AC100 V-AC240 V (50/60 Hz)	
Operating Voltage Range	DC10.8 V-DC35 V		AC90 V-AC264 V (50/60 Hz)	
Operating Ambient Temperature	-20 °C--+50 °C			
Operating Humidity Range	85%RH or less, no condensation			
Storage Temperature Range	-30 °C--+60 °C			
Storage Humidity Range	85%RH or less, no condensation			
Mounting Location	Indoor and Outdoor			
Mounting Direction	Upright, Sideways, Upside-down (Direct the horn in a downward direction when installing)			
Protection Rating	IP65 (IEC 60529) Conditions: Upright Installation			
Insulation Resistance	More than 1MΩ at 500VDC between the terminals and the chassis			
Withstand Voltage	AC 500V for 1 minute between power terminal and non-conductive metal part		AC1500V for 1 minute between power terminal and non-conductive metal part	
Vibration Resistance	45.0m/s ² (the 30-Hz up-and-down direction, a horizontal direction, the direction of sequence 2h each)			
Impact Resistance	250m/s ² 6ms 1000 times (one direction each of 3 axis), 500m/s ² 11ms 3 times (both directions each of 3 axis) IEC 60068-2-27:2008 (Upright Position)			
Mass (Tolerance±10%)	1.25 kg			
Sound Level	Alarm	Maximum: 110 dB (1m distance from the front and "Stutter" alarm played back)		
	MP3 EHV	Maximum: 105 dB (1m distance from the front and a 1 kHz at -6dB sine wave played back)		
SD Card Format	FAT16 / FAT32			
Data Rewriting	SD/SDHC Card (Recommended SD Card: SDV-2GP Option)			
Compliance Standards	EMC Directive (EN 61000-6-4, EN 61000-6-2) (EH□-M1 Only) RoHS Directive (EN 50581) (EH□-M1 Only) UL 464, CSA-C22.2 No. 205-M1983 (EH□-M1, EH□-M2) FCC Part15 SubpartB Class A (EH□-M1, EH□-M2) KC (KN22, KN24) (EH□-M1, EH□-M2)			
Remarks	UL Listed (File No.S24210) (EH□-M1, EH□-M2) There are no contents of controlled substances exceeding the threshold for the RoHS Directive. (EH□-M2)			

18.2. Specific Model Specifications EHV EHS

Model	EHV-□□□□ EHV	EHS-□□□ EHS
-------	--	---

Rated Power Consumption (Standard)	- Non-voltage Contact (NPN) <table border="1" style="width: 100%;"> <tr><td>EHV-M1</td><td>4.0 W (DC12 V)</td></tr> <tr><td>EHV-M2</td><td>5.3 W (AC240 V)</td></tr> </table>	EHV-M1	4.0 W (DC12 V)	EHV-M2	5.3 W (AC240 V)	- Non-voltage Contact (NPN) <table border="1" style="width: 100%;"> <tr><td>EHS-M1</td><td>5.0 W (DC12 V)</td></tr> <tr><td>EHS-M2</td><td>6.9 W (AC240 V)</td></tr> </table>	EHS-M1	5.0 W (DC12 V)	EHS-M2	6.9 W (AC240 V)
	EHV-M1	4.0 W (DC12 V)								
EHV-M2	5.3 W (AC240 V)									
EHS-M1	5.0 W (DC12 V)									
EHS-M2	6.9 W (AC240 V)									
	- Voltage Contact (PNP) <table border="1" style="width: 100%;"> <tr><td>EHV-M1</td><td>5.0 W (DC24 V)</td></tr> </table>	EHV-M1	5.0 W (DC24 V)	- Voltage Contact (PNP) <table border="1" style="width: 100%;"> <tr><td>EHS-M1</td><td>5.9 W (DC24 V)</td></tr> </table>	EHS-M1	5.9 W (DC24 V)				
EHV-M1	5.0 W (DC24 V)									
EHS-M1	5.9 W (DC24 V)									
	Volume at maximum and a 1 kHz at -6dB sinusoidal wave played back	Volume at maximum and "Rapid Hi Lo" alarm in playback								
Rated Power Consumption (Maximum)	- Non-voltage Contact (NPN) <table border="1" style="width: 100%;"> <tr><td>EHV-M1</td><td>5.8 W (DC12 V)</td></tr> <tr><td>EHV-M2</td><td>7.9 W (AC264 V)</td></tr> </table>	EHV-M1	5.8 W (DC12 V)	EHV-M2	7.9 W (AC264 V)	- Non-voltage Contact (NPN) <table border="1" style="width: 100%;"> <tr><td>EHS-M1</td><td>5.2 W (DC12 V)</td></tr> <tr><td>EHS-M2</td><td>7.3 W (AC264 V)</td></tr> </table>	EHS-M1	5.2 W (DC12 V)	EHS-M2	7.3 W (AC264 V)
	EHV-M1	5.8 W (DC12 V)								
EHV-M2	7.9 W (AC264 V)									
EHS-M1	5.2 W (DC12 V)									
EHS-M2	7.3 W (AC264 V)									
	- Voltage Contact (PNP) <table border="1" style="width: 100%;"> <tr><td>EHV-M1</td><td>8.0 W (DC31.6 V)</td></tr> </table>	EHV-M1	8.0 W (DC31.6 V)	- Voltage Contact (PNP) <table border="1" style="width: 100%;"> <tr><td>EHS-M1</td><td>7.6 W (DC31.6 V)</td></tr> </table>	EHS-M1	7.6 W (DC31.6 V)				
EHV-M1	8.0 W (DC31.6 V)									
EHS-M1	7.6 W (DC31.6 V)									
	Volume at maximum and "Rapid Hi Lo" alarm in playback									
Volume Control	Volume Adjustment: Minimum to Maximum									
	<p>Sound-reduction Input: Specifies the decrease in sound volume. (None, -10 dB, -20 dB, -30 dB selection)</p> <ul style="list-style-type: none"> Depending on the Mode Switch, it may be unusable. Refer to page 26 "8.2 Sound Reduction Function EHV EHS". 	<p>Sound-reduction Input: Specifies the decrease in sound volume. (None, -10 dB, -20 dB, -30 dB selection)</p>								
Sound Playback	MP3 data /Alarm melody (Fixed) <ul style="list-style-type: none"> Only an alarm melody is at the time of the MP3 setup OFF. 	Alarm/Melody (Fixed)								
Number of Playback Channels	Bit Input: 8 / Binary Input: 63	Bit Input: 8 / Binary Input: 32								
Playback start-up time	300ms or less (signal input / power supply start-up)									
Playback Mode	<p>Normal playback /Input priority playback / Hold playback /Memory Playback</p> <ul style="list-style-type: none"> Hold Playback mode at the time of MP3 setting OFF. Selection done with Mode Switch. 	Hold Playback								

18.3. Signal input specification EHV EHS

Model	All Models	
Signal Input Priority	Channel 8 > Channel 7 > Channel 6 > Channel 5 > Channel 4 > Channel 3 > Channel 2 > Channel 1 (except for Binary Input)	
Contact Control Method	[EH□-M1]: Non-voltage/Voltage Contact [EH□-M2/EH□-M3]: Non-voltage Contact	
Contact Closed-Circuit Current	12mA or less	
Contact Open-Circuit Voltage	【EH□-M1】 : 6V or less 【EH□-M2/EH□-M3】 : 8V or less	
Contact Input (Circuit Configuration)	Non-voltage Contact	Voltage Contact (EH□-M1 Only)
Transistor Input (Circuit Configuration)	NPN Transistor	PNP Transistor (EH□-M1 Only)

18.4. MP3 Specifications EHV

Model	EHV-□□□□
Playback File	MPEG1-Audio Layer III (MP3, Fs:44.1kHz)
Bit Rate	32 Kbit/s, 64 Kbit/s (Standard), and 128 Kbit/s Constant Bit Rate (CBR) Only
Maximum Playback Time	A total of 220 seconds (at the standard bit rate and continuous MP3 file playback)
Internal Memory Size	2 MByte (Including Management Territory)
Remarks	※ Joint Stereo and Dual Channel not available. ※ The sample rate, it can use only 44.1KHz.

18.5. Outside Dimensions EHV EHS

[Unit: mm]

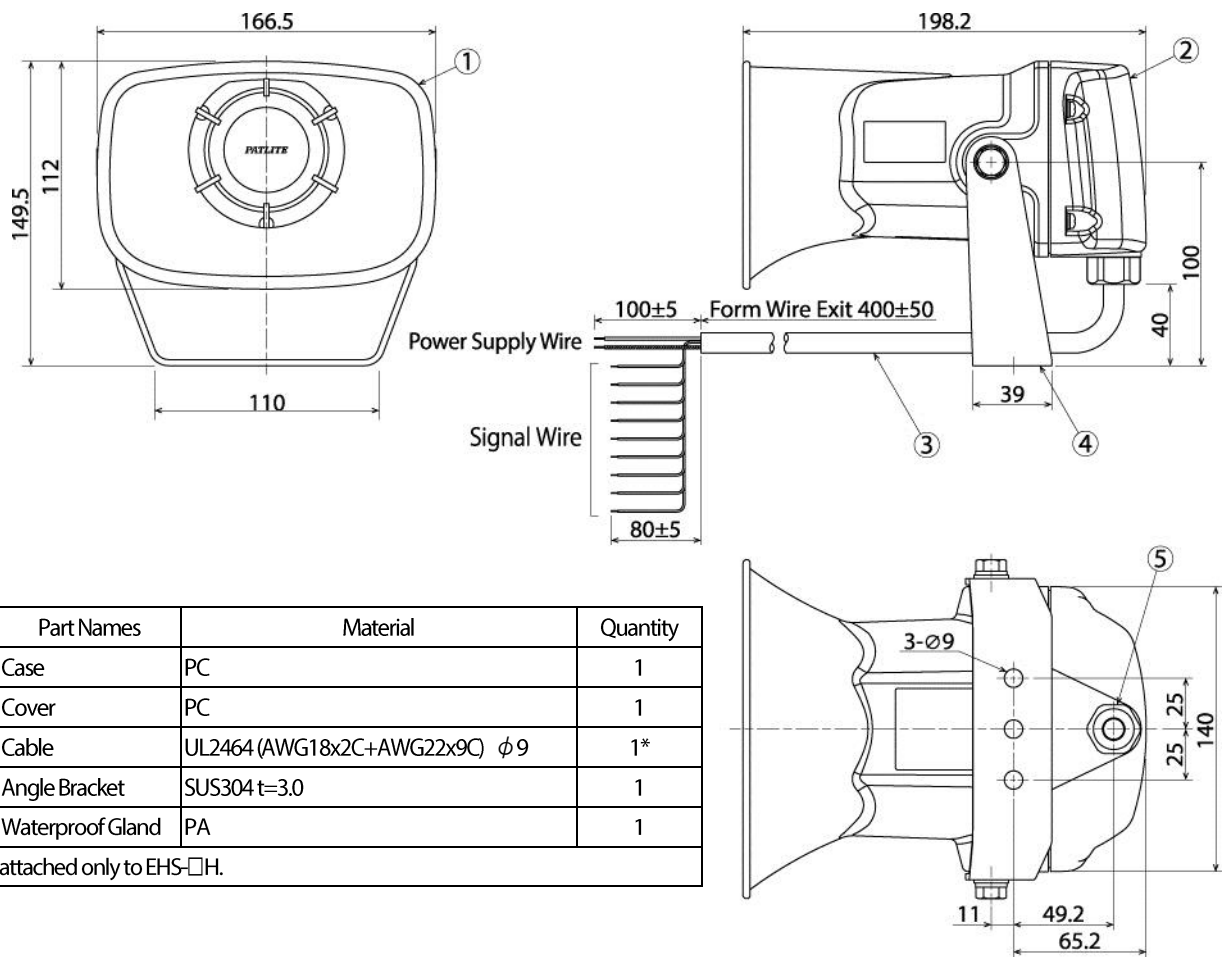

No.	Part Names	Material	Quantity
1	Case	PC	1
2	Cover	PC	1
3	Cable	UL2464 (AWG18x2C+AWG22x9C) ϕ 9	1*
4	Angle Bracket	SUS304 t=3.0	1
5	Waterproof Gland	PA	1

* (3) is attached only to EHS-□H.

Specifications may change without prior notice.

19. Sound List EHV EHS

19.1. Type A EHS

01	Beep	08	Synthesized Bell	15	Minuet in Gmjr	22	Village Blacksmith	29	Spanish Romance
02	Stutter	09	Stutter + Bell	16	Annie Laurie	23	On the Avignon Bridge	30	Katysusha
03	Bell	10	Synthesized Melody	17	London Bridge is falling down	24	Daydream Believer	31	Grandfather's Clock
04	Yelp	11	Chime	18	Hol-Di-Li-Dia	25	Amaryllis	32	Ave Maria
05	Rapid Hi-Lo	12	Call Sign	19	Mary had a little Lamb	26	Mozart Symphony No.40		
06	Melody Chime	13	Fur Elise	20	Camptown Races	27	Quiet Lakeside		
07	Synthesized Piano	14	A Maiden's Prayer	21	Cuckoo	28	Mountain Musician		



CH	Group A	Group B	Group C	Group D	Group E	Group F	Group G	Group H	Use an SD Card to freely select a melody. Group A is the default setting upon factory shipment.
CH1	Fur Elise	Mary had a little Lamb	Amaryllis	Grandfather's Clock	Spanish Romance	Mary had a little Lamb	Beep		
CH2	Maiden's Prayer	Camptown Races	Symphony No.40	Ave Maria	Camptown Races	Symphony No.40	Stutter		
CH3	Minuet in Gmaj	Cuckoo	Quiet Lakeside	Daydream Believer	Minuet in Gmaj	Hol-Di-Li-Dia	Bell		
CH4	Annie Laurie	Village Blacksmith	Mountain Musician	London Bridge is falling down	Ave Maria	Daydream Believer	Yelp		
CH5	London Bridge is falling down	On the Avignon Bridge	Spanish Romance	Bell	Stutter + Bell	Rapid Hi-Lo	Rapid Hi-Lo		
CH6	Hol-Di-Li-Dia	Daydream Believer	Katysusha	Yelp	Synthesized Melody	Melody Chime	Melody Chime		
CH7	Chime	Chime	Chime	Synthesized Piano	Synthesized Piano	Synthesized Piano	Synthesized Piano		
CH8	Call Sign	Call Sign	Call Sign	Synthesized Bell	Synthesized Bell	Synthesized Bell	Synthesized Bell		

Author 13:LUDWIG VAN BEETHOVEN 14:BADARZEWSKA BARANOWSKA TEKLA 15:BACH JOHANN SEBASTIAN 16:SCOTT LADY JOHN DOUGLAS 17,18,21,25,28,29:TRADITIONAL 19,27:PD 20:FOSTER STEPHEN COLLINS 22:MEXT JAPAN SONG 23:WERNER HEINRICH (DE 2) 24:STEWART JOHN C 26:MOZART WOLFGANG AMADEUS 30:BLANTER MATVEJ ISAAKOVICH 31:WORK HENRY CLAY 32:SCHUBERT FRANZ ※24,30  T-06B0152

19.2. Type C EHS

01	Beep	08	Synthesized Bell	15	The Entertainer	22	Oshiete	29	Guts Daze!!
02	Stutter	09	Stutter + Bell	16	Amazing Grace	23	Makenai de	30	Odoru Ponpokorin
03	Bell	10	Synthesized Melody	17	Maiden with the flaxen hair	24	"Rocky" Theme Song	31	Ima sugu Kiss Me
04	Yelp	11	Chime	18	Aux Champs-Elysees	25	I Don't Want to Miss a Thing	32	Haru yo, Koi
05	Rapid Hi-Lo	12	Call Sign	19	Canon	26	Yozora no Mukou		
06	Melody Chime	13	Can't take my eyes off of You	20	La-la Sunshine	27	Ai wa Katsu		
07	Synthesized Piano	14	Top of the World	21	Space Battleship Yamato	28	Truth		

CH	Group A	Group B	Group C	Group D	Group E	Group F	Group G	Group H	Use an SD Card to freely select a melody. Group A is the default setting upon factory shipment.
CH1	Can't take my eyes off of You	Canon	I Don't Want to Miss a Thing	Ima sugu Kiss Me	Maiden with the flaxen hair	Beep	Odoru Ponpokorin		
CH2	Top of the World	La-la Sunshine	Yozora no Mukou	Haru yo, Koi	Makenai de	Stutter	Ai wa Katsu		
CH3	The Entertainer	Space Battleship Yamato	Ai wa Katsu	Space Battleship Yamato	Guts Daze!!	Stutter + Bell	Truth		
CH4	Amazing Grace	Oshiete	Truth	La-la Sunshine	Top of the World	Synthesized Melody	Aux Champs-Elysees		
CH5	Maiden with the flaxen hair	Makenai de	Guts Daze!!	Can't take my eyes off of You	Canon	Synthesized Piano	Amazing Grace		
CH6	Aux Champs-Elysees	"Rocky" Theme Song	Odoru Ponpokorin	"Rocky" Theme Song	Haru yo, Koi	Synthesized Bell	Yozora no Mukou		
CH7	Chime	Chime	Chime	Chime	Chime	Chime	Chime		
CH8	Call Sign	Call Sign	Call Sign	Call Sign	Call Sign	Call Sign	Call Sign		

Author 13:CREWE BOB 14:CARPENTER RICHARD LYNN 15:JOPLIN SCOTT 16:CARRELL JAMES P 17:Kouichi Sugiyama 18:WILSHAW MICHAEL 19:PACHELBEL JOHANN 20:Jjichi Hiromasa 21:Hiroshi Miyagawa 22:Takeo Watanabe 23,30:Tetsuro Oda 24:CONTI BILL 25:WARREN DJANE EVE 26:Yuka Kawamura 27:KAN 28:Masahiro Andoh 29:Totatsu Matsumoto 31:Tatsuya Hirakawa 32:Yumi Matsuyota ※13~14, 17~18, 20~31  T-0710139 ※32 

19.3. Type D EHS

01	Beep	08	Synthesized Bell	15	Douyobi no Koibito	22	The Bear Song	29	Yellow Rose of Texas
02	Stutter	09	Chime	16	Aki no Kihai	23	Toys Go Cha-Cha-Cha	30	Yankee Doodle
03	Bell	10	Call Sign	17	Surf Tengoku, Ski Tengoku	24	Konnako Irukana	31	When the Saints Go Marching In
04	Yelp	11	Runner	18	Iro, White Blend	25	Shubert's Lullaby	32	Londonderry Aire
05	Rapid Hi-Lo	12	Mamotte Agetai	19	Happy Birthday	26	Rudolph the Red-nosed Reindeer		
06	Melody Chime	13	While listening to Olivia	20	Hi Ho	27	She Wore a Yellow Ribbon		
07	Synthesized Piano	14	September	21	I've been working on the Railroad	28	My Darling Clementine		

CH	Group A	Group B	Group C	Group D	Group E	Group F	Group G	Group H
CH1	Runner	Happy Birthday	She Wore a Yellow Ribbon	Yellow Rose of Texas	Runner	Surf Tengoku, Ski Tengoku	Douyobi no Koibito	Use an SD Card to freely select a melody. Group A is the default setting upon factory shipment.
CH2	Mamotte Agetai	Hi Ho	My Darling Clementine	Yankee Doodle	Iro, White Blend	Konnako Irukana	I've been working on the Railroad	
CH3	While listening to Olivia	I've been working on the Railroad	Yellow Rose of Texas	When the Saints Go Marching In	Shubert's Lullaby	While listening to Olivia	She Wore a Yellow Ribbon	
CH4	September	The Bear Song	Yankee Doodle	Londonderry Aire	Hi Ho	Rudolph the Red-nosed Reindeer	Yankee Doodle	
CH5	Douyobi no Koibito	Toys Go Cha-Cha-Cha	When the Saints Go Marching In	Beep	Bell	Rapid Hi-Lo	Synthesized Piano	
CH6	Aki no Kihai	Konnako Irukana	Londonderry Aire	Stutter	Yelp	Melody Chime	Synthesized Bell	
CH7	Surf Tengoku, Ski Tengoku	Shubert's Lullaby	Runner	Chime	Chime	Chime	Chime	
CH8	Iro, White Blend	Rudolph the Red-nosed Reindeer	Mamotte Agetai	Call Sign	Call Sign	Call Sign	Call Sign	

Author 11:New Funky Sueyoshi 12:Yumi Matsutoya 13:Ami Ozaki 14:Tetsuji Hayashi 15:Tatsuro Yamashita 16:Kazumasa Oda
 17:Yumi Matsutoya 18:Maria Takeuchi 19:HILL MILDRED J 20:CHURCHILL FRANK E
 21·22·27·29·30·31·32:TRADITIONAL 23:Nobuyoshi Koshibe 24:Takeishi Shibuya 25:SCHUBERT FRANZ
 26:MARKS JOHN D 28:American folk song

※11,13~18, 23~24,26  T-0710140

※12  Nextone

19.4. Type E EHS



01	Beep	08	Synthesized Bell	15	Alien Chatter	22	Ringin Hi-Lo	29	Amaryllis
02	Stutter	09	Stutter + Bell	16	Falling Crystals	23	Fur Elise	30	Symphony No.40
03	Bell	10	Synthesized Melody	17	Inverted Revellie	24	Minuet in Gmaj	31	Ave Maria
04	Yelp	11	Chime	18	Galactic Motor	25	Annie Laurie	32	Grandfather's Clock
05	Rapid Hi-Lo	12	Call Sign	19	Ringin Phone	26	London Bridge is falling down		
06	Melody Chime	13	Train Ride	20	Two Tone	27	Mary had a little Lamb		
07	Synthesized Piano	14	Galloping Hi-Lo	21	Alarm Clock	28	Camptown Races		

CH	Group A	Group B	Group C	Group D	Group E	Group F	Group G	Group H
CH1	Fur Elise	Minuet in Gmaj	Fur Elise	Alien Chatter	Train Ride	Rapid Hi-Lo	Beep	Use an SD Card to freely select a melody. Group A is the default setting upon factory shipment.
CH2	Minuet in Gmaj	Annie Laurie	London Bridge is falling down	Falling Crystals	Galloping Hi-Lo	Chime	Stutter	
CH3	Annie Laurie	Amaryllis	Mary had a little Lamb	Inverted Revellie	Inverted Revellie	Stutter	Bell	
CH4	London Bridge is falling down	Symphony No.40	Camptown Races	Galactic Motor	Galactic Motor	Ringin Phone	Yelp	
CH5	Mary had a little Lamb	Grandfather's Clock	Amaryllis	Ringin Phone	Alarm Clock	Stutter + Bell	Rapid Hi-Lo	
CH6	Camptown Races	Ave Maria	Grandfather's Clock	Two Tone	Ringin Hi-Lo	Synthesized Melody	Melody Chime	
CH7	Chime	Chime	Chime	Alarm Clock	Synthesized Piano	Synthesized Piano	Synthesized Piano	
CH8	Call Sign	Call Sign	Call Sign	Ringin Hi-Lo	Synthesized Bell	Synthesized Bell	Synthesized Bell	

Author 23:LUDWIG VAN BEETHOVEN 24:BACH JOHANN SEBASTIAN 25:SCOTT LADY JOHN DOUGLAS
 26,29:TRADITIONAL 27:PD 28:FOSTER STEPHEN COLLINS 26:MOZART WOLFGANG AMADEUS 31:SCHUBERT FRANZ 32:WORK HENRY CLAY

19.5. Type F EHV

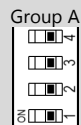
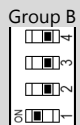
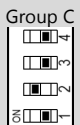
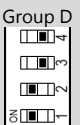
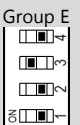
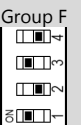
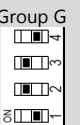
01	Beep	14	Game Intermission	27	A Maiden's Prayer	40	Quiet Lakeside	53	BANZAI SUKIDE YOKATTA
02	Stutter	15	Spring Melody	28	Minuet in Gmjr	41	Mountain Musician	54	NAMONAKI UTA
03	Bell	16	Jalopy Horn	29	Annie Laurie	42	Spanish Romance	55	Genesis of Aquarion
04	Yelp	17	ET Doorbell	30	London bridge is falling down	43	Katyusha	56	MAMBO NO 5
05	Rapid Hi-Lo	18	RR-crossing	31	Holdiridia	44	Ave Maria	57	The Parade of the Tin Soldiers
06	Melody Chime	19	Train Whistle	32	Mary had a little Lamb	45	Grandfather's Clock	58	Turkey in the Straw
07	Synthesized Piano	20	Train Ride	33	Camptown Races	46	RHYTHM AND POLICE	59	Aka tombo
08	Synthesized Bell	21	Starting Notice Chime1	34	Cuckoo Song	47	ZANKOKUNA TENSHINO TEEZE	60	Funiculi, Funicula
09	Stutter + Bell	22	Starting Notice Chime2	35	Village Blacksmith	48	MAJINGAA ZETTO	61	Furusato
10	Melody Chime	23	Starting Notice Chime3	36	On the Avignon Bridge	49	HATARAKU KURUMA	62	Beautiful Dreamer
11	Chime	24	Ending Notice Chime1	37	Daydream Believer	50	NINGENTTE IINA	63	JOLLY HOLIDAY
12	Call sign	25	Ending Notice Chime2	38	Amaryllis	51	ROBINSON		
13	Galactic Hovercraft	26	Fur Elise	39	Mozart Symphony No.40	52	WORLD FOOTBALL ANTHEM		

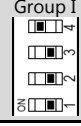
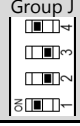
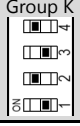
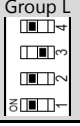
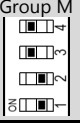
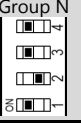
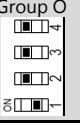
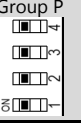
CH	Group A 	Group B 	Group C 	Group D 	Group E 	Group F 	Group G 	Group H 
CH1	Fur Elise	Mary had a little Lamb	Amaryllis	Grandfather's Clock	Spanish Romance	Mary had a little Lamb	Beep	RHYTHM AND POLICE
CH2	A Maiden's Prayer	Camptown Races	Mozart Symphony No.40	Ave Maria	Camptown Races	Mozart Symphony No.40	Stutter	ZANKOKUNA TENSHINO TEEZE
CH3	Minuet in Gmjr	Cuckoo Song	Quiet Lakeside	Daydream Believer	Minuet in Gmjr	Holdiridia	Bell	MAJINGAA ZETTO
CH4	Annie Laurie	Village Blacksmith	Mountain Musician	London bridge is falling down	Ave Maria	Daydream Believer	Yelp	HATARAKU KURUMA
CH5	London bridge is falling down	On the Avignon Bridge	Spanish Romance	Bell	Stutter + Bell	Rapid Hi-Lo	Rapid Hi-Lo	NINGENTTE IINA
CH6	Holdiridia	Daydream Believer	Katyusha	Yelp	Melody Chime	Melody Chime	Melody Chime	ROBINSON
CH7	Chime	Chime	Chime	Synthesized Piano	Synthesized Piano	Synthesized Piano	Synthesized Piano	Synthesized Piano
CH8	Call sign	Call sign	Call sign	Synthesized Bell	Synthesized Bell	Synthesized Bell	Synthesized Bell	Synthesized Bell
CH	Group I 	Group J 	Group K 	Group L 	Group M 	Group N 	Group O 	Group P 
CH1	WORLD FOOTBALL ANTHEM	Turkey in the Straw	RHYTHM AND POLICE	ZANKOKUNA TENSHINO TEEZE	Galactic Hovercraft	Annie Laurie	Camptown Races	Daydream Believer
CH2	BANZAI SUKIDE YOKATTA	Aka tombo	BANZAI SUKIDE YOKATTA	MAJINGAA ZETTO	Game Intermission	London bridge is falling down	Cuckoo Song	Amaryllis
CH3	NAMONAKI UTA	Funiculi, Funicula	MAMBO NO 5	HATARAKU KURUMA	Spring Melody	Holdiridia	Village Blacksmith	Mozart Symphony No.40
CH4	Genesis of Aquarion	Furusato	Galactic Hovercraft	NINGENTTE IINA	Jalopy Horn	Mary had a little Lamb	On the Avignon Bridge	Quiet Lakeside
CH5	MAMBO NO 5	Beautiful Dreamer	Game Intermission	Genesis of Aquarion	ET Doorbell	BANZAI SUKIDE YOKATTA	WORLD FOOTBALL ANTHEM	Starting Notice Chime1
CH6	The Parade of the Tin Soldiers	JOLLY HOLIDAY	Spring Melody	Aka tombo	RR-crossing	NAMONAKI UTA	Turkey in the Straw	Starting Notice Chime2
CH7	Starting Notice Chime3	Ending Notice Chime1	Ending Notice Chime2	Jalopy Horn	Train Whistle	Furusato	Funiculi, Funicula	Chime
CH8	Stutter	Stutter	Stutter	Stutter	Stutter	Beautiful Dreamer	JOLLY HOLIDAY	Call sign

Author 26:LUDWIG VAN BEETHOVEN 27:BADARZEWSKA BARANOWSKA TEKLA 28:BACH JOHANN SEBASTIAN 29:SCOTT LADY JOHN DOUGLAS 30,31,34,38,41,42,58:TRADITIONAL 32,40:PD 33,62:FOSTER STEPHEN COLLINS 35:MEXT JAPAN SONG 36:WERNER HEINRICH (DE 2) 37:STEWART JOHN C 39:MOZART WOLFGANG AMADEUS 43:BLANTER MATVEJ ISAAKOVICH 44:WORK HENRY CLAY 45:SCHUBERT FRANZ 46: Akihiko Matsumoto 47:Hidetoshi Satou 48:Chumei Watanabe 49:Nobuyoshi Koshibe 50:Asei Kobayashi 51:Masamune Kusano 52:LAMBERT FRANZ/LOEW PETER 53: Tortoise Matsumoto 54:Kazutoshi Sakurai 55:Yoko Kanno 56:PRADO DAMASO PEREZ 57:JESSEL LEON 59: Kousaku Yamada 60:DENZA LUIGI 61: Teiichi Okano

※37,43, 46~56, 59  T-1340038

19.6. Type G EHV

01	Beep	14	Galloping Hi-Lo	27	ET Doorbell	40	Mozart Symphony No.40	53	Polka Trablanka
02	Stutter	15	Alien Chatter	28	RR-crossing	41	Ave Maria	54	O Vreneli
03	Bell	16	Falling Crystals	29	Starting Notice Chime1	42	Grandfather's Clock	55	KAERUNO GASSHOU
04	Yelp	17	Inverted Reveille	30	Starting Notice Chime2	43	The Parade of the Tin Soldiers	56	El Condor Pasa (If I Could)
05	Rapid Hi-Lo	18	Galactic Motor	31	Ending Notice Chime1	44	If You're Happy and You Know It	57	Hungarian Dance No.5
06	Melody Chime	19	Ringing Phone	32	Ending Notice Chime2	45	Flea Waltz	58	William Tell Overture
07	Synthesized Piano	20	Two Tone	33	Fur Elise	46	Turkey in the Straw	59	Pomp and Circumstance
08	Synthesized Bell	21	Alarm Clock	34	Minuet in Gmjr	47	The Battle Hymn of the Republic	60	Greensleeves
09	Stutter + Bell	22	Ringing Hi-Lo	35	Annie Laurie	48	J'ai perdu le do de ma clarinette	61	Nedelka
10	Melody Chime	23	Galactic Hovercraft	36	London bridge is falling down	49	Can-can	62	Moonlight Serenade
11	Chime	24	Game Intermission	37	Mary had a little Lamb	50	Radetzky March	63	WAREWA UMINO KO
12	Call Sign	25	Spring Melody	38	Camptown Races	51	Funiculi, Funicula		
13	Train Ride	26	Jalopy Horn	39	Amaryllis	52	Csikos Post		

CH	Group A	Group B	Group C	Group D	Group E	Group F	Group G	Group H
CH1	Fur Elise	Minuet in Gmjr	Fur Elise	Alien Chatter	Train Ride	Rapid Hi-Lo	Beep	The Parade of the Tin Soldiers
CH2	Minuet in Gmjr	Annie Laurie	London bridge is falling down	Falling Crystals	Galloping Hi-Lo	Chime	Stutter	If You're Happy and You Know It
CH3	Annie Laurie	Amaryllis	Mary had a little Lamb	Inverted Reveille	Inverted Reveille	Stutter	Bell	Flea Waltz
CH4	London bridge is falling down	Mozart Symphony No.40	Camptown Races	Galactic Motor	Galactic Motor	Ringing Phone	Yelp	Turkey in the Straw
CH5	Mary had a little Lamb	Grandfather's Clock	Amaryllis	Ringing Phone	Alarm Clock	Stutter + Bell	Rapid Hi-Lo	The Battle Hymn of the Republic
CH6	Camptown Races	Ave Maria	Grandfather's Clock	Two Tone	Ringing Hi-Lo	Melody Chime	Melody Chime	J'ai perdu le do de ma clarinette
CH7	Chime	Chime	Chime	Alarm Clock	Synthesized Piano	Synthesized Piano	Synthesized Piano	Synthesized Piano
CH8	Call Sign	Call Sign	Call Sign	Ringing Hi-Lo	Synthesized Bell	Synthesized Bell	Synthesized Bell	Synthesized Bell
CH	Group I	Group J	Group K	Group L	Group M	Group N	Group O	Group P
CH1	Can-can	KAERUNO GASSHOU	Nedelka	The Parade of the Tin Soldiers	Galactic Hovercraft	Fur Elise	Mary had a little Lamb	Ave Maria
CH2	Radetzky March	El Condor Pasa (If I Could)	Moonlight Serenade	J'ai perdu le do de ma clarinette	Game Intermission	Minuet in Gmjr	Camptown Races	Grandfather's Clock
CH3	Funiculi, Funicula	Hungarian Dance No.5	WAREWA UMINO KO	Funiculi, Funicula	Spring Melody	Annie Laurie	Amaryllis	Radetzky March
CH4	Csikos Post	William Tell Overture	Spring Melody	Nedelka	Jalopy Horn	London bridge is falling down	Mozart Symphony No.40	Polka Trablanka
CH5	Polka Trablanka	Pomp and Circumstance	Jalopy Horn	RR-crossing	ET Doorbell	If You're Happy and You Know It	Flea Waltz	O Vreneli
CH6	O Vreneli	Greensleeves	ET Doorbell	Starting Notice Chime2	RR-crossing	Csikos Post	Turkey in the Straw	El Condor Pasa (If I Could)
CH7	Galactic Hovercraft	Galactic Hovercraft	Starting Notice Chime1	Ending Notice Chime2	Starting Notice Chime1	KAERUNO GASSHOU	The Battle Hymn of the Republic	Hungarian Dance No.5
CH8	Game Intermission	Game Intermission	Ending Notice Chime1	Chime	Ending Notice Chime2	Greensleeves	Can-can	William Tell Overture

Author 33:LUDWIG VAN BEETHOVEN 34:BACH JOHANN SEBASTIAN 35:SCOTT LADY JOHN DOUGLAS 36,39,46,54,60,61:TRADITIONAL 37,45,47,48,55:PD 38:FOSTER STEPHEN COLLINS 40:MOZART WOLFGANG AMADEUS 41:SCHUBERT FRANZ 42:WORK HENRY CLAY 43:JESSEL LEON 44:U.S. Folk Song 49:OFFENBACH JACQUES AUGUSTE IGNAC 50:STRAUSS SEN JOHANN 51:DENZA LUIGI 52:NECKE HERMANN 53:SYGIETYNSKI TADEUSZ KAZIMIERZ 56:ROBELES DANIEL ALOMIA 57:BRAHMS JOHANNES 58:ROSSINI GIOACCHINO ANTONIO 59:ELGAR EDWARD 62:MILLER GLENN 63:MEXT JAPAN SONG

Due to improvements, changes to the contents of this document may be made without prior notice.

V95100153	F
'17.08. WEB	