

**PATLITE®**

New Frontiers in Safety, Security and Comfort

**Bright Light, Broad Coverage**  
**Ideal for Machine Tools**

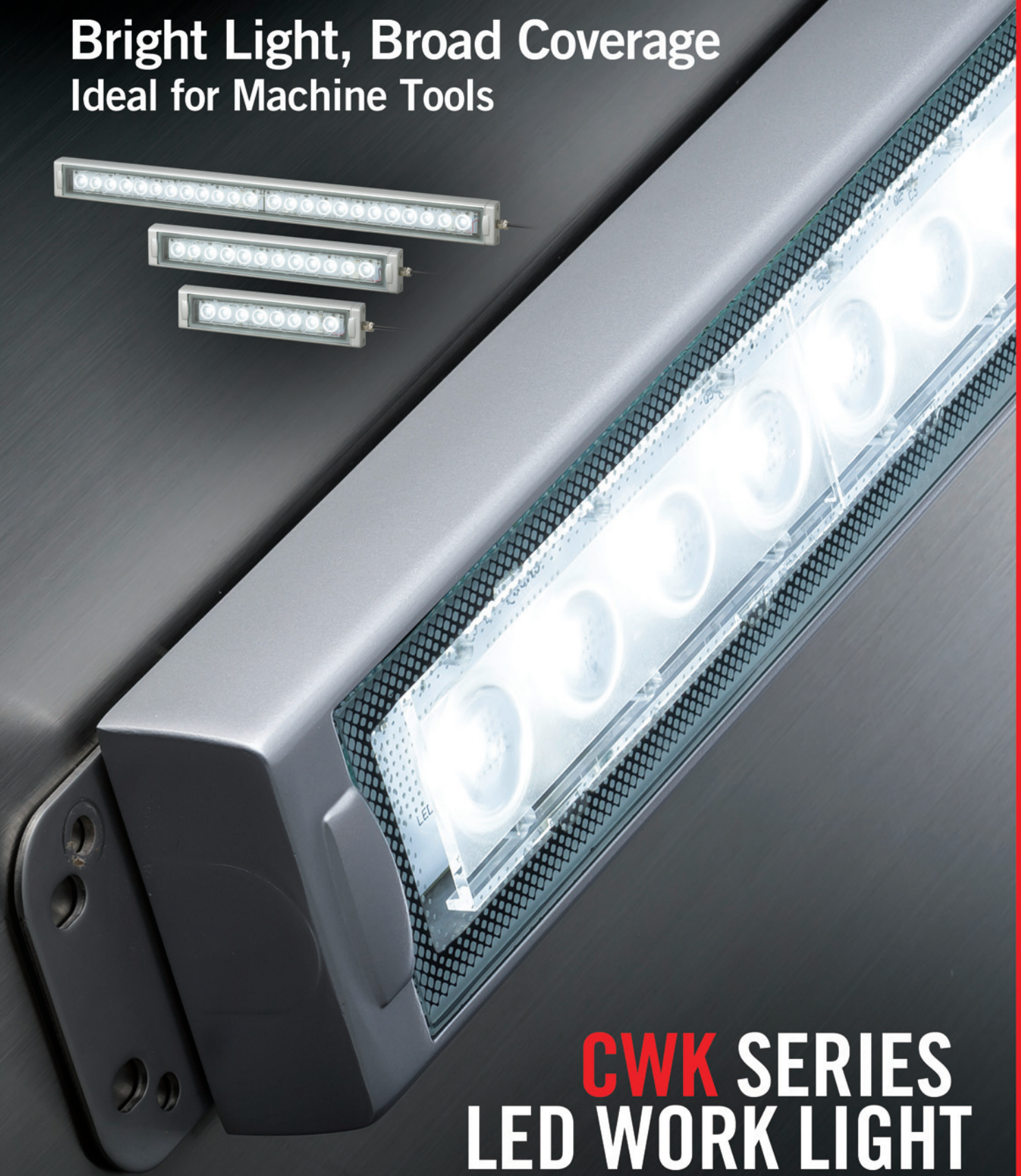

**CWK SERIES**  
**LED WORK LIGHT**

Wide Angle & High Illuminance.

[www.patlite.com](http://www.patlite.com)



# 1. Lens Design for Optimal Light Distribution

PATLITE's unique lens design assures proper illumination so that the space inside the machine is brighter. Thus, an operator can work in a well lit environment safely and more productively.

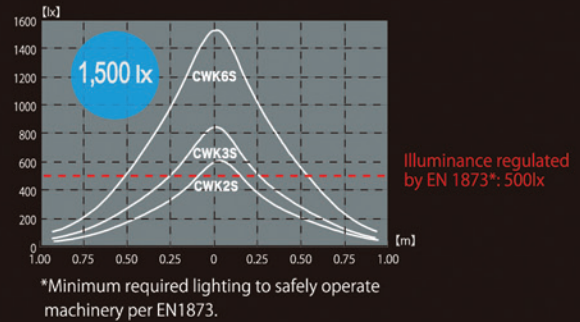
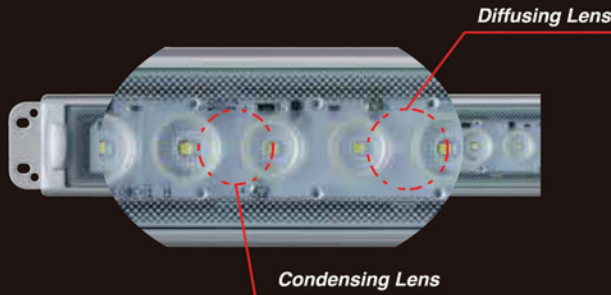

## The CWK meets the illumination needs of various machine sizes

Machine Size	Recommended Models	Light Distribution Diagram
Small-size Machines	CWK2S, CWK3S	0.5m from center CWK2S: 2500lx, 2000lx, 1750lx, 1500lx, 1250lx, 1000lx, 750lx, 500lx CWK3S: 3000lx, 2400lx, 2100lx, 1800lx, 1500lx, 1200lx, 900lx, 600lx
Mid-size Machines	CWK3S, CWK6S	1.0m from center CWK3S: 900lx, 800lx, 700lx, 600lx CWK6S: 1100lx, 1000lx, 900lx, 800lx, 700lx, 600lx, 500lx
Large Machines	CWK6S	1.0m from center: 1500lx, 1350lx, 1200lx, 1050lx, 900lx, 750lx, 600lx 1.5m from center: 900lx, 800lx, 700lx, 600lx, 500lx, 400lx

## Comparison in irradiation range

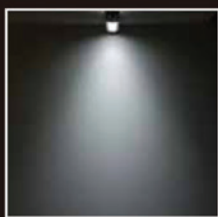

CWK Series  
Wide angled, high illuminance

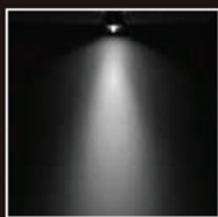

Others  
Narrow illuminance

- Provides better light dispersion than some other models.
- Use any of the three available lengths to achieve the desired illuminance according to the size and space inside the machine.



## 2. Compact Yet Durable

The CWK's compact design allows more processing space and its high resistance to cutting fluids and flying metal chips makes it ideal for machine tools.



\*\*G\* Rated to Protect Your Investment.  
Tested with several cutting fluids for 48 hours each without any damage or fluid penetration to the CWK.

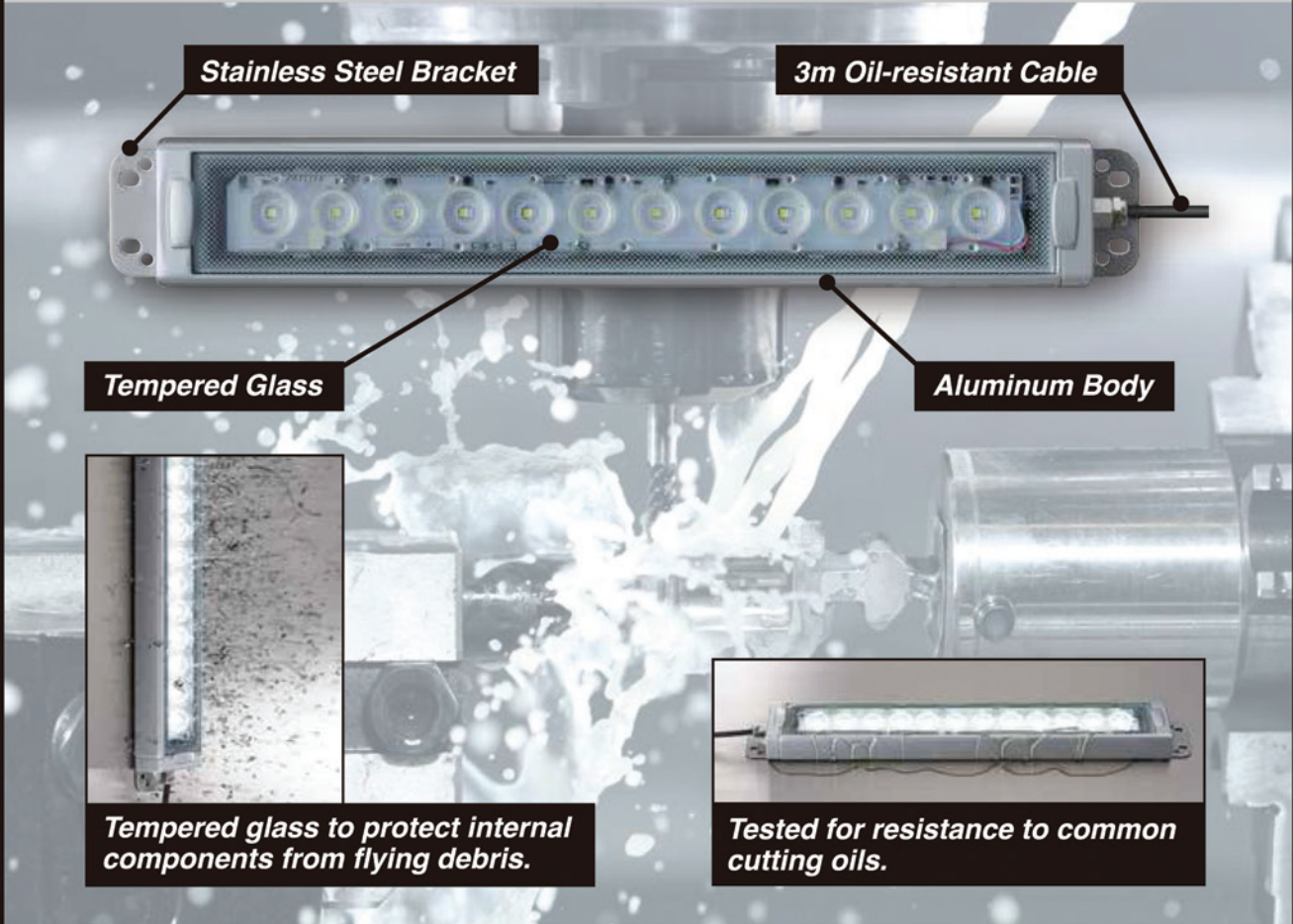

## 3. Lower Maintenance Costs and Mounting Options

- Long-lasting LED (50,000 hrs., 25°C) no need to change ballast.
- Easier cleaning with a flat structure.
- Various mounting options.

The following brackets can be used to fit various mounting applications.



## Dimensions

Unit : mm

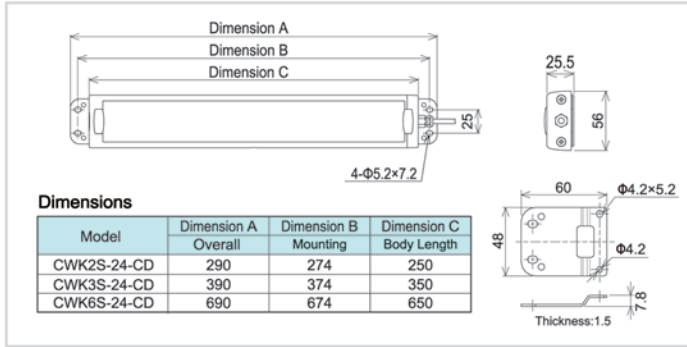

## Mounting Method

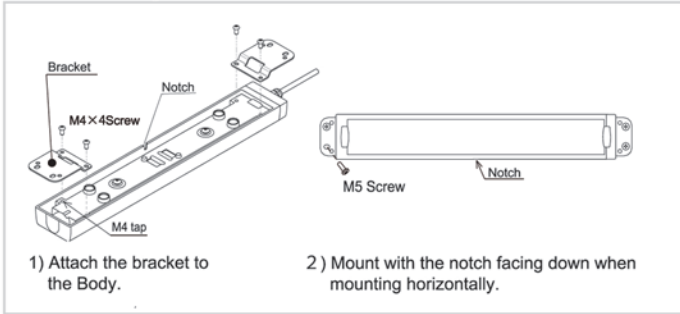

## Wiring Diagram

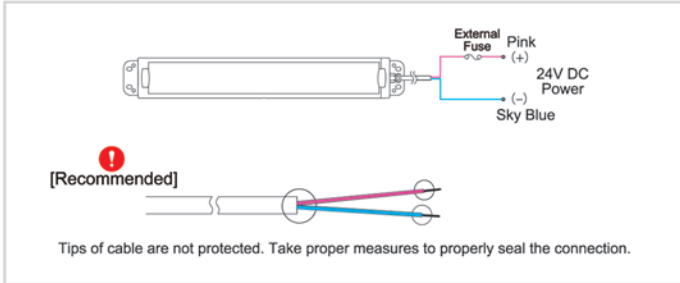

## How to Order

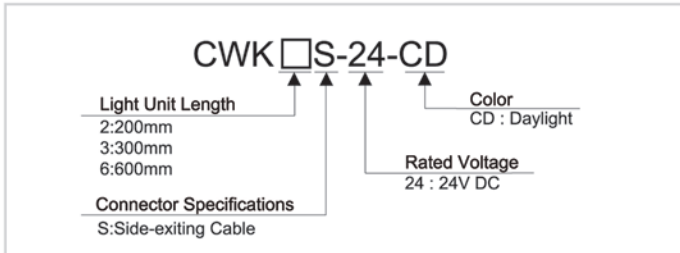

## Specifications

Model	CWK2S-24	CWK3S-24	CWK6S-24	
Luminous Color	Daylight			
Color Temperature (typ.)	6500 K			
Illuminance (typ.) (Center, at DC24V)	1.0m	600 lx	850 lx	1500 lx
Lumens (typical)	800 lm	1200 lm	2400 lm	
Operating Voltage Range	24V DC ±10%			
Rated Current Consumption	360 mA ±10%	480 mA ±10%	960 mA ±10%	
Rated Power Consumption	8.6 W	11.5 W	23 W	
Operating Ambient Temperature	-10°C ~ +50°C			
Operation Ambient Humidity	90% RH or less, no condensation			
Main Unit Material	Body : Aluminum Alloy , Lens : Tempered Glass			
Cable length	3m			
Mounting Location	Indoor			
Protection Rating	IP66G/67G (JIS C0920)			
Insulation Resistance	500V DC 5MΩ or more			
Withstand Voltage	500V AC for 1 minute (between terminals and chassis)			
Vibration Resistance	30Hz 20 m/s <sup>2</sup>			
Mass (Tolerance ±10%)	600 g	750 g	1230 g	

## Option Brackets

Unit : mm

- Angle Adjustment Bracket : SZ-320KS

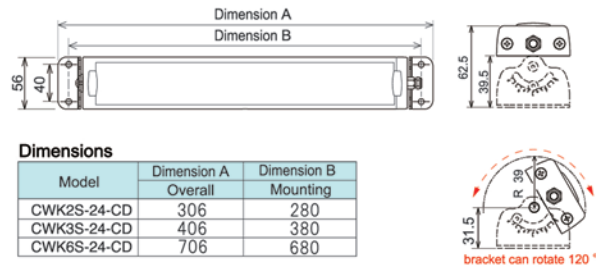

- Surface Mount Bracket : SZ-330KP

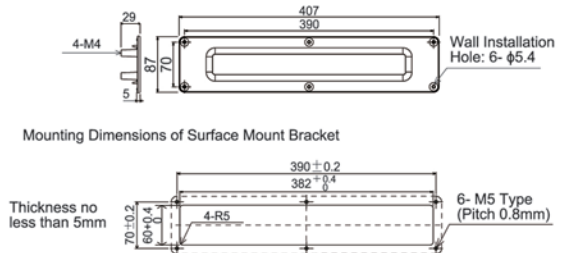

PATLITE, the PATLITE logo are either registered trademarks or trademarks of PATLITE Corporation in JAPAN and/or other countries.

## PATLITE Corporation

4-4-25, Hommachi, Chuo-ku, Osaka-shi, 541-0053 Japan  
International Sales Division  
TEL: +81-6-7711-8953 FAX: +81-6-7711-8961 E-mail: overseas@patlite.co.jp

**PATLITE (U.S.A.) Corporation**  
20130 S. Western Ave. Torrance, CA 90501, U.S.A. TEL: +1-310-328-3222 FAX: +1-310-328-2676

**PATLITE (SINGAPORE) PTE LTD**  
No.2 Leng Kee Road, #05-01 Thye Hong Centre, Singapore 159086 TEL: +65-6226-1111 FAX: +65-6324-1411

**PATLITE (CHINA) Corporation**  
Room 1102-1103, No.55, Lane 777, Guangzhong Road (West), Zhabei District, Shanghai, China 200072 TEL: +86-21-6630-8969 FAX: +86-21-6630-8938

**PATLITE Europe GmbH**  
Am Soeldnermoos 8, D-85399 Hallbergmoos, Germany TEL:+49-811 9981 9770-0 FAX:+49-811 9981 9770-9

**PATLITE KOREA CO., LTD.**  
A-2603, Daesung D-POLIS, 543-1 Gasan-dong, Geumcheon-gu, Seoul, 153-719 TEL:+82-2-523-6636 FAX:+82-2-861-9919

**PATLITE TAIWAN CO., LTD.**  
7F, No. 91, Huayin St, Datong District Taipei, Taiwan R.O.C TEL:+886-2-2555-1611 FAX:+886-2-2555-1621

### CAUTION

To ensure correct use of these products, read the Instruction Manual prior to use.  
Failure to follow all safeguards can result in fire, electric shock, or other accidents.  
Specifications are subject to change without notice.