

Ex9C09/12/18/25/32/38 General Purpose Contactor

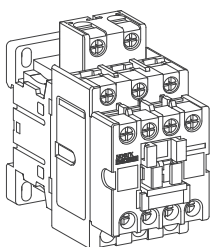

Ex9CR09/12/18/25/32/38
 Horizontal Reversing General Purpose Contactor

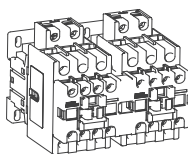

Z9C2201401NA

⚠ WARNING

DO NOT ATTEMPT TO INSTALL OR PERFORM MAINTENANCE ON EQUIPMENT WHILE IT IS ENERGIZED. DEATH, SEVERE PERSONAL INJURY, OR SUBSTANTIAL PROPERTY DAMAGE CAN RESULT FROM CONTACT WITH ENERGIZED EQUIPMENT. ALWAYS VERIFY THAT NO VOLTAGE IS PRESENT BEFORE PROCEEDING WITH THE TASK, AND ALWAYS FOLLOW GENERALLY ACCEPTED SAFETY PROCEDURES.

NOARK IS NOT LIABLE FOR THE MISAPPLICATION OR MISSAPPLICATION OF IT'S PRODUCTS.

	A	B	C	D	E	F	G	H	I	
	M3.5 15Lb.in [1.7N.m]		AWG[mm ²] 18-12 [1-2.5]	AWG[mm ²] 18-12 [1-2.5]	0.4 in [10 mm] AWG[mm ²] 18-12 [1-2.5]	AWG[mm ²] 18-12 [1-2.5]	AWG[mm ²] 18-12 [1-2.5]	AWG[mm ²] 18-12 [1-2.5]	AWG[mm ²] 18-12 [1-2.5]	
Code	Model	A	B	C	D	E	F	G	H	I
Ex9C09-18	M3.5	15Lb.in [1.7N.m]	18-12AWG 1-2.5mm ²	18-12AWG 1-2.5mm ²	18-12AWG 1-2.5mm ²	18-12AWG 1-2.5mm ²	18-12AWG 1-2.5mm ²	18-12AWG 1-2.5mm ²	18-12AWG 1-2.5mm ²	0.4 in 10 mm
Ex9C25-38	M4	22Lb.in [2.5N.m]	18-8AWG 1-10mm ²	18-8AWG 1-10mm ²	18-8AWG 1-10mm ²	18-8AWG 1-10mm ²	18-8AWG 1-10mm ²	18-8AWG 1-10mm ²	18-8AWG 1-10mm ²	0.6 in 14 mm

Device must be installed in an enclosure sized 240 mm X 240 mm X 150 mm at a minimum

AX42	Auxiliary contact
AX43	Auxiliary contact
AXC	Air delay
CCU42	Surge arrester

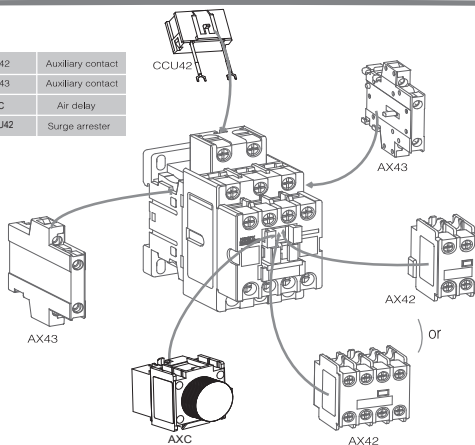

Warning!

Motor may start automatically. Automatic start may injure persons and damage machines. Automatic restart is possible when "automatic reset" is active.

Avertissement !

Le redémarrage automatique du moteur peut provoquer des dégâts matériels et être dangereux pour personnes. Ce danger du redémarrage automatique correspond au mode «réarmement automatique».

¡Advertencia!

El motor puede arrancar automáticamente. El arranque automático es posible cuando el "botón de reset" está en posición automático y el circuito de maniobra activado.



Dangerous Electrical Current!
Only skilled qualified persons may carry out the following operations.

Tension électrique dangereuse!
Seules les personnes qualifiées et averties doivent exécuter les travaux ci-après.

¡Corriente eléctrica! ¡Peligro de muerte!
El trabajo a continuación descrito debe ser realizado por personas cualificadas y advertidas.

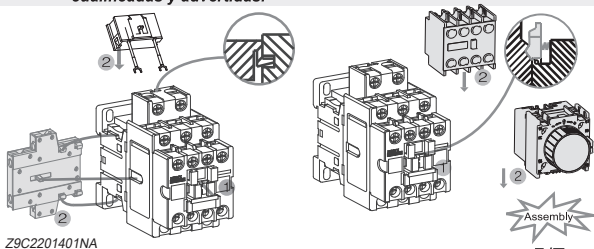

5/7

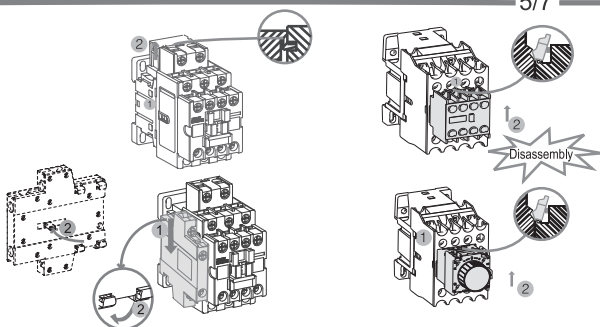

Disconnect all power before working on equipment.
Coupez toutes les alimentations avant de travailler sur l'équipement.
Desconecte la alimentación antes de trabajar en equipo.

6/7

0911~3811

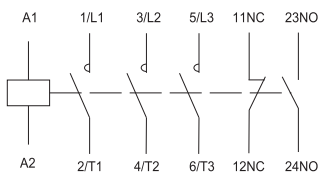

0922~3822

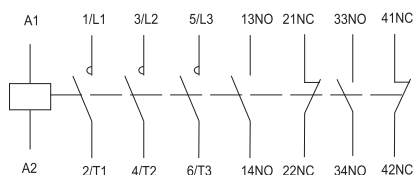

7/7

NOARK



Printed with environment-friendly paper

Copyright Noark. All Rights Reserved

www.noark-electric.com

01/2014