

ImperviTRAN™

Industrial Control Transformers

Advanced transformers built for the industrial environment



Catalog

CCT-16A-English



Supersedes: CCT-15B

Table of Contents
PROUDLY BUILT IN THE USA

The Micron Story	2 -- 3
Transformer Selection Process	4 – 6
Overcurrent Protection Selection Guide	7
Product Selection Guide – ImperviTRAN	8
Part Numbers/Wiring Diagrams	9 -- 11
Product Dimensional Data – ImperviTRAN	12 -- 15
Product Selection Guide – GlobalTRAN	16
Part Numbers/Wiring Diagrams	16 -- 18
Product Dimensional Data – GlobalTRAN	18 -- 21
Product Selection Guide – Medium Voltage	22
Part Numbers/Dimensions	
Control Transformer Accessories	23 – 24
What is a Transformer	25 -- 26
Common Questions	27 – 28
Micron Total Product Offering	29 -- 31

Micron Industries Corporation is a manufacturer of control magnetics and custom windings headquartered in Oak Brook IL with manufacturing facilities in Sterling IL. Best known for the ImperviTRAN™ brand 600 volt class control transformer, Micron has developed into an industry leader in DIN Rail mount industrial power supplies and converters as well as NEMA 3R transformers. Banking on our history of providing non-catalog products within the same 10 day lead time as catalog standards, Micron has recently added specialty reactors and custom wound coils to its growing product portfolio.



Oak Brook IL Headquarters

Over its nearly 50 year history as a transformer manufacturer, Micron has become the supplier of choice to the majority of the motor control and drive industry. Besides maintaining rapid response inventories on over 250 catalog items, Micron's active SKU file exceeds 4,500 additional part numbers which are available in a maximum of 15 working days.



Sterling IL Manufacturing

Why Choose Micron?

Micron chose to encapsulate its control transformer designs over 40 years ago and still does so today. Why?

Encapsulation provides:

- Improved heat dissipation from the core.
- Windings and solder connections protected from corrosion for longer transformer life.
 - The average MTBF of our 600 volt class ImperviTRAN™ is 192,720 hours.
- The use of encapsulation and robust terminal block construction greatly reduces freight and installation damage.

From the beginning, Micron designed a user-centric product that stands the test of time.

- Compact terminal spacing.
- Integral secondary fusing capability was designed into the first ImperviTRAN™.
- Offering primary fusing capability for nearly 40 years! Simplified by the factory installed ImperviMOUNT™ accessory mounting plate.
- ImperviMOUNT™ is standard on all Series 2 designs and is optional on all other Micron transformer products, including open construction transformers and reactors; thus allowing the installer an additional accessory mounting location.
- Philslot/pressure plate terminal screws simplify the wiring process.

This user-centric philosophy is visible in all Micron products, from control transformers to DC power supplies and reactors.

Manufacturing Capabilities

Control Transformers: The ImperviTRAN™ product offering is available from 25VA through 5,000VA in any 600 volt class voltage combination. All designs meet UL, cUL, CSA or EN61558-2-2 and can be built in 105°C, 130°C, 155°C or 180°C designs.

Power Supplies and Converters: The *DINergy*™ product offering encompasses power supplies from 18 watt single phase through 960 watt three-phase in the most popular industrial output voltages. The majority also operate as converters with 120 VDC input capability. Low profile, PCB and panel mount supplies and converters on special order.

NEMA 3R Products: Micron can furnish virtually all combinations of 600 volt class single and three-phase catalog designs both as encapsulated and ventilated. Included in this selection are transformers capable of providing voltage adjustments as buck-boost designs.

Specialty Designs and Coils: Micron can provide 15 day turn-around on your magnetics needs

- Specialty coils both stick and bobbin configurations
- Single-phase 600 volt class transformers and chokes built on E-I laminations
- Custom three-phase open construction 600 volt class transformers through 150kVA
- Custom three-phase load bank reactors from 0.25kvar through 150kvar
- Custom three-phase line and load reactors from fractional through 250HP
- Custom capacitor detuning reactors through 75kvar
- Medium voltage control transformers through 15kVA and 14,400 volts
- Custom Auto transformers through 500kVA
- 600 volt class motor starting reactors through 250HP

Selection Guide for Control Transformers

How to size a transformer

Inrush VA: Helps choose final VA

Sealed VA: helps choose FLA

REGULATION DATA CHART

VA	Inrush VA at 20% Power Factor		
	NEMA / IEC 95% Sec. Voltage	NEMA / IEC 90% Sec. Voltage	NEMA / IEC 85% Sec. Voltage
25 ¹	100 / ----	130 / ---	150 / ---
50 ¹	170 / 190	200 / 220	240 / 270
75 ¹	310 / 350	410 / 460	540 / 600
100 ¹	370 / 410	540 / 600	730 / 810
150 ²	780 / 850	930 / 1030	1150 / 1270
200 ²	810 / 900	1150 / 1270	1450 / 1600
250 ²	1400 / 1540	1900 / 2090	2300 / 2530
300 ²	1900 / 2090	2700 / 2970	3850 / 4240
350 ²	3100 / 3410	3650 / 4020	4800 / 5280
500 ²	4000 / 4400	5300 / 5830	7000 / 7700
750 ²	8300 / 9130	11000 / 12100	14000 / 15400
1000 ²	15000 / 16500	21000 / 23000	27000 / 29500
1000 ³	9000 / 9900	13000 / 14300	18500 / 20300
1500 ³	10500 / 11500	15000 / 16500	20500 / 22500
2000 ³	17000 / 18900	25500 / 27300	34000 / 36400
3000 ³	24000 / 25700	36000 / 38500	47500 / 50200
5000 ³	55000 / 58800	92500 / 98900	115000 / 122000

SELECTION PROCESS

Selecting a transformer for industrial control circuit applications requires understanding the relationships between the following terms.

INRUSH VA is the product of the *load voltage (V)* multiplied by the *current (A)* that is required during start-up. This is also known as *magnetizing current*. It is calculated by adding together the inrush VA of all components that might be energized simultaneously. Inrush VA is available from the component manufacturer.

SEALED VA also called *Steady State VA* is the product of the *load voltage (V)* multiplied by the *current (A)* that is required during normal operation. It is calculated by adding together the sealed VA of all components that might be operating simultaneously. Sealed VA is available from the component manufacturer.

PRIMARY VOLTAGE is the voltage available from the distribution system and its operational frequency, which is connected to the transformer *supply voltage (H)* terminals.

SECONDARY VOLTAGE is the voltage required for load operation, which is connected to the transformer *load voltage (X)* terminals.

¹ For units with class 105° C insulation system.

² For units with class 130° C insulation system.

³ For units with class 180° C insulation system.

Once the circuit variables have been determined, transformer selection is a simple four step process:

- 1) Based on the industry accepted formula: **Application Inrush VA = $\sqrt{((\text{Inrush VA})^2 + (\text{Sealed VA})^2)}$**
- 2) Refer to the regulation data chart. **If the load can tolerate a 10% voltage sag upon start-up select from the 90% secondary voltage column;** if only 5%, select from the 95% column.
- 3) After determining the proper secondary voltage column, read down until a value equal or greater than the Application Inrush VA is found. The numbers indicate the *maximum* Application Inrush VA that will still generate the required secondary voltage upon start-up.
- 4) Read left to the transformer VA column and select the proper transformer for the application. *As a final check make sure that the Transformer VA is equal or greater than the total Sealed VA requirements.*

Selection Guide for Single Phase Power Transformers

1. Determine the primary (source) voltage
-the voltage presently available.
2. Determine the secondary (load) voltage
-the voltage needed at the load.
3. Determine the Kva load:
 - If the load is defined in Kva, a transformer can be selected from the tabulated data.
 - If the load rating is given in amperes, determine the load Kva from the Full Load Current chart. To determine Kva when volts and amperes are known, use the formula:

$$\text{Kva} = \frac{\text{Volts} \times \text{Amperes}}{1000}$$

- If the load is an AC motor, determine the minimum transformer Kva from the chart at the right.
 - Select a transformer rating equal to or greater than the load Kva.
4. Define tap arrangements needed.
 5. Define temperature rise.

Using the above procedure, select the transformer from the listings in this catalog.

Single Phase AC Motors₁

Horsepower	Full Load Amperes				MINIMUM KVA ₂
	115V	208V	220V	230V	
1/6	4.4	2.4	2.3	2.2	0.53
1/4	5.8	3.2	3	2.9	0.70
1/3	7.2	4	3.8	3.6	0.87
1/2	9.8	5.4	5.1	4.9	1.18
3/4	13.8	7.6	7.2	6.9	1.66
1	16	8.8	8.4	8	1.92
1-1/2	20	11	10.4	10	2.40
2	24	13.2	12.5	12	2.88
3	34	18.7	17.8	17	4.10
5	56	30.8	29.3	28	6.72
7-1/2	80	44	42	40	9.60
10	100	55	52	50	12.0

EXAMPLE OF TRANSFORMER SELECTION FOR 1.5HP SINGLE-PHASE MOTOR. ALTERNATELY, MULTIPLY VOLTS (115) x AMPS (20) AND DIVIDE BY 1,000 = 2.3KVA

Full Load Current in Amperes₁ – Single Phase Circuits

1. When motor service factor is greater than 1, increase Full Load amps proportionally.
Example: If service factor is 1.15, increase above amp values by 15%.
2. If motors are started more than once per hour, increase the minimum transformer Kva by 20%.

Kva ₂	Single Phase Volts								
	120	208	220	240	277	480	600	2400	4160
0.250	2	1.2	1.1	1	0.9	0.5	0.4	0.10	0.06
0.500	4.2	2.4	2.3	2.1	1.8	1	0.8	0.21	0.12
0.750	6.3	3.6	3.4	3.1	2.7	1.6	1.3	0.31	0.18
1	8.3	4.8	4.5	4.2	3.6	2.1	1.7	0.42	0.24
1.5	12.5	7.2	6.8	6.2	5.4	3.1	2.5	0.63	0.36
2	16.7	9.6	9.1	8.3	7.2	4.2	3.3	0.83	0.48
3	25	14.4	13.6	12.5	10.8	6.2	5	1.2	0.72
5	41	24	22.7	20.8	18	10.4	8.3	2.1	1.2
7.5	62	36	34	31	27	15.6	12.5	3.1	1.8
10	83	48	45	41	36	20.8	16.7	4.2	2.4
15	125	72	68	62	54	31	25	6.2	3.6
25	208	120	114	104	90	52	41	10.4	6
37.5	312	180	170	156	135	78	62	15.6	9
50	416	240	227	208	180	104	83	20.8	12
75	625	360	341	312	270	156	125	31.3	18
100	833	480	455	416	361	208	166	41.7	24
167	1391	802	759	695	602	347	278	69.6	40.1

Selection Guide for Three Phase Power Transformers Three Phase AC Motors₁

1. Determine the primary (source) voltage – the voltage available.
2. Determine the secondary (load) voltage – the voltage needed at the load.
3. Determine the KVA load.
 - If the load is defined in KVA, a transformer can be selected directly from the table.
 - If the load rating is given in amperes, determine the load Kva from the Full load Current chart. To determine Kva when volts and amperes are known, use the formula:
Kva= $\frac{\text{Volts} \times \text{Amperes} \times 1.732}{1000}$
 - If the load is an AC motor, determine the minimum transformer Kva from the chart at the right.
 - Select a transformer rating equal or greater than the load Kva.
4. Define tap arrangements needed.
5. Define temperature rise.

Horsepower	Full Load Amps					MINIMUM KVA ₂
	208V	230V	380V	460V	575V	
½	2.2	2.0	1.2	1.0	0.8	0.9
¾	3.1	2.8	1.7	1.4	1.1	1.2
1	4.0	3.6	2.2	1.8	1.4	1.5
1-1/2	5.7	5.2	3.1	2.6	2.1	2.1
2	7.5	6.8	4.1	3.4	2.7	2.7
3	10.7	9.6	5.8	4.8	3.9	3.8
5	16.7	15.2	9.2	7.6	6.1	6.3
7-1/2	24	22	14	11	9	9.2
10	31	28	17	14	11	11.2
15	46	42	26	21	17	16.6
20	59	54	33	27	22	21.6
25	75	68	41	34	27	26.6
30	88	80	48	40	32	32.4
40	114	104	63	52	41	43.2
50	143	130	79	65	52	52
60	170	154	93	77	62	64
75	211	192	116	96	77	80
100	273	248	150	124	99	103
125	342	312	189	156	125	130
150	396	360	218	180	144	150
200	528	480	291	240	192	200

EXAMPLE OF TRANSFORMER SELECTION FOR A 1.5HP THREE-PHASE MOTOR. ALTERNATELY, MULTIPLY VOLTS (208) x AMPS (5.7) AND THAT PRODUCT BY 1.732 THEN DIVIDE BY 1,000 = 2.05KVA

Using the above procedure, select the transformer from the listings in this catalog.

Full Load Current in Amperes₁ – Three Phase Circuits

1. When motor service factor is greater than 1, increase Full Load amps proportionally. Example: If service factor is 1.15, increase above amp values by 15%.
2. If motors are started more than once per hour, increase the minimum transformer Kva by 20%.

Kva ₂	Three Phase Volts						
	208	240	380	480	600	2400	4160
3	8.3	7.2	4.6	3.6	2.90	0.72	0.42
6	16.6	14.4	9.1	7.2	5.8	1.4	0.83
9	25	21.6	13.7	10.8	8.6	2.2	1.2
15	41.7	36.1	22.8	18	14.4	3.6	2.1
22.5	62.4	54.1	34.2	27.1	21.6	5.4	3.1
30	83.4	72.3	45.6	36.1	28.9	7.2	4.2
37.5	104	90.3	57	45.2	36.1	9	5.2
45	124	108	68.4	54.2	43.4	10.8	6.3
50	139	120	76	60.1	48.1	12	6.9
75	208	180	114	90	72	18	10.4
112.5	312	270	171	135	108	27.1	15.6
150	416	360	228	180	144	36.1	20.8
225	624	541	342	270	216	54.2	31.3
300	832	721	456	360	288	72.2	41.6
500	1387	1202	760	601	481	120	69.4
750	2084	1806	1140	903	723	180	104
1000	2779	2408	1519	1204	963	241	139

Pick the VA rating requested + the secondary voltage. ie: 250VA @ 24 volts. The chart indicates a maximum 15 amp fuse

Pick the VA rating requested + the primary voltage. ie: 250Va @ 480 volts. The chart indicates a maximum 1-1/4 amp fuse.

SECONDARY AND PRIMARY OVERCURRENT PROTECTION

Secondary Voltage	VA RATING															
	25	50	75	100	150	200	250	300	350	500	750	1000	1500	2000	3000	5000
12	3-2/10	6-1/4	10	12	15	20	25	30	--	--	--	--	--	--	--	--
23	1-8/10	3-1/2	5	7	10	12	15	17-1/2	20	30	--	--	--	--	--	--
24	1-6/10	3-2/10	5	6-1/4	10	12	15	17-1/2	20	30	--	--	--	--	--	--
25	1-6/10	3-2/10	5	6-1/4	10	12	15	15	17-1/2	25	--	--	--	--	--	--
90	4/10	8/10	1-1/4	1-8/10	2-1/2	3-1/2	4-1/2	5	6-1/4	9	12	15	20	25	--	--
95	4/10	8/10	1-1/4	1-6/10	2-1/2	3-1/2	4	5	6	8	12	15	17-1/2	25	--	--
100	4/10	8/10	1-1/4	1-6/10	2-1/2	3-2/10	4	5	5-6/10	8	12	15	17-1/2	25	--	--
110	3/10	3/4	1-1/8	1-1/2	2-1/4	3	3-1/2	4-1/2	5	7-1/2	10	12	17-1/2	25	--	--
115	3/10	6/10	1	1-4/10	2	2-8/10	3-1/2	4	5	7	10	12	17-1/2	25	--	--
120	3/10	6/10	1	1-1/4	2	2-1/2	3-2/10	4	4-1/2	6-1/4	10	12	17-1/2	25	--	--
220	3/16	3/10	1/2	3/4	1-1/8	1-1/2	1-8/10	2-1/4	2-1/2	3-1/2	5-6/10	7-1/2	10	12	17-1/2	30
230	15/100	3/10	1/2	6/10	1	1-4/10	1-8/10	2	2-1/2	3-1/2	5	7	10	12	17-1/2	30
240	15/100	3/10	1/2	6/10	1	1-4/10	1-6/10	2	2-1/4	3-2/10	5	6-1/4	10	12	17-1/2	30

Primary Voltage	VA RATING															
	25	50	75	100	150	200	250	300	350	500	750	1000	1500	2000	3000	5000
115	1/2	1	1-6/10	2	3-2/10	4	5	6-1/4	7-1/2	10	15	20	30	--	--	--
120	1/2	1	1-1/2	2	3	4	5	6-1/4	7	10	15	20	30	--	--	--
200	3/10	6/10	8/10	1-1/4	1-8/10	2-1/2	3	3-1/2	4	6-1/4	9	12	17-1/2	25	--	--
208	3/10	6/10	8/10	1-1/8	1-8/10	2-1/4	3	3-1/2	4	6	9	12	17-1/2	20	--	--
220	1/4	1/2	8/10	1-1/8	1-6/10	2-1/4	2-8/10	3-2/10	3-1/2	5-6/10	8	10	15	20	30	--
230	1/4	1/2	8/10	1	1-6/10	2	2-1/2	3-2/10	3-1/2	5	8	10	15	20	30	--
240	1/4	1/2	3/4	1	1-1/2	2	2-1/2	3	3-1/2	5	7-1/2	10	15	20	30	--
277	2/10	4/10	6/10	8/10	1-1/4	1-8/10	2-1/4	2-1/2	3	4-1/2	6-1/4	9	12	17-1/2	25	--
380	15/100	3/10	4/10	6/10	8/10	1-1/4	1-6/10	1-8/10	2-1/4	3-2/10	4-1/2	6-1/4	9	12	17-1/2	30
400	15/100	3/10	4/10	6/10	8/10	1-1/4	1-1/2	1-8/10	2	3	4-1/2	6-1/4	9	12	17-1/2	30
415	15/100	3/10	4/10	6/10	8/10	1-1/8	1-1/2	1-8/10	2	3	4-1/2	6	9	12	17-1/2	30
440	1/8	1/4	4/10	1/2	8/10	1-1/8	1-4/10	1-6/10	1-8/10	2-8/10	4	5-6/10	8	10	15	25
460	1/8	1/4	4/10	1/2	8/10	1	1-1/4	1-6/10	1-8/10	2-1/2	4	5	8	10	15	25
480	1/8	1/4	3/10	1/2	3/4	1	1-1/4	1-1/2	1-8/10	2-1/2	3-1/2	5	7-1/2	10	15	25
550	1/10	2/10	3/10	4/10	6/10	8/10	1-1/8	1-1/4	1-1/2	2-1/4	3-2/10	4-1/2	6-1/4	9	12	20
575	1/10	2/10	3/10	4/10	6/10	8/10	1	1-1/4	1-1/2	2	3-2/10	4	6-1/4	8	12	20
600	1/10	2/10	3/10	4/10	6/10	8/10	1	1-1/4	1-4/10	2	3	4	6-1/4	8	12	20

- If the rated secondary current is less than 9 amps, the secondary rating of overcurrent protection is 167% maximum of rated secondary current.
- If the rated secondary current is 9 amps or greater, the secondary rating of overcurrent protection is 125% maximum of rated secondary current
- Primary rating of overcurrent protection is 250% maximum of rated primary current when secondary is protected by overcurrent protection.

Reference: NEC 450.3(B)

Rev 9/3/10

ImperviTRAN™ PRODUCT SELECTION GUIDE

GENERAL SPECIFICATIONS: ALL ARE 50/60 Hz RATED

BUILDING STYLE:

Series 2 IMPERVITRAN

IMPERVITRAN (non-Series 2) highlighted in blue

APPROVALS: UL/cUL File #E46323

APPROVALS: UL File #E46323/CSA File #LR27533

TERMINAL TIGHTENING TORQUE (ALL IMPERVITRAN STYLES): ≤30A: 20 lb/in; >30A: 30 lb/in

TERMINAL NUMBER: Column "T" denotes terminal count needed to select terminal cover kits

Sold as 10-Paks. TPTC-2001 fits all 4-terminal designs; TPTC-2002 fits all 6-terminal designs.

TEMPERATURE CLASS:

Two letter suffix denotes Temp Class 105°C

Three letter suffix ending in "F" denotes Temp Class 130°C

Three letter suffix ending in "H" denotes Temp Class 180°C

PART NUMBER DESCRIPTORS:

Alpha-numeric

B150BTZ13JKF

B = Impervitran construction

150 = VA rating (Kva = *K*ie: 3K0)

BT = Primary voltage rating

Z = Triple rated ±5% around nominal voltage

13 = Secondary voltage

JK = installed accessories

F = 130°C construction

Serialized

B150-2004-GAF

B = Impervitran construction

150 = VA rating

2004 = Assigned by engineering

GA = GlobalTran EN61558-2-2

F = 130°C construction

COMMON PRIMARY VOLTAGES

120 = L	277 = Q	460 = T
208 = M	380 = R	480 = U
230 = B	400 = F	575 = W
240 = P	415 = D	±5% = Z

COMMON SECONDARY VOLTAGES

5 = 12	19 = 240
7 = 24	34 = 110 X 220
13 = 115	37 = 95, 115
15 = 120	

SUFFIX DESCRIPTION:

"J" in suffix denotes jumpers necessary for operation

"K" in suffix denotes installed secondary fuse clips for 13/32 x 1-1/2 fuse

"-1" in suffix denotes installed secondary fuse clips (serialized P/Ns)

"-3" in suffix denotes no fuse clips on unit (serialized P/Ns)

"-5" in suffix denotes factory installed non-standard accessories

"R" in suffix denotes installed Class "CC" primary fuse block

"-8" in suffix denotes installed Class "CC" primary fuse block (serialized P/Ns)

"X" in suffix is a place holder. The letter it replaces is not available on that unit

EXAMPLE:

B100BTZ13JK >>> B100BTZ13RB

B150MBT13XKF >>> B150MBT13RKF

Blue not Series 2

Pertinent agency and mechanical data

Number of terminals

Transformer Full Load Amps

Terminal designators

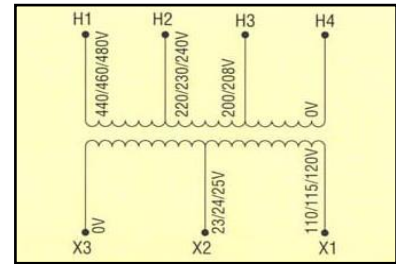
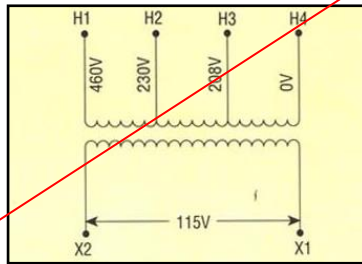
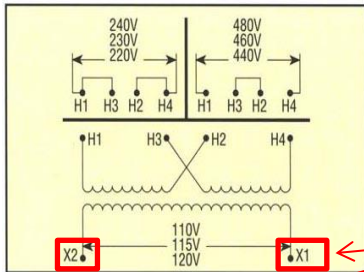

Primary: 220 x 440, 230 x 460,
240 x 480
Secondary: 110/115/120

Primary: 208, 230, 460
Secondary: 115

Primary: 208/230/460
Secondary: 24/115

T	F.L.A.	VA	CATALOG NUMBER
4	0.43	50	B050BTZ13JK
4	0.65	75	B075BTZ13JK
4	0.87	100	B100BTZ13JK
4	1.30	150	B150BTZ13JKF
4	1.74	200	B200BTZ13JKF
4	2.17	250	B250BTZ13JKF
4	2.61	300	B300BTZ13JKF
4	3.04	350	B350BTZ13JKF
6	4.35	500	B500BTZ13JKF
6	6.52	750	B750BTZ13JKF
6	8.70	1000	B1K0BTZ13JKF
6	13.04	1500	B1K5BTZ13JKF
6	17.39	2000	B2K0BTZ13JKH
6	26.09	3000	B3K0BTZ13JXH
6	43.48	5000	B5K0BTZ13JXH

T	F.L.A.	VA	CATALOG NUMBER
4	0.43	50	B050MBT13XK
4	0.65	75	B075MBT13XK
4	0.87	100	B100MBT13XK
4	1.30	150	B150MBT13XKF
4	1.74	200	B200MBT13XKF
4	2.17	250	B250MBT13XKF
4	2.61	300	B300MBT13XKF
4	3.04	350	B350MBT13XKF
6	4.35	500	B500MBT13XKF
6	6.52	750	B750MBT13XKF
6	8.70	1000	B1K0MBT13XKF
6	13.04	1500	B1K5MBT13XKF
6	17.39	2000	B2K0MBT13XKH
6	26.09	3000	B3K0MBT13XXH
6	43.48	5000	B5K0MBT13XXH

T	F.L.A.	VA	CATALOG NUMBER
4	2.08/0.44	50	B050-2000-1
4	3.13/0.65	75	B075-2001-1
4	4.17/0.87	100	B100-2002-1
4	6.25/1.30	150	B150-2003-1F
4	8.33/1.74	200	B200-2004-1F
4	10.42/2.17	250	B250-2005-1F
6	12.50/2.61	300	B300-2006-1F
6	14.58/3.04	350	B350-2007-1F
6	20.84/4.35	500	B500-2008-1F
6	31.30/6.50	750	B750-2009-1F
6	41.70/8.70	1000	B1K0-2010-1F

Blue is not Series 2

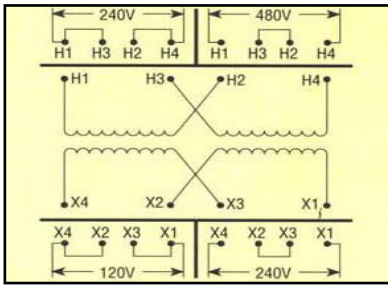

Primary: 240 x 480
Secondary: 120 x 240

T	F.L.A.	VA	CATALOG NUMBER
4	0.42/0.21	50	B050PU1519JJ
4	0.63/0.31	75	B075PU1519JJ
4	0.83/0.42	100	B100PU1519JJ
4	1.25/0.63	150	B150PU1519JJF
4	1.67/0.83	200	B200PU1519JJF
4	2.08/1.04	250	B250PU1519JJF
4	2.50/1.25	300	B300PU1519JJF
4	2.92/1.46	350	B350PU1519JJF
6	4.17/2.08	500	B500PU1519JJF
6	6.25/3.12	750	B750PU1519JJF
6	8.70/4.35	1000	B1K0-0500-3F
6	13.04/6.52	1500	B1K5-0501-3H
6	17.39/8.70	2000	B2K0-0502-3H
6	26.09/13.04	3000	B3K0-0503-3H
6	43.48/21.74	5000	B5K0-0504-3H

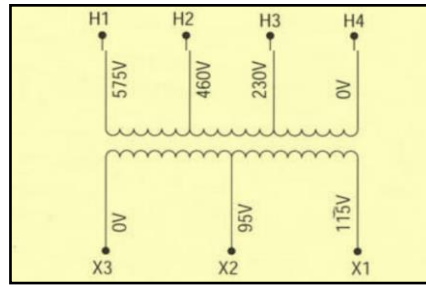

Primary: 230, 460, 575
Secondary: 95, 115

T	F.L.A.	VA	CATALOG NUMBER
4	0.53/0.44	50	B050BTW37XX
4	0.79/0.65	75	B075BTW37XX
4	1.05/0.87	100	B100BTW37XX
4	1.58/1.30	150	B150BTW37XXF
4	2.11/1.74	200	B200BTW37XXF
4	2.63/2.17	250	B250BTW37XXF
4	3.16/2.61	300	B300BTW37XXF
4	3.68/3.04	350	B350BTW37XXF
6	5.26/4.35	500	B500BTW37XXF
6	7.89/6.52	750	B750BTW37XXF
6	10.53/8.70	1000	B1K0BTW37XXKH
6	15.79/13.04	1500	B1K5BTW37XXKH
6	21.05/17.39	2000	B2K0BTW37XXKH
6	31.58/26.09	3000	B3K0BTW37XXKH
6	52.63/43.48	5000	B5K0BTW37XXKH

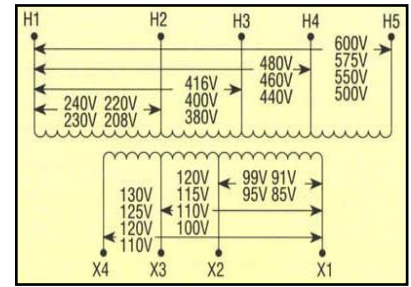

Primary: 208-600
Secondary: 85-130

T	F.L.A.	VA	CATALOG NUMBER
6	0.38	50	B050-0482-1
6	0.77	100	B100-0483-1
6	1.15	150	B150-0484-1F
6	1.92	250	B250-0485-1F
6	2.69	350	B350-0486-1F
6	3.85	500	B500-0487-1F
6	5.77	750	B750-0488-1F

IMPERVITRAN (non-Series 2)

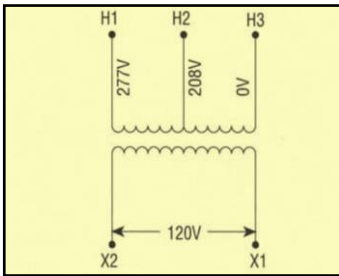

Primary: 208, 277
Secondary: 120

T	F.L.A.	VA	CATALOG NUMBER
4	0.42	50	B050MQ15XK
4	0.63	75	B075MQ15XK
4	0.83	100	B100MQ15XK
4	1.25	150	B150MQ15XKF
4	1.67	200	B200MQ15XKF
4	2.08	250	B250MQ15XKF
4	2.50	300	B300MQ15XKF
4	2.92	350	B350MQ15XKF
6	4.17	500	B500MQ15XKF
6	6.25	750	B750MQ15XKF

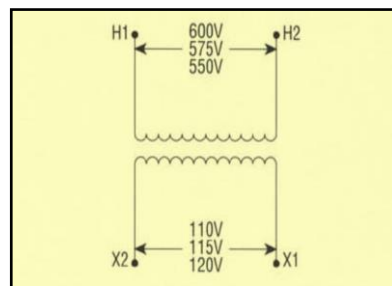

Primary: 550/575/600
Secondary: 110/115/120

T	F.L.A.	VA	CATALOG NUMBER
4	0.42	50	B050WZ13XK
4	0.65	75	B075WZ13XK
4	0.87	100	B100WZ13XK
4	1.30	150	B150WZ13XKF
4	1.74	200	B200WZ13XKF
4	2.17	250	B250WZ13XKF
4	2.61	300	B300WZ13XKF
4	3.04	350	B350WZ13XKF
6	4.35	500	B500WZ13XKF
6	6.52	750	B750WZ13XKF

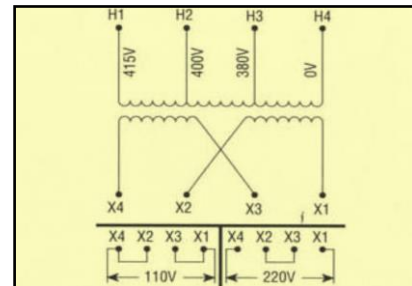

Primary: 380, 400, 415
Secondary: 110 x 220

T	F.L.A.	VA	CATALOG NUMBER
4	0.46/0.23	50	B050RFD34XJ
4	0.68/0.34	75	B075RFD34XJ
4	0.91/0.46	100	B100RFD34XJ
4	1.37/0.69	150	B150RFD34XJF
4	1.82/0.91	200	B200RFD34XJF
4	2.28/1.14	250	B250RFD34XJF
4	2.72/1.36	300	B300RFD34XJF
4	3.18/1.59	350	B350RFD34XJF
6	4.55/2.27	500	B500RFD34XJF
6	6.82/3.41	750	B750RFD34XJF

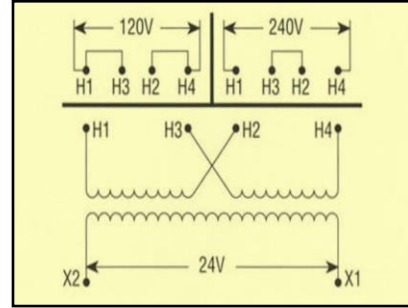
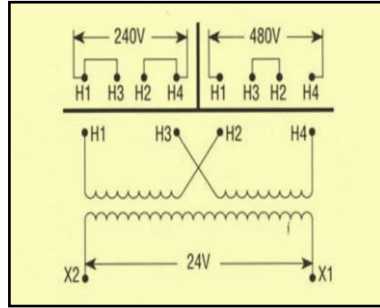
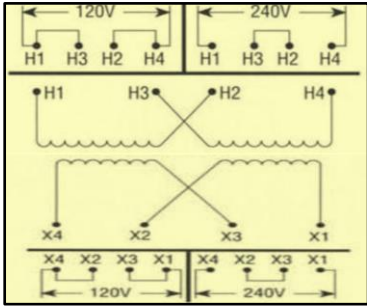

Primary: 120 x 240 Secondary: 120 x 240			
T	F.L.A.	VA	CATALOG NUMBER
4	0.42/0.21	50	B050LP1519JJ
4	0.83/0.42	100	B100LP1519JJ
4	1.25/0.63	150	B150LP1519JJF
4	2.08/1.04	250	B250LP1519JJF
4	2.92/1.46	350	B350LP1519JJF
6	4.17/2.08	500	B500LP1519JJF
6	6.25/3.12	750	B750LP1519JJF

Primary: 240 x 480 Secondary: 24			
T	F.L.A.	VA	CATALOG NUMBER
4	2.08	50	B050PU7JK
4	3.13	75	B075PU7JK
4	4.17	100	B100PU7JK
4	6.25	150	B150PU7JKF
4	8.33	200	B200PU7JKF
4	10.42	250	B250PU7JKF
4	12.50	300	B300PU7JKF
4	14.58	350	B350PU7JKF
6	20.83	500	B500PU7JKF
6	31.25	750	B750PU7JKF

Primary: 120 x 240 Secondary: 24			
T	F.L.A.	VA	CATALOG NUMBER
4	2.08	50	B050LP7JK
4	3.13	75	B075LP7JK
4	4.17	100	B100LP7JK
4	6.25	150	B150LP7JKF
4	8.33	200	B200LP7JKF
4	10.42	250	B250LP7JKF
4	12.50	300	B300LP7JKF
4	14.58	350	B350LP7JKF
6	20.83	500	B500LP7JKF
6	31.25	750	B750LP7JKF

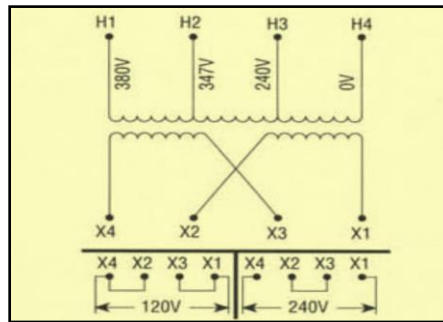
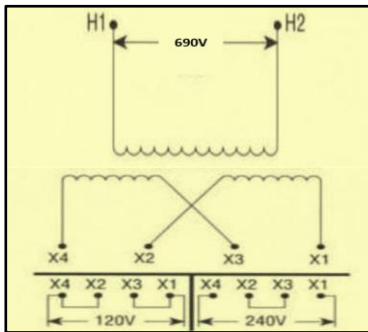

(non UL) Primary: 690 (non CSA) Secondary: 120 x 240			
T	F.L.A.	VA	CATALOG NUMBER
4	0.42/0.21	50	B050-3656-5
4	0.83/0.42	100	B100-3657-5
4	1.25/0.63	150	B150-0653-5F
4	2.08/1.04	250	B250-0654-5F
4	2.92/1.46	350	B350-0655-5F
6	4.17/2.08	500	B500-0656-5F
6	6.25/3.12	750	B750-0657-5F

Primary: 240, 347, 380 Secondary: 120 x 240			
T	F.L.A.	VA	CATALOG NUMBER
6	8.33/4.17	1000	B1K0-0321-3F
6	12.50/6.25	1500	B1K5-0322-3H
6	16.67/8.33	2000	B2K0-0323-3H
6	25.00/12.50	3000	B3K0-0324-3H
6	41.67/20.83	5000	B5K0-0325-3H
IMPERVITRAN (Non-Series 2)			

MICRON ALSO OFFERS THE *DI*Nergy™ LINE OF INDUSTRIAL DIN-MOUNT POWER SUPPLIES FROM 18 – 960 WATT PLUS SINGLE PHASE AND THREE PHASE LVGP, BUCK-BOOST TRANSFORMERS AND SPECIALTY MAGNETICS

ImperviTRAN™ PRODUCT DIMENSIONAL DATA

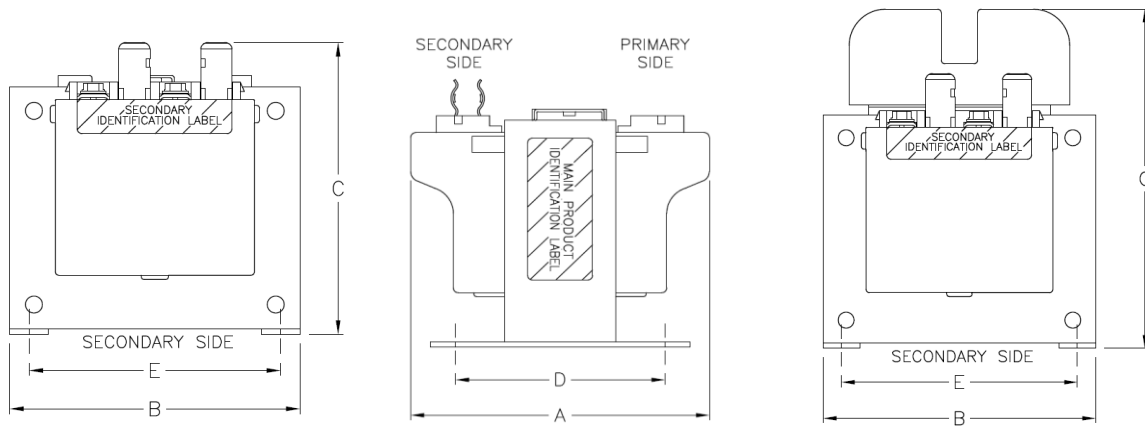

Series 2 Depicted

Note: Dimension “C” is always depicted as a maximum dimension
 Primary fuse block adds 1.375” (35MM) to the “C” dimension
 Deduct 0.50” (12.7MM) from “C” dimension when removing secondary fuse clips

All highlighted in yellow matches footprint to identical VA “BTZ13” design

MATCHED DIMENSIONS: 50-750VA Yellow highlight equals match to same VA, BTZ13 footprint

Voltage Groups: BTZ13, PU7, LP7, WZ13, MQ15, RFD34, PU1519, LP1519

VA	SERIES 2 (MAX)		ALL VERSIONS		INC'L FUSE CLIP		ALL VERSIONS		ALL VERSIONS		W
DIMENSIONS	INCH	MM	INCH	MM	INCH	MM	INCH	MM	INCH	MM	LBS
50	3.78	96	3.00	76	3.14	79	1.96	50	2.50	64	2.70
75	4.00	102	3.00	76	3.14	79	2.42	62	2.50	64	3.40
100	4.00	102	3.38	86	3.46	88	2.45	62	2.81	71	4.40
150	4.03	102	3.75	95	3.77	96	2.82	71	3.13	79	6.00
200	4.38	111	4.50	114	4.40	112	2.42	62	3.75	95	8.90
250	4.38	111	4.50	114	4.40	112	2.82	71	3.75	95	9.30
300	4.75	121	4.50	114	4.40	112	3.18	81	3.75	95	11.00
350	4.75	121	4.50	114	4.40	112	3.75	95	3.75	95	11.60
500	6.11	155	5.25	133	5.14	131	3.88	99	4.38	111	17.40
750	7.61	193	5.25	133	5.14	131	5.38	137	4.38	111	26.50

THE FOLLOWING DIMENSIONS DIFFER FROM THE PREVIOUSLY LISTED VA RATINGS

MBT13 -- Pri: 208, 230, 460 Sec: 115

VA	SERIES 2 (MAX)		ALL VERSIONS		INC'L FUSE CLIP		ALL VERSIONS		ALL VERSIONS		W
DIMENSIONS	INCH	MM	INCH	MM	INCH	MM	INCH	MM	INCH	MM	LBS
B050MBT13XK	3.78	96	3.00	76	3.14	79	2.21	56	2.50	64	2.70
B075MBT13XK	4.00	102	3.38	86	3.46	88	2.45	63	2.82	71	3.40
B100MBT13XK	4.00	102	3.38	86	3.46	88	2.62	67	2.81	71	4.40
B150MBT13XKF	4.03	102	3.75	95	3.77	96	2.82	71	3.13	79	5.60
B200MBT13XKF	4.38	111	4.50	114	4.40	112	2.82	71	3.75	95	9.10
B250MBT13XKF	4.75	121	4.50	114	4.40	112	3.18	81	3.75	95	10.80
B300MBT13XKF	4.75	121	4.50	114	4.40	112	3.75	95	3.75	95	11.20
B350MBT13XKF	5.75	146	4.50	114	4.40	112	4.72	120	3.75	95	12.40
B500MBT13XKF	6.11	155	5.25	133	5.14	131	4.38	111	4.38	111	17.40
B750MBT13XKF	7.61	193	5.25	133	5.14	131	5.87	149	4.38	111	26.20

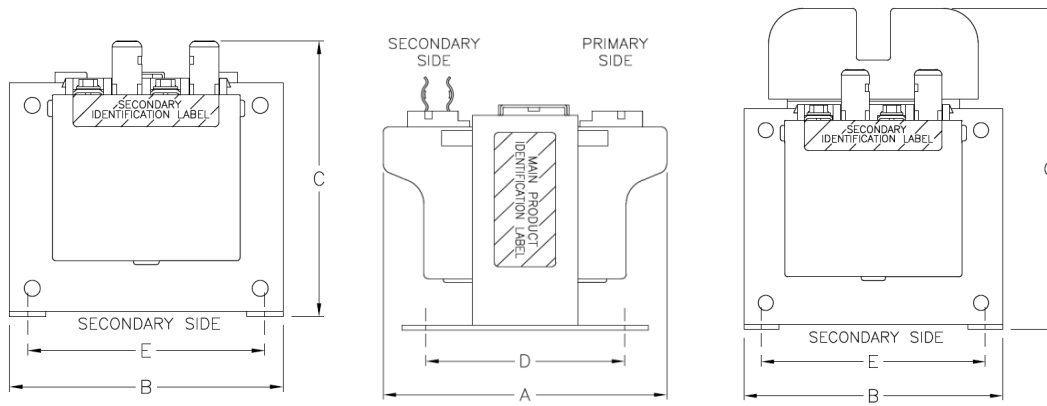

Series 2 Depicted

BTW37 -- Pri: 230, 460, 575 Sec: 95, 115

VA	SERIES 2 (MAX)		ALL VERSIONS		NO FUSE CLIP		ALL VERSIONS		ALL VERSIONS		W
	INCH	MM	INCH	MM	INCH	MM	INCH	MM	INCH	MM	
B050BTW37XX	4.03	102	3.00	76	2.72	69	2.20	56	2.50	64	3.20
B075BTW37XX	4.03	102	3.38	86	3.04	77	2.42	62	2.81	71	4.20
B100BTW37XX	4.50	114	3.38	86	3.04	77	2.81	71	2.81	71	5.50
B150BTW37XXF	4.53	115	3.75	95	3.36	85	3.18	81	3.13	79	7.70
B200BTW37XXF	4.38	111	3.75	95	3.98	101	2.82	72	3.75	95	9.10
B250BTW37XXF	4.38	111	4.50	114	3.98	101	3.18	81	3.75	95	9.50
B300BTW37XXF	4.75	121	4.50	114	3.98	101	3.75	95	3.75	95	11.60
B350BTW37XXF	5.61	143	5.25	133	4.63	118	3.38	86	4.38	111	13.80
B500BTW37XXF	6.19	157	5.25	133	4.63	118	4.38	111	4.38	111	17.60
B750BTW37XXF	8.11	206	5.25	133	4.63	118	5.87	149	4.38	111	29.90

GROUP J – (SERIES 2 VERSION OF MBT713)

*B1K0-2010-1F IS NON SERIES 2

Pri: -- 208, 230, 460 Sec: 24, 115

Red highlight equals match to same VA Group J footprint

All highlighted in red matches footprint to identical VA "Group J" design

VA					INC'L FUSE CLIP						W
	INCH	MM	INCH	MM	INCH	MM	INCH	MM	INCH	MM	
B050-2000-1	4.53	115	3.00	76	3.14	79	2.81	71	2.50	64	4.30
B075-2001-1	4.50	114	3.38	86	3.46	88	2.81	71	2.81	71	5.50
B100-2002-1	4.53	115	3.75	95	3.78	96	3.00	76	3.13	79	6.50
B150-2003-1F	5.03	128	3.75	95	3.78	96	3.18	81	3.13	79	9.50
B200-2004-1F	4.38	111	4.50	114	4.40	112	3.00	76	3.75	95	9.80
B250-2005-1F	4.75	121	4.50	114	4.40	112	3.75	95	3.75	95	11.30
B300-2006-1F	6.11	155	5.25	133	5.14	131	3.88	99	4.38	111	14.10
B350-2007-1F	6.11	155	5.25	133	5.14	131	3.88	99	4.38	111	16.40
B500-2008-1F	7.11	181	5.25	133	5.14	131	5.38	137	4.38	111	23.10
B750-2009-1F	7.11	181	6.75	172	6.30	160	5.00	127	6.13	156	38.60
*B1K0-2010-1F	8.13	207	6.75	172	5.73	146	6.13	156	6.13	156	48.40

Universal Voltage – Pri: 208-600 Sec: 85-130

ALL ARE NON SERIES 2

VA					INC'L FUSE CLIP						W
	INCH	MM	INCH	MM	INCH	MM	INCH	MM	INCH	MM	
B050-0482-1	3.44	87	3.88	99	3.38	86	2.41	61	2.81	71	4.00
B100-0483-1	4.00	102	3.75	95	3.62	92	3.00	76	3.13	79	6.80
B150-0484-1F	4.00	102	4.50	114	4.11	104	2.82	71	3.75	95	7.90
B250-0485-1F	5.75	146	4.50	114	4.11	104	4.73	120	3.75	95	10.00
B350-0486-1F	5.69	145	5.25	133	4.64	118	4.38	111	4.38	111	13.60
B500-0487-1F	7.19	183	5.25	133	4.95	126	5.88	149	4.38	111	18.20
B750-0488-1F	6.44	164	6.75	172	5.73	146	4.25	108	6.13	156	30.70

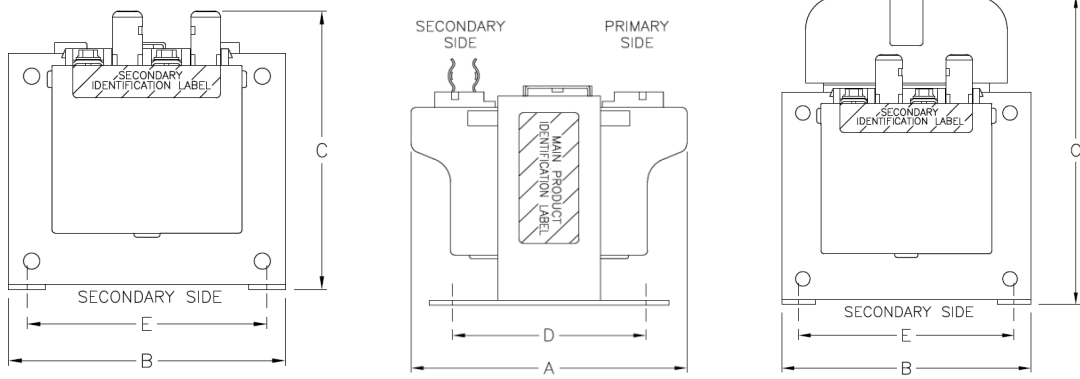

Series 2 Depicted

Special Products – Pri: 690, Sec: 120 x 240

VA	DIMENSIONS		NO FUSE CLIP		W	
	INCH	MM	INCH	MM	INCH	LBS
B050-3656-3	3.78	96	3.00	76	2.95	2.70
B100-3657-3	4.00	102	3.38	86	3.27	4.10
B150-0653-5F	4.03	102	3.75	95	3.57	5.10
B250-0654-5F	4.37	111	4.50	114	4.20	8.80
B350-0655-5F	4.74	121	4.50	114	4.18	10.90
B500-0656-5F	6.11	155	5.25	133	4.94	16.20
B750-0657-5F	7.61	193	5.25	133	4.94	24.90

DIAGRAMS BELOW DEPICT SERIES 2 PRIMARY FUSING OPTION

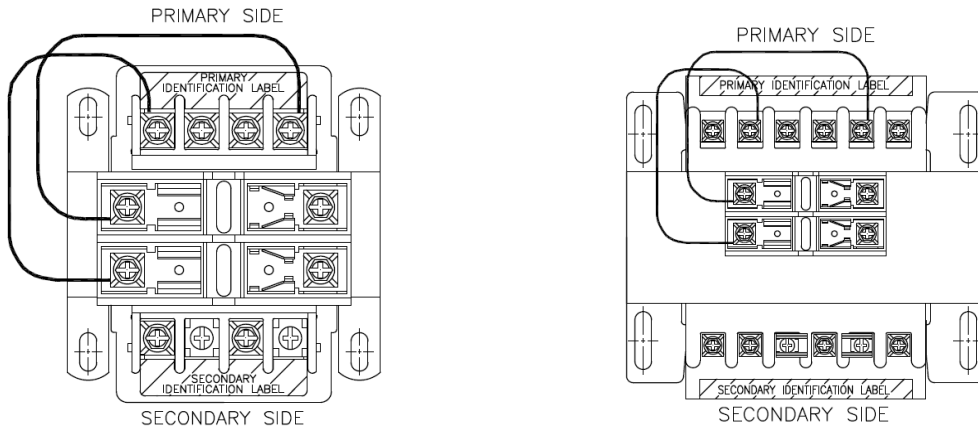

DIAGRAMS BELOW DEPICT NON-SERIES 2 PRIMARY FUSING OPTION

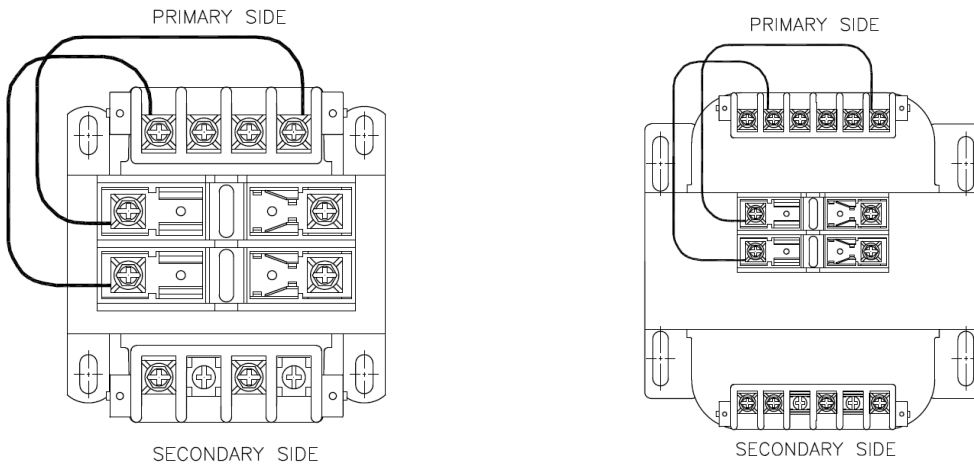

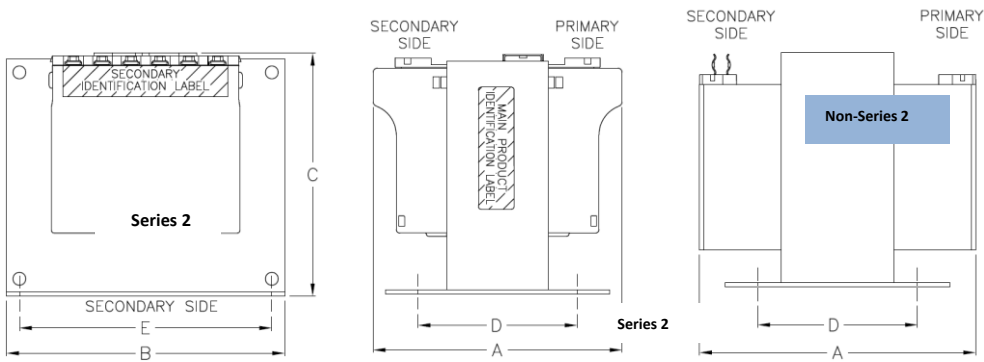

KVA SIZES: Can be either Series 2 or Non-Series 2

BTZ13 Pri: 230/460 Sec: 115 No secondary fuse clip > 2Kva Yellow highlight equals same VA footprint

VA					INC'L FUSE CLIP						W
DIMENSIONS	INCH	A MM	INCH	B MM	INCH	C MM	INCH	D MM	INCH	E MM	LBS
B1K0BTZ13JKF	6.11	155	6.75	172	6.30	160	3.91	99	6.13	156	30.50
B1K5BTZ13JKF	8.11	206	6.75	172	6.32	161	6.13	156	6.13	156	50.10
B2K0BTZ13JKH	7.75	197	6.75	172	6.28	160	6.13	156	6.13	156	46.10
B3K0BTZ13JXH	8.00	203	9.00	229	7.50	191	5.25	133	7.50	191	68.80
B5K0BTZ13JXH	10.00	254	9.00	229	7.50	191	7.19	183	7.50	191	109.40

MBT13 Pri: 208, 230, 460 Sec: 115 No secondary fuse clip > 2Kva

VA					INC'L FUSE CLIP						W
DIMENSIONS	INCH	A MM	INCH	B MM	INCH	C MM	INCH	D MM	INCH	E MM	LBS
B1K0MBT13XKF	7.45	189	6.38	162	5.42	138	5.06	129	5.31	135	37.00
B1K5MBT13XKF	8.50	216	6.75	172	5.75	146	6.09	155	6.13	156	53.90
B2K0MBT13XKH	8.13	207	6.75	172	6.28	160	5.25	133	6.13	156	51.60
B3K0MBT13XXH	8.50	216	9.00	229	7.50	191	5.75	146	7.50	191	77.10
B5K0MBT13XXH	10.31	262	9.00	229	7.50	191	7.56	192	7.50	191	114.60

BTWZ37 Pri: 230/460/575 Sec: 95/115 No secondary fuse clip > 2Kva

VA					INC'L FUSE CLIP						W
DIMENSIONS	INCH	A MM	INCH	B MM	INCH	C MM	INCH	D MM	INCH	E MM	LBS
B1K0BTWZ37XKH	7.00	178	6.38	162	5.42	138	5.06	129	5.31	135	31.80
B1K5BTWZ37XKH	7.45	189	6.75	172	6.29	160	5.25	133	6.13	156	44.20
B2K0BTWZ37XKH	7.56	192	9.00	229	7.80	198	4.81	122	7.50	191	57.70
B3K0BTWZ37XXH	8.69	221	9.00	229	7.50	191	5.94	151	7.50	191	83.60
B5K0BTWZ37XXH	11.00	279	9.00	229	7.50	191	8.19	208	7.50	191	129.40

PU1519 Pri: 240 x 480 Sec: 120 x 240

VA					NO FUSE CLIP						W
DIMENSIONS	INCH	A MM	INCH	B MM	INCH	C MM	INCH	D MM	INCH	E MM	LBS
B1K0-0500-3F	7.00	178	5.25	133	4.48	114	5.38	137	4.38	111	28.8
B1K5-0501-3H	7.00	178	6.75	172	5.75	146	4.25	108	6.13	156	37.00
B2K0-0502-3H	7.75	197	6.75	172	5.73	146	4.97	126	6.13	156	46.00
B3K0-0503-3H	8.00	203	9.00	229	7.62	194	5.25	133	7.50	191	80.00
B5K0-0504-3H	10.00	254	9.00	229	7.50	191	7.19	183	7.50	191	114.60

Special Voltages – Pri: 240, 347, 380 Sec: 120 x 240

VA					NO FUSE CLIP						W
DIMENSIONS	INCH	A MM	INCH	B MM	INCH	C MM	INCH	D MM	INCH	E MM	LBS
B1K0-0321-3F	7.19	183	6.38	162	5.42	138	5.06	129	5.31	135	29.00
B1K5-0322-3H	8.13	207	6.38	162	5.44	138	5.06	129	5.31	135	33.30
B2K0-0323-3H	8.88	226	6.75	172	5.79	147	6.13	156	6.13	156	61.10
B3K0-0324-3H	8.50	216	9.00	229	7.62	194	5.69	146	7.50	191	80.00
B5K0-0325-3H	10.31	262	9.00	229	7.50	191	7.56	192	7.50	191	114.60

GlobalTRAN™ PRODUCT SELECTION GUIDE

GENERAL SPECIFICATIONS: ALL ARE 50/60 Hz RATED

BUILDING STYLE:

ImperviTRAN (non-Series 2)

APPROVALS: UL File #E46323/CSA File #LR27533/CE to EN61558-2-2

GlobalTran includes installed IP-20 terminal covers

TERMINAL TIGHTENING TORQUE (ALL IMPERVITRAN STYLES):

≤30A: 20 lb/in

>30A: 30 lb/in

SUFFIX DESCRIPTION:

The GlobalTRAN product is defined by serialized part numbers ending in the basic suffix “GA”

Two letter suffix denotes Temp Class 105°C

Three letter suffix ending in “F” denotes Temp Class 130°C

Three letter suffix ending in “H” denotes Temp Class 180°C

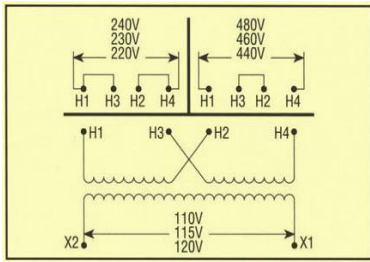

Primary: 220 x 440, 230 x 460,
240 x 480
Secondary: 110/115/120

T	F.L.A.	VA	CATALOG NUMBER
4	0.43	50	B050-2001-GA
4	0.65	75	B075-2002-GA
4	0.87	100	B100-2003-GA
4	1.30	150	B150-2004-GAF
4	1.74	200	B200-2005-GAF
4	2.17	250	B250-2006-GAF
4	2.61	300	B300-2007-GAF
4	3.04	350	B350-2008-GAF
4	4.35	500	B500-2009-GAF
4	6.52	750	B750-2010-GAF
6	8.70	1000	B1K0-2008-GAH
6	13.04	1500	B1K5-2009-GAH
6	17.39	2000	B2K0-2010-GAH
6	26.09	3000	B3K0-2011-GAH
6	45.45	5000	B5K0-2012-GAH

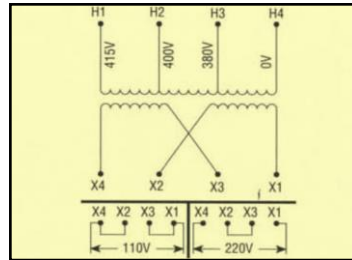

Primary: 380, 400, 415
Secondary: 110 x 220

T	F.L.A.	VA	CATALOG NUMBER
4	0.46/0.23	50	B050-2061-GA
4	0.68/0.34	75	B075-2062-GA
4	0.91/0.46	100	B100-2063-GA
4	1.37/0.69	150	B150-2064-GAF
4	1.82/0.91	200	B200-2065-GAF
4	2.28/1.14	250	B250-2066-GAF
4	2.72/1.36	300	B300-2067-GAF
4	3.18/1.59	350	B350-2068-GAF
4	4.55/2.27	500	B500-2069-GAF
4	6.82/3.41	750	B750-2070-GAF

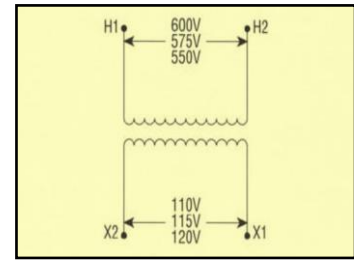

Primary: 550/575/600
Secondary: 110/115/120

T	F.L.A.	VA	CATALOG NUMBER
4	0.43	50	B050-2041-GA
4	0.65	75	B075-2042-GA
4	0.87	100	B100-2043-GA
4	1.30	150	B150-2044-GAF
4	1.74	200	B200-2045-GAF
4	2.17	250	B250-2046-GAF
4	2.61	300	B300-2047-GAF
4	3.04	350	B350-2048-GAF
4	4.35	500	B500-2049-GAF
4	6.52	750	B750-2050-GAF

MICRON ALSO OFFERS THE DINergy™ LINE OF INDUSTRIAL DIN-MOUNT POWER SUPPLIES FROM 18 – 960 WATT PLUS SINGLE PHASE AND THREE PHASE LVGP, BUCK-BOOST TRANSFORMERS AND SPECIALTY MAGNETICS

250VA – 1KVA

1.5KVA – 5KVA

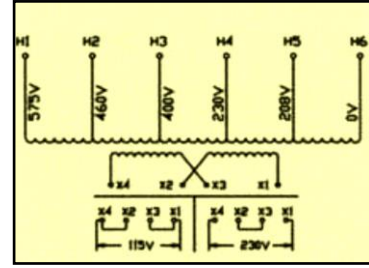
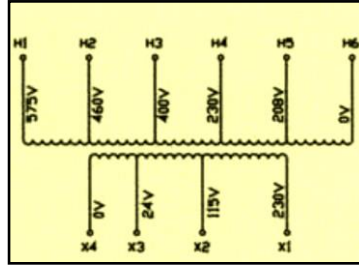
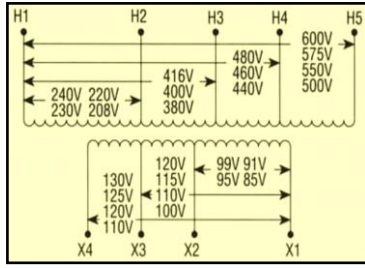

Primary: 208 – 600 Secondary: 85 – 130			
T	F.L.A.	VA	CATALOG NUMBER
6/4	1.92	250	B250-2283-GAF
6/4	2.31	300	B300-2284-GAF
6/4	2.69	350	B350-2285-GAF
6/4	3.85	500	B500-2286-GAF
6/4	5.77	750	B750-2287-GAF
6	7.69	1000	B1K0-2288-GAH
6	11.54	1500	B1K5-2289-GAH
6	15.38	2000	B2K0-2290-GAH
6	23.08	3000	B3K0-2291-GAH

Primary: 230/400/460/575 Secondary: 24/115/230			
T	F.L.A.	VA	CATALOG NUMBER
4	10.42/2.17/1.10	250	B250-2263-GAF
4	12.50/2.61/1.30	300	B300-2264-GAF
4	14.58/3.04/1.50	350	B350-2265-GAF
4	20.84/4.35/2.20	500	B500-2266-GAF
6	31.30/6.50/3.30	750	B750-2267-GAF
6	41.70/8.70/4.30	1000	B1K0-2268-GAH
6	XX/13.04/6.52	1500	B1K5-2269-GAH
6	XX/17.39/8.70	2000	B2K0-2270-GAH
6	XX/26.09/13.04	3000	B3K0-2271-GAH
6	XX/43.48/21.74	5000	B5K0-2272-GAH

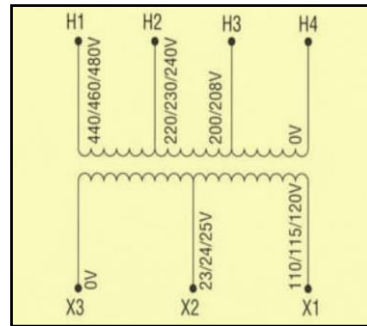
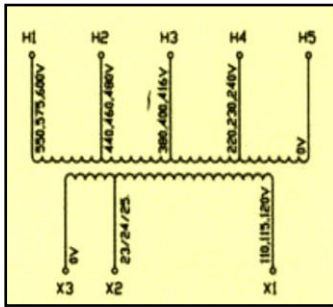

Primary: 230/400/460/575 Secondary: 24/115			
T	F.L.A.	VA	CATALOG NUMBER
6/4	10.40/2.20	250	B250-2243-GAF
6/4	12.50/2.60	300	B300-2244-GAF
6/4	14.60/3.00	350	B350-2245-GAF
6/4	20.80/4.30	500	B500-2246-GAF
6/4	31.30/6.50	750	B750-2247-GAF
6/4	41.70/8.70	1000	B1K0-2248-GAH

Primary: 208/230/460 Secondary: 24/115				
T	T	F.L.A.	VA	CATALOG NUMBER
4	4	2.08/0.44	50	B050-2101-GA
4	4	3.13/0.65	75	B075-2102-GA
4	4	4.17/0.87	100	B100-2103-GA
4	4	6.25/1.30	150	B150-2104-GAF
4	4	8.33/1.74	200	B200-2105-GAF
4	4	10.42/2.17	250	B250-2106-GAF
4	4	12.50/2.61	300	B300-2107-GAF
4	4	14.58/3.04	350	B350-2108-GAF
4	4	20.84/4.35	500	B500-2109-GAF
4	6	31.30/6.50	750	B750-2110-GAF
6	6	41.70/8.70	1000	B1K0-2188-GAH

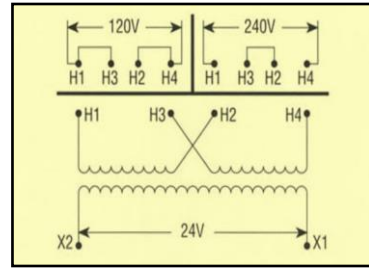
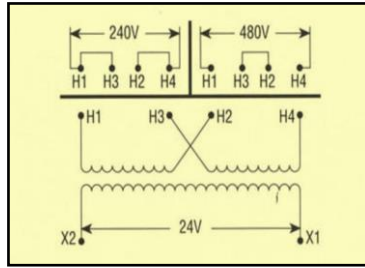
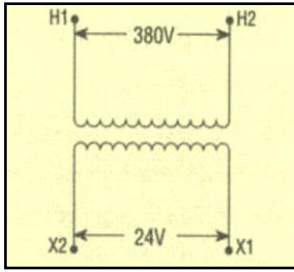

Primary: 380 Secondary: 24			
T	F.L.A.	VA	CATALOG NUMBER
4	2.08	50	B050-2051-GA
4	3.13	75	B075-2052-GA
4	4.17	100	B100-2053-GA
4	6.25	150	B150-2054-GAF
4	8.33	200	B200-2055-GAF
4	10.42	250	B250-2056-GAF
4	12.50	300	B300-2057-GAF
4	14.48	350	B350-2058-GAF
4	20.83	500	B500-2059-GAF
4	31.25	750	B750-2060-GAF

Primary: 240 x 480 Secondary: 24			
T	F.L.A.	VA	CATALOG NUMBER
4	2.08	50	B050-2011-GA
4	3.13	75	B075-2012-GA
4	4.17	100	B100-2013-GA
4	6.25	150	B150-2014-GAF
4	8.33	200	B200-2015-GAF
4	10.42	250	B250-2016-GAF
4	12.50	300	B300-2017-GAF
4	14.48	350	B350-2018-GAF
4	20.83	500	B500-2019-GAF
4	31.25	750	B750-2020-GAF
6	41.67	1000	B1K0-2028-GAF

Primary: 120 x 240 Secondary: 24			
T	F.L.A.	VA	CATALOG NUMBER
4	2.08	50	B050-2021-GA
4	3.13	75	B075-2022-GA
4	4.17	100	B100-2023-GA
4	6.25	150	B150-2024-GAF
4	8.33	200	B200-2025-GAF
4	10.42	250	B250-2026-GAF
4	12.50	300	B300-2027-GAF
4	14.48	350	B350-2028-GAF
4	20.83	500	B500-2029-GAF
4	31.25	750	B750-2030-GAF
6	41.67	1000	B1K0-2048-GAF

GlobalTRAN™ PRODUCT DIMENSIONAL DATA

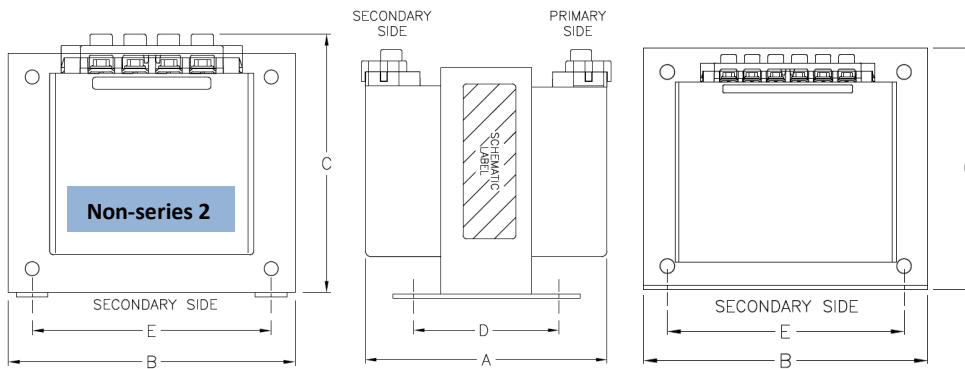

Voltage – Pri: 230/460 Sec: 115

VA	DIMENSIONS		INCH		MM		INCH		MM		W
	INCH	MM	INCH	MM	INCH	MM	INCH	MM	INCH	MM	LBS
B050-2001-GA	3.38	86	3.00	76	3.00	76	2.44	61	2.50	64	3.40
B075-2002-GA	3.46	88	3.38	86	3.25	83	2.44	61	2.81	71	4.80
B100-2003-GA	3.38	86	3.75	95	3.50	89	2.44	61	3.13	79	5.90
B150-2004-GAF	3.75	95	4.50	114	4.00	102	2.44	61	3.75	95	8.50
B200-2005-GAF	3.75	95	4.50	114	4.00	102	2.81	71	3.75	95	10.00
B250-2006-GAF	4.00	102	4.50	114	4.00	102	3.19	81	3.75	95	11.00
B300-2007-GAF	4.38	111	4.50	114	4.00	102	3.75	95	3.75	95	13.00
B350-2008-GAF	4.95	126	5.25	133	4.50	114	3.38	86	4.38	111	15.00
B500-2009-GAF	5.13	130	5.25	133	4.50	114	4.38	111	4.38	111	20.00
B750-2010-GAF	7.00	178	5.25	133	5.00	127	5.88	149	4.38	111	29.80
B1K0-2008-GAH	6.63	168	6.38	162	5.50	140	3.75	95	5.31	135	35.00
B1K5-2009-GAH	7.31	186	6.75	172	6.00	152	5.00	127	6.13	156	40.00
B2K0-2010-GAH	8.13	203	6.75	172	6.00	152	5.25	133	6.13	156	45.00
B3K0-2011-GAH	8.06	202	9.00	225	8.00	200	5.25	133	7.50	191	65.20
B5K0-2012-GAH	10.00	250	9.00	225	8.00	200	7.19	183	7.50	191	104.80

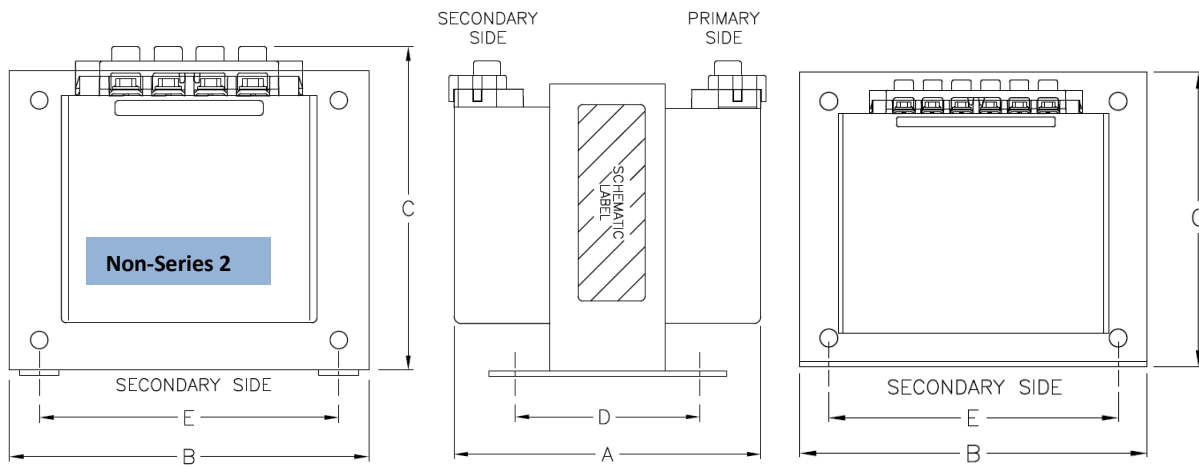

Voltage – Pri: 380, 400, 415 Sec: 110 x 220

VA	INCH A		INCH B		INCH C		INCH D		INCH E		W
DIMENSIONS	MM	MM	MM	MM	MM	MM	MM	MM	MM	LBS	
B050-2061-GA	3.38	86	3.00	76	3.00	76	2.44	61	2.50	64	3.40
B075-2062-GA	3.46	88	3.38	86	3.25	83	2.44	61	2.81	71	4.80
B100-2063-GA	3.38	86	3.75	95	3.50	89	2.44	61	3.13	79	5.90
B150-2064-GAF	3.75	95	4.50	114	4.00	102	2.44	61	3.75	95	8.50
B200-2065-GAF	3.75	95	4.50	114	4.00	102	3.00	76	3.75	95	10.00
B250-2066-GAF	4.00	102	4.50	114	4.00	102	3.19	81	3.75	95	11.00
B300-2067-GAF	4.38	111	4.50	114	4.00	102	3.75	95	3.75	95	13.00
B350-2068-GAF	4.75	121	4.50	114	4.00	102	3.75	95	3.75	95	15.00
B500-2069-GAF	5.13	130	5.25	133	4.50	114	4.38	111	4.38	111	20.00
B750-2070-GAF	7.00	178	5.25	133	4.50	114	5.88	149	4.38	111	27.00

Voltage – Pri: 550/575/600 Sec: 110/115/120

VA	INCH A		INCH B		INCH C		INCH D		INCH E		W
DIMENSIONS	MM	MM	MM	MM	MM	MM	MM	MM	MM	LBS	
B050-2041-GA	3.38	86	3.00	76	3.00	76	2.44	61	2.50	64	3.40
B075-2042-GA	3.38	86	3.38	86	3.25	83	2.44	61	2.81	71	4.80
B100-2043-GA	3.38	86	3.75	95	3.50	89	2.44	61	3.13	80	5.90
B150-2044-GAF	3.75	95	4.50	114	4.00	102	2.44	61	3.75	95	8.50
B200-2045-GAF	3.75	95	4.50	114	4.00	102	3.00	76	3.75	95	10.00
B250-2046-GAF	4.00	102	4.50	114	4.00	102	3.19	81	3.75	95	11.00
B300-2047-GAF	4.38	111	4.50	114	4.00	102	3.75	95	3.75	95	13.00
B350-2048-GAF	4.50	114	5.25	133	4.50	114	3.38	86	4.38	111	15.00
B500-2049-GAF	5.13	130	5.25	133	4.50	114	4.38	111	4.38	111	20.00
B750-2050-GAF	7.00	178	5.25	133	4.50	114	5.38	137	4.38	111	28.00

Voltage – Universal Pri: 208-600 Sec: 85-130

VA	INCH A		INCH B		INCH C		INCH D		INCH E		W
DIMENSIONS	MM	MM	MM	MM	MM	MM	MM	MM	MM	LBS	
B250-2283-GAF	4.25	108	4.50	114	4.00	102	3.44	86	3.75	95	11.40
B300-2284-GAF	4.75	121	4.50	114	4.00	102	3.75	95	3.75	95	13.60
B350-2285-GAF	5.25	133	4.50	114	4.11	104	3.75	95	3.75	95	14.20
B500-2286-GAF	5.50	140	5.25	133	4.66	118	3.88	99	4.38	111	17.40
B750-2287-GAF	7.38	187	5.25	133	4.78	121	5.88	149	4.38	111	27.50
B1K0-2288-GAH	7.00	178	6.38	162	5.50	140	5.06	129	5.31	135	27.90
B1K5-2289-GAH	7.75	199	6.75	171	6.00	152	5.00	127	6.13	156	43.10
B2K0-2290-GAH	7.63	194	9.00	229	8.00	203	4.81	122	7.50	191	56.00
B3K0-2291-GAH	8.56	217	9.00	229	7.63	194	5.75	146	7.50	191	76.20

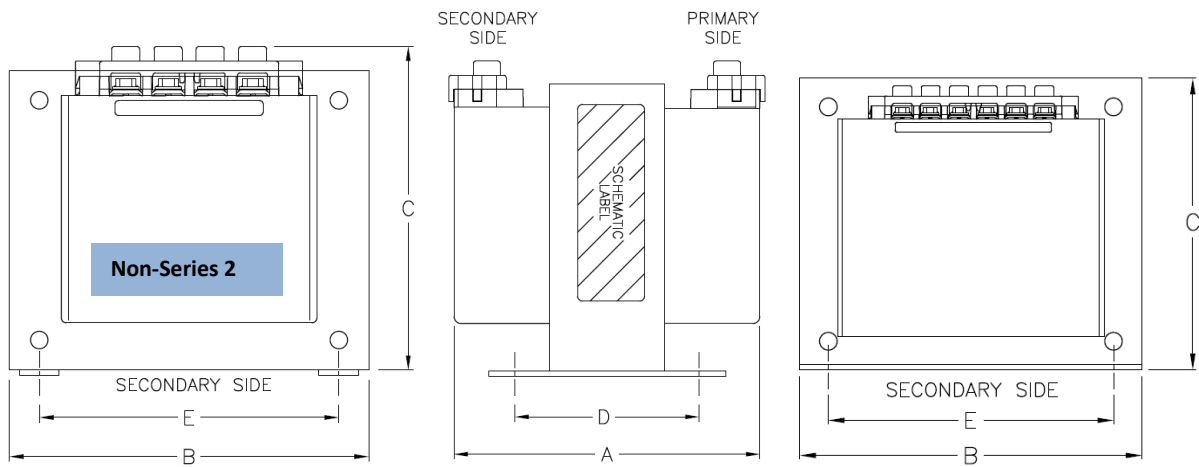

Voltage -- Pri: 208/230/400/460/575 Sec: 24*/115/230

VA	INCH A		INCH B		INCH C		INCH D		INCH E		W
DIMENSIONS	MM	MM	MM	MM	MM	MM	MM	MM	MM	LBS	
B250-2263-GAF	4.75	121	4.50	114	4.00	102	4.75	121	3.75	95	14.90
B300-2264-GAF	5.25	133	4.50	114	4.00	102	4.75	121	3.75	95	17.40
B350-2265-GAF	5.60	145	5.25	133	4.50	114	4.38	111	4.38	111	17.80
B500-2266-GAF	7.19	183	5.25	133	4.75	121	5.88	149	4.38	111	26.60
B750-2267-GAF	7.44	189	6.38	162	5.56	141	5.06	129	5.31	135	32.50
B1K0-2268-GAH	7.75	199	6.75	171	6.25	159	5.00	127	6.13	156	44.00
B1K5-2269-GAH	7.75	199	6.75	171	6.00	152	5.00	127	6.13	156	45.40
B2K0-2270-GAH	7.63	194	9.00	229	7.63	194	4.81	122	7.50	191	58.60
B3K0-2271-GAH	8.75	222	9.00	229	7.63	194	5.94	151	7.50	191	92.90
B5K0-2272-GAH	10.44	265	9.00	229	7.63	194	7.63	194	7.50	191	127.40

Voltage -- Pri: 230/400/460/575 Sec: 24/115

VA	INCH A		INCH B		INCH C		INCH D		INCH E		W
DIMENSIONS	MM	MM	MM	MM	MM	MM	MM	MM	MM	LBS	
B250-2243-GAF	4.75	121	4.50	114	4.00	102	3.75	95	3.75	95	14.30
B300-2244-GAF	5.00	127	4.50	114	4.00	102	4.75	121	3.75	95	15.80
B350-2245-GAF	5.19	132	5.25	133	4.50	114	3.88	99	4.38	111	16.50
B500-2246-GAF	6.19	157	5.25	133	4.50	114	4.88	124	4.38	111	20.50
B750-2247-GAF	7.00	178	6.38	162	5.56	141	5.06	129	5.31	135	28.80
B1K0-2248-GAH	8.13	207	6.38	162	6.00	152	5.06	129	5.31	135	34.90

Voltage -- Pri: 208/230/460 Sec: 24/115

VA	INCH A		INCH B		INCH C		INCH D		INCH E		W
DIMENSIONS	MM	MM	MM	MM	MM	MM	MM	MM	MM	LBS	
B050-2101-GA	3.38	86	3.00	76	3.25	83	2.25	56	2.81	71	4.20
B075-2102-GA	3.38	86	3.38	86	3.50	89	2.44	61	3.13	79	5.90
B100-2103-GA	3.63	92	3.75	95	3.50	89	3.19	81	3.13	79	7.90
B150-2104-GAF	3.75	95	4.50	114	4.00	102	2.81	71	3.75	95	10.00
B200-2105-GAF	4.38	111	4.50	114	4.00	102	3.44	87	3.75	95	12.80
B250-2106-GAF	4.75	121	4.50	114	4.00	102	3.75	95	3.75	95	14.00
B300-2107-GAF	4.88	124	5.25	133	4.50	114	3.88	99	4.38	111	16.80
B350-2108-GAF	4.88	124	5.25	133	4.50	114	3.88	99	4.38	111	19.20
B500-2109-GAF	5.63	143	5.25	133	4.60	114	5.88	149	4.38	111	29.00
B750-2110-GAF	6.75	172	6.38	162	5.56	141	5.06	129	5.31	135	29.80
B1K0-2188-GAH	7.06	179	6.38	162	6.00	152	5.06	129	5.31	135	30.20

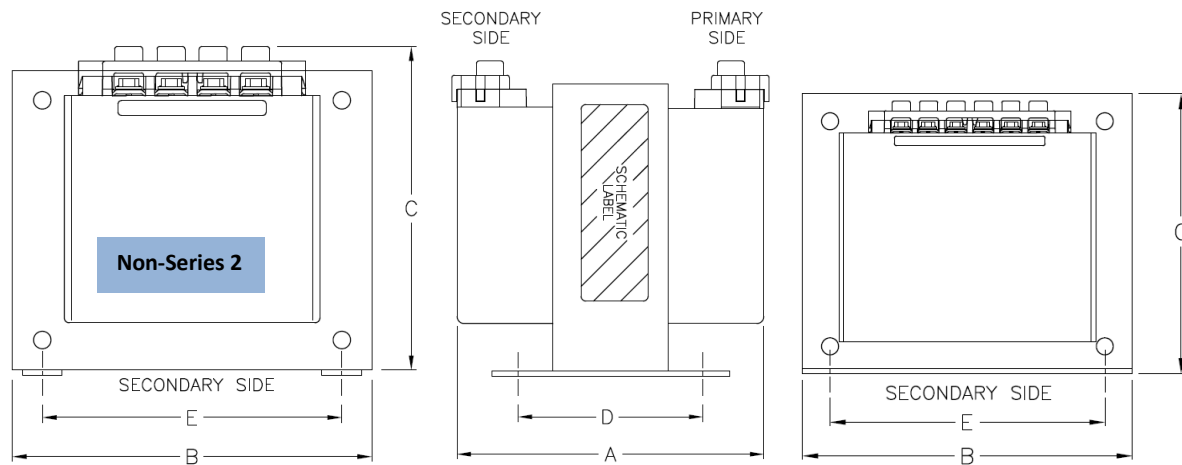

Voltage -- Pri: 380 Sec: 24

VA	INCH A		MM		INCH B		MM		INCH C		MM		INCH D		MM		INCH E		MM		W
DIMENSIONS																					LBS
B050-2051-GA	3.38		86		3.00		76		3.00		76		2.19		55		2.50		64		3.50
B075-2052-GA	3.46		88		3.38		86		3.25		83		2.19		55		2.81		71		4.20
B100-2053-GA	3.38		86		3.75		95		3.50		89		2.44		61		3.13		79		5.90
B150-2054-GAF	3.63		91		3.75		95		3.50		89		3.00		76		3.13		79		8.50
B200-2055-GAF	3.75		95		4.50		114		4.00		102		2.81		70		3.75		95		10.00
B250-2056-GAF	4.00		102		4.50		114		4.00		102		3.19		81		3.75		95		11.00
B300-2057-GAF	4.38		111		4.50		114		4.00		102		3.75		95		3.75		95		13.20
B350-2058-GAF	4.50		114		5.25		133		4.50		114		3.88		99		4.38		111		14.90
B500-2059-GAF	5.13		130		5.25		133		4.50		114		3.88		99		4.38		111		19.20
B750-2060-GAF	7.00		178		5.25		133		5.00		127		5.88		149		4.38		111		28.10

Voltage -- Pri: 240 x 480 Sec: 24

VA	INCH A		MM		INCH B		MM		INCH C		MM		INCH D		MM		INCH E		MM		W
DIMENSIONS																					LBS
B050-2011-GA	3.38		86		3.00		76		3.00		76		2.19		56		2.50		64		3.40
B075-2012-GA	3.38		86		3.38		86		3.25		83		2.19		56		2.81		71		4.20
B100-2013-GA	3.38		86		3.75		95		3.50		89		2.44		61		3.13		80		5.90
B150-2014-GAF	4.00		102		4.50		114		4.00		102		2.44		62		3.75		95		8.50
B200-2015-GAF	4.00		102		4.50		114		4.00		102		2.81		71		3.75		95		10.00
B250-2016-GAF	4.00		102		4.50		114		4.00		102		3.19		81		3.75		95		11.00
B300-2017-GAF	4.38		111		4.50		114		4.00		102		3.75		95		3.75		95		13.20
B350-2018-GAF	4.50		114		5.25		133		4.50		114		3.38		86		4.38		111		14.90
B500-2019-GAF	5.13		130		5.25		133		4.50		114		3.88		99		4.38		111		19.20
B750-2020-GAF	7.00		178		5.25		133		5.00		127		5.38		137		4.38		111		28.10
B1K0-2028-GAF	7.00		178		6.38		162		6.00		152		3.75		95		5.31		135		30.00

Voltage -- Pri: 120 x 240 Sec: 24

VA	INCH A		MM		INCH B		MM		INCH C		MM		INCH D		MM		INCH E		MM		W
DIMENSIONS																					LBS
B050-2021-GA	3.38		86		3.00		76		3.00		76		2.19		56		2.50		64		3.40
B075-2022-GA	3.38		86		3.38		86		3.25		83		2.19		56		2.81		71		4.20
B100-2023-GA	3.38		86		3.75		95		3.50		89		2.44		61		3.13		79		5.90
B150-2024-GAF	4.00		102		4.50		114		4.00		102		2.44		61		3.75		95		8.50
B200-2025-GAF	4.00		102		4.50		114		4.00		102		2.81		70		3.75		95		10.00
B250-2026-GAF	4.00		102		4.50		114		4.00		102		3.19		81		3.75		95		11.00
B300-2027-GAF	4.38		111		4.50		114		4.00		102		3.75		95		3.75		95		13.20
B350-2028-GAF	4.50		114		5.25		133		4.50		114		3.38		86		4.38		111		14.90
B500-2029-GAF	5.13		130		5.25		133		4.50		114		3.88		99		4.38		111		19.20
B750-2030-GAF	7.00		178		5.25		133		5.00		127		5.88		149		4.38		111		29.80
B1K0-2048-GAF	7.00		178		6.38		162		6.00		152		3.75		95		5.31		135		31.00

MEDIUM VOLTAGE CONTROL TRANSFORMERS

GENERAL SPECIFICATIONS: All are EITHER 50Hz or 60Hz

BUILDING STYLE: Open core and coil

APPROVALS: This product is not UL/CSA

130°C Insulation system

24" Minimum primary lead length

Frequency: 60Hz

HIPOT: 7,400 volts for 2,400 volt primary

11,500 volts for 4160 volt primary

Construction: – Epoxy impregnated coils

Primary: 4200 Secondary: 120			
T	F.L.A.	VA	CATALOG NUMBER
W/4	6.25	750	H750-0030

Primary: 2400 Secondary: 120			
T	F.L.A.	VA	CATALOG NUMBER
W/4	6.25	750	H750-0031

Primary: 4160 Secondary: 120 x 240			
T	F.L.A.	VA	CATALOG NUMBER
W/4	8.33/4.17	1000	H1K0-0015
W/4	12.50/6.25	1500	HN1K5G1519P
W/4	16.67/8.33	2000	HN2K0G1519P
W/4	25.00/12.50	3000	HN3K0G1519P

Primary: 2400 Secondary: 120 x 240			
T	F.L.A.	VA	CATALOG NUMBER
W/4	8.33/4.17	1000	H1K0-0010
W/4	12.50/6.25	1500	HN1K5F1519P
W/4	16.67/8.33	2000	HN2K0F1519P
W/4	25.00/12.50	3000	HN3K0F1519P

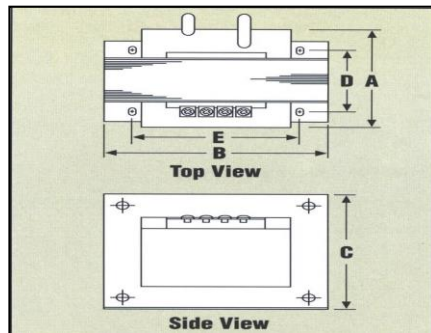

Voltage – Pri: 4200* or 2400 Sec: 120

VA											W					
DIMENSIONS	INCH	A	MM	INCH	B	MM	INCH	C	MM	INCH	D	MM	INCH	E	MM	LBS
*H750-0030	6.63		168	6.38		162	5.81		148	5.25		133	5.31		135	30.50
H750-0031	6.63		168	6.38		162	5.81		148	5.25		133	5.31		135	30.70

Voltage – Pri: 4160* or 2400 Sec: 120 x 240

VA											W					
DIMENSIONS	INCH	A	MM	INCH	B	MM	INCH	C	MM	INCH	D	MM	INCH	E	MM	LBS
H1K0-0010	6.25		159	7.56		192	6.38		162	3.50		89	5.63		143	31.30
*H1K0-0015	6.25		159	7.56		192	6.38		162	3.50		89	5.63		143	31.10
HN1K5F1519P	7.00		178	9.00		229	7.63		194	4.25		108	6.50		165	53.7
*HN1K5G1519P	7.00		178	9.00		229	7.63		194	4.25		108	6.50		165	53.2
HN2K0F1519P	7.94		202	9.00		229	7.63		194	5.19		132	6.50		165	65.40
*HN2K0G1519P	7.94		202	9.00		229	7.63		194	5.19		132	6.50		165	58.20
HN3K0F1519P	9.75		248	9.00		229	7.63		194	7.00		178	6.50		165	99.90
*HN3K0G1519P	9.75		248	9.00		229	7.63		194	7.00		178	6.50		165	101.00

CONTROL TRANSFORMER ACCESSORIES

CATALOG NUMBER	DESCRIPTION	APPROX. WEIGHT	
		LBS	KG
	IP-20 Safetouch™ Covers		
TPTC-2001	10PACK 4TERM.	1.0	0.5
TPTC-2002	10PACK 6TERM.	1.0	0.5
TPTC-2006	10PACK UNIVERSAL PRI BLOCK	1.0	0.5
			
FKTP-1001	PRIMARY CL "CC" FUSE KIT	0.25	0.1
			
	Bulk Fuse Clips		
514-1661-01C	BULK FUSE CLIPS 13/32 X 1-1/2 SMALL TERMINALS	N/A	
514-1662-01A	BULK FUSE CLIPS 13/32 X 1-1/2 LARGE TERMINALS	N/A	
514-1661-02C	BULK FUSE CLIPS 1/4 X 1-1/4 SMALL TERMINALS	N/A	
514-1662-02A	BULK FUSE CLIPS 1/4 X 1-1/4 LARGE TERMINALS	N/A	
514-1621A	BULK FUSE CLIPS 9/16 X 2 FITS SMALL TERMINALS ONLY	N/A	
	Bulk Jumpers		
514-1653-02A	BAGGED JUMPERS SMALL TERMINALS – 2 PER BAG	N/A	
514-1654-02B	BAGGED JUMPERS LARGE TERMINALS – 2 PER BAG	N/A	
	Optional Factory Installed Primary Fuse Holders		
CL. "CC" PRI.	P/N SUFFIX = RB, RK, RX, RJ, RR, RY, RG, RL, RN, RC, -8		
	*Non-rejection version available on all factory installed primary fuseblock options		
	Secondary Fuse Clip Options		
1/4 X 1-1/4 SEC.	P/N SUFFIX = JQ, XQ		
9/16 X 2 SEC.	P/N SUFFIX = JM, XM FITS SMALL TERMINALS ONLY		

TRANSFORMER ACCESSORY INTERCHANGE MATRIX

WITHOUT PRIMARY FUSE BLOCK	>>	DUAL CLASS "CC" PRIMARY FUSED SUFFIX
JK, JKF, JKH	>>	RB, RBF, RBH
XK, XKF, XKH	>>	RK, RKF, RKH
XX, XXF, XXH	>>	RX, RXF, RXH
XJ, XJF, XJH	>>	RJ, RJF, RJH
JJ, JJF, JJH	>>	RR, RRF, RRH
JM, JMF, JMH	>>	RY, RYF, RYH
XM, JMF, JMH	>>	RG, RGF, RGH
JQ, JQF, JQH	>>	RL RLF, RLH
XQ, XQF, XQH	>>	RN, RNF, RNH
JX, JXF, JXH	>>	RC, RCF, RCH
-1, -1F, -1H	>>	-8, -8F, -8H

PRIMARY FUSE KIT # FKTP-1001

Universal mounting instructions

In addition to factory installed primary fusing capability Micron offers a primary fuse kit for ImperviTRAN intended for field installation. The primary fuse kit includes a 2-pole Class "CC" fuse block, instructions and all associated mounting hardware. Additionally, this fuse block will fit many competitive units. To order this kit, use catalog number FKTP-1001. The primary fuse kit, when installed, will add a maximum of 11/16" to the transformer "A" dimension and 1-15/16" to the "C" dimension.

For transformers with integral accessory mounting plate

1. Connect one end of the 2 primary leads (#1) under the appropriate primary terminal screws. Secure screws to 16 lb-in <500VA and 30 lb-in 500VA and larger.
2. Insert locking clips (#4) oriented as shown into the fuse block (#3) pockets. Use caution in choosing screw length if locking clips are not used.
3. Attach clips and fuse block to accessory mounting plate (#2) using screws (#5). Recommended torque 16 lb-in.
4. Insert fuses (not supplied) into fuse block followed by fuse block covers (#6) (IF ORDERED) with lock slots (#6a) matching tip of the clips, as shown. Press down until cover locks.

Cover cannot be removed without releasing tab from detent (#6a). A tip of a pen will suffice.

Refer to primary fuse chart for recommended fuses.

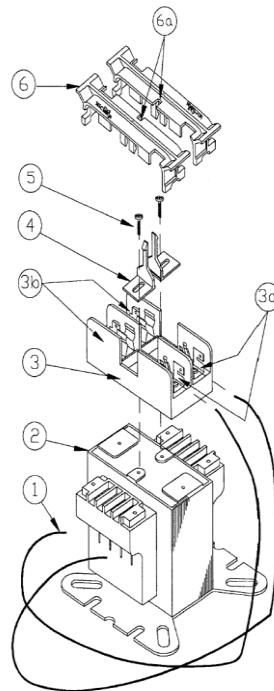

For transformers without integral accessory mounting plate:

Loosen two outer screws on primary side of transformer. On 6-terminal designs leave 2 open spaces between. Capture mounting brackets and leads under terminal screws and tighten to correct value.

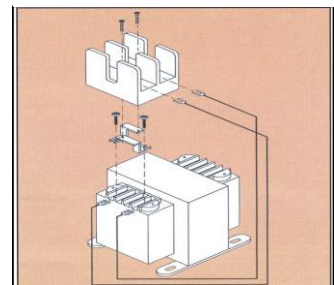

5. Connect the other end of the 2 primary leads (#1) under the screws on each of the 2 poles on the fuse block (#3a) and secure to 20 lb-in.
6. Apply primary voltage to the opposite end of the fuse block (#3b).

Additionally the mounting plate (#2) can be utilized to mount other accessories such as DIN Rail. Use caution in choosing screw length.

What is a Transformer:

Transformers are AC to AC devices. You cannot transform DC. Transformers change and/or isolate one voltage value from another. This is accomplished via electromagnetic induction, the magnetic field caused when alternating current passing through the primary coil is induced into the secondary coil. By varying the number of turns of wire within one coil with respect to the other, the voltage seen at the secondary coil differs from that of the primary. The laminations or core are in place to make the process more efficient.

What is a Control Transformer:

DEFINITION:

Control Transformers are virtually always single phase. They are also called "CPTs", Control Power Transformers, High Inrush Transformers, Step-Down and Power Transformers. They are designed to provide a stable secondary voltage at high initial energizing or inrush currents typically 5 to 15 times normal operating load current.

TERMS:

Sinusoidal: Or sine wave. A mathematical function that describes a smooth repetitive oscillation. The phase is defined where in the cycle the oscillation begins. See following definition of AC.

AC: Alternating current is the most common transmitted type of electricity. The flow begins by building up a voltage which is positive on top and negative on the bottom, and therefore pushes electrons through the circuit in the direction indicated by the solid arrows. However, then the source voltage starts falling off, and eventually reverses polarity. Now current will still flow through the circuit, but this time in the direction shown by the dotted arrows. The cycle repeats itself endlessly and as a result the current through the circuit reverses direction repeatedly.

The number of alterations per second is called frequency. If viewed on an oscilloscope, the cycles would form a **Sine wave** (fig. 4).

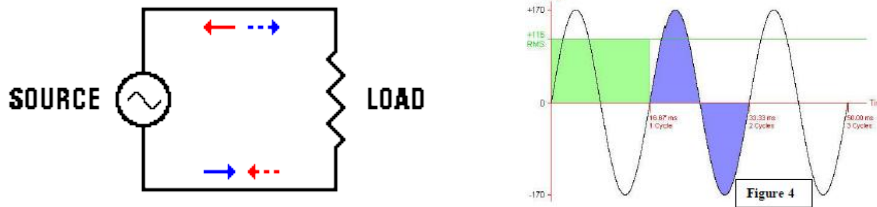

Hertz (Hz): The frequency (cycles) that AC reverses direction per second. 60Hz is common in NA, 50Hz in EU.

AMPS: The volume of electrical charge passing a point per unit of time. This "flow rate" called current, is measured in amps.

Volts: The velocity of the electrical charge passing through a conductor.

Ambient: Refers to the ambient temperature of the air surrounding the transformer. Expressed in degrees Celsius (Centigrade).

The established industrial ambient is 40°C. Typically environments above this require component derating.

Regulation: The variation of transformer secondary voltage from no load to full load. In smaller sizes like 50VA, the difference between no load and full load voltage may be as high as 12%-13%.

Inrush: The initial peak current (amp draw) measured as the transformer or the load becomes energized. This peak lasts only a few cycles but can equal as much as 40 times the normal operating current. As the current spikes the voltage dips. Think of why your house lights dim when the air conditioner compressor turns on. Control transformers are designed to minimize the voltage drop at inrush. Magnetizing the laminations and coil of the transformer itself also produces inrush. This causes a similar amperage peak on the line feeding the transformer and may cause premature or nuisance tripping of fuses and breakers. The worst case inrush is always at the peak of a cycle.

Compensated windings: The transformer is designed to provide label voltage at full load. At less than full load the measured output voltage is higher. This design feature is called a compensated winding. At 5Kva and above, compensation no longer is designed in.

Center Tap: Is a tap at the midpoint of a winding.
 A typical example would be a 36 volt center tap.
 You could derive 18 volts from each corner of the winding to the center OR 36 volts across the entire winding.

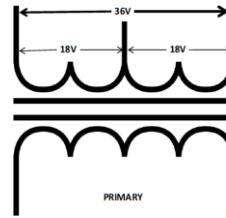

Autotransformer: An Autotransformer is designed with a single winding that acts as both primary and secondary. The secondary voltage can be tapped anywhere between the start and finish of the single winding. See $I_2 - I_3$ on adjacent drawing. Although smaller than a two-winding transformer, an autotransformer cannot provide electrical isolation between primary and secondary voltages.

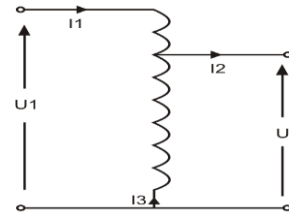

Types of Loads: The reversing action of alternating current makes no difference to some kinds of loads. For example, the light bulbs in your home don't care which way the current flows through them. When the circuit is closed by turning on the switch, the light turns on without regard for the direction of the current flow.

Resistive: Also described as linear. Loads that cause little or no initial energizing (inrush) current. Examples include incandescent lighting or heating resistors. Since there is no inrush, source current and source voltage rise and fall in sync with each other. (see Unity Power Factor)

Inductive: Typically caused by energizing a magnetic field such as solenoids, relays, transformers, motors or magnetic starters. Initial energizing (inrush) current is high which causes voltage to initially sag. After energizing occurs the current draw drops causing voltage to again rise. This point defines "steady state" or "sealed" VA. Inductive loads require more current than voltage initially in order to build the necessary magnetic field. The extra time it takes for the current in an inductor to build to its maximum before falling causes the source current to lag the source voltage. (see Lagging Power Factor)

Capacitive: The load presents a very high initial current draw similar to charging a capacitor. The initial high current draw causes a momentary voltage sag. In this way it is similar to inductive power. However, capacitive power is the opposite of inductive power in that it energizes an *electrical field* as opposed to a *magnetic field*. Because of the charging/discharging action of a capacitor the current always leads the voltage in the sine wave by 90°. This phenomenon causes the source current to lead the source voltage. Examples are capacitors, power supplies and variable frequency devices. At high switching frequencies all loads contain some capacitive value. (see Leading Power Factor)

What is Power Factor:

Power Factor is the timing difference in % of delivered voltage VS delivered amps.

- A power factor of 1 equates to Unity: Timing of delivered voltage % = timing of delivered amps %.
- A power factor of <1 equates to Lagging: Timing of delivered voltage reaches peak before delivered amps.
 - Power lines & motor windings cause energy losses that draw excess current.
 - High inrush loads initially draw more current than volts.
- A power factor of >1 equates to Leading: Timing of delivered voltage reaches peak after delivered amps.
 - Capacitors (once charged) store energy (amps) and can compensate for losses (power factor correction capacitors).

In the diagram to **the** right,
 Blue = voltage reached peak before current (lag)
 Red = current reached peak before voltage (lead)

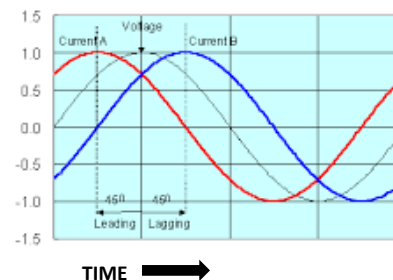

TYPICAL CONTROL TRANSFORMER QUESTIONS

<p>My output voltage seems high.</p> <p>●You need this info to answer.</p>	<ul style="list-style-type: none"> ●What is the <u>measured</u> voltage between the two wires connected to the primary? ●What voltage are you getting from the transformer? ●What is the actual load on the transformer (either amps or VA)? ●What VA size transformer do you have? <p>1. Typically transformers are designed to provide nameplate voltage at full rated load. When little or no load is attached the output may be as much as 13% high. The no load to full load voltage differential decreases in proportion to the load.</p> <p>2. Obtain the correct voltage measurement for the primary voltage. Just because the breaker is labeled 480 volts, is the actual voltage 480 volts? The secondary will be affected by the same percentage as the actual primary differs from the label primary. 492 volts applied to a 480 volt primary would cause a 2.5% increase in the measured secondary.</p> <p>EXAMPLE: "I wired up a B050BTZ13JK and see 140 volts on the secondary. Something is wrong with the transformer."</p> <p>ANSWER: (using the examples above)</p> <ol style="list-style-type: none"> 1. Ask what the measured primary voltage is. (492V) 2. Ask what the actual transformer load is. (20VA Essentially no-load) 3. Calculate what the actual secondary would be based on actual primary voltage and actual load. <ul style="list-style-type: none"> 492V/480V = 2.5% 120V + 13% = 135.6V 135.6V + 2.5% = 139V 4. If your calculations do not meet that of the customer it may be worthy of further investigation. In the example, the measured primary was 492V. Without that 2.5% overage, the secondary voltage would have been 135.6V which is within the specifications.
<p>Help me size a transformer. I have 3 Size One starters plus 2 lamps. Can you help me? (PAGE 4)</p> <p>●You need this info to answer.</p>	<ul style="list-style-type: none"> ●What is the inrush and sealed VA of each component simultaneously running? ●How often will these devices be energized per hour? <p>Remember that you need both the inrush and sealed VA for all of the primary devices used. In this case the 3 starters, as the lamps resistive loads that draw only milliamps. The customer states that each starter draws 175VA inrush and 44VA sealed and starts simultaneously. If you add the 3 inrush VAs: (175 X 3) = 525VA the choice points to a 100VA using the 90% table. Because the 3 starters energize together as well, then the inrush calculation would also include all sealed VA values: ((170 X 3) + (40 X 3)) = 630VA, pointing to 150VA. This means the minimum available selection becomes 150VA.</p> <p>Alternately, the calculation can be made by applying the universal formula for inrush VA selection found on Page 4 of the catalog. The formula is: $\sqrt{((\text{inrush VA})^2 + (\text{sealed VA})^2)}$</p> <p>ANSWER: $\sqrt{((3 \times 175)^2 + (3 \times 44)^2)} = 541.34\text{VA}$ which is just beyond the 100VA selection. However, the total sealed VA=132 which means that the minimum transformer available is 150VA.</p> <p>NOTE: The numbers depicted on inrush selection charts are finite. If the application meets or exceeds it is suggested to move to the next largest VA size as items may later be added and replacement parts may not have equal inrush/sealed VA.</p> <p>NOTE: If multiple starts per hour, oversize transformer VA by 20%.</p>
<p>I need a step-up transformer. Can the transformer be reverse connected?</p>	<p>Read reverse connecting below. If necessary for loads under 3Kva it may be best to design a transformer to do the job or allow for the voltage drop when run backward.</p> <ul style="list-style-type: none"> ●What voltage do you desire? ●What size load (VA or amps) does the caller need? <p>Reverse Connecting: Typically, above 3Kva, a transformer can be wired either as a step-down or step-up device. Windings on transformers under 5Kva are typically "compensated" to provide nameplate voltage at full rated load. The compensation value can be as much as 13% on a 50Va and lessens as the VA increases.</p>

<p>● <i>You need this info to answer</i></p>	<p>NOTE: Unlike running as a step-down transformer, reverse connection <i>lowers</i> the output voltage by the compensation percentage at no load and by 2X the compensation percentage at full load!</p> <p>EXAMPLE: putting 120V into the secondary of a B050BTZ13JK might yield 418V from the 480V primary at no load and 355V at full load.</p> <p>EXAMPLE: putting 120V into the secondary of a B3K0BTZ13JXH would yield 475V from the 480V primary at no load and 470V at full load.</p>
<p><i>I get a strange voltage when measuring voltage from X₁ or X₂ to ground.</i></p>	<p>The only meaningful reference is a voltage measurement between two terminals and not one or the other to ground. In this case the measurement should be X₂-X₁. A measurement between a terminal and ground is referred to as a ghost voltage and is meaningless as there is no connected ground reference between the windings.</p> <ol style="list-style-type: none"> 1. Caused by a capacitive coupling and typically read by a high impedance instrument. 2. Probably would not be picked up by a device with lower impedance. 3. This type of mutual inductance is incapable of carrying significant current. <p>Think: holding a fluorescent tube under a high tension line and seeing it illuminate.</p>
<p><i>I need an isolation transformer.</i></p>	<ol style="list-style-type: none"> 1. The definition of an isolation transformer is that the primary and secondary windings are connected magnetically but not physically. Also called "Double Wound". 2. An isolation transformer can also be defined as one having equal voltage primaries and secondaries. The B050LP1519JJ fits both categories of isolation.
<p><i>I need a shielded transformer.</i></p>	<p>Shielding is typically a conductor wound between major windings, then bonded to the core. The shield acts to mitigate line-to-line or line-to-ground noise. Typically, US built control transformers do not have shielding. In reality, an isolation transformer with a properly grounded secondary can mitigate nearly as well as a general use shield. The type of noise should define the type or placement of shielding required.</p>
<p><i>I need to get 24Vdc out, which transformer?</i></p>	<p>Transformers are AC to AC devices. You cannot transform DC. What you are describing is a power supply.</p>
<p><i>I have a high operating ambient. Do I need a high temperature class transformer?</i></p> <p><i>Will a higher temperature class transformer solve a high ambient problem?</i></p>	<p>The standard operating environment is based at 40°C. As a rule-of-thumb, for each 10° increase over 40°C, derate the maximum load by a minimum of 10%.</p> <hr/> <p>The standard operating environment is based at 40°C. The temperature class of the transformer is based on internal temperature rise above 40°C. Higher temperature classes run hotter and further add to the ambient.</p> <p>This may necessitate additional derating.</p>

TOTAL PRODUCT OFFERING

General Purpose, Power and Buck-Boost Transformers:

50VA – 750Kva

TYPICAL EXAMPLES

Single Phase from 0.05kVA – 100kVA

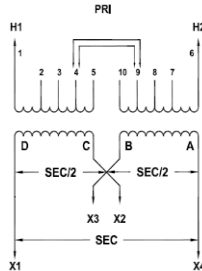

Typical Single Phase Connection Diagrams

WDG	VOLTS	CONNECT	LINE
PRI	480	H2-H3	H1-H4
	240	H1H3-H2H4	
SEC	240	X2-X3	X1-X4
	120	X1X3-X2X4	
	120/240	X2-X3*	



Buck-Boost Transformers are used to provide an economical method of correcting a lower or higher voltage to a voltage rating more suitable for efficient operation of electrical equipment. Buck-Boost applications are primarily used for motor operation and should not be used for motor control circuits, correction of fluctuating voltages or obtaining a neutral on a Delta system.

Typical Buck-Boost Selection Table and Wiring Diagram Depiction

Need Single Phase 230Volts, 60Hz

Units Req'd	Unit Kva	Use Catalog Number	Have Available Voltage Of																			
			199		203		207		209		216		219		242		246		253		260	
			Kva-Amps		Kva-Amps		Kva-Amps		Kva-Amps		Kva-Amps		Kva-Amps		Kva-Amps		Kva-Amps		Kva-Amps		Kva-Amps	
1	.05	J050A1EA1A01	-	-	-	-	0.43	1.88	0.48	2.08	-	-	0.96	4.16	1.00	4.38	-	-	0.53	2.29	-	-
1	.05	J050A1EB1A01	0.31	1.36	0.36	1.56	-	-	-	-	0.72	3.12	-	-	-	-	0.77	3.34	-	-	0.41	1.77
1	.10	J100A1EA1A01	-	-	-	-	0.86	3.75	0.96	4.17	-	-	1.92	8.33	2.01	8.75	-	-	1.05	4.58	-	-
1	.10	J100A1EB1A01	0.62	2.71	0.72	3.12	-	-	-	-	1.44	6.25	-	-	-	-	1.53	6.67	-	-	0.82	3.54
1	.15	J150A1EA1A01	-	-	-	-	1.29	5.62	1.44	6.25	-	-	2.87	12.5	3.02	13.1	-	-	1.58	6.87	-	-
1	.15	J150A1EB1A01	0.93	4.06	1.08	4.69	-	-	-	-	2.16	9.37	-	-	-	-	2.30	10	-	-	1.22	5.31
Connection Diagram			G		F		G		F		E		E		E		E		F		F	

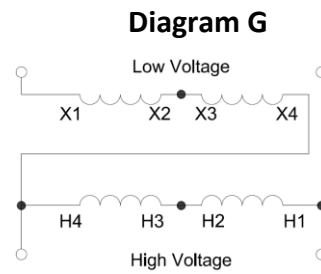
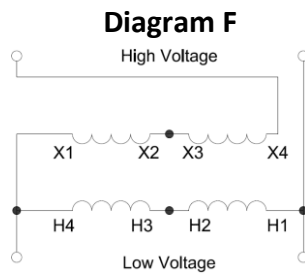
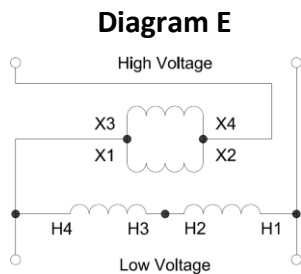

Three-Phase from 3kVA – 750kVA

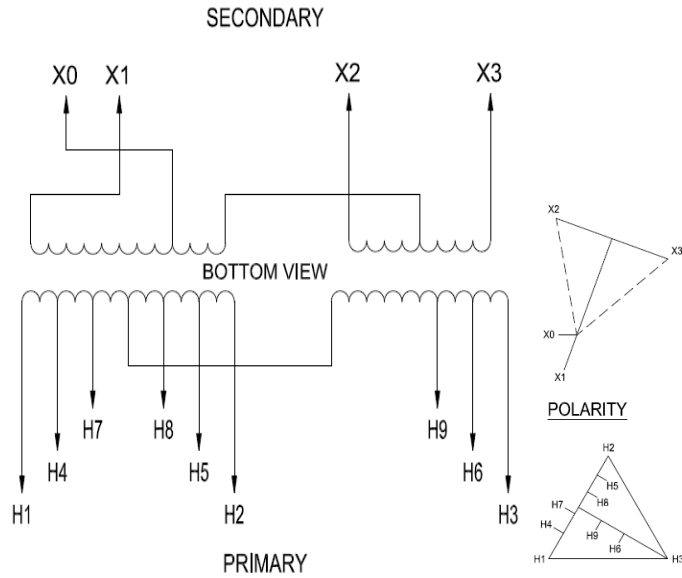

Meets D.O.E 2016 Standards

Power Supplies and Converters:

18 Watts – 960 Watt Three-Phase

TYPICAL EXAMPLES



Industrial DIN-Mount power supplies are used in an ever increasing number of automation applications. 480 volt and three-phase capability offers even more user flexibility.

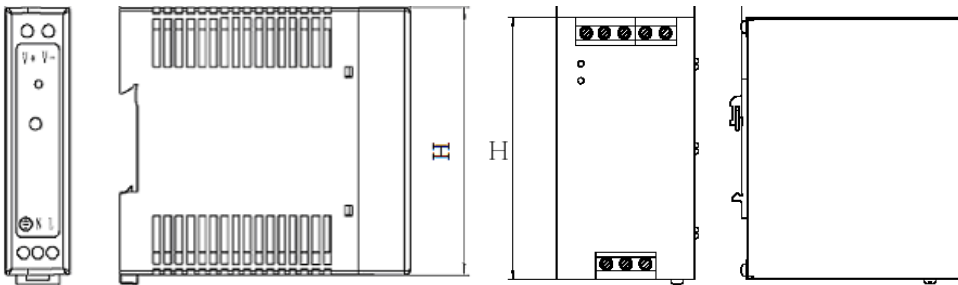

Can't get what you need from your current source? **Contact Micron's customer service department at 1.800.664.4660 and press 1!**

Some of the industry's smallest packages

Custom Coils:

AND since all of our products contain coils, we are the perfect choice for your custom coil winding requirements! **Contact Micron's customer service department at 1.800.664.4660 and press 1!**

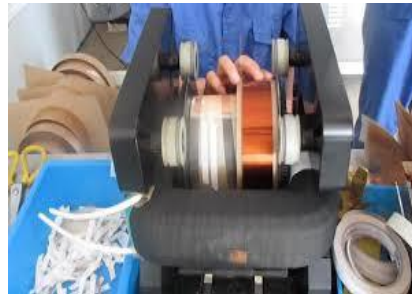
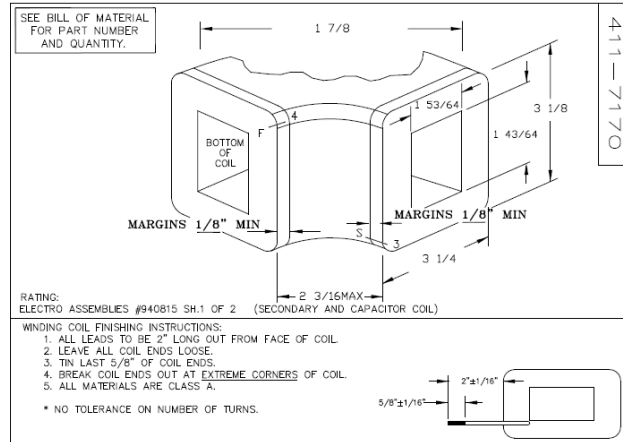

Do you have a specification that just cannot be met by "catalog" designs? Micron's user-centric design philosophy allows you to determine what works best for you. Either by choosing a product built to match industry standards or by choosing to work with our engineering staff and design to meet your individual OEM needs.

Contact Micron at +1.630.516.1222 or info@micronpower.com to learn more.



MICRON INDUSTRIES CORPORATION
SUITE 200
1211 WEST 22ND STREET
OAK BROOK, IL 60523 USA
1.800.664.4660 WITHIN USA
+1.630.516.1222
+1.630.516.1820 FAX