







General Specifications



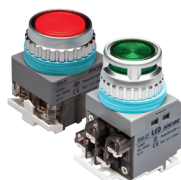

Nominal Rating		10A 250VAC
Contact Resistance		Max. 50mΩ
Insulation Resistance		100MΩ at 500V DC
Frequency of Alteration	Mechanical	30 operation/min
	Electrical	30 operation/min
Dielectric Strength	btwn Charging sectors	1,800VAC/Min. (50~60Hz)
	btwn charger & earth	2,500VAC/Min. (50~60Hz)
Expected Life	Mechanical	500,000 times
	Electrical	100,000 times
Degree of Protection		IP63 (Optional IP65)
Ambient Temperature	Operation	-25°C~+70°C
	Storage	-30°C~+80°C
Ambient Humidity		35~80% RH

LED	Nominal Current	AC	LED	Approx. 15mA
		DC	LED	Approx. 15mA
	Voltage	24VAC		
Expected Life				Min. 50,000 hrs

Norminal Current

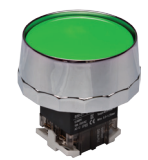
Contact Material		Ag Alloy		
Rated Current	Voltage	AC1	AC3	DC1
	24V	20A	10A	6A
	110V	16A	8A	1.2A
	250V	10A	5A	0.5A
440V	5A	2.5A	0.25A	

	Style	Operation	Part Number
Push button		Momentary	B30-21①
		Momentary Illuminated	B30-27①
Half guarded Push button		Momentary	B30-21①-EG
Selector switch		2 Step Knob	B30-41S
		2 Step long lever	B30-41L
		3 Step Knob	B30-51S
		3 Step long lever	B30-51L
Key selector switch		2 Step	B30-61K
		3 Step	B30-71K
Mushroom 45mm head		Momentary	B30-21①-N40
Halfmoon guard 65mm Head		Momentary	B30-21①-C65

	Style	Operation	Part Number
Extended 65mm Head		Momentary	B30-21①-H65
Full guard 65mm Head		Momentary	B30-21①-F65
Mushroom 65mm Head		Momentary	B30-21①-N65
Latch type E-stop switch		Turn to release	B30-81L
Water proof E-stop switch		Turn to release	B30-81A
E-stop switch		Turn to release	B30-81R

* ① (Head color) = R: Red, Y: Yellow, G: Green, B: Blue, W: White

Dimensions

Push Buttons

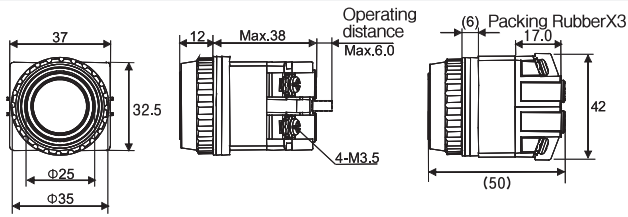

Illuminated Push Buttons

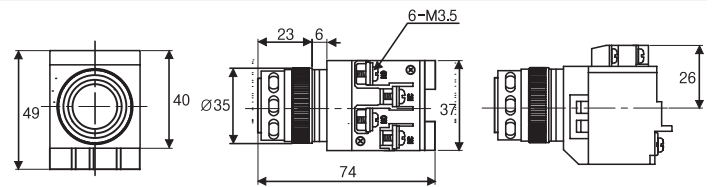

E-Stop Switches

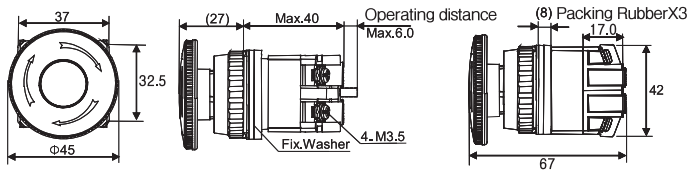

E-Stop Switches (water proof)/ Latch Type E-Stop Switches

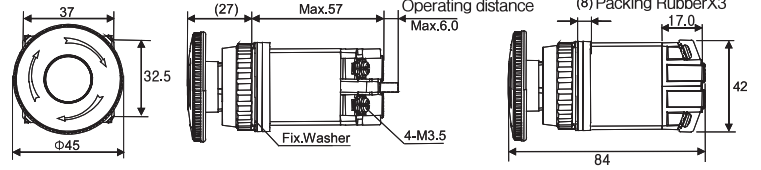

Selector Switches

Knob Type

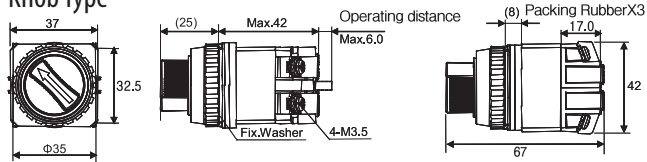

Lever Type

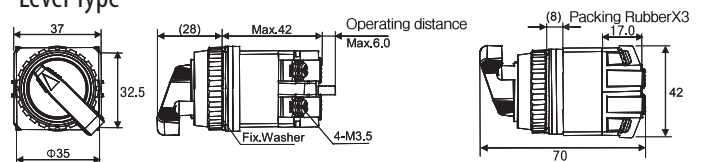

Key Switches

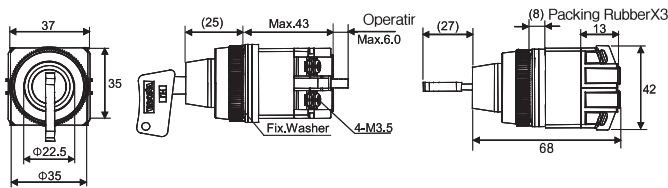

Mushroom Push Buttons

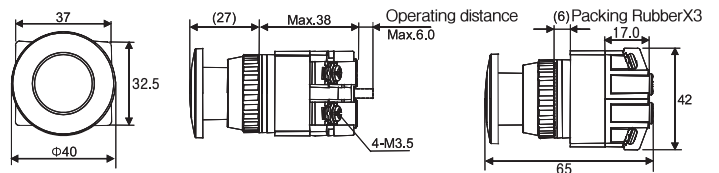

65mm Metal Guarded Head Push Buttons

Halfmoon Guard

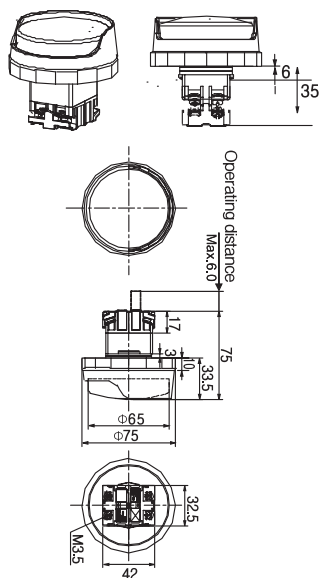

Full Guard

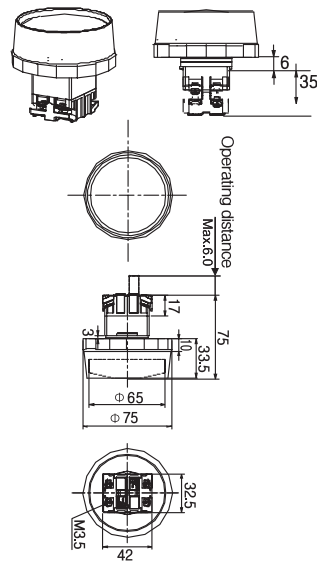

Extended head

