



Cable Glands

NPT Threads 2-4



PG Threads 5-13



Metric Threads..... 14-15



Accessories 16-26



Sealing Glands 27-29



Cable Entry Systems 30





Cable Glands: NPT Threads

Standard Brass Cable Glands

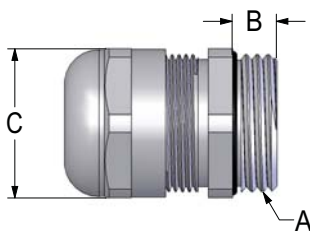

Mencom Cable Glands are easy to use and provide a good strain relief and water tight seal for round cables. The cable glands are rated up to IP 68 (comparable to NEMA 6P). The glands have a wide clamping range.

NPT style cable glands are not supplied with nuts. Nuts can be ordered separately, see page V-4.

Brass Cable Glands					
Part Number	Diameter Range mm (inches)	Mounting Hole Clearance mm (inches)	A Thread Type	B Thread Length mm (inches)	C Wrench Flats mm (inches)
MCG-3/8	3 - 9 (0.118 - 0.354)	17.1 (0.675)	3/8" NPT	8 (0.315)	20 (0.79)
MCG-1/2	5 - 13 (0.197 - 0.512)	21.0 (0.825)	1/2" NPT	10 (0.394)	24 (0.94)
MCG-3/4	8 - 16 (0.315 - 0.630)	26.7 (1.050)	3/4" NPT	11 (0.433)	30 (1.18)
MCG-1.0	12 - 21 (0.472 - 0.827)	34.3 (1.350)	1" NPT	14 (0.551)	40 (1.57)
MCG-1.25	16 - 27 (0.630 - 1.063)	41.9 (1.650)	1.25" NPT	14 (0.551)	50 (1.97)
MCG-1.5	21 - 35 (0.827 - 1.378)	49.5 (1.950)	1.5" NPT	15 (0.591)	55 (2.17)
MCG-2.0	27 - 48 (1.063 - 1.890)	61.0 (2.400)	2" NPT	15 (0.591)	65 (2.56)

Materials:

Body: Nickel Plated Brass
 Insert: Polyamide
 Seal: Neoprene
 O-Ring: BUNA-N

Cable Glands: NPT Threads

Standard Plastic Cable Glands

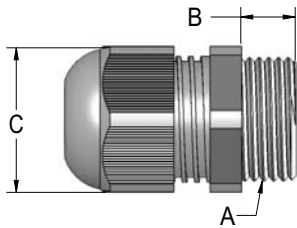

Mencom cable glands are easy to use and provide a good strain relief and water tight seal for round cables. The cable glands are rated up to IP 68-5 BAR (comparable to NEMA 6P). The glands have a wide clamping range.

NPT style cable glands are not supplied with nuts. Nuts can be ordered separately, see page V-4.

Plastic Cable Glands						
Part Number		Diameter Range mm (inches)	Mounting Hole Clearance mm (inches)	A Thread Type	B Thread Length mm (inches)	C Wrench Flats mm (inches)
Gray	Black					
PCG-3/8R	PCG-3/8R-B	3 - 7 (0.118 - 0.276)	17.1 (0.675)	3/8" NPT	15.5 (0.610)	22 (0.87)
PCG-3/8	PCG-3/8-B	5 - 10 (0.197 - 0.394)	17.1 (0.675)	1/2" NPT	15.5 (0.610)	22 (0.87)
PCG-1/2X	PCG-1/2X-B	5 - 9 (0.197 - 0.354)	21.0 (0.825)	1/2" NPT	14.5 (0.571)	24 (0.94)
PCG-1/2Y	PCG-1/2Y-B	6 - 12 (0.236 - 0.472)	21.0 (0.825)	1/2" NPT	14.5 (0.571)	24 (0.94)
PCG-1/2R	PCG-1/2R-B	7 - 12 (0.276 - 0.472)	21.0 (0.825)	1/2" NPT	15 (0.591)	27 (1.06)
PCG-1/2	PCG-1/2-B	10 - 14 (0.394 - 0.551)	21.0 (0.825)	1/2" NPT	15 (0.591)	27 (1.06)
PCG-1/2E	PCG-1/2E-B	13 - 18 (0.512 - 0.709)	21.0 (0.825)	1/2" NPT	15 (0.591)	33 (1.30)
PCG-3/4R	PCG-3/4R-B	9 - 16 (0.354 - 0.630)	26.7 (1.050)	3/4" NPT	15 (0.591)	33 (1.30)
PCG-3/4	PCG-3/4-B	14 - 18 (0.551 - 0.709)	26.7 (1.050)	3/4" NPT	15 (0.591)	33 (1.30)
PCG-1.0R	PCG-1.0R-B	12 - 20 (0.472 - 0.787)	34.3 (1.350)	1" NPT	18 (0.709)	42 (1.65)
PCG-1.0	PCG-1.0-B	19 - 25 (0.748 - 0.984)	34.3 (1.350)	1" NPT	18 (0.709)	42 (1.65)
PCG-1.25R	PCG-1.25R-B	20 - 26 (0.787 - 1.024)	41.9 (1.650)	1.25" NPT	18 (0.709)	53 (2.09)
PCG-1.25	PCG-1.25-B	22 - 32 (0.866 - 1.260)	41.9 (1.650)	1.25" NPT	18 (0.709)	53 (2.09)

For the flex style version, add "S" to the part number (e.g. PCG-1/2R-BS). Flex styles are not available on the PCG-1.0 or 1.25 versions.

Materials:

Body: Polyamide

Seal: Neoprene

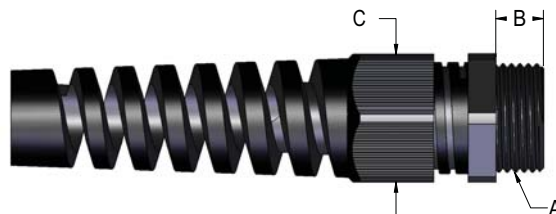

Cable Glands: NPT Threads

Nuts ❖ Plastic & Metal

Plastic Nuts					
Part Number		Thread Type	A mm (inches)	B mm (inches)	Figure
Gray	Black				
238PA	238PA/SW	3/8" NPT	22 (0.87)	5 (0.20)	1
212PA	212PA/SW	1/2" NPT	27 (1.06)	6 (0.24)	1
234PA	234PA/SW	3/4" NPT	36 (1.42)	7 (0.28)	1
210PA	210PA/SW	1" NPT	42 (1.65)	7 (0.28)	1

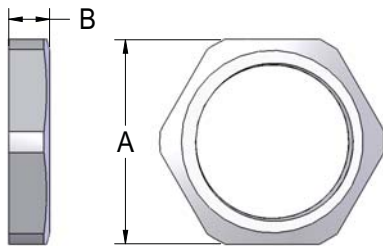

Figure 1

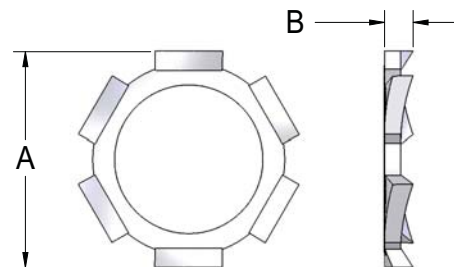
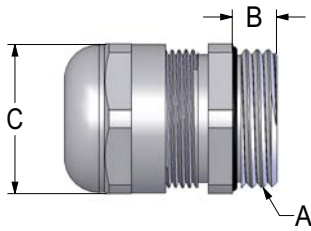

Figure 2

Metal Nuts				
Part Number	Thread Type	A mm (inches)	B mm (inches)	Figure
214M	1/4" NPT	17.5 (0.69)	3.3 (0.13)	1
238M	3/8" NPT	20.1 (0.79)	3.0 (0.12)	1
212M	1/2" NPT	28.4 (1.12)	3.3 (0.13)	2
234M	3/4" NPT	35.1 (1.38)	3.8 (0.15)	2
210M	1" NPT	42.9 (1.69)	5.1 (0.20)	2
Material: Steel Zinc Plate				

Cable Glands: PG Threads

Standard Brass Cable Glands



Mencom cable glands are easy to use and provide a good strain relief and water tight seal for round cables. The cable glands are rated up to IP 68 (comparable to NEMA 6P). The glands have a wide clamping range.

An O-Ring and Locking Nut are supplied on all PG threaded metal cable glands.

Part Number	Diameter Range mm (inches)	Mounting Hole Clearance (inches)	A Thread Type	B Thread Length mm (inches)	C Wrench Flats mm (inches)
MCG-07R	2 - 5 (0.079 - 0.196)	12.7 (.500)	PG 7	5 (.197)	14 (.551)
MCG-07	3 - 6.5 (.118-.255)	12.7 (.500)	PG 7	5 (.197)	14 (.551)
MCG-09R	2 - 6 (0.079-.236)	15.4 (.606)	PG 9	6 (.236)	17 (.669)
MCG-09	4 - 8 (.157-.315)	15.4 (.606)	PG 9	6 (.236)	17 (.669)
MCG-11R	3 - 7 (.118-.275)	18.8 (.740)	PG 11	6 (.236)	20 (.787)
MCG-11	5 - 10 (.197-.393)	18.8 (.740)	PG 11	6 (.236)	20 (.787)
MCG-13.5R	5 - 9 (.197-.354)	20.7 (.815)	PG 13.5	6.5 (.256)	22 (.866)
MCG-13.5	6 - 12 (.236-.472)	20.7 (.815)	PG 13.5	6.5 (.256)	22 (.866)
MCG-16R	7 - 12 (.276-.472)	22.8 (.900)	PG 16	6.5 (.256)	24 (.945)
MCG-16	10 - 14 (.394-.551)	22.8 (.900)	PG 16	6.5 (.256)	24 (.945)
MCG-21R	9 - 16 (.354-.630)	28.6 (1.125)	PG 21	7 (.276)	30 (1.181)
MCG-21	13 - 18 (.512-.708)	28.6 (1.125)	PG 21	7 (.276)	30 (1.181)
MCG-29R	12 - 20 (.472-.787)	37.4 (1.475)	PG 29	8 (.315)	40 (1.575)
MCG-29	18 - 25 (.709-.984)	37.4 (1.475)	PG 29	8 (.315)	40 (1.575)
MCG-36R	20 - 26 (.787-1.02)	47.5 (1.870)	PG 36	9 (.354)	50 (1.968)
MCG-36	24 - 32 (.866-1.26)	47.5 (1.870)	PG 36	9 (.354)	50 (1.968)
MCG-42R	25 - 31 (.984-1.22)	54.5 (2.145)	PG 42	10 (.394)	57 (2.244)
MCG-42	30 - 38 (1.18-1.50)	54.5 (2.145)	PG 42	10 (.394)	57 (2.244)
MCG-48R	29 - 35 (1.14-1.38)	59.8 (2.354)	PG 48	10 (.394)	64 (2.520)
MCG-48	34 - 44 (1.34-1.73)	59.8 (2.354)	PG 48	10 (.394)	64 (2.520)

Longer thread length (0.590") is available, add "L" to the end of the part number (e.g. MCG-21L).

Materials:

Body: Nickel Plated Brass
 Insert: Polyamide
 Seal: Neoprene



Cable Glands: PG Threads

Standard Plastic Cable Glands

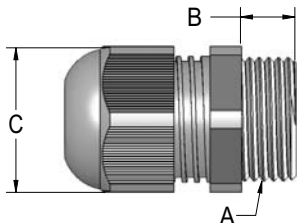

Mencom Cable Glands are easy to use and provide a good strain relief and water tight seal for round cables. The cable glands are rated up to IP 68-5 Bar (comparable to NEMA 6P). The glands have a wide clamping range.

A Locking Nut is supplied on all PG threaded parts. O-Rings are not required to maintain a seal on sizes PG 7 to PG 21, but are supplied on size PG 29 and larger.

Part Number		Diameter Range mm (inches)	Mounting Hole Clearance mm (inches)	A Thread Type	B Thread Length mm (inches)	C Wrench Flats mm (inches)
Gray	Black					
PCG-07R	PCG-07-B	2 - 5 (.079-.196)	12.7 (.500)	PG 7	8 (.315)	15 (.591)
PCG-07	PCG-07-B	3 - 6.5 (.118-.255)	12.7 (.500)	PG 7	8 (.315)	15 (.591)
PCG-09R	PCG-09R-B	2 - 6 (.079-.236)	15.4 (.606)	PG 9	8 (.315)	19 (.748)
PCG-09	PCG-09-B	4 - 8 (.157-.315)	15.4 (.606)	PG 9	8 (.315)	19 (.748)
PCG-11R	PCG-11R-B	3 - 7 (.118-.275)	18.8 (.740)	PG 11	8 (.315)	22 (.866)
PCG-11	PCG-11-B	5 - 10 (.197-.393)	18.8 (.740)	PG 11	8 (.315)	22 (.866)
PCG-13.5R	PCG-13.5R-B	5 - 9 (.197-.354)	20.7 (.815)	PG 13.5	9 (.354)	24 (.945)
PCG-13.5	PCG-13.5-B	6 - 12 (.236-.472)	20.7 (.815)	PG 13.5	9 (.354)	24 (.945)
PCG-16R	PCG-16R-B	7 - 12 (.276-.472)	22.8 (.900)	PG 16	10 (.394)	27 (1.06)
PCG-16	PCG-16-B	10 - 14 (.394-.551)	22.8 (.900)	PG 16	10 (.394)	27 (1.06)
PCG-21R	PCG-21R-B	9 - 16 (.354-.630)	28.6 (1.125)	PG 21	11 (.433)	33 (1.30)
PCG-21	PCG-21-B	13 - 18 (.512-.708)	28.6 (1.125)	PG 21	11 (.433)	33 (1.30)
PCG-29R	PCG-29R-B	12 - 20 (.472-.787)	37.4 (1.475)	PG 29	11 (.433)	42 (1.65)
PCG-29	PCG-29-B	18 - 25 (.709-.984)	37.4 (1.475)	PG 29	11 (.433)	42 (1.65)
PCG-36R	PCG-36R-B	20 - 26 (.787-1.02)	47.5 (1.870)	PG 36	13 (.512)	53 (2.09)
PCG-36	PCG-36-B	22 - 32 (.866-1.26)	47.5 (1.870)	PG 36	13 (.512)	53 (2.09)
PCG-42R	PCG-42R-B	25 - 31 (.984-1.22)	54.5 (2.145)	PG 42	13 (.512)	60 (2.36)
PCG-42	PCG-42-B	30 - 38 (1.18-1.50)	54.5 (2.145)	PG 42	13 (.512)	60 (2.36)
PCG-48R	PCG-48R-B	29 - 35 (1.14-1.38)	59.8 (2.354)	PG 48	14 (.552)	65 (2.60)
PCG-48	PCG-48-B	34 - 44 (1.34-1.73)	59.8 (2.354)	PG 48	14 (.552)	65 (2.60)

For the Flex Style Version, add "S" to the part number (e.g. PCG-16R-BS).

Flex Styles are not available on the PCG-29 to PCG-48 versions.

Materials:

Body: Polyamide
Seal: Neoprene

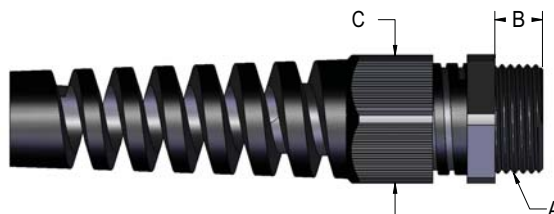

Cable Glands: PG Threads

EMI Shielding Brass Cable Glands

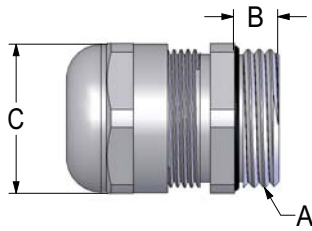

Mencom EMI Cable Glands provide an easy way to ground the shield from a shielded cable to the body of the metal cable gland. The seal rating is IP 68.

A special cutting Locking Nut and O-Ring are supplied on EMI Shielding Cable Glands. The nut will cut through painted surfaces to allow the gland to ground to the metal panel.

Part Number	Diameter Range mm (inches)	Mounting Hole Clearance mm (inches)	A Thread Type	B Thread Length mm (inches)	C Wrench Flats mm (inches)
MCGB-07R	2 - 5 (.079-.196)	12.7 (.500)	PG 7	5 (.197)	14 (.551)
MCGB-07	3 - 6.5 (.118-.255)	12.7 (.500)	PG 7	5 (.197)	14 (.551)
MCGB-09R	2 - 6 (.079-.236)	15.4 (.606)	PG 9	6 (.236)	17 (.669)
MCGB-09	4 - 8 (.157-.315)	15.4 (.606)	PG 9	6 (.236)	17 (.669)
MCGB-11R	3 - 7 (.118-.275)	18.8 (.740)	PG 11	6 (.236)	20 (.787)
MCGB-11	5 - 10 (.197-.393)	18.8 (.740)	PG 11	6 (.236)	20 (.787)
MCGB-13.5R	5 - 9 (.197-.354)	20.7 (.815)	PG 13.5	6.5 (.256)	22 (.866)
MCGB-13.5	6 - 12 (.236-.472)	20.7 (.815)	PG 13.5	6.5 (.256)	22 (.866)
MCGB-16R	7 - 12 (.276-.472)	22.8 (.900)	PG 16	6.5 (.256)	24 (.945)
MCGB-16	10 - 14 (.394-.551)	22.8 (.900)	PG 16	6.5 (.256)	24 (.945)
MCGB-21R	9 - 16 (.354-.630)	28.6 (1.125)	PG 21	7 (.276)	30 (1.181)
MCGB-21	13 - 18 (.512-.708)	28.6 (1.125)	PG 21	7 (.276)	30 (1.181)
MCGB-29R	12 - 20 (.472-.787)	37.4 (1.475)	PG 29	8 (.315)	40 (1.575)
MCGB-29	18 - 25 (.709-.984)	37.4 (1.475)	PG 29	8 (.315)	40 (1.575)
MCGB-36R	20 - 26 (.787-1.02)	47.5 (1.870)	PG 36	9 (.354)	50 (1.968)
MCGB-36	24 - 32 (.866-1.26)	47.5 (1.870)	PG 36	9 (.354)	50 (1.968)
MCGB-42R	25 - 31 (.984-1.22)	54.5 (2.145)	PG 42	10 (.394)	57 (2.244)
MCGB-42	30 - 38 (1.18-1.50)	54.5 (2.145)	PG 42	10 (.394)	57 (2.244)
MCGB-48R	29 - 35 (1.14-1.38)	59.8 (2.354)	PG 48	10 (.394)	64 (2.520)
MCGB-48	34 - 44 (1.34-1.73)	59.8 (2.354)	PG 48	10 (.394)	64 (2.520)

Materials:

Body: Nickel Plated Brass
 Insert: Polyamide
 Seal: Neoprene





Cable Glands: PG Threads

Clamping Cable Glands

CRSS Series

Nickel Plated Brass Cable Gland with self-centering double saddle clamps. The seal is achieved with a neoprene sealing ring (with multiple perforations to accommodate a wide range of diameters). Brass Nuts and O-Rings for these must be ordered separately. Protection to IP 55.



CRSS Series		
Part Number	Diameter Range mm (inches)	Thread Type
CRSS-09	7 - 10 (0.255 - 0.374)	PG 9
CRSS-11	8 - 12 (0.295 - 0.452)	PG 11
CRSS-13.5	9 - 13 (0.334 - 0.531)	PG 13.5
CRSS-16	10 - 15 (0.374 - 0.591)	PG 16
CRSS-21	12.5 - 19 (0.472 - 0.748)	PG 21
CRSS-29	19 - 27 (0.728 - 1.063)	PG 29
CRSS-36	26 - 33 (1.00 - 1.30)	PG 36
CRSS-42	30.5 - 39 (1.18 - 1.54)	PG 42
CRSS-48	35 - 45 (1.35 - 1.77)	PG 48

CRT Series

Nickel Plated Brass Cable Gland with multiple perforations. The seal is made of nitrile rubber, per DIN 46320.



CRT Series		
Part Number	Diameter Range mm (inches)	Thread Type
CRT-09	4 - 11 (0.157 - 0.433)	PG 9
CRT-11	6 - 12 (0.236 - 0.472)	PG 11
CRT-13.5	6 - 13 (0.236 - 0.512)	PG 13.5
CRT-16	6 - 16 (0.236 - 0.630)	PG 16
CRT-21	9 - 20 (0.354 - 0.787)	PG 21
CRT-29	17 - 28 (0.669 - 1.102)	PG 29
CRT-36	23 - 34 (0.906 - 1.339)	PG 36
CRT-42	29 - 40 (1.142 - 1.575)	PG 42
CRT-48	35 - 47 (1.378 - 1.850)	PG 48

Cable Glands: PG Threads

Plastic Right Angle Cable Glands

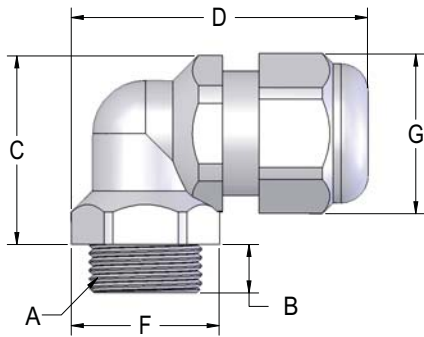

Mencom Cable Glands are easy to use and provide a good strain relief and water tight seal for round cables. The cable glands are rated up to IP 68-5 Bar (comparable to NEMA 6P). The glands have a wide clamping range.

A Locking Nut is supplied on all PG threaded parts.

Part Number	Diameter Range mm (inches)	Mounting Hole Clearance mm (inches)	A Thread Type	B Thread Length mm (inches)	C Height mm (inches)	D Length mm (inches)	F Wrench Flats mm (inches)	G Wrench Flats mm (inches)
PCGA-07R	2 - 6 (0.079- 0.236)	12.7 (0.500)	PG 7	8 (0.315)	26 (1.02)	38.5 (1.516)	15 (0.591)	19 (0.748)
PCGA-07	4 - 8 (0.157- 0.315)	12.7 (0.500)	PG 7	8 (0.315)	26 (1.02)	38.5 (1.516)	15 (0.591)	19 (0.748)
PCGA-09R	3 - 7 (0.118- 0.276)	15.4 (0.606)	PG 9	8 (0.315)	29 (1.14)	47 (1.850)	19 (0.748)	22 (0.866)
PCGA-09	5 - 10 (0.197- 0.394)	15.4 (0.606)	PG 9	8 (0.315)	29 (1.14)	47 (1.850)	19 (0.748)	22 (0.866)
PCGA-11R	5 - 7 (0.197- 0.276)	18.8 (0.740)	PG 11	8 (0.315)	31.3 (1.23)	51 (2.008)	22 (0.866)	24 (0.945)
PCGA-11	6 - 12 (0.236- 0.472)	18.8 (0.740)	PG 11	8 (0.315)	31.3 (1.23)	51 (2.008)	22 (0.866)	24 (0.945)
PCGA-13.5R	7 - 12 (0.276- 0.472)	20.7 (0.815)	PG 13.5	9 (0.354)	34 (1.34)	54.7 (2.154)	24 (0.945)	27 (1.063)
PCGA-13.5	10 - 14 (0.394- 0.551)	20.7 (0.815)	PG 13.5	9 (0.354)	34 (1.34)	54.7 (2.154)	24 (0.945)	27 (1.063)
PCGA-16	11 - 17 (0.433- 0.669)	22.8 (0.900)	PG 16	10 (0.394)	38.2 (1.50)	57 (2.241)	27 (1.063)	29 (1.142)
PCGA-21	15 - 21 (0.591- 0.827)	28.6 (1.125)	PG 21	11 (0.433)	45.7 (1.80)	71 (2.795)	33 (1.299)	36 (1.417)
PCGA-29	21 - 28 (0.827- 1.102)	37.4 (1.475)	PG 29	11 (0.433)	57 (2.24)	85 (3.346)	42 (1.654)	46 (1.811)

Standard color is gray. For black, add "-B" to the end of the part number (e.g. PCGA-09R-B).

Materials:

Body: Polyamide
Seal: Neoprene



Cable Glands: PG Threads

Adapters

PG to NPT Adapter						
Part Number	A External	B Internal	C (mm)	D (mm)	E (mm)	F (mm)
PG11-3/8	PG 11	3/8" NPT	14	6.0	13.5	20
PG11-1/2	PG 11	1/2" NPT	18	6.5	13	24
PG13.5-1/2	PG 13.5	1/2" NPT	18	6.5	17	24
PG16-1/2	PG 16	1/2" NPT	18	6.5	17	24
PG21-3/4	PG 21	3/4" NPT	18	7.0	22	30
PG29-1	PG 29	1.0" NPT	18	8.0	29	39
PG36-1.25	PG 36	1.25" NPT	20	9.0	36	50
PG42-1.5	PG 42	1.5" NPT	18	10	42.7	57

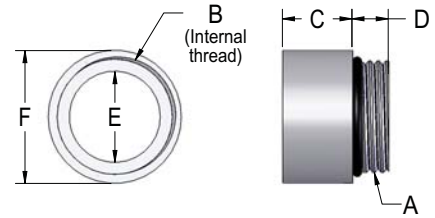

Materials:

Body: Nickel Plated Brass
O-Ring: BUNA-N

PG to Metric Adapter						
Part Number	A External	B Internal	C (mm)	D (mm)	E (mm)	F (mm)
PG07-M12	PG 07	M12 x 1.5	14	5	15	9
PG09-M16	PG 09	M16 x 1.5	19	6	16	12.2
PG11-M16	PG 11	M16 x 1.5	22	6	16	13
PG13.5-M20	PG 13.5	M20 x 1.5	24	6.5	17.5	16
PG16-M20	PG 16	M20 x 1.5	27	6.5	17.5	18.5
PG16-M25	PG 16	M25 x 1.5	30	6.5	18.5	18.5
PG21-M25	PG 21	M25 x 1.5	32	7	19	23
PG21-M32	PG 21	M32 x 1.5	36	7	20	23
PG29-M40	PG 29	M40 x 1.5	43	8	21	32
PG36-M50	PG 36	M50 x 1.5	55	9	23	42
PG42-M63	PG 42	M63 x 1.5	65	10	25	48

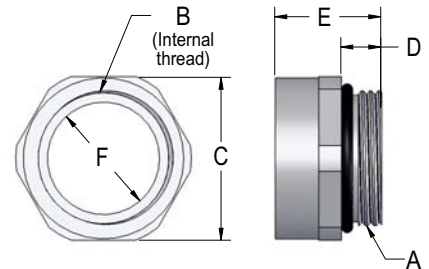

Materials:

Body: Nickel Plated Brass
O-Ring: BUNA-N

Cable Glands & Adapters

Cable Glands: PG Threads

Nuts ❖ Plastic & Metal

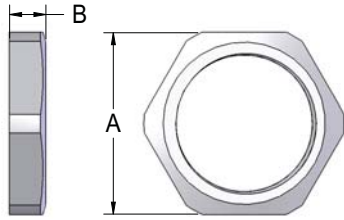

Material:
Polyamide

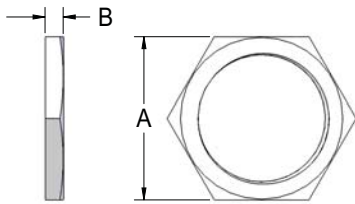

Standard Metal Nut

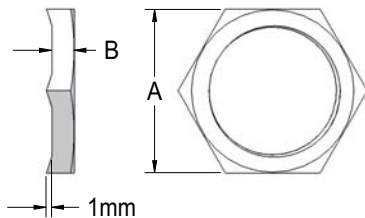

Cutting Metal Nut

Plastic Nuts				
Part Number		A (mm)	B (mm)	Thread Type
Gray	Black			
207PA	207PA/SW	19	5	PG 7
209PA	209PA/SW	22	5	PG 9
211PA	211PA/SW	24	5	PG 11
213PA	213PA/SW	27	6	PG 13.5
216PA	216PA/SW	30	6	PG 16
221PA	221PA/SW	36	7	PG 21
229PA	229PA/SW	46	7	PG 29
236PA	236PA/SW	60	8	PG 36
242PA	242PA/SW	65	8	PG 42
248PA	248PA/SW	70	8	PG 48

Metal Nuts				
Part Number		A (mm)	B (mm)	Thread Type
Standard	Cutting			
207M	207MPOT	15	2.8	PG 7
209M	209MPOT	18	2.8	PG 9
211M	211MPOT	21	3	PG 11
213M	213MPOT	23	3	PG 13.5
216M	216MPOT	26	3	PG 16
221M	221MPOT	32	3.5	PG 21
229M	229MPOT	41	4	PG 29
236M	236MPOT	51	5	PG 36
242M	242MPOT	65	5	PG 42
248M	248MPOT	69	5.5	PG 48

Material:
Nickel Plated Brass



Cable Glands: PG Threads

Blanking Plugs ❖ Blind Plugs

Blanking Plugs							
Part Number			Plastic		Metal		Thread Type
Gray Plastic	Black Plastic	Metal	Diameter (mm)	Thread Length (mm)	Diameter (mm)	Thread Length (mm)	
CRB-07PA	CRB-07PA/SW	CRB-07	15	6	16	4.5	PG 07
CRB-09PA	CRB-09PA/SW	CRB-09	19	6	19	4.5	PG 09
CRB-11PA	CRB-11PA/SW	CRB-11	22	6	22	4.5	PG 11
CRB-13.5PA	CRB-13.5PA/SW	CRB-13.5	25	6	24	6.0	PG 13.5
CRB-16PA	CRB-16PA/SW	CRB-16	27	6	26	6.0	PG 16
CRB-21PA	CRB-21PA/SW	CRB-21	33	8	32	6.0	PG 21
CRB-29PA	CRB-29PA/SW	CRB-29	44.5	8	39	8.0	PG 29
CRB-36PA	CRB-36PA/SW	CRB-36	55.5	10	50	9.0	PG 36
CRB-42PA	CRB-42PA/SW	CRB-42	62.5	10	57	10.0	PG 42
CRB-48PA	CRB-48PA/SW	CRB-48	69.5	12	64	10.0	PG 48

Materials:

Metal: Nickel Plated Brass

Plastic: Polystyrene

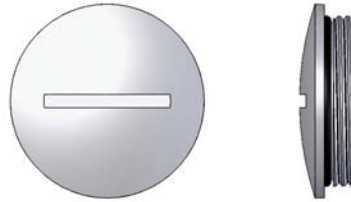

Blind Plugs

This insert is used to block a PCG or MCG style cable gland that is not currently in use, but is installed onto a panel. The Blind Plug will enable the cable gland to seal to IP 68. The Blind Plug is NOT for use in the EX style cable glands.

Blind Plugs						
Part Number	Thread Type	L	H	D1	D2	D3
PG07-BP	PG 07	6	14	8.5	6.5	5
PG09-BP	PG 09	7	16	10	8	6
PG11-BP	PG 11	8	18	12	10	7
PG13.5-BP	PG 13.5	9	20	14	12	9
PG16-BP	PG 16	10	22.5	16	14	12
PG21-BP	PG 21	12	26.5	20	18	16
PG29-BP	PG 29	14	30.5	28	25	20

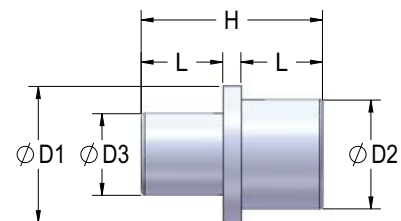

Material:

Polyamide

Cable Glands: PG Threads

Reducers & Enlargers



PG Reducers					
Part Number	A	B	C (mm)	D (mm)	E (mm)
CEC-07	PG 09	PG 07	18	2.5	6
CEC-07X	PG 11	PG 07	20	2.5	6
CEC-07Y	PG 13.5	PG 07	24	3	6.5
CEC-07Z	PG 16	PG 07	24	3	6.5
CEC-09	PG 11	PG 09	20	2.5	6
CEC-09X	PG 13.5	PG 09	24	3	6.5
CEC-09Y	PG 16	PG 09	24	3	6.5
CEC-11	PG 13.5	PG 11	24	3	6.5
CEC-11X	PG 16	PG 11	24	3	6.5
CEC-13.5	PG 16	PG 13.5	24	3	6.5
CEC-13.5X	PG 21	PG 13.5	32	3	7
CEC-16	PG 21	PG 16	32	3	7
CEC-16X	PG 29	PG 16	41	3.5	8
CEC-21	PG 29	PG 21	41	3.5	8
CEC-29	PG 36	PG 29	50	3.5	9

PG Enlargers						
Part Number	A	B	C (mm)	D (mm)	E (mm)	F (mm)
CRC-07	PG 07	PG 09	10	5	10	17
CRC-09	PG 09	PG 11	10.5	6	12	20
CRC-09X	PG 09	PG 13.5	11.5	6	12	22
CRC-11	PG 11	PG 13.5	11.5	6	15	22
CRC-11X	PG 11	PG 16	12.5	6.5	15	24
CRC-13.5	PG 13.5	PG 16	12.5	6.5	17	24
CRC-16	PG 16	PG 21	14.5	6.5	18.5	30
CRC-16X	PG 16	PG 29	16	6.5	18.5	39
CRC-21	PG 21	PG 29	16	7	24	39
CRC-29	PG 29	PG 36	19.5	8	32	50
CRC-36	PG 36	PG 42	22	9	42	57

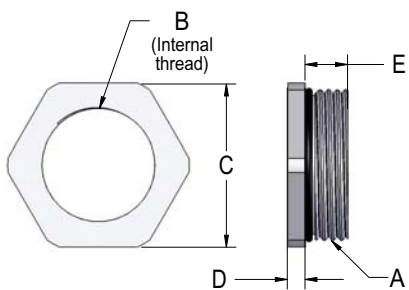

Materials:

Body: Nickel Plated Brass
O-Ring: BUNA-N

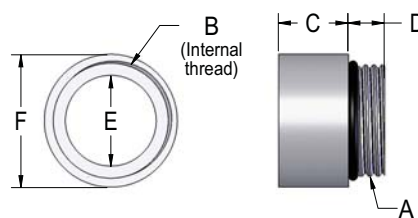

Materials:

Body: Nickel Plated Brass
O-Ring: BUNA-N



Cable Glands: Metric Threads

Standard Brass Cable Glands

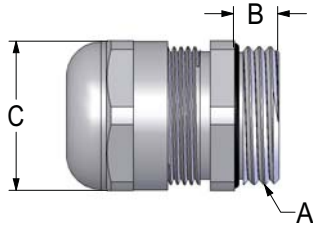

Mencom Cable Glands are easy to use and provide a good strain relief and water tight seal for round cables. The cable glands are rated up to IP 68 (comparable to NEMA 6P). The glands have a wide clamping range.

A Locking Nut and an O-Ring are supplied on all Metric threaded Metal Cable Glands, except where noted.

Part Number	Diameter Range (mm)	A Mounting Hole Clearance (mm)	B Thread Length (mm)	C Wrench Flats (mm)	Thread Type
MCG-M06*	2 - 3.2	6.5	6	8	M 6 x 1.0
MCG-M08*	3 - 5	8.5	4	11	M 8 x 1.25
MCG-M12	3 - 6	12.5	5	14	M12 x 1.5
MCG-M16	3 - 9	16.5	5	17	M16 x 1.5
MCG-M20	5 - 13	20.5	6	22	M20 x 1.5
MCG-M25	8 - 16	25.5	7	27	M25 x 1.5
MCG-M32	12 - 21	32.5	8	34	M32 x 1.5
MCG-M40	16 - 27	40.5	8	43	M40 x 1.5
MCG-M50	21 - 35	50.5	9	55	M50 x 1.5
MCG-M63	27 - 48	63.5	10	65	M63 x 1.5

* MCG-M06 & MCG-M08 are not supplied with Locking Nuts. Nuts are not available for these cable glands.

Material:

Body: Nickel Plated Brass
 Insert: Polyamide
 Seal: Neoprene
 O-Ring: BUNA-N

Cable Glands: Metric Threads

Standard Plastic Cable Glands

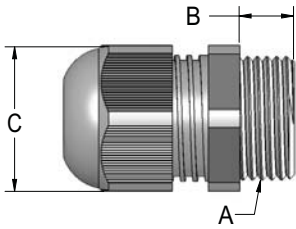

Mencom Cable Glands are easy to use and provide a good strain relief and water tight seal for round cables. The cable glands are rated up to IP 68-5 Bar (comparable to NEMA 6P). The glands have a wide clamping range.

A Locking Nut is supplied on all Metric threaded parts. O-Rings are not required to maintain a seal on any sizes smaller than M32. An O-Ring is supplied on size M32 and larger.

Part Number		Diameter Range (mm)	A Mounting Hole Clearance (mm)	B Thread Length (mm)	C Wrench Flats (mm)	Thread Type
Gray	Black					
PCG-M12R	PCG-M12R-B	2 - 5	12.5	8	15	M12 x 1.5
PCG-M12	PCG-M12-B	3 - 6.5	12.5	8	15	M12 x 1.5
PCG-M16R	PCG-M16R-B	3 - 7	16.5	8	22	M16 x 1.5
PCG-M16	PCG-M16-B	5 - 10	16.5	8	22	M16 x 1.5
PCG-M20R	PCG-M20R-B	5 - 9	20.5	8	24	M20 x 1.5
PCG-M20	PCG-M20-B	10 - 14	20.5	8	27	M20 x 1.5
PCG-M25R	PCG-M25R-B	9 - 16	25.5	8	33	M25 x 1.5
PCG-M25	PCG-M25-B	13 - 18	25.5	8	33	M25 x 1.5
PCG-M32R	PCG-M32R-B	12 - 20	32.5	10	42	M32 x 1.5
PCG-M32	PCG-M32-B	18 - 25	32.5	10	42	M32 x 1.5
PCG-M40R	PCG-M40R-B	20 - 26	40.5	10	53	M40 x 1.5
PCG-M40	PCG-M40-B	22 - 32	40.5	10	53	M40 x 1.5
PCG-M50R	PCG-M50R-B	25 - 31	50.5	12	60	M50 x 1.5
PCG-M50	PCG-M50-B	30 - 38	50.5	12	60	M50 x 1.5
PCG-M63R	PCG-M63R-B	29 - 35	63.5	12	65	M63 x 1.5
PCG-M63	PCG-M63-B	34 - 44	63.5	12	65	M63 x 1.5

For the Flex Style Version, add "S" to the part number (e.g. PCG-M25-BS). Flex Styles are not available on the PCG-M32 to PCG-M63 versions.

Longer thread styles are available (15 mm long for M16 - M32 and 18 mm long for M40 - M63). Add an "L" after the part number, but before any "-B" (e.g. PCG-M32RL or PCG-M25L-B)

Material:

Body: Polyamide

Seal: Neoprene

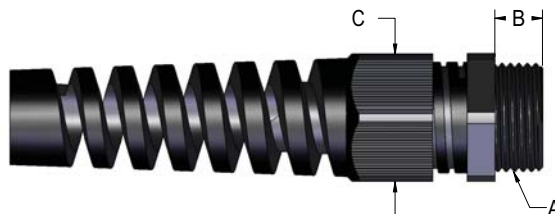



Cable Glands: Metric Threads

Dual Grommet Plastic Cable Glands

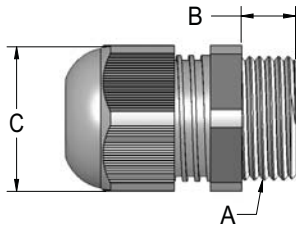

These Cable Glands have a dual grommet system that allows for a much wider range in diameter than the standard plastic cable glands. Cables that are in the lower part of the diameter range will fit into the cable gland without any change. For cables that are in the upper part of the diameter range, the dome nut is removed and the seals are removed. Separate the inner seal from the outer seal into the cable gland and then put the outer seal back in place. It is now ready for use with the larger cable.

A Locking Nut is supplied on all Metric threaded parts. An O-Ring is not needed on any sizes smaller than M32. An O-Ring is supplied on size M32 and larger.

Part Number		Diameter Range (mm)	A Mounting Hole Clearance (mm)	B Thread Length (mm)	C Wrench Flats (mm)	Thread Type
Gray	Black					
PCGU-M12	PCGU-M12-B	2 - 5	12.5	8	15	M12 x 1.5
PCGU-M16	PCGU-M16-B	3 - 10	16.5	8	20	M16 x 1.5
PCGU-M20	PCGU-M20-B	5 - 13	20.5	8	24	M20 x 1.5
PCGU-M25	PCGU-M25-B	8 - 17	25.5	8	29	M25 x 1.5
PCGU-M32	PCGU-M32-B	12 - 21	32.5	10	36	M32 x 1.5
PCGU-M40	PCGU-M40-B	16 - 28	40.5	10	46	M40 x 1.5
PCGU-M50	PCGU-M50-B	21 - 35	50.5	12	55	M50 x 1.5
PCGU-M63	PCGU-M63-B	27 - 48	63.5	12	68	M63 x 1.5

Material:

Body: Polyamide

O-Ring: BUNA-N

Cable Glands: Metric, PG & NPT Threads

Cable Glands for Flat & Festoon Cable

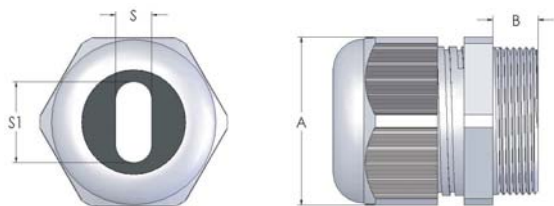

Cable Glands for Flat Cable Applications

Mencom's plastic and brass cable glands are perfect for flat and festoon cables. Sealing ratings up to IP 66 can be obtained.

A Locking Nut is supplied on all Metric and PG threaded parts. An O-Ring is not needed for the plastic style cable glands smaller than M32. O-Rings are supplied on M32 and larger sizes.

Plastic Version									
Part Numbers		A Wrench Flats (mm)	B Thread Length (mm)	S1 DIM MAX (mm)	S1 DIM MIN (mm)	S DIM MAX (mm)	S DIM MIN (mm)	Thread Type	Mounting Hole Clearance (mm)
Gray	Black								
PFG-M20-12X5	PFG-M20-12X5-B	24	8	12	8	5	2	M20 x 1.5	20.5
PFG-M25-16.3X6	PFG-M25-16.3X6-B	29	8	16.3	10	6	2	M25 x 1.5	25.5
PFG-M32-20X9	PFG-M32-20X9-B	36	10	20	12	9	3	M32 x 1.5	32.5
PFG-M40-27X10	PFG-M40-27X10-B	46	10	27	19	10	3	M40 x 1.5	40.5
PFG-M50-34X13	PFG-M50-34X13-B	55	12	34	23	13	4	M50 x 1.5	50.5
PFG-M63-45X15	PFG-M63-45X15-B	68	12	45	32	15	6	M63 x 1.5	63.5
PFG-1/2-12X5	PFG-1/2-12X5-B	22	13	12	8	5	2	1/2-14 NPT	21.5
PFG-13.5-12X5	PFG-13.5-12X5-B	22	6.5	12	8	5	2	PG13.5	20.7

Brass Version								
Part Numbers	A Wrench Flats (mm)	B Thread Length (mm)	S1 DIM MAX (mm)	S1 DIM MIN (mm)	S DIM MAX (mm)	S DIM MIN (mm)	Thread Type	Mounting Hole Clearance (mm)
MFG-M20-12X5	24	6	12	9	5	2	M20 x 1.5	20.5
MFG-M25-16.3X6	29	7	16.3	11	6	2	M25 x 1.5	25.5
MFG-M32-20X9	36	8	20	13	9	3	M32 x 1.5	32.5
MFG-M40-27X10	46	8	27	17	10	3	M40 x 1.5	40.5
MFG-M50-34X13	55	9	34	24	13	4	M50 x 1.5	50.5
MFG-M63-45X15	68	10	45	33	15	6	M63 x 1.5	63.5
MFG-1/2-12X5	22	13	12	9	5	2	1/2" - 14 NPT	21.5
MFG-13.5-12X5	22	6.5	12	9	5	2	PG 13.5	20.7

Plastic Version Materials:

Body: Polyamide
Grommet: TPE
O-Ring: BUNA-N

Brass Version Materials:

Body: Nickel Plated
Brass
Insert: Polyamide
Grommet: TPE
O-Ring: BUNA-N

Sealing for these cable glands is IP 66 only if the cable matches the slot dimensions exactly. For cables that are less than the "max", but more than the "min", the seals are rated to IP 54. Longer thread lengths are available for some of these cable glands, please consult the factory.



Cable Glands: Metric Threads

EMI Shielding Brass Cable Glands ❖ Metric Threads

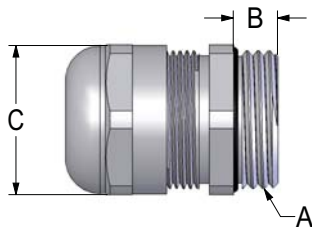

Mencom EMI Cable Glands provide an easy way to ground the shield from a shielded cable to the body of the metal cable gland. The seal rating is IP 68.

Special cutting Locking Nuts can be ordered separately. The Lock Nuts have sharp "teeth" that will cut through painted surfaces, see page V-21.

Part Number	Diameter Range (mm)	A Mounting Hole Clearance (mm)	B Thread Length (mm)	C Wrench Flats (mm)	Thread Type
MCGB-M12 *	3 - 6	12.5	5	14	M12 x 1.5
MCGB-M12L	3 - 6	12.5	10	14	M12 x 1.5
MCGB-M16 *	3 - 9	16.5	5	17	M16 x 1.5
MCGB-M16L	3 - 9	16.5	10	17	M16 x 1.5
MCGB-M20 *	5 - 13	20.5	6	22	M20 x 1.5
MCGB-M20L	5 - 13	20.5	10	22	M20 x 1.5
MCGB-M25	8 - 16	25.5	7	27	M25 x 1.5
MCGB-M25L	8 - 16	25.5	11	27	M25 x 1.5
MCGB-M32	12 - 21	32.5	8	34	M32 x 1.5
MCGB-M32L	12 - 21	32.5	13	34	M32 x 1.5
MCGB-M40	16 - 27	40.5	8	43	M40 x 1.5
MCGB-M40L	16 - 27	40.5	13	43	M40 x 1.5
MCGB-M50	21 - 35	50.5	9	55	M50 x 1.5
MCGB-M50L	21 - 35	50.5	14	55	M50 x 1.5
MCGB-M63	27 - 48	63.5	10	65	M63 x 1.5

Lock Nuts are supplied with all cable glands listed other than those with an *. These threads are too short to be used with Lock Nuts.



Materials:

Body: Nickel Plated Brass
 Insert: Polyamide
 Seal: Neoprene

Cable Glands: Metric Threads

Explosion-Proof Brass Cable Glands

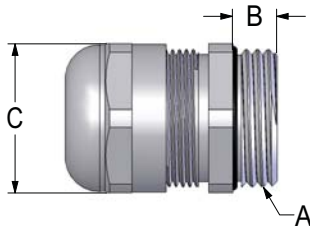

These Explosion-Proof Cable Glands are made of Nickel Plated Brass and are for potentially explosive areas according to EN 50014 and EN 50019. The type of protection is EExd e II-increased safety. There is excellent strain relief, a wide clamping range, and a torsion protected plastic insert that is resistant to impact at cold temperatures. Also, the cable glands feature a neoprene sealing insert, the O-Ring seal is BUNA-N, and the permanent ambient temperature is -25°C to +80°C (-13° F to +176°F). Protection type is IP 68 according to EN 60529, E-Generation, certificate of conformity: DMT 99 ATEX E 016. Locking Nuts must be ordered separately.

Part Number	Diameter Range (mm)	A Mounting Hole Clearance (mm)	B Thread Length (mm)	C Wrench Flats (mm)	Thread Type
MCGEX-M12	3 - 6.5	12.5	5	14	M12 x 1.5
MCGEX-M16	5 - 9	16.5	5	17	M16 x 1.5
MCGEX-M20	6 - 12	20.5	6	22	M20 x 1.5
MCGEX-M25	11 - 16	25.5	7	27	M25 x 1.5
MCGEX-M32	14 - 21	32.5	8	34	M32 x 1.5
MCGEX-M40	19 - 27	40.5	8	43	M40 x 1.5
MCGEX-M50	24 - 35	50.5	9	55	M50 x 1.5
MCGEX-M63	32 - 42	63.5	10	65	M63 x 1.5

ATEX 100a

With a view toward further harmonization of the legal provisions in the European Union in respect to the use of equipment and protection systems in accordance with the regulations in areas subject to explosion hazards, the European Parliament and Council passed Directive 94/9/EC on the 23rd of March, 1994. This directive is also known as ATEX 100A. The period for implementing this guideline started on the 1st of March, 1996 and from the 1st of July, 2003 onwards, it will replace and supplement all directives on explosion protection applicable to date at the European level. The single market requires national regulations to be replaced by European Standards (EN).

The ATEX 100A governs the requirements for all (both electrical and non-electrical) equipment and protection systems which are intended for use in areas subject to explosion hazards. Monitoring, control and safety equipment for use outside areas subject to explosion hazards also fall within the provisions of this directive if they are necessary in view of explosion hazards for the safe running of equipment and protection systems.

The explosion-proof cable glands listed in this catalog are produced in Germany and are for use in areas subject to explosion hazards. Such parts are also termed "cable glands and entry fittings" (abbreviated KLE) and "accessories."

EN 50014 defines cable glands and entry fittings as equipment which allows one or several electrical and/or fibre optic cables or wires to be inserted into electrical equipment while retaining the corresponding type of protection.

The explosion-proof KLE items contained in this catalog are suitable for inserting cables and wires into housing of protection type EEx e "increased safety," and EEx i "inherent safety" in Device Groups II and Categories 2 and 3.

For further information on ATEX and European explosion-proof classifications, please consult the factory.

These specifications are not intended to be correlated to or to be a substitution for U.S. Explosion-Proof ratings.



Cable Glands: Metric Threads

Explosion-Proof Plastic Cable Glands

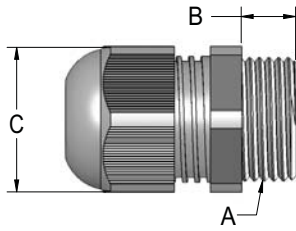

Type of protection EExd e II- increased safety. Permanent ambient temperature -50°C to +55°C (-58°F to +131°F). Protection type is IP 66 according to EN 60529. Certificate of conformity: PTB-No. Ex-92-C.3142; PTB-No. Ex-92.C3108X (M12 & M16).

Locking Nuts must be ordered separately.

Color	Part Number	Diameter Range (mm)	A Mounting Hole Clearance (mm)	B Thread Length (mm)	C Wrench Flats (mm)	Thread Type
Black	PCGEX-M12-B	4 - 7	12.5	8	15	M12 x 1.5
Black	PCGEX-M12L-B	4 - 7	12.5	12	15	M12 x 1.5
Black	PCGEX-M16-B	5.5 - 10	16.5	8	20	M16 x 1.5
Black	PCGEX-M16L-B	5.5 - 10	16.5	12	20	M16 x 1.5
Black	PCGEX-M20-B	5.5 - 13	20.5	8	24	M20 x 1.5
Black	PCGEX-M20L-B	5.5 - 13	20.5	13	24	M20 x 1.5
Black	PCGEX-M25-B	8 - 17	25.5	8	29	M25 x 1.5
Black	PCGEX-M25L-B	8 - 17	25.5	13	29	M25 x 1.5
Black	PCGEX-M32-B	12 - 21	32.5	10	36	M32 x 1.5
Black	PCGEX-M40-B	17 - 28	40.5	10	46	M40 x 1.5
Black	PCGEX-M50-B	22 - 35	50.5	12	55	M50 x 1.5
Black	PCGEX-M63-B	27 - 48	63.5	12	68	M63 x 1.5

Intrinsically safe explosion proof versions are also available, please consult the factory. Protection type EExd e II is a standard European classification.

Materials: ALCRYM

These specifications are NOT intended to be correlated to or to be a substitution for U.S. Explosion-Proof ratings.

Cable Glands: Metric Threads

Nuts & Plugs



Nuts								
Part Number				Plastic		Metal		Thread Type
Gray Plastic	Black Plastic	Metal	Cutting	A (mm)	B (mm)	A (mm)	B (mm)	
2M12PA	2M12PA/SW	2M12M	2M12MPOT	17	5	15	2.8	M12 x 1.5
2M16PA	2M16PA/SW	2M16M	2M16MPOT	22	5	19	2.8	M16 x 1.5
2M20PA	2M20PA/SW	2M20M	2M20MPOT	27	6	24	3	M20 x 1.5
2M25PA	2M25PA/SW	2M25M	2M25MPOT	32	6	30	3.5	M25 x 1.5
2M32PA	2M32PA/SW	2M32M	2M32MPOT	41	7	36	4	M32 x 1.5
2M40PA	2M40PA/SW	2M40M	2M40MPOT	50	7	46	5	M40 x 1.5
2M50PA	2M50PA/SW	2M50M	2M50MPOT	60	8	60	5	M50 x 1.5
2M63PA	2M63PA/SW	2M63M	2M63MPOT	75	8	70	6	M63 x 1.5

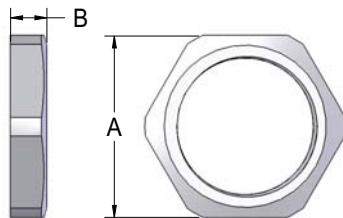

Material:
 Plastic: Polyamide
 Metal: Nickel Plated Brass
 O-Ring: BUNA-N

Blanking Plugs							
Part Number			Plastic		Metal		Thread Type
Gray Plastic	Black Plastic	Metal	Diameter (mm)	Thread Length (mm)	Diameter (mm)	Thread Length (mm)	
CRB-M12PA	CRB-M12PA/SW	CRB-M12	15	6	16	5	M12 x 1.5
CRB-M16PA	CRB-M16PA/SW	CRB-M16	20	6	20	6	M16 x 1.5
CRB-M20PA	CRB-M20PA/SW	CRB-M20	24	6	24	6.5	M20 x 1.5
CRB-M25PA	CRB-M25PA/SW	CRB-M25	30	8	28	7	M25 x 1.5
CRB-M32PA	CRB-M32PA/SW	CRB-M32	37	8	35	8	M32 x 1.5
CRB-M40PA	CRB-M40PA/SW	CRB-M40	46	8	45	8	M40 x 1.5
CRB-M50PA	CRB-M50PA/SW	CRB-M50	56	10	55	9	M50 x 1.5
CRB-M63PA	CRB-M63PA/SW	CRB-M63	70	12	68	10	M63 x 1.5

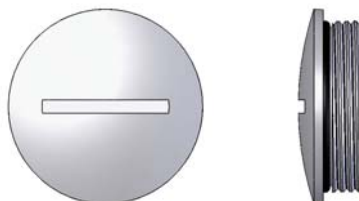

Material:
 Plastic: Polyamide
 Metal: Nickel Plated Brass
 O-Ring: BUNA-N

Cable Glands & Adapters



Cable Glands: Metric Threads

Adapters

Metric to PG						
Part Number	A	B	C (mm)	D (mm)	E (mm)	F (mm)
M12-PG9	M12 x 1.5	PG 09	11	5	8	17
M16-PG11	M16 x 1.5	PG 11	11.5	5	12	20
M20-PG16	M20 x 1.5	PG 16	13.5	6	15	24
M25-PG21	M25 x 1.5	PG 21	14.5	7	21	30
M32-PG29	M32 x 1.5	PG 29	17	8	26	39
M40-PG36	M40 x 1.5	PG 36	20.5	8	34	50
M50-PG42	M50 x 1.5	PG 42	23	9	44	57
M50-PG48	M50 x 1.5	PG 48	24	9	44	64

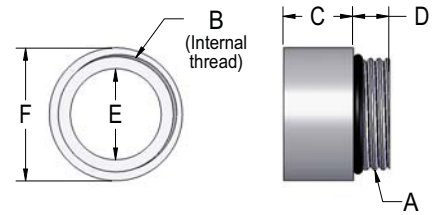

Material:

Body: Nickel Plated Brass
O-Ring: BUNA-N

Metric to NPT (Metal)						
Part Number	A	B	C (mm)	D (mm)	E (mm)	F (mm)
M16-1/2	M16 x 1.5	1/2" NPT	18.5	6.5	11	24
M20-1/2	M20 x 1.5	1/2" NPT	18.5	6.5	15	24
M25-3/4	M25 x 1.5	3/4" NPT	21	7	18	30
M32-3/4	M32 x 1.5	3/4" NPT	18	8	23	37
M32-1	M32 x 1.5	1" NPT	25	8	27	38
M40-1.25	M40 x 1.5	1.25" NPT	26	8	34	46

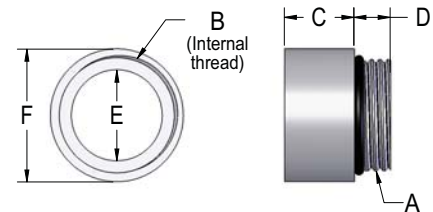

Material:

Body: Nickel Plated Brass
O-Ring: BUNA-N

Metric to NPT (Black Plastic)						
Part Number	A	B	C (mm)	D (mm)	E (mm)	F (mm)
M16-1/2PA/SW	M16 x 1.5	1/2" NPT	27	8	28	11
M20-1/2PA/SW	M20 x 1.5	1/2" NPT	27	8	27	15

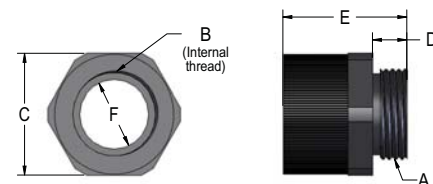

Material:

Body: Polyamide

Cable Glands & Adapters

Cable Glands: Metric Threads

Reducers & Enlargers

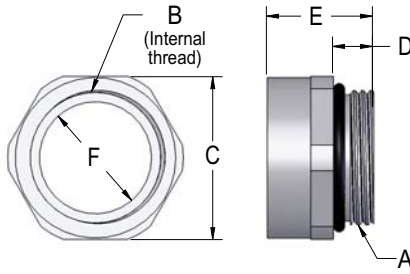

Material:

Body: Nickel Plated Brass
O-Ring: BUNA-N

Metric Enlargers						
Part Number	A	B	C (mm)	D (mm)	E (mm)	F (mm)
CRC-M12	M12 x 1.5	M16 x 1.5	18	5	16	8
CRC-M16	M16 x 1.5	M20 x 1.5	22	5	16.5	12
CRC-M20	M20 x 1.5	M25 x 1.5	27	6	18.5	15
CRC-M25	M25 x 1.5	M32 x 1.5	34	7	20.5	21
CRC-M32	M32 x 1.5	M40 x 1.5	42	8	23.5	26
CRC-M40	M40 x 1.5	M50 x 1.5	52	8	30	34
CRC-M50	M50 x 1.5	M63 x 1.5	65	9	32.5	44

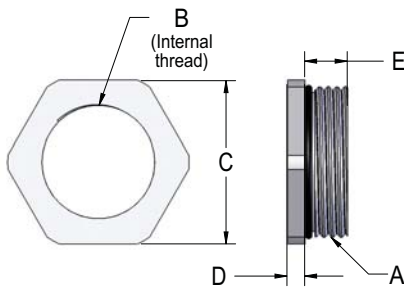

Material:

Body: Nickel Plated Brass
O-Ring: BUNA-N

Metric Reducers					
Part Number	A	B	C (mm)	D (mm)	E (mm)
CEC-M12	M16 x 1.5	M12 x 1.5	17	5	8
CEC-M12X	M20 x 1.5	M12 x 1.5	22	6	9
CEC-M16	M20 x 1.5	M16 x 1.5	22	6	9
CEC-M16X	M25 x 1.5	M16 x 1.5	27	7	10
CEC-M20	M25 x 1.5	M20 x 1.5	27	7	10
CEC-M20X	M32 x 1.5	M20 x 1.5	34	8	11
CEC-M25	M32 x 1.5	M25 x 1.5	34	8	11
CEC-M20Y	M40 x 1.5	M20 x 1.5	43	8	12
CEC-M25X	M40 x 1.5	M25 x 1.5	43	8	12
CEC-M32	M40 x 1.5	M32 x 1.5	43	8	12
CEC-M25Y	M50 x 1.5	M25 x 1.5	55	9	13
CEC-M32X	M50 x 1.5	M32 x 1.5	55	9	13
CEC-M40	M50 x 1.5	M40 x 1.5	55	9	13
CEC-M32Y	M63 x 1.5	M32 x 1.5	65	10	14
CEC-M40X	M63 x 1.5	M40 x 1.5	65	10	14
CEC-M50	M63 x 1.5	M50 x 1.5	65	10	14



Cable Glands: PG Threads

Multi-Hole Cable Gland Inserts ❖ PG 9 - PG 13.5 Cable Gland Accessories

Mencom Multi-Hole Cable Gland Inserts will allow the user to use one cable gland for multiple wires, cables, or tubes. The inserts fit into the Mencom "MCG" or "PCG" cable glands, and will seal to IP 65.

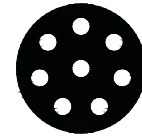

Part Number	# of Holes	Diameter of Holes mm (inches)	Fits Into	
PG09-0x0	0	None		
PG09-2x3	2	3 (0.118)		
PG09-2x3.5	2	3.5 (0.138)	MCG-09	PCG-09
PG09-3x2	3	2 (0.079)	MCG-09R	PCG-09-B
PG09-3x3.5	3	3.5 (0.138)	MCG-3/8	PCG-09R
PG09-4x2	4	2 (0.079)	MCG-3/8R	PCG-09R-B
PG09-4x3	4	3 (0.118)		
PG11-0x0	0	None		
PG11-2x3	2	3 (0.118)		
PG11-2x4	2	4 (0.157)	MCG-11	PCG-3/8-B
PG11-2x4.5	2	4.5 (0.177)	MCG-11R	PCG-3/8R
PG11-2x5	2	5 (0.197)	PCG-11	PCG-3/8R-B
PG11-3x3	3	3 (0.118)	PCG-11-B	PCG-M16
PG11-3x4	3	4 (0.157)	PCG-11R	PCG-M16-B
PG11-3x5	3	5 (0.197)	PCG-11R-B	PCG-M16R
PG11-4x3	4	3 (0.118)	PCG-3/8	PCG-M16R-B
PG11-7x2.7	7	2.7 (0.107)		
PG11-8x2	8	2 (0.079)		
PG13.5-0x0	0	None	MCG-13.5	PCG-13.5R-B
PG13.5-2x4.5	2	4.5 (0.177)	MCG-13.5R	PCG-1/2X
PG13.5-2x5	2	5 (0.197)	MCG-1/2	PCG-1/2X-B
PG13.5-2x6	2	6 (0.236)	MCG-1/2R	PCB-1/2Y
PG13-3x4	3	4 (0.157)	PCG-13.5	PCG-1/2Y-B
PG13-3x5	3	5 (0.197)	PCG-13.5-B	PCG-M20R
			PCG-13.5R	PCG-M20R-B
PG16-0x0	0	None		
PG16-2x4	2	4 (0.157)		
PG16-2x6	2	6 (0.236)		
PG16-3x4	3	4 (0.157)	MCG-16	PCG-1/2
PG16-3x4.5	3	4.5 (0.177)	MCG-16R	PCG-1/2-B
PG16-3x5	3	5 (0.197)	PCG-16	PCG-1/2R
PG16-3x6	3	6 (0.236)	PCG-16-B	PCG-1/2R-B
PG16-3x6.5	3	6.5 (0.256)	PCG-16R	PCG-M20
PG16-3x7	3	7 (0.276)	PCG-16R-B	PCG-M20B
PG16-4x4	4	4 (0.157)		
PG16-4x5	4	5 (0.197)		
PG16-4x6	4	6 (0.236)		
PG16-5x4	5	4 (0.157)		

Inserts are intended for use with wires, cables, or tubes that have diameters that are within ± 0.020 " of the "hole diameter" listed.

Inserts without holes allow the user to drill holes for low volume, custom applications.

Cable Glands: PG Threads

Multi-Hole Cable Gland Inserts ❖ PG 16 - PG 29 Cable Gland Accessories



Mencom Multi-Hole Cable Gland Inserts will allow the user to use one cable gland for multiple wires, cables, or tubes. The inserts fit into the Mencom "MCG" or "PCG" cable glands, and will seal to IP 65.

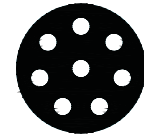

Part Number	# of Holes	Diameter of Holes mm (inches)	Fits Into		
PG21-0x0	0	None	MCG-21 MCG-21R PCG-21-B PCG-21R PCG-21R-B PCG-3/4 PCG-3/4-B PCG-3/4-R PCG-3/4R-B PCG-M25 PCG-M25-B PCG-M25R PCG-M25R-B		
PG21-2x7	2	7 (0.276)			
PG21-2x8	2	8 (0.315)			
PG21-2x9	2	9 (0.354)			
PG21-3x7	3	7 (0.276)			
PG21-3x8	3	8 (0.315)			
PG21-4x5	4	5 (0.197)			
PG21-4x6.5	4	6.5 (0.256)			
PG21-4x7	4	7 (0.276)			
PG21-4x7.5	4	7.5 (0.295)			
PG21-5x5	5	5 (0.197)			
PG29-0x0	0	None			
PG29-5x8.5	5	8.5 (0.335)			
PG29-6x5	6	5 (0.197)			
PG29-6x7.5	6	7.5 (0.295)			
PG29-8x5	8	5 (0.197)			
M25-0x0	0	None	MCG-3/4 MCG-3/4R MCG-M25		
M25-2x8	2	8 (0.315)			
M25-3x4	3	4 (0.157)			
M25-3x7	3	7 (0.107)			
M25-4x5	4	5 (0.197)			
M25-4x6.5	4	6.5 (0.256)			
M25-6x6	6	6 (0.236)			

Inserts can be pre-installed in cable glands for orders of 100 or more. Order as follows:

Multi-Hole Insert
PG 11-3X3

Desired Cable Gland
MCG-11

Resulting Part Number
MCG-11-3X3



Cable Glands: NPT, PG & Metric

ASI Cable Glands & O-Rings ❖ Cable Glands & Accessories

Part Number		Figure Number	A Mounting Hole Clearance	B Thread Length	C Wrench Flats	Thread Type
Gray	Black					
Plastic ASI Cable Glands						
PCG-1/2-ASI	PCG-1/2-B-ASI	Figure 1	.825"	.591"	1.06"	1/2" NPT
PCG-1/2-2ASI	PCG-1/2-B-2ASI	Figure 2	.825"	.591"	1.06"	1/2" NPT
PCG-13.5-ASI	PCG-13.5-B-ASI	Figure 1	.825"	.354"	.945"	PG 13.5
PCG-13.5-2ASI	PCG-13.5-B-2ASI	Figure 2	.825"	.354"	.945"	PG 13.5
PCG-M20-ASI	PCG-M20-B-ASI	Figure 1	20.5 mm	8 mm	27 mm	M20x1.5
PCG-M20-2ASI	PCG-M20-B-2ASI	Figure 2	20.5 mm	8 mm	27 mm	M20x1.5
PCG-M25-ASI	PCG-M25-B-ASI	Figure 1	25.5 mm	8 mm	33 mm	M25x1.5
PCG-M25-2ASI	PCG-M25-B-2ASI	Figure 2	25.5 mm	8 mm	33 mm	M25x1.5
Metal ASI Cable Glands						
MCG-1/2-ASI		Figure 1	.825"	.591"	1.06"	1/2" NPT
MCG-13.5-ASI		Figure 1	.825"	.256"	.945"	PG 13.5
MCG-M20-ASI		Figure 1	20.5 mm	6 mm	22 mm	M20x1.5
MCG-M25-ASI		Figure 1	25.5 mm	7 mm	27 mm	M25x1.5
MCG-M25-2ASI		Figure 2	25.5 mm	7 mm	27 mm	M25x1.5

Figure 1: Single

Plastic Material:

Body: Polyamide
Seal: Neoprene

Metal Material:

Body: Nickel Plated Brass
Insert: Polyamide
Seal: Neoprene

Figure 2: Double

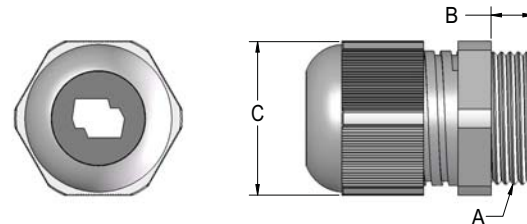
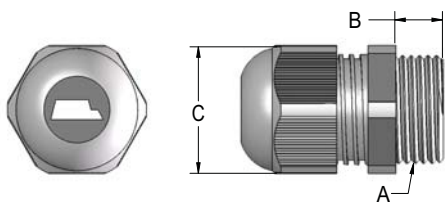

For Metric Threads: O-Rings (100 Pieces/Package)				
Part Number	Size	A (mm)	B (mm)	C (mm)
3M12G	M12	12	9	1.5
309G	M16	16	13	1.5
313G	M20	21	18	2.0
3M25G	M25	27	23	2.0
3M32G	M32	34	29	2.5
3M40G	M40	41	37	2.0
3M50G	M50	52	47	2.5
3M63G	M63	66	60	3.0

For PG Threads: O-Rings (100 Pieces/Package)				
Part Number	Size	A (mm)	B (mm)	C (mm)
307G	PG 07	13	10	1.5
309G	PG 09	17	13	1.5
311G	PG 11	20	16	2.0
313G	PG 13.5	22	18	2.0
316G	PG 16	24	20	2.0
321G	PG 21	28	24	2.0
329G	PG 29	37	33	2.0
336G	PG 36	47	42	2.5
342G	PG 42	53	48	2.5
348G	PG 48	60	54	3.0

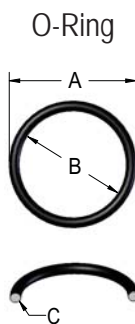

Material:

O-Ring: BUNA-N

Sealing Glands: Click Seal

Click Seal ❖ TSS



Click Seal Metric										
Color	Part Number	Size	IP 67 Diameter Range (mm)	IP 65 Diameter Range (mm)	A Mounting Hole Clearance (mm)	B Panel Thickness Range (mm)	L1 (mm)	L2 (mm)	L3 (mm)	SW (mm)
Gray	SGL-M20-TGY	M20	7 - 11	4 - 11	20.5	2 - 5	17 - 20	5.7	4.0	29.3 - 34.5
Gray	SGL-M25-TGY	M25	7 - 13	4 - 14	25.5	2 - 5	17 - 20	5.7	5.0	34.3 - 40.0

For volume use, black or light gray glands are available. Please consult the factory for part numbers and availability.

Materials:

Body: TPE (Thermoplastic Elastomer) and Polyamide
 Temperature: -20°C to +125°C (-4° to +257°F)
 Protection: IP67 and IP65

Test standard EN60529:1991+A1, EN50262:1998, EMKO-TUI (03-SEC) FI001/84
 The IP67 cable range has been tested to the same EN 50262 pull force requirements as Mencom's standard PCG cable glands.

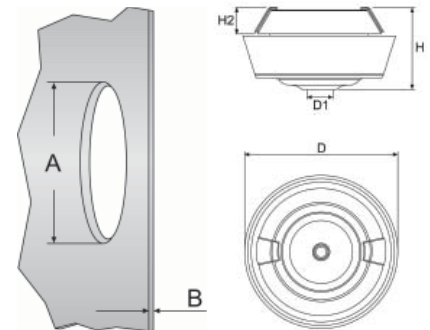

Height of only 17-20 mm, 5.7 mm on the outside irrespective of size. Cable glands are approx. 30-40 mm.

Handles large range of cable and pipe diameters.

Installation time saving up to 90%.

Ergonomic installation

Fixed in both directions when mounted.

Rubber coated tension relief for protection of the cable mantle.

Integrated tension relief

"Pushout" membrane

Self-adjusting to wall thickness 2 - 5 mm.

Space saving design

Fixed IP67 / IP65

Click Seal means no material compression during installation.

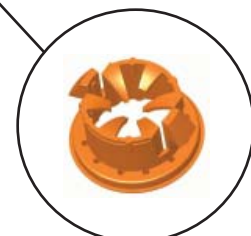

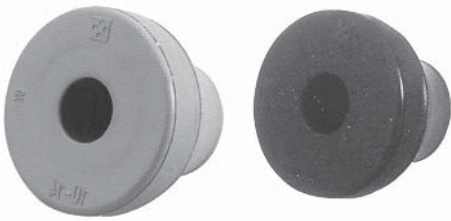

Sealing Glands: PG

EPDM ❖ Chloroprene

EPDM Sealing Glands for PG Holes								
Color	Part Number	Size	Diameter Range (mm)	A Mounting Hole Clearance (mm)	B Panel Thickness Range (mm)	Da (mm)	H (mm)	H1 (mm)
Gray	SG-PG07-EGY	PG 7	3 - 5	13	0.5 - 2	20	12.6	5.4
Gray	SG-PG09-EGY	PG 9	5 - 7	16	1 - 4	21	17.8	10.3
Gray	SG-PG11-EGY	PG 11	7 - 10	19	1 - 4	24	19.8	12.7
Gray	SG-PG16-EGY	PG 16	10 - 14	23	1 - 4	28	21.6	14.7
Gray	SG-PG21-EGY	PG 21	14 - 20	29	1 - 4	35	24.6	17.6
Gray	SG-PG29-EGY	PG 29	20 - 26	38	1 - 4	46	28.5	20.0
Gray	SG-PG36-EGY	PG 36	26 - 35	48	1 - 4	58	34.9	23.9

For volume use, black or light gray glands are available. Please consult the factory for part numbers and availability.

Materials:

Body: EPDM
 Temperature: -40°C to +110°C (-40° to +230°F)
 Protection: IP67

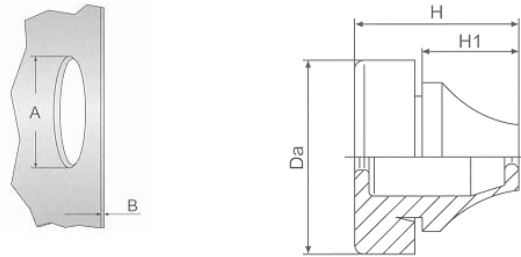

Chloroprene Sealing Glands for PG Holes								
Color	Part Number	Size	Diameter Range (mm)	A Mounting Hole Clearance (mm)	B Panel Thickness Range (mm)	Da (mm)	H (mm)	H1 (mm)
Black	SG-PG07-CBK	PG 7	3 - 5	13	0.5 - 2	20	12.6	5.4
Black	SG-PG09-CBK	PG 9	5 - 7	16	1 - 4	21	17.8	10.3
Black	SG-PG11-CBK	PG 11	7 - 10	19	1 - 4	24	19.8	12.7
Black	SG-PG16-CBK	PG 16	10 - 14	23	1 - 4	28	21.6	14.7
Black	SG-PG21-CBK	PG 21	14 - 20	29	1 - 4	35	24.6	17.6
Black	SG-PG29-CBK	PG 29	20 - 26	38	1 - 4	46	28.5	20.0
Black	SG-PG36-CBK	PG 36	26 - 35	48	1 - 4	58	34.9	23.9

Materials:

Body: Chloroprene
 Temperature: -30°C to +100°C (-22° to +212°F)
 Protection: IP67

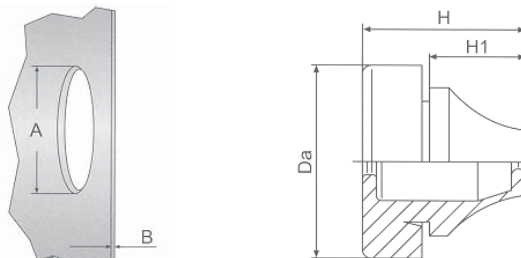

Cable Glands & Adapters

Sealing Glands: Metric

EPDM ❖ Chloroprene ❖ TSS

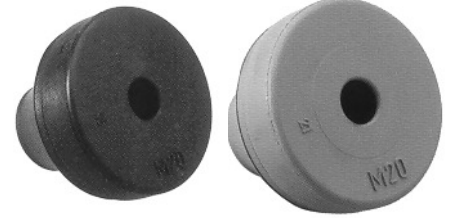

EPDM or Chloroprene Sealing Glands for Metric Holes										
Color	EPDM Part Number	Color	Chloroprene Part Number	Size	Diameter Range (mm)	A Mounting Hole Clearance (mm)	B Panel Thickness Range (mm)	Da (mm)	H (mm)	H1 (mm)
Gray	SG-M12-EGY	Black	SG-M12-CBK	M12	4 - 7	12.5	0.5 - 2	20	12.8	5.6
Gray	SG-M16-EGY	Black	SG-M16-CBK	M16	5 - 9	16.5	1 - 4	21	17.7	11.0
Gray	SG-M20-EGY	Black	SG-M20-CBK	M20	8 - 13	20.5	1 - 4	25.5	20.0	13.4
Gray	SG-M25-EGY	Black	SG-M25-CBK	M25	11 - 17	25.5	1 - 4	30.5	21.3	15.3
Gray	SG-M32-EGY	Black	SG-M32-CBK	M32	15 - 20	32.5	1 - 4	38.5	24.6	18.6
Gray	SG-M40-EGY	Black	SG-M40-CBK	M40	19 - 28	40.5	1 - 4	48.5	29.5	21.7
Gray	SG-M50-EGY	Black	SG-M50-CBK	M50	27 - 35	50.5	1 - 4	60.5	34.8	25.0

For volume use, black or white glands are available. Please consult the factory for part numbers and availability.

Materials:

Body: EPDM
 Temperature: -40°C to +110°C (-40° to +230°F)
 Protection: IP67

Materials:

Body: Chloroprene
 Temperature: -30°C to +100°C (-22° to +212°F)
 Protection: IP67

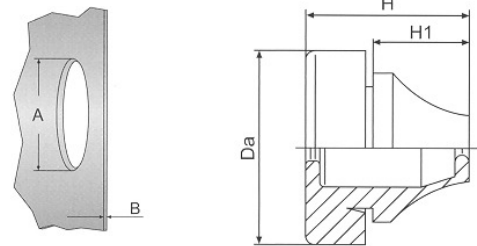

TSS Metric										
Color	Part Number	Size	Diameter Range (mm)	A Mounting Hole Clearance (mm)	B Panel Thickness Range (mm)	H (mm)	H1 (mm)	H2 (mm)	D (mm)	D1 (mm)
Gray	SGC-M16-TGY	M16	5 - 10	16.5	0.5 - 3.0	11	4	6.75	23.5	4
Gray	SGC-M20-TGY	M20	6 - 13	20.5	0.5 - 3.0	11	4	6.75	27.5	5
Gray	SGC-M25-TGY	M25	8 - 17	25.5	0.5 - 3.5	11	4	6.75	32.5	7
Gray	SGC-M32-TGY	M32	12 - 24	32.5	0.5 - 4.5	11	4	6.75	39.5	11

Materials:

Body: TPE (Thermoplastic Elastomer)
 Temperature: -50°C to +125°C (-58° to +257°F)
 Protection: IP67

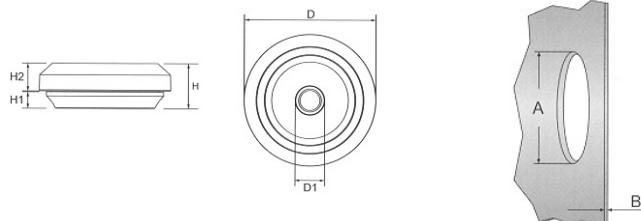

Cable Glands & Adapters



Cable Entry System

Frames



This unique and versatile cable entry system allows for custom designed solutions based on individual applications. Simply put the inserts together, place them in the frame, and install on your panel. Whether you have two large cables, or fifty small cables, or any combination between the two, this flexible frame and insert design can provide what you need.

Fiberglass reinforced Polypropylene is used for the frame and the inserts, ensuring a rigid and reliable structure. The soft TPE insert membrane allows for the ease of a push-out design with exceptional sealing properties.

With this cable entry system you have the freedom to decide where the inserts are placed, and where the different size openings should be in the frame. You will get a sealing solution that is easy to install, that allows for growth, and still maintains an IP65 protection rating.



No tools are needed to install cables once the frame has been mounted. The inserts have push-out membranes that insure a proper seal every time. If additional strain relief is desired, the membranes can be removed and a standard cable gland can be mounted in the resulting hole.

Part Number	Description	View
FL21-FRAME	<p>Large frame for flexible cable entry system</p> <p>Frame will accept a maximum of five 34mm wide inserts. Total insert length not to exceed 170mm.</p> <p>Frame will accept combinations of insert with the part numbers FLI-44-001, FLI-44-002, FLI-42-001, FLI-42-002, & FLI-42-003.</p>	
FL13-FRAME	<p>Small frame for flexible cable entry system</p> <p>Frame will accept a maximum of three 34mm wide inserts. Total insert length not to exceed 102mm.</p> <p>Frame will accept combinations of inserts with the part numbers FLI-42-001, FLI-42-002, FLI-42-0003 & FLI-22-001.</p>	

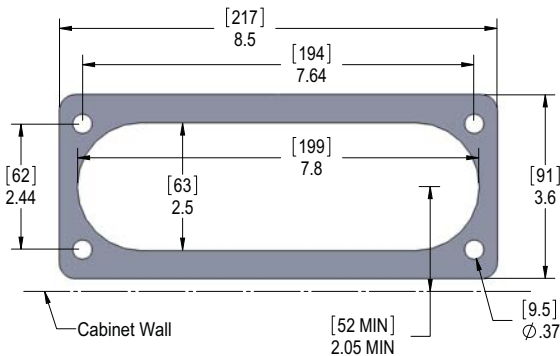

FL21-Frame

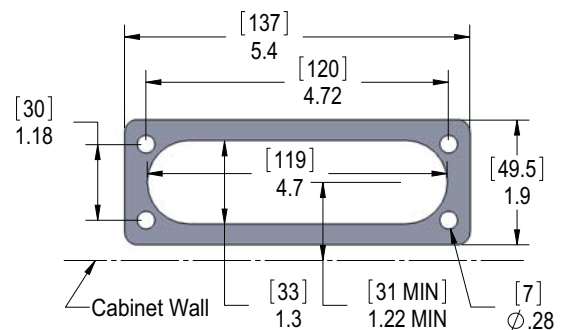

FL13-Frame

Cable Entry System

Inserts



Part Number	Description	View
FLI-44-001	Cable entry system insert, 2xM16 and 2xM25, 68 mm x 68 mm	
FLI-44-002	Cable entry system insert, Knock-out for M32, M40, or M50, 68 mm x 68 mm	
FLI-42-001	Cable entry system insert, 2xM20, 68 mm x 34 mm	
FLI-42-002	Cable entry system insert, 2xM25, 68 mm x 34 mm	
FLI-42-003	Cable entry system insert, 10x4 mm, 68 mm x 34 mm	
FLI-22-001	Cable entry system insert 1xM20, 34 mm x 34 mm	

Specifications:

Material: Fiberglass reinforced Polypropylene and TPE
 UL approved halogen-free material
 Protection: IP65
 Temperature: -20°C.....+125°C

Cable Opening Size	Cable Range
M16	5 - 10 mm
M20	6 - 13 mm
M25	8 - 17 mm
4-10	4 - 10 mm

Cable Glands & Adapters

