



MERCURY DISPLACEMENT INDUSTRIES, INC.

Post Office Box 710 - U.S. 12 East - Edwardsburg, Michigan 49112-0710

Phone (269) 663-8574 - Fax (269) 663-2924

(800) 634-4077



INDUSTRIAL CONTROL EQUIPMENT

L35NO-24AH

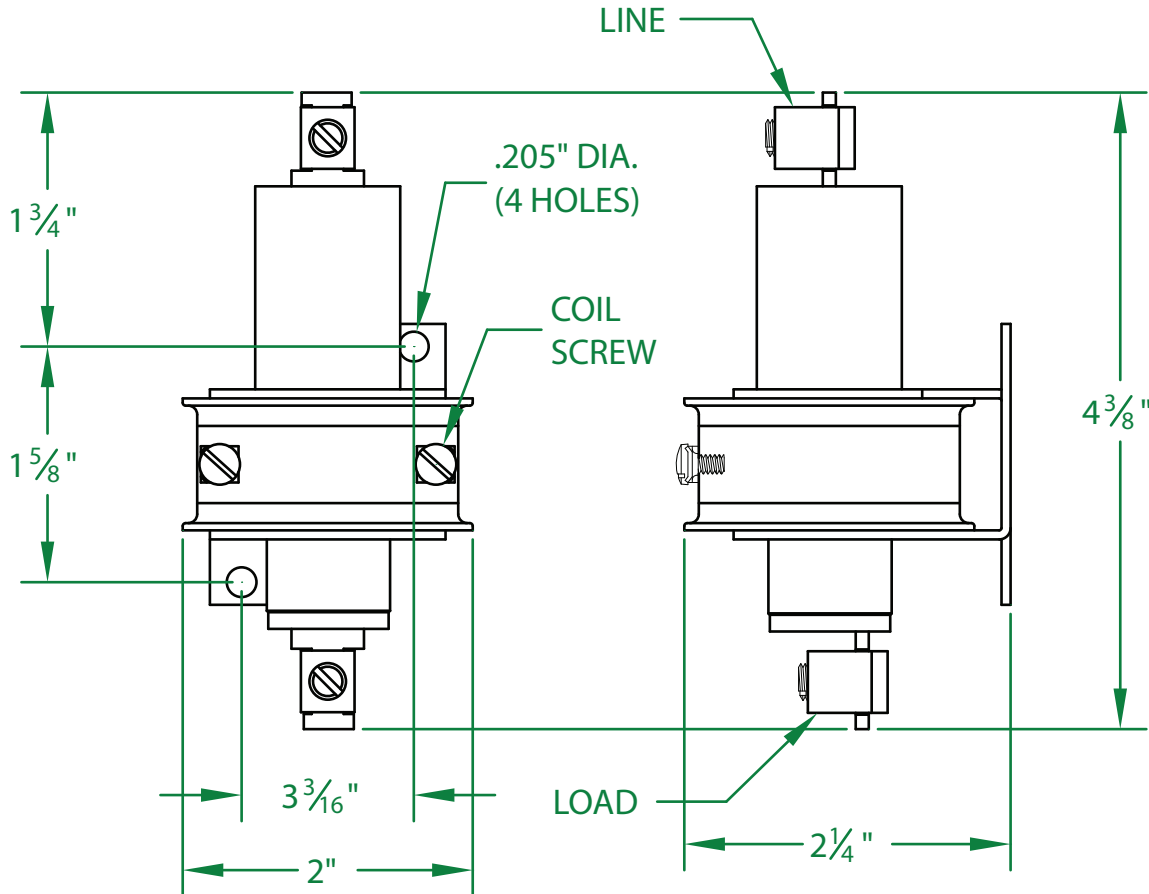

* CONTACT RESISTANCE .003 ohms

* DIELECTRIC WITHSTAND 2,500 VAC RMS

* OPERATE TIME 50 MILLISECONDS

* RELEASE TIME 80 MILLISECONDS

* RATINGS:

CONTACTS: 35 AMP @ 480 VAC
RESISTIVE OR GENERAL PURPOSE

COIL: 24V 50/60 Hz

RESISTANCE: 28 Ω

CURRENT: 325 mA

VA: 7.8 WATTAGE: 3.0

* TEMPERATURE RANGE -35° TO +85° C

* COIL TERMINALS #6 BINDING HEAD SCREWS
TORQUE TO 7 IN-LB

* LOAD TERMINALS 4-14 AWG COMPRESSION TYPE
TORQUE TO 31.5 IN-LB

* SINGLE POLE / SINGLE THROW

* MAGNETICALLY ACTIVATED

* MERCURY CONTACTOR

* LIFE CYCLE ENDURANCE TESTS: U.L. 508 @ 100,00 & CSA 22.2 @ 250,000 CYCLES

Contactors - Relays - Switches

<http://www.mdius.com>