



Figure can vary

Part no.: 50137056

PRK3C.A3/4-M8.3

Polarized retro-reflective photoelectric sensor



Contents

- Technical data
- Reflectors & reflective tapes
- Dimensioned drawings
- Electrical connection
- Diagrams
- Operation and display
- Part number code
- Accessories
- Notes

Technical data

Basic data	
Series	3C
Operating principle	Reflection principle
Special design	
Special design	Autocollimation
Optical data	
Operating range	Guaranteed operating range
Operating range	0 ... 4 m, With reflector TK(S) 100x100
Operating range limit	Typical operating range
Operating range limit	0 ... 5 m, With reflector TK(S) 100x100
Light source	LED, Red
LED light wavelength	635 nm
Transmitted-signal shape	Pulsed
LED protection class	Exempt group (in acc. with EN 62471)
Electrical data	
Protective circuit	Polarity reversal protection Short circuit protected
Performance data	
Supply voltage	10 ... 30 V, DC, Incl. residual ripple
Residual ripple	0 ... 15 %, From U_B
Open-circuit current	0 ... 15 mA
Outputs	
Number of digital switching outputs	1 Piece(s)
Switching outputs	
Voltage type	DC
Switching current, max.	100 mA
Switching voltage	Low: $\leq 2V$ High: $\geq (U_B - 2V)$
Switching output 1	
Assignment	Connection 1, pin 4
Switching element	Transistor, PNP
Switching principle	Light switching
Timing	
Switching frequency	1,500 Hz
Response time	0.33 ms
Readiness delay	300 ms
Response jitter	110 μs
Connection	

Connection 1

Type of connection	Connector
Function	Signal OUT Voltage supply
Thread size	M8
Type	Male
Material	Metal
No. of pins	3 -pin

Mechanical data

Design	Cubic
Dimension (W x H x L)	11.4 mm x 34.2 mm x 18.3 mm
Housing material	Plastic, PC-ABS
Lens cover material	Plastic / PMMA
Net weight	10 g
Housing color	Red
Type of fastening	Via optional mounting device Through-hole mounting
Compatibility of materials	ECOLAB

Operation and display

Type of display	LED
Number of LEDs	2 Piece(s)
Operational controls	Teach button
Function of the operational control	Sensitivity adjustment

Environmental data

Ambient temperature, operation	-40 ... 60 °C
Ambient temperature, storage	-40 ... 70 °C





Certifications

Degree of protection	IP 67 IP 69K
Protection class	III
Certifications	c UL US
Standards applied	IEC 60947-5-2

Classification

eCl@ss 8.0	27270902
eCl@ss 9.0	27270902
ETIM 5.0	EC002717

Reflectors & reflective tapes

	Part no.	Designation	Operating range/ Operating range limit	Description
	50108300	REF 4-A-50x50	0 ... 0.7 m 0 ... 1 m	Design: Rectangular Reflective surface: 50 mm x 50 mm Material: Plastic Chemical designation of the material: PMMA Fastening: Self-adhesive
	50003192	TK 100x100	0 ... 4 m 0 ... 5 m	Design: Rectangular Reflective surface: 96 mm x 96 mm Triple reflector size: 4 mm Material: Plastic Base material: Plastic Chemical designation of the material: PMMA8N Fastening: Adhesive
	50022816	TKS 100X100	0 ... 4 m 0 ... 5 m	Design: Rectangular Reflective surface: 96 mm x 96 mm Triple reflector size: 4 mm Material: Plastic Base material: Plastic Chemical designation of the material: PMMA8N Fastening: Through-hole mounting, Adhesive
	50081283	TKS 20X40	0 ... 1.3 m 0 ... 1.5 m	Design: Rectangular Reflective surface: 16 mm x 38 mm Triple reflector size: 2.3 mm Material: Plastic Base material: Plastic Chemical designation of the material: PMMA8N Fastening: Through-hole mounting, Adhesive
	50040820	TKS 40X60	0 ... 2.6 m 0 ... 3.2 m	Design: Rectangular Reflective surface: 37 mm x 56 mm Triple reflector size: 4 mm Material: Plastic Base material: Plastic Chemical designation of the material: PMMA8N Fastening: Through-hole mounting, Adhesive

Dimensioned drawings

All dimensions in millimeters

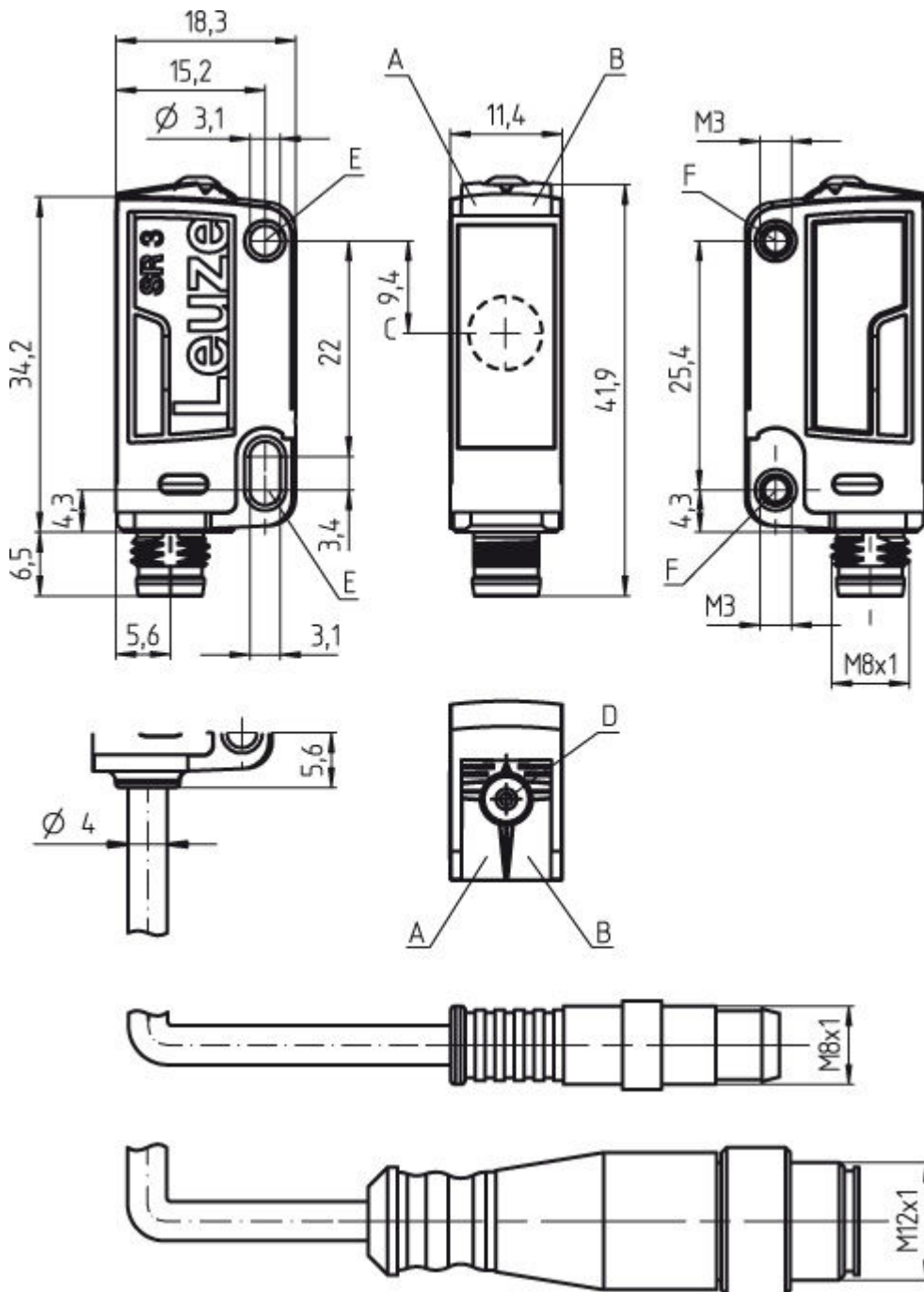

- A Green LED
- B Yellow LED
- C Optical axis
- D Teach button
- E Mounting sleeve (standard)
- F Threaded sleeve (3C.B series)

Electrical connection

Connection 1	
Type of connection	Connector
Function	Signal OUT Voltage supply

Part no.: 50137056 – PRK3C.A3/4-M8.3 – Polarized retro-reflective photoelectric

Connection 1	
Thread size	M8
Type	Male
Material	Metal
No. of pins	3 -pin
Encoding	

Pin	Pin assignment
1	V+
3	GND
4	OUT 1

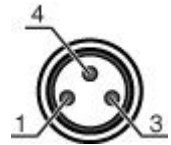

Diagrams

Typ. response behavior

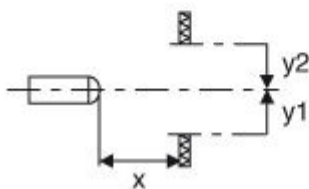
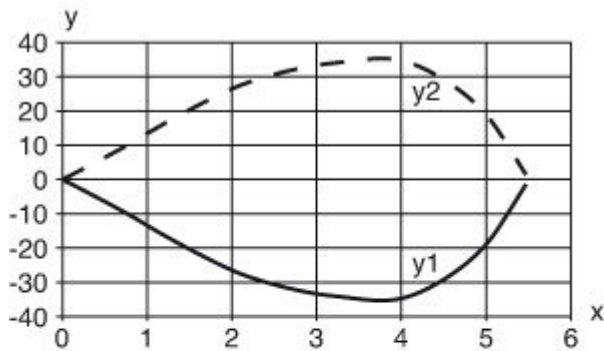

x Distance [m]
y Misalignment [mm]

Typ. function reserve

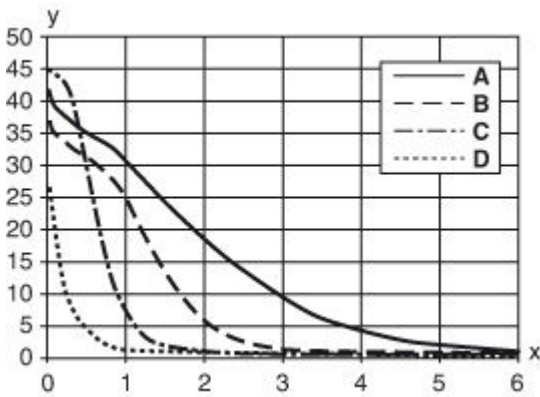

- x Distance [m]
- y Function reserve
- A TKS 100x100
- B TKS 40x60
- C TKS 20x40
- D Film REF 4-A-50x50

Operation and display

LEDs

LED	Display	Meaning
1	Green, continuous light	Ready
2	Yellow, continuous light	Light path free
	Yellow, flashing	Light path free, no function reserve

Part number code



Part designation: **AAA 3C d EE-f.GG H/i J-K-L**

AAA3C	Operating principle / construction: HT3C: diffuse reflection sensor with background suppression LS3C: throughbeam photoelectric sensor transmitter LE3C: throughbeam photoelectric sensor receiver PRK3C: retro-reflective photoelectric sensor with polarization filter
d	Light type: n/a: red light l: infrared light
EE	Light source: n/a: LED L1: laser class 1 L2: laser class 2
f	Pre-set scanning range (optional): n/a: operating range acc. to data sheet XXXX: pre-set scanning range [mm]











GG	Equipment: n/a: standard A: autocollimation principle (single lens) for positioning tasks B: housing model with two M3 threaded sleeves, brass F: permanently set scanning range L: long light spot S: small light spot T: autocollimation principle (single lens) for highly transparent bottles without tracking TT: autocollimation principle (single lens) for highly transparent bottles with tracking V: V-optics XL: extra long light spot
H	Operating range adjustment: n/a with HT: scanning range adjustable via 8-turn potentiometer 1: 270° potentiometer 3: teach-in via button 6: auto-teach
i	Switching output/function OUT 1/IN: Pin 4 or black conductor: 2: NPN transistor output, light switching N: NPN transistor output, dark switching 4: PNP transistor output, light switching P: PNP transistor output, dark switching 6: push-pull switching output, PNP light switching, NPN dark switching G: push-pull switching output, PNP dark switching, NPN light switching L: IO-Link 8: activation input (activation with high signal) X: not connected (n. c.)
J	Switching output / function OUT 2/IN: pin 2 or white conductor: 2: NPN transistor output, light switching N: NPN transistor output, dark switching 4: PNP transistor output, light switching P: PNP transistor output, dark switching 6: push-pull switching output, PNP light switching, NPN dark switching G: push-pull switching output, PNP dark switching, NPN light switching W: warning output X: not connected (n. c.) 8: activation input (activation with high signal) 9: deactivation input (deactivation with high signal) T: teach-in via cable
K	Electrical connection: n/a: cable, PVC, standard length 2000 mm, 4-wire 5000: cable, PVC, standard length 5000 mm, 4-wire M8: M8 connector, 4-pin (plug) M8.3: M8 connector, 3-pin (plug) 200-M8: cable, PVC, length 200 mm with M8 connector, 4-pin, axial (plug) 200-M8.3: cable, PVC, length 200 mm with M8 connector, 3-pin, axial (plug) 200-M12: cable, PVC, length 200 mm with M12 connector, 4-pin, axial (plug)

Accessories



Connection technology - Connection cables

	Part no.	Designation	Article	Description
	50130842	KD U-M8-3A-P1-020	Connection cable	Connection 1: Connector, M8, Axial, Female, 3 -pin Connection 2: Open end Shielded: No Cable length: 2,000 mm Sheathing material: PUR
	50130844	KD U-M8-3A-P1-050	Connection cable	Connection 1: Connector, M8, Axial, Female, 3 -pin Connection 2: Open end Shielded: No Cable length: 5,000 mm Sheathing material: PUR
	50130845	KD U-M8-3A-P1-100	Connection cable	Connection 1: Connector, M8, Axial, Female, 3 -pin Connection 2: Open end Shielded: No Cable length: 10,000 mm Sheathing material: PUR

Part no.: 50137056 – PRK3C.A3/4-M8.3 – Polarized retro-reflective photoelectric

	Part no.	Designation	Article	Description
	50130846	KD U-M8-3A-P1-150	Connection cable	Connection 1: Connector, M8, Axial, Female, 3 -pin Connection 2: Open end Shielded: No Cable length: 15,000 mm Sheathing material: PUR
	50130847	KD U-M8-3A-P1-200	Connection cable	Connection 1: Connector, M8, Axial, Female, 3 -pin Connection 2: Open end Shielded: No Cable length: 20,000 mm Sheathing material: PUR
	50130837	KD U-M8-3A-V1-020	Connection cable	Connection 1: Connector, M8, Axial, Female, 3 -pin Connection 2: Open end Shielded: No Cable length: 2,000 mm Sheathing material: PVC
	50130832	KD U-M8-3A-V1-050	Connection cable	Connection 1: Connector, M8, Axial, Female, 3 -pin Connection 2: Open end Shielded: No Cable length: 5,000 mm Sheathing material: PVC
	50130839	KD U-M8-3A-V1-100	Connection cable	Connection 1: Connector, M8, Axial, Female, 3 -pin Connection 2: Open end Shielded: No Cable length: 10,000 mm Sheathing material: PVC
	50130840	KD U-M8-3A-V1-150	Connection cable	Connection 1: Connector, M8, Axial, Female, 3 -pin Connection 2: Open end Shielded: No Cable length: 15,000 mm Sheathing material: PVC
	50130841	KD U-M8-3A-V1-200	Connection cable	Connection 1: Connector, M8, Axial, Female, 3 -pin Connection 2: Open end Shielded: No Cable length: 20,000 mm Sheathing material: PVC
	50130865	KD U-M8-3W-P1-020	Connection cable	Connection 1: Connector, M8, Angled, Female, 3 -pin Connection 2: Open end Shielded: No Cable length: 2,000 mm Sheathing material: PUR
	50130867	KD U-M8-3W-P1-050	Connection cable	Connection 1: Connector, M8, Angled, Female, 3 -pin Connection 2: Open end Shielded: No Cable length: 5,000 mm Sheathing material: PUR
	50130868	KD U-M8-3W-P1-100	Connection cable	Connection 1: Connector, M8, Angled, Female, 3 -pin Connection 2: Open end Shielded: No Cable length: 10,000 mm Sheathing material: PUR



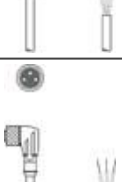
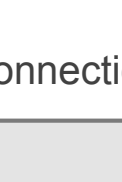



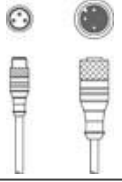
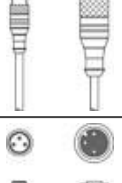
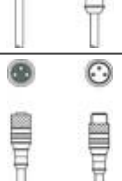
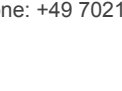



Part no.: 50137056 – PRK3C.A3/4-M8.3 – Polarized retro-reflective photoelectric

	Part no.	Designation	Article	Description
	50130860	KD U-M8-3W-V1-020	Connection cable	Connection 1: Connector, M8, Angled, Female, 3 -pin Connection 2: Open end Shielded: No Cable length: 2,000 mm Sheathing material: PVC
	50130862	KD U-M8-3W-V1-050	Connection cable	Connection 1: Connector, M8, Angled, Female, 3 -pin Connection 2: Open end Shielded: No Cable length: 5,000 mm Sheathing material: PVC
	50130863	KD U-M8-3W-V1-100	Connection cable	Connection 1: Connector, M8, Angled, Female, 3 -pin Connection 2: Open end Shielded: No Cable length: 10,000 mm Sheathing material: PVC
	50130864	KD U-M8-3W-V1-200	Connection cable	Connection 1: Connector, M8, Angled, Female, 3 -pin Connection 2: Open end Shielded: No Cable length: 20,000 mm Sheathing material: PVC

Connection technology - Interconnection cables

	Part no.	Designation	Article	Description
	50130929	KDS U-M8-3A-M12-3A-P1-010	Interconnection cable	Connection 1: Connector, M8, Axial, Female, 3 -pin Connection 2: Connector, M12, Axial, Male, A-coded, 3 -pin Shielded: No Cable length: 1,000 mm Sheathing material: PUR
	50130931	KDS U-M8-3A-M12-3A-P1-020	Interconnection cable	Connection 1: Connector, M8, Axial, Female, 3 -pin Connection 2: Connector, M12, Axial, Male, A-coded, 3 -pin Shielded: No Cable length: 2,000 mm Sheathing material: PUR
	50130932	KDS U-M8-3A-M12-3A-P1-050	Interconnection cable	Connection 1: Connector, M8, Axial, Female, 3 -pin Connection 2: Connector, M12, Axial, Male, A-coded, 3 -pin Shielded: No Cable length: 5,000 mm Sheathing material: PUR
	50130901	KDS U-M8-3A-M8-3A-P1-003	Interconnection cable	Connection 1: Connector, M8, Axial, Female, 3 -pin Connection 2: Connector, M8, Axial, Male, 3 -pin Shielded: No Cable length: 300 mm Sheathing material: PUR
	50130902	KDS U-M8-3A-M8-3A-P1-006	Interconnection cable	Connection 1: Connector, M8, Axial, Female, 3 -pin Connection 2: Connector, M8, Axial, Male, 3 -pin Shielded: No Cable length: 600 mm Sheathing material: PUR





Part no.: 50137056 – PRK3C.A3/4-M8.3 – Polarized retro-reflective photoelectric

	Part no.	Designation	Article	Description
	50130903	KDS U-M8-3A-M8-3A-P1-010	Interconnection cable	Connection 1: Connector, M8, Axial, Female, 3 -pin Connection 2: Connector, M8, Axial, Male, 3 -pin Shielded: No Cable length: 1,000 mm Sheathing material: PUR
	50130905	KDS U-M8-3A-M8-3A-P1-020	Interconnection cable	Connection 1: Connector, M8, Axial, Female, 3 -pin Connection 2: Connector, M8, Axial, Male, 3 -pin Shielded: No Cable length: 2,000 mm Sheathing material: PUR
	50130907	KDS U-M8-3A-M8-3A-P1-050	Interconnection cable	Connection 1: Connector, M8, Axial, Female, 3 -pin Connection 2: Connector, M8, Axial, Male, 3 -pin Shielded: No Cable length: 5,000 mm Sheathing material: PUR
	50130897	KDS U-M8-3A-M8-3A-V1-003	Interconnection cable	Connection 1: Connector, M8, Axial, Female, 3 -pin Connection 2: Connector, M8, Axial, Male, 3 -pin Shielded: No Cable length: 300 mm Sheathing material: PVC
	50130898	KDS U-M8-3A-M8-3A-V1-006	Interconnection cable	Connection 1: Connector, M8, Axial, Female, 3 -pin Connection 2: Connector, M8, Axial, Male, 3 -pin Shielded: No Cable length: 600 mm Sheathing material: PVC
	50130899	KDS U-M8-3A-M8-3A-V1-010	Interconnection cable	Connection 1: Connector, M8, Axial, Female, 3 -pin Connection 2: Connector, M8, Axial, Male, 3 -pin Shielded: No Cable length: 1,000 mm Sheathing material: PVC
	50130900	KDS U-M8-3A-M8-3A-V1-020	Interconnection cable	Connection 1: Connector, M8, Axial, Female, 3 -pin Connection 2: Connector, M8, Axial, Male, 3 -pin Shielded: No Cable length: 2,000 mm Sheathing material: PVC
	50130917	KDS U-M8-3W-M8-3A-P1-003	Interconnection cable	Connection 1: Connector, M8, Angled, Female, 3 -pin Connection 2: Connector, M8, Axial, Male, 3 -pin Shielded: No Cable length: 300 mm Sheathing material: PUR
	50130918	KDS U-M8-3W-M8-3A-P1-006	Interconnection cable	Connection 1: Connector, M8, Angled, Female, 3 -pin Connection 2: Connector, M8, Axial, Male, 3 -pin Shielded: No Cable length: 600 mm Sheathing material: PUR
	50130919	KDS U-M8-3W-M8-3A-P1-010	Interconnection cable	Connection 1: Connector, M8, Angled, Female, 3 -pin Connection 2: Connector, M8, Axial, Male, 3 -pin Shielded: No Cable length: 1,000 mm Sheathing material: PUR



Part no.: 50137056 – PRK3C.A3/4-M8.3 – Polarized retro-reflective photoelectric

	Part no.	Designation	Article	Description
	50130920	KDS U-M8-3W-M8-3A-P1-020	Interconnection cable	Connection 1: Connector, M8, Angled, Female, 3 -pin Connection 2: Connector, M8, Axial, Male, 3 -pin Shielded: No Cable length: 2,000 mm Sheathing material: PUR



Mounting technology - Mounting brackets

	Part no.	Designation	Article	Description
	50118542	BT 200M.5	Mounting bracket	Design of mounting device: Angle, L-shape Mounting bracket, at system: Through-hole mounting Mounting bracket, at device: Screw type Type of mounting device: Adjustable Material: Stainless steel
	50124651	BT 205M	Mounting device set	Contains: 10x Design of mounting device: Angle, L-shape Mounting bracket, at system: Through-hole mounting Mounting bracket, at device: Screw type Type of mounting device: Rigid Material: Metal
	50060511	BT 3	Mounting device	Design of mounting device: Angle, L-shape Mounting bracket, at system: Through-hole mounting Mounting bracket, at device: Screw type Type of mounting device: Rigid Material: Metal
	50105585	BT 3.1	Mounting strap set	Contains: 10x Design of mounting device: Retaining clip Mounting bracket, at system: Through-hole mounting Mounting bracket, at device: Screw type Type of mounting device: Rigid Material: Metal
	50105546	BT 3B	Mounting device	Design of mounting device: Angle, L-shape Mounting bracket, at system: Through-hole mounting Mounting bracket, at device: Screw type Type of mounting device: Rigid Material: Metal





Mounting technology - Rod mounts

	Part no.	Designation	Article	Description
	50117256	BTU 200M-D10	Mounting system	Contains: 2x M3 x 18 screw, 2x position washers Design of mounting device: Mounting system Mounting bracket, at system: For 10 mm rod, Sheet-metal mounting Mounting bracket, at device: Screw type Type of mounting device: Clampable, Adjustable, Turning, 360° Material: Metal
	50117255	BTU 200M-D12	Mounting system	Contains: 2x M3 x 18 screw, 2x position washers Design of mounting device: Mounting system Mounting bracket, at system: For 12 mm rod, Sheet-metal mounting Mounting bracket, at device: Screw type Type of mounting device: Clampable, Adjustable, Turning, 360° Material: Metal

Part no.: 50137056 – PRK3C.A3/4-M8.3 – Polarized retro-reflective photoelectric

	Part no.	Designation	Article	Description
	50117254	BTU 200M-D14	Mounting system	Contains: 2x M3 x 18 screw, 2x position washers Design of mounting device: Mounting system Mounting bracket, at system: For 14 mm rod, Sheet-metal mounting Mounting bracket, at device: Screw type Type of mounting device: Clampable, Adjustable, Turning, 360° Material: Metal
	50120426	BTU 200M.5-D12	Mounting system	Contains: 2x M3 x 18 screw, 2x M3 mounting nut, 2x position washers Design of mounting device: Mounting system Mounting bracket, at system: For 12 mm rod Mounting bracket, at device: Screw type Type of mounting device: Turning, 360°, Clampable, Adjustable Material: Stainless steel

Standard reflectors

	Part no.	Designation	Article	Description
	50134985	MTKS 20x30.1	Reflector	Design: Rectangular Reflective surface: 18.5 mm x 28.5 mm Triple reflector size: 1 mm Material: Plastic Base material: Plastic Chemical designation of the material: PMMA Fastening: Through-hole mounting, Adhesive
	50003192	TK 100x100	Reflector	Design: Rectangular Reflective surface: 96 mm x 96 mm Triple reflector size: 4 mm Material: Plastic Base material: Plastic Chemical designation of the material: PMMA8N Fastening: Adhesive
	50022816	TKS 100X100	Reflector	Design: Rectangular Reflective surface: 96 mm x 96 mm Triple reflector size: 4 mm Material: Plastic Base material: Plastic Chemical designation of the material: PMMA8N Fastening: Through-hole mounting, Adhesive
	50081283	TKS 20X40	Reflector	Design: Rectangular Reflective surface: 16 mm x 38 mm Triple reflector size: 2.3 mm Material: Plastic Base material: Plastic Chemical designation of the material: PMMA8N Fastening: Through-hole mounting, Adhesive
	50040820	TKS 40X60	Reflector	Design: Rectangular Reflective surface: 37 mm x 56 mm Triple reflector size: 4 mm Material: Plastic Base material: Plastic Chemical designation of the material: PMMA8N Fastening: Through-hole mounting, Adhesive

Reflective tapes for standard applications

	Part no.	Designation	Article	Description
	50108300	REF 4-A-50x50	Reflective tape	Design: Rectangular Reflective surface: 50 mm x 50 mm Material: Plastic Chemical designation of the material: PMMA Fastening: Self-adhesive

Notes

Observe intended use!

- This product is not a safety sensor and is not intended as personnel protection.
- The product may only be put into operation by competent persons.
- Only use the product in accordance with its intended use.

For UL applications:

- For UL applications, use is only permitted in Class 2 circuits in accordance with the NEC (National Electric Code).
- These proximity switches shall be used with UL Listed Cable assemblies rated 30V, 0.5A min, in the field installation, or equivalent (categories: CYJV/CYJV7 or PVVA/PVVA7)

- Light source: Average life expectancy 100,000 h at an ambient temperature of 25 °C
- Response time: For short decay times, an ohmic load of approx. 5 kOhm is recommended
- Sum of the output currents for both outputs, 50 mA for ambient temperatures > 40 °C