



Figure can vary

Part no.: 50129398
HT3CL2/4P-200-M8
Diffuse sensor with background suppression



Contents

- Technical data
- Dimensioned drawings
- Electrical connection
- Diagrams
- Operation and display
- Part number code
- Accessories
- Notes

Technical data

Basic data	
Series	3C
Operating principle	Scanning principle with background suppression
Optical data	
Black-white error	< 10% up to 250 mm
Operating range	Guaranteed operating range
Operating range, white 90%	0.015 ... 0.55 m
Operating range, gray 18%	0.015 ... 0.44 m
Operating range, black 6%	0.015 ... 0.25 m
Operating range limit	Typical operating range
Operating range limit	0.015 ... 0.55 m
Adjustment range	20 ... 550 mm
Beam profile	Collimated
Light source	Laser, Red
Laser light wavelength	650 nm
Laser class	2, IEC/EN 60825-1:2007
Max. laser power	0.0045 W
Transmitted-signal shape	Pulsed
Pulse duration	5.1 μ s
Light-spot size [at sensor distance]	1 mm [550 mm]
Type of light-spot geometry	Round
Shift angle	Typ. \pm 2°
Electrical data	
Protective circuit	Short circuit protected Polarity reversal protection Overvoltage protection
Performance data	
Supply voltage	10 ... 30 V, DC, Incl. residual ripple
Residual ripple	0 ... 10 %, From U_B
Open-circuit current	0 ... 20 mA
Outputs	
Number of digital switching outputs	2 Piece(s)
Switching outputs	
Voltage type	DC
Switching current, max.	100 mA
Switching voltage	High: $\geq(U_B-2V)$ Low: $\leq 2V$
Switching output 1	
Assignment	Connection 1, pin 4
Switching element	Transistor, PNP
Switching principle	Light switching
Switching output 2	
Assignment	Connection 1, pin 2
Switching element	Transistor, PNP
Switching principle	Dark switching
Timing	

Part no.: 50129398 – HT3CL2/4P-200-M8 – Diffuse sensor with background

Switching frequency	3,000 Hz
Response time	0.16 ms
Decay time	0.16 ms
Readiness delay	300 ms
Response jitter	55 µs

Connection
Connection 1

Type of connection	Cable with connector
Function	Signal OUT Voltage supply
Cable length	200 mm
Sheathing material	PUR
Cable color	Black
Wire cross section	0.2 mm ²
Thread size	M8
Type	Male
Material	Metal
No. of pins	4 -pin

Mechanical data

Design	Cubic
Dimension (W x H x L)	11.4 mm x 34.2 mm x 18.3 mm
Housing material	Plastic, PC-ABS
Lens cover material	Plastic / PMMA
Net weight	20 g
Housing color	Red
Type of fastening	Via optional mounting device Through-hole mounting
Compatibility of materials	ECOLAB

Operation and display

Type of display	LED
Number of LEDs	2 Piece(s)
Operational controls	Multiturn potentiometer
Function of the operational control	Scanning range adjustment

Environmental data

Ambient temperature, operation	-40 ... 55 °C
Ambient temperature, storage	-40 ... 70 °C

Certifications

Degree of protection	IP 69K IP 67
Protection class	III
Certifications	c UL US
Standards applied	IEC 60947-5-2

Classification

eCl@ss 8.0	27270904
------------	----------

Dimensioned drawings

All dimensions in millimeters

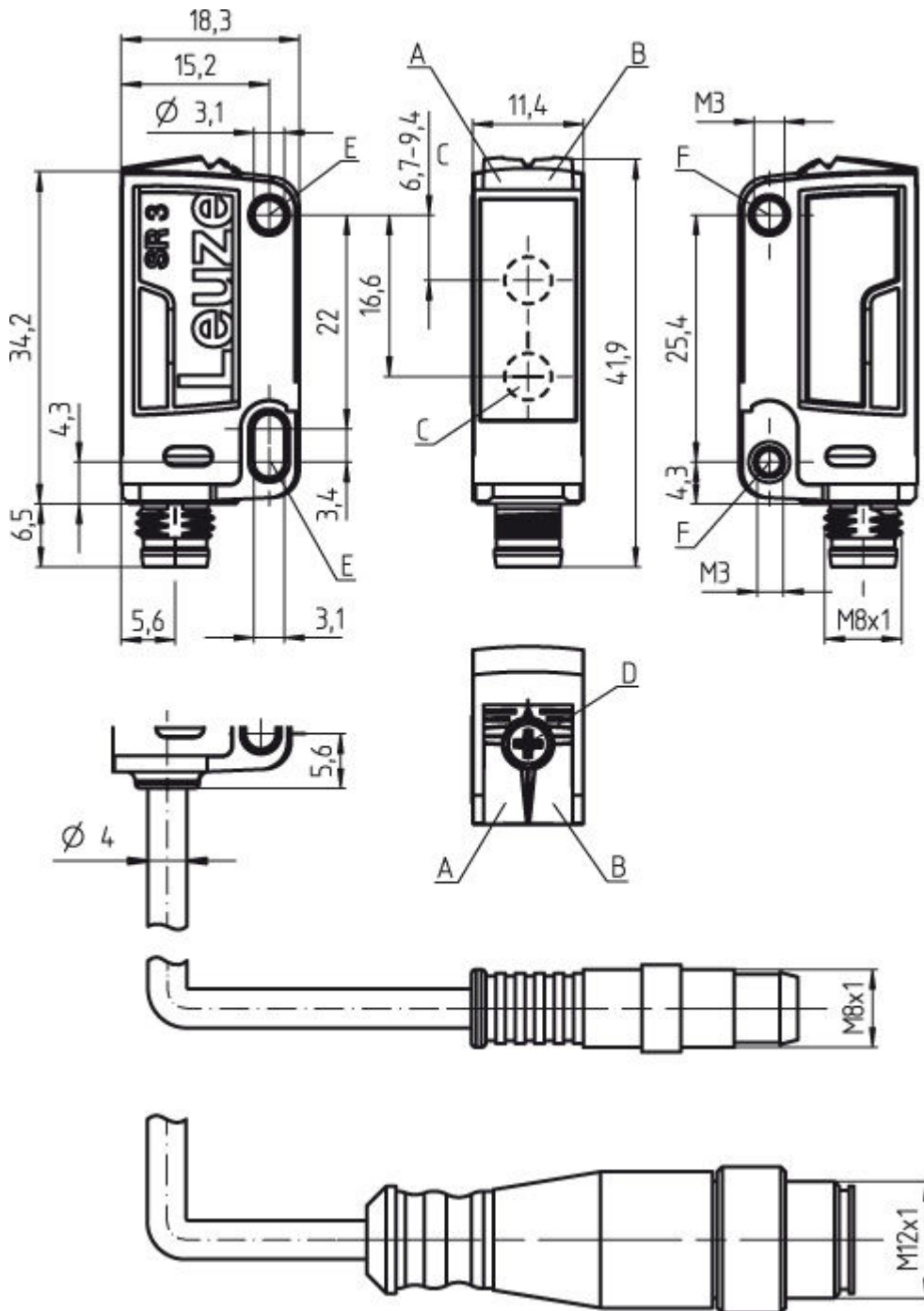

- A Green LED
- B Yellow LED
- C Optical axis
- D Multiturn potentiometer
- E Mounting sleeve (standard)

F Threaded sleeve (3C.B series)

Electrical connection

Connection 1	
Type of connection	Cable with connector
Function	Signal OUT Voltage supply
Cable length	200 mm
Sheathing material	PUR
Cable color	Black
Wire cross section	0.2 mm ²
Thread size	M8
Type	Male
Material	Metal
No. of pins	4 -pin
Encoding	

Pin	Pin assignment
1	V+
2	OUT 2
3	GND
4	OUT 1

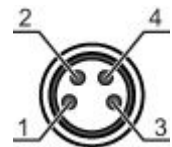

Diagrams

Typ. black/white behavior

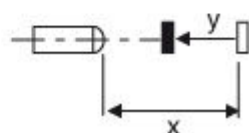
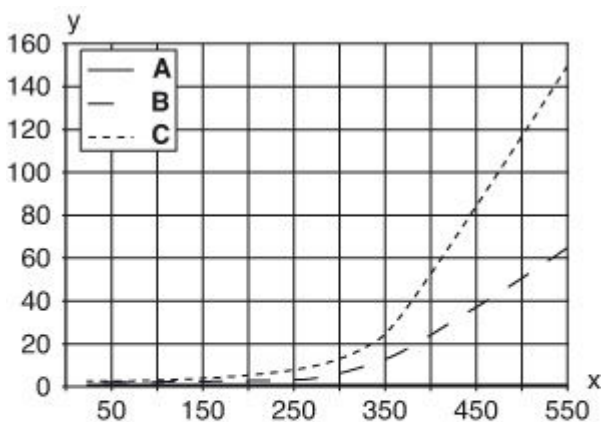

x Distance [mm]
y Reduction of range [mm]
A White 90%

B Gray 18%
C Black 6%

Operation and display

LEDs

LED	Display	Meaning
1	Green, continuous light	Operational readiness
2	Yellow, continuous light	Object detected

Part number code







Part designation: AAA 3C d EE-f.GG H/i J-K-L

AAA3C	Operating principle / construction: HT3C: diffuse reflection sensor with background suppression LS3C: throughbeam photoelectric sensor transmitter LE3C: throughbeam photoelectric sensor receiver PRK3C: retro-reflective photoelectric sensor with polarization filter
d	Light type: n/a: red light l: infrared light
EE	Light source: n/a: LED L1: laser class 1 L2: laser class 2
f	Pre-set scanning range (optional): n/a: operating range acc. to data sheet XXXX: pre-set scanning range [mm]
GG	Equipment: n/a: standard A: autocollimation principle (single lens) for positioning tasks B: housing model with two M3 threaded sleeves, brass F: permanently set scanning range L: long light spot S: small light spot T: autocollimation principle (single lens) for highly transparent bottles without tracking TT: autocollimation principle (single lens) for highly transparent bottles with tracking V: V-optics XL: extra long light spot
H	Operating range adjustment: n/a with HT: scanning range adjustable via 8-turn potentiometer 1: 270° potentiometer 3: teach-in via button 6: auto-teach
i	Switching output/function OUT 1/IN: Pin 4 or black conductor: 2: NPN transistor output, light switching N: NPN transistor output, dark switching 4: PNP transistor output, light switching P: PNP transistor output, dark switching 6: push-pull switching output, PNP light switching, NPN dark switching G: push-pull switching output, PNP dark switching, NPN light switching L: IO-Link 8: activation input (activation with high signal) X: not connected (n. c.)
J	Switching output / function OUT 2/IN: pin 2 or white conductor: 2: NPN transistor output, light switching N: NPN transistor output, dark switching 4: PNP transistor output, light switching P: PNP transistor output, dark switching 6: push-pull switching output, PNP light switching, NPN dark switching G: push-pull switching output, PNP dark switching, NPN light switching W: warning output X: not connected (n. c.) 8: activation input (activation with high signal) 9: deactivation input (deactivation with high signal) T: teach-in via cable









K	Electrical connection: n/a: cable, PVC, standard length 2000 mm, 4-wire 5000: cable, PVC, standard length 5000 mm, 4-wire M8: M8 connector, 4-pin (plug) M8.3: M8 connector, 3-pin (plug) 200-M8: cable, PVC, length 200 mm with M8 connector, 4-pin, axial (plug) 200-M8.3: cable, PVC, length 200 mm with M8 connector, 3-pin, axial (plug) 200-M12: cable, PVC, length 200 mm with M12 connector, 4-pin, axial (plug)
---	--

Accessories

Connection technology - Connection cables

	Part no.	Designation	Article	Description
	50106152	K-D M8A-4P-2m-FAB	Connection cable	Connection 1: Connector, M8, Axial, Female, 4 -pin Connection 2: Open end Shielded: No Cable length: 2,000 mm Sheathing material: FAB
	50106153	K-D M8A-4P-5m-FAB	Connection cable	Connection 1: Connector, M8, Axial, Female, 4 -pin Connection 2: Open end Shielded: No Cable length: 5,000 mm Sheathing material: FAB
	50106154	K-D M8W-4P-2m-FAB	Connection cable	Connection 1: Connector, M8, Angled, Female, 4 -pin Connection 2: Open end Shielded: No Cable length: 2,000 mm Sheathing material: FAB
	50106155	K-D M8W-4P-5m-FAB	Connection cable	Connection 1: Connector, M8, Angled, Female, 4 -pin Connection 2: Open end Shielded: No Cable length: 5,000 mm Sheathing material: FAB
	50130854	KD U-M8-4A-P1-020	Connection cable	Connection 1: Connector, M8, Axial, Female, 4 -pin Connection 2: Open end Shielded: No Cable length: 2,000 mm Sheathing material: PUR
	50130856	KD U-M8-4A-P1-050	Connection cable	Connection 1: Connector, M8, Axial, Female, 4 -pin Connection 2: Open end Shielded: No Cable length: 5,000 mm Sheathing material: PUR
	50130857	KD U-M8-4A-P1-100	Connection cable	Connection 1: Connector, M8, Axial, Female, 4 -pin Connection 2: Open end Shielded: No Cable length: 10,000 mm Sheathing material: PUR

Part no.: 50129398 – HT3CL2/4P-200-M8 – Diffuse sensor with background





	Part no.	Designation	Article	Description
	50130848	KD U-M8-4A-V1-020	Connection cable	Connection 1: Connector, M8, Axial, Female, 4 -pin Connection 2: Open end Shielded: No Cable length: 2,000 mm Sheathing material: PVC
	50130850	KD U-M8-4A-V1-050	Connection cable	Connection 1: Connector, M8, Axial, Female, 4 -pin Connection 2: Open end Shielded: No Cable length: 5,000 mm Sheathing material: PVC
	50130851	KD U-M8-4A-V1-100	Connection cable	Connection 1: Connector, M8, Axial, Female, 4 -pin Connection 2: Open end Shielded: No Cable length: 10,000 mm Sheathing material: PVC
	50130873	KD U-M8-4W-P1-020	Connection cable	Connection 1: Connector, M8, Angled, Female, 4 -pin Connection 2: Open end Shielded: No Cable length: 2,000 mm Sheathing material: PUR
	50130875	KD U-M8-4W-P1-050	Connection cable	Connection 1: Connector, M8, Angled, Female, 4 -pin Connection 2: Open end Shielded: No Cable length: 5,000 mm Sheathing material: PUR
	50130876	KD U-M8-4W-P1-100	Connection cable	Connection 1: Connector, M8, Angled, Female, 4 -pin Connection 2: Open end Shielded: No Cable length: 10,000 mm Sheathing material: PUR
	50130869	KD U-M8-4W-V1-020	Connection cable	Connection 1: Connector, M8, Angled, Female, 4 -pin Connection 2: Open end Shielded: No Cable length: 2,000 mm Sheathing material: PVC
	50130871	KD U-M8-4W-V1-050	Connection cable	Connection 1: Connector, M8, Angled, Female, 4 -pin Connection 2: Open end Shielded: No Cable length: 5,000 mm Sheathing material: PVC
	50130872	KD U-M8-4W-V1-100	Connection cable	Connection 1: Connector, M8, Angled, Female, 4 -pin Connection 2: Open end Shielded: No Cable length: 10,000 mm Sheathing material: PVC

Part no.: 50129398 – HT3CL2/4P-200-M8 – Diffuse sensor with background



Connection technology - Interconnection cables

	Part no.	Designation	Article	Description
	50130916	KDS U-M8-4A-M8-4A-P1-020	Interconnection cable	Connection 1: Connector, M8, Axial, Female, 4 -pin Connection 2: Connector, M8, Axial, Male, 4 -pin Shielded: No Cable length: 2,000 mm Sheathing material: PUR



Mounting technology - Mounting brackets

	Part no.	Designation	Article	Description
	50118542	BT 200M.5	Mounting bracket	Design of mounting device: Angle, L-shape Mounting bracket, at system: Through-hole mounting Mounting bracket, at device: Screw type Type of mounting device: Adjustable Material: Stainless steel
	50124651	BT 205M	Mounting device set	Contains: 10x Design of mounting device: Angle, L-shape Mounting bracket, at system: Through-hole mounting Mounting bracket, at device: Screw type Type of mounting device: Rigid Material: Metal
	50060511	BT 3	Mounting device	Design of mounting device: Angle, L-shape Mounting bracket, at system: Through-hole mounting Mounting bracket, at device: Screw type Type of mounting device: Rigid Material: Metal
	50105585	BT 3.1	Mounting strap set	Contains: 10x Design of mounting device: Retaining clip Mounting bracket, at system: Through-hole mounting Mounting bracket, at device: Screw type Type of mounting device: Rigid Material: Metal
	50105546	BT 3B	Mounting device	Design of mounting device: Angle, L-shape Mounting bracket, at system: Through-hole mounting Mounting bracket, at device: Screw type Type of mounting device: Rigid Material: Metal

Mounting technology - Rod mounts

	Part no.	Designation	Article	Description
	50117256	BTU 200M-D10	Mounting system	Contains: 2x M3 x 18 screw, 2x position washers Design of mounting device: Mounting system Mounting bracket, at system: For 10 mm rod, Sheet-metal mounting Mounting bracket, at device: Screw type Type of mounting device: Clampable, Adjustable, Turning, 360° Material: Metal
	50117255	BTU 200M-D12	Mounting system	Contains: 2x M3 x 18 screw, 2x position washers Design of mounting device: Mounting system Mounting bracket, at system: For 12 mm rod, Sheet-metal mounting Mounting bracket, at device: Screw type Type of mounting device: Clampable, Adjustable, Turning, 360° Material: Metal

Part no.: 50129398 – HT3CL2/4P-200-M8 – Diffuse sensor with background

	Part no.	Designation	Article	Description
	50117254	BTU 200M-D14	Mounting system	Contains: 2x M3 x 18 screw, 2x position washers Design of mounting device: Mounting system Mounting bracket, at system: For 14 mm rod, Sheet-metal mounting Mounting bracket, at device: Screw type Type of mounting device: Clampable, Adjustable, Turning, 360° Material: Metal
	50120426	BTU 200M.5-D12	Mounting system	Contains: 2x M3 x 18 screw, 2x M3 mounting nut, 2x position washers Design of mounting device: Mounting system Mounting bracket, at system: For 12 mm rod Mounting bracket, at device: Screw type Type of mounting device: Turning, 360°, Clampable, Adjustable Material: Stainless steel

Notes

Observe intended use!

- This product is not a safety sensor and is not intended as personnel protection.
- The product may only be put into operation by competent persons.
- Only use the product in accordance with its intended use.

For UL applications:

- For UL applications, use is only permitted in Class 2 circuits in accordance with the NEC (National Electric Code).
- These proximity switches shall be used with UL Listed Cable assemblies rated 30V, 0.5A min, in the field installation, or equivalent (categories: CYJV/CYJV7 or PVVA/PVVA7)

WARNING! LASER RADIATION – LASER CLASS 2
Never look directly into the beam!

The device satisfies the requirements of IEC 60825-1:2007 (EN 60825-1:2007) safety regulations for a product of **laser class 2** as well as the U.S. 21 CFR 1040.10 regulations with deviations corresponding to "Laser Notice No. 50" from June 24, 2007.

- Never look directly into the laser beam or in the direction of reflected laser beams! If you look into the beam path over a longer time period, there is a risk of injury to the retina.
- Do not point the laser beam of the device at persons!
- Interrupt the laser beam using a non-transparent, non-reflective object if the laser beam is accidentally directed towards a person.
- When mounting and aligning the device, avoid reflections of the laser beam off reflective surfaces!
- CAUTION! Use of controls or adjustments or performance of procedures other than specified herein may result in hazardous light exposure.
- Observe the applicable statutory and local laser protection regulations.
- The device must not be tampered with and must not be changed in any way.
There are no user-serviceable parts inside the device.
Repairs must only be performed by Leuze electronic GmbH + Co. KG.

NOTE**Affix laser information and warning signs!**

Laser information and warning signs are affixed to the device. In addition, self-adhesive laser information and warning signs (stick-on labels) are supplied in several languages.

- Affix the laser information sheet to the device in the language appropriate for the place of use. When using the device in the US, use the stick-on label with the "Complies with 21 CFR 1040.10" note.
- Affix the laser information and warning signs near the device if no signs are attached to the device (e.g. because the device is too small) or if the attached laser information and warning signs are concealed due to the installation position.
- Affix the laser information and warning signs so that they are legible without exposing the reader to the laser radiation of the device or other optical radiation.

- Light source: Average life expectancy 50,000 h at an ambient temperature of 25 °C
- Response time: For short decay times, an ohmic load of approx. 5 kOhm is recommended
- Sum of the output currents for both outputs, 50 mA for ambient temperatures > 40 °C