



**Part no.: 50116346**  
**BCL 304i SF 100**  
**Stationary bar code reader**



Figure can vary

## Contents

- Technical data
- Dimensioned drawings
- Electrical connection
- Diagrams
- Operation and display
- Part number code
- Accessories
- Notes

## Technical data

<b>Basic data</b>	
Series	BCL 300i
<b>Functions</b>	
Functions	AutoRefIAct Alignment mode Reference code comparison Code fragment technology AutoControl LED indicator AutoConfig
<b>Characteristic parameters</b>	
MTTF	110 years
<b>Read data</b>	
Code types, readable	2/5 Interleaved UPC Code 128 Code 93 GS1 Databar Omnidirectional GS1 Databar Expanded EAN 8/13 GS1 Databar Limited Codabar Code 39
Scanning rate, typical	1,000 scans/s
Bar codes per reading gate, max. number	64 Piece(s)
<b>Optical data</b>	
Reading distance	70 ... 445 mm
Light source	Laser, Red
Laser light wavelength	655 nm
Laser class	2, IEC/EN 60825-1:2007
Transmitted-signal shape	Continuous
Usable opening angle (reading field opening)	60 °
Module size	0.3 ... 0.5 mm
Reading method	Line scanner with deflecting mirror
Beam deflection	By means of rotating polygon mirror wheel + deflecting mirror
Light beam exit	Lateral with deflecting mirror
<b>Electrical data</b>	
Protective circuit	Polarity reversal protection
<b>Performance data</b>	
Supply voltage	18 ... 30 V, DC
Power consumption, max.	4.5 W
<b>Inputs/outputs selectable</b>	
Output current, max.	60 mA
Number of inputs/outputs selectable	2 Piece(s)
Input current, max.	8 mA
<b>Interface</b>	
Type	PROFIBUS DP

**Part no.: 50116346 – BCL 304i SF 100 – Stationary bar code reader**
**PROFIBUS DP**

Function	Process
Classification	V1
Transmission speed	0.0096 ... 12 Mbit/s

**Service interface**

Type	USB
------	-----

**USB**

Function	Service
----------	---------

**Connection**

Number of connections	1 Piece(s)
-----------------------	------------

**Connection 1**

Type of connection	Plug connector
Function	BUS IN BUS OUT Data interface Service interface Connection to device PWR / SW IN/OUT
No. of pins	32 -pin
Type	Male

**Mechanical data**

Design	Cubic
Dimension (W x H x L)	103 mm x 44 mm x 96 mm
Housing material	Metal, Diecast aluminum
Lens cover material	Glass
Net weight	350 g
Housing color	Red Black
Type of fastening	Via optional mounting device Dovetail grooves Fastening on back

**Operation and display**

Type of display	LED
Number of LEDs	2 Piece(s)
Type of configuration	Via web browser

**Environmental data**

Ambient temperature, operation	0 ... 40 °C
Ambient temperature, storage	-20 ... 70 °C
Relative humidity (non-condensing)	0 ... 90 %

**Certifications**

Degree of protection	IP 65
Protection class	III
Certifications	c UL US
Test procedure for EMC in accordance with standard	EN 61000-4-2, 3, -4, -6 EN 55022
Test procedure for shock in accordance with standard	IEC 60068-2-27, test Ea

Part no.: 50116346 – BCL 304i SF 100 – Stationary bar code reader

Test procedure for continuous shock in accordance with standard	IEC 60068-2-29, test Eb
Test procedure for vibration in accordance with standard	IEC 60068-2-6, test Fc

#### **Classification**

eCl@ss 8.0	27280102
eCl@ss 9.0	27280102
ETIM 5.0	EC002550

## **Dimensioned drawings**

All dimensions in millimeters

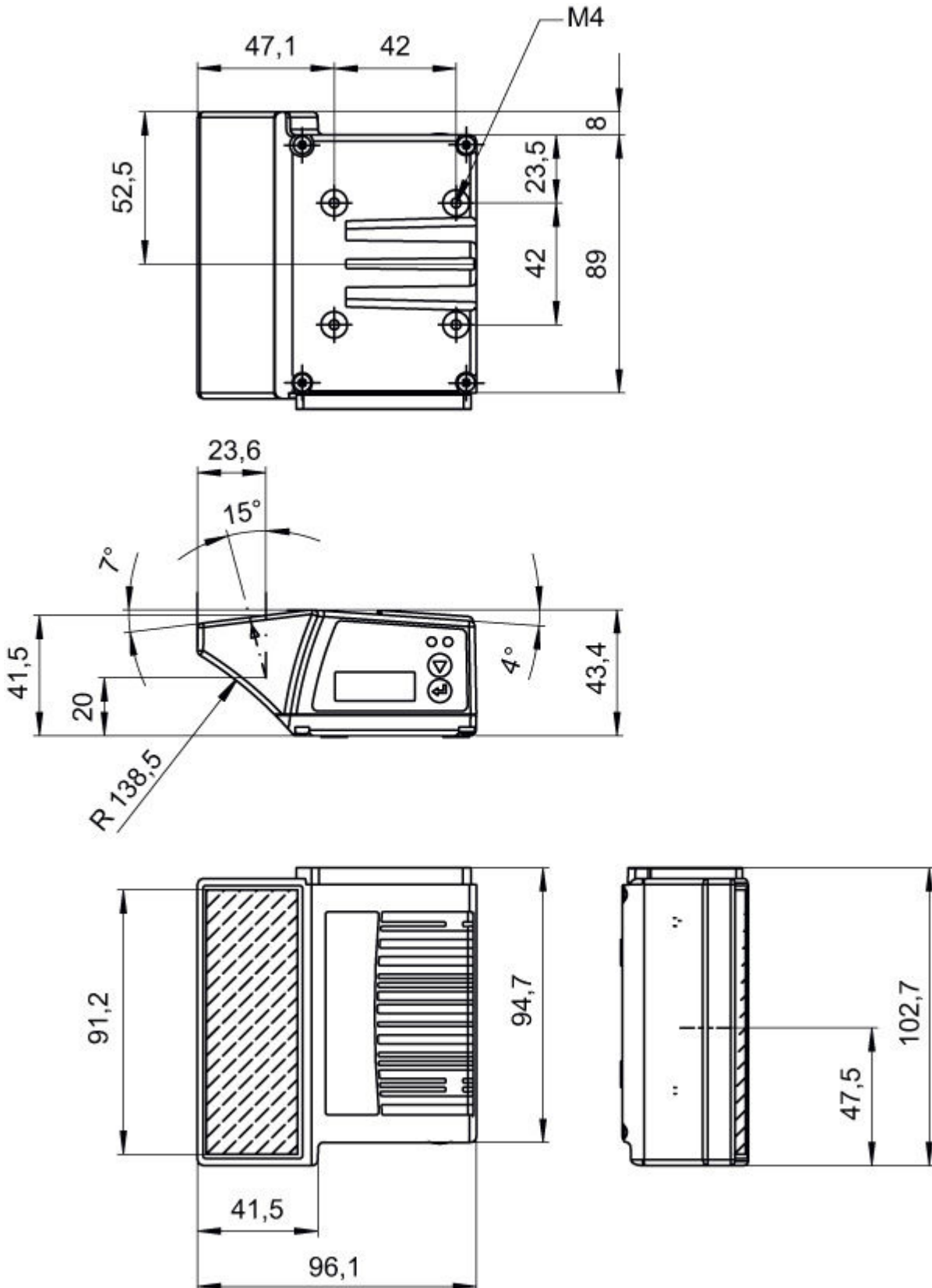

## Electrical connection

Connection 1	
Type of connection	Plug connector
Function	BUS IN BUS OUT Data interface Service interface Connection to device PWR / SW IN/OUT
No. of pins	32 -pin
Type	Male

## Diagrams

### Reading field curve

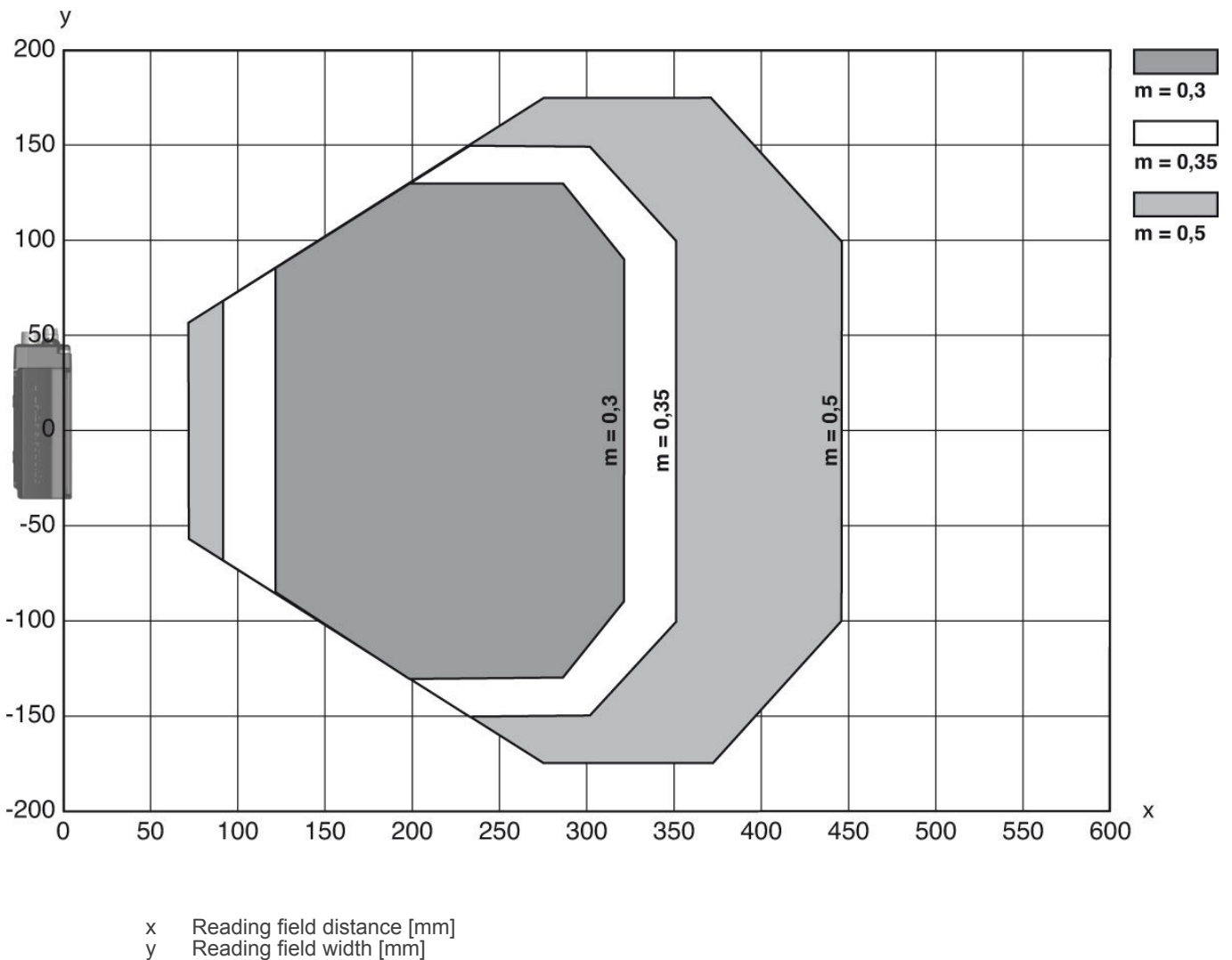

## Operation and display

### LEDs

LED	Display	Meaning	
1	PWR	Green, flashing	Device ok, initialization phase
		Green, continuous light	Device OK
		Green, briefly off - on	Reading successful
		green, briefly off - briefly red - on	Reading not successful
		Orange, continuous light	Service mode
		Red, flashing	Device OK, warning set
		Red, continuous light	Error, device error
2	BUS	Green, flashing	Initialization
		Green, continuous light	Bus operation ok
		Red, flashing	Communication error
		Red, continuous light	Bus error

## Part number code

Part designation: **BCL XXXX YYZ AAA BB**









BCL	<b>Operating principle:</b> BCL: bar code reader
XXXX	<b>Series/interface (integrated fieldbus technology)::</b> 300i: RS 232 / RS 422 (stand-alone) 301i: RS 485 (multiNet slave) 304i: PROFIBUS DP 308i: EtherNet TCP/IP, UDP 348i: PROFINET RT 358i: EtherNet/IP
YY	<b>Scanning principle:</b> S: line scanner (single line) R1: line scanner (raster) O: oscillating-mirror scanner (oscillating mirror)
Z	<b>Optics:</b> N: High Density (close) M: Medium Density (medium distance) F: Low Density (remote) L: Long Range (very large distances) J: ink-jet (depending on the application)
AAA	<b>Beam exit:</b> 100: lateral 102: front
BB	<b>Special equipment:</b> D: with display H: with heating DH: optionally with display and heating

## Accessories

### Connection technology - Connection cables

	Part no.	Designation	Article	Description
	50135243	KD PB-M12-4A-P3-050	Connection cable	Suitable for interface: PROFIBUS DP Connection 1: Connector, M12, Axial, Female, B-coded, 4 - pin Connection 2: Open end Shielded: Yes Cable length: 5,000 mm Sheathing material: PUR

**Part no.: 50116346 – BCL 304i SF 100 – Stationary bar code reader**

	Part no.	Designation	Article	Description
	50135244	KD PB-M12-4A-P3-100	Connection cable	Suitable for interface: PROFIBUS DP Connection 1: Connector, M12, Axial, Female, B-coded, 4 -pin Connection 2: Open end Shielded: Yes Cable length: 10,000 mm Sheathing material: PUR
	50135245	KD PB-M12-4A-P3-150	Connection cable	Suitable for interface: PROFIBUS DP Connection 1: Connector, M12, Axial, Female, B-coded, 4 -pin Connection 2: Open end Shielded: Yes Cable length: 15,000 mm Sheathing material: PUR
	50135246	KD PB-M12-4A-P3-300	Connection cable	Suitable for interface: PROFIBUS DP Connection 1: Connector, M12, Axial, Female, B-coded, 4 -pin Connection 2: Open end Shielded: Yes Cable length: 30,000 mm Sheathing material: PUR
	50132077	KD U-M12-5A-V1-020	Connection cable	Connection 1: Connector, M12, Axial, Female, A-coded, 5 -pin Connection 2: Open end Shielded: No Cable length: 2,000 mm Sheathing material: PVC
	50132079	KD U-M12-5A-V1-050	Connection cable	Connection 1: Connector, M12, Axial, Female, A-coded, 5 -pin Connection 2: Open end Shielded: No Cable length: 5,000 mm Sheathing material: PVC
	50132080	KD U-M12-5A-V1-100	Connection cable	Connection 1: Connector, M12, Axial, Female, A-coded, 5 -pin Connection 2: Open end Shielded: No Cable length: 10,000 mm Sheathing material: PVC
	50132432	KD U-M12-5A-V1-300	Connection cable	Connection 1: Connector, M12, Axial, Female, A-coded, 5 -pin Connection 2: Open end Shielded: No Cable length: 30,000 mm Sheathing material: PVC
	50135247	KS PB-M12-4A-P3-020	Connection cable	Suitable for interface: PROFIBUS DP Connection 1: Connector, M12, Axial, Male, B-coded, 4 -pin Connection 2: Open end Shielded: Yes Cable length: 2,000 mm Sheathing material: PUR
	50135248	KS PB-M12-4A-P3-050	Connection cable	Suitable for interface: PROFIBUS DP Connection 1: Connector, M12, Axial, Male, B-coded, 4 -pin Connection 2: Open end Shielded: Yes Cable length: 5,000 mm Sheathing material: PUR
	50135249	KS PB-M12-4A-P3-100	Connection cable	Suitable for interface: PROFIBUS DP Connection 1: Connector, M12, Axial, Male, B-coded, 4 -pin Connection 2: Open end Shielded: Yes Cable length: 10,000 mm Sheathing material: PUR

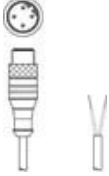
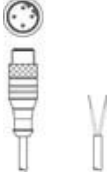

**Part no.: 50116346 – BCL 304i SF 100 – Stationary bar code reader**

	Part no.	Designation	Article	Description
	50135250	KS PB-M12-4A-P3-150	Connection cable	Suitable for interface: PROFIBUS DP Connection 1: Connector, M12, Axial, Male, B-coded, 4 -pin Connection 2: Open end Shielded: Yes Cable length: 15,000 mm Sheathing material: PUR
	50135251	KS PB-M12-4A-P3-300	Connection cable	Suitable for interface: PROFIBUS DP Connection 1: Connector, M12, Axial, Male, B-coded, 4 -pin Connection 2: Open end Shielded: Yes Cable length: 30,000 mm Sheathing material: PUR

**Connection technology - Interconnection cables**



	Part no.	Designation	Article	Description
	50117011	KB USB A - USB miniB	Service line	Suitable for interface: USB Connection 1: USB Connection 2: USB Shielded: Yes Cable length: 1,500 mm Sheathing material: PVC
	50135252	KDS PB-M12-4A-M12-4A-P3-010	Interconnection cable	Suitable for interface: PROFIBUS DP Connection 1: Connector, M12, Axial, Female, B-coded, 2 -pin Connection 2: Connector, M12, Axial, Male, B-coded, 4 -pin Shielded: Yes Cable length: 1,000 mm Sheathing material: PUR
	50135253	KDS PB-M12-4A-M12-4A-P3-020	Interconnection cable	Suitable for interface: PROFIBUS DP Connection 1: Connector, M12, Axial, Female, B-coded, 2 -pin Connection 2: Connector, M12, Axial, Male, B-coded, 4 -pin Shielded: Yes Cable length: 2,000 mm Sheathing material: PUR
	50135254	KDS PB-M12-4A-M12-4A-P3-050	Interconnection cable	Suitable for interface: PROFIBUS DP Connection 1: Connector, M12, Axial, Female, B-coded, 2 -pin Connection 2: Connector, M12, Axial, Male, B-coded, 4 -pin Shielded: Yes Cable length: 5,000 mm Sheathing material: PUR
	50135255	KDS PB-M12-4A-M12-4A-P3-100	Interconnection cable	Suitable for interface: PROFIBUS DP Connection 1: Connector, M12, Axial, Female, B-coded, 2 -pin Connection 2: Connector, M12, Axial, Male, B-coded, 4 -pin Shielded: Yes Cable length: 10,000 mm Sheathing material: PUR
	50135256	KDS PB-M12-4A-M12-4A-P3-150	Interconnection cable	Suitable for interface: PROFIBUS DP Connection 1: Connector, M12, Axial, Female, B-coded, 2 -pin Connection 2: Connector, M12, Axial, Male, B-coded, 4 -pin Shielded: Yes Cable length: 15,000 mm Sheathing material: PUR
	50135257	KDS PB-M12-4A-M12-4A-P3-300	Interconnection cable	Suitable for interface: PROFIBUS DP Connection 1: Connector, M12, Axial, Female, B-coded, 2 -pin Connection 2: Connector, M12, Axial, Male, B-coded, 4 -pin Shielded: Yes Cable length: 30,000 mm Sheathing material: PUR

Part no.: 50116346 – BCL 304i SF 100 – Stationary bar code reader

## Connection technology - Y distribution cables

	Part no.	Designation	Article	Description
	50110856	KB PB-500-YBSB	Interconnection cable	Suitable for interface: PROFIBUS DP Connection 1: Connector, M12, Axial, Female, B-coded, 5 -pin Connection 2: Connector, M12, Axial, Female, B-coded, 5 -pin Connection 3: Connector, M12, Axial, Male, B-coded, 5 -pin Shielded: Yes Cable length: 500 mm Sheathing material: PUR



## Connection technology - Connectors

	Part no.	Designation	Article	Description
	50038538	KD 02-5-BA	Connector	Suitable for interface: PROFIBUS DP, MultiNet Plus Connection: Connector, M12, Axial, Female, B-coded, 5 -pin
	50038537	KD 02-5-SA	Connector	Suitable for interface: PROFIBUS DP, MultiNet Plus Connection: Connector, M12, Axial, Male, B-coded, 5 -pin
	50020501	KD 095-5A	Connector	Connection: Connector, M12, Axial, Female, A-coded, 5 -pin

## Connection technology - Terminating resistors

	Part no.	Designation	Article	Description
	50038539	TS 02-4-SA	Terminator plug	Suitable for: MultiNet Plus, PROFIBUS DP Connection 1: Connector, M12, Axial, Male, B-coded, 4 -pin Function: Bus termination

## Connection technology - Terminal boxes

	Part no.	Designation	Article	Description
	50116465 *	MK 304	Connection unit	Suitable for: BCL 304i, BPS 304i Suitable for interface: PROFIBUS DP Number of connections: 4 Piece(s) Connection: Terminal
	50116470 *	MS 304	Connection unit	Suitable for: BCL 304i, BPS 304i Suitable for interface: PROFIBUS DP Number of connections: 4 Piece(s) Connection: Connector, M12



\* Necessary accessories, please order separately

Part no.: 50116346 – BCL 304i SF 100 – Stationary bar code reader



## Mounting technology - Mounting brackets

	Part no.	Designation	Article	Description
	50121433	BT 300 W	Mounting device	Contains: 4x M4 x 10 screw, 4x position washers, 4x lock washers Design of mounting device: Angle, L-shape Mounting bracket, at system: Through-hole mounting Mounting bracket, at device: Screw type Type of mounting device: Adjustable Material: Metal

## Mounting technology - Rod mounts

	Part no.	Designation	Article	Description
	50121434	BT 300 - 1	Mounting device	Contains: 4x M4 x 10 screw, 4x position washers, 4x lock washers Design of mounting device: Mounting system Mounting bracket, at system: For 12 mm rod, For 14 mm rod, For 16 mm rod Mounting bracket, at device: Screw type Type of mounting device: Turning, 360°, Adjustable Material: Metal
	50027375	BT 56	Mounting device	Design of mounting device: Mounting system Mounting bracket, at system: For 16 mm rod, For 18 mm rod, For 20 mm rod Mounting bracket, at device: Clampable Material: Metal Tightening torque of the clamping jaws: 8 N·m Functions: Static applications
	50121435	BT 56 - 1	Mounting device	Design of mounting device: Mounting system Mounting bracket, at system: For 12 mm rod, For 14 mm rod, For 16 mm rod Mounting bracket, at device: Clampable Material: Metal Tightening torque of the clamping jaws: 8 N·m Functions: Static applications

## Mounting technology - Other

	Part no.	Designation	Article	Description
	50111224	BT 59	Mounting bracket	Mounting bracket, at system: Groove mounting Mounting bracket, at device: Clampable Material: Metal
	50124941	BTU 0300M-W	Mounting device	Mounting bracket, at system: Through-hole mounting Mounting bracket, at device: Clampable, Groove mounting Material: Metal

## Reflective tapes for standard applications

	Part no.	Designation	Article	Description
	50106119	REF 4-A-100x100	Reflective tape	Design: Rectangular Reflective surface: 100 mm x 100 mm Material: Plastic Chemical designation of the material: PMMA Fastening: Self-adhesive

## General

	Part no.	Designation	Article	Description
	50120731	Housing BCL 300i V2A	Protective housing	Suitable for: BCL 3xxi series bar code reader, deflecting mirror Length: 63 mm Housing material: Stainless steel Standard designation, housing: V2A Lens cover material: Glass Degree of protection: IP 67, IP 69K

## Notes

### Observe intended use!

- This product is not a safety sensor and is not intended as personnel protection.
- The product may only be put into operation by competent persons.
- Only use the product in accordance with its intended use.

### WARNING! LASER RADIATION – LASER CLASS 2

#### Never look directly into the beam!

The device satisfies the requirements of IEC 60825-1:2007 (EN 60825-1:2007) safety regulations for a product of **laser class 2** as well as the U.S. 21 CFR 1040.10 regulations with deviations corresponding to "Laser Notice No. 50" from June 24, 2007.

- Never look directly into the laser beam or in the direction of reflected laser beams! If you look into the beam path over a longer time period, there is a risk of injury to the retina.
- Do not point the laser beam of the device at persons!
- Interrupt the laser beam using a non-transparent, non-reflective object if the laser beam is accidentally directed towards a person.
- When mounting and aligning the device, avoid reflections of the laser beam off reflective surfaces!
- CAUTION! Use of controls or adjustments or performance of procedures other than specified herein may result in hazardous light exposure.
- Observe the applicable statutory and local laser protection regulations.
- The device must not be tampered with and must not be changed in any way.  
There are no user-serviceable parts inside the device.  
Repairs must only be performed by Leuze electronic GmbH + Co. KG.

**NOTE****Affix laser information and warning signs!**

Laser information and warning signs are affixed to the device. In addition, self-adhesive laser information and warning signs (stick-on labels) are supplied in several languages.

- Affix the laser information sheet to the device in the language appropriate for the place of use. When using the device in the US, use the stick-on label with the "Complies with 21 CFR 1040.10" note.
- Affix the laser information and warning signs near the device if no signs are attached to the device (e.g. because the device is too small) or if the attached laser information and warning signs are concealed due to the installation position.
- Affix the laser information and warning signs so that they are legible without exposing the reader to the laser radiation of the device or other optical radiation.