



Inverter

Inverter i510 Cabinet 0.25 to 2.2 kW

Contents

1	General information	11
1.1	Read first, then start	11
2	Safety instructions	12
2.1	Basic safety measures	12
2.2	Residual hazards	13
2.3	Application as directed	13
3	Mounting	14
3.1	Important notes	14
3.2	Mechanical installation	15
3.3	Electrical installation	18
3.3.1	1-phase mains connection 230/240 V	18
3.3.1.1	Connection plan	18
3.3.1.2	Fusing and terminal data	19
3.3.2	1/3-phase mains connection 230/240 V	20
3.3.2.1	Connection plan	20
3.3.2.2	Fusing and terminal data	21
3.3.3	3-phase mains connection 400 V	22
3.3.3.1	Connection plan	22
3.3.3.2	Fusing and terminal data	23
3.3.4	3-phase mains connection 480 V	24
3.3.4.1	Connection plan	24
3.3.4.2	Fusing and terminal data	25
3.3.5	CANopen/Modbus	26
4	Commissioning	27
4.1	Important notes	27
4.2	Operating interfaces	28
4.2.1	Keypad	28
4.2.2	Engineering tool »EASY Starter«	29
4.2.2.1	Generate a connection between inverter and »EASY Starter«	30
4.3	Parameter setting	32
4.3.1	General notes on parameters	33
4.3.2	Basic inverter settings	34
4.3.3	Basic motor settings	36
4.3.4	Function assignment of the inputs and outputs	38
4.4	Keypad parameter list	41
4.5	Save parameter settings in the memory module	58
4.5.1	Save parameter settings with keypad	58
4.5.2	Save parameter settings with »EASY Starter«	58

Contents

5	Diagnostics and fault elimination	59
5.1	LED status display	59
5.2	Diagnostics parameter	60
5.2.1	Logbook	61
5.2.2	Error history buffer	62
5.2.3	Inverter diagnostics	64
5.2.4	Network diagnostics	70
5.2.4.1	CANopen diagnostics	72
5.2.4.2	Modbus diagnostics	75
5.2.4.3	Wireless-LAN diagnostics	75
5.2.5	Diagnostics of the inputs and outputs	77
5.2.5.1	Digital inputs and outputs	77
5.2.5.2	Analog inputs and outputs	78
5.2.6	Process controller status	79
5.2.7	Device identification	80
5.2.8	Device overload monitoring (i*t)	81
5.2.9	Heatsink Temperature Monitoring	81
5.2.10	Life-diagnosis	82
5.3	Error handling	83
5.3.1	Error types	83
5.3.2	Error configuration	84
5.3.3	Error reset	84
5.3.4	Keypad error messages	84
6	Basic setting	85
6.1	Mains voltage	86
6.2	Control source selection	88
6.3	Selection of setpoint source	89
6.3.1	Keypad setpoint default setting	90
6.4	Starting/stopping performance	91
6.4.1	Starting performance	91
6.4.2	Stopping performance	91
6.5	Frequency limits and ramp times	92
6.6	Quick stop	95
6.7	S-shaped ramps	97
6.8	Optical device identification	98

7	Motor control	99
7.1	Motor data	100
7.1.1	Automatic identification of the motor data.....	103
7.2	Motor control selection	105
7.2.1	V/f characteristic control (VFC)	106
7.2.1.1	Linear V/f characteristic.....	107
7.2.1.2	Square-law V/f characteristic.....	108
7.2.1.3	V/f characteristic control - energy-saving (VFC Eco).....	109
7.2.2	Sensorless vector control (SLVC)	110
7.2.3	Sensorless control for synchronous motors (SL-PSM).....	112
7.3	Optimisation of motor control	113
7.3.1	V/f voltage boost	113
7.3.2	Skip frequencies	114
7.3.3	Optimising the stalling behaviour	116
7.3.4	Slip compensation	118
7.3.5	Oscillation damping.....	119
7.4	Optimisation of the control loops.....	121
7.4.1	Speed controller	121
7.4.2	I _{max} controller	122
7.4.3	Current controller.....	122
7.5	Motor rotating direction	123
7.6	Switching frequency changeover.....	124
7.7	Motor protection.....	125
7.7.1	Motor overload monitoring (i ² *t)	126
7.7.2	Current limits.....	130
7.7.3	Overcurrent monitoring.....	132
7.7.4	Motor phase failure detection	133
7.7.5	Motor speed monitoring	134
7.7.6	Motor torque monitoring	134

Contents

8	Configuring the network	136
8.1	General network settings	137
8.2	Predefined process data words	149
8.2.1	Device profile CiA 402	150
8.2.2	AC Drive Profile	151
8.2.3	Lenze LECOM profile	152
8.2.4	Further process data	153
8.3	Acyclic data exchange	157
8.4	CANopen	158
8.4.1	CANopen introduction	158
8.4.2	CANopen node address	159
8.4.3	CANopen baud rate	159
8.4.4	CANopen initialisation	160
8.4.5	CANopen diagnostics	161
8.4.6	CANopen emergency telegram	163
8.4.7	CANopen heartbeat protocol	164
8.4.8	CANopen process data objects	165
8.4.9	CANopen data mapping	173
8.4.10	CANopen service data objects	176
8.4.11	CANopen error responses	177
8.4.12	CANopen diagnostic counter	179
8.4.13	CANopen LED status displays	180
8.4.14	Resetting the CANopen interface	180
8.4.15	CANopen - short setup	181
8.5	Modbus	184
8.5.1	Modbus introduction	184
8.5.2	Modbus node address	185
8.5.3	Modbus baud rate	185
8.5.4	Modbus data format	185
8.5.5	Modbus time-out monitoring	186
8.5.6	Modbus diagnostics	186
8.5.7	Modbus function codes	189
8.5.8	Modbus data mapping	190
8.5.9	Modbus LED status displays	194
8.5.10	Reset Modbus interface	194
8.5.11	Modbus response time	194
8.5.12	Short setup of Modbus	195
8.6	Wireless LAN (WLAN)	196
8.6.1	LED status displays	196
8.6.2	WLAN basic settings	197
8.6.2.1	Resetting WLAN settings to default setting	199
8.6.3	WLAN access point mode	200
8.6.3.1	Establishing a direct WLAN connection between smartphone and inverter	201
8.6.3.2	Using the smartphone as "Smart Keypad"	202
8.6.3.3	Establishing a direct WLAN connection between Engineering PC and inverter	203
8.6.4	WLAN client mode	205

9 Configuring the process controller207

- 9.1 Basic process controller settings208
- 9.2 Process controller - idle state and rinse function.....214
 - 9.2.1 Process controller idle state.....214
 - 9.2.2 Process controller rinse function215

Contents

10 Additional functions	216
10.1 Device Commands.....	217
10.1.1 Reset parameters to default.....	217
10.1.2 Saving/loading the parameter settings.....	218
10.1.3 Device commands for parameter change-over.....	220
10.1.4 Initialising the network interface.....	221
10.1.5 Delete logbook.....	222
10.2 Keypad.....	223
10.2.1 Keypad language selection.....	223
10.2.2 Keypad setpoint increment.....	223
10.2.3 Keypad scaling of speed display.....	223
10.2.4 Keypad status display.....	223
10.3 DC braking.....	224
10.3.1 Example 1: Automatic DC braking when the motor is started.....	226
10.3.2 Example 2: Automatic DC braking when the motor is stopped.....	227
10.4 Brake energy management.....	229
10.4.1 Stopping the deceleration ramp function generator.....	230
10.4.2 Inverter motor brake.....	231
10.5 Load loss detection.....	232
10.6 Access protection.....	233
10.6.1 Write access protection.....	233
10.6.1.1 Write access protection in the »EASY Starter«.....	235
10.6.1.2 Write access protection in the keypad.....	238
10.7 Favorites.....	242
10.7.1 Accessing the "Favorites" with the keypad.....	242
10.7.2 Favorites parameter list (default setting).....	243
10.7.3 Configuring the "Favorites".....	244
10.8 Parameter change-over.....	247
10.8.1 Example: Selective control of several motors with one inverter.....	260
10.9 Device profile CiA 402.....	262
10.10 Holding brake control.....	266
10.10.1 "Automatic" brake mode (automatic operation).....	269
10.10.2 Example 1: Forward motion without feedforward control.....	272
10.10.3 Example 2: Forward motion without feedforward control with reversal.....	273
10.10.4 Example 3: Upward motion with feedforward control.....	274
10.10.5 Example 4: Upward motion with feedforward control and inverted rotation.....	275
10.10.6 Example 5: Downward motion with feedforward control.....	276
10.10.7 Manual release of the holding brake.....	277
10.11 Flying restart circuit.....	278
10.12 Timeout für fault reaction.....	280
10.13 Automatic restart.....	281
10.14 Mains failure control.....	282
10.14.1 Activating the mains failure control.....	284
10.14.2 Restart protection.....	285
10.14.3 Fast mains recovery.....	285
10.14.4 Commissioning the mains failure control.....	286
10.15 Firmware download.....	287
10.15.1 Firmware download with »EASY Starter (Firmware loader)«.....	287

10.16	Additive voltage impression.....	288
10.16.1	Example: Using the function with a 400-V inverter.....	289
10.17	Parameter for engineering tools.....	290
11	Flexible I/O configuration	292
11.1	Control source change-over.....	293
11.1.1	Example 1: Change-over from terminal control to keypad control.....	297
11.1.2	Example 2: Change-over from terminal control to network control.....	298
11.2	Start / stop motor.....	299
11.2.1	Example 1: Start/stop (1 signal) and reversal.....	304
11.2.2	Example 2: Start forward/start reverse/stop (edge-controlled).....	305
11.2.3	Example 3: Run forward/Run reverse/stop (status-controlled).....	307
11.2.4	Example 4: Quick stop.....	309
11.2.5	Example 5: Jog forward/Jog reverse.....	310
11.2.6	Example 6: Enable inverter.....	312
11.3	Setpoint change-over.....	313
11.3.1	Priority of the setpoint sources.....	314
11.3.2	Analog input setpoint source.....	315
11.3.3	Keypad setpoint source.....	317
11.3.4	Network setpoint source.....	319
11.3.5	Setpoint source of preset setpoints.....	320
11.3.6	Motor potentiometer setpoint source (MOP).....	325
11.4	Reset error.....	329
11.5	Activating DC braking manually.....	331
11.6	Releasing holding brake manually.....	333
11.7	Activating ramp 2 manually.....	335
11.8	Triggering a user-defined fault.....	337
11.9	Functions for parameter change-over.....	338
11.9.1	Example 1: Activation via command (only when disabled).....	340
11.9.2	Example 2: Activation via command (immediately).....	341
11.9.3	Example 3: Activation if the selection is changed (only if the inverter is disabled).....	342
11.9.4	Example 4: Activation if the selection is changed (immediately).....	343
11.10	Process controller function selection.....	344
11.11	Frequency threshold for "Frequency threshold exceeded" trigger.....	347
11.12	Configuration of digital inputs.....	348
11.13	Configuration of analog inputs.....	349
11.13.1	Analog input 1.....	349
11.13.1.1	Example 1: Input range 0 ... 10 V \equiv setting range 0 ... 50 Hz.....	351
11.13.1.2	Example 2: Input range 0 ... 10 V \equiv setting range -40 ... +40 Hz.....	351
11.13.1.3	Example 3: Error detection.....	352
11.13.2	Analog input 2.....	353
11.14	Configuration of digital outputs.....	355
11.14.1	Relay.....	355
11.14.2	Digital output 1.....	358
11.14.3	NetWordOUT1 status word.....	359
11.15	Configuration of analog outputs.....	362
11.15.1	Analog output 1.....	362
11.15.1.1	Example 1: Output voltage 0 ... 10 V \equiv output frequency 0 ... 100 Hz.....	363
11.15.1.2	Example 2: Output voltage 2 ... 10 V \equiv output frequency 30 ... 60 Hz.....	364

Contents

12 Technical data	365
12.1 Standards and operating conditions	365
12.1.1 Conformities/approvals	365
12.1.2 Protection of persons and device protection	365
12.1.3 EMC data	365
12.1.4 Motor connection	366
12.1.5 Environmental conditions	366
12.1.6 Electrical supply conditions	366
12.2 1-phase mains connection 230/240 V	367
12.2.1 Rated data	367
12.3 1/3-phase mains connection 230/240 V	368
12.3.1 Rated data	368
12.4 3-phase mains connection 400 V	369
12.4.1 Rated data	369
12.5 3-phase mains connection 480 V	370
12.5.1 Rated data	370
13 Appendix	371
13.1 Operate and parameterise the inverter with keypad	371
13.1.1 Keypad operating mode	372
13.1.1.1 Keypad status display	372
13.1.1.2 Function of keypad keys in operating mode	373
13.1.1.3 Error reset with keypad	373
13.1.2 Keypad parameterisation mode	374
13.1.2.1 Parameter groups	374
13.1.2.2 Function of the keypad keys in the parameterisation mode	375
13.1.2.3 Save parameter settings with keypad	376
13.1.2.4 Display of status words on keypad	377
13.2 Error codes	378
13.3 Parameter attribute list	388



1 General information

1.1 Read first, then start

WARNING!

Read this documentation thoroughly before carrying out the installation and commissioning.

► Please observe the safety instructions!



Information and tools with regard to the Lenze products can be found on the Internet:

<http://www.lenze.com> → Download

Safety instructions

Basic safety measures



2 Safety instructions

2.1 Basic safety measures

Disregarding the following basic safety measures may lead to severe personal injury and damage to material assets!

The product

- must only be used as directed.
- must never be commissioned if they display signs of damage.
- must never be technically modified.
- must never be commissioned if they are not fully mounted.
- must never be operated without required covers.

Connect/disconnect all pluggable terminals only in deenergised condition.

Only remove the product from the installation in the deenergised state.

Insulation resistance tests between 24V control potential and PE: According to EN 61800–5–1, the maximum test voltage must not exceed 110 V DC.

Observe all specifications of the corresponding documentation supplied. This is the precondition for safe and trouble-free operation and for obtaining the product features specified.

The procedural notes and circuit details described in this document are only proposals. It is up to the user to check whether they can be adapted to the particular applications. Lenze does not take any responsibility for the suitability of the procedures and circuit proposals described.

The product must only be used by qualified personnel. IEC 60364 or CENELEC HD 384 define the skills of these persons:

- They are familiar with installing, mounting, commissioning, and operating the product.
- They have the corresponding qualifications for their work.
- They know and can apply all regulations for the prevention of accidents, directives, and laws applicable at the place of use.

Please observe the specific notes in the other chapters!

Notes used:

DANGER!

This note refers to an imminent danger which, if not avoided, may result in death or serious injury.

WARNING!

This note refers to a danger which, if not avoided, may result in death or serious injury.

CAUTION!

This note refers to a danger which, if not avoided, may result in minor or moderate injury.

NOTICE

This note refers to a danger which, if not avoided, may result in damage to property.







2.2 Residual hazards

The user must take the residual hazards mentioned into consideration in the risk assessment for his/her machine/system.

If the above is disregarded, this can lead to severe injuries to persons and damage to material assets!

Product

Observe the warning labels on the product!

Icon	Description
	Electrostatic sensitive devices: Before working on the product, the staff must ensure to be free of electrostatic charge!
	Dangerous electrical voltage Before working on the product, check if no voltage is applied to the power terminals! After mains disconnection, the power terminals carry the hazardous electrical voltage given on the product!
	High leakage current: Carry out fixed installation and PE connection in compliance with EN 61800-5-1 or EN 60204-1!
	Hot surface: Use personal protective equipment or wait until devices have cooled down!

Motor

If there is a short circuit of two power transistors, a residual movement of up to 180°/number of pole pairs can occur at the motor! (For 4-pole motor: residual movement max. $180^\circ/2 = 90^\circ$).

2.3 Application as directed

- The product must only be operated under the operating conditions prescribed in this documentation.
- The product meets the protection requirements of 2014/35/EU: Low-Voltage Directive.
- The product is not a machine in terms of 2006/42/EC: Machinery Directive.
- Commissioning or starting the operation as directed of a machine with the product is not permitted until it has been ensured that the machine meets the regulations of the EC Directive 2006/42/EC: Machinery Directive; observe EN 60204-1.
- Commissioning or starting the operation as directed is only allowed when there is compliance with the EMC Directive 2014/30/EU.
- The harmonised standard EN 61800-5-1 is used for the inverters.
- The product is not a household appliance, but is only designed as component for commercial or professional use in terms of EN 61000-3-2.
- The product can be used according to the technical data if drive systems have to comply with categories according to EN 61800-3.

In residential areas, the product may cause EMC interferences. The operator is responsible for taking interference suppression measures.



3 Mounting

3.1 Important notes

 DANGER!

Dangerous electrical voltage

Possible consequence: death or severe injuries

- ▶ All work on the inverter must only be carried out in the deenergised state.
 - ▶ After switching off the mains voltage, wait for at least 3 minutes before you start working.
-



3.2 Mechanical installation

Dimensions I51AE 0.25 kW ... 0.37 kW

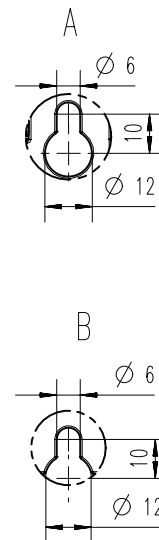
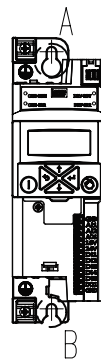
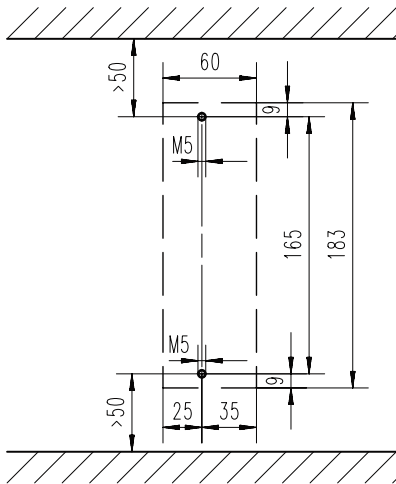
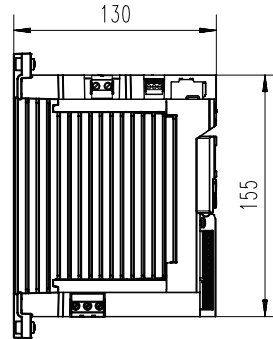
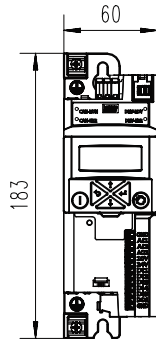

8800270

All dimensions in mm

Mounting

Mechanical installation



Dimensions I51AE 0.55 kW ... 0.75 kW

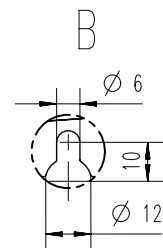
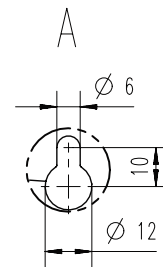
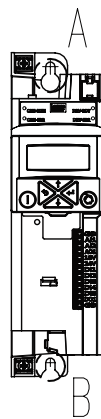
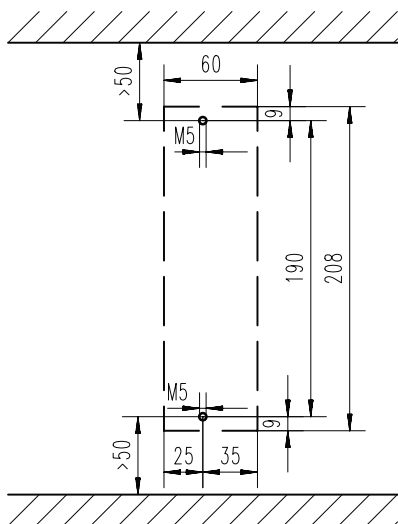
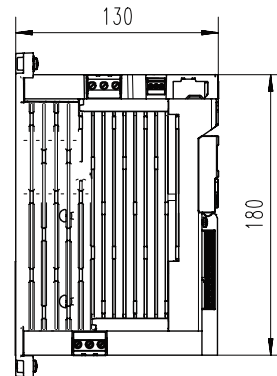
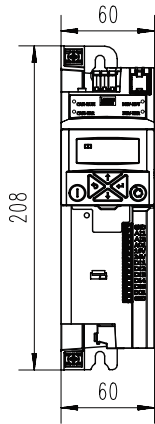

8800271

All dimensions in mm



Dimensions I51AE 1.1 kW ... 2.2 kW

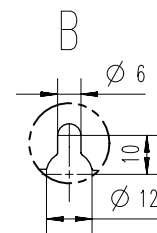
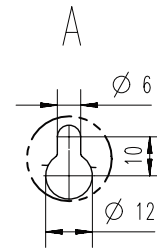
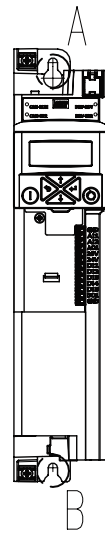
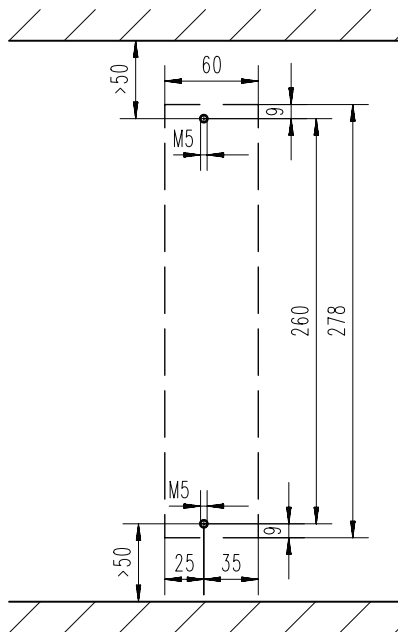
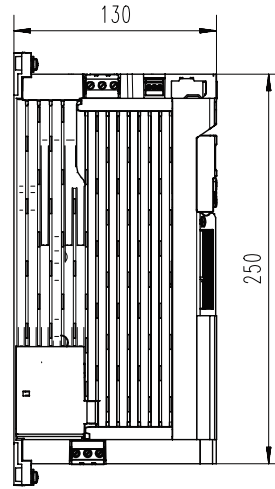
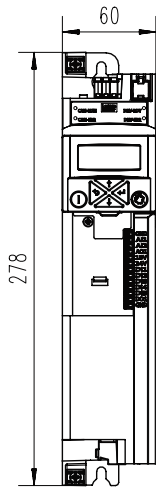

8800272

All dimensions in mm

Mounting

Electrical installation

1-phase mains connection 230/240 V



3.3 Electrical installation

3.3.1 1-phase mains connection 230/240 V

3.3.1.1 Connection plan

The wiring diagram is valid for I5xAExxxB inverters.

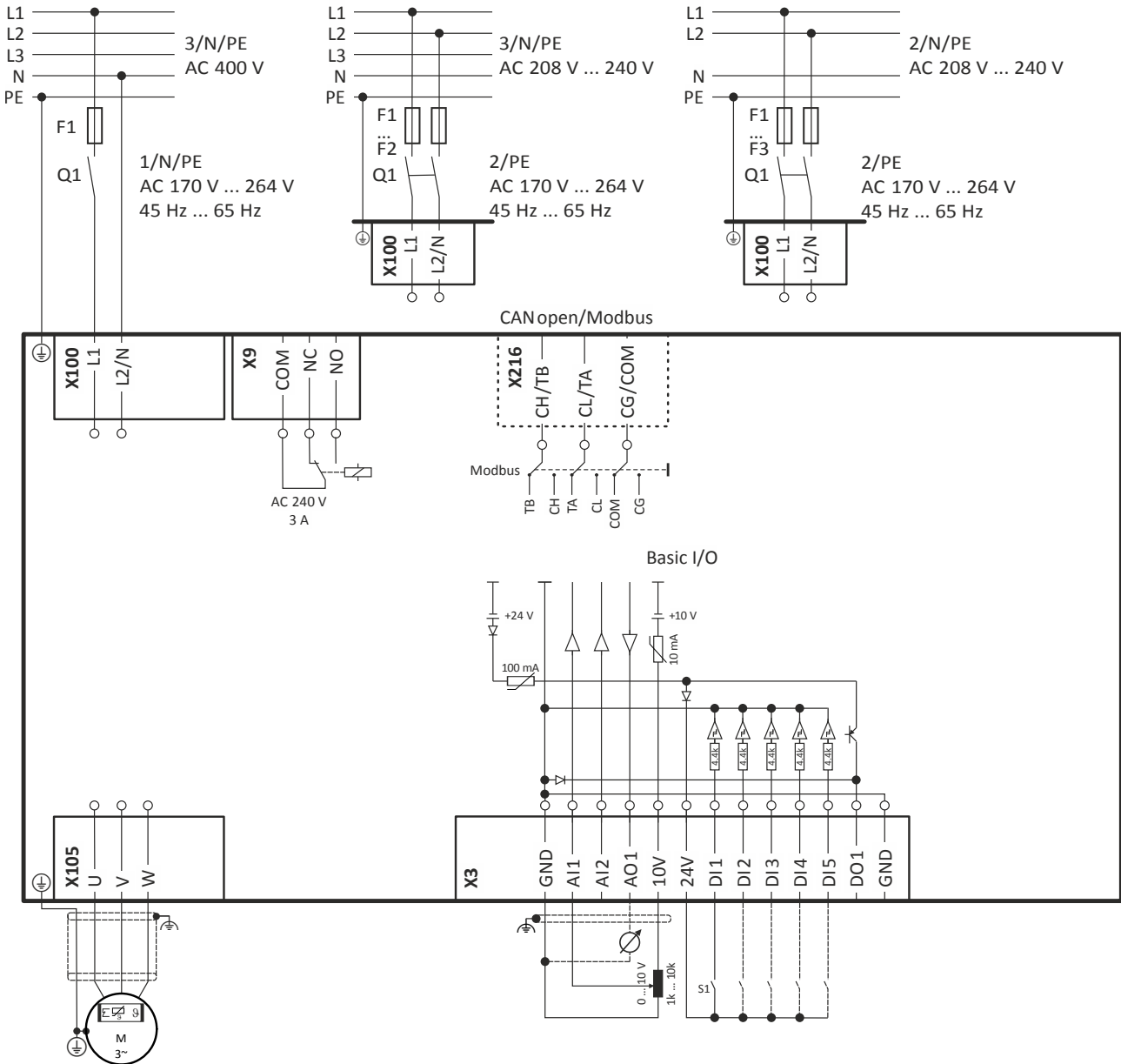

Fig. 1: Wiring example

S1 Run/Stop
Fx Fuses

Q1 Mains contactor
--- Dashed line = options



3.3.1.2 Fusing and terminal data

Inverter		I51AE125B	I51AE137B	I51AE155B	I51AE175B	I51AE211B	I51AE215B	I51AE222B
Cable installation in compliance with		EN 60204-1						
Laying system		B2						
Operation		without mains choke						
Fuse								
Characteristics		gG/gL or gRL						
Max. rated current	A	10	10	16	16	25	25	25
Circuit breaker								
Characteristics		B						
Max. rated current	A	10	10	16	16	25	25	25
Operation		with mains choke						
Fuse								
Characteristics		gG/gL or gRL						
Max. rated current	A	10	10	16	16	25	25	25
Circuit breaker								
Characteristics		B						
Max. rated current	A	10	10	16	16	25	25	25
Earth-leakage circuit breaker								
1-phase mains connection		≥ 30 mA, type A or B						
Mains connection								
Connection		X100						
Connection type		Screw terminal						
Min. cable cross-section	mm ²	1						
Max. cable cross-section	mm ²	2.5				6		
Stripping length	mm	8						
Tightening torque	Nm	0.5				0.7		
Required tool		0.5 x 3.0				0.6 x 3.5		
Motor connection								
Connection		X105						
Connection type		Screw terminal						
Min. cable cross-section	mm ²	1						
Max. cable cross-section	mm ²	2.5						
Stripping length	mm	8						
Tightening torque	Nm	0.5						
Required tool		0.5 x 3.0						

Mounting

Electrical installation
1/3-phase mains connection 230/240 V



3.3.2 1/3-phase mains connection 230/240 V



I5xAExxD inverters do not have an integrated EMC filter in the AC mains supply.

In order to comply with the EMC requirements according to EN 61800-3, an external EMC filter according to IEC EN 60939 has to be used.

The user must prove that the EN 61800-3 requirements for conformity are fulfilled.

3.3.2.1 Connection plan

The wiring diagram is valid for I5xAExxD inverters.

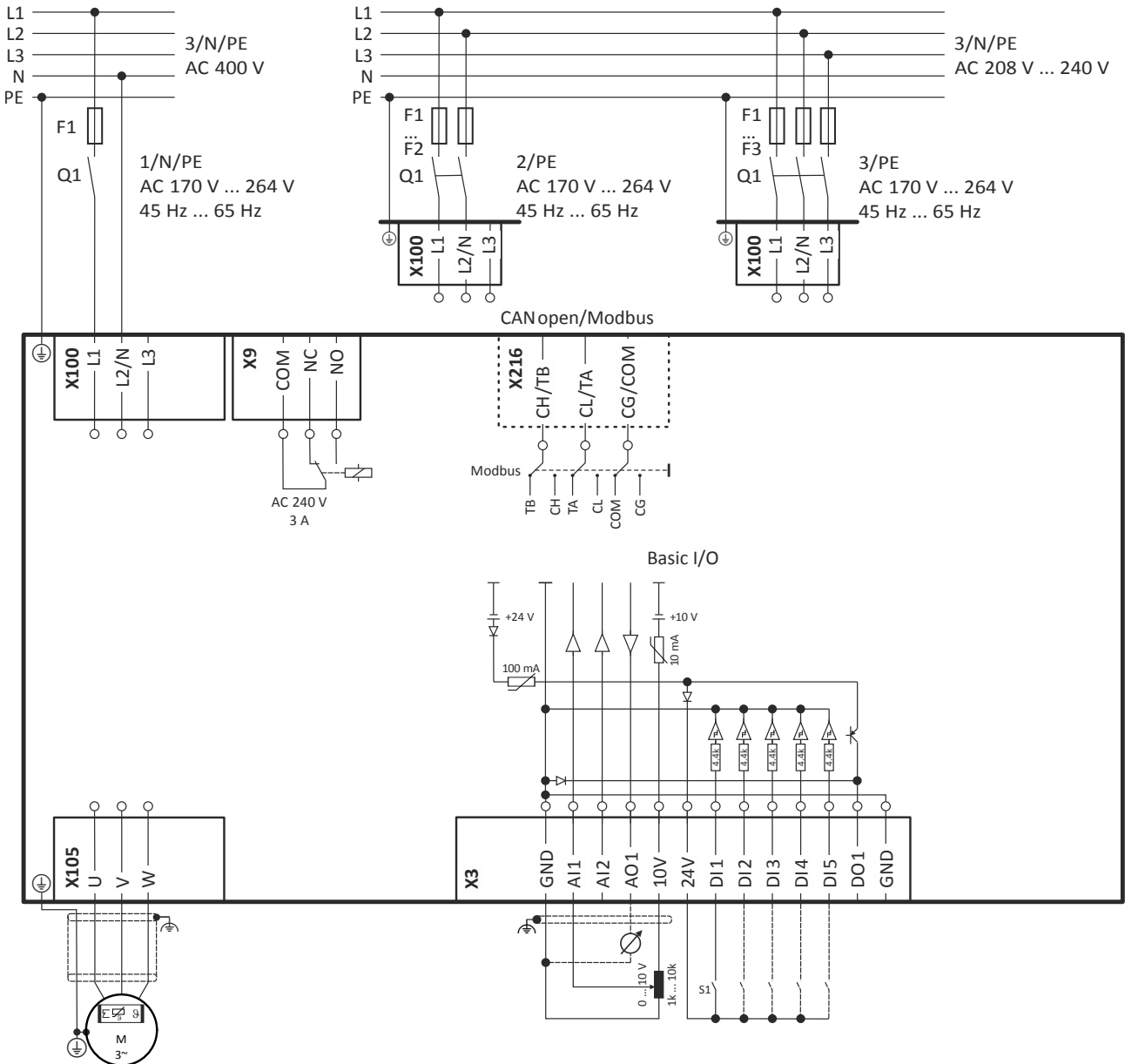

Fig. 2: Wiring example

S1 Run/Stop
Fx Fuses

Q1 Mains contactor
--- Dashed line = options



3.3.2.2 Fusing and terminal data

Inverter		I51AE125D	I51AE137D	I51AE155D	I51AE175D	I51AE211D	I51AE215D	I51AE222D
Cable installation in compliance with		EN 60204-1						
Laying system		B2						
Operation		without mains choke						
Fuse								
Characteristics		gG/gL or gRL						
Max. rated current	A	10	10	16	16	25	25	25
Circuit breaker								
Characteristics		B						
Max. rated current	A	10	10	16	16	25	25	25
Operation		with mains choke						
Fuse								
Characteristics		gG/gL or gRL						
Max. rated current	A	10	10	16	16	25	25	25
Circuit breaker								
Characteristics		B						
Max. rated current	A	10	10	16	16	25	25	25
Earth-leakage circuit breaker								
1-phase mains connection		≥ 30 mA, type A or B						
3-phase mains connection		≥ 30 mA, type B						
Mains connection								
Connection		X100						
Connection type		Screw terminal						
Min. cable cross-section	mm ²	1						
Max. cable cross-section	mm ²	2.5				6		
Stripping length	mm	8						
Tightening torque	Nm	0.5				0.7		
Required tool		0.5 x 3.0				0.6 x 3.5		
Motor connection								
Connection		X105						
Connection type		Screw terminal						
Min. cable cross-section	mm ²	1						
Max. cable cross-section	mm ²	2.5						
Stripping length	mm	8						
Tightening torque	Nm	0.5						
Required tool		0.5 x 3.0						

Mounting

Electrical installation
3-phase mains connection 400 V



3.3.3 3-phase mains connection 400 V

3.3.3.1 Connection plan

The wiring diagram is valid for I5xAExxF inverters.

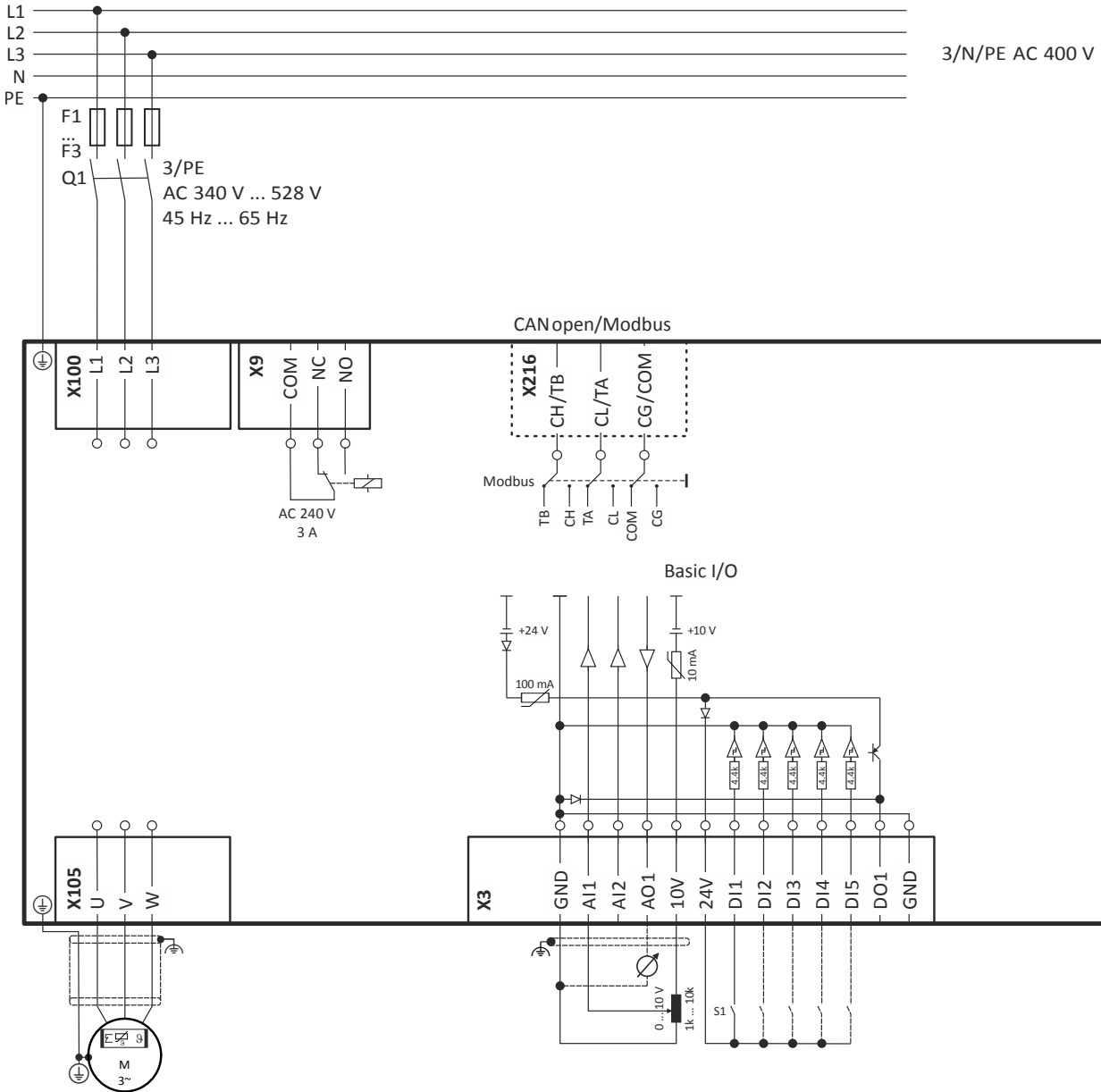

Fig. 3: Wiring example

- | | | | |
|----|----------|-----|-----------------------|
| S1 | Run/Stop | Q1 | Mains contactor |
| Fx | Fuses | --- | Dashed line = options |



3.3.3.2 Fusing and terminal data

Inverter		I51AE137F	I51AE155F	I51AE175F	I51AE211F	I51AE215F	I51AE222F
Cable installation in compliance with		EN 60204-1					
Laying system		B2					
Operation		without mains choke					
Fuse							
Characteristics		gG/gL or gRL					
Max. rated current	A	10	10	10	16	16	16
Circuit breaker							
Characteristics		B					
Max. rated current	A	10	10	10	16	16	16
Operation		with mains choke					
Fuse							
Characteristics		gG/gL or gRL					
Max. rated current	A	10	10	10	16	16	16
Circuit breaker							
Characteristics		B					
Max. rated current	A	10	10	10	16	16	16
Earth-leakage circuit breaker							
3-phase mains connection		≥ 30 mA, type B					
Mains connection							
Connection		X100					
Connection type		Screw terminal					
Min. cable cross-section	mm ²	1					
Max. cable cross-section	mm ²	2.5					
Stripping length	mm	8					
Tightening torque	Nm	0.5					
Required tool		0.5 x 3.0					
Motor connection							
Connection		X105					
Connection type		Screw terminal					
Min. cable cross-section	mm ²	1					
Max. cable cross-section	mm ²	2.5					
Stripping length	mm	8					
Tightening torque	Nm	0.5					
Required tool		0.5 x 3.0					

Mounting

Electrical installation
3-phase mains connection 480 V



3.3.4 3-phase mains connection 480 V

3.3.4.1 Connection plan

The wiring diagram is valid for I5xAExxF inverters.

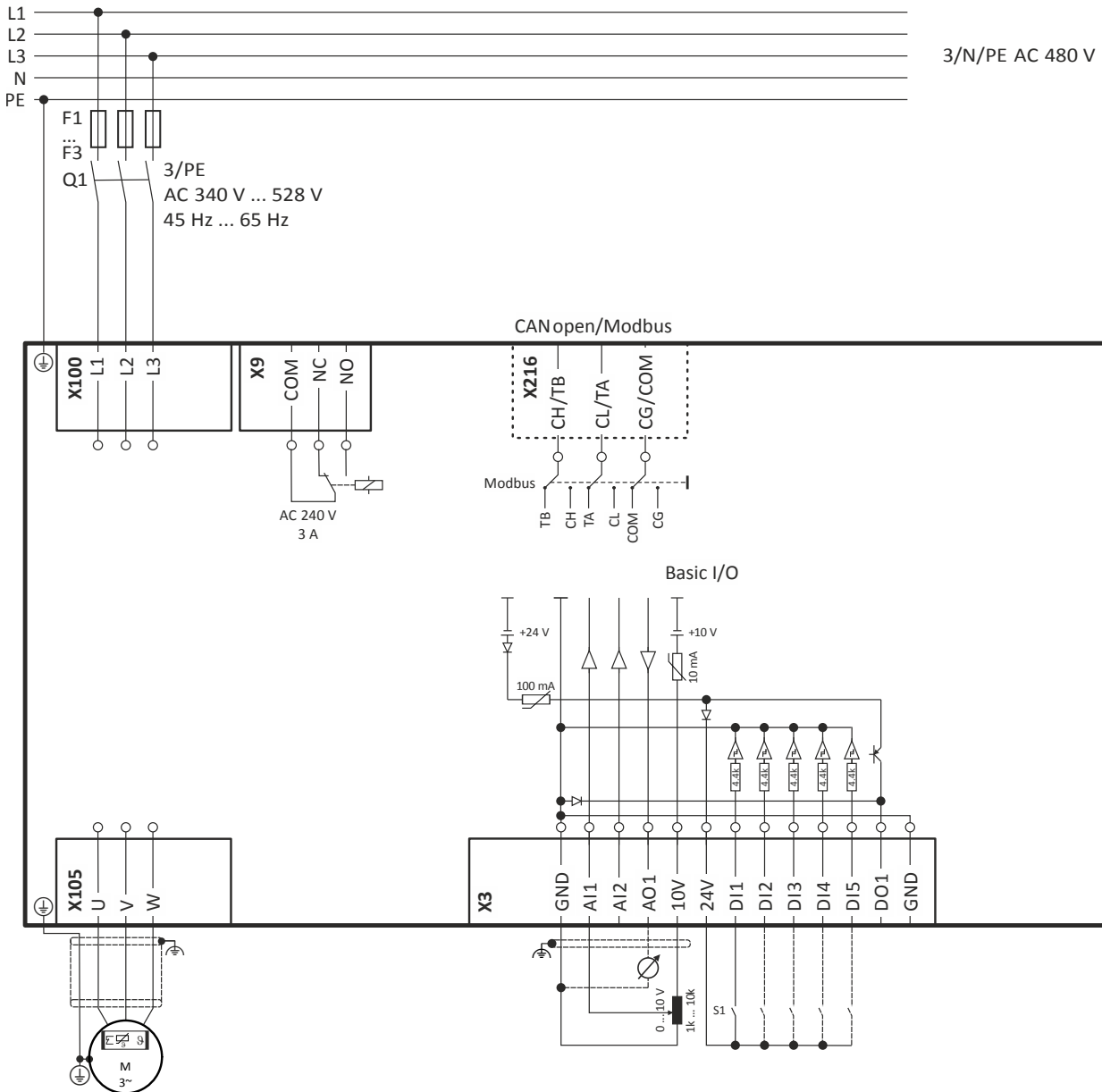

Fig. 4: Wiring example

S1 Run/Stop
Fx Fuses

Q1 Mains contactor
--- Dashed line = options



3.3.4.2 Fusing and terminal data

Inverter		I51AE137F	I51AE155F	I51AE175F	I51AE211F	I51AE215F	I51AE222F
Cable installation in compliance with		EN 60204-1					
Laying system		B2					
Operation		without mains choke					
Fuse							
Characteristics		gG/gL or gRL					
Max. rated current	A	10	10	10	16	16	16
Circuit breaker							
Characteristics		B					
Max. rated current	A	10	10	10	16	16	16
Operation		with mains choke					
Fuse							
Characteristics		gG/gL or gRL					
Max. rated current	A	10	10	10	16	16	16
Circuit breaker							
Characteristics		B					
Max. rated current	A	10	10	10	16	16	16
Earth-leakage circuit breaker							
3-phase mains connection		≥ 30 mA, type B					
Mains connection							
Connection		X100					
Connection type		Screw terminal					
Min. cable cross-section	mm ²	1					
Max. cable cross-section	mm ²	2.5					
Stripping length	mm	8					
Tightening torque	Nm	0.5					
Required tool		0.5 x 3.0					
Motor connection							
Connection		X105					
Connection type		Screw terminal					
Min. cable cross-section	mm ²	1					
Max. cable cross-section	mm ²	2.5					
Stripping length	mm	8					
Tightening torque	Nm	0.5					
Required tool		0.5 x 3.0					



3.3.5 CANopen/Modbus

Typical topologies

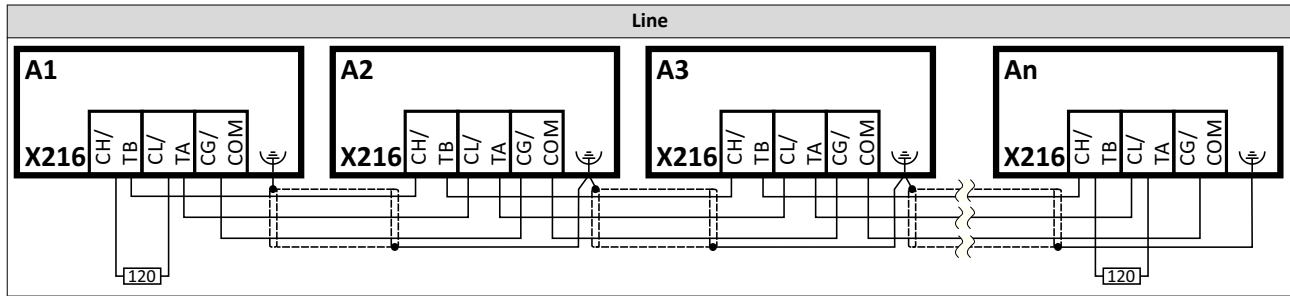

Terminal description		CANopen/Modbus
Connection		X216
Connection type		Spring terminal
Min. cable cross-section	mm ²	0.5
Max. cable cross-section	mm ²	2.5
Stripping length	mm	10
Tightening torque	Nm	-
Required tool		0.4 x 2.5

Basic network settings

1. Select network CANopen or Modbus using the switch on the front of the inverter.

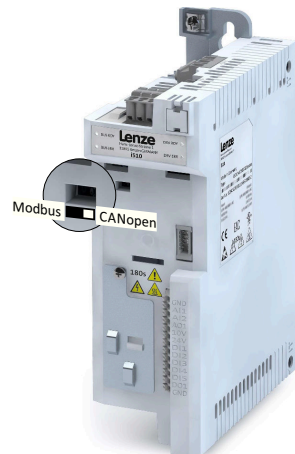

2. Set node address and baud rate via the corresponding parameters.



The network must be terminated with a 120 Ω resistor at the physically first and last node.

Connect resistor to terminals CH/TB and CL/TA.



4 Commissioning

4.1 Important notes

WARNING!

Incorrect wiring can cause unexpected states during the commissioning phase.

Possible consequence: death, severe injuries or damage to property

Check the following before switching on the mains voltage:

- ▶ Is the wiring complete and correct?
 - ▶ Are there no short circuits and earth faults?
 - ▶ Is the motor circuit configuration (star/delta) adapted to the output voltage of the inverter?
 - ▶ Is the motor connected in-phase (direction of rotation)?
 - ▶ Does the "emergency stop" function of the entire plant operate correctly?
-

WARNING!

Incorrect settings during commissioning may cause unexpected and dangerous motor and system movements.

Possible consequence: death, severe injuries or damage to property

- ▶ Clear hazardous area.
 - ▶ Observe safety instructions and safety clearances.
-

Commissioning

Operating interfaces
Keypad



4.2 Operating interfaces

Commissioning the inverter requires an operator-process interface.

4.2.1 Keypad

The keypad is an easy means for the local operation, parameterisation, and diagnostics of the inverter.



- The keypad is simply connected to the diagnostic interface on the front of the inverter.
- The keypad can also be connected and removed during operation.

Detailed information on the keypad can be found in the appendix:

▶ [Operate and parameterise the inverter with keypad](#)  371



4.2.2 Engineering tool »EASY Starter«

The »EASY Starter« is a PC software that is especially designed for the commissioning and maintenance of the inverter.



The »EASY Starter« PC software can be found on the Internet:
<http://www.lenze.com> → Download → Software Downloads

Sample screenshot:

The screenshot displays the EASY Starter V1.8.0.6156 software interface. The main window is titled "i550 CAN application IO 50 Hz - Diagnosis-Adapter - My Device". The interface is divided into several sections:

- Left Panel:** Shows the device tree with "Type: i550 CAN application IO 50 Hz", "Address path: Diagnosis-Adapter", "Name: My Device", "Version: 1.0.1.0", "Bus server: Lenze OPC Diagnostics Serv", and "Device description: i550_CAN_application_IO_0".
- Settings Panel:** Contains tabs for "Settings", "Diagnosis", "Parameter list", and "Trend". The "Settings" tab is active, showing "Actuating Speed Overview".
- Basic Setup:** Includes parameters for "Rated mains voltage" (230Veff [0]), "Rotation restriction" (Forward and reverse [1]), "Default frequency setpoint" (Analog input 1 [2]), "Start method" (Normal [0]), "Start on Power up" (Off [0]), and "Stop method" (Standard Ramp [1]).
- Motor Control:** Includes parameters for "Designation" (0), "Motor control mode" (VFC open loop [6]), "Motor rated current" (1.420 A), "Rated speed" (1450 rpm), "Rated frequency" (50.0 Hz), "Rated voltage" (230 V), and "Rated cosine phi" (0.80).
- Function & I/O Setup:** Includes parameters for "Preset bit0 selection" (Digital input 4 [14]), "Preset bit1 selection" (Digital input 5 [15]), "Inverter enable" (TRUE [1]), "Quick stop" (Not connected [0]), "Run forward (CW)" (Not connected [0]), "Run reverse (CCW)" (Not connected [0]), and three "Preset" frequency values (20.0 Hz, 40.0 Hz, 50.0 Hz).
- Controller inhibit set:** A section at the bottom with checkboxes for "DC link circuit volta...", "Actual motor current", "Actual motor voltage", "v1 velocity actual va...", "Actual frequency", "Status words: L402...", and "Error code".
- Real-time Monitoring:** A row of seven data boxes showing: "0 V", "0.0 A", "0 VAC", "0 rpm", "0.0 Hz", "Initial [0]", and "No Error [0]". A "Drag&Drop Parameter" button is located to the right.

Commissioning

Operating interfaces
Engineering tool »EASY Starter«



4.2.2.1 Generate a connection between inverter and »EASY Starter«

For commissioning the inverter with the »EASY Starter«, a communication link with the inverter is required. This can be established in a wired or wireless manner via WLAN.

Preconditions

- For the wired communication with the inverter, the USB module and a USB 2.0 cable (A plug on Micro-B plug) are required.



- For the wireless communication with the inverter, the WLAN module is required. Moreover, the PC on which the »EASY Starter« is installed must be wireless-enabled.





Details

The following instructions describe the connection establishment via the USB module.

- Parameterising without motor operation does not require a mains voltage: If you connect the inverter directly to the PC without a hub, The USB interface of the PC is sufficient for the voltage supply.
- Instructions for the connection establishment via the WLAN module can be found in the chapter "Wireless LAN (WLAN)". [196](#)

How to establish a communication to the inverter via USB:

Preconditions for commissioning:

- The functional test described in the mounting and switch-on instructions has been completed successfully (without any errors or faults).
- The inverter is ready for operation (mains voltage is switched on).

Accessories required for commissioning:

- USB module
- USB 2.0 cable (A-plug on micro B-plug)
- PC with installed »EASY Starter« software

1. Plug the USB module onto the front of the inverter (interface X16).
2. Use a USB cable to connect the inverter to the PC on which »EASY Starter« is installed:
 - a) Plug the micro B plug of the USB cable into the socket of the USB module.
 - b) Plug the other end into a free USB type A-socket of the PC.

3. Start »EASY Starter«.

The "Add devices" dialog is shown.

4. Select the "USB - USB via adapter i5MADU0000000S" connection:

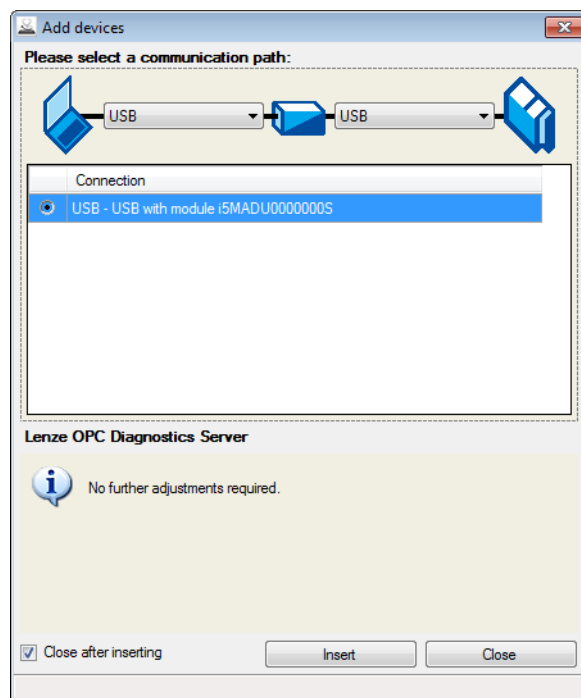

5. Click the **Insert** button.

»EASY Starter« searches for connected devices via the communication path selected. When the connection has been established successfully, the inverter is displayed in the device list of »EASY Starter«. The inverter parameters can now be accessed via the tabs of »EASY Starter«.

Commissioning

Parameter setting
Engineering tool »EASY Starter«



4.3 Parameter setting

As a part of a machine with a speed-variable drive system, the inverter must be adapted to its drive task. The adaptation process of the inverter is carried out by changing parameters. Optionally these parameters can be accessed by means of the keypad or »EASY Starter«. If the inverter is provided with a network option, access can also be effected by a higher-level control via the corresponding network.



Certain device commands or settings which might cause a critical state of the drive behaviour can only be carried out when the inverter is inhibited.



4.3.1 General notes on parameters

Each parameter features a 16-bit index as address. Under this address, the parameter is stored in the object directory of the inverter.

- Parameters that belong together functionally are combined in a data set. These parameters are additionally provided with an 8-bit subindex.
- The colon is used as a separator between the index and subindex Example: "0x2540:001"
- There are parameters the setting of which can be changed, and (diagnostic) parameters which can only be read.

Parameterisation using the keypad

- All parameters which can be accessed by means of the keypad are provided with a "Display code", the first digit of the display code specifying the group in which the parameter can be found on the keypad.
- In the documentation, the display code — if available — is specified in brackets behind the address. Example: "0x2915 (P210.00)".

▶ [Keypad parameterisation mode](#) [374](#)

Structure of the parameter descriptions in this documentation

- The parameter descriptions in this documentation are structured in table form.
- The representation distinguishes parameters with a setting range, text, selection list, and bit-coded display.
- The default setting of parameters with a write access feature is shown in **bold**.
- The display code as well as the short keypad designation of the parameter which is limited to 16 characters, are — if available — shown in brackets.

Example: parameters with a setting range

Parameter	Name / value range / [default setting]	Info
Index:Subindex (display code)	Parameter designation (abbreviated keypad designation) Minimum value ... [default setting] ... maximum value • Optional information with regard to the parameter.	Explanations & notes with regard to the parameter.

Example: parameters with a selection list

Parameter	Name / value range / [default setting]	Info
Index:Subindex (display code)	Parameter designation (abbreviated keypad designation) • Optional information with regard to the parameter.	Explanations & notes with regard to the parameter. Note: The corresponding selection number (here 0, 1, or 2) must be set. Other values are not permissible.
	0 Designation of selection 0	Optionally: Explanations & notes with regard to the corresponding selection.
	1 Designation of selection 1	The default selection is shown in bold .
	2 Designation of selection 2	

Example: parameters with a bit-coded display

Parameter	Name / value range / [default setting]	Info
Index:Subindex (display code)	Parameter designation (abbreviated keypad designation) • Optional information with regard to the parameter.	Explanations & notes with regard to the parameter.
	Bit 0 Designation of bit 0	Optionally: Explanations & notes with regard to the corresponding bit.
	Bit 1 Designation of bit 1	
	Bit 2 Designation of bit 2	
	
	Bit 15 Designation of bit 15	

Parameter overview lists in this documentation

- [Keypad parameter list](#): for the parameterisation using the keypad, contains a list of all parameters which can also be accessed by means of the keypad. [41](#)
- [Parameter attribute list](#): contains a list of all inverter parameters. This list in particular includes some information that is relevant for the reading and writing of parameters via the network. [388](#)

Commissioning

Parameter setting
Basic inverter settings



4.3.2 Basic inverter settings

Check the following basic settings of the inverter and adapt them, if required.

Parameter	Name / value range / [default setting]	Info
0x2540:001 (P208.01)	Mains settings: Rated mains voltage (Mains settings: Mains voltage) • Setting can only be changed if the inverter is inhibited.	Selection of the mains voltage for actuating the inverter.
	0 230 Veff	
	1 400 Veff	
	2 480 Veff	
0x2838:001 (P203.01)	Start/stop configuration: Start method (Start/stop cfg: Start method) • Setting can only be changed if the inverter is inhibited.	Behaviour after start command.
	0 Normal	After start command, the standard ramps are active. • Acceleration time 1 can be set in 0x2917 (P220.00) . • Deceleration time 1 can be set in 0x2918 (P221.00) .
	1 DC braking	After start command, the "DC braking" function is active for the time set in 0x2B84:002 (P704.02) . ▶ DC braking □ 224
	2 Flying restart circuit	After the start command, the flying restart circuit is active. The flying restart function makes it possible to restart a coasting motor during operation without speed feedback. Synchronicity between the inverter and motor is coordinated so that the transition to the rotating motor is effected without jerk at the time of connection. ▶ Flying restart circuit □ 278
0x2838:002 (P203.02)	Start/stop configuration: Start at power-up (Start/stop cfg: Start at powerup)	Starting performance after switching on the mains voltage.
	0 Off	No automatic start after switching on mains voltage. In addition to the inverter enable, a renewed start command is always required to start the motor.
	1 On	Automatic start of the motor after switching on the mains voltage if the inverter is enabled and a start command exists.
0x2838:003 (P203.03)	Start/stop configuration: Stop method (Start/stop cfg: Stop method)	Behaviour after the "Stop" command.
	0 Coasting	The motor becomes torqueless (coasts down to standstill).
	1 Standard ramp	The motor is brought to a standstill with deceleration time 1 (or deceleration time 2, if activated). • Deceleration time 1 can be set in 0x2918 (P221.00) . • Deceleration time 2 can be set in 0x291A (P223.00) . ▶ Frequency limits and ramp times □ 92
	2 Quick stop ramp	The motor is brought to a standstill with the deceleration time set for the "Quick stop" function. • Deceleration time for quick stop can be set in 0x291C (P225.00) . • The "quick stop" function can also be activated manually, for instance via a digital input. ▶ Quick stop □ 95
0x283A (P304.00)	Limitation of rotation (Limit. rotation)	Optional restriction of the rotating direction.
	0 Only clockwise (CW)	The motor can only be rotated clockwise (CW). The transfer of negative frequency and PID setpoints to the motor control is prevented. • This function takes effect after the "Invert rotation" function (0x2631:013 (P400.13)). • Since this function only prevents negative setpoints, counter-clockwise rotation (CCW) is possible if the motor has been wired for this rotating direction.
	1 Both rotation directions	Both directions of motor rotation are enabled.



Commissioning

Parameter setting Basic inverter settings

Parameter	Name / value range / [default setting]	Info
0x2860:001 (P201.01)	Frequency control: Default setpoint source (Std. setpoints: Freq. setp. src.)	Selection of the standard setpoint source for operating mode "MS: Velocity mode". <ul style="list-style-type: none"> The selected standard setpoint source is always active in the operating mode 0x6060 (P301.00) = "MS: Velocity mode [-2]" when no setpoint change-over to another setpoint source via corresponding triggers/functions is active. ▶ Setpoint change-over □ 313
	1 Keypad	The setpoint is specified locally by the keypad. <ul style="list-style-type: none"> Default setting: 0x2601:001 (P202.01) Use the ↑ and ↓ navigation keys to change the keypad setpoint (also during running operation).
	2 Analog input 1	The setpoint is specified analogously via X3/AI1. <ul style="list-style-type: none"> ▶ Analog input 1 □ 349
	3 Analog input 2	The setpoint is specified analogously via X3/AI2. <ul style="list-style-type: none"> ▶ Analog input 2 □ 353
	5 Network	The setpoint is specified via network. <ul style="list-style-type: none"> ▶ Configuring the network □ 136
	11 Frequency preset 1	For the setpoint selection, preset values can be parameterised and selected. <ul style="list-style-type: none"> ▶ Setpoint source of preset setpoints □ 320
	12 Frequency preset 2	
	13 Frequency preset 3	
	14 Frequency preset 4	
	15 Frequency preset 5	
	16 Frequency preset 6	
	17 Frequency preset 7	
	18 Frequency preset 8	
	19 Frequency preset 9	
	20 Frequency preset 10	
	21 Frequency preset 11	
	22 Frequency preset 12	
23 Frequency preset 13		
24 Frequency preset 14		
25 Frequency preset 15		
50 Motor potentiometer	The setpoint is generated by the "Motor potentiometer" function. <ul style="list-style-type: none"> ▶ Motor potentiometer setpoint source (MOP) □ 325 	
0x2911:001 (P450.01)	Frequency setpoint presets: Preset 1 (Freq. presets: Freq. preset 1) 0.0 ... [20.0] ... 599.0 Hz	Parameterisable frequency setpoints (presets) for operating mode "MS: Velocity mode".
0x2911:002 (P450.02)	Frequency setpoint presets: Preset 2 (Freq. presets: Freq. preset 2) 0.0 ... [40.0] ... 599.0 Hz	
0x2911:003 (P450.03)	Frequency setpoint presets: Preset 3 (Freq. presets: Freq. preset 3) 0.0 ... [50.0] ... 599.0 Hz	
0x2915 (P210.00)	Minimum frequency (Min. frequency) 0.0 ... [0.0] ... 599.0 Hz	Lower limit value for all frequency setpoints.
0x2916 (P211.00)	Maximum frequency (Max. frequency) 0.0 ... [50.0] ... 599.0 Hz	Upper limit value for all frequency setpoints.
0x2917 (P220.00)	Acceleration time 1 (Accelerat.time 1) 0.0 ... [5.0] ... 3600.0 s	Acceleration time 1 for the operating mode "MS: Velocity mode". <ul style="list-style-type: none"> The acceleration time set refers to the acceleration from standstill to the maximum frequency set. In the case of a lower setpoint selection, the actual acceleration time is reduced accordingly. Setting is not effective in the operating mode 0x6060 (P301.00) = "CiA: Velocity mode [2]". ▶ Device profile CiA 402 □ 262

Commissioning

Parameter setting
Basic motor settings



Parameter	Name / value range / [default setting]	Info
0x2918 (P221.00)	Deceleration time 1 (Decelerat.time 1) 0.0 ... [5.0] ... 3600.0 s	Deceleration time 1 for the operating mode "MS: Velocity mode". <ul style="list-style-type: none"> The deceleration time set refers to the deceleration from the maximum frequency set to standstill. In the case of a lower actual frequency, the actual deceleration time is reduced accordingly. Setting is not effective in the operating mode 0x6060 (P301.00) = "CiA: Velocity mode [2]". ▶ Device profile CiA 402 □ 262
0x291C (P225.00)	Quick stop deceleration time (QSP dec. time) 0.0 ... [1.0] ... 3600.0 s	Quick stop deceleration time for the operating mode "MS: Velocity mode". <ul style="list-style-type: none"> If the "Quick stop" function is activated, the motor is brought to a standstill within the deceleration time set here. The deceleration time set refers to the deceleration from the maximum frequency set to standstill. In the case of a lower actual frequency, the actual deceleration time is reduced accordingly. Setting is not effective in the operating mode 0x6060 (P301.00) = "CiA: Velocity mode [2]". ▶ Device profile CiA 402 □ 262

All possible basic settings are described in the "Basic setting" chapter. [□ 85](#)

4.3.3 Basic motor settings

Check the following default settings for the motor and motor control and adapt them, if required.

Drive behaviour by default

By default, the V/f characteristic control with a linear characteristic is preset as motor control for asynchronous motors. The V/f characteristic control is a motor control for conventional frequency inverter applications. It is based on a simple and robust control mode for the operation of asynchronous motors with a linear or square-law load torque characteristic (e.g. fan). Because of the minimal parameterisation effort, such applications can be commissioned easily and quickly.

The default settings of the parameters ensure that the inverter is ready for operation immediately and the motor works adequately without further parameterisation if an inverter and a 50 Hz asynchronous machine with matching performances are assigned to each other.

Parameter	Name / value range / [default setting]	Info
0x2B01:001 (P303.01)	V/f shape data: Base voltage (V/f shape data: Base voltage) 0 ... [230]* ... 5000 V • Default setting depending on the size.	Base voltage and base frequency define the V/f ratio and thus the gradient of the V/f characteristic. <ul style="list-style-type: none"> The V/f base voltage is usually set to the rated motor voltage 0x2C01:007 (P320.07).
0x2B01:002 (P303.02)	V/f shape data: Base frequency (V/f shape data: Base frequency) 0 ... [50]* ... 599 Hz • Default setting depending on the size.	<ul style="list-style-type: none"> The V/f base frequency is usually set to the rated motor frequency 0x2C01:005 (P320.05).
0x2C00 (P300.00)	Motor control mode (Motor ctrl mode) • Setting can only be changed if the inverter is inhibited.	Selection of the motor control type.
	3 Sensorless control (SL PSM) • From version 02.00	This control type is used for the sensorless control of a synchronous motor. ▶ Sensorless control for synchronous motors (SL-PSM) □ 112
	4 Sensorless vector control (SLVC)	This control type is used for sensorless vector control of an asynchronous motor. ▶ Sensorless vector control (SLVC) □ 110
	6 V/f characteristic control (VFC open loop)	This control mode is used for the speed control of an asynchronous motor via a V/f characteristic and is the simplest control mode. ▶ V/f characteristic control (VFC) □ 106
0x2C01:010	Motor parameters: Motor name	The name (e.g. " 1") can be freely selected by the user. If the motor in the engineering tool has been selected from the "motor catalog", the respective motor name is automatically entered here (example: "MDSKA080-22, 70").



Commissioning

Parameter setting
Basic motor settings

Parameter	Name / value range / [default setting]	Info
0x6075 (P323.00)	Motor rated current (Motor current) 0.001 ... [1.700]* ... 500.000 A <ul style="list-style-type: none">• Default setting depending on the size.• Setting can only be changed if the inverter is inhibited.	The rated motor current to be set here serves as a reference value for different parameters with a setting/display in percent. Relevant parameters: <ul style="list-style-type: none">• DC braking: Current 0x2B84:001 (P704.01)• Flying restart circuit: Current 0x2BA1:001 (P718.01)• Motor overload monitoring ($i^2 \cdot t$): Maximum utilisation [60 s] 0x2D4B:001 (P308.01)• Load loss detection: Threshold 0x4006:001 (P710.01)• Max current 0x6073 (P324.00)• Current actual value 0x6078 (P103.00)

All possible settings with regard to the motor and motor control are described in the "[Motor control](#)" chapter. [99](#)

Commissioning

Parameter setting
Function assignment of the inputs and outputs



4.3.4 Function assignment of the inputs and outputs

The inverter control can be adapted individually to the respective application. This is basically effected by assigning digital control sources ("triggers") to functions of the inverter.

By default, the inverter can be controlled via the I/O terminals as follows:

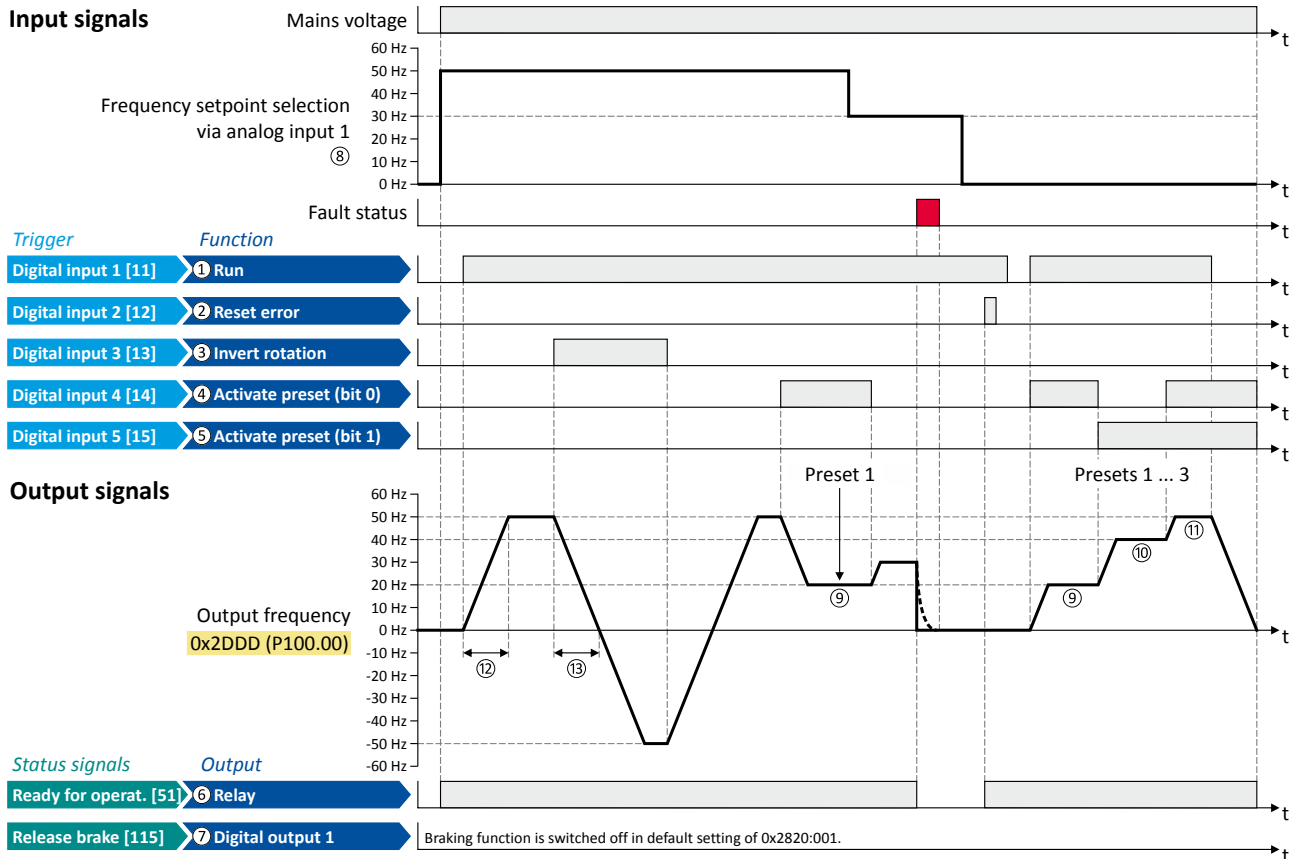

Parameter	Name	Default setting
Control functions		
① 0x2631:002 (P400.02)	Run	Digital input 1 [11]
② 0x2631:004 (P400.04)	Reset fault	Digital input 2 [12]
③ 0x2631:013 (P400.13)	Invert rotation	Digital input 3 [13]
④ 0x2631:018 (P400.18)	Activate preset (bit 0)	Digital input 4 [14]
⑤ 0x2631:019 (P400.19)	Activate preset (bit 1)	Digital input 5 [15]
Configuration of digital outputs		
⑥ 0x2634:001 (P420.01)	Relay	Ready for operation [51]
⑦ 0x2634:002 (P420.02)	Digital output 1	Release holding brake [115]
Settings for the frequency setpoint		
⑧ 0x2860:001 (P201.01)	Frequency control: Default setpoint source	Analog input 1 [2]
⑨ 0x2911:001 (P450.01)	Frequency setpoint presets: Preset 1	20 Hz
⑩ 0x2911:002 (P450.02)	Frequency setpoint presets: Preset 2	40 Hz
⑪ 0x2911:003 (P450.03)	Frequency setpoint presets: Preset 3	50 Hz
⑫ 0x2917 (P220.00)	Acceleration time 1	5.0 s
⑬ 0x2918 (P221.00)	Deceleration time 1	5.0 s



Commissioning

Parameter setting

Function assignment of the inputs and outputs

Parameter	Name / value range / [default setting]	Info
0x2631:002 (P400.02)	Function list: Run (Function list: Run) <ul style="list-style-type: none"> Setting can only be changed if the inverter is inhibited. For possible settings see description for 0x2631:001 (P400.01). □ 300 	Assignment of a trigger for the "Run" function. Function 1: Start / stop motor (default setting) Function 1 is active if no further start commands (start forward/start reverse) have been connected to triggers, no keypad control is active and no network control is active. Trigger = TRUE: Let motor rotate forward (CW). Trigger = FALSE: Stop motor. Notes to function 1: <ul style="list-style-type: none"> If "Enable inverter" 0x2631:001 (P400.01) is set = "Constant TRUE [1]", the only permissible trigger for this function is a digital input in order that the motor can be stopped again any time. The stop method can be selected in 0x2838:003 (P203.03). The function also serves to realise an automatic start after switch-on. <ul style="list-style-type: none"> ▶ Starting performance □ 91 Function 2: Start enable/stop motor Function 2 is active if further start commands have been connected to triggers, keypad control is active or network control is active. Trigger = TRUE: Start commands of the active control source are enabled. Trigger = FALSE: Stop motor. Notes to function 2: <ul style="list-style-type: none"> If no separate start enable is required for the application, the trigger "Constant TRUE [1]" must be set. The stop method can be selected in 0x2838:003 (P203.03).
	11 Digital input 1	State of X3/DI1, taking an inversion set in 0x2632:001 (P411.01) into consideration.
0x2631:003 (P400.03)	Function list: Activate quick stop (Function list: Quick stop) <ul style="list-style-type: none"> Setting can only be changed if the inverter is inhibited. For possible settings see description for 0x2631:001 (P400.01). □ 300 	Assignment of a trigger for the "Activate quick stop" function. Trigger = TRUE: Activate quick stop. Trigger = FALSE: Deactivate quick stop. Notes: <ul style="list-style-type: none"> The "Quick stop" function brings the motor to a standstill within the deceleration time set in 0x291C (P225.00).
	00 Not connected	No trigger assigned (trigger is constantly FALSE).
0x2631:004 (P400.04)	Function list: Reset fault (Function list: Reset fault) <ul style="list-style-type: none"> For possible settings see description for 0x2631:001 (P400.01). □ 300 	Assignment of a trigger for the "Reset fault" function. Trigger = FALSE → TRUE (edge): Active error is reset (acknowledged) if the error condition is not active anymore and the error is resettable. Trigger = FALSE: no action.
	12 Digital input 2	State of X3/DI2, taking an inversion set in 0x2632:002 (P411.02) into consideration.
0x2631:013 (P400.13)	Function list: Invert rotation (Function list: Invert rotation) <ul style="list-style-type: none"> Setting can only be changed if the inverter is inhibited. For possible settings see description for 0x2631:001 (P400.01). □ 300 	Assignment of a trigger for the "Invert rotation" function. Trigger = TRUE: the setpoint specified is inverted (i. e. the sign is inverted). Trigger = FALSE: no action / deactivate function again.
	13 Digital input 3	State of X3/DI3, taking an inversion set in 0x2632:003 (P411.03) into consideration.
0x2631:018 (P400.18)	Function list: Activate preset (bit 0) (Function list: Setp: Preset b0) <ul style="list-style-type: none"> For possible settings see description for 0x2631:001 (P400.01). □ 300 	Assignment of a trigger for the "Activate preset (bit 0)" function. Selection bit with the valency 20 for the bit-coded selection and activation of a parameterised setpoint (preset value). Trigger = FALSE: selection bit = "0". Trigger = TRUE: selection bit = "1".
	14 Digital input 4	State of X3/DI4, taking an inversion set in 0x2632:004 (P411.04) into consideration.
0x2631:019 (P400.19)	Function list: Activate preset (bit 1) (Function list: Setp: Preset b1) <ul style="list-style-type: none"> For possible settings see description for 0x2631:001 (P400.01). □ 300 	Assignment of a trigger for the "Activate preset (bit 1)" function. Selection bit with the valency 21 for the bit-coded selection and activation of a parameterised setpoint (preset value). Trigger = FALSE: selection bit = "0". Trigger = TRUE: selection bit = "1".
	15 Digital input 5	State of X3/DI5, taking an inversion set in 0x2632:005 (P411.05) into consideration.

Commissioning

Parameter setting

Function assignment of the inputs and outputs



Parameter	Name / value range / [default setting]	Info
0x2634:001 (P420.01)	Digital outputs function: Relay (Dig.out.function: Relay function) <ul style="list-style-type: none"> For possible settings see description for 0x2634:001 (P420.01). □ 355 	Assignment of a trigger to the relay. Trigger = FALSE: X9/NO-COM open and NC-COM closed. Trigger = TRUE: X9/NO-COM closed and NC-COM open. Notes: <ul style="list-style-type: none"> An inversion set in 0x2635:001 (P421.01) is taken into consideration here.
	51 Ready for operation	TRUE if inverter is ready for operation (no error active, no STO active and DC-bus voltage ok). Otherwise FALSE.
0x2634:002 (P420.02)	Digital outputs function: Digital output 1 (Dig.out.function: DO1 function) <ul style="list-style-type: none"> For possible settings see description for 0x2634:001 (P420.01). □ 355 	Assignment of a trigger to digital output 1. Trigger = FALSE: X3/DO1 set to LOW level. Trigger = TRUE: X3/DO1 set to HIGH level. Notes: <ul style="list-style-type: none"> An inversion set in 0x2635:002 (P421.02) is taken into consideration here.
	115 Release holding brake	Trigger signal for releasing the holding brake (TRUE = release holding brake). ▶ Holding brake control □ 266

All functional possible settings for controlling the inverter are described in the "[Flexible I/O configuration](#)" chapter. [□ 292](#)



4.4 Keypad parameter list

For commissioning or diagnostics using the keypad, all parameters of the inverter that can also be accessed by means of the keypad are listed in the following "Keypad parameter list".

- The keypad parameter list is sorted in ascending order in compliance with the "display code" (Pxxx).
- In order to provide for quick access, all parameters of the inverter are divided into different groups according to their function.
- Group 0 contains the configurable "Favorites". In the default setting these are the most common parameters for the solution of typical applications. ▶ [Favorites](#) [□ 242](#)
- Based on the hundreds digit of the display code (Pxxx) you can quickly see in which group the parameter is to be found on the keypad:

Parameter	Group - name	Description
P1xx	Group 1 - Diagnostics	Diagnostic/display parameters for displaying device-internal process factors, current actual values, and status messages. ▶ Diagnostics parameter □ 60
P2xx	Group 2 - Basic setting	Setting of the mains voltage, selection of the control and setpoint source, starting and stopping performance, frequency limits and ramp times. ▶ Basic setting □ 85
P3xx	Group 3 - Motor control	Configuration of the motor and motor control ▶ Motor control □ 99
P4xx	Group 4 - I/O setting	Function assignment and configuration of the inputs and outputs ▶ Flexible I/O configuration □ 292
P5xx	Group 5 - Network setting	Configuration of the network (if available) ▶ Configuring the network □ 136
P6xx	Group 6 - Process controller	Configuration of the process controller ▶ Configuring the process controller □ 207
P7xx	Group 7 - Additional functions	Parameterisable additional functions ▶ Additional functions □ 216



A complete overview of all parameter indexes can be found in the annex in the [Parameter attribute list](#). [□ 388](#)

Frequently used abbreviations in the short keypad designations of the parameters:

Abbreviation	Meaning
AI	Analog input
AO	Analog output
BO, B1, ...	Bit 0, bit 1, ...
CU	Control unit
DI	Digital input
DO	Digital output
LU	Undervoltage
MOP	Motor potentiometer
NET	network
OU	Overvoltage
PID	Process controller
PU	Power unit
QSP	quick stop
Setp	Setpoint
WD	Watchdog

Commissioning

Keypad parameter list



How to read the keypad parameter list:

Column	Meaning
Display code	Parameter number on the keypad. Format: Number.Subindex
Short designation	Short keypad designation limited to 16 characters.
Default setting	Default setting of the parameter.
Setting range	Possible setting range for the parameter. Format: minimum value ... maximum value [unit]
Address	Address of the parameter in the object directory. Format: Index:Subindex
Category	Functional assignment of the parameter, for example "motor control" or "CANopen".

Keypad parameter list (short overview of all parameters with display code)

Display code	Short designation	Default setting	Setting range	Address	Category
P100.00	Output frequency	x.x Hz	- (Read only)	0x2DDD	general
P101.00	Scaled act value	x Units	- (Read only)	0x400D	general
P102.00	Freq. setpoint	x.x Hz	- (Read only)	0x2B0E	general
P103.00	Current actual	x.x %	- (Read only)	0x6078	general
P104.00	Motor current	x.x A	- (Read only)	0x2D88	general
P105.00	DC-bus voltage	x V	- (Read only)	0x2D87	general
P106.00	Motor voltage	x VAC	- (Read only)	0x2D89	general
P107.00	Torque actual	x.x %	- (Read only)	0x6077	general
P108.xx	Output power				
└ P108.01	Effective power	x.xxx kW	- (Read only)	0x2DA2:001	general
└ P108.02	Apparent power	x.xxx kVA	- (Read only)	0x2DA2:002	general
P109.xx	Output energy				
└ P109.01	Motor	x.xx kWh	- (Read only)	0x2DA3:001	general
└ P109.02	Generator	x.xx kWh	- (Read only)	0x2DA3:002	general
P110.xx	AI1 diagnostics				
└ P110.01	AI1 terminal %	x.x %	- (Read only)	0x2DA4:001	general
└ P110.02	AI1 scaled freq.	x.x Hz	- (Read only)	0x2DA4:002	general
└ P110.03	AI1 scaled PID	x.xx PID unit	- (Read only)	0x2DA4:003	general
└ P110.04	AI1 scaled torq.	x.xx %	- (Read only)	0x2DA4:004	general
└ P110.16	AI1 status	-	- (Read only)	0x2DA4:016	general
P111.xx	AI2 diagnostics				
└ P111.01	AI2 terminal %	x.x %	- (Read only)	0x2DA5:001	general
└ P111.02	AI2 scaled freq.	x.x Hz	- (Read only)	0x2DA5:002	general
└ P111.03	AI2 scaled PID	x.xx PID unit	- (Read only)	0x2DA5:003	general
└ P111.04	AI2 scaled torq.	x.xx %	- (Read only)	0x2DA5:004	general
└ P111.16	AI2 status	-	- (Read only)	0x2DA5:016	general
P112.xx	AO1 diagnostics				
└ P112.01	AO1 Voltage	x.xx V	- (Read only)	0x2DAA:001	general
└ P112.02	AO1 Current	x.xx mA	- (Read only)	0x2DAA:002	general
P117.xx	Heatsink temp.				
└ P117.01	Heatsink temp.	x.x °C	- (Read only)	0x2D84:001	general
P118.00	Digital inputs	-	- (Read only)	0x60FD	general
P119.00	Keypad status	-	- (Read only)	0x2DAC	general
P120.00	Int. HW states	-	- (Read only)	0x2DAD	general
P121.xx	PID diagnostics				
└ P121.01	PID setpoint	x.xx PID unit	- (Read only)	0x401F:001	general
└ P121.02	PID process var.	x.xx PID unit	- (Read only)	0x401F:002	general
└ P121.03	PID status	-	- (Read only)	0x401F:003	general
P123.00	Mot. i2t utilis.	x %	- (Read only)	0x2D4F	general
P125.xx	Inverter diag.				
└ P125.01	Active control	-	- (Read only)	0x282B:001	general
└ P125.02	Active setpoint	-	- (Read only)	0x282B:002	general

* Default setting depending on the size.

Firmware version 02.01.01.00



Commissioning

Keypad parameter list

Display code	Short designation	Default setting	Setting range	Address	Category
↳ P125.03	Keypad LCD stat.	-	- (Read only)	0x282B:003	general
↳ P125.04	Drive mode	-	- (Read only)	0x282B:004	general
↳ P125.05	Netw. contr.reg.	-	- (Read only)	0x282B:005	general
↳ P125.06	Netw. setp.reg.	-	- (Read only)	0x282B:006	general
P126.xx	Status words				
↳ P126.01	Cause of disable	-	- (Read only)	0x282A:001	general
↳ P126.02	Cause of QSP	-	- (Read only)	0x282A:002	general
↳ P126.03	Cause of stop	-	- (Read only)	0x282A:003	general
↳ P126.05	Device status	-	- (Read only)	0x282A:005	general
P135.xx	Device utilisat.				
↳ P135.04	ixt utilisation	x %	- (Read only)	0x2D40:004	general
↳ P135.05	Error response	Fault [3]	Selection list	0x2D40:005	general
P150.00	Error code	-	- (Read only)	0x603F	general
P151.xx	Life-diagnosis				
↳ P151.01	Operating time	x s	- (Read only)	0x2D81:001	general
↳ P151.02	Operating time	x s	- (Read only)	0x2D81:002	general
↳ P151.03	CU oper. time	x ns	- (Read only)	0x2D81:003	general
↳ P151.04	Switching cycles	-	- (Read only)	0x2D81:004	general
↳ P151.05	Relay cycles	-	- (Read only)	0x2D81:005	general
↳ P151.06	Short-circ.count	-	- (Read only)	0x2D81:006	general
↳ P151.07	Earthfault count	-	- (Read only)	0x2D81:007	general
↳ P151.08	Clamp active	-	- (Read only)	0x2D81:008	general
↳ P151.09	Fan oper. time	x s	- (Read only)	0x2D81:009	general
P155.xx	Fault memory				
↳ P155.00	Error memory	-	- (Read only)	0x2006:000	general
P190.xx					
↳ P190.01	Product code	-	- (Read only)	0x2000:001	general
↳ P190.02	Serial number	-	- (Read only)	0x2000:002	general
↳ P190.04	CU firmware ver.	-	- (Read only)	0x2000:004	general
↳ P190.05	CU firmware type	-	- (Read only)	0x2000:005	general
↳ P190.06	CU bootldr ver.	-	- (Read only)	0x2000:006	general
↳ P190.07	CU bootldr type	-	- (Read only)	0x2000:007	general
↳ P190.08	OBD version	-	- (Read only)	0x2000:008	general
↳ P190.10	PU firmware ver.	-	- (Read only)	0x2000:010	general
↳ P190.11	PU firmware type	-	- (Read only)	0x2000:011	general
↳ P190.12	PU bootldr ver.	-	- (Read only)	0x2000:012	general
↳ P190.13	PU bootldr type	-	- (Read only)	0x2000:013	general
P191.00	Device name	My Device	Text	0x2001	general
P197.00	Protect. status	-	- (Read only)	0x2040	general
P198.00	Status load. par	-	- (Read only)	0x2827	general
P200.00	Control select.	Flexible I/O [0]	Selection list	0x2824	general
P201.xx	Stnd. setpoints				
↳ P201.01	Freq. setp. src.	Analog input 1 [2]	Selection list	0x2860:001	general
↳ P201.02	PID setp. src.	Keypad [1]	Selection list	0x2860:002	general
P202.xx	Keypad setpoints				
↳ P202.01	KP freq.setpoint	20.0 Hz	0.0 ... 599.0 Hz	0x2601:001	general
↳ P202.02	KP PID setpoint	0.00 PID unit	-300.00 ... 300.00 PID unit	0x2601:002	general
P203.xx	Start/stop cfg				
↳ P203.01	Start method	Normal [0]	Selection list	0x2838:001	general
↳ P203.02	Start at powerup	Off [0]	Selection list	0x2838:002	general
↳ P203.03	Stop method	Standard ramp [1]	Selection list	0x2838:003	general
P208.xx	Mains settings				
↳ P208.01	Mains voltage	230 Veff [0]	Selection list	0x2540:001	general
↳ P208.02	LU warn. thresh.	0 V *	0 ... 800 V	0x2540:002	general

* Default setting depending on the size.

Firmware version 02.01.01.00

Commissioning

Keypad parameter list



Display code	Short designation	Default setting	Setting range	Address	Category
↳ P208.03	LU error thresh.	x V	- (Read only)	0x2540:003	general
↳ P208.04	LU reset thresh.	x V	- (Read only)	0x2540:004	general
↳ P208.05	OU warn. thresh.	0 V *	0 ... 800 V	0x2540:005	general
↳ P208.06	OU error thresh.	x V	- (Read only)	0x2540:006	general
↳ P208.07	OU reset thresh.	x V	- (Read only)	0x2540:007	general
P210.00	Min. frequency	0.0 Hz	0.0 ... 599.0 Hz	0x2915	general
P211.00	Max. frequency	50.0 Hz	0.0 ... 599.0 Hz	0x2916	general
P220.00	Accelerat.time 1	5.0 s	0.0 ... 3600.0 s	0x2917	general
P221.00	Decelerat.time 1	5.0 s	0.0 ... 3600.0 s	0x2918	general
P222.00	Accelerat.time 2	5.0 s	0.0 ... 3600.0 s	0x2919	general
P223.00	Decelerat.time 2	5.0 s	0.0 ... 3600.0 s	0x291A	general
P224.00	Ramp 2 thresh.	0.0 Hz	0.0 ... 599.0 Hz	0x291B	general
P225.00	QSP dec. time	1.0 s	0.0 ... 3600.0 s	0x291C	general
P226.xx	S-ramp char.				
↳ P226.01	Smoothing factor	0.0 %	0.0 ... 100.0 %	0x291E:001	general
P230.xx	Optical tracking				
↳ P230.01	Start detection	Stop [0]	Selection list	0x2021:001	general
↳ P230.02	Blink. duration	5 s	0 ... 3600 s	0x2021:002	general
P300.00	Motor ctrl mode	VFC open loop [6]	Selection list	0x2C00	general
P301.00	Modes of op.	MS: Velocitymode [-2]	Selection list	0x6060	general
P302.00	V/f charac.shape	Linear [0]	Selection list	0x2B00	general
P303.xx	V/f shape data				
↳ P303.01	Base voltage	230 V *	0 ... 5000 V	0x2B01:001	MCTRL
↳ P303.02	Base frequency	50 Hz *	0 ... 599 Hz	0x2B01:002	MCTRL
P304.00	Limit. rotation	Both directions [1]	Selection list	0x283A	general
P305.00	Switching freq.	8kHz var/opt/4 [21]	Selection list	0x2939	general
P308.xx	Motor overload				
↳ P308.01	Max.load.for 60s	150 %	30 ... 200 %	0x2D4B:001	general
↳ P308.02	Speed comp.	On [0]	Selection list	0x2D4B:002	general
↳ P308.03	Response	Fault [3]	Selection list	0x2D4B:003	general
P310.xx	Mot.phase.fail.				
↳ P310.01	Response	No response [0]	Selection list	0x2D45:001	general
↳ P310.02	Current thresh.	5.0 %	1.0 ... 10.0 %	0x2D45:002	general
↳ P310.03	Voltage thresh.	10.0 V	0.0 ... 100.0 V	0x2D45:003	general
P315.xx	Slip compens.				
↳ P315.01	Slip: gain	100.00 %	-200.00 ... 200.00 %	0x2B09:001	general
↳ P315.02	Filter time	5 ms	1 ... 6000 ms	0x2B09:002	general
P316.xx	V/f boosts				
↳ P316.01	Fixed V/f boost	2.5 % *	0.0 ... 20.0 %	0x2B12:001	general
↳ P316.02	Dynam. V/f boost	0.0 %	0.0 ... 20.0 %	0x2B12:002	general
P317.xx	Skip frequencies				
↳ P317.01	Skip frequency 1	0.0 Hz	0.0 ... 599.0 Hz	0x291F:001	general
↳ P317.02	Skip bandwidth 1	0.0 Hz	0.0 ... 10.0 Hz	0x291F:002	general
↳ P317.03	Skip frequency 2	0.0 Hz	0.0 ... 599.0 Hz	0x291F:003	general
↳ P317.04	Skip bandwidth 2	0.0 Hz	0.0 ... 10.0 Hz	0x291F:004	general
↳ P317.05	Skip frequency 3	0.0 Hz	0.0 ... 599.0 Hz	0x291F:005	general
↳ P317.06	Skip bandwidth 3	0.0 Hz	0.0 ... 10.0 Hz	0x291F:006	general
P318.xx	Oscillat. damp.				
↳ P318.01	Gain	20 %	-100 ... 100 %	0x2B0A:001	MCTRL
↳ P318.02	Filter time	5 ms	1 ... 600 ms	0x2B0A:002	MCTRL
P319.00	Field weak thold	0.0 Hz	-599.0 ... 599.0 Hz	0x2B0C	general
P320.xx	Motor parameters				
↳ P320.04	Rated speed	1450 rpm	50 ... 50000 rpm	0x2C01:004	MCTRL
↳ P320.05	Rated frequency	50.0 Hz	1.0 ... 1000.0 Hz	0x2C01:005	MCTRL

* Default setting depending on the size.

Firmware version 02.01.01.00



Commissioning

Keypad parameter list

Display code	Short designation	Default setting	Setting range	Address	Category
↳ P320.06	Rated power	0.25 kW *	0.00 ... 655.35 kW	0x2C01:006	MCTRL
↳ P320.07	Rated voltage	230 V *	0 ... 65535 V	0x2C01:007	MCTRL
↳ P320.08	Cosine phi	0.80	0.00 ... 1.00	0x2C01:008	MCTRL
P322.00	Max motor speed	6075 rpm	0 ... 480000 rpm	0x6080	general
P323.00	Motor current	1.700 A *	0.001 ... 500.000 A	0x6075	MCTRL
P324.00	Max current	200.0 %	0.0 ... 3000.0 %	0x6073	general
P325.00	Motor torque	1.650 Nm *	0.001 ... 1000.000 Nm	0x6076	MCTRL
P326.00	Max torque	250.0 %	0.0 ... 3000.0 %	0x6072	general
P327.xx	Axis commands				
↳ P327.04	Identify mot.	0	0 ... 1	0x2822:004	general
↳ P327.05	Calibrate mot.	0	0 ... 1	0x2822:005	general
P329.xx	MaxTrq.Monitor				
↳ P329.01	Response	No reaction [0]	Selection list	0x2D67:001	MCTRL
↳ P329.02	Triggering delay	0.000 s	0.000 ... 10.000 s	0x2D67:002	MCTRL
P330.xx					
↳ P330.01	Min. voltage	20 %	20 ... 100 %	0x2B0D:001	MCTRL
P332.xx	Speed controller				
↳ P332.01	Gain	0.00193 Nm/rpm *	0.00000 ... 20000.00000 Nm/rpm	0x2900:001	MCTRL
↳ P332.02	Reset time	80.0 ms *	1.0 ... 6000.0 ms	0x2900:002	MCTRL
P333.xx	V/f Imax contr.				
↳ P333.01	Gain	0.284 Hz/A *	0.000 ... 1000.000 Hz/A	0x2B08:001	MCTRL
↳ P333.02	Reset time	2.3 ms *	1.0 ... 2000.0 ms	0x2B08:002	MCTRL
P334.xx	Current contr.				
↳ P334.01	Gain	42.55 V/A *	0.00 ... 750.00 V/A	0x2942:001	MCTRL
↳ P334.02	Reset time	4.50 ms *	0.01 ... 2000.00 ms	0x2942:002	MCTRL
P335.xx	Moment of inert.				
↳ P335.01	Motor inertia	3.70 kg cm² *	0.00 ... 20000000.00 kg cm ²	0x2910:001	MCTRL
↳ P335.02	Load inertia	3.70 kg cm² *	0.00 ... 20000000.00 kg cm ²	0x2910:002	MCTRL
P350.xx	Overspeed monit.				
↳ P350.01	Threshold	8000 rpm	50 ... 50000 rpm	0x2D44:001	general
↳ P350.02	Response	Fault [3]	Selection list	0x2D44:002	general
P351.xx	ASM motor par.				
↳ P351.01	Rotor resistance	8.8944 Ω *	0.0000 ... 200.0000 Ω	0x2C02:001	MCTRL
↳ P351.02	Mutual induct.	381.9 mH *	0.0 ... 50000.0 mH	0x2C02:002	MCTRL
↳ P351.03	Magn. current	0.96 A *	0.00 ... 500.00 A	0x2C02:003	MCTRL
↳ P351.04	Slip frequency	x.x Hz	- (Read only)	0x2C02:004	general
P352.xx					
↳ P352.01	EMK constant	41.8 V/1000rpm	0.0 ... 100000.0 V/1000rpm	0x2C03:001	MCTRL
P353.xx	Overcurr. monit.				
↳ P353.01	Threshold	6.8 A *	0.0 ... 1000.0 A	0x2D46:001	general
↳ P353.02	Response	Fault [3]	Selection list	0x2D46:002	general
P400.xx	Function list				
↳ P400.01	Enable inverter	TRUE [1]	Selection list	0x2631:001	general
↳ P400.02	Run	Digital input 1 [11]	Selection list	0x2631:002	general
↳ P400.03	Quick stop	Not connected [0]	Selection list	0x2631:003	general
↳ P400.04	Reset fault	Digital input 2 [12]	Selection list	0x2631:004	general
↳ P400.05	DC braking	Not connected [0]	Selection list	0x2631:005	general
↳ P400.06	Start forward	Not connected [0]	Selection list	0x2631:006	general
↳ P400.07	Start reverse	Not connected [0]	Selection list	0x2631:007	general
↳ P400.08	Run forward	Not connected [0]	Selection list	0x2631:008	general
↳ P400.09	Run reverse	Not connected [0]	Selection list	0x2631:009	general
↳ P400.10	Jog forward	Not connected [0]	Selection list	0x2631:010	general
↳ P400.11	Jog reverse	Not connected [0]	Selection list	0x2631:011	general

* Default setting depending on the size.

Firmware version 02.01.01.00

Commissioning

Keypad parameter list



Display code	Short designation	Default setting	Setting range	Address	Category
L P400.12	Keypad control	Not connected [0]	Selection list	0x2631:012	general
L P400.13	Invert rotation	Digital input 3 [13]	Selection list	0x2631:013	general
L P400.14	Setp: AI1	Not connected [0]	Selection list	0x2631:014	general
L P400.15	Setp: AI2	Not connected [0]	Selection list	0x2631:015	general
L P400.16	Setp: Keypad	Not connected [0]	Selection list	0x2631:016	general
L P400.18	Setp: Preset b0	Digital input 4 [14]	Selection list	0x2631:018	general
L P400.19	Setp: Preset b1	Digital input 5 [15]	Selection list	0x2631:019	general
L P400.20	Setp: Preset b2	Not connected [0]	Selection list	0x2631:020	general
L P400.21	Setp: Preset b3	Not connected [0]	Selection list	0x2631:021	general
L P400.23	MOP up	Not connected [0]	Selection list	0x2631:023	general
L P400.24	MOP down	Not connected [0]	Selection list	0x2631:024	general
L P400.25	Setp: MOP	Not connected [0]	Selection list	0x2631:025	general
L P400.37	Network control	Not connected [0]	Selection list	0x2631:037	general
L P400.39	Activ. ramp 2	Not connected [0]	Selection list	0x2631:039	general
L P400.40	Load param.set	Not connected [0]	Selection list	0x2631:040	general
L P400.41	Sel. paramset b0	Not connected [0]	Selection list	0x2631:041	general
L P400.42	Sel. paramset b1	Not connected [0]	Selection list	0x2631:042	general
L P400.43	Fault 1	Not connected [0]	Selection list	0x2631:043	general
L P400.44	Fault 2	Not connected [0]	Selection list	0x2631:044	general
L P400.45	PID off	Not connected [0]	Selection list	0x2631:045	general
L P400.46	PID output=0	Not connected [0]	Selection list	0x2631:046	general
L P400.47	PID-I inhibited	Not connected [0]	Selection list	0x2631:047	general
L P400.48	PID-Inf ramp on	TRUE [1]	Selection list	0x2631:048	general
L P400.49	Release brake	Not connected [0]	Selection list	0x2631:049	general
P410.xx	DI settings				
L P410.02	Input function	Digital Input [0]	Selection list	0x2630:002	general
P411.xx	DI inversion				
L P411.01	DI1 inversion	Not inverted [0]	Selection list	0x2632:001	general
L P411.02	DI2 inversion	Not inverted [0]	Selection list	0x2632:002	general
L P411.03	DI3 inversion	Not inverted [0]	Selection list	0x2632:003	general
L P411.04	DI4 inversion	Not inverted [0]	Selection list	0x2632:004	general
L P411.05	DI5 inversion	Not inverted [0]	Selection list	0x2632:005	general
P412.00	Freq. threshold	0.0 Hz	0.0 ... 599.0 Hz	0x4005	general
P413.00	MOP startmode	Last value [0]	Selection list	0x4003	general
P414.xx	MOP start value				
L P414.01	Frequency	0.0 Hz	0.0 ... 599.0 Hz	0x4004:001	general
L P414.02	PID value	0.00 PID unit	-300.00 ... 300.00 PID unit	0x4004:002	general
L P414.03	Torque	0.0 %	0.0 ... 1000.0 %	0x4004:003	general
P420.xx	Dig.out.function				
L P420.01	Relay function	Rdy for operat. [51]	Selection list	0x2634:001	general
L P420.02	DO1 function	Release brake [115]	Selection list	0x2634:002	general
L P420.10	NetWordOUT1.00	Rdy for operat. [51]	Selection list	0x2634:010	general
L P420.11	NetWordOUT1.01	Not connected [0]	Selection list	0x2634:011	general
L P420.12	NetWordOUT1.02	Operat. enabled [52]	Selection list	0x2634:012	general
L P420.13	NetWordOUT1.03	Error [56]	Selection list	0x2634:013	general
L P420.14	NetWordOUT1.04	Not connected [0]	Selection list	0x2634:014	general
L P420.15	NetWordOUT1.05	Quick stop [54]	Selection list	0x2634:015	general
L P420.16	NetWordOUT1.06	Running [50]	Selection list	0x2634:016	general
L P420.17	NetWordOUT1.07	Device warning [58]	Selection list	0x2634:017	general
L P420.18	NetWordOUT1.08	Not connected [0]	Selection list	0x2634:018	general
L P420.19	NetWordOUT1.09	Not connected [0]	Selection list	0x2634:019	general
L P420.20	NetWordOUT1.10	Speed - setp=act [72]	Selection list	0x2634:020	general
L P420.21	NetWordOUT1.11	At current limit [78]	Selection list	0x2634:021	general
L P420.22	NetWordOUT1.12	Actual speed=0 [71]	Selection list	0x2634:022	general

* Default setting depending on the size.

Firmware version 02.01.01.00



Commissioning

Keypad parameter list

Display code	Short designation	Default setting	Setting range	Address	Category
L P420.23	NetWordOUT1.13	Rot.dir.reversed [69]	Selection list	0x2634:023	general
L P420.24	NetWordOUT1.14	Release brake [115]	Selection list	0x2634:024	general
L P420.25	NetWordOUT1.15	Safe Torque Off [55]	Selection list	0x2634:025	general
P421.xx	DO inversion				
L P421.01	Relay inverted	Not inverted [0]	Selection list	0x2635:001	general
L P421.02	DO1 inversion	Not inverted [0]	Selection list	0x2635:002	general
P430.xx	Analog input 1				
L P430.01	AI1 input range	0 ... 10 VDC [0]	Selection list	0x2636:001	general
L P430.02	AI1 freq @ min	0.0 Hz	-1000.0 ... 1000.0 Hz	0x2636:002	general
L P430.03	AI1 freq @ max	50.0 Hz	-1000.0 ... 1000.0 Hz	0x2636:003	general
L P430.04	AI1 PID @ min	0.00 PID unit/%	-300.00 ... 300.00 PID unit/%	0x2636:004	general
L P430.05	AI1 PID @ max	100.00 PID unit/%	-300.00 ... 300.00 PID unit/%	0x2636:005	general
L P430.06	AI1 filter time	10 ms	0 ... 10000 ms	0x2636:006	general
L P430.07	AI1 dead band	0.0 %	0.0 ... 100.0 %	0x2636:007	general
L P430.08	AI1 monit.level	0.0 %	-100.0 ... 100.0 %	0x2636:008	general
L P430.09	AI1 monit.cond.	IN < threshold [0]	Selection list	0x2636:009	general
L P430.10	AI1 error resp.	Fault [3]	Selection list	0x2636:010	general
P431.xx	Analog input 2				
L P431.01	AI2 input range	0 ... 10 VDC [0]	Selection list	0x2637:001	general
L P431.02	AI2 freq @ min	0.0 Hz	-1000.0 ... 1000.0 Hz	0x2637:002	general
L P431.03	AI2 freq @ max	50.0 Hz	-1000.0 ... 1000.0 Hz	0x2637:003	general
L P431.04	AI2 PID @ min	0.00 PID unit/%	-300.00 ... 300.00 PID unit/%	0x2637:004	general
L P431.05	AI2 PID @ max	100.00 PID unit/%	-300.00 ... 300.00 PID unit/%	0x2637:005	general
L P431.06	AI2 filter time	10 ms	0 ... 10000 ms	0x2637:006	general
L P431.07	AI2 dead band	0.0 %	0.0 ... 100.0 %	0x2637:007	general
L P431.08	AI2 monit.level	0.0 %	-100.0 ... 100.0 %	0x2637:008	general
L P431.09	AI2 error resp.	IN < threshold [0]	Selection list	0x2637:009	general
L P431.10	AI2 error resp.	Fault [3]	Selection list	0x2637:010	general
P440.xx	Analog output 1				
L P440.01	AO1 outp. range	0 ... 10 VDC [1]	Selection list	0x2639:001	general
L P440.02	AO1 function	Outp. frequency [1]	Selection list	0x2639:002	general
L P440.03	AO1 min. signal	0	-2147483648 ... 2147483647	0x2639:003	general
L P440.04	AO1 max. signal	1000	-2147483648 ... 2147483647	0x2639:004	general
P450.xx	Freq. presets				
L P450.01	Freq. preset 1	20.0 Hz	0.0 ... 599.0 Hz	0x2911:001	general
L P450.02	Freq. preset 2	40.0 Hz	0.0 ... 599.0 Hz	0x2911:002	general
L P450.03	Freq. preset 3	50.0 Hz	0.0 ... 599.0 Hz	0x2911:003	general
L P450.04	Freq. preset 4	0.0 Hz	0.0 ... 599.0 Hz	0x2911:004	general
L P450.05	Freq. preset 5	0.0 Hz	0.0 ... 599.0 Hz	0x2911:005	general
L P450.06	Freq. preset 6	0.0 Hz	0.0 ... 599.0 Hz	0x2911:006	general
L P450.07	Freq. preset 7	0.0 Hz	0.0 ... 599.0 Hz	0x2911:007	general
L P450.08	Freq. preset 8	0.0 Hz	0.0 ... 599.0 Hz	0x2911:008	general
L P450.09	Freq. preset 9	0.0 Hz	0.0 ... 599.0 Hz	0x2911:009	general
L P450.10	Freq. preset 10	0.0 Hz	0.0 ... 599.0 Hz	0x2911:010	general
L P450.11	Freq. preset 11	0.0 Hz	0.0 ... 599.0 Hz	0x2911:011	general
L P450.12	Freq. preset 12	0.0 Hz	0.0 ... 599.0 Hz	0x2911:012	general
L P450.13	Freq. preset 13	0.0 Hz	0.0 ... 599.0 Hz	0x2911:013	general
L P450.14	Freq. preset 14	0.0 Hz	0.0 ... 599.0 Hz	0x2911:014	general
L P450.15	Freq. preset 15	0.0 Hz	0.0 ... 599.0 Hz	0x2911:015	general
P451.xx	PID presets				
L P451.01	PID preset 1	0.00 PID unit	-300.00 ... 300.00 PID unit	0x4022:001	general
L P451.02	PID preset 2	0.00 PID unit	-300.00 ... 300.00 PID unit	0x4022:002	general
L P451.03	PID preset 3	0.00 PID unit	-300.00 ... 300.00 PID unit	0x4022:003	general
L P451.04	PID preset 4	0.00 PID unit	-300.00 ... 300.00 PID unit	0x4022:004	general

* Default setting depending on the size.

Firmware version 02.01.01.00

Commissioning

Keypad parameter list



Display code	Short designation	Default setting	Setting range	Address	Category
↳ P451.05	PID preset 5	0.00 PID unit	-300.00 ... 300.00 PID unit	0x4022:005	general
↳ P451.06	PID preset 6	0.00 PID unit	-300.00 ... 300.00 PID unit	0x4022:006	general
↳ P451.07	PID preset 7	0.00 PID unit	-300.00 ... 300.00 PID unit	0x4022:007	general
↳ P451.08	PID preset 8	0.00 PID unit	-300.00 ... 300.00 PID unit	0x4022:008	general
P500.xx	Module ID				
↳ P500.01	Active module ID	-	- (Read only)	0x231F:001	general
↳ P500.02	Module ID conn.	-	- (Read only)	0x231F:002	general
P505.xx	NetWordIN1 fct.				
↳ P505.01	NetWordIN1.00	Not active [0]	Selection list	0x400E:001	general
↳ P505.02	NetWordIN1.01	Not active [0]	Selection list	0x400E:002	general
↳ P505.03	NetWordIN1.02	Quick stop [3]	Selection list	0x400E:003	general
↳ P505.04	NetWordIN1.03	Not active [0]	Selection list	0x400E:004	general
↳ P505.05	NetWordIN1.04	Run forward [8]	Selection list	0x400E:005	general
↳ P505.06	NetWordIN1.05	Setp: Preset b0 [18]	Selection list	0x400E:006	general
↳ P505.07	NetWordIN1.06	Setp: Preset b1 [19]	Selection list	0x400E:007	general
↳ P505.08	NetWordIN1.07	Reset error [4]	Selection list	0x400E:008	general
↳ P505.09	NetWordIN1.08	Not active [0]	Selection list	0x400E:009	general
↳ P505.10	NetWordIN1.09	DC braking [5]	Selection list	0x400E:010	general
↳ P505.11	NetWordIN1.10	Not active [0]	Selection list	0x400E:011	general
↳ P505.12	NetWordIN1.11	Not active [0]	Selection list	0x400E:012	general
↳ P505.13	NetWordIN1.12	Invert rotation [13]	Selection list	0x400E:013	general
↳ P505.14	NetWordIN1.13	Not active [0]	Selection list	0x400E:014	general
↳ P505.15	NetWordIN1.14	Not active [0]	Selection list	0x400E:015	general
↳ P505.16	NetWordIN1.15	Not active [0]	Selection list	0x400E:016	general
P508.00	CANopen comm.	No action [0]	Selection list	0x2300	CANopen
P508.00	Modbus comm.	0	0 ... 1	0x2320	Modbus
P509.00	CANopen switch	-	- (Read only)	0x2303	CANopen
P509.00	Modbus switch	-	- (Read only)	0x2323	Modbus
P510.xx	CANopen sett.				
↳ P510.01	Node ID	1	1 ... 127	0x2301:001	CANopen
↳ P510.02	Baud rate	500 kbps [5]	Selection list	0x2301:002	CANopen
↳ P510.03	Slave/Master	Slave [0]	Selection list	0x2301:003	CANopen
↳ P510.04	Start rem. delay	3000 ms	0 ... 65535 ms	0x2301:004	CANopen
↳ P510.05	SDO2 channel	Not active [0]	Selection list	0x2301:005	CANopen
P510.xx	Modbus sett.				
↳ P510.01	Node ID	1	1 ... 247	0x2321:001	Modbus
↳ P510.02	Baud rate	Automatic [0]	Selection list	0x2321:002	Modbus
↳ P510.03	Data format	Automatic [0]	Selection list	0x2321:003	Modbus
↳ P510.04	Min. resp. time	0 ms	0 ... 1000 ms	0x2321:004	Modbus
P511.xx	CANopen diag.				
↳ P511.01	Active node ID	-	- (Read only)	0x2302:001	CANopen
↳ P511.02	Active baud rate	-	- (Read only)	0x2302:002	CANopen
P511.xx	Modbus diag.				
↳ P511.01	Active node ID	-	- (Read only)	0x2322:001	Modbus
↳ P511.02	Active baud rate	-	- (Read only)	0x2322:002	Modbus
↳ P511.03	Data format	-	- (Read only)	0x2322:003	Modbus
P515.00	Time-out status	-	- (Read only)	0x2307	CANopen
P515.xx	Modbus monit.				
↳ P515.01	Resp. Time-out	Fault [3]	Selection list	0x2858:001	Modbus
↳ P515.02	Time-out time	2.0 s	0.0 ... 300.0 s	0x2858:002	Modbus
P516.00	CANopen status	-	- (Read only)	0x2308	CANopen
P517.00	CAN contr.status	-	- (Read only)	0x2309	CANopen
P518.00	CAN errorcounter	-	- (Read only)	0x230B	CANopen
P520.xx	Cons. heartbeat				

* Default setting depending on the size.

Firmware version 02.01.01.00



Commissioning

Keypad parameter list

Display code	Short designation	Default setting	Setting range	Address	Category
L P520.00	Highest subindex	-	- (Read only)	0x1016:000	CANopen
L P520.01	Cons. heartbeat1	0x00000000	0x00000000 ... 0x00FFFFFF	0x1016:001	CANopen
L P520.02	Cons. heartbeat2	0x00000000	0x00000000 ... 0x00FFFFFF	0x1016:002	CANopen
L P520.03	Cons. heartbeat3	0x00000000	0x00000000 ... 0x00FFFFFF	0x1016:003	CANopen
L P520.04	Cons. heartbeat4	0x00000000	0x00000000 ... 0x00FFFFFF	0x1016:004	CANopen
P522.00	Prod. heartbeat	0 ms	0 ... 65535 ms	0x1017	CANopen
P530.xx	Para. mapping				
L P530.01	Parameter 1	0x00000000	0x00000000 ... 0xFFFFFFFF	0x232B:001	Modbus
L P530.02	Parameter 2	0x00000000	0x00000000 ... 0xFFFFFFFF	0x232B:002	Modbus
L P530.03	Parameter 3	0x00000000	0x00000000 ... 0xFFFFFFFF	0x232B:003	Modbus
L P530.04	Parameter 4	0x00000000	0x00000000 ... 0xFFFFFFFF	0x232B:004	Modbus
L P530.05	Parameter 5	0x00000000	0x00000000 ... 0xFFFFFFFF	0x232B:005	Modbus
L P530.06	Parameter 6	0x00000000	0x00000000 ... 0xFFFFFFFF	0x232B:006	Modbus
L P530.07	Parameter 7	0x00000000	0x00000000 ... 0xFFFFFFFF	0x232B:007	Modbus
L P530.08	Parameter 8	0x00000000	0x00000000 ... 0xFFFFFFFF	0x232B:008	Modbus
L P530.09	Parameter 9	0x00000000	0x00000000 ... 0xFFFFFFFF	0x232B:009	Modbus
L P530.10	Parameter 10	0x00000000	0x00000000 ... 0xFFFFFFFF	0x232B:010	Modbus
L P530.11	Parameter 11	0x00000000	0x00000000 ... 0xFFFFFFFF	0x232B:011	Modbus
L P530.12	Parameter 12	0x00000000	0x00000000 ... 0xFFFFFFFF	0x232B:012	Modbus
L P530.13	Parameter 13	0x00000000	0x00000000 ... 0xFFFFFFFF	0x232B:013	Modbus
L P530.14	Parameter 14	0x00000000	0x00000000 ... 0xFFFFFFFF	0x232B:014	Modbus
L P530.15	Parameter 15	0x00000000	0x00000000 ... 0xFFFFFFFF	0x232B:015	Modbus
L P530.16	Parameter 16	0x00000000	0x00000000 ... 0xFFFFFFFF	0x232B:016	Modbus
L P530.17	Parameter 17	0x00000000	0x00000000 ... 0xFFFFFFFF	0x232B:017	Modbus
L P530.18	Parameter 18	0x00000000	0x00000000 ... 0xFFFFFFFF	0x232B:018	Modbus
L P530.19	Parameter 19	0x00000000	0x00000000 ... 0xFFFFFFFF	0x232B:019	Modbus
L P530.20	Parameter 20	0x00000000	0x00000000 ... 0xFFFFFFFF	0x232B:020	Modbus
L P530.21	Parameter 21	0x00000000	0x00000000 ... 0xFFFFFFFF	0x232B:021	Modbus
L P530.22	Parameter 22	0x00000000	0x00000000 ... 0xFFFFFFFF	0x232B:022	Modbus
L P530.23	Parameter 23	0x00000000	0x00000000 ... 0xFFFFFFFF	0x232B:023	Modbus
L P530.24	Parameter 24	0x00000000	0x00000000 ... 0xFFFFFFFF	0x232B:024	Modbus
P531.xx	Reg. assigned				
L P531.01	Register 1	-	- (Read only)	0x232C:001	Modbus
L P531.02	Register 2	-	- (Read only)	0x232C:002	Modbus
L P531.03	Register 3	-	- (Read only)	0x232C:003	Modbus
L P531.04	Register 4	-	- (Read only)	0x232C:004	Modbus
L P531.05	Register 5	-	- (Read only)	0x232C:005	Modbus
L P531.06	Register 6	-	- (Read only)	0x232C:006	Modbus
L P531.07	Register 7	-	- (Read only)	0x232C:007	Modbus
L P531.08	Register 8	-	- (Read only)	0x232C:008	Modbus
L P531.09	Register 9	-	- (Read only)	0x232C:009	Modbus
L P531.10	Register 10	-	- (Read only)	0x232C:010	Modbus
L P531.11	Register 11	-	- (Read only)	0x232C:011	Modbus
L P531.12	Register 12	-	- (Read only)	0x232C:012	Modbus
L P531.13	Register 13	-	- (Read only)	0x232C:013	Modbus
L P531.14	Register 14	-	- (Read only)	0x232C:014	Modbus
L P531.15	Register 15	-	- (Read only)	0x232C:015	Modbus
L P531.16	Register 16	-	- (Read only)	0x232C:016	Modbus
L P531.17	Register 17	-	- (Read only)	0x232C:017	Modbus
L P531.18	Register 18	-	- (Read only)	0x232C:018	Modbus
L P531.19	Register 19	-	- (Read only)	0x232C:019	Modbus
L P531.20	Register 20	-	- (Read only)	0x232C:020	Modbus
L P531.21	Register 21	-	- (Read only)	0x232C:021	Modbus
L P531.22	Register 22	-	- (Read only)	0x232C:022	Modbus

* Default setting depending on the size.

Firmware version 02.01.01.00

Commissioning

Keypad parameter list



Display code	Short designation	Default setting	Setting range	Address	Category
↳ P531.23	Register 23	-	-(Read only)	0x232C:023	Modbus
↳ P531.24	Register 24	-	-(Read only)	0x232C:024	Modbus
P532.00	Verificationcode	-	-(Read only)	0x232D	Modbus
P540.xx	RPDO1 config.				
↳ P540.01	COB-ID	0x00000200	0x00000000 ... 0xFFFFFFFF	0x1400:001	CANopen
↳ P540.02	Transm. type	255	0 ... 255	0x1400:002	CANopen
↳ P540.05	Event timer	100 ms	0 ... 65535 ms	0x1400:005	CANopen
P541.xx	RPDO2 config.				
↳ P541.01	COB-ID	0x80000300	0x00000000 ... 0xFFFFFFFF	0x1401:001	CANopen
↳ P541.02	Transm. type	255	0 ... 255	0x1401:002	CANopen
↳ P541.05	Event timer	100 ms	0 ... 65535 ms	0x1401:005	CANopen
P542.xx	RPDO3 config.				
↳ P542.01	COB-ID	0x80000400	0x00000000 ... 0xFFFFFFFF	0x1402:001	CANopen
↳ P542.02	Transm. type	255	0 ... 255	0x1402:002	CANopen
↳ P542.05	Event timer	100 ms	0 ... 65535 ms	0x1402:005	CANopen
P550.xx	TPDO1 config.				
↳ P550.01	COB-ID	0x40000180	0x00000001 ... 0xFFFFFFFF	0x1800:001	CANopen
↳ P550.02	Transm. type	255	0 ... 255	0x1800:002	CANopen
↳ P550.03	Inhibit time	0.0 ms	0.0 ... 6553.5 ms	0x1800:003	CANopen
↳ P550.05	Event timer	20 ms	0 ... 65535 ms	0x1800:005	CANopen
P551.xx	TPDO2 config.				
↳ P551.01	COB-ID	0xC0000280	0x00000001 ... 0xFFFFFFFF	0x1801:001	CANopen
↳ P551.02	Transm. type	255	0 ... 255	0x1801:002	CANopen
↳ P551.03	Inhibit time	0.0 ms	0.0 ... 6553.5 ms	0x1801:003	CANopen
↳ P551.05	Event timer	0 ms	0 ... 65535 ms	0x1801:005	CANopen
P552.xx	TPDO3 config.				
↳ P552.01	COB-ID	0xC0000380	0x00000001 ... 0xFFFFFFFF	0x1802:001	CANopen
↳ P552.02	Transm. type	255	0 ... 255	0x1802:002	CANopen
↳ P552.03	Inhibit time	0.0 ms	0.0 ... 6553.5 ms	0x1802:003	CANopen
↳ P552.05	Event timer	0 ms	0 ... 65535 ms	0x1802:005	CANopen
P580.xx	CAN statistics				
↳ P580.01	PDO1 received	-	-(Read only)	0x230A:001	CANopen
↳ P580.02	PDO2 received	-	-(Read only)	0x230A:002	CANopen
↳ P580.03	PDO3 received	-	-(Read only)	0x230A:003	CANopen
↳ P580.05	PDO1 transmitted	-	-(Read only)	0x230A:005	CANopen
↳ P580.06	PDO2 transmitted	-	-(Read only)	0x230A:006	CANopen
↳ P580.07	PDO3 transmitted	-	-(Read only)	0x230A:007	CANopen
↳ P580.09	SDO1 counter	-	-(Read only)	0x230A:009	CANopen
↳ P580.10	SDO2 counter	-	-(Read only)	0x230A:010	CANopen
P580.xx	Modbus statistic				
↳ P580.01	Mess. received	-	-(Read only)	0x232A:001	Modbus
↳ P580.02	Val. mess. rec.	-	-(Read only)	0x232A:002	Modbus
↳ P580.03	Mess. w. exc.	-	-(Read only)	0x232A:003	Modbus
↳ P580.04	Mess. w. errors	-	-(Read only)	0x232A:004	Modbus
↳ P580.05	Messages sent	-	-(Read only)	0x232A:005	Modbus
P583.xx	Rx data diagn.				
↳ P583.01	Rx data offset	0	0 ... 240	0x232E:001	Modbus
↳ P583.02	Last RxD byte0	-	-(Read only)	0x232E:002	Modbus
↳ P583.03	Last RxD byte2	-	-(Read only)	0x232E:003	Modbus
↳ P583.04	Last RxD byte4	-	-(Read only)	0x232E:004	Modbus
↳ P583.05	Last RxD byte6	-	-(Read only)	0x232E:005	Modbus
↳ P583.06	Last RxD byte8	-	-(Read only)	0x232E:006	Modbus
↳ P583.07	Last RxD byte10	-	-(Read only)	0x232E:007	Modbus
↳ P583.08	Last RxD byte12	-	-(Read only)	0x232E:008	Modbus

* Default setting depending on the size.

Firmware version 02.01.01.00



Commissioning

Keypad parameter list

Display code	Short designation	Default setting	Setting range	Address	Category
↳ P583.09	Last RxD byte14	-	-(Read only)	0x232E:009	Modbus
↳ P583.10	Last RxD byte16	-	-(Read only)	0x232E:010	Modbus
↳ P583.11	Last RxD byte18	-	-(Read only)	0x232E:011	Modbus
↳ P583.12	Last RxD byte20	-	-(Read only)	0x232E:012	Modbus
↳ P583.13	Last RxD byte22	-	-(Read only)	0x232E:013	Modbus
↳ P583.14	Last RxD byte24	-	-(Read only)	0x232E:014	Modbus
↳ P583.15	Last RxD byte26	-	-(Read only)	0x232E:015	Modbus
↳ P583.16	Last RxD byte28	-	-(Read only)	0x232E:016	Modbus
↳ P583.17	Last RxD byte30	-	-(Read only)	0x232E:017	Modbus
P585.xx	Tx data diagn.				
↳ P585.01	Tx data offset	0	0 ... 240	0x232F:001	Modbus
↳ P585.02	Last TxD byte0	-	-(Read only)	0x232F:002	Modbus
↳ P585.03	Last TxD Byte1	-	-(Read only)	0x232F:003	Modbus
↳ P585.04	Last TxD byte2	-	-(Read only)	0x232F:004	Modbus
↳ P585.05	Last TxD byte3	-	-(Read only)	0x232F:005	Modbus
↳ P585.06	Last TxD byte4	-	-(Read only)	0x232F:006	Modbus
↳ P585.07	Last TxD byte5	-	-(Read only)	0x232F:007	Modbus
↳ P585.08	Last TxD byte6	-	-(Read only)	0x232F:008	Modbus
↳ P585.09	Last TxD byte7	-	-(Read only)	0x232F:009	Modbus
↳ P585.10	Last TxD byte8	-	-(Read only)	0x232F:010	Modbus
↳ P585.11	Last TxD byte9	-	-(Read only)	0x232F:011	Modbus
↳ P585.12	Last TxD byte10	-	-(Read only)	0x232F:012	Modbus
↳ P585.13	Last TxD byte11	-	-(Read only)	0x232F:013	Modbus
↳ P585.14	Last TxD byte12	-	-(Read only)	0x232F:014	Modbus
↳ P585.15	Last TxD byte13	-	-(Read only)	0x232F:015	Modbus
↳ P585.16	Last TxD byte14	-	-(Read only)	0x232F:016	Modbus
↳ P585.17	Last TxD byte15	-	-(Read only)	0x232F:017	Modbus
P590.xx	NetWordINx				
↳ P590.01	NetWordIN1	0x0000	0x0000 ... 0xFFFF	0x4008:001	general
↳ P590.02	NetWordIN2	0x0000	0x0000 ... 0xFFFF	0x4008:002	general
↳ P590.03	NetWordIN3	0.0 %	0.0 ... 100.0 %	0x4008:003	general
↳ P590.04	NetWordIN4	0.0 %	0.0 ... 100.0 %	0x4008:004	general
P591.xx	NetWordOUTx				
↳ P591.01	NetWordOUT1	-	-(Read only)	0x400A:001	general
↳ P591.02	NetWordOUT2	-	-(Read only)	0x400A:002	general
P592.xx	Process data IN				
↳ P592.01	AC control word	0x0000	0x0000 ... 0xFFFF	0x400B:001	general
↳ P592.02	LECOM ctrl word	0x0000	0x0000 ... 0xFFFF	0x400B:002	general
↳ P592.03	Net.freq. 0.1Hz	0.0 Hz	0.0 ... 599.0 Hz	0x400B:003	general
↳ P592.04	Net.setp. speed	0 rpm	0 ... 50000 rpm	0x400B:004	general
↳ P592.05	Net.freq.0.01Hz	0.00 Hz	0.00 ... 599.00 Hz	0x400B:005	general
↳ P592.06	Veloc. mode setp	0.0 Hz	-599.0 ... 599.0 Hz	0x400B:006	general
↳ P592.07	PID setpoint	0.00 PID unit	-300.00 ... 300.00 PID unit	0x400B:007	general
↳ P592.08	Torque mode setp	0 Nm	-32768 ... 32767 Nm	0x400B:008	general
↳ P592.09	Torque scaling	0	-128 ... 127	0x400B:009	general
P593.xx	Process data OUT				
↳ P593.01	AC status word	-	-(Read only)	0x400C:001	general
↳ P593.02	LECOM stat. word	-	-(Read only)	0x400C:002	general
↳ P593.03	Frequency 0.1Hz	x.x Hz	-(Read only)	0x400C:003	general
↳ P593.04	Motor speed	x rpm	-(Read only)	0x400C:004	general
↳ P593.05	Drive status	-	-(Read only)	0x400C:005	general
↳ P593.06	Frequency 0.01Hz	x.xx Hz	-(Read only)	0x400C:006	general
↳ P593.07	Torque scaled	-	-(Read only)	0x400C:007	general
P600.xx	Process control.				

* Default setting depending on the size.

Firmware version 02.01.01.00

Commissioning

Keypad parameter list



Display code	Short designation	Default setting	Setting range	Address	Category
↳ P600.01	Operating mode	Inhibited [0]	Selection list	0x4020:001	general
↳ P600.02	PID process var.	Analog input 1 [1]	Selection list	0x4020:002	general
↳ P600.03	PID speed range	100 %	0 ... 100 %	0x4020:003	general
↳ P600.04	PID line speed	w/o speed.add. [0]	Selection list	0x4020:004	general
P601.00	PID P-component	5.0 %	0.0 ... 1000.0 %	0x4048	general
P602.00	PID I- component	400 ms	20 ... 6000 ms	0x4049	general
P603.00	PID D-component	0.0 s	0.0 ... 20.0 s	0x404A	general
P604.00	PID setp.ramp	20.0 s	0.0 ... 100.0 s	0x404B	general
P605.xx	PID setp. limit				
↳ P605.01	Minimum setpoint	-300.00 PID unit	-300.00 ... 300.00 PID unit	0x404E:001	general
↳ P605.02	Maximum setpoint	300.00 PID unit	-300.00 ... 300.00 PID unit	0x404E:002	general
P606.xx	PID speed op.				
↳ P606.01	Accel. time	1.0 s	0.0 ... 3600.0 s	0x4021:001	general
↳ P606.02	Decel. time	1.0 s	0.0 ... 3600.0 s	0x4021:002	general
P607.xx	PID influence				
↳ P607.01	Show time	5.0 s	0.0 ... 999.9 s	0x404C:001	general
↳ P607.02	Mask out time	5.0 s	0.0 ... 999.9 s	0x404C:002	general
P608.xx	PID alarms				
↳ P608.01	MIN alarm thrsh.	0.00 PID unit	-300.00 ... 300.00 PID unit	0x404D:001	general
↳ P608.02	MAX alarm thrsh.	100.00 PID unit	-300.00 ... 300.00 PID unit	0x404D:002	general
P610.xx	PID sleep mode				
↳ P610.01	Activation	Disabled [0]	Selection list	0x4023:001	general
↳ P610.02	Stop method	Coasting [0]	Selection list	0x4023:002	general
↳ P610.03	Freq. thresh.	0.0 Hz	0.0 ... 599.0 Hz	0x4023:003	general
↳ P610.04	Feedback thresh.	0.00 PID unit	-300.00 ... 300.00 PID unit	0x4023:004	general
↳ P610.05	Delay time	0.0 s	0.0 ... 300.0 s	0x4023:005	general
↳ P610.06	Recovery	Setp. > P610.3 [0]	Selection list	0x4023:006	general
↳ P610.07	Bandwidth	0.00 PID unit	0.00 ... 300.00 PID unit	0x4023:007	general
↳ P610.08	Recovery thresh.	0.00 PID unit	-300.00 ... 300.00 PID unit	0x4023:008	general
P615.xx	Auto-rinsing				
↳ P615.01	Rinsing in idle	Inhibited [0]	Selection list	0x4024:001	general
↳ P615.02	Rinse interval	30.0 min	0.0 ... 6000.0 min	0x4024:002	general
↳ P615.03	Rinse speed	0.0 Hz	-599.0 ... 599.0 Hz	0x4024:003	general
↳ P615.04	Rinse period	0.0 s	0.0 ... 6000.0 s	0x4024:004	general
P700.xx	Device commands				
↳ P700.01	Load def. sett.	Off / ready [0]	Selection list	0x2022:001	general
↳ P700.03	Save user data	Off / ready [0]	Selection list	0x2022:003	general
↳ P700.04	Load user data	Off / ready [0]	Selection list	0x2022:004	general
↳ P700.05	Load OEM data	Off / ready [0]	Selection list	0x2022:005	general
↳ P700.06	Save OEM data	Off / ready [0]	Selection list	0x2022:006	general
↳ P700.07	Load par. set 1	Off / ready [0]	Selection list	0x2022:007	general
↳ P700.08	Load par. set 2	Off / ready [0]	Selection list	0x2022:008	general
↳ P700.09	Load par. set 3	Off / ready [0]	Selection list	0x2022:009	general
↳ P700.10	Load par. set 4	Off / ready [0]	Selection list	0x2022:010	general
↳ P700.11	Save par. set 1	Off / ready [0]	Selection list	0x2022:011	general
↳ P700.12	Save par. set 2	Off / ready [0]	Selection list	0x2022:012	general
↳ P700.13	Save par. set 3	Off / ready [0]	Selection list	0x2022:013	general
↳ P700.14	Save par. set 4	Off / ready [0]	Selection list	0x2022:014	general
↳ P700.15	Delete logbook	Off / ready [0]	Selection list	0x2022:015	general
↳ P700.27	Accept new HW	Off / ready [0]	Selection list	0x2022:027	general
P701.00	KP setp. incr.	1	1 ... 100	0x2862	general
P702.00	Scal.speed fact.	0.00	0.00 ... 650.00	0x4002	general
P703.00	KP status displ.	0x00000000	0x00000000 ... 0xFFFFFFFF00	0x2864	general
P704.xx	DC braking				

* Default setting depending on the size.

Firmware version 02.01.01.00



Commissioning

Keypad parameter list

Display code	Short designation	Default setting	Setting range	Address	Category
↳ P704.01	Current	0.0 %	0.0 ... 200.0 %	0x2B84:001	general
↳ P704.02	Hold time autom.	0.0 s	0.0 ... 999.9 s	0x2B84:002	general
↳ P704.03	Threshold autom.	0.0 Hz	0.0 ... 599.0 Hz	0x2B84:003	general
P705.00	KP language	English [1]	Selection list	0x2863	general
P706.xx	Brake management				
↳ P706.01	Operating mode	Rfg stop (RFGS) [1]	Selection list	0x2541:001	general
↳ P706.02	Active threshold	x V	- (Read only)	0x2541:002	general
↳ P706.03	Red. threshold	0 V	0 ... 100 V	0x2541:003	general
↳ P706.04	Add.frequency	0.0 Hz	0.0 ... 10.0 Hz	0x2541:004	general
↳ P706.05	Del.overr.time	2.0 s	0.0 ... 60.0 s	0x2541:005	general
P710.xx	Load loss detect				
↳ P710.01	Threshold	0.0 %	0.0 ... 200.0 %	0x4006:001	general
↳ P710.02	Deceleration	0.0 s	0.0 ... 300.0 s	0x4006:002	general
P712.xx	Brake control				
↳ P712.01	Brake mode	Off [2]	Selection list	0x2820:001	general
↳ P712.02	Closing time	100 ms	0 ... 10000 ms	0x2820:002	general
↳ P712.03	Opening time	100 ms	0 ... 10000 ms	0x2820:003	general
↳ P712.07	Closing thresh.	0.2 Hz	0.0 ... 599.0 Hz	0x2820:007	general
↳ P712.08	Holding load	0.0 %	-500.0 ... 500.0 %	0x2820:008	general
↳ P712.15	Brake status	-	- (Read only)	0x2820:015	general
P718.xx	Flying restart				
↳ P718.01	Current	30 %	0 ... 100 %	0x2BA1:001	MCTRL
↳ P718.02	Start frequency	20.0 Hz	-599.0 ... 599.0 Hz	0x2BA1:002	MCTRL
↳ P718.03	Restart time	5911 ms *	1 ... 60000 ms	0x2BA1:003	MCTRL
↳ P718.08	Fl.res.frequency	x.x Hz	- (Read only)	0x2BA1:008	MCTRL
P721.xx	Mains fail. ctrl				
↳ P721.01	Enable function	Disabled [0]	Selection list	0x2D66:001	general
↳ P721.02	DC-bus act.level	0 % *	60 ... 90 %	0x2D66:002	general
↳ P721.03	Gain V-ctrl	0.01000 Hz/V	0.00001 ... 0.50000 Hz/V	0x2D66:003	general
↳ P721.04	Res. time V-ctrl	20 ms	5 ... 2000 ms	0x2D66:004	general
↳ P721.05	DC voltage setp.	100 %	80 ... 110 %	0x2D66:005	general
↳ P721.06	Setp. ramp	20 ms	1 ... 16000 ms	0x2D66:006	general
↳ P721.07	Clear time	20 ms	1 ... 60000 ms	0x2D66:007	general
↳ P721.08	Restart level	0.0 Hz	0.0 ... 599.0 Hz	0x2D66:008	general
↳ P721.09	RERT:Status	-	- (Read only)	0x2D66:009	general
P730.00	PIN1 protection	0	-1 ... 9999	0x203D	general
P731.00	PIN2 protection	0	-1 ... 9999	0x203E	general
P732.00	Auto-Save EPM	Inhibit [0]	Selection list	0x2829	general
P740.xx	Favorites sett.				
↳ P740.01	Parameter 1	0x2DDD0000	0x00000000 ... 0xFFFFFFFF00	0x261C:001	general
↳ P740.02	Parameter 2	0x60780000	0x00000000 ... 0xFFFFFFFF00	0x261C:002	general
↳ P740.03	Parameter 3	0x2D890000	0x00000000 ... 0xFFFFFFFF00	0x261C:003	general
↳ P740.04	Parameter 4	0x603F0000	0x00000000 ... 0xFFFFFFFF00	0x261C:004	general
↳ P740.05	Parameter 5	0x28240000	0x00000000 ... 0xFFFFFFFF00	0x261C:005	general
↳ P740.06	Parameter 6	0x28600100	0x00000000 ... 0xFFFFFFFF00	0x261C:006	general
↳ P740.07	Parameter 7	0x28380100	0x00000000 ... 0xFFFFFFFF00	0x261C:007	general
↳ P740.08	Parameter 8	0x28380300	0x00000000 ... 0xFFFFFFFF00	0x261C:008	general
↳ P740.09	Parameter 9	0x25400100	0x00000000 ... 0xFFFFFFFF00	0x261C:009	general
↳ P740.10	Parameter 10	0x29150000	0x00000000 ... 0xFFFFFFFF00	0x261C:010	general
↳ P740.11	Parameter 11	0x29160000	0x00000000 ... 0xFFFFFFFF00	0x261C:011	general
↳ P740.12	Parameter 12	0x29170000	0x00000000 ... 0xFFFFFFFF00	0x261C:012	general
↳ P740.13	Parameter 13	0x29180000	0x00000000 ... 0xFFFFFFFF00	0x261C:013	general
↳ P740.14	Parameter 14	0x2C000000	0x00000000 ... 0xFFFFFFFF00	0x261C:014	general
↳ P740.15	Parameter 15	0x2B000000	0x00000000 ... 0xFFFFFFFF00	0x261C:015	general

* Default setting depending on the size.

Firmware version 02.01.01.00

Commissioning

Keypad parameter list



Display code	Short designation	Default setting	Setting range	Address	Category
L P740.16	Parameter 16	0x2B010100	0x00000000 ... 0xFFFFFFFF00	0x261C:016	general
L P740.17	Parameter 17	0x2B010200	0x00000000 ... 0xFFFFFFFF00	0x261C:017	general
L P740.18	Parameter 18	0x283A0000	0x00000000 ... 0xFFFFFFFF00	0x261C:018	general
L P740.19	Parameter 19	0x29390000	0x00000000 ... 0xFFFFFFFF00	0x261C:019	general
L P740.20	Parameter 20	0x2D4B0100	0x00000000 ... 0xFFFFFFFF00	0x261C:020	general
L P740.21	Parameter 21	0x2B120100	0x00000000 ... 0xFFFFFFFF00	0x261C:021	general
L P740.22	Parameter 22	0x60730000	0x00000000 ... 0xFFFFFFFF00	0x261C:022	general
L P740.23	Parameter 23	0x26310100	0x00000000 ... 0xFFFFFFFF00	0x261C:023	general
L P740.24	Parameter 24	0x26310200	0x00000000 ... 0xFFFFFFFF00	0x261C:024	general
L P740.25	Parameter 25	0x26310300	0x00000000 ... 0xFFFFFFFF00	0x261C:025	general
L P740.26	Parameter 26	0x26310400	0x00000000 ... 0xFFFFFFFF00	0x261C:026	general
L P740.27	Parameter 27	0x26310500	0x00000000 ... 0xFFFFFFFF00	0x261C:027	general
L P740.28	Parameter 28	0x26310600	0x00000000 ... 0xFFFFFFFF00	0x261C:028	general
L P740.29	Parameter 29	0x26310700	0x00000000 ... 0xFFFFFFFF00	0x261C:029	general
L P740.30	Parameter 30	0x26310800	0x00000000 ... 0xFFFFFFFF00	0x261C:030	general
L P740.31	Parameter 31	0x26310900	0x00000000 ... 0xFFFFFFFF00	0x261C:031	general
L P740.32	Parameter 32	0x26310D00	0x00000000 ... 0xFFFFFFFF00	0x261C:032	general
L P740.33	Parameter 33	0x26311200	0x00000000 ... 0xFFFFFFFF00	0x261C:033	general
L P740.34	Parameter 34	0x26311300	0x00000000 ... 0xFFFFFFFF00	0x261C:034	general
L P740.35	Parameter 35	0x26311400	0x00000000 ... 0xFFFFFFFF00	0x261C:035	general
L P740.36	Parameter 36	0x26340100	0x00000000 ... 0xFFFFFFFF00	0x261C:036	general
L P740.37	Parameter 37	0x26340200	0x00000000 ... 0xFFFFFFFF00	0x261C:037	general
L P740.38	Parameter 38	0x26360100	0x00000000 ... 0xFFFFFFFF00	0x261C:038	general
L P740.39	Parameter 39	0x26360200	0x00000000 ... 0xFFFFFFFF00	0x261C:039	general
L P740.40	Parameter 40	0x26360300	0x00000000 ... 0xFFFFFFFF00	0x261C:040	general
L P740.41	Parameter 41	0x26390100	0x00000000 ... 0xFFFFFFFF00	0x261C:041	general
L P740.42	Parameter 42	0x26390200	0x00000000 ... 0xFFFFFFFF00	0x261C:042	general
L P740.43	Parameter 43	0x26390300	0x00000000 ... 0xFFFFFFFF00	0x261C:043	general
L P740.44	Parameter 44	0x26390400	0x00000000 ... 0xFFFFFFFF00	0x261C:044	general
L P740.45	Parameter 45	0x29110100	0x00000000 ... 0xFFFFFFFF00	0x261C:045	general
L P740.46	Parameter 46	0x29110200	0x00000000 ... 0xFFFFFFFF00	0x261C:046	general
L P740.47	Parameter 47	0x29110300	0x00000000 ... 0xFFFFFFFF00	0x261C:047	general
L P740.48	Parameter 48	0x29110400	0x00000000 ... 0xFFFFFFFF00	0x261C:048	general
L P740.49	Parameter 49	0x00000000	0x00000000 ... 0xFFFFFFFF00	0x261C:049	general
L P740.50	Parameter 50	0x00000000	0x00000000 ... 0xFFFFFFFF00	0x261C:050	general
P750.xx	Param.set setup				
L P750.01	Parameter 1	0x00000000	0x00000000 ... 0xFFFFFFFF00	0x4041:001	general
L P750.02	Parameter 2	0x00000000	0x00000000 ... 0xFFFFFFFF00	0x4041:002	general
L P750.03	Parameter 3	0x00000000	0x00000000 ... 0xFFFFFFFF00	0x4041:003	general
L P750.04	Parameter 4	0x00000000	0x00000000 ... 0xFFFFFFFF00	0x4041:004	general
L P750.05	Parameter 5	0x00000000	0x00000000 ... 0xFFFFFFFF00	0x4041:005	general
L P750.06	Parameter 6	0x00000000	0x00000000 ... 0xFFFFFFFF00	0x4041:006	general
L P750.07	Parameter 7	0x00000000	0x00000000 ... 0xFFFFFFFF00	0x4041:007	general
L P750.08	Parameter 8	0x00000000	0x00000000 ... 0xFFFFFFFF00	0x4041:008	general
L P750.09	Parameter 9	0x00000000	0x00000000 ... 0xFFFFFFFF00	0x4041:009	general
L P750.10	Parameter 10	0x00000000	0x00000000 ... 0xFFFFFFFF00	0x4041:010	general
L P750.11	Parameter 11	0x00000000	0x00000000 ... 0xFFFFFFFF00	0x4041:011	general
L P750.12	Parameter 12	0x00000000	0x00000000 ... 0xFFFFFFFF00	0x4041:012	general
L P750.13	Parameter 13	0x00000000	0x00000000 ... 0xFFFFFFFF00	0x4041:013	general
L P750.14	Parameter 14	0x00000000	0x00000000 ... 0xFFFFFFFF00	0x4041:014	general
L P750.15	Parameter 15	0x00000000	0x00000000 ... 0xFFFFFFFF00	0x4041:015	general
L P750.16	Parameter 16	0x00000000	0x00000000 ... 0xFFFFFFFF00	0x4041:016	general
L P750.17	Parameter 17	0x00000000	0x00000000 ... 0xFFFFFFFF00	0x4041:017	general
L P750.18	Parameter 18	0x00000000	0x00000000 ... 0xFFFFFFFF00	0x4041:018	general

* Default setting depending on the size.

Firmware version 02.01.01.00



Commissioning

Keypad parameter list

Display code	Short designation	Default setting	Setting range	Address	Category
L P750.19	Parameter 19	0x00000000	0x00000000 ... 0xFFFFFFFF00	0x4041:019	general
L P750.20	Parameter 20	0x00000000	0x00000000 ... 0xFFFFFFFF00	0x4041:020	general
L P750.21	Parameter 21	0x00000000	0x00000000 ... 0xFFFFFFFF00	0x4041:021	general
L P750.22	Parameter 22	0x00000000	0x00000000 ... 0xFFFFFFFF00	0x4041:022	general
L P750.23	Parameter 23	0x00000000	0x00000000 ... 0xFFFFFFFF00	0x4041:023	general
L P750.24	Parameter 24	0x00000000	0x00000000 ... 0xFFFFFFFF00	0x4041:024	general
L P750.25	Parameter 25	0x00000000	0x00000000 ... 0xFFFFFFFF00	0x4041:025	general
L P750.26	Parameter 26	0x00000000	0x00000000 ... 0xFFFFFFFF00	0x4041:026	general
L P750.27	Parameter 27	0x00000000	0x00000000 ... 0xFFFFFFFF00	0x4041:027	general
L P750.28	Parameter 28	0x00000000	0x00000000 ... 0xFFFFFFFF00	0x4041:028	general
L P750.29	Parameter 29	0x00000000	0x00000000 ... 0xFFFFFFFF00	0x4041:029	general
L P750.30	Parameter 30	0x00000000	0x00000000 ... 0xFFFFFFFF00	0x4041:030	general
L P750.31	Parameter 31	0x00000000	0x00000000 ... 0xFFFFFFFF00	0x4041:031	general
L P750.32	Parameter 32	0x00000000	0x00000000 ... 0xFFFFFFFF00	0x4041:032	general
P751.xx	Par. value set 1				
L P751.01	Set 1 - Value 1	0	-2147483648 ... 2147483647	0x4042:001	general
L P751.02	Set 1 - Value 2	0	-2147483648 ... 2147483647	0x4042:002	general
L P751.03	Set 1 - Value 3	0	-2147483648 ... 2147483647	0x4042:003	general
L P751.04	Set 1 - Value 4	0	-2147483648 ... 2147483647	0x4042:004	general
L P751.05	Set 1 - Value 5	0	-2147483648 ... 2147483647	0x4042:005	general
L P751.06	Set 1 - Value 6	0	-2147483648 ... 2147483647	0x4042:006	general
L P751.07	Set 1 - Value 7	0	-2147483648 ... 2147483647	0x4042:007	general
L P751.08	Set 1 - Value 8	0	-2147483648 ... 2147483647	0x4042:008	general
L P751.09	Set 1 - Value 9	0	-2147483648 ... 2147483647	0x4042:009	general
L P751.10	Set 1 - Value 10	0	-2147483648 ... 2147483647	0x4042:010	general
L P751.11	Set 1 - Value 11	0	-2147483648 ... 2147483647	0x4042:011	general
L P751.12	Set 1 - Value 12	0	-2147483648 ... 2147483647	0x4042:012	general
L P751.13	Set 1 - Value 13	0	-2147483648 ... 2147483647	0x4042:013	general
L P751.14	Set 1 - Value 14	0	-2147483648 ... 2147483647	0x4042:014	general
L P751.15	Set 1 - Value 15	0	-2147483648 ... 2147483647	0x4042:015	general
L P751.16	Set 1 - Value 16	0	-2147483648 ... 2147483647	0x4042:016	general
L P751.17	Set 1 - Value 17	0	-2147483648 ... 2147483647	0x4042:017	general
L P751.18	Set 1 - Value 18	0	-2147483648 ... 2147483647	0x4042:018	general
L P751.19	Set 1 - Value 19	0	-2147483648 ... 2147483647	0x4042:019	general
L P751.20	Set 1 - Value 20	0	-2147483648 ... 2147483647	0x4042:020	general
L P751.21	Set 1 - Value 21	0	-2147483648 ... 2147483647	0x4042:021	general
L P751.22	Set 1 - Value 22	0	-2147483648 ... 2147483647	0x4042:022	general
L P751.23	Set 1 - Value 23	0	-2147483648 ... 2147483647	0x4042:023	general
L P751.24	Set 1 - Value 24	0	-2147483648 ... 2147483647	0x4042:024	general
L P751.25	Set 1 - Value 25	0	-2147483648 ... 2147483647	0x4042:025	general
L P751.26	Set 1 - Value 26	0	-2147483648 ... 2147483647	0x4042:026	general
L P751.27	Set 1 - Value 27	0	-2147483648 ... 2147483647	0x4042:027	general
L P751.28	Set 1 - Value 28	0	-2147483648 ... 2147483647	0x4042:028	general
L P751.29	Set 1 - Value 29	0	-2147483648 ... 2147483647	0x4042:029	general
L P751.30	Set 1 - Value 30	0	-2147483648 ... 2147483647	0x4042:030	general
L P751.31	Set 1 - Value 31	0	-2147483648 ... 2147483647	0x4042:031	general
L P751.32	Set 1 - Value 32	0	-2147483648 ... 2147483647	0x4042:032	general
P752.xx	Param. set 2				
L P752.01	Set 2 - Value 1	0	-2147483648 ... 2147483647	0x4043:001	general
L P752.02	Set 2 - Value 2	0	-2147483648 ... 2147483647	0x4043:002	general
L P752.03	Set 2 - Value 3	0	-2147483648 ... 2147483647	0x4043:003	general
L P752.04	Set 2 - Value 4	0	-2147483648 ... 2147483647	0x4043:004	general
L P752.05	Set 2 - Value 5	0	-2147483648 ... 2147483647	0x4043:005	general
L P752.06	Set 2 - Value 6	0	-2147483648 ... 2147483647	0x4043:006	general

* Default setting depending on the size.

Firmware version 02.01.01.00

Commissioning

Keypad parameter list



Display code	Short designation	Default setting	Setting range	Address	Category
L P752.07	Set 2 - Value 7	0	-2147483648 ... 2147483647	0x4043:007	general
L P752.08	Set 2 - Value 8	0	-2147483648 ... 2147483647	0x4043:008	general
L P752.09	Set 2 - Value 9	0	-2147483648 ... 2147483647	0x4043:009	general
L P752.10	Set 2 - Value 10	0	-2147483648 ... 2147483647	0x4043:010	general
L P752.11	Set 2 - Value 11	0	-2147483648 ... 2147483647	0x4043:011	general
L P752.12	Set 2 - Value 12	0	-2147483648 ... 2147483647	0x4043:012	general
L P752.13	Set 2 - Value 13	0	-2147483648 ... 2147483647	0x4043:013	general
L P752.14	Set 2 - Value 14	0	-2147483648 ... 2147483647	0x4043:014	general
L P752.15	Set 2 - Value 15	0	-2147483648 ... 2147483647	0x4043:015	general
L P752.16	Set 2 - Value 16	0	-2147483648 ... 2147483647	0x4043:016	general
L P752.17	Set 2 - Value 17	0	-2147483648 ... 2147483647	0x4043:017	general
L P752.18	Set 2 - Value 18	0	-2147483648 ... 2147483647	0x4043:018	general
L P752.19	Set 2 - Value 19	0	-2147483648 ... 2147483647	0x4043:019	general
L P752.20	Set 2 - Value 20	0	-2147483648 ... 2147483647	0x4043:020	general
L P752.21	Set 2 - Value 21	0	-2147483648 ... 2147483647	0x4043:021	general
L P752.22	Set 2 - Value 22	0	-2147483648 ... 2147483647	0x4043:022	general
L P752.23	Set 2 - Value 23	0	-2147483648 ... 2147483647	0x4043:023	general
L P752.24	Set 2 - Value 24	0	-2147483648 ... 2147483647	0x4043:024	general
L P752.25	Set 2 - Value 25	0	-2147483648 ... 2147483647	0x4043:025	general
L P752.26	Set 2 - Value 26	0	-2147483648 ... 2147483647	0x4043:026	general
L P752.27	Set 2 - Value 27	0	-2147483648 ... 2147483647	0x4043:027	general
L P752.28	Set 2 - Value 28	0	-2147483648 ... 2147483647	0x4043:028	general
L P752.29	Set 2 - Value 29	0	-2147483648 ... 2147483647	0x4043:029	general
L P752.30	Set 2 - Value 30	0	-2147483648 ... 2147483647	0x4043:030	general
L P752.31	Set 2 - Value 31	0	-2147483648 ... 2147483647	0x4043:031	general
L P752.32	Set 2 - Value 32	0	-2147483648 ... 2147483647	0x4043:032	general
P753.xx	Param. set 3				
L P753.01	Set 3 - Value 1	0	-2147483648 ... 2147483647	0x4044:001	general
L P753.02	Set 3 - Value 2	0	-2147483648 ... 2147483647	0x4044:002	general
L P753.03	Set 3 - Value 3	0	-2147483648 ... 2147483647	0x4044:003	general
L P753.04	Set 3 - Value 4	0	-2147483648 ... 2147483647	0x4044:004	general
L P753.05	Set 3 - Value 5	0	-2147483648 ... 2147483647	0x4044:005	general
L P753.06	Set 3 - Value 6	0	-2147483648 ... 2147483647	0x4044:006	general
L P753.07	Set 3 - Value 7	0	-2147483648 ... 2147483647	0x4044:007	general
L P753.08	Set 3 - Value 8	0	-2147483648 ... 2147483647	0x4044:008	general
L P753.09	Set 3 - Value 9	0	-2147483648 ... 2147483647	0x4044:009	general
L P753.10	Set 3 - Value 10	0	-2147483648 ... 2147483647	0x4044:010	general
L P753.11	Set 3 - Value 11	0	-2147483648 ... 2147483647	0x4044:011	general
L P753.12	Set 3 - Value 12	0	-2147483648 ... 2147483647	0x4044:012	general
L P753.13	Set 3 - Value 13	0	-2147483648 ... 2147483647	0x4044:013	general
L P753.14	Set 3 - Value 14	0	-2147483648 ... 2147483647	0x4044:014	general
L P753.15	Set 3 - Value 15	0	-2147483648 ... 2147483647	0x4044:015	general
L P753.16	Set 3 - Value 16	0	-2147483648 ... 2147483647	0x4044:016	general
L P753.17	Set 3 - Value 17	0	-2147483648 ... 2147483647	0x4044:017	general
L P753.18	Set 3 - Value 18	0	-2147483648 ... 2147483647	0x4044:018	general
L P753.19	Set 3 - Value 19	0	-2147483648 ... 2147483647	0x4044:019	general
L P753.20	Set 3 - Value 20	0	-2147483648 ... 2147483647	0x4044:020	general
L P753.21	Set 3 - Value 21	0	-2147483648 ... 2147483647	0x4044:021	general
L P753.22	Set 3 - Value 22	0	-2147483648 ... 2147483647	0x4044:022	general
L P753.23	Set 3 - Value 23	0	-2147483648 ... 2147483647	0x4044:023	general
L P753.24	Set 3 - Value 24	0	-2147483648 ... 2147483647	0x4044:024	general
L P753.25	Set 3 - Value 25	0	-2147483648 ... 2147483647	0x4044:025	general
L P753.26	Set 3 - Value 26	0	-2147483648 ... 2147483647	0x4044:026	general
L P753.27	Set 3 - Value 27	0	-2147483648 ... 2147483647	0x4044:027	general
* Default setting depending on the size.				Firmware version 02.01.01.00	



Commissioning

Keypad parameter list

Display code	Short designation	Default setting	Setting range	Address	Category
L P753.28	Set 3 - Value 28	0	-2147483648 ... 2147483647	0x4044:028	general
L P753.29	Set 3 - Value 29	0	-2147483648 ... 2147483647	0x4044:029	general
L P753.30	Set 3 - Value 30	0	-2147483648 ... 2147483647	0x4044:030	general
L P753.31	Set 3 - Value 31	0	-2147483648 ... 2147483647	0x4044:031	general
L P753.32	Set 3 - Value 32	0	-2147483648 ... 2147483647	0x4044:032	general
P754.xx	Param. set 4				
L P754.01	Set 4 - Value 1	0	-2147483648 ... 2147483647	0x4045:001	general
L P754.02	Set 4 - Value 2	0	-2147483648 ... 2147483647	0x4045:002	general
L P754.03	Set 4 - Value 3	0	-2147483648 ... 2147483647	0x4045:003	general
L P754.04	Set 4 - Value 4	0	-2147483648 ... 2147483647	0x4045:004	general
L P754.05	Set 4 - Value 5	0	-2147483648 ... 2147483647	0x4045:005	general
L P754.06	Set 4 - Value 6	0	-2147483648 ... 2147483647	0x4045:006	general
L P754.07	Set 4 - Value 7	0	-2147483648 ... 2147483647	0x4045:007	general
L P754.08	Set 4 - Value 8	0	-2147483648 ... 2147483647	0x4045:008	general
L P754.09	Set 4 - Value 9	0	-2147483648 ... 2147483647	0x4045:009	general
L P754.10	Set 4 - Value 10	0	-2147483648 ... 2147483647	0x4045:010	general
L P754.11	Set 4 - Value 11	0	-2147483648 ... 2147483647	0x4045:011	general
L P754.12	Set 4 - Value 12	0	-2147483648 ... 2147483647	0x4045:012	general
L P754.13	Set 4 - Value 13	0	-2147483648 ... 2147483647	0x4045:013	general
L P754.14	Set 4 - Value 14	0	-2147483648 ... 2147483647	0x4045:014	general
L P754.15	Set 4 - Value 15	0	-2147483648 ... 2147483647	0x4045:015	general
L P754.16	Set 4 - Value 16	0	-2147483648 ... 2147483647	0x4045:016	general
L P754.17	Set 4 - Value 17	0	-2147483648 ... 2147483647	0x4045:017	general
L P754.18	Set 4 - Value 18	0	-2147483648 ... 2147483647	0x4045:018	general
L P754.19	Set 4 - Value 19	0	-2147483648 ... 2147483647	0x4045:019	general
L P754.20	Set 4 - Value 20	0	-2147483648 ... 2147483647	0x4045:020	general
L P754.21	Set 4 - Value 21	0	-2147483648 ... 2147483647	0x4045:021	general
L P754.22	Set 4 - Value 22	0	-2147483648 ... 2147483647	0x4045:022	general
L P754.23	Set 4 - Value 23	0	-2147483648 ... 2147483647	0x4045:023	general
L P754.24	Set 4 - Value 24	0	-2147483648 ... 2147483647	0x4045:024	general
L P754.25	Set 4 - Value 25	0	-2147483648 ... 2147483647	0x4045:025	general
L P754.26	Set 4 - Value 26	0	-2147483648 ... 2147483647	0x4045:026	general
L P754.27	Set 4 - Value 27	0	-2147483648 ... 2147483647	0x4045:027	general
L P754.28	Set 4 - Value 28	0	-2147483648 ... 2147483647	0x4045:028	general
L P754.29	Set 4 - Value 29	0	-2147483648 ... 2147483647	0x4045:029	general
L P754.30	Set 4 - Value 30	0	-2147483648 ... 2147483647	0x4045:030	general
L P754.31	Set 4 - Value 31	0	-2147483648 ... 2147483647	0x4045:031	general
L P754.32	Set 4 - Value 32	0	-2147483648 ... 2147483647	0x4045:032	general
P755.00	PSet activation	On op. disabled [0]	Selection list	0x4046	general
P756.xx	PSet error msg.				
L P756.01	Status	-	-(Read only)	0x4047:001	general
L P756.02	List entry	-	-(Read only)	0x4047:002	general
P760.xx	Fault config.				
L P760.02	Restart delay	3.0 s	0.0 ... 1000.0 s	0x2839:002	general
L P760.03	Restart counter	5	0 ... 255	0x2839:003	general
L P760.04	Tro.count r.time	5.0 s	0.1 ... 3600.0 s	0x2839:004	general
L P760.05	Trouble counter	-	-(Read only)	0x2839:005	general
P780.00	CIA: Statusword	-	-(Read only)	0x6041	general
P781.00	Target velocity	0 rpm	-32768 ... 32767 rpm	0x6042	general
P782.00	Velocity demand	x rpm	-(Read only)	0x6043	general
P783.00	Velocity actual	x rpm	-(Read only)	0x6044	general
P784.xx	Vel. min max				
L P784.01	Vel. min amount	0 rpm	0 ... 480000 rpm	0x6046:001	general
L P784.02	Vel. max amount	2147483647 rpm	0 ... 2147483647 rpm	0x6046:002	general

* Default setting depending on the size.

Firmware version 02.01.01.00

Commissioning

Keypad parameter list

Save parameter settings with keypad



Display code	Short designation	Default setting	Setting range	Address	Category
P785.xx	Vel.acceleration				
└ P785.01	Delta speed	3000 rpm	0 ... 2147483647 rpm	0x6048:001	general
└ P785.02	Delta time	10 s	0 ... 65535 s	0x6048:002	general
P786.xx	Vel.deceleration				
└ P786.01	Delta speed	3000 rpm	0 ... 2147483647 rpm	0x6049:001	general
└ P786.02	Delta time	10 s	0 ... 65535 s	0x6049:002	general
P788.00	Modes of op. dis	-	- (Read only)	0x6061	general
P789.00	Supported modes	-	- (Read only)	0x6502	general
P790.00	Quick stop dec.	546000 pos. unit/s ²	0 ... 2147483647 pos. unit/s ²	0x6085	general

* Default setting depending on the size. Firmware version 02.01.01.00

4.5 Save parameter settings in the memory module

4.5.1 Save parameter settings with keypad

If one parameter setting has been changed with the keypad but has not been saved in the memory module with mains failure protection, the SET display is blinking.

In order to save parameter settings in the user memory of the memory module, press the keypad enter key longer than 3 s.



4.5.2 Save parameter settings with »EASY Starter«

If a parameter setting has been changed with the »EASY Starter« but not yet saved in the memory module with mains failure protection, the status line of the »EASY Starter« displays the note "The parameter set was changed".

In order to save parameter settings in the user memory of the memory module,



















- click the button in the toolbar of the »EASY Starter«  or
- press the function key <F6> or
- execute the device command "Save user data": 0x2022:003 (P700.03) = "On / start [1]".



5 Diagnostics and fault elimination

5.1 LED status display

The "RDY" and "ERR" LED status displays on the front of the inverter provide some quick information about certain operating states.

"RDY" LED (blue)	"ERR" LED (red)	Status/meaning
off	off	No supply voltage.
 on	 on	Initialisation (inverter is started.)
 blinking (1 Hz)	off	Safe torque off (STO) active.
	 blinking fast (4 Hz)	Safe torque off (STO) active, warning active.
 blinking (2 Hz)	off	Inverter inhibited.
	 blinking fast (4 Hz)	Inverter disabled, warning active. ▶ Error handling  83
	 on	Inverter disabled, error active. ▶ Error handling  83
	 lit every 1.5 s for a short time	Inverter inhibited, no DC-bus voltage.
	 on for a short time every 1 s	USB module is connected, 5-V supply voltage for the USB module is available.
 on	off	Inverter enabled. The motor rotates according to the specified setpoint or quick stop active.
	 blinking fast (4 Hz)	Inverter enabled, warning active. The motor rotates according to the specified setpoint or quick stop active.
	 blinking (1 Hz)	Inverter enabled, quick stop as response to fault active. ▶ Error handling  83
 Both LEDs are blinking in a rapidly alternating mode		Firmware update active. ▶ Firmware download  287
 Both LEDs are blinking in a very rapidly synchronous mode		"Visual tracking" function is active. ▶ Optical device identification  98



5.2 Diagnostics parameter

The inverter provides many diagnostic parameters which are helpful for operation, maintenance, error diagnosis, error correction, etc.

- In the following overview the most common diagnostic parameters are listed. For the keypad you can find these diagnostic parameters in group 1.
- Further parameters for more specific diagnostic purposes are described in the following subchapters.
- The diagnostic parameters can only be read and cannot be written to.

Parameter	Name / value range / [default setting]	Info
0x2030	CRC parameter set • Read only	Display of the 32-bit hash sum for the integrity check of the parameter set.
0x2B0E (P102.00)	Frequency setpoint (Freq. setpoint) • Read only: x.x Hz	Display of the frequency setpoint currently assigned. • Depending on the present operating conditions, this value may differ from the current output frequency 0x2DDD (P100.00) .
0x2B0F	VFC output frequency • Read only: x.x Hz	Display of the current output frequency at V/f operation.
0x2D4F (P123.00)	Motor utilisation ($i^2 \cdot t$) (Mot. i^2t utilis.) • Read only: x %	Display of the current thermal motor utilisation.
0x2D87 (P105.00)	DC-bus voltage (DC-bus voltage) • Read only: x V	Display of the current DC-bus voltage.
0x2D88 (P104.00)	Motor current (Motor current) • Read only: x.x A	Display des present current-r.m.s. value.
0x2D89 (P106.00)	Motor voltage (Motor voltage) • Read only: x VAC	Display of the current motor voltage.
0x2DA2:001 (P108.01)	Output power: Effective power (Output power: Effective power) • Read only: x.xxx kW	Display of the active output power for an energy analysis in the respective application.
0x2DA2:002 (P108.02)	Output power: Apparent power (Output power: Apparent power) • Read only: x.xxx kVA	Display of the apparent output power for an energy analysis in the respective application.
0x2DA3:001 (P109.01)	Output energy: Motor (Output energy: Motor) • Read only: x.xx kWh	Display of the output power in motor mode for an energy analysis in the respective application.
0x2DA3:002 (P109.02)	Output energy: Generator (Output energy: Generator) • Read only: x.xx kWh	Display of the output power in generator mode for an energy analysis in the respective application.
0x2DDD (P100.00)	Output frequency (Output frequency) • Read only: x.x Hz	Display of the current output frequency for diagnostics of the control.
0x400D (P101.00)	Scaled actual value (Scaled act value) • Read only: x Units	Display of the current speed in application units.
0x6077 (P107.00)	Torque actual value (Torque actual) • Read only: x.x %	Display of the current torque. • 100 % \equiv Motor rated torque 0x6076 (P325.00)
0x6078 (P103.00)	Current actual value (Current actual) • Read only: x.x %	Display of the present motor current. • 100 % \equiv Motor rated current 0x6075 (P323.00)
0x2D84:001 (P117.01)	Heatsink temperature (Heatsink temp.: Heatsink temp.) • Read only: x.x °C	Display of the current heatsink temperature.



Parameter	Name / value range / [default setting]	Info
0x2D84:002	Heatsink temperature: Warning threshold 50.0 ... [80.0]* ... 100.0 °C <ul style="list-style-type: none"> • Default setting depending on the size. 	Warning threshold for temperature monitoring. <ul style="list-style-type: none"> • If the heatsink temperature exceeds the threshold set here, the inverter outputs a warning. • The warning is reset with a hysteresis of approx. 5 °C. • If the heatsink temperature increases further and exceeds the non-adjustable error threshold (100 °C), the inverter changes to the "Fault" device status. The inverter is disabled and thus any further operation is stopped.

5.2.1 Logbook

For diagnostic purposes, the logbook contains the last 32 error messages and warning signals of the inverter, which have occurred during operation.

Preconditions

The logbook can only be accessed

- via the user interface of »EASY Starter« ("Diagnostics" tab) or
- via network.

Details

In contrast to the error history buffer, the logbook additionally protocols the following events:

- Fault messages
- Change-over from normal to setup mode (and vice versa)
- Execution of device commands
- Avoidance of safety functions

The logbook entries are saved persistently in the inverter. If all 32 memory units are occupied, the oldest entry is deleted for a new entry. By means of the "Delete logbook" device command, all logbook entries can be deleted.

Accessing the logbook with »EASY Starter«

1. Select the inverter on the left side in the »EASY Starter« device list.
2. Change to the "Diagnostics" tab.
3. Click the  icon to open the logbook.

Observe that the logbook only presents a snapshot at the time the data are read out. If a new event occurs, the logbook must be read out again so that the new event becomes visible.

Accessing the logbook via network

The logbook can also be accessed via network from a higher-level controller or a visualisation. The structure of the diagnostic messages complies with the "ETG.1020" standard of the EtherCAT Technology Group (ETG).



See chapter 13.3 of document "ETG.1020 Protocol Enhancements" provided by the EtherCAT Technology Group (ETG) for detailed information on the structure of the diagnostic messages.

Parameter	Name / value range / [default setting]	Info
0x2022:015 (P700.15)	Device commands: Delete logbook (Device commands: Delete logbook) <ul style="list-style-type: none"> • Setting can only be changed if the inverter is inhibited. 	1 = delete all entries in the logbook.
	0 Off / ready	
	1 On / start	

Diagnostics and fault elimination

Diagnostics parameter
Error history buffer



5.2.2 Error history buffer

For purposes of diagnostics, the error history buffer contains the last 32 error and warning messages of the inverter, which have occurred during operation. The error history buffer can be read out using the keypad via P155.00 and provides a limited view on the logbook.

Details

- For each event that is recorded, the error history buffer contains the message text, the error code, the time of occurrence as well as a counter for successive, identical events. If an event that has already been recorded occurs repeatedly, only the counter is incremented.
- The error history buffer can be reset by the user. In order to prevent the buffer from being reset by the user, this function can be protected by means of a password.
- Observe that the error history buffer only presents a snapshot at the time the data are read out. If a new event occurs, the error history buffer must be read out again via P155.00 so that the new event becomes visible.

Accessing the error history buffer with the keypad

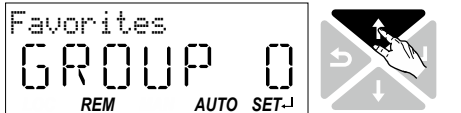
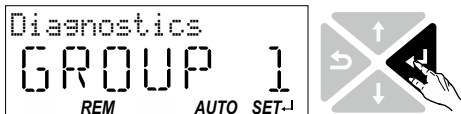
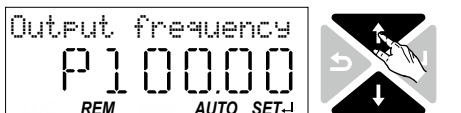
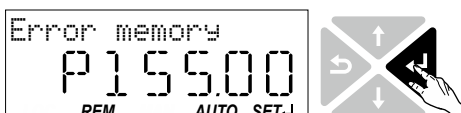
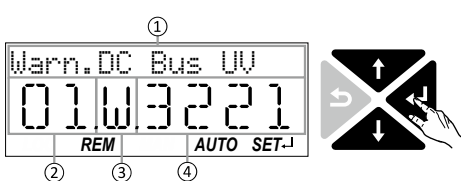
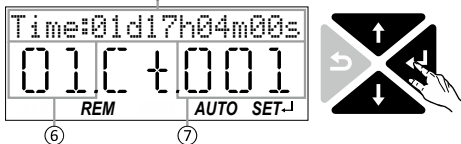
1. 
2. 
3. 
4. 
5. 
6. 
7. 

1. Use the \leftarrow key in the operating mode to navigate to the parameterisation mode one level below.
You are now in the group level. All parameters of the inverter are divided into different groups according to their function.
Note: By using the \rightarrow key you can navigate one level upwards again anytime.
2. Use the \uparrow navigation key to select group 1 ("Diagnostics").
3. Use the \leftarrow key to navigate to one level below.
You are now in the parameter level of the group selected.
4. Use the \uparrow and \downarrow select the P155.00 parameter.
5. Use the \leftarrow key to navigate to one level below.
You are now in the error history buffer.
6. Use the \uparrow and \downarrow navigation keys you can now scroll through the error history buffer entries.
Use the \leftarrow key, you can switch over the display.

Information displayed (page 1):

- ① Message text
- ② No. of the entry (01 = latest event)
- ③ Response (W = warning, T = trouble, F = fault)
- ④ Error code

Information displayed (page 2):

- ⑤ Time of occurrence
- ⑥ No. of the entry (01 = latest event)
- ⑦ Counter for successive, identical events

Note: By using the \rightarrow key you can exit the error history buffer again.

Parameter	Name / value range / [default setting]	Info
0x2006:000 (P155.00)	Error history buffer: Keypad display (Fault memory: Error memory) • Read only	Display of the error history buffer on the keypad.
0x2006:001	Error history buffer: Maximum number of messages • Read only	Display of the maximum number of messages which can be stored in the history buffer (from subindex 6).



Diagnostics and fault elimination

Diagnostics parameter
Error history buffer

Parameter	Name / value range / [default setting]	Info
0x2006:002	Error history buffer: Latest message • Read only	Display of the subindex of the most recent message.
0x2006:003	Error history buffer: Latest acknowledgement message 0 ... [1] ... 1	0 = delete all entries in the error history buffer.
0x2006:004	Error history buffer: New message • Read only	Reserved for future extensions.
0x2006:005	Error history buffer: Buffer overflow • Read only	Bit 0 ... bit 4 = 0. Bit 5 = 1 ≡ overflow (after recording the 33th event in the error history buffer).
0x2006:006	Error history buffer: Message 0 • Read only	Error history buffer entry 01 (latest event)
0x2006:007	Error history buffer: Message 1 • Read only	Error history buffer entry 02
0x2006:008	Error history buffer: Message 2 • Read only	Error history buffer entry 03
0x2006:009	Error history buffer: Message 3 • Read only	Error history buffer entry 04
0x2006:010	Error history buffer: Message 4 • Read only	Error history buffer entry 05
0x2006:011	Error history buffer: Message 5 • Read only	Error history buffer entry 06
0x2006:012	Error history buffer: Message 6 • Read only	Error history buffer entry 07
0x2006:013	Error history buffer: Message 7 • Read only	Error history buffer entry 08
0x2006:014	Error history buffer: Message 8 • Read only	Error history buffer entry 09
0x2006:015	Error history buffer: Message 9 • Read only	Error history buffer entry 10
0x2006:016	Error history buffer: Message 10 • Read only	Error history buffer entry 11
0x2006:017	Error history buffer: Message 11 • Read only	Error history buffer entry 12
0x2006:018	Error history buffer: Message 12 • Read only	Error history buffer entry 13
0x2006:019	Error history buffer: Message 13 • Read only	Error history buffer entry 14
0x2006:020	Error history buffer: Message 14 • Read only	Error history buffer entry 15
0x2006:021	Error history buffer: Message 15 • Read only	Error history buffer entry 16
0x2006:022	Error history buffer: Message 16 • Read only	Error history buffer entry 17
0x2006:023	Error history buffer: Message 17 • Read only	Error history buffer entry 18
0x2006:024	Error history buffer: Message 18 • Read only	Error history buffer entry 19
0x2006:025	Error history buffer: Message 19 • Read only	Error history buffer entry 20
0x2006:026	Error history buffer: Message 20 • Read only	Error history buffer entry 21
0x2006:027	Error history buffer: Message 21 • Read only	Error history buffer entry 22
0x2006:028	Error history buffer: Message 22 • Read only	Error history buffer entry 23
0x2006:029	Error history buffer: Message 23 • Read only	Error history buffer entry 24
0x2006:030	Error history buffer: Message 24 • Read only	Error history buffer entry 25

Diagnostics and fault elimination

Diagnostics parameter
Inverter diagnostics



Parameter	Name / value range / [default setting]	Info
0x2006:031	Error history buffer: Message 25 • Read only	Error history buffer entry 26
0x2006:032	Error history buffer: Message 26 • Read only	Error history buffer entry 27
0x2006:033	Error history buffer: Message 27 • Read only	Error history buffer entry 28
0x2006:034	Error history buffer: Message 28 • Read only	Error history buffer entry 29
0x2006:035	Error history buffer: Message 29 • Read only	Error history buffer entry 30
0x2006:036	Error history buffer: Message 30 • Read only	Error history buffer entry 31
0x2006:037	Error history buffer: Message 31 • Read only	Error history buffer entry 32

5.2.3 Inverter diagnostics

The following parameters supply some information about the current operating status of the inverter.

This includes the following information:

- Active access protection after log-in by means of PIN1/PIN2
- Currently loaded parameter settings
- Cause(s) for disable, quick stop and stop.
- Active control source and active setpoint source
- Active operating mode
- Keypad status
- Status of the internal motor control

Some of the following parameters contain bit-coded status words. Each single bit has a certain meaning.

► [Display of status words on keypad](#) 377

Parameter	Name / value range / [default setting]	Info
0x2040 (P197.00)	Access protection status (Protect. status) • Read only	Bit-coded display of the active access protection after login by PIN1/ PIN2.
	Bit 0 No write access	
	Bit 1 Only favorites changeable	
	Bit 2 Reserved	
	Bit 3 Reserved	
	Bit 4 Reserved	
	Bit 5 Reserved	
	Bit 6 Reserved	
	Bit 7 Reserved	
	Bit 8 Reserved	
	Bit 9 Reserved	
	Bit 10 Reserved	
	Bit 11 Reserved	
	Bit 12 Reserved	
	Bit 13 Reserved	
	Bit 14 Reserved	
Bit 15 Reserved		



Diagnostics and fault elimination

Diagnostics parameter
Inverter diagnostics

Parameter	Name / value range / [default setting]	Info
0x2827 (P198.00)	Currently loaded parameter settings (Status load. par) • Read only	Display of the parameter settings currently loaded. ▶ Saving/loading the parameter settings □ 218
	0 User settings	
	1 Reset 60 Hz setting	Delivery status (default setting) for 50 Hz
	2 Reset 50 Hz setting	Delivery status (default setting) for 60 Hz
	3 OEM default settings	
0x282A:001 (P126.01)	Status words: Cause of disable (Status words: Cause of disable) • Read only	Bit-coded display of the cause(s) for disabled inverter.
	Bit 0 Flexible I/O configuration	1 ≡ the inverter was disabled by the trigger set in 0x2631:001 (P400.01) .
	Bit 1 Network	1 ≡ the inverter was disabled via network.
	Bit 2 Axis command	1 ≡ the inverter was disabled via axis command 0x2822:001 .
	Bit 3 Reserved	-
	Bit 4 Reserved	
	Bit 5 Reserved	
	Bit 6 Fault DC-bus	1 ≡ the inverter was inhibited due to a DC-bus error.
	Bit 7 Drive not ready	1 ≡ the inverter was disabled internally since the drive was not ready for operation. Possible causes: • Under/overvoltage in the DC bus • Defect device hardware
	Bit 8 Quick stop active	1 ≡ the inverter has been disabled by the "Quick stop" function.
	Bit 9 Motor data identification	1 ≡ the inverter was disabled by the "Automatic identification of the motor data" function.
	Bit 10 Automatic holding brake control	1 ≡ the inverter was disabled by the "Holding brake control" function.
	Bit 11 Reserved	-
	Bit 12 CiA402 Inverter disabled	1 ≡ the inverter was disabled by the internal state machine. The bit is only set if • operating mode 0x6060 (P301.00) = "CiA: Velocity mode [2]" and • state machine in the "Switch on disabled" state and • the state change has not been carried out via the "Disable operation" command.
	Bit 13 CiA402 Quick stop option code 2	1 ≡ the inverter has been disabled by the "Quick stop" function.
	Bit 14 Safe torque off (STO)	1 ≡ the inverter has been disabled by the integrated safety system.
	Bit 15 CiA402 operation mode 0	1 ≡ the inverter has been disabled because the selection "No mode change/no mode assigned [0]" is set in 0x6060 (P301.00) .
	Bit 16 Reserved	-
	Bit 17 Reserved	
	Bit 18 Reserved	
	Bit 19 Reserved	
	Bit 20 Reserved	
	Bit 21 Reserved	
	Bit 22 Reserved	
	Bit 23 Reserved	
Bit 24 Reserved		
Bit 25 Reserved		
Bit 26 Reserved		
Bit 27 Reserved		
Bit 28 Reserved		
Bit 29 Reserved		
Bit 30 Reserved		
Bit 31 Reserved		

Diagnostics and fault elimination

Diagnostics parameter
Inverter diagnostics



Parameter	Name / value range / [default setting]	Info
0x282A:002 (P126.02)	Status words: Cause of quick stop (Status words: Cause of QSP) • Read only	Bit coded display of the cause(s) of quick stop.
	Bit 0 Flexible I/O configuration	1 ≙ quick stop was activated by the trigger set in 0x2631:003 (P400.03).
	Bit 1 Network	1 ≙ quick stop was activated via network.
	Bit 2 Axis command	1 ≙ quick stop was activated via axis command 0x2822:001.
	Bit 3 Reserved	-
	Bit 4 Reserved	-
	Bit 5 Reserved	-
	Bit 6 Error response	1 ≙ quick stop has been activated as a response to an error.
	Bit 7 Reserved	-
	Bit 8 Reserved	-
	Bit 9 Reserved	-
	Bit 10 Reserved	-
	Bit 11 Reserved	-
	Bit 12 Reserved	-
	Bit 13 Reserved	-
	Bit 14 Reserved	-
Bit 15 Reserved	-	
0x282A:003 (P126.03)	Status words: Cause of stop (Status words: Cause of stop) • Read only	Bit coded display of the cause(s) of stop.
	Bit 0 Flexible I/O: Start disabled	1 ≙ stop was activated by the trigger set in 0x2631:002 (P400.02).
	Bit 1 Flexible I/O: Run forward	1 ≙ stop has been activated due to cancellation of the command "Run forward (CW)".
	Bit 2 Flexible I/O: Run reverse	1 ≙ stop has been activated due to cancellation of the command "Run reverse (CCW)".
	Bit 3 Flexible I/O: Jog forward	1 ≙ stop has been activated due to cancellation of the command "Jog forward (CW)".
	Bit 4 Flexible I/O: Jog reverse	1 ≙ stop has been activated due to cancellation of the command "Jog reverse (CCW)".
	Bit 5 Network	1 ≙ stop was activated via network.
	Bit 6 Keypad	1 ≙ stop was activated via keypad.
	Bit 7 Control mode transition	1 ≙ stop has been activated due to a change of the operating mode.
	Bit 8 End of sequence	-
	Bit 9 Reserved	-
	Bit 10 Reserved	-
	Bit 11 Reserved	-
	Bit 12 Reserved	-
	Bit 13 Reserved	-
	Bit 14 Reserved	-
Bit 15 Waiting for start	1 ≙ Stop is active as a start command is not yet available (e.g. after enabling the inverter).	



Diagnostics and fault elimination

Diagnostics parameter
Inverter diagnostics

Parameter	Name / value range / [default setting]	Info
0x282A:004	Status words: Extended status word • Read only	Bit-coded status word.
	Bit 0 Reserved	-
	Bit 1 Reserved	-
	Bit 2 Reserved	-
	Bit 3 Reserved	-
	Bit 4 Reserved	-
	Bit 5 Reserved	-
	Bit 6 Reserved	-
	Bit 7 Reserved	-
	Bit 8 Reversal	1 ≡ reversal active.
	Bit 9 Reserved	-
	Bit 10 Safe torque off (STO) active	1 ≡ "Safe torque off (STO)" function has been triggered by the integrated safety system.
	Bit 11 Reserved	-
	Bit 12 Reserved	-
0x282A:005 (P126.05)	Status words: Device status (Status words: Device status) • Read only	Display of the current inverter device state.
	0 Initialisation	
	2 Not ready to switch on	
	3 Switch on disabled	
	4 Ready to switch on	
	5 Switched on	
	6 Operation enabled	
	7 Disable operation	
	8 Shut down	
	9 Quick stop active	
	10 Fault reaction active	
	11 Fault	
0x282B:001 (P125.01)	Inverter diagnostics: Active control source (Inverter diag.: Active control) • Read only	Display of the control source that is currently active.
	0 Flexible I/O configuration	
	1 Network	
	2 Keypad	

Diagnostics and fault elimination

Diagnostics parameter
Inverter diagnostics



Parameter	Name / value range / [default setting]	Info
0x282B:002 (P125.02)	Inverter diagnostics: Active setpoint source (Inverter diag.: Active setpoint) • Read only	Display of the setpoint source that is currently active.
	0 Not selected	
	1 Analog input 1	
	2 Analog input 2	
	3 Keypad Setpoint	
	4 Digital frequency via Dlx	
	5 Network Setpoint	
	11 Setpoint preset 1	
	12 Setpoint preset 2	
	13 Setpoint preset 3	
	14 Setpoint preset 4	
	15 Setpoint preset 5	
	16 Setpoint preset 6	
	17 Setpoint preset 7	
	18 Setpoint preset 8	
	19 Setpoint preset 9	
	20 Setpoint preset 10	
	21 Setpoint preset 11	
	22 Setpoint preset 12	
	23 Setpoint preset 13	
	24 Setpoint preset 14	
	25 Setpoint preset 15	
	31 Segment preset 1	
	32 Segment preset 2	
	33 Segment preset 3	
	34 Segment preset 4	
35 Segment preset 5		
36 Segment preset 6		
37 Segment preset 7		
38 Segment preset 8		
39 Last segment		
50 Motor potentiometer		
0x282B:003 (P125.03)	Inverter diagnostics: Keypad LCD status (Inverter diag.: Keypad LCD stat.) • Read only	Bit-coded state of the keypad status displays.
	Bit 0 LOC	1 ≡ local keypad control active.
	Bit 1 REM	1 ≡ remote control via terminals, network, etc. active.
	Bit 2 MAN	1 ≡ manual setpoint selection via keypad active.
	Bit 3 Auto	1 ≡ automatic setpoint selection via terminals, network, etc. active.
	Bit 4 Set	1 ≡ a parameter setting has been changed but not been saved yet in the memory module with mains failure protection.
	Bit 5 Reserved	-
	Bit 6 Reserved	-
0x282B:004 (P125.04)	Inverter diagnostics: Active drive mode (Inverter diag.: Drive mode) • Read only	Display of the active drive mode.
	0 Velocity mode	"Velocity mode" active.
	1 PID control	PID control active.
	4 Jog operation	"Jog forward (CW)" or "Jog reverse (CCW)" function active.



Diagnostics and fault elimination







Diagnostics parameter
Inverter diagnostics

Parameter	Name / value range / [default setting]	Info
0x2831	Inverter status word • Read only	Bit-coded status word of the internal motor control.
	Bit 0 Reserved	-
	Bit 1 Speed 1 limited	1 ≡ input of speed controller 1 in limitation.
	Bit 2 Speed limited	1 ≡ output of speed controller 1 in limitation.
	Bit 3 Torque limited	1 ≡ setpoint torque in limitation.
	Bit 4 Current limited	1 ≡ setpoint current in limitation.
	Bit 5 Speed 2 limited	1 ≡ input of the speed controller 2 in "torque mode" in limitation.
	Bit 6 Upper speed limit active	1 ≡ in "torque mode", the speed is limited to upper speed limit .
	Bit 7 Lower speed limit active	1 ≡ in "torque mode", the speed is limited to lower speed limit.
	Bit 8 Reserved	-
	Bit 9 Reserved	-
	Bit 10 Output frequency limited	1 ≡ setpoint frequency with V/f operation in limitation.
	Bit 11 Magnetisation completed	1 ≡ during V/f operation, the factor 7 rotor time constant has passed (calculated from the time at which the inverter was enabled without restart on the fly and with a total motor current of 20 % rated motor current for the first time). Otherwise 0.
	Bit 12 Motor phase error	1 ≡ motor phase failure detection active.
	Bit 13 Reserved	-
Bit 14 Error reset blocking time active	1 ≡ the fault can only be reset when the blocking time has elapsed.	
Bit 15 Reserved	-	
0x2833	Inverter status word 2 • Read only	Bit-coded status word 2 of the inverter.
	Bit 0 Reserved	-
	Bit 1 Manual test mode active	1 ≡ manual test mode active.
	Bit 2 Manual control active	1 ≡ manual control active.
	Bit 3 Reserved	-
	Bit 4 Reserved	-
	Bit 5 Reserved	-
	Bit 6 DC braking active	1 ≡ DC braking active.
	Bit 7 Reserved	-
	Bit 8 Reserved	-
	Bit 9 Reserved	-
	Bit 10 Reserved	-
	Bit 11 Reserved	-
	Bit 12 Reserved	-
	Bit 13 Reserved	-
	Bit 14 Reserved	-
Bit 15 Reserved	-	

Diagnostics and fault elimination

Diagnostics parameter
Network diagnostics



Parameter	Name / value range / [default setting]	Info
0x2DAC (P119.00)	Keypad status (Keypad status) • Read only	Bit-coded display of the keypad status.
	Bit 0 Start Key	1 ≡ keypad start key  pressed.
	Bit 1 Stop Key	1 ≡ keypad stop key  pressed.
	Bit 2 Up arrow	1 ≡ keypad up-arrow key  pressed.
	Bit 3 Down arrow	1 ≡ keypad down-arrow key  pressed.
	Bit 4 Enter Key	1 ≡ keypad enter key  pressed.
	Bit 5 Back key	1 ≡ keypad back key  pressed.
	Bit 6 Reserved	-
	Bit 7 Reserved	-
	Bit 8 Reserved	-
	Bit 9 Reserved	-
	Bit 10 Reserved	-
	Bit 11 Reserved	-
	Bit 12 Reserved	-
	Bit 13 Reserved	-
	Bit 14 Reserved	-
Bit 15 Reserved	-	
0x2DAD (P120.00)	Internal hardware states (Int. HW states) • Read only	Bit-coded display of internal hardware states.
	Bit 0 Relay	0 ≡ X9/NO-COM open and NC-COM closed. 1 ≡ X9/NO-COM closed and NC-COM open.
	Bit 1 Digital output 1	0 ≡ LOW level, 1 ≡ HIGH level.
	Bit 2 Digital output 2	-
	Bit 3 Reserved	-
	Bit 4 Reserved	-
	Bit 5 Reserved	-
	Bit 6 Reserved	-
	Bit 7 Reserved	-
	Bit 8 Reserved	-
	Bit 9 Reserved	-
	Bit 10 Charge Relay	1 ≡ precharging of the DC bus via charge relay is active.
	Bit 11 Reserved	-
	Bit 12 Reserved	-
Bit 13 Reserved	-	
Bit 14 Reserved	-	
Bit 15 Reserved	-	
0x603F (P150.00)	Error code (Error code) • Read only	Error message

5.2.4 Network diagnostics

The following parameters show some general information with regard to the network option available and the network.

Further fieldbus-specific diagnostic parameters are described in the following subchapters.

Parameter	Name / value range / [default setting]	Info
0x282B:005 (P125.05)	Inverter diagnostics: Most recently used control register (Inverter diag.: Netw. contr.reg.) • Read only	Display of the network register for the control that was accessed last (e. g. 0x6040 or 0x400B:1). • Format: 0xiiii:ss00 (iiii = hexadecimal index, ss = hexadecimal subindex) • The lowest byte is always 0x00.



Diagnostics and fault elimination

Diagnostics parameter
Network diagnostics

Parameter	Name / value range / [default setting]	Info
0x282B:006 (P125.06)	Inverter diagnostics: Most recently used setpoint register (Inverter diag.: Netw. setp.reg.) • Read only	Display of the network register for setpoint selection that was accessed last (e. g. 0x6042 or 0x400B:3). • Format: 0xiiiiSS00 (iiii = hexadecimal index, SS = hexadecimal subindex) • The lowest byte is always 0x00.
0x400B:006 (P592.06)	Process input data: Velocity mode setpoint (Process data IN: Veloc. mode setp) -599.0 ... [0.0] ... 599.0 Hz	Display of the setpoint received via network for "velocity mode".
0x400B:007 (P592.07)	Process input data: PID setpoint (Process data IN: PID setpoint) -300.00 ... [0.00] ... 300.00 PID unit	Display of the setpoint received via network (reference value) for PID control.
0x400B:008 (P592.08)	Process input data: Torque mode setpoint (Process data IN: Torque mode setp) -32768 ... [0] ... 32767 Nm	Display of the setpoint received via network for "torque mode".
0x231F:001 (P500.01)	Module ID: Active module ID (Module ID: Active module ID) • Read only • Default setting depending on the size.	Display of the network options currently configured in the inverter. • When the "Load default settings" device command 0x2022:001 (P700.01) or "Accept new inverter hardware" 0x2022:027 (P700.27) is executed, the module ID is stored in the memory module. • With the help of this module ID, the keypad only shows the communication parameters relevant to the respective network. Note! When the inverter is switched on, it checks whether the parameter settings stored in the memory module match the network option available in the inverter. If not, the inverter changes to the error status. The error status can only be quit if all parameters are initialised for the new (available) network option. ▶ Initialising the network interface □ 221
	48 No network	
	65 AS-Interface • From version 02.00	
	67 CANopen	
	71 EtherNet/IP • From version 02.00	
	80 PROFIBUS	
	82 ProfiNet • From version 02.00	
	84 EtherCAT • From version 02.00	
87 Modbus		
0x231F:002 (P500.02)	Module ID: Module ID connected (Module ID: Module ID conn.) • Read only	Display of the network option currently available in the inverter. Note! When the inverter is switched on, it checks whether the parameter settings stored in the memory module match the network option available in the inverter. If not, the inverter changes to the error status. The error status can only be quit if all parameters are initialised for the new (available) network option. ▶ Initialising the network interface □ 221
	48 No network	
	65 AS-Interface • From version 02.00	
	67 CANopen	
	71 EtherNet/IP • From version 02.00	
	80 PROFIBUS	
	82 ProfiNet • From version 02.00	
	84 EtherCAT • From version 02.00	
87 Modbus		
0x400B:009 (P592.09)	Process input data: Torque scaling (Process data IN: Torque scaling) -128 ... [0] ... 127 • From version 02.00	Scaling factor for torque setpoint and actual torque value 0x400C:007 (P593.07) via network. • With the setting 0, no scaling takes place.

Related topics

▶ [Configuring the network](#) [□ 136](#)

Diagnostics and fault elimination

Diagnostics parameter
Network diagnostics



5.2.4.1 CANopen diagnostics

The following parameters serve to diagnose the CANopen interface and communication via CANopen.

Preconditions

Control unit (CU) of the inverter is provided with CANopen.

Parameter	Name / value range / [default setting]	Info
0x1000	Device type • Read only	CANopen device profile according CANopen specification CiA 301/ CiA 402. Specifies the axis type: • 0x01010192 ≙ single axis • 0x02010192 ≙ double axis • 0x01020192 ≙ servo single axis • 0x02020192 ≙ servo double axis • 0x01030192 ≙ stepper single axis • 0x02030192 ≙ stepper double axis
0x1001	Error register • Read only	Bit-coded error status. • Bit 0 is set if an error is active. The other bits signalise which group the active error belongs to: • Bit 1: Current error • Bit 2: Voltage error • Bit 3: Temperature error • Bit 4: Communication error • Bit 5: Device profile-specific error • Bit 6: Reserved (always 0) • Bit 7: Manufacturer-specific error
0x1008	Manufacturer device name • Read only	Manufacturer's device name
0x1009	Manufacturer hardware version • Read only	Manufacturer hardware version
0x100A	Manufacturer software version • Read only	Manufacturer software version
0x1018:001	Identity object: Vendor ID • Read only	Manufacturer's identification number • The identification number allocated to Lenze by the organisation "CAN in Automation e. V." is "0x0000003B".
0x1018:002	Identity object: Product code • Read only	Product code of the inverter.
0x1018:003	Identity object: Revision number • Read only	Main and subversion of firmware.
0x1018:004	Identity object: Serial number • Read only	Serial number of the inverter.
0x2302:001 (P511.01)	Active CANopen settings: Active node ID (CANopen diag.: Active node ID) • Read only	Display of the active node address.
0x2302:002 (P511.02)	Active CANopen settings: Active baud rate (CANopen diag.: Active baud rate) • Read only	Display of the active baud rate.
	1 20 kbps	
	2 50 kbps	
	3 125 kbps	
	4 250 kbps	
	5 500 kbps	
	6 800 kbps	
	7 1 Mbps	



Diagnostics and fault elimination

Diagnostics parameter
Network diagnostics

Parameter	Name / value range / [default setting]	Info
0x2307 (P515.00)	CANopen time-out status (Time-out status) • Read only	Bit-coded status display of the CAN time monitoring functions.
	Bit 0 RPDO1-Timeout	1 ≙ RPDO1 was not received within the monitoring time or not with the sync configured. • Status is reset automatically after the RPDO has been received again. • Setting of monitoring time for RPDO1 in 0x1400:005 (P540.05) .
	Bit 1 RPDO2-Timeout	1 ≙ RPDO2 was not received within the monitoring time or not with the sync configured. • Status is reset automatically after the RPDO has been received again. • Setting of monitoring time for RPDO2 in 0x1401:005 (P541.05) .
	Bit 2 RPDO3-Timeout	1 ≙ RPDO3 was not received within the monitoring time or not with the sync configured. • Status is reset automatically after the RPDO has been received again. • Setting of monitoring time for RPDO3 in 0x1402:005 (P542.05) .
	Bit 3 Reserved	-
	Bit 4 Reserved	-
	Bit 5 Reserved	-
	Bit 6 Reserved	-
	Bit 7 Reserved	-
	Bit 8 Heartbeat-Timeout Consumer 1	1 ≙ within the "Heartbeat Consumer Time", no heartbeat telegram was received from node 1 to be monitored. • Status can only be reset by mains switching or error reset. • "Heartbeat Consumer Time" setting in 0x1016:001 (P520.01) .
	Bit 9 Heartbeat-Timeout Consumer 2	1 ≙ within the "Heartbeat Consumer Time", no heartbeat telegram was received from node 2 to be monitored. • Status can only be reset by mains switching or error reset. • "Heartbeat Consumer Time" setting in 0x1016:002 (P520.02) .
	Bit 10 Heartbeat-Timeout Consumer 3	1 ≙ within the "Heartbeat Consumer Time", no heartbeat telegram was received from node 3 to be monitored. • Status can only be reset by mains switching or error reset. • "Heartbeat Consumer Time" setting in 0x1016:003 (P520.03) .
	Bit 11 Heartbeat-Timeout Consumer 4	1 ≙ within the "Heartbeat Consumer Time", no heartbeat telegram was received from node 4 to be monitored. • Status can only be reset by mains switching or error reset. • "Heartbeat Consumer Time" setting in 0x1016:004 (P520.04) .
	Bit 12 Reserved	-
	Bit 13 Reserved	-
	Bit 14 Reserved	-
	Bit 15 Reserved	-
	Bit 16 Reserved	-
	Bit 17 Reserved	-
	Bit 18 Reserved	-
	Bit 19 Reserved	-
	Bit 20 Reserved	-
	Bit 21 Reserved	-
	Bit 22 Reserved	-
	Bit 23 Reserved	-
	Bit 24 Reserved	-
	Bit 25 Reserved	-
	Bit 26 Reserved	-
	Bit 27 Reserved	-
	Bit 28 Reserved	-
	Bit 29 Reserved	-
	Bit 30 Reserved	-
Bit 31 Reserved	-	

Diagnostics and fault elimination

Diagnostics parameter
Network diagnostics



Parameter	Name / value range / [default setting]	Info
0x2308 (P516.00)	CANopen status (CANopen status) • Read only	Display of the current CAN bus state.
	0 Initialisation	CAN bus initialisation active. • The initialisation is started automatically at mains connection. During this phase, the inverter is not involved in the data exchange process on the CAN bus. • All CAN-relevant parameters are initialised with the saved settings. • When the initialisation process has been completed, the inverter automatically adopts the "Pre-Operational" state.
	1 Reset node	"Reset Node" NMT command active. • All parameters are initialised with the saved settings (not only the CAN-relevant parameters).
	2 Reset communication	"Reset Communication" NMT command active. • Initialisation of all CAN-relevant parameters with the values stored.
	4 Stopped	Only network management telegrams can be received.
	5 Operational	Parameter data and process data can be received. If defined, process data is sent as well.
	127 Pre-Operational	Parameter data can be received, process data are ignored.
0x2309 (P517.00)	CANopen controller status (CAN contr.status) • Read only	Status display of the internal CANopen controller.
	1 Error active	The inverter is a fully-fledged communication node at the CANopen network. It is able to transmit and receive data and to report faults.
	2 Error passive	The inverter can only passively indicate faulty reception via the ACK field.
	3 Bus off	The inverter is electrically separated from the CANopen network. In order to exit this state, the CANopen interface must be reset. An automatic restart is implemented.
0x230A:001 (P580.01)	CANopen statistics: PDO1 received (CAN statistics: PDO1 received) • Read only	Display of the number of PDO1 telegrams received.
0x230A:002 (P580.02)	CANopen statistics: PDO2 received (CAN statistics: PDO2 received) • Read only	Display of the number of PDO2 telegrams received.
0x230A:003 (P580.03)	CANopen statistics: PDO3 received (CAN statistics: PDO3 received) • Read only	Display of the number of PDO3 telegrams received.
0x230A:005 (P580.05)	CANopen statistics: PDO1 transmitted (CAN statistics: PDO1 transmitted) • Read only	Display of the number of PDO1 telegrams sent.
0x230A:006 (P580.06)	CANopen statistics: PDO2 transmitted (CAN statistics: PDO2 transmitted) • Read only	Display of the number of PDO2 telegrams sent.
0x230A:007 (P580.07)	CANopen statistics: PDO3 transmitted (CAN statistics: PDO3 transmitted) • Read only	Display of the number of PDO3 telegrams sent.
0x230A:009 (P580.09)	CANopen statistics: SDO1 telegrams (CAN statistics: SDO1 counter) • Read only	Display of the number of SDO1 telegrams.
0x230A:010 (P580.10)	CANopen statistics: SDO2 telegrams (CAN statistics: SDO2 counter) • Read only	Display of the number of SDO2 telegrams.
0x230B (P518.00)	CANopen error counter (CAN errorcounter) • Read only	Display of the total number of CAN faults that have occurred.

Related topics

▶ [CANopen](#)  158



5.2.4.2 Modbus diagnostics

The following parameters serve to diagnose the Modbus interface and communication via Modbus.

Preconditions

Control unit (CU) of the inverter is provided with Modbus.

Parameter	Name / value range / [default setting]	Info
0x2322:001 (P511.01)	Active Modbus settings: Active node ID (Modbus diag.: Active node ID) • Read only	Display of the active node address.
0x2322:002 (P511.02)	Active Modbus settings: Active baud rate (Modbus diag.: Active baud rate) • Read only	Display of the active baud rate.
0x2322:003 (P511.03)	Active Modbus settings: Data format (Modbus diag.: Data format) • Read only	Display of the active data format.
0x232A:001 (P580.01)	Modbus statistics: Messages received (Modbus statistic: Mess. received) • Read only	Display of the total number of messages received. • This counter counts both valid and invalid messages. • After the maximum value has been reached, the counter starts again "0".
0x232A:002 (P580.02)	Modbus statistics: Valid messages received (Modbus statistic: Val. mess. rec.) • Read only	Display of the number of valid messages received. • After the maximum value has been reached, the counter starts again "0".
0x232A:003 (P580.03)	Modbus statistics: Messages with exceptions (Modbus statistic: Mess. w. exc.) • Read only	Display of the number of messages with exceptions that have been received. • After the maximum value has been reached, the counter starts again "0".
0x232A:004 (P580.04)	Modbus statistics: Messages with errors (Modbus statistic: Mess. w. errors) • Read only	Display of the number of messages received with a faulty data integrity (parity, CRC). • After the maximum value has been reached, the counter starts again "0".
0x232A:005 (P580.05)	Modbus statistics: Messages sent (Modbus statistic: Messages sent) • Read only	Display of the total number of messages sent. • After the maximum value has been reached, the counter starts again "0".

Related topics

► [Modbus](#) 184

5.2.4.3 Wireless-LAN diagnostics

The following parameters serve to diagnose the WLAN module and the WLAN communication.

Preconditions

WLAN module has been plugged onto the interface X16 on the front of the inverter.

Parameter	Name / value range / [default setting]	Info
0x2442:001	Active IP address • Read only • From version 02.00	Display of the active IP address. • If DHCP is activated, the active IP address usually derives from the configured static IP address of the device.
0x2442:002	Active netmask • Read only • From version 02.00	Display of the active netmask.
0x2442:003	Active gateway • Read only • From version 02.00	Display of the active gateway IP address.
0x2442:004	Active module mode • Read only • From version 02.00	Display of the active WLAN settings. • This parameter indicates whether the settings used come from the inverter or from the WLAN module.
	0 Inverter	The WLAN settings saved in the inverter are used.
	1 Standalone	The WLAN settings saved in the WLAN module are used.
0x2442:005	MAC address • Read only • From version 02.00	Display of the MAC address of the WLAN module.

Diagnostics and fault elimination

Diagnostics parameter
Network diagnostics



Parameter	Name / value range / [default setting]	Info
0x2448:001	WLAN status: Connection time • Read only • From version 02.00	Display of the connection time in [s] since the current connection was established.
0x2448:002	WLAN status: Number of connections • Read only • From version 02.00	In access point mode: Display of the number of currently connected clients. In client mode: 0 = not connected; 1 = connected with external WLAN network.
0x2448:003	WLAN status: Rx frame counter • Read only • From version 02.00	Display of the number of request received via WLAN.
0x2448:004	WLAN status: Error statistics • Read only • From version 02.00	Display of the quality of the WLAN connection. A display value > 0 indicates communication problems.
0x2449	WLAN error • Read only • From version 02.00	Bit coded display of WLAN errors.
	Bit 2 ERR_WIFI_ERROR	WLAN connection problem
	Bit 3 ERR_MEM_CHK_FAILED	Memory problem
	Bit 4 WIFI_CHK_FAILED	WLAN connection problem
	Bit 7 ERR_WIFI_OFF	
	Bit 9 ERR_CLIENT_MODE_OFF	WLAN-client-mode problem
Bit 12 ERR_TCPIP_CFG_FAIL	TCP/IP configuration error	

Related topics

▶ [Wireless LAN \(WLAN\)](#) 196



5.2.5 Diagnostics of the inputs and outputs

5.2.5.1 Digital inputs and outputs

The following parameters serve to diagnose the digital inputs and outputs of the inverter.

Parameter	Name / value range / [default setting]	Info
0x60FD (P118.00)	Digital inputs (Digital inputs) • Read only	Bit coded display of the current state of the digital inputs
	Bit 0 Reserved	-
	Bit 1 Reserved	-
	Bit 2 Reserved	-
	Bit 3 Reserved	-
	Bit 4 Reserved	-
	Bit 5 Reserved	-
	Bit 6 Reserved	-
	Bit 7 Reserved	-
	Bit 8 Reserved	-
	Bit 9 Reserved	-
	Bit 10 Reserved	-
	Bit 11 Reserved	-
	Bit 12 Reserved	-
	Bit 13 Reserved	-
	Bit 14 Reserved	-
	Bit 15 Reserved	-
	Bit 16 Level of digital input 1	0 ≡ LOW level, 1 ≡ HIGH level.
	Bit 17 Level of digital input 2	
	Bit 18 Level of digital input 3	
	Bit 19 Level of digital input 4	
	Bit 20 Level of digital input 5	
	Bit 21 Level of digital input 6	- (not supported)
	Bit 22 Level of digital input 7	
	Bit 23 Reserved	-
	Bit 24 Reserved	-
	Bit 25 Internal interconnection of digital inputs	0 ≡ digital input terminals are set to HIGH level via pull-up resistors. 1 ≡ digital input terminals are set to LOW level via pull-down resistors.
	Bit 26 Reserved	-
	Bit 27 Reserved	-
	Bit 28 Reserved	-
	Bit 29 Reserved	-
	Bit 30 Reserved	-
Bit 31 Reserved	-	
0x4016:005	Digital output 1: Terminal state • Read only	Display of the logic state of output terminal X3/DO1.
	0 FALSE	
	1 TRUE	
0x4016:006	Digital output 1: Trigger signal state • Read only	Display of the logic state of the trigger signal for digital output 1 (without taking a ON/OFF delay set and inversion into consideration).
	0 FALSE	
	1 TRUE	
0x4018:005	Relay: Relay state • Read only	Display of the logic state of the relay.
	0 FALSE	
	1 TRUE	
0x4018:006	Relay: Trigger signal state • Read only	Display of the logic state of the trigger signal for the relay (without taking a ON/OFF delay set and inversion into consideration).
	0 FALSE	
	1 TRUE	

Diagnostics and fault elimination

Diagnostics parameter

Diagnostics of the inputs and outputs



Related topics

▶ [Configuration of digital inputs](#) 348

▶ [Configuration of digital outputs](#) 355

5.2.5.2 Analog inputs and outputs

The following parameters serve to diagnose the analog inputs and outputs of the inverter.

Parameter	Name / value range / [default setting]	Info
0x2DA4:001 (P110.01)	Diagnostics of analog input 1: Value in percent (AI1 diagnostics: AI1 terminal %) • Read only: x.x %	Display of the current input value at X3/AI1 scaled as value in percent. • 100 % \equiv 10 V or 20 mA or 5 V
0x2DA4:002 (P110.02)	Diagnostics of analog input 1: Frequency value (AI1 diagnostics: AI1 scaled freq.) • Read only: x.x Hz	Display of the current input value at X3/AI1 scaled as a frequency value. • The standard setpoint source for operating mode 0x6060 (P301.00) = "MS: Velocity mode [-2]" is selected in 0x2860:001 (P201.01) .
0x2DA4:003 (P110.03)	Diagnostics of analog input 1: Process controller value (AI1 diagnostics: AI1 scaled PID) • Read only: x.xx PID unit	Display of the current input value at X3/AI1 scaled as a process controller value. • The standard setpoint source for the reference value of PID control is selected in 0x2860:002 (P201.02) .
0x2DA4:004 (P110.04)	Diagnostics of analog input 1: Torque value (AI1 diagnostics: AI1 scaled torq.) • Read only: x.xx %	Display of the current input value at X3/AI1 scaled as a percentage torque value. • 100 % \equiv permissible maximum torque 0x6072 (P326.00)
0x2DA4:016 (P110.16)	Diagnostics of analog input 1: Status (AI1 diagnostics: AI1 status) • Read only	Bit-coded display of the status of analog input 1 (X3/AI1).
	Bit 0 Mode 0: 0 ... 10 VDC active	
	Bit 1 Mode 1: 0 ... 5 VDC active	
	Bit 2 Mode 2: 2 ... 10 VDC active	
	Bit 3 Mode 3: -10 ... 10 VDC active	
	Bit 4 Mode 4: 4 ... 20 mA active	
	Bit 5 Mode 5: 0 ... 20 mA active	
	Bit 6 24 V supply OK	
	Bit 7 Calibration successful	
	Bit 8 Monitoring threshold exceeded/not reached	
	Bit 9 Input current too low (mode 4)	
	Bit 10 Input voltage too low (mode 2)	
	Bit 11 Input voltage too high (mode 4)	
	Bit 12 Reserved	
	Bit 13 Reserved	
	Bit 14 Reserved	
	Bit 15 Reserved	
0x2DA5:001 (P111.01)	Diagnostics of analog input 2: Value in percent (AI2 diagnostics: AI2 terminal %) • Read only: x.x %	Display of the current input value at X3/AI2 scaled as a value in percent. • 100 % \equiv 10 V or 20 mA or 5 V
0x2DA5:002 (P111.02)	Diagnostics of analog input 2: Frequency value (AI2 diagnostics: AI2 scaled freq.) • Read only: x.x Hz	Display of the current input value at X3/AI2 scaled as a frequency value. • The standard setpoint source for operating mode 0x6060 (P301.00) = "MS: Velocity mode [-2]" is selected in 0x2860:001 (P201.01) .
0x2DA5:003 (P111.03)	Diagnostics of analog input 2: Process controller value (AI2 diagnostics: AI2 scaled PID) • Read only: x.xx PID unit	Display of the current input value at X3/AI2 scaled as a process controller value. • The standard setpoint source for the reference value of PID control is selected in 0x2860:002 (P201.02) .
0x2DA5:004 (P111.04)	Diagnostics of analog input 2: Torque value (AI2 diagnostics: AI2 scaled torq.) • Read only: x.xx %	Display of the current input value at X3/AI2 scaled as a percentage torque value. • 100 % \equiv permissible maximum torque 0x6072 (P326.00)



Diagnostics and fault elimination

Diagnostics parameter
Process controller status

Parameter	Name / value range / [default setting]	Info
0x2DA5:016 (P111.16)	Diagnostics of analog input 2: Status (AI2 diagnostics: AI2 status) • Read only	Bit-coded display of the status of analog input 2 (X3/AI2).
	Bit 0 Mode 0: 0 ... 10 VDC active	
	Bit 1 Mode 1: 0 ... 5 VDC active	
	Bit 2 Mode 2: 2 ... 10 VDC active	
	Bit 3 Mode 3: -10 ... 10 VDC active	
	Bit 4 Mode 4: 4 ... 20 mA active	
	Bit 5 Mode 5: 0 ... 20 mA active	
	Bit 6 24 V supply OK	
	Bit 7 Calibration successful	
	Bit 8 Monitoring threshold exceeded/not reached	
	Bit 9 Input current too low	
	Bit 10 Input voltage too low	
	Bit 11 Input voltage too high	
	Bit 12 Reserved	
	Bit 13 Reserved	
Bit 14 Reserved		
Bit 15 Reserved		
0x2DAA:001 (P112.01)	Diagnostics of analog output 1: Voltage (AO1 diagnostics: AO1 Voltage) • Read only: x.xx V	Display of the current output voltage at X3/AO1.
0x2DAA:002 (P112.02)	Diagnostics of analog output 1: Current (AO1 diagnostics: AO1 Current) • Read only: x.xx mA	Display of the present output current at X3/AO1.

Related topics

- ▶ [Configuration of analog inputs](#) 349
- ▶ [Configuration of analog outputs](#) 362

5.2.6 Process controller status

The following parameters serve to diagnose the process controller.

Parameter	Name / value range / [default setting]	Info
0x401F:001 (P121.01)	Process controller diagnostics: Current setpoint (PID diagnostics: PID setpoint) • Read only: x.xx PID unit	Display of the current reference value (setpoint) for the process controller.
0x401F:002 (P121.02)	Process controller diagnostics: Current process variable (PID diagnostics: PID process var.) • Read only: x.xx PID unit	Display of the current controlled variable (actual value) fed back for the process controller.
0x401F:003 (P121.03)	Process controller diagnostics: Status (PID diagnostics: PID status) • Read only	Bit-coded status display of the process controller.
	Bit 0 Process controller off	
	Bit 1 PID output set to 0	
	Bit 2 PID I-component set to 0	
	Bit 3 PID influence shown	
	Bit 4 Setpoint = actual value	
	Bit 5 Idle state active	
	Bit 6 Reserved	
Bit 7 Reserved		

Related topics

- ▶ [Configuring the process controller](#) 207

Diagnostics and fault elimination

Diagnostics parameter
Device identification



5.2.7 Device identification

The following parameters show some general information about the inverter.

Parameter	Name / value range / [default setting]	Info
0x2000:001 (P190.01)	Product code (Product code) <ul style="list-style-type: none">• Read only	Product code of the complete device. Example: "I51AE155D10V10017S"
0x2000:002 (P190.02)	Serial number (Serial number) <ul style="list-style-type: none">• Read only	Serial number of the complete device. Example: "0000000000000000XYZXYZ"
0x2000:004 (P190.04)	CU firmware version (CU firmware ver.) <ul style="list-style-type: none">• Read only	Firmware version of the control unit. Example: "01.00.01.00"
0x2000:005 (P190.05)	CU firmware type (CU firmware type) <ul style="list-style-type: none">• Read only	Firmware type of the control unit. Example: "IOFW51AC10"
0x2000:006 (P190.06)	CU bootloader version (CU bootlдер ver.) <ul style="list-style-type: none">• Read only	Bootloader version of the control unit. Example: "00.00.00.13"
0x2000:007 (P190.07)	CU bootloader type (CU bootlдер type) <ul style="list-style-type: none">• Read only	Bootloader type of the control unit. Example: "IOBL51AOnn"
0x2000:008 (P190.08)	Object directory version (OBD version) <ul style="list-style-type: none">• Read only	Example: "108478"
0x2000:010 (P190.10)	PU firmware version (PU firmware ver.) <ul style="list-style-type: none">• Read only	Firmware version of the power unit. Example: "00202"
0x2000:011 (P190.11)	PU firmware type (PU firmware type) <ul style="list-style-type: none">• Read only	Firmware type of the power unit. Example: "IDFW5AA"
0x2000:012 (P190.12)	PU bootloader version (PU bootlдер ver.) <ul style="list-style-type: none">• Read only	Bootloader version of the power unit.
0x2000:013 (P190.13)	PU bootloader type (PU bootlдер type) <ul style="list-style-type: none">• Read only	Bootloader type of the power unit.
0x2001 (P191.00)	Device name (Device name) ["My Device"]	Any device name (e.g. "Wheel drive") can be set in this object for the purpose of device identification.



5.2.8 Device overload monitoring (i*t)

The inverter calculates the i*t utilisation in order to protect itself against thermal overload. In simple terms: a higher current or an overcurrent that continues for a longer time causes a higher i*t utilisation.

⚠ DANGER!

Uncontrolled motor movements by pulse inhibit.

When the device overload monitoring function is activated, pulse inhibit is set and the motor becomes torqueless. A load that is connected to motors without a holding brake may therefore cause uncontrolled movements! Without a load, the motor will coast.

► Only operate the inverter under permissible load conditions.

Details

The device overload monitoring function primarily offers protection to the power section. Indirectly, also other components such as filter chokes, circuit-board conductors, and terminals are protected against overheating. Short-time overload currents followed by recovery periods (times of smaller current utilisation) are permissible. The monitoring function during operation checks whether these conditions are met, taking into consideration that higher switching frequencies and lower stator frequencies as well as higher DC voltages cause a greater device utilisation.

- If the device utilisation exceeds the warning threshold set in [0x2D40:002](#) (default setting: 95 %), the inverter outputs a warning.
- If the device utilisation exceeds the permanent error threshold 100 %, the inverter is disabled immediately and any further operation is stopped.

Device overload monitoring enables operation of the inverter under the following load conditions:

- Continuous current load with up to 100 % rated current.
- 3-minute cycle: 150 % rated current for 60 s, recovery phase 120 s with 75 % rated current.
- 15-second cycle: 200 % rated current for 3 s, recovery phase 12 s with 75 % rated current.

Parameter	Name / value range / [default setting]	Info
0x2D40:002	Device utilisation (i*t): Warning threshold 0 ... [95] ... 101 %	If the device utilisation exceeds the threshold set, the inverter outputs a warning. <ul style="list-style-type: none"> • With the setting 0 % or ≥ 100 %, the warning is deactivated.
0x2D40:004 (P135.04)	Device utilisation (i*t) (Device utilisat.: ixt utilisation) <ul style="list-style-type: none"> • Read only: x % 	Display of the current device utilisation.
0x2D40:005 (P135.05)	Device utilisation (i*t): Error response (Device utilisat.: Error response)	Selection of the response to be executed when the device overload monitoring function is triggered. Associated error code: <ul style="list-style-type: none"> • 9090 0x2382 - I*t error
	2 Trouble 3 Fault	► Error types 83
0x2DDF:001	Axis information: Rated current <ul style="list-style-type: none"> • Read only: x.xx A • Default setting depending on the size. 	Display of the rated current of the axis.

5.2.9 Heatsink Temperature Monitoring

Parameter	Name / value range / [default setting]	Info
0x2D84:001 (P117.01)	Heatsink temperature (Heatsink temp.: Heatsink temp.) <ul style="list-style-type: none"> • Read only: x.x °C 	Display of the current heatsink temperature.

Diagnostics and fault elimination

Diagnostics parameter
Life-diagnosis



Parameter	Name / value range / [default setting]	Info
0x2D84:002	Heatsink temperature: Warning threshold 50.0 ... [80.0]* ... 100.0 °C • Default setting depending on the size.	Warning threshold for temperature monitoring. • If the heatsink temperature exceeds the threshold set here, the inverter outputs a warning. • The warning is reset with a hysteresis of approx. 5 °C. • If the heatsink temperature increases further and exceeds the non-adjustable error threshold (100 °C), the inverter changes to the "Fault" device status. The inverter is disabled and thus any further operation is stopped.

5.2.10 Life-diagnosis

The following parameters provide some information about the use of the inverter.

This includes the following information:

- Operating and power-on time of the inverter/control unit
- Operating time of the internal fan
- Number of switching cycles of the mains voltage
- Number of switching cycles of the relay
- Number of short-circuits and earth faults that have occurred
- Display of the number of "Imax: Clamp responded too often" errors that have occurred.

Parameter	Name / value range / [default setting]	Info
0x2D81:001 (P151.01)	Life-diagnosis: Operating time (Life-diagnosis: Operating time) • Read only: x s	Display showing for how long the inverter has been running so far "Operation enabled" device state).
0x2D81:002 (P151.02)	Life-diagnosis: Operating time (Life-diagnosis: Operating time) • Read only: x s	Display showing for how long the inverter has been supplied with mains voltage so far.
0x2D81:003 (P151.03)	Life-diagnosis: Control unit operating time (Life-diagnosis: CU oper. time) • Read only: x ns	Display showing how long the control unit of the inverter has been supplied with voltage via the USB module. Display showing how long the control unit of the inverter has been switched on for so far. • This also includes the time within which the control unit has only been supplied with an external 24 V voltage.
0x2D81:004 (P151.04)	Life-diagnosis: Main switching cycles (Life-diagnosis: Switching cycles) • Read only	Display of the number of switching cycles of the mains voltage.
0x2D81:005 (P151.05)	Life-diagnosis: Relay switching cycles (Life-diagnosis: Relay cycles) • Read only	Display of the number of switching cycles of the relay.
0x2D81:006 (P151.06)	Life-diagnosis: Short-circuit counter (Life-diagnosis: Short-circ.count) • Read only	Display of the number of short circuits that have occurred.
0x2D81:007 (P151.07)	Life-diagnosis: Earth fault counter (Life-diagnosis: Earthfault count) • Read only	Display of the number of earth faults that have occurred.
0x2D81:008 (P151.08)	Life-diagnosis: Clamp active (Life-diagnosis: Clamp active) • Read only	Display of the number of "Imax: Clamp responded too often" errors that have occurred. • "Clamp" = short-time inhibit of the inverter in V/f operation when the current limit shown in 0x2DDF:002 is reached.
0x2D81:009 (P151.09)	Life-diagnosis: Fan operating time (Life-diagnosis: Fan oper. time) • Read only: x s	Display showing for how long the internal fan has been running so far.



5.3 Error handling

Many functions integrated in the inverter can

- detect errors and thus protect inverter and motor from damages,
- detect an operating error of the user,
- output a warning or information if desired.

5.3.1 Error types

In the event of an error, the inverter response is determined by the error type defined for the error.

In the following, the different error types are described.

Error type "No response"

The error is completely ignored (does not affect the running process).

Error type "Warning"

A warning does not severely affect the process and may be also ignored in consideration of safety aspects.

Error type "Fault"

The motor is brought to a standstill with the quick stop ramp.

- The inverter will only be disabled after the quick stop is executed (motor at standstill) or after the time-out time set in [0x2826](#) has been elapsed. ▶ [Timeout für fault reaction](#) [380](#)
- **Exception:** In case of a serious fault, the inverter is disabled immediately. The motor becomes torqueless (coasts). For details see the table "[Error codes](#)". [378](#)

Error type "Trouble"

Just like "Fault", but the error state will be left automatically if the error condition is not active anymore.



- **Exception:** In case of a severe trouble, the inverter is disabled immediately. The motor becomes torqueless (coasts). For details see the table "[Error codes](#)". [378](#)
- The restart behaviour after trouble can be configured. ▶ [Automatic restart](#) [281](#)



In the operating mode [0x6060 \(P301.00\)](#) = "CiA: Velocity mode [2]", the behaviour in case of "Trouble" is just like in case of "Fault"!

Comparison of the error types

The following table compares the main differences of the error types:

Error type	Logging in the Error history buffer / Logbook	Display in the CiA 402 status word 0x6041 (P780.00)	Inverter disable	Motor stop	Error reset is required	"ERR" LED (red)
No response	No	No	No	No	No	off
Warning	Yes	yes, bit 7	No	No	No	 blinking fast (4 Hz)
Trouble	Yes	yes, bit 3	after quick stop or immediately.	quick stop ramp or coasting.	No	 blinking (1 Hz)
Error	Yes	yes, bit 3	For details see table " Error codes ". 378		Yes	 on

Diagnostics and fault elimination

Error handling
Error configuration



5.3.2 Error configuration

The errors can be divided into two types:

- Errors with predefined error type
- Errors with configurable error type



Especially critical errors are permanently set to the "Fault" error type in order to protect inverter and motor from damages.

In case of errors with configurable error type, the default setting can be changed in consideration of safety aspects and the operational performance. The selection "No response [0]" is, however, only available for minor errors.

The "Error codes" table lists the error type for each error. If the error type can be configured by the user, the "adjustable in" column displays the corresponding parameter. [378](#)

5.3.3 Error reset

If the error condition is not active anymore, there are several options to reset an active error and thus leave the error state again:

- Via the keypad key . [Error reset with keypad 373](#)
- Via the trigger assigned to the "Reset fault" function. [Reset error 329](#)
- Via the button  in the »EASY Starter« ("Diagnostics" tab).
- In the default setting of [0x400E:008 \(P505.08\)](#) via bit 7 in the mappable data word NET-WordIN1 [0x4008:001 \(P590.01\)](#).
- Via bit 7 in the mappable CiA 402 control word [0x6040](#).
- Via bit 2 in the mappable AC Drive control word [0x400B:001 \(P592.01\)](#).
- Via bit 11 in the mappable LECOM control word [0x400B:002 \(P592.02\)](#).

Notes:

- Certain errors can only be reset by mains switching.
- Certain errors (e. g. earth fault or short circuit of the motor phases) may cause a blocking time. In this case, the error can be reset only after the blocking time has elapsed. An active blocking time is displayed via bit 14 in the inverter status word [0x2831](#).

The "Error codes" table gives the blocking time (if available) for each error. This table also shows whether mains switching is required for the error reset. [378](#)

5.3.4 Keypad error messages

If an error is pending, the keypad shows the following information:

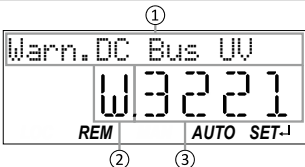
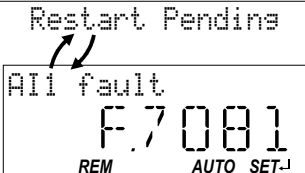
Keypad display	Meaning						
 <ul style="list-style-type: none"> • Faults (F) and trouble (T) are displayed continuously. • Warnings (W) are only displayed every 2 seconds for a short time. 	<p>① Error text</p> <p>② Error type:</p> <table border="1"> <tr><td>F</td><td>Fault</td></tr> <tr><td>T</td><td>Trouble</td></tr> <tr><td>W</td><td>Warning</td></tr> </table> <p>③ Error code (hexadecimal)</p> <p>Error codes 378</p> <p>Error reset with keypad 373</p>	F	Fault	T	Trouble	W	Warning
F	Fault						
T	Trouble						
W	Warning						
	<p>After a disturbance, a restart is possible if the error condition is not active anymore. The keypad shows this by the "Restart Pending" note. The note is displayed in a 1-second interval alternating with the error text.</p> <p>Timeout für fault reaction 280</p>						



6 Basic setting

This chapter contains the most frequently used functions and settings to adapt the inverter to a simple application based on the default setting.

- [Mains voltage](#) 86
- [Control source selection](#) 88
- [Selection of setpoint source](#) 89
- [Starting/stopping performance](#) 91
- [Frequency limits and ramp times](#) 92
- [Quick stop](#) 95
- [S-shaped ramps](#) 97
- [Optical device identification](#) 98

Basic setting

Mains voltage



6.1 Mains voltage

The rated mains voltage set for the inverter has an impact on the operating range of the inverter.

Details

By default, the rated mains voltage in [0x2540:001 \(P208.01\)](#) is set according to the product code of the inverter.



Check the setting of the rated mains voltage in [0x2540:001 \(P208.01\)](#). Ensure that it matches the actual mains voltage applied!

Region	inverter	Product code 0x2000:001 (P190.01)	Rated mains voltage	
			Default setting	Possible settings
EU	i500, 230 V, 1-phase	i5xAExxBxxxx0xxxx	230 Veff [0]	230 Veff [0]
US	i500, 230 V, 1-phase	i5xAExxBxxxx1xxxx	230 Veff [0]	230 Veff [0]
EU	i500, 230 V, 1/3-phase	i5xAExxDxxxx0xxxx	230 Veff [0]	230 Veff [0]
US	i500, 230 V, 1/3-phase	i5xAExxDxxxx1xxxx	230 Veff [0]	230 Veff [0]
EU	i500, 400 V, 3-phase	i5xAExxFxxxx0xxxx	400 Veff [1]	400 Veff [1], 480 Veff [2]
US	i500, 480 V, 3-phase	i5xAExxFxxxx1xxxx	480 Veff [2]	400 Veff [1], 480 Veff [2]

Notes regarding the table:

- The inverter types 400/480 V can be used with different mains voltages. For setting the internal limit values, the rated mains voltage can be set in [0x2540:001 \(P208.01\)](#) by the user.
- If the inverter is reset to the delivery status, the rated mains voltage is also reset to the default setting listed in the table according to the product code.

The following results from the rated mains voltage set:

- the error threshold for monitoring the DC-bus voltage and
- the voltage threshold for braking operation ("brake chopper threshold").

Monitoring of the DC-bus voltage

- The warning thresholds for monitoring are adjustable.
- The error thresholds and reset thresholds for monitoring result from the rated mains voltage set:

Rated mains voltage	Undervoltage thresholds			Overvoltage thresholds		
	Warning threshold	Error threshold	Reset threshold	Warning threshold	Error threshold	Reset threshold
Setting in 0x2540:001 (P208.01)	Setting in 0x2540:002 (P208.02)	Display in 0x2540:003 (P208.03)	Display in 0x2540:004 (P208.04)	Setting in 0x2540:005 (P208.05)	Display in 0x2540:006 (P208.06)	Display in 0x2540:007 (P208.07)

- If the DC-bus voltage of the inverter falls below the undervoltage error threshold, the "Trouble" response is triggered. The motor behaves in accordance with [0x2838:002 \(P203.02\)](#).
- If the DC-bus voltage of the inverter exceeds the overvoltage error threshold, the "Fault" response is triggered.



The motor does not restart automatically after the overvoltage monitoring function has been activated.

Parameter	Name / value range / [default setting]	Info
0x2540:001 (P208.01)	Mains settings: Rated mains voltage (Mains settings: Mains voltage)	Selection of the mains voltage for actuating the inverter.
	<ul style="list-style-type: none"> Setting can only be changed if the inverter is inhibited. 	
	0 230 Veff	
	1 400 Veff	
	2 480 Veff	



Basic setting

Mains voltage

Parameter	Name / value range / [default setting]	Info
0x2540:002 (P208.02)	Mains settings: Undervoltage warning threshold (Mains settings: LU warn. thresh.) 0 ... [0]* ... 800 V • Default setting depending on the size.	Setting of the warning threshold for monitoring DC bus undervoltage. • If the DC bus voltage falls below the threshold set, the inverter outputs a warning. • The warning is reset with a hysteresis of 10 V.
0x2540:003 (P208.03)	Mains settings: Undervoltage error threshold (Mains settings: LU error thresh.) • Read only: x V • Default setting depending on the size.	Display of the fixed error threshold for monitoring DC bus undervoltage. • If the DC-bus voltage falls below the threshold displayed, the "Fault" response is triggered.
0x2540:004 (P208.04)	Mains settings: Undervoltage reset threshold (Mains settings: LU reset thresh.) • Read only: x V • Default setting depending on the size.	Display of the fixed reset threshold for monitoring DC bus undervoltage.
0x2540:005 (P208.05)	Mains settings: Overvoltage warning threshold (Mains settings: OU warn. thresh.) 0 ... [0]* ... 800 V • Default setting depending on the size.	Setting of the warning threshold for monitoring DC bus overvoltage. • If the DC bus voltage exceeds the threshold set, the inverter outputs a warning. • The warning is reset with a hysteresis of 10 V.
0x2540:006 (P208.06)	Mains settings: Overvoltage error threshold (Mains settings: OU error thresh.) • Read only: x V • Default setting depending on the size.	Display of the fixed error threshold for monitoring the DC bus overvoltage. • If the DC-bus voltage exceeds the threshold displayed, the "Fault" response is triggered.
0x2540:007 (P208.07)	Mains settings: Overvoltage reset threshold (Mains settings: OU reset thresh.) • Read only: x V • Default setting depending on the size.	Display of the fixed reset threshold for monitoring DC bus overvoltage.



6.2 Control source selection

The selected "control source" serves to provide the inverter with its start, stop, and reversal commands.

Possible control sources are:

- Digital inputs
- Keypad
- Network





Irrespective of the control source selection, stop commands are always active from each source connected! If, for instance, the network control is active and a keypad is connected for diagnostic purposes, the motor is also stopped if the keypad key  is pressed.

Exception: In the jog operation, a stop command has no impact.

Details

- The default setting "Flexible I/O configuration [0]" in [0x2824 \(P200.00\)](#) enables a flexible control of the inverter via digital inputs, network and keypad. The control of the inverter via the digital inputs is preconfigured. For details see the chapter "[Function assignment of the inputs and outputs](#)". [📖 38](#)
- If the keypad is to be used as the sole control source for the application, selection "Keypad [1]" is to be set in [0x2824 \(P200.00\)](#).
- The control source that is currently active is displayed in [0x282B:001 \(P125.01\)](#).

Parameter	Name / value range / [default setting]	Info
0x2824 (P200.00)	Control selection (Control select.)	Selection of the type of inverter control.
	0 Flexible I/O configuration	This selection enables a flexible assignment of the start, stop, and rotating direction commands with digital signal sources. <ul style="list-style-type: none"> • Digital signal sources can be digital inputs, network and keypad. • The I/O configuration is made via the parameters 0x2631:xx (P400.xx).
	1 Keypad	This selection enables the motor to be started exclusively via the start key of the keypad. Other signal sources for starting the motor are ignored. <p> Start motor  Stop motor</p> <p>Note!</p> <ul style="list-style-type: none"> • The functions "Enable inverter" 0x2631:001 (P400.01) and "Run" 0x2631:002 (P400.02) must be set to TRUE to start the motor. • If jog operation is active, the motor cannot be stopped via the  keypad key.
0x282B:001 (P125.01)	Inverter diagnostics: Active control source (Inverter diag.: Active control)	Display of the control source that is currently active.
	• Read only	
	0 Flexible I/O configuration	
	1 Network	
	2 Keypad	

Related topics

- The preset I/O configuration can be individually adapted to the respective application. For details see the chapter "[Flexible I/O configuration](#)". [📖 292](#)
- For details of the network control of the inverter, see the chapter "[General network settings](#)". [📖 137](#)



6.3 Selection of setpoint source

The selected "setpoint source" serves to provide the inverter with its setpoint. The setpoint source can be selected individually for each operating mode.

Possible setpoint sources are:

- Analog inputs
- Keypad
- Network
- Parameterisable setpoints (preset values)
- "Motor potentiometer" function

Details

- For applications only requiring one setpoint it is sufficient to define the standard setpoint source in the following parameters.
- For applications requiring a change-over of the setpoint source during operation, the functions for setpoint change-over have to be configured accordingly. [▶ Setpoint change-over](#)

[📖 313](#)

Parameter	Name / value range / [default setting]	Info
0x2860:001 (P201.01)	Frequency control: Default setpoint source (Stnd. setpoints: Freq. setp. src.)	Selection of the standard setpoint source for operating mode "MS: Velocity mode". <ul style="list-style-type: none"> • The selected standard setpoint source is always active in the operating mode 0x6060 (P301.00) = "MS: Velocity mode [-2]" when no setpoint change-over to another setpoint source via corresponding triggers/functions is active. ▶ Setpoint change-over 📖 313
	1 Keypad	The setpoint is specified locally by the keypad. <ul style="list-style-type: none"> • Default setting: 0x2601:001 (P202.01) • Use the \uparrow and \downarrow navigation keys to change the keypad setpoint (also during running operation).
	2 Analog input 1	The setpoint is specified analogously via X3/AI1. ▶ Analog input 1 📖 349
	3 Analog input 2	The setpoint is specified analogously via X3/AI2. ▶ Analog input 2 📖 353
	5 Network	The setpoint is specified via network. ▶ Configuring the network 📖 136
	11 Frequency preset 1	For the setpoint selection, preset values can be parameterised and selected. ▶ Setpoint source of preset setpoints 📖 320
	12 Frequency preset 2	
	13 Frequency preset 3	
	14 Frequency preset 4	
	15 Frequency preset 5	
	16 Frequency preset 6	
	17 Frequency preset 7	
	18 Frequency preset 8	
	19 Frequency preset 9	
	20 Frequency preset 10	
	21 Frequency preset 11	
	22 Frequency preset 12	
23 Frequency preset 13		
24 Frequency preset 14		
25 Frequency preset 15		
50 Motor potentiometer	The setpoint is generated by the "Motor potentiometer" function. ▶ Motor potentiometer setpoint source (MOP) 📖 325	

Basic setting

Selection of setpoint source
Keypad setpoint default setting



Parameter	Name / value range / [default setting]	Info
0x2860:002 (P201.02)	PID control: Default setpoint source (Std. setpoints: PID setp. src.)	Selection of the standard setpoint source for the reference value of the PID control. <ul style="list-style-type: none"> The selected standard setpoint source is always active with an activated PID control when no setpoint change-over to another setpoint source via corresponding triggers/functions is active.
	1 Keypad	The setpoint is specified locally by the keypad. <ul style="list-style-type: none"> Default setting: 0x2601:002 (P202.02) Use the ↑ and ↓ navigation keys to change the keypad setpoint (also during running operation).
	2 Analog input 1	The setpoint is specified analogously via X3/AI1. ▶ Analog input 1 □ 349
	3 Analog input 2	The setpoint is specified analogously via X3/AI2. ▶ Analog input 2 □ 353
	5 Network	The setpoint is specified via network. Configuring the network □ 136
	11 PID preset 1	For the setpoint selection, preset values can be parameterised and selected. ▶ Setpoint source of preset setpoints □ 320
	12 PID preset 2	
	13 PID preset 3	
	14 PID preset 4	
	15 PID preset 5	
	16 PID preset 6	
	17 PID preset 7	
	18 PID preset 8	
	31 Segment preset 1 • From version 02.00	
	32 Segment preset 2 • From version 02.00	
	33 Segment preset 3 • From version 02.00	
	34 Segment preset 4 • From version 02.00	
	35 Segment preset 5 • From version 02.00	
	36 Segment preset 6 • From version 02.00	
	37 Segment preset 7 • From version 02.00	
38 Segment preset 8 • From version 02.00		
50 Motor potentiometer	The setpoint is generated by the "Motor potentiometer" function. ▶ Motor potentiometer setpoint source (MOP) □ 325	

6.3.1 Keypad setpoint default setting

For the manual setpoint selection via keypad the following default settings are used.

Parameter	Name / value range / [default setting]	Info
0x2601:001 (P202.01)	Keypad setpoints: Frequency setpoint (Keypad setpoints: KP freq.setpoint) 0.0 ... [20.0] ... 599.0 Hz	Default setting of the keypad setpoint for the operating mode 0x6060 (P301.00) = "MS: Velocity mode [-2]".
0x2601:002 (P202.02)	Keypad setpoints: Process controller setpoint (Keypad setpoints: KP PID setpoint) -300.00 ... [0.00] ... 300.00 PID unit	Default setting of the keypad setpoint for the reference value of the PID control.

The increment for keypad setpoints can be adapted in [0x2862 \(P701.00\)](#) by pressing a keypad arrow key once.



6.4 Starting/stopping performance

6.4.1 Starting performance

The start can be optionally made with DC braking or flying restart circuit. Moreover, an automatic start can be activated after switch-on.

Parameter	Name / value range / [default setting]	Info
0x2838:001 (P203.01)	Start/stop configuration: Start method (Start/stop cfg: Start method) <ul style="list-style-type: none"> Setting can only be changed if the inverter is inhibited. 	Behaviour after start command.
	0 Normal	After start command, the standard ramps are active. <ul style="list-style-type: none"> Acceleration time 1 can be set in 0x2917 (P220.00). Deceleration time 1 can be set in 0x2918 (P221.00).
	1 DC braking	After start command, the "DC braking" function is active for the time set in 0x2B84:002 (P704.02) . ▶ DC braking ☐ 224
	2 Flying restart circuit	After the start command, the flying restart circuit is active. The flying restart function makes it possible to restart a coasting motor during operation without speed feedback. Synchronicity between the inverter and motor is coordinated so that the transition to the rotating motor is effected without jerk at the time of connection. ▶ Flying restart circuit ☐ 278
0x2838:002 (P203.02)	Start/stop configuration: Start at power-up (Start/stop cfg: Start at powerup)	Starting performance after switching on the mains voltage.
	0 Off	No automatic start after switching on mains voltage. In addition to the inverter enable, a renewed start command is always required to start the motor.
	1 On	Automatic start of the motor after switching on the mains voltage if the inverter is enabled and a start command exists.

6.4.2 Stopping performance

In the default setting, the motor is brought to a standstill after a stop command with standard ramp. Alternatively, coasting or ramping down with quick stop ramp can be selected.

Parameter	Name / value range / [default setting]	Info
0x2838:003 (P203.03)	Start/stop configuration: Stop method (Start/stop cfg: Stop method)	Behaviour after the "Stop" command.
	0 Coasting	The motor becomes torqueless (coasts down to standstill).
	1 Standard ramp	The motor is brought to a standstill with deceleration time 1 (or deceleration time 2, if activated). <ul style="list-style-type: none"> Deceleration time 1 can be set in 0x2918 (P221.00). Deceleration time 2 can be set in 0x291A (P223.00). ▶ Frequency limits and ramp times ☐ 92
	2 Quick stop ramp	The motor is brought to a standstill with the deceleration time set for the "Quick stop" function. <ul style="list-style-type: none"> Deceleration time for quick stop can be set in 0x291C (P225.00). The "quick stop" function can also be activated manually, for instance via a digital input. ▶ Quick stop ☐ 95

Basic setting

Frequency limits and ramp times



6.5 Frequency limits and ramp times

The frequency range can be limited by setting a minimum and maximum frequency. For the frequency setpoint, two different ramps can be parameterised. Change-over to ramp 2 can be carried out manually or automatically.

Details

The frequency setpoint is internally led via a ramp generator.

- The acceleration time set in [0x2917 \(P220.00\)](#) refers to an acceleration from standstill to the maximum frequency set in [0x2916 \(P211.00\)](#). At a low setpoint selection, the real acceleration time decreases accordingly.
- The deceleration time set in [0x2918 \(P221.00\)](#) refers to the deceleration of the set maximum frequency to standstill. In case of a lower actual frequency, the actual deceleration time is reduced accordingly.

Input signals

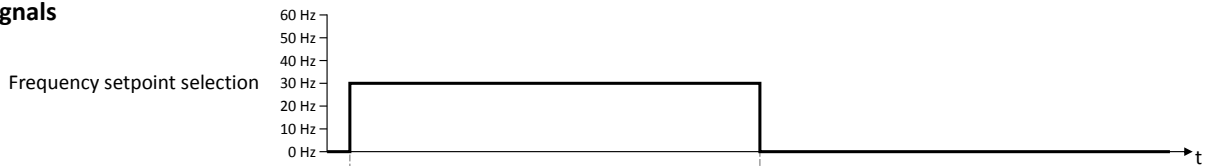

Output signals

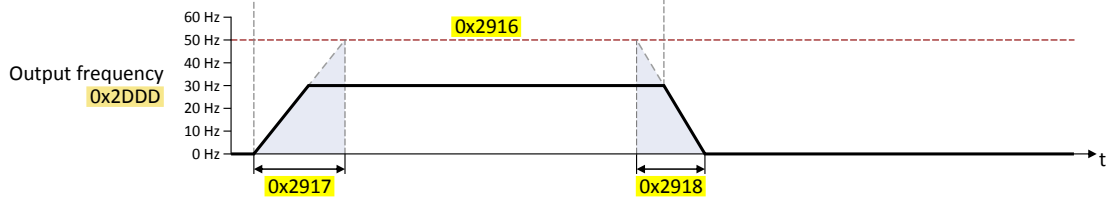

Automatic/manual change-over to ramp 2

- For ramp 2, the acceleration time 2 set in [0x2919 \(P222.00\)](#) and the deceleration time 2 set in [0x291A \(P223.00\)](#) apply.
- The change-over to ramp 2 is effected automatically if the frequency setpoint (absolute value) \geq auto-changeover threshold [0x291B \(P224.00\)](#).

Input signals

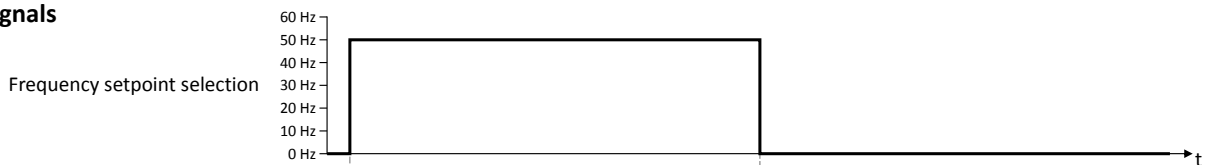

Output signals

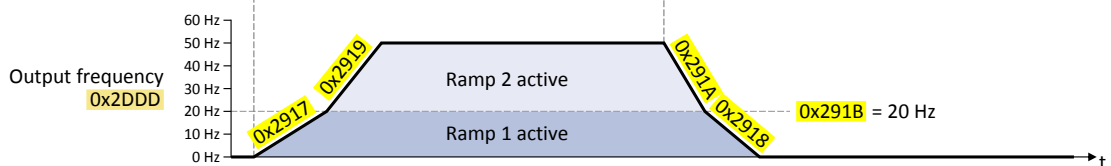

- The "Activate ramp 2" function serves to manually activate the acceleration time 2 and the deceleration time 2. [▶ Activating ramp 2 manually](#) [□ 335](#)

Parameter	Name / value range / [default setting]	Info
0x2915 (P210.00)	Minimum frequency (Min. frequency) 0.0 ... [0.0] ... 599.0 Hz	Lower limit value for all frequency setpoints.
0x2916 (P211.00)	Maximum frequency (Max. frequency) 0.0 ... [50.0] ... 599.0 Hz	Upper limit value for all frequency setpoints.
0x2917 (P220.00)	Acceleration time 1 (Accelerat.time 1) 0.0 ... [5.0] ... 3600.0 s	Acceleration time 1 for the operating mode "MS: Velocity mode". <ul style="list-style-type: none"> • The acceleration time set refers to the acceleration from standstill to the maximum frequency set. In the case of a lower setpoint selection, the actual acceleration time is reduced accordingly. • Setting is not effective in the operating mode 0x6060 (P301.00) = "CiA: Velocity mode [2]". ▶ Device profile CiA 402 □ 262



Parameter	Name / value range / [default setting]	Info
0x2918 (P221.00)	Deceleration time 1 (Decelerat.time 1) 0.0 ... [5.0] ... 3600.0 s	Deceleration time 1 for the operating mode "MS: Velocity mode". <ul style="list-style-type: none"> The deceleration time set refers to the deceleration from the maximum frequency set to standstill. In the case of a lower actual frequency, the actual deceleration time is reduced accordingly. Setting is not effective in the operating mode 0x6060 (P301.00) = "CiA: Velocity mode [2]". ▶ Device profile CiA 402 □ 262
0x2919 (P222.00)	Acceleration time 2 (Accelerat.time 2) 0.0 ... [5.0] ... 3600.0 s	Acceleration time 2 for the operating mode "MS: Velocity mode". <ul style="list-style-type: none"> The acceleration time set refers to the acceleration from standstill to the maximum frequency set. In the case of a lower setpoint selection, the actual acceleration time is reduced accordingly. The acceleration time 2 is active if the frequency setpoint (absolute value) \geq auto switching threshold 0x291B (P224.00) or the trigger assigned to the function "Activate ramp 2" in 0x2631:039 (P400.39) = TRUE. The acceleration time 2 is also used for changing the MOP setpoint generated by the "motor potentiometer" function. Setting is not effective in the operating mode 0x6060 (P301.00) = "CiA: Velocity mode [2]". ▶ Device profile CiA 402 □ 262
0x291A (P223.00)	Deceleration time 2 (Decelerat.time 2) 0.0 ... [5.0] ... 3600.0 s	Deceleration time 2 for the operating mode "MS: Velocity mode". <ul style="list-style-type: none"> The deceleration time set refers to the deceleration from the maximum frequency set to standstill. In the case of a lower actual frequency, the actual deceleration time is reduced accordingly. The deceleration time 2 is active if the frequency setpoint (absolute value) \geq auto change-over threshold 0x291B (P224.00) or the trigger assigned to the function "Activate ramp 2" in 0x2631:039 (P400.39) = TRUE. The deceleration time 2 is also used for changing the MOP setpoint generated by the "motor potentiometer" function. Setting is not effective in the operating mode 0x6060 (P301.00) = "CiA: Velocity mode [2]". ▶ Device profile CiA 402 □ 262
0x291B (P224.00)	Auto-changeover threshold of ramp 2 (Ramp 2 thresh.) 0.0 ... [0.0] ... 599.0 Hz	Threshold for the automatic change-over to acceleration time 2 and deceleration time 2. <ul style="list-style-type: none"> The change-over is effected if the frequency setpoint (absolute value) \geq auto change-over threshold. With the setting 0, the automatic change-over function is deactivated.



Example for operating mode

Parameter	Name	Setting for this example
0x2631:001 (P400.01)	Enable inverter	Constant TRUE [1]
0x2631:002 (P400.02)	Run	Digital input 1 [11]
0x2915 (P210.00)	Minimum frequency	15 Hz
0x2916 (P211.00)	Maximum frequency	40 Hz
0x2917 (P220.00)	Acceleration time 1	4 s
0x2918 (P221.00)	Deceleration time 1	3 s

Input signals

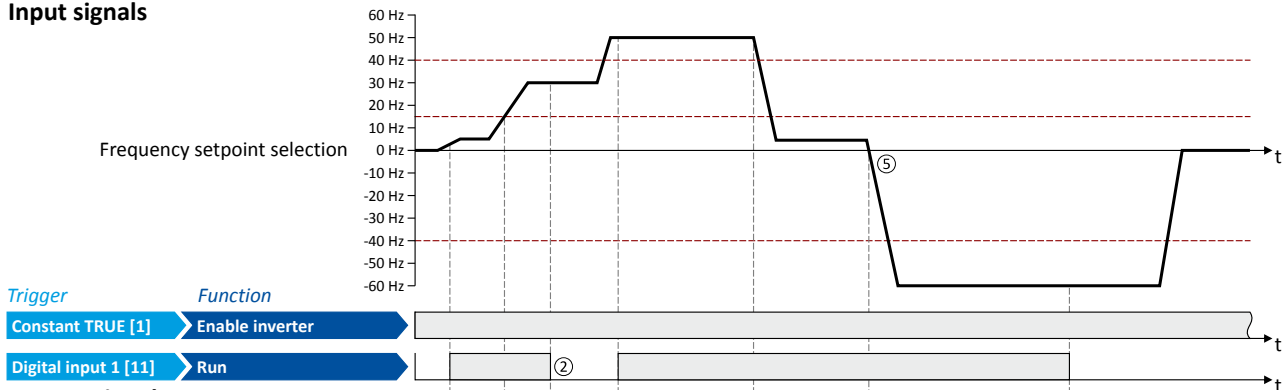

Output signals

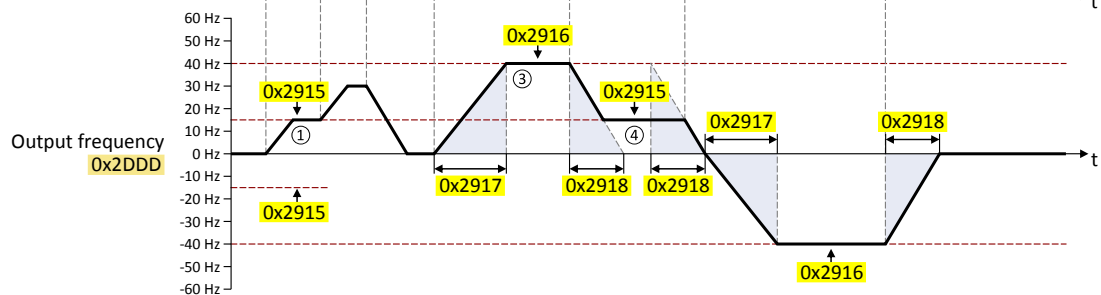

- ① After a start command, the motor is accelerated to the minimum frequency. This is also the case if the setpoint selection is = 0 Hz. If the setpoint exceeds the minimum frequency, the ramp generator follows the setpoint.
- ② If the start command is deactivated again, the motor is stopped with the stop method set in 0x2838:003 (P203.03) (here: Standard ramp).
- ③ The motor is accelerated to the set maximum frequency.
- ④ If the setpoint falls below the minimum frequency, it is decelerated up to the minimum frequency.
- ⑤ In case of a sign reversal of the setpoint, a change of direction of rotation takes place, minimum and maximum frequency, however, continue to apply.



6.6 Quick stop

The "quick stop" function is an alternative stop method if the motor has to be stopped faster than normal.



Cancelling the quick stop causes a restart of the motor if the start command is still active and the inverter is enabled!

Details

- Possible triggers to be selected for the "quick stop" function are available for example in [0x2631:003 \(P400.03\)](#) the digital inputs and internal status signals of the inverter.
- An activation via network is possible via the mappable NetWordIN1 data word or one of the predefined process data words. ▶ [General network settings](#) [137](#)

Diagnostic parameters:

- [0x282A:002 \(P126.02\)](#) displays the cause of quick stop bit-coded.

Parameter	Name / value range / [default setting]	Info
0x291C (P225.00)	Quick stop deceleration time (QSP dec. time) 0.0 ... [1.0] ... 3600.0 s	Quick stop deceleration time for the operating mode "MS: Velocity mode". <ul style="list-style-type: none"> • If the "Quick stop" function is activated, the motor is brought to a standstill within the deceleration time set here. • The deceleration time set refers to the deceleration from the maximum frequency set to standstill. In the case of a lower actual frequency, the actual deceleration time is reduced accordingly. • Setting is not effective in the operating mode 0x6060 (P301.00) = "CiA: Velocity mode [2]". ▶ Device profile CiA 402 262
0x2631:003 (P400.03)	Function list: Activate quick stop (Function list: Quick stop) <ul style="list-style-type: none"> • Setting can only be changed if the inverter is inhibited. • For possible settings see description for 0x2631:001 (P400.01). 300 	Assignment of a trigger for the "Activate quick stop" function. Trigger = TRUE: Activate quick stop. Trigger = FALSE: Deactivate quick stop. Notes: <ul style="list-style-type: none"> • The "Quick stop" function brings the motor to a standstill within the deceleration time set in 0x291C (P225.00).
	00 Not connected	No trigger assigned (trigger is constantly FALSE).

Basic setting

Quick stop



Example for operating mode

Parameter	Name	Setting for this example
0x2631:001 (P400.01)	Enable inverter	Constant TRUE [1]
0x2631:002 (P400.02)	Run	Digital input 1 [11]
0x2631:003 (P400.03)	Activate quick stop	Digital input 2 [12]
0x2838:003 (P203.03)	Stop method	Standard ramp [1]
0x2916 (P211.00)	Maximum frequency	50 Hz
0x2917 (P220.00)	Acceleration time 1	4 s
0x2918 (P221.00)	Deceleration time 1	3 s
0x291C (P225.00)	Quick stop deceleration time	1 s

Input signals

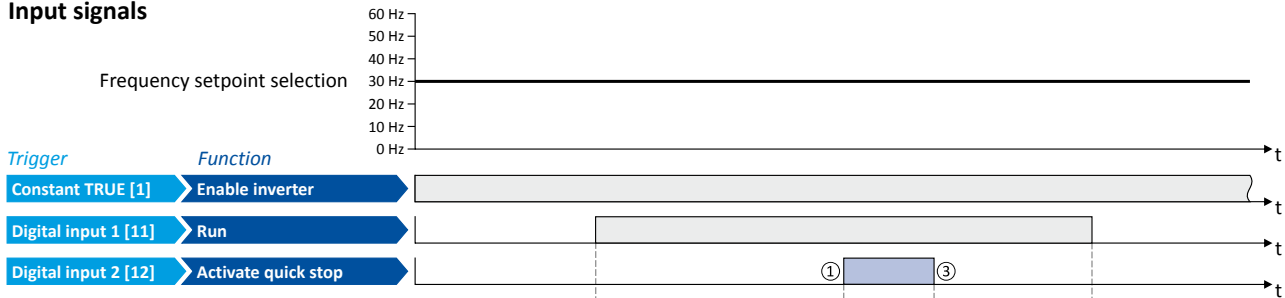

Output signals

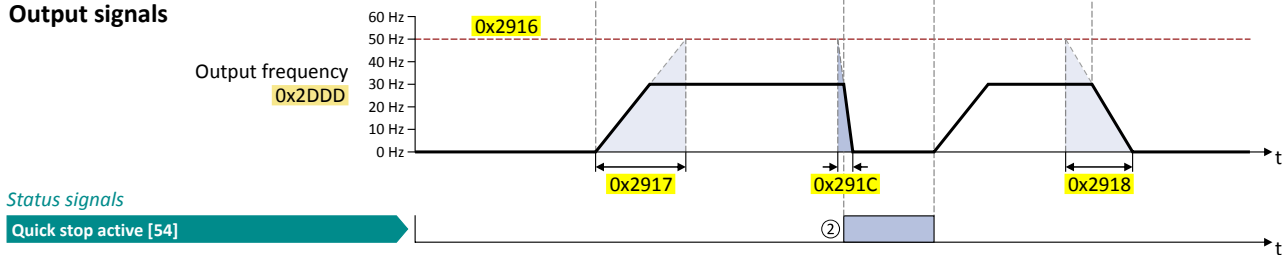

- ① Quick stop is activated: The motor is brought to a standstill within the deceleration time set in 0x291C (P225.00).
- ② If quick stop is active, the status signal "Quick stop active [54]" is set to TRUE. This status signal can be assigned via the Flexible I/O configuration of a function or a digital output.
- ③ Quick stop is deactivated again: The motor accelerates again to the setpoint since the start command is still active.



6.7 S-shaped ramps

In order to reduce the jerk and to therefore prevent the drive components from damage, a smoothing factor can be set for the acceleration/deceleration ramps.

Details

In the default setting, the motor is accelerated and decelerated with linear ramps since this is the most used configuration. The setting of a smoothing factor causes S-shaped ramps. This leads to a smoother starting and braking behaviour which, for instance, is used for sensitive machine parts with backlash. It has to be observed here that the setting of a smoothing factor causes longer acceleration and delay times (see the following diagrams).

Input signals

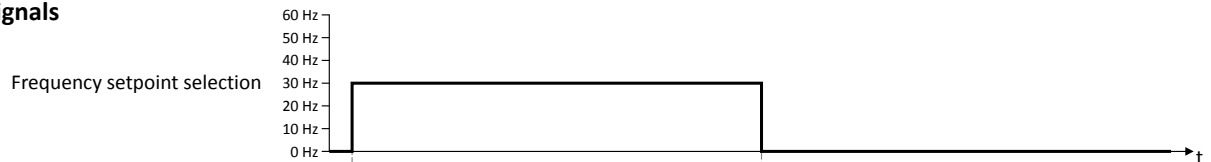

Output signals

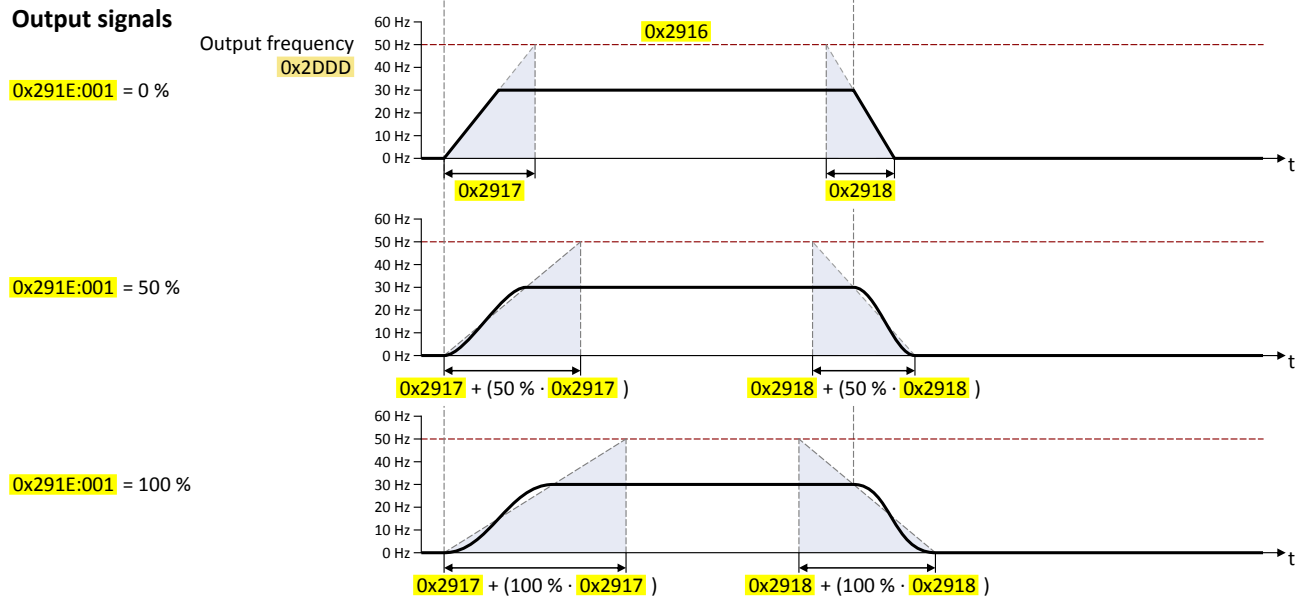

Parameter	Name / value range / [default setting]	Info
0x291E:001 (P226.01)	S-Ramp characteristic: Smoothing factor (S-ramp char.: Smoothing factor) 0.0 ... [0.0] ... 100.0 %	Factor for S-rounding of the acceleration/deceleration ramps. <ul style="list-style-type: none"> With the setting "0.0", the S-rounding is deactivated and acceleration/ deceleration with linear ramps is carried out.



6.8 Optical device identification

For applications including several interconnected inverters it may be difficult to locate a device that has been connected online. The "Optical device identification" function serves to locate the inverter by means of blinking LEDs.

Details

In order to start the visual tracking,

- click the button in the toolbar of the »EASY Starter«  or
- set **0x2021:001 (P230.01)** = "Start [1]".

After the start, both LEDs "RDY" and "ERR" on the front of the inverter synchronously blink very fast.

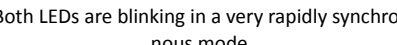
"RDY" LED (blue)	"ERR" LED (red)	Status/meaning
		"Visual tracking" function is active.
Both LEDs are blinking in a very rapidly synchronous mode		

The blinking duration can be set in **0x2021:002 (P230.02)** or selected in the »EASY Starter« in the dropdown list field:

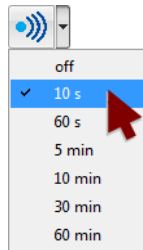







Parameter	Name / value range / [default setting]	Info		
0x2021:001 (P230.01)	Optical tracking: Start detection (Optical tracking: Start detection)	1 = start optical device identification. <ul style="list-style-type: none"> • After the start, the two LEDs "RDY" and "ERR" on the front of the inverter are blinking with a blinking frequency of 20 Hz for the blinking duration set in 0x2021:002 (P230.02). The setting is then automatically reset to "0" again. • If the function is reactivated within the blinking time set, the time is extended correspondingly. • A manual reset to "0" makes it possible to stop the function prematurely. 		
	<table border="1"> <tr> <td>0</td> <td>Stop</td> </tr> <tr> <td>1</td> <td>Start</td> </tr> </table>		0	Stop
0	Stop			
1	Start			
0x2021:002 (P230.02)	Optical tracking: Blinking duration (Optical tracking: Blink. duration) 0 ... [5] ... 3600 s			



7 Motor control

This chapter contains all functions and settings relevant for the motor control.

- [Motor data](#)  100
- [Motor control selection](#)  105
- [Optimisation of motor control](#)  113
- [Optimisation of the control loops](#)  121
- [Motor rotating direction](#)  123
- [Switching frequency changeover](#)  124
- [Motor protection](#)  125

Motor control

Motor data



7.1 Motor data

The term "motor data" comprises all parameters only depending on the motor and only characterising the electrical behaviour of the machine. Motor data are independent of the application in which the inverter and the motor are used.

Preconditions

When you enter the motor nameplate data, take into account the phase connection implemented for the motor (star or delta connection). Only enter the data applying to the connection type selected.

Parameter	Name / value range / [default setting]	Info						
0x2822:004 (P327.04)	Axis commands: Identify motor data (energized) (Axis commands: Identify mot.) 0 ... [0] ... 1	1 = start automatic identification of the motor data. <ul style="list-style-type: none"> Inverter characteristics, motor equivalent circuit diagram data and controller settings are identified and set automatically. During the procedure, the motor is energised! ▶ Automatic identification of the motor data □ 103						
0x2822:005 (P327.05)	Axis commands: Calibrate motor data (non-energized) (Axis commands: Calibrate mot.) 0 ... [0] ... 1	1 = start automatic calibration of the motor data. <ul style="list-style-type: none"> A default inverter characteristic is loaded. the motor equivalent circuit diagram data and controller settings are calculated on the basis of the currently set rated motor data. The motor is not energised. 						
0x2910:001 (P335.01)	Motor moment of inertia (Motor inertia) 0.00 ... [3.70]* ... 20000000.00 kg cm ² <ul style="list-style-type: none"> Default setting depending on the size. 	Setting of the moment of inertia of the motor.						
0x2910:002 (P335.02)	Load moment of inertia (Load inertia) 0.00 ... [3.70]* ... 20000000.00 kg cm ² <ul style="list-style-type: none"> Default setting depending on the size. 	Setting of the moment of inertia of the load.						
0x2910:003	Coupling <table border="1" style="width: 100%; border-collapse: collapse;"> <tr> <td style="text-align: center;">0</td> <td>Stiff</td> </tr> <tr> <td style="text-align: center;">1</td> <td>Elastic</td> </tr> <tr> <td style="text-align: center;">2</td> <td>With backlash</td> </tr> </table>	0	Stiff	1	Elastic	2	With backlash	Selection of the type of coupling between the moment of inertia of the motor and that of the load.
0	Stiff							
1	Elastic							
2	With backlash							



Parameter	Name / value range / [default setting]	Info
0x2947:001	Inverter characteristic: Value y1 0.00 ... [0.00] * ... 20.00 V • Default setting depending on the size.	<p>The inverter characteristic (consisting of 17 values) is calculated and set during the automatic identification of the motor data. If only an automatic calibration of the motor data is carried out, a default inverter characteristic is loaded instead.</p> <p>Note! Changing these values is not recommended by the manufacturer.</p>
0x2947:002	Inverter characteristic: Value y2 0.00 ... [0.00] * ... 20.00 V • Default setting depending on the size.	
0x2947:003	Inverter characteristic: Value y3 0.00 ... [0.00] * ... 20.00 V • Default setting depending on the size.	
0x2947:004	Inverter characteristic: Value y4 0.00 ... [0.00] * ... 20.00 V • Default setting depending on the size.	
0x2947:005	Inverter characteristic: Value y5 0.00 ... [0.00] * ... 20.00 V • Default setting depending on the size.	
0x2947:006	Inverter characteristic: Value y6 0.00 ... [0.00] * ... 20.00 V • Default setting depending on the size.	
0x2947:007	Inverter characteristic: Value y7 0.00 ... [0.00] * ... 20.00 V • Default setting depending on the size.	
0x2947:008	Inverter characteristic: Value y8 0.00 ... [0.00] * ... 20.00 V • Default setting depending on the size.	
0x2947:009	Inverter characteristic: Value y9 0.00 ... [0.00] * ... 20.00 V • Default setting depending on the size.	
0x2947:010	Inverter characteristic: Value y10 0.00 ... [0.00] * ... 20.00 V • Default setting depending on the size.	
0x2947:011	Inverter characteristic: Value y11 0.00 ... [0.00] * ... 20.00 V • Default setting depending on the size.	
0x2947:012	Inverter characteristic: Value y12 0.00 ... [0.00] * ... 20.00 V • Default setting depending on the size.	
0x2947:013	Inverter characteristic: Value y13 0.00 ... [0.00] * ... 20.00 V • Default setting depending on the size.	
0x2947:014	Inverter characteristic: Value y14 0.00 ... [0.00] * ... 20.00 V • Default setting depending on the size.	
0x2947:015	Inverter characteristic: Value y15 0.00 ... [0.00] * ... 20.00 V • Default setting depending on the size.	
0x2947:016	Inverter characteristic: Value y16 0.00 ... [0.00] * ... 20.00 V • Default setting depending on the size.	
0x2947:017	Inverter characteristic: Value y17 0.00 ... [0.00] * ... 20.00 V • Default setting depending on the size.	
0x2C01:001	Motor parameters: Number of pole pairs • Read only	Display of the number of pole pairs calculated from the rated speed and rated frequency.
0x2C01:002	Motor parameters: Stator resistance 0.0000 ... [10.1565] * ... 125.0000 Ω • Default setting depending on the size.	<p>General motor data. Carry out settings as specified by manufacturer data/motor data sheet.</p>
0x2C01:003	Motor parameters: Stator leakage inductance 0.000 ... [23.566] * ... 500.000 mH • Default setting depending on the size.	

Motor control

Motor data



Parameter	Name / value range / [default setting]	Info
0x2C01:004 (P320.04)	Motor parameters: Rated speed (Motor parameters: Rated speed) 50 ... [1450] ... 50000 rpm	General motor data. Carry out settings as specified by motor nameplate data.
0x2C01:005 (P320.05)	Motor parameters: Rated frequency (Motor parameters: Rated frequency) 1.0 ... [50.0] ... 1000.0 Hz	
0x2C01:006 (P320.06)	Motor parameters: Rated power (Motor parameters: Rated power) 0.00 ... [0.25] * ... 655.35 kW • Default setting depending on the size.	
0x2C01:007 (P320.07)	Motor parameters: Rated voltage (Motor parameters: Rated voltage) 0 ... [230] * ... 65535 V • Default setting depending on the size.	
0x2C01:008 (P320.08)	Motor parameters: Cosine phi (Motor parameters: Cosine phi) 0.00 ... [0.80] ... 1.00	
0x2C01:010	Motor parameters: Motor name	The name (e.g. "1") can be freely selected by the user. If the motor in the engineering tool has been selected from the "motor catalog", the respective motor name is automatically entered here (example: "MDSKA080-22, 70").
0x2C02:001 (P351.01)	Motor parameter (ASM): Rotor resistance (ASM motor par.: Rotor resistance) 0.0000 ... [8.8944] * ... 200.0000 Ω • Default setting depending on the size.	Equivalent circuit data of the motor required for the motor model.
0x2C02:002 (P351.02)	Motor parameter (ASM): Mutual inductance (ASM motor par.: Mutual induct.) 0.0 ... [381.9] * ... 50000.0 mH • Default setting depending on the size.	
0x2C02:003 (P351.03)	Motor parameter (ASM): Magnetising current (ASM motor par.: Magn. current) 0.00 ... [0.96] * ... 500.00 A • Default setting depending on the size.	
0x6075 (P323.00)	Motor rated current (Motor current) 0.001 ... [1.700] * ... 500.000 A • Default setting depending on the size. • Setting can only be changed if the inverter is inhibited.	The rated motor current to be set here serves as a reference value for different parameters with a setting/display in percent. Relevant parameters: <ul style="list-style-type: none"> • DC braking: Current 0x2B84:001 (P704.01) • Flying restart circuit: Current 0x2BA1:001 (P718.01) • Motor overload monitoring (i²*t): Maximum utilisation [60 s] 0x2D4B:001 (P308.01) • Load loss detection: Threshold 0x4006:001 (P710.01) • Max current 0x6073 (P324.00) • Current actual value 0x6078 (P103.00)
0x6076 (P325.00)	Motor rated torque (Motor torque) 0.001 ... [1.650] * ... 1000.000 Nm • Default setting depending on the size. • Setting can only be changed if the inverter is inhibited.	The rated motor torque to be set here serves as a reference value for different parameters with a setting/display in percent. Relevant parameters: <ul style="list-style-type: none"> • Target torque 0x6071 • Max torque 0x6072 (P326.00) • Torque demand value 0x6074 • Torque actual value 0x6077 (P107.00) • Positive torque limit 0x60E0 • Negative torque limit 0x60E1
0x6080 (P322.00)	Max motor speed (Max motor speed) 0 ... [6075] ... 480000 rpm	Limitation of the maximum motor speed.



7.1.1 Automatic identification of the motor data

For an optimal operation, the inverter characteristics, equivalent circuit data and controller settings can be automatically identified and set.



During the procedure, the motor is energised! The motor may be noisy but should not rotate.

Preconditions

Before the procedure is started, the following rated motor data has to be set correctly. Starting the calibration with wrong settings causes wrong results!

- Rated speed [0x2C01:004 \(P320.04\)](#)
- Rated frequency [0x2C01:005 \(P320.05\)](#)
- Rated power [0x2C01:006 \(P320.06\)](#)
- Rated voltage [0x2C01:007 \(P320.07\)](#)
- Cosine phi [0x2C01:008 \(P320.08\)](#)
- Motor rated current [0x6075 \(P323.00\)](#)
- Max current [0x6073 \(P324.00\)](#)

Steps required before starting the identification

1. Disable inverter or stop motor.
2. Set minimum frequency of the motor/application in [0x2915 \(P210.00\)](#).
3. Set maximum frequency of the motor/application in [0x2916 \(P211.00\)](#).
4. Set the desired motor control type in [0x2C00 \(P300.00\)](#).
5. Ensure that the operating mode "MS: Velocity mode [-2]" is set in [0x6060 \(P301.00\)](#).

General information on the identification

- The automatic identification can take from some seconds to minutes.
- During and after the procedure, the LED "RDY" (blue) is permanently on.
- After completing, a renewed start command is required to start the motor.

Diagnostic parameters:

- [0x2823:002](#) displays the status of the identification.

Execute automatic identification with »EASY Starter«

The easiest way to execute the automatic identification is to use the »EASY Starter«:

1. Go to the "Settings" tab and navigate to the parameterisation dialog "Advanced motor setting".
2. Press the "Energized" button under "Motor calibration" for an automatic identification. The "Identify motor parameters" dialog box is displayed. Simply follow the instructions in the dialog box to execute the identification.

Execute automatic identification with keypad

1. Request automatic identification: Set [0x2822:004 \(P327.04\)](#) = "1".
The automatic identification starts with the next start command.
2. Enable the inverter again (if disabled) and give the start command. ▶ [Start / stop motor](#)
[299](#)
The automatic identification is started.

Motor control

Motor data

Automatic identification of the motor data



Parameters set by the automatic identification

After a successful identification, the following parameters are set to the identified values:

Inverter identification

- Inverter characteristic [0x2947:001](#) ... [0x2947:017](#)

Motor identification

- Number of pole pairs [0x2C01:001](#)
- Stator resistance [0x2C01:002](#)
- Stator leakage inductance [0x2C01:003](#)
- Rotor resistance [0x2C02:001](#) (P351.01)
- Mutual inductance [0x2C02:002](#) (P351.02)
- Magnetising current [0x2C02:003](#) (P351.03)



During the procedure, also the following parameters are calculated and set. A manual adaptation of these parameters is usually not recommended since wrong settings may have a negative impact on the control.

Speed controller

- Gain [0x2900:001](#) (P332.01)
- Reset time [0x2900:002](#) (P332.02)

I_{max} controller

- Gain [0x2B08:001](#) (P333.01)
- Reset time [0x2B08:002](#) (P333.02)

Current controller

- Gain [0x2942:001](#) (P334.01)
- Reset time [0x2942:002](#) (P334.02)

Field controller

- Gain [0x29C0:001](#)
- Reset time [0x29C0:002](#)

Field weakening controller

- Gain [0x29E0:001](#)
- Reset time [0x29E0:002](#)

SLVC Q controller

- Gain [0x2B40:001](#)
- Reset time [0x2B40:002](#)

Flying restart circuit

- Restart time [0x2BA1:003](#) (P718.03)



7.2 Motor control selection

The inverter supports different modes for closed-loop/open-loop motor control.

Parameter	Name / value range / [default setting]	Info
0x2C00 (P300.00)	Motor control mode (Motor ctrl mode) <ul style="list-style-type: none">Setting can only be changed if the inverter is inhibited.	Selection of the motor control type.
	3 Sensorless control (SL PSM) <ul style="list-style-type: none">From version 02.00	This control type is used for the sensorless control of a synchronous motor. ▶ Sensorless control for synchronous motors (SL-PSM) □ 112
	4 Sensorless vector control (SLVC)	This control type is used for sensorless vector control of an asynchronous motor. ▶ Sensorless vector control (SLVC) □ 110
	6 V/f characteristic control (VFC open loop)	This control mode is used for the speed control of an asynchronous motor via a V/f characteristic and is the simplest control mode. ▶ V/f characteristic control (VFC) □ 106

In the following subchapters, each motor control is described in detail.

Motor control

Motor control selection
V/f characteristic control (VFC)



7.2.1 V/f characteristic control (VFC)

The V/f characteristic control is a motor control for conventional frequency inverter applications. It is based on a simple and robust control mode for the operation of asynchronous motors with a linear or square-law load torque characteristic (e.g. fan). Because of the minimal parameterisation effort, such applications can be commissioned easily and quickly.

Preconditions

- The V/f characteristic control is only suitable for asynchronous motors.
- If you want to actuate a drive with a square-law V/f characteristic: please always check whether the corresponding drive is suitable for operation with a square-law V/f characteristic!
- From the motor nameplate data, at least the rated speed and rated frequency must be entered, so that the inverter can calculate the correct number of pole pairs. [▶ Motor data](#) [□ 100](#)
- The motor must only be actuated above the rated motor frequency/rated voltage if this is expressly approved by the motor manufacturer!

Details

This motor control type is activated by setting **0x2C00 (P300.00)** = "V/f characteristic control (VFC open loop) [6]".

- **0x2B00 (P302.00)** provides different characteristic shapes which are described in detail in the following subchapters.
- Limiting factors for the V/f characteristic are rated mains voltage **0x2540:001 (P208.01)**, minimum frequency **0x2915 (P210.00)** and maximum frequency **0x2916 (P211.00)**.

Parameter	Name / value range / [default setting]	Info
0x2B00 (P302.00)	V/f characteristic shape (V/f charac.shape) • Setting can only be changed if the inverter is inhibited.	Selection of the V/f characteristic shape for the adaptation to different load profiles.
	0 Linear	Linear characteristic for drives with constant load torque over the speed. ▶ Linear V/f characteristic □ 107
	1 Quadratic	Square-law characteristic for drives with a linear or square-law load torque over the speed. • Square-law V/f characteristics are preferably used for centrifugal pumps and fan drives. • Please always check whether the corresponding drive is suitable for operation with a square-law V/f characteristic! • If your pump drive or fan drive is not suitable for operation with a square-law V/f characteristic, use the linear V/f characteristic instead. ▶ Square-law V/f characteristic □ 108
	3 Eco • From version 02.00	Linear characteristic with energy optimisation in the partial load operational range. ▶ V/f characteristic control - energy-saving (VFC Eco) □ 109
0x2B01:001 (P303.01)	V/f shape data: Base voltage (V/f shape data: Base voltage) 0 ... [230] * ... 5000 V • Default setting depending on the size.	Base voltage and base frequency define the V/f ratio and thus the gradient of the V/f characteristic. • The V/f base voltage is usually set to the rated motor voltage 0x2C01:007 (P320.07) .
0x2B01:002 (P303.02)	V/f shape data: Base frequency (V/f shape data: Base frequency) 0 ... [50] * ... 599 Hz • Default setting depending on the size.	• The V/f base frequency is usually set to the rated motor frequency 0x2C01:005 (P320.05) .



7.2.1.1 Linear V/f characteristic

The linear V/f characteristic is the most used characteristic shape for general applications since they cause a torque that is largely constant.

Details

Select V/f characteristic control with linear characteristic:

1. Motor control mode `0x2C00 (P300.00)` = "V/f characteristic control (VFC open loop) [6]"
2. V/f characteristic shape `0x2B00 (P302.00)` = "Linear [0]"

Setting of the V/f characteristic:

- Limiting factors for the V/f characteristic are rated mains voltage `0x2540:001 (P208.01)`, minimum frequency `0x2915 (P210.00)` and maximum frequency `0x2916 (P211.00)`.
- The base voltage `0x2B01:001 (P303.01)` is usually set to the rated motor voltage (motor nameplate data). The base voltage is preset to the rated mains voltage. This again is preset according to the product key of the inverter. ▶ [Mains voltage](#) 86
- The base frequency `0x2B01:002 (P303.02)` is usually set to the rated motor frequency (motor nameplate data).

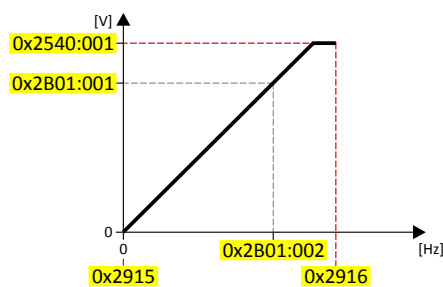

The current output frequency can exceed the set maximum frequency if the gain for the slip compensation in `0x2B09:001 (P315.01)` is set to a value higher than 0.

Example

In this example, a 400 V/50 Hz motor is connected to the inverter which is to be operated with maximally 75 Hz. The minimum frequency is set to 10 Hz.

- V/f characteristic on the left: The inverter is operated with a rated mains voltage of 400 V.
- V/f characteristic on the right: The inverter is operated with a rated mains voltage of 480 V. This causes the output voltage to further increase above 50 Hz.

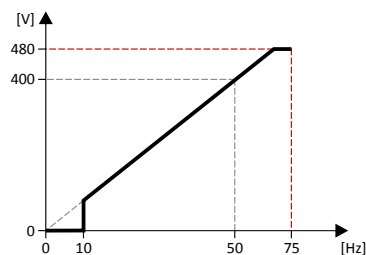
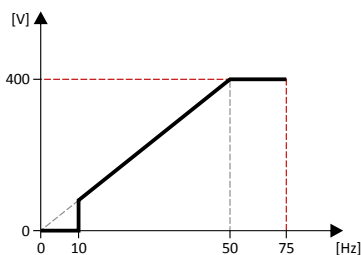

Parameter	Name	Setting for this example
<code>0x2540:001 (P208.01)</code>	Rated mains voltage	400 Veff [1] (on the left) / 480 Veff [2] (on the right)
<code>0x2915 (P210.00)</code>	Minimum frequency	10 Hz
<code>0x2916 (P211.00)</code>	Maximum frequency	75 Hz
<code>0x2B01:001 (P303.01)</code>	Base voltage	400 V
<code>0x2B01:002 (P303.02)</code>	Base frequency	50 Hz

Motor control

Motor control selection
V/f characteristic control (VFC)



7.2.1.2 Square-law V/f characteristic

The square-law V/f characteristic is typically used in heating, ventilation and climate applications to control the speed of fans and pumps.

Details

Each application that is provided with the features according to the affinity laws may possibly benefit from a square-law V/f characteristic.

The affinity laws describe the relation between the speed and other variables:

- The volume flow increases proportionately to the speed.
- The required pressure behaves proportionately to the square of the speed.
- The power input is proportionately to the cube of the speed. This means that already a minimal reduction of the speed may lead to substantial savings in energy consumption.

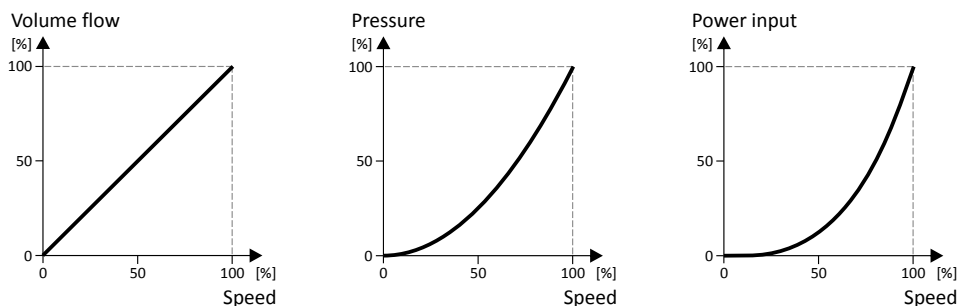

By approximation, the square-law V/f characteristic corresponds to the curve for power input shown above. At low frequencies, the voltage is reduced since due to the type of load a lower voltage is sufficient to generate the required power. All in all, this results in an energy-efficient system.

Select V/f characteristic control with square-law characteristic:

1. Motor control mode `0x2C00 (P300.00)` = "V/f characteristic control (VFC open loop) [6]"
2. V/f characteristic shape `0x2B00 (P302.00)` = "Quadratic [1]"

Setting of the V/f characteristic:

- Limiting factors for the V/f characteristic are rated mains voltage `0x2540:001 (P208.01)`, minimum frequency `0x2915 (P210.00)` and maximum frequency `0x2916 (P211.00)`.
- The base voltage `0x2B01:001 (P303.01)` is usually set to the rated motor voltage (motor nameplate data). The base voltage is preset to the rated mains voltage. This again is preset according to the product key of the inverter. ▶ [Mains voltage](#) 86
- The base frequency `0x2B01:002 (P303.02)` is usually set to the rated motor frequency (motor nameplate data).

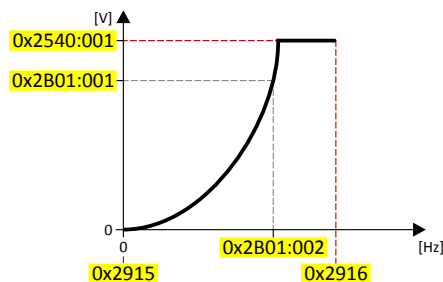

The current output frequency can exceed the set maximum frequency if the gain for the slip compensation in `0x2B09:001 (P315.01)` is set to a value higher than 0.



7.2.1.3 V/f characteristic control - energy-saving (VFC Eco)

In case of the energy-saving V/f characteristic control (VFCplusEco), the motor voltage of the inverter is detected by means of a linear characteristic as a function of the rotating field frequency or motor speed to be generated. Moreover, the motor is always driven in the optimal efficiency range via a cosφ control and the resulting voltage reduction (reduced copper losses in the asynchronous motor).

Details

Select energy-saving V/f characteristic control with linear characteristic:

1. Motor control mode `0x2C00 (P300.00)` = "V/f characteristic control (VFC open loop) [6]"
2. V/f characteristic shape `0x2B00 (P302.00)` = "Eco [3]"

Setting of the V/f characteristic:

- Limiting factors for the V/f characteristic are rated mains voltage `0x2540:001 (P208.01)`, minimum frequency `0x2915 (P210.00)` and maximum frequency `0x2916 (P211.00)`.
- The base voltage `0x2B01:001 (P303.01)` is usually set to the rated motor voltage (motor nameplate data). The base voltage is preset to the rated mains voltage. This again is preset according to the product key of the inverter. ▶ [Mains voltage](#) [86](#)
- The base frequency `0x2B01:002 (P303.02)` is usually set to the rated motor frequency (motor nameplate data).

Eco efficiency range:

- The Eco efficiency range (grey) is between the V/f-standard characteristic (black) and the V/f Eco characteristic (green).
- The V/f Eco characteristic (green) is defined by the operating point that results from the minimum voltage `0x2B0D:001 (P330.01)` and the base frequency `0x2B01:002 (P303.02)`.
- The minimum voltage `0x2B0D:001 (P330.01)` has to be set in percent with reference to the base voltage `0x2B01:001 (P303.01)`.

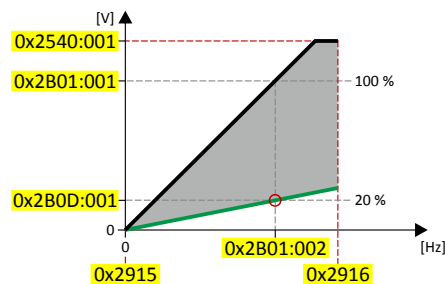

The current output frequency can exceed the set maximum frequency if the gain for the slip compensation in `0x2B09:001 (P315.01)` is set to a value higher than 0.

Optimising the control mode:

1. Select the used motor in the engineering tool from the "motor catalog". If the motor is not available in the motor catalog, the motor data have to be set according to the manufacturer information/motor data sheet. ▶ [Motor data](#) [100](#)
2. Identify motor data (energized) or calibrate (non-energized). Details: ▶ [Automatic identification of the motor data](#) [103](#)

Parameter	Name / value range / [default setting]	Info
0x2B0D:001 (P330.01)	Minimum voltage (Min. voltage) 20 ... [20] ... 100 % • From version 02.00	Defining the operating point of the V/f eco characteristic. The V/f eco characteristic defines the lower limit of the eco efficiency range. • 100 % ≙ Base voltage <code>0x2B01:001 (P303.01)</code>

Motor control

Motor control selection
Sensorless vector control (SLVC)



7.2.2 Sensorless vector control (SLVC)

Sensorless (field-oriented) vector control for asynchronous motors is based on a decoupled, separate control for the torque-producing and the field-producing current component. In addition, the actual speed is reconstructed by means of a motor model so that a speed sensor is not required.

Preconditions

- Sensorless vector control (SLVC) is only suitable for asynchronous motors.
- Operation of the sensorless vector control (SLVC) is only permissible for one single drive!
- Operation of the sensorless vector control (SLVC) is **not** permissible for hoists!
- The default setting enables the actuation of a power-adapted motor. Optimum operation requires an automatic identification of the motor data. ▶ [Automatic identification of the motor data](#) [103](#)

Details

This motor control type is activated by setting `0x2C00 (P300.00) = "Sensorless vector control (SLVC) [4]"`.

Compared to the V/f characteristics, the sensorless vector control (SLVC) serves to achieve improved drive characteristics thanks to:

- higher torque throughout the entire speed range
- higher speed accuracy and higher concentricity factor
- higher efficiency

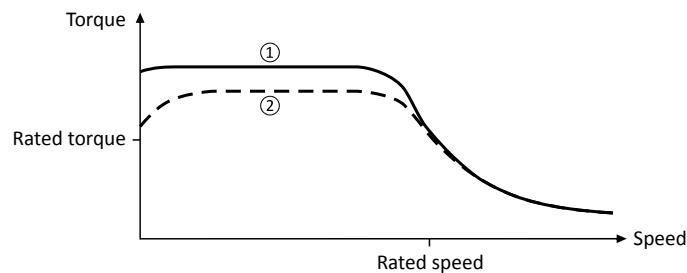

- ① Sensorless vector control (SLVC)
- ② V/f characteristic control (VFC) [106](#)

Parameter	Name / value range / [default setting]	Info
0x29C0:001	Field controller settings: Gain 0.00 ... [59.68]* ... 50000.00 A/Vs • Default setting depending on the size.	Gain factor Vp of the field controller.
0x29C0:002	Field controller settings: Reset time 1.0 ... [45.5]* ... 6000.0 ms • Default setting depending on the size.	Reset time Tn of the field controller.
0x29E0:001	Field weakening controller settings: Gain 0.000 ... [0.000]* ... 2000000.000 Vs/V • Default setting depending on the size.	Gain factor Vp of the field weakening controller.
0x29E0:002	Field weakening controller settings: Reset time 1.0 ... [1478.3]* ... 240000.0 ms • Default setting depending on the size.	Reset time Tn of the field weakening controller.
0x2B40:001	SLVC: Gain 0.0000 ... [0.2686]* ... 1000.0000 Hz/A • Default setting depending on the size.	Gain of the SLVC-Q controller.
0x2B40:002	SLVC: Reset time 1.0 ... [2.3]* ... 2000.0 ms • Default setting depending on the size.	Reset time of the SLVC-Q controller.
0x2900:001 (P332.01)	Speed controller settings: Gain (Speed controller: Gain) 0.00000 ... [0.00193]* ... 20000.00000 Nm/rpm • Default setting depending on the size.	Gain factor Vp of the speed controller.
0x2900:002 (P332.02)	Speed controller settings: Reset time (Speed controller: Reset time) 1.0 ... [80.0]* ... 6000.0 ms • Default setting depending on the size.	Reset time Ti of the speed controller.



Motor control

Motor control selection

Sensorless vector control (SLVC)

Parameter	Name / value range / [default setting]	Info
0x2915 (P210.00)	Minimum frequency (Min. frequency) 0.0 ... [0.0] ... 599.0 Hz	Lower limit value for all frequency setpoints.
0x2916 (P211.00)	Maximum frequency (Max. frequency) 0.0 ... [50.0] ... 599.0 Hz	Upper limit value for all frequency setpoints.
0x2942:001 (P334.01)	Current controller parameters: Gain (Current contr.: Gain) 0.00 ... [42.55]* ... 750.00 V/A • Default setting depending on the size.	Gain factor V_p of the current controller.
0x2942:002 (P334.02)	Current controller parameters: Reset time (Current contr.: Reset time) 0.01 ... [4.50]* ... 2000.00 ms • Default setting depending on the size.	Reset time T_i of the current controller.
0x2BA1:003 (P718.03)	Flying restart circuit: Restart time (Flying restart: Restart time) 1 ... [5911]* ... 60000 ms • Default setting depending on the size.	Integration time for controlling the flying restart circuit. • The parameter is calculated and set in the course of the automatic identification of the motor data. The same applies if an automatic calibration of the motor data is carried out. ▶ Automatic identification of the motor data  103
0x6073 (P324.00)	Max current (Max current) 0.0 ... [200.0] ... 3000.0 %	Maximum overload current of the inverter. • 100 % \equiv Motor rated current 0x6075 (P323.00) • If the current consumption of the motor exceeds this current limit, the inverter changes its dynamic behaviour, in order to counteract this exceedance. • If the change in the dynamic behaviour carried out by the inverter does not result in exiting the overcurrent state, the inverter outputs an error. Note! This parameter is not identical to the so-called ultimate motor current I_{ULT} ! • The ultimate motor current set in 0x2D46:001 (P353.01) is a limit value for synchronous motors that serves to protect their magnets. • The value to be set here should always be considerably below the ultimate motor current!

Motor control

Motor control selection

Sensorless control for synchronous motors (SL-PSM)



7.2.3 Sensorless control for synchronous motors (SL-PSM)



In preparation!

Parameter	Name / value range / [default setting]	Info
0x2C03:001 (P352.01)	EMK constant (EMK constant) 0.0 ... [41.8] ... 100000.0 V/1000rpm • From version 02.00	
0x2C11:001	Lower limit 10 ... [30] ... 100 % • From version 02.00	
0x2C11:002	Tracking controller gain 0 ... [250] ... 65535 % • From version 02.00	
0x2C11:003	Tracking controller reset time 0.00 ... [3.30] ... 655.35 ms • From version 02.00	
0x2C11:004	Tracking controller decouple time 0.00 ... [0.50] ... 655.35 ms • From version 02.00	
0x2C12:001	Acceleration current 5 ... [100] ... 400 % • From version 02.00	
0x2C12:002	Standstill current 5 ... [40] ... 400 % • From version 02.00	



7.3 Optimisation of motor control

The inverter provides different functions by means of which the drive behaviour can be further optimised.

- [V/f voltage boost](#) 113
- [Skip frequencies](#) 114
- [Optimising the stalling behaviour](#) 116
- [Slip compensation](#) 118
- [Oscillation damping](#) 119

7.3.1 V/f voltage boost

The parameterisable voltage boost makes it possible to improve the starting performance for applications requiring a high starting torque.

Preconditions

"V/f characteristic control (VFC open loop)" motor control has been selected in [0x2C00](#) (P300.00). Otherwise the voltage boost is not effective.

Details

- In [0x2B12:001](#) (P316.01), a permanent voltage boost can be set. ①
- In [0x2B12:002](#) (P316.02), an additional voltage boost can be set for acceleration processes only. ②
- Reference for the percentage setting of the voltage boost is the base voltage [0x2B01:001](#) (P303.01).

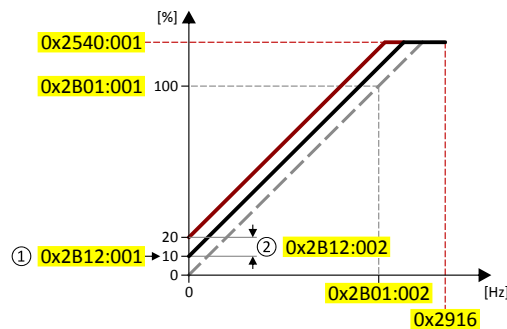

Parameter	Name / value range / [default setting]	Info
0x2B12:001 (P316.01)	V/f voltage boost: Fixed boost (V/f boosts: Fixed V/f boost) 0.0 ... [2.5]* ... 20.0 % • Default setting depending on the size.	Fixed (constant) voltage boost for V/f characteristic control without feedback. • 100 % \equiv V/f base voltage 0x2B01:001 (P303.01) • For the purpose of optimising the starting performance for applications requiring a high starting torque.
0x2B12:002 (P316.02)	V/f voltage boost: Boost at acceleration (V/f boosts: Dynam. V/f boost) 0.0 ... [0.0] ... 20.0 %	Additional voltage boost for V/f characteristic control without feedback. • 100 % \equiv V/f base voltage 0x2B01:001 (P303.01) • This voltage boost is only active while the motor is accelerated. It then acts in addition to the fixed voltage boost set in 0x2B12:001 (P316.01).
0x2B01:001 (P303.01)	V/f shape data: Base voltage (V/f shape data: Base voltage) 0 ... [230]* ... 5000 V • Default setting depending on the size.	Base voltage and base frequency define the V/f ratio and thus the gradient of the V/f characteristic. • The V/f base voltage is usually set to the rated motor voltage 0x2C01:007 (P320.07). • The V/f base frequency is usually set to the rated motor frequency 0x2C01:005 (P320.05).

Motor control

Optimisation of motor control
Skip frequencies



7.3.2 Skip frequencies

By means of the three parameterisable skip frequencies, critical frequencies can be suppressed which lead to mechanical resonances in the system.

Details

A blocking zone is active as soon as the frequency for this blocking zone is set to value unequal to "0 Hz".

- The set frequency defines the centre of the range to be masked out. ①
- The set bandwidth defines its total size. ②

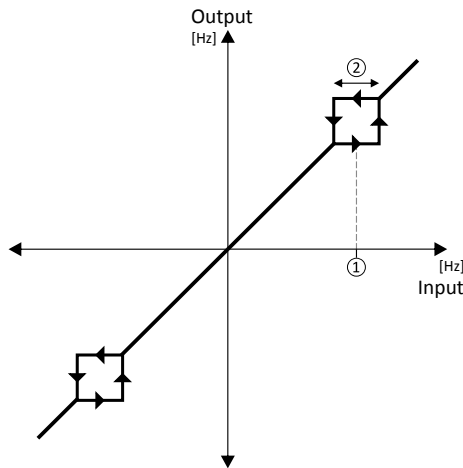

Example: For a blocking zone, the frequency is set to 20 Hz and the bandwidth to 10 Hz. These settings mask out the range from 15 Hz to 25 Hz.

Notes:

- Skip frequencies are absolute values. With the setting "20 Hz", at the same time also the skip frequency "-20 Hz" is defined.
- The inverter accelerates/decelerates the motor by the range to be masked out. A continuous operation within this range is not possible.
- A blocking zone is not active if its bandwidth is set to "0 Hz".

Adjacent and overlapping ranges:

- Example on the left: If the ranges are closely spaced, the ranges are passed through as shown.
- Example on the right: If the ranges overlap, the lowest and highest value form a new range. In the status display `0x291F:016`, both ranges are shown as active.

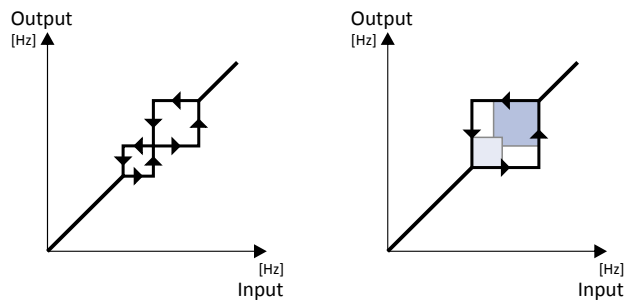



Valid and invalid ranges:

- Example on the left: Skip frequency = 5 Hz, bandwidth = 10 Hz
→ Valid range (starts at ≥ 0)
- Example on the right: Skip frequency = 4 Hz, bandwidth = 10 Hz
→ Invalid range (starts at < 0); is thus ignored.

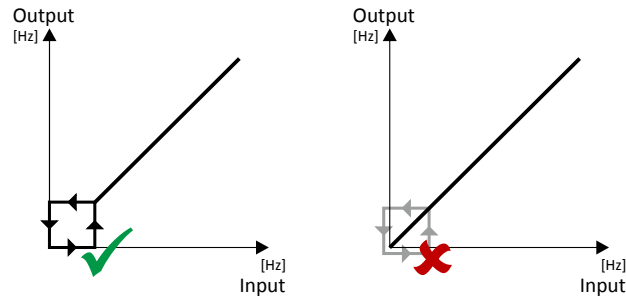

Parameter	Name / value range / [default setting]	Info
0x291F:001 (P317.01)	Skip frequencies: Skip frequency 1 (Skip frequencies: Skip frequency 1) 0.0 ... [0.0] ... 599.0 Hz	Centre of frequency range 1 which is to be skipped.
0x291F:002 (P317.02)	Skip frequencies: Skip bandwidth 1 (Skip frequencies: Skip bandwidth 1) 0.0 ... [0.0] ... 10.0 Hz	Size of frequency range 1 which is to be skipped.
0x291F:003 (P317.03)	Skip frequencies: Skip frequency 2 (Skip frequencies: Skip frequency 2) 0.0 ... [0.0] ... 599.0 Hz	Centre of frequency range 2 which is to be skipped.
0x291F:004 (P317.04)	Skip frequencies: Skip bandwidth 2 (Skip frequencies: Skip bandwidth 2) 0.0 ... [0.0] ... 10.0 Hz	Size of frequency range 2 which is to be skipped.
0x291F:005 (P317.05)	Skip frequencies: Skip frequency 3 (Skip frequencies: Skip frequency 3) 0.0 ... [0.0] ... 599.0 Hz	Centre of frequency range 3 which is to be skipped.
0x291F:006 (P317.06)	Skip frequencies: Skip bandwidth 3 (Skip frequencies: Skip bandwidth 3) 0.0 ... [0.0] ... 10.0 Hz	Size of frequency range 3 which is to be skipped.
0x291F:016	Skip frequencies: Status • Read only	Bit-coded status display of the skip frequencies.
	Bit 0	Blocking zone 1 active
	Bit 1	Blocking zone 2 active
	Bit 2	Blocking zone 3 active
	Bit 3	Reserved
	Bit 4	Frequency above blocking zone 1
	Bit 5	Frequency above blocking zone 2
	Bit 6	Frequency above blocking zone 3
	Bit 7	Reserved
	Bit 8	Blocking zone 1 invalid
	Bit 9	Blocking zone 2 invalid
	Bit 10	Blocking zone 3 invalid
	Bit 11	Reserved
	Bit 12	Reserved
	Bit 13	Reserved
	Bit 14	Reserved
	Bit 15	Reserved
0x291F:032	Skip frequencies: Input frequency • Read only: x.xx Hz	Display of the skip filter input frequency.
0x291F:033	Skip frequencies: Output frequency • Read only: x.xx Hz	Display of the skip filter output frequency.

Motor control

Optimisation of motor control
Optimising the stalling behaviour



7.3.3 Optimising the stalling behaviour

If the motor is driven with frequencies above the rated motor frequency, the operating point is shifted to the "field weakening range". In this range, the motor voltage does not increase proportionately to the output frequency anymore. As a consequence, the inverter automatically reduces the maximum current since the full torque is not available anymore at these frequencies.

For special motors which enable an operation in the field weakening range, the behaviour in the field weakening range can be adapted to the motor with [0x2B0C \(P319.00\)](#).

⚠ DANGER!

Danger by incorrect parameterisation.

Possible consequences: damage to material assets and injury to persons

- ▶ Only change the default setting (0 Hz) in [0x2B0C \(P319.00\)](#) after consulting the motor manufacturer!
- ▶ Recommendation: Maintain default setting (0 Hz).

Preconditions

The function is only effective if the a V/f motor control mode is selected in [0x2C00 \(P300.00\)](#).

Details

The operating range of an asynchronous motor consists of the voltage range ① and the field weakening range. The field weakening range again is divided into two ranges:

- In the first range ②, the power can be kept constant without the motor stalling.
- The second field weakening range ③ is characterised by the fact that the maximum permissible stator current is decreased to prevent the motor from stalling.

Speed/torque curve of the asynchronous motor with two field weakening ranges

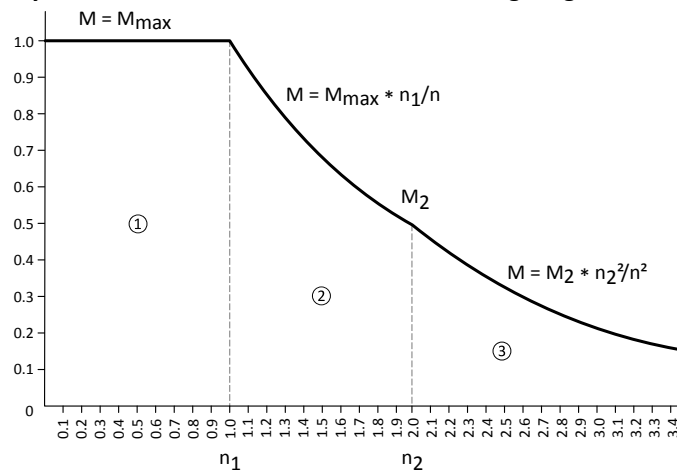

The override point (n₂, M₂) can be influenced with [0x2B0C \(P319.00\)](#).

[0x2B0C \(P319.00\)](#) > 0 Hz:

- The maximum current characteristic is shifted to higher field frequencies by the frequency entered.
- The maximum permissible current and the maximum torque increase in the field weakening range.
- The risk of motor stalling increases.

[0x2B0C \(P319.00\)](#) < 0 Hz:

- The maximum current characteristic is shifted to lower field frequencies by the frequency entered.
- The maximum permissible current and the maximum torque are reduced in the field weakening range.
- The risk of motor stalling is reduced.



Motor control

Optimisation of motor control

Optimising the stalling behaviour

Parameter	Name / value range / [default setting]	Info
0x2B0C (P319.00)	Override field weakening (Field weak thold) -599.0 ... [0.0] ... 599.0 Hz	Offset of the override point for field weakening.
0x2B01:002 (P303.02)	V/f shape data: Base frequency (V/f shape data: Base frequency) 0 ... [50]* ... 599 Hz <ul style="list-style-type: none">• Default setting depending on the size.	Base voltage and base frequency define the V/f ratio and thus the gradient of the V/f characteristic. <ul style="list-style-type: none">• The V/f base voltage is usually set to the rated motor voltage 0x2C01:007 (P320.07).• The V/f base frequency is usually set to the rated motor frequency 0x2C01:005 (P320.05).

Motor control

Optimisation of motor control
Slip compensation



7.3.4 Slip compensation

In case of a load, the speed of an asynchronous motor decreases. This load-dependent speed drop is called slip. The slip compensation serves to counteract the load-dependent speed loss.

Preconditions

In order that the slip compensation can determine the rated slip correctly, the following parameters must be set correctly:

- Rated speed
- Rated frequency
- Number of pole pairs (automatically calculated from Rated speed and Rated frequency)

Details

The slip compensation increases or decreases the output frequency as a response to a load change. Thus, the slip is counteracted and the speed is kept precisely.

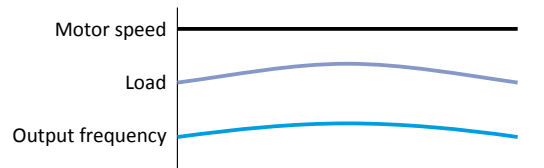

The rated slip required for the slip compensation is calculated by the inverter according to the following formula:

$$\text{Rated slip [\%]} = (1 - (\text{rated motor speed [rpm]} / (120 * \text{rated motor frequency [Hz]} / \text{number of poles}))) * 100$$

Calculation example:

- Rated motor speed = 1750 rpm
- Rated motor frequency = 60 Hz
- Number of poles = 2 * Number of pole pairs = 2 * 2 = 4
- Rated slip = $(1 - (1750 / (120 * 60 / 4))) * 100 = 2.77 \%$

The rated slip represents the reduction of the motor speed due to the motor load. At full speed and full load, the motor given in the example would rotate with 1750 rpm, which means 2.77 % below its synchronous speed of 1800 rpm. In order to compensate this speed loss, the inverter increases the output frequency by the rated slip multiplied by the rated motor frequency. In the example $2.77 \% * 60 \text{ Hz} = 1.66 \text{ Hz}$ increase at full load.

In order to consider load changes, the influence of the rated slip on output frequency can be adapted in [0x2B09:001 \(P315.01\)](#). A setting of 100 % corresponds to the rated slip of the machine in the nominal operating point.

With reference to the example above and a setpoint frequency of 60 Hz:

- If [0x2B09:001 \(P315.01\)](#) = 100 %, the output frequency is = 61.66 Hz (60 Hz + 100 % * 1.66 Hz).
- If [0x2B09:001 \(P315.01\)](#) = 50 %, the output frequency is = 60.83 Hz (60 Hz + 50 % * 1.66 Hz).

Additionally, the filter time for the slip compensation can be adapted in [0x2B09:002 \(P315.02\)](#) if required. The preset filter time is adapted to typical motors. If full load or nearly full load oscillations or instabilities occur, we recommend an increase of the filter time.

Parameter	Name / value range / [default setting]	Info
0x2B09:001 (P315.01)	Slip compensation: Gain (Slip compens.: Slip: gain) -200.00 ... [100.00] ... 200.00 %	Adjustment in percent of the slip calculated. <ul style="list-style-type: none">• For instance required for deviations of the real motor data from the nameplate data.• A setting of 100 % corresponds to the rated slip of the machine in the nominal operating point.
0x2B09:002 (P315.02)	Slip compensation: Filter time (Slip compens.: Filter time) 1 ... [5] ... 6000 ms	Filter time for the slip compensation. <ul style="list-style-type: none">• The preset filter time is adapted to typical motors.
0x2C02:004 (P351.04)	Slip frequency (Slip frequency) <ul style="list-style-type: none">• Read only: x.x Hz	Display of the rated slip determined.



Parameter	Name / value range / [default setting]	Info
0x2C01:001	Motor parameters: Number of pole pairs • Read only	Display of the number of pole pairs calculated from the rated speed and rated frequency.
0x2C01:004 (P320.04)	Motor parameters: Rated speed (Motor parameters: Rated speed) 50 ... [1450] ... 50000 rpm	General motor data. Carry out settings as specified by motor nameplate data.
0x2C01:005 (P320.05)	Motor parameters: Rated frequency (Motor parameters: Rated frequency) 1.0 ... [50.0] ... 1000.0 Hz	

7.3.5 Oscillation damping

The oscillation damping serves to reduce the oscillations during no-load operation which are caused by energy oscillating between the mechanical system (mass inertia) and the electrical system (DC bus). Furthermore, the oscillation damping can also be used to compensate for resonances.

Preconditions

"V/f characteristic control (VFC open loop)" motor control has been selected in [0x2C00 \(P300.00\)](#). Otherwise the oscillation damping is not effective.

Restrictions

Observe the following restrictions:

- Damping is possible only for constant oscillations at a steady-state operating point.
- Oscillations occurring sporadically cannot be damped.
- Oscillation damping is not suitable for oscillations occurring during dynamic processes (e.g. accelerations or load changes).
- Oscillation damping is only active if the setpoint speed is greater than 10 rpm and the DC-bus voltage exceeds a value of 100 V.

Details

The determination of the oscillation is based on the active current. In order to obtain the alternating component of the active current, this current is differentiated. This signal is then passed through a PT1 filter.

Identification of the oscillation

Before the oscillation damping function can be parameterised, the oscillation has to be identified. One way to do this is to examine the motor current while oscillation damping is switched off (gain = 0 %). At steady-state operation, a constant current flows. If the drive oscillates, these oscillations are also visible on the motor current. It is therefore possible to determine the frequency and the amplitude of the oscillation from the alternating component of the motor current. In the following, this alternating component is referred to as "current oscillation".

Parameter setting

The gain of the oscillation signal is to be set according to the following equation:

$$0x2B0A:001 \text{ (P318.01)} = \text{current amplitude} * 100 \% / (\sqrt{2} * \text{maximum device current})$$

The default time constant of the PT1 filter should be sufficient for most applications. If required, it is only possible to adapt the time constant via »EASY Starter«. Generally, the time constant must be set so that the oscillation can be dampened, but that higher-frequency components are filtered from the signal. The time constant is determined from the reciprocal value of the double current oscillation frequency:

$$0x2B0A:002 \text{ (P318.02)} = 1 / (2 * \text{oscillation frequency})$$

Parameter	Name / value range / [default setting]	Info
0x2B0A:001 (P318.01)	Gain (Gain) -100 ... [20] ... 100 %	Gain of the oscillation signal. • With the setting 0, oscillation damping is deactivated.
0x2B0A:002 (P318.02)	Filter time (Filter time) 1 ... [5] ... 600 ms	Time constant of the PT1 filter.

Motor control

Optimisation of motor control
Oscillation damping



Parameter	Name / value range / [default setting]	Info
0x2DDF:002	Axis information: Maximum current • Read only: x.xx A • Default setting depending on the size.	Display of the maximum current of the axis.
0x2D88 (P104.00)	Motor current (Motor current) • Read only: x.x A	Display des present current-r.m.s. value.



7.4 Optimisation of the control loops

The following speed controller, I_{max} controller and current controller parameters are calculated and set automatically in the course of automatic identification of the motor data.

Details

- For details see chapter "[Automatic identification of the motor data](#)". [103](#)
- The automatic identification considers all controllers at once, they cannot be controlled individually.
- Without carrying out the automatic identification, standard values are preset according to the voltage and power of the inverter.
- When the automatic identification has been carried out, further adaptation is neither required nor recommended for typical applications.



If these parameters have to be adapted, this has to be done very carefully. An incorrect setting may have a negative impact on the control system.

7.4.1 Speed controller

Parameter	Name / value range / [default setting]	Info
0x2900:001 (P332.01)	Speed controller settings: Gain (Speed controller: Gain) 0.00000 ... [0.00193]* ... 20000.00000 Nm/rpm • Default setting depending on the size.	Gain factor V _p of the speed controller.
0x2900:002 (P332.02)	Speed controller settings: Reset time (Speed controller: Reset time) 1.0 ... [80.0]* ... 6000.0 ms • Default setting depending on the size.	Reset time T _i of the speed controller.
0x2904	Actual speed filter time 0.0 ... [2.0] ... 50.0 ms	Filter time for the actual speed value.

Motor control

Optimisation of the control loops
Imax controller



7.4.2 Imax controller

The Imax controller becomes active if the actual motor current exceeds the maximum overload current "Max current". The Imax controller changes the output frequency to counteract the exceedance.

Preconditions

The Imax controller is only effective if a V/f motor control mode is selected in [0x2C00 \(P300.00\)](#).

Details

The maximum overload current "Max current" is defined in [0x6073 \(P324.00\)](#) in percent with regard to the rated motor current "Motor rated current" [0x6075 \(P323.00\)](#).

If the maximum overload current is exceeded:

- During operation in motor mode, the Imax controller reduces the output frequency.
- During operation in generator mode, the Imax controller increases the output frequency.

Optimising the Imax controller



For typical applications, a manual adaptation of the parameters of the Imax controller is not recommended. A wrong setting may have a negative effect on the control. For special applications, contact the manufacturer before adapting the parameters.

If oscillations occur at the current limit during operation:

- Reduce gain of the Imax controller in [0x2B08:001 \(P333.01\)](#).
- Increase reset time of the Imax controller in [0x2B08:002 \(P333.02\)](#).
- Carry out the changes in small steps only (by 2 ... 3 % of the set value) until the oscillations do not exist anymore.

If the Imax controller does not respond fast enough after the maximum current has been exceeded:

- Increase gain of the Imax controller in [0x2B08:001 \(P333.01\)](#).
- Reduce reset time of the Imax controller in [0x2B08:002 \(P333.02\)](#).
- Carry out the changes in small steps only (by 2 ... 3 % of the set value) until the response time is acceptable.

Parameter	Name / value range / [default setting]	Info
0x2822:019	Axis commands: Calculate Imax controller parameter 0 ... [0] ... 1	1 = start automatic calculation of the Imax controller parameters.
0x2B08:001 (P333.01)	V/f Imax controller: Gain (V/f Imax contr.: Gain) 0.000 ... [0.284]* ... 1000.000 Hz/A • Default setting depending on the size.	Gain factor Vp of the Imax controller. • The parameter is calculated and set in the course of the automatic identification of the motor data. • The parameter can also be set and thus overwritten by selecting a motor in the engineering tool from the "motor catalog" or calibrating the motor data. ▶ Automatic identification of the motor data □ 103
0x2B08:002 (P333.02)	V/f Imax controller: Reset time (V/f Imax contr.: Reset time) 1.0 ... [2.3]* ... 2000.0 ms • Default setting depending on the size.	Reset time Ti of the Imax controller. • The parameter is calculated and set in the course of the automatic identification of the motor data. • The parameter can also be set and thus overwritten by selecting a motor in the engineering tool from the "motor catalog" or calibrating the motor data. ▶ Automatic identification of the motor data □ 103

7.4.3 Current controller

Parameter	Name / value range / [default setting]	Info
0x2942:001 (P334.01)	Current controller parameters: Gain (Current contr.: Gain) 0.00 ... [42.55]* ... 750.00 V/A • Default setting depending on the size.	Gain factor Vp of the current controller.



Parameter	Name / value range / [default setting]	Info
0x2942:002 (P334.02)	Current controller parameters: Reset time (Current contr.: Reset time) 0.01 ... [4.50] * ... 2000.00 ms • Default setting depending on the size.	Reset time T_i of the current controller.

7.5 Motor rotating direction

In the default setting, both directions of motor rotation are enabled. Optionally, the direction of rotation can be restricted so that only a clockwise rotation (CW) of the motor is possible.

Preconditions

Wiring of the motor phases must be carried out correctly with regard to the direction of motor rotation.

In the documentation and the parameter selection texts, the following terms are used for the direction of rotation:

- Forward = clockwise direction of rotation (CW)
- Reverse = counter-clockwise direction of rotation (CCW)

Details

The direction of rotation of the motor can be controlled in various ways:

- Via the function "Invert rotation". Possible triggers to be selected for the function "Invert rotation" are available for example in [0x2631:013 \(P400.13\)](#) the digital inputs and internal status signals of the inverter.
- Via network. The definition of the direction of rotation is possible via the mappable Net-WordIN1 data word or one of the predefined process data words.
- By specifying a bipolar setpoint value via analog input. Either via bipolar input range (-10 ... +10 V) or configuration of a bipolar setting range.

If a reversal is not required, the direction of rotation can be restricted in [0x283A \(P304.00\)](#) to "Only clockwise (CW) [0]".

Parameter	Name / value range / [default setting]	Info
0x283A (P304.00)	Limitation of rotation (Limit. rotation)	Optional restriction of the rotating direction.
	0 Only clockwise (CW)	The motor can only be rotated clockwise (CW). The transfer of negative frequency and PID setpoints to the motor control is prevented. <ul style="list-style-type: none"> • This function takes effect after the "Invert rotation" function (0x2631:013 (P400.13)). • Since this function only prevents negative setpoints, counter-clockwise rotation (CCW) is possible if the motor has been wired for this rotating direction.
	1 Both rotation directions	Both directions of motor rotation are enabled.
0x2631:013 (P400.13)	Function list: Invert rotation (Function list: Invert rotation) <ul style="list-style-type: none"> • Setting can only be changed if the inverter is inhibited. • For possible settings see description for 0x2631:001 (P400.01). 300 	Assignment of a trigger for the "Invert rotation" function. Trigger = TRUE: the setpoint specified is inverted (i. e. the sign is inverted). Trigger = FALSE: no action / deactivate function again.
	13 Digital input 3	State of X3/DI3, taking an inversion set in 0x2632:003 (P411.03) into consideration.

Motor control

Switching frequency changeover



7.6 Switching frequency changeover

The output voltage of the inverter is a DC voltage with sine-coded pulse width modulation (PWM). This corresponds by approximation to a AC voltage with variable frequency. The frequency of the PWM pulses is adjustable and is called "switching frequency".

Details

The switching frequency has an impact on the smooth running performance and the noise generation in the motor connected as well as on the power loss in the inverter. The lower the switching frequency, the better the concentricity factor, the smaller the power loss and the higher the noise generation.

Parameter	Name / value range / [default setting]	Info
0x2939 (P305.00)	Switching frequency (Switching freq.)	Selection of the inverter switching frequency.
	1 4 kHz variable / drive-optimised	Abbreviations used: <ul style="list-style-type: none">• "Variable": adaptation of the switching frequency as a function of the current• "Drive-opt.": drive-optimised modulation ("sine/delta modulation")• "Fixed": fixed switching frequency• "Min. Pv": additional reduction of power loss
	2 8 kHz variable / drive-optimised	
	3 16 kHz variable / drive-optimised	
	5 2 kHz fixed / drive-optimised	
	6 4 kHz fixed / drive-optimised	
	7 8 kHz fixed / drive-optimised	
	8 16 kHz fixed / drive-optimised	
	11 4 kHz variable / min. Pv	
	12 8 kHz variable / min. Pv	
	13 16 kHz variable / min. Pv	
	15 2 kHz constant/min. Pv	
	16 4 kHz constant/min. Pv	
	17 8 kHz constant/min. Pv	
	18 16 kHz constant/min. Pv	
	21 8 kHz variable / drive-optimised / 4 kHz min.	
	22 16 kHz variable / drive-optimised / 4 kHz min.	
	23 16 kHz variable / drive-optimised / 8 kHz min.	
31 8 kHz variable /min. Pv / 4 kHz min.		
32 16 kHz variable /min. Pv / 4 kHz min.		
33 16 kHz variable /min. Pv / 8 kHz min.		



7.7 Motor protection

Many monitoring functions integrated in the inverter can detect errors and thus protect the device or motor from being destroyed or overloaded.

- [Motor overload monitoring \(\$i^2 \cdot t\$ \)](#) 126
- [Current limits](#) 130
- [Overcurrent monitoring](#) 132
- [Motor phase failure detection](#) 133
- [Motor speed monitoring](#) 134
- [Motor torque monitoring](#) 134

Motor control

Motor protection

Motor overload monitoring ($i^2 \cdot t$)



7.7.1 Motor overload monitoring ($i^2 \cdot t$)

This function monitors the thermal utilisation of the motor, taking the motor currents recorded and a mathematical model as a basis.

DANGER!

Fire hazard by overheating of the motor.

Possible consequences: Death or severe injuries

- ▶ To achieve full motor protection, an additional temperature monitoring function with a separate evaluation must be installed.

Details

This function only serves to functionally protect the motor. It is not suitable for the safety-relevant protection against energy-induced hazards, since the implementation is not fail-safe.

- When the thermal motor utilisation calculated reaches the threshold set in [0x2D4B:001 \(P308.01\)](#), the response set in [0x2D4B:003 \(P308.03\)](#) is triggered.
- With the setting [0x2D4B:003 \(P308.03\)](#) = "No response [0]", the monitoring function is deactivated.



For a UL-compliant operation, leave [0x2D4B:002 \(P308.02\)](#) and [0x2D4B:003 \(P308.03\)](#) to the default setting!

(speed compensation = "on [0]" and error response = "Fault [3]")

In order to meet the UL requirements, the calculated motor load is internally saved when the inverter is switched off and loaded again when the inverter is switched on.



The following two diagrams show the relation between the motor load and release time of the monitoring under the following conditions:

- Maximum utilisation **0x2D4B:001 (P308.01)** = 150 %
- Speed compensation **0x2D4B:002 (P308.02)** = "Off [1]" or output frequency ≥ 40 Hz

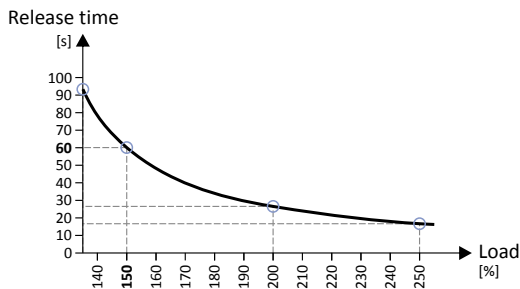
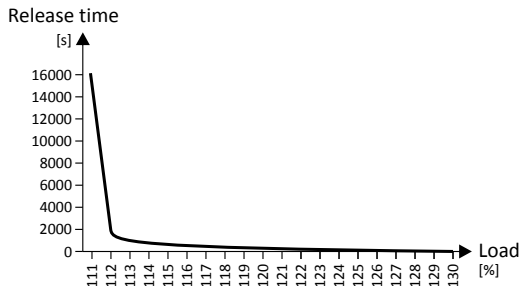

Load * Load ratio	Release time
110 %	Indefinite
135 %	93 s
150 %	60 s
200 %	26 s
250 %	17 s

Depending on the setting in **0x2D4B:001 (P308.01)**, the release time from the diagrams can be derived as follows:

- Calculation of the load ratio:
Load ratio = 150 % / maximum utilisation **0x2D4B:001 (P308.01)**
(example: **0x2D4B:001 (P308.01)** = 75 % \rightarrow load ratio = 150 % / 75 % = 2)
- Calculation of the release time of the monitoring:
Release time = actual load * load ratio
(example: actual load = 75 % \rightarrow release time = 75 % * 2 = 150 %)
- Looking up the release time from the above table based on load * load ratio.
(example: Load * load ratio = 150 % \rightarrow release time = 60 s)

Motor control

Motor protection
 Motor overload monitoring ($i^2 \cdot t$)



Speed compensation for protecting motors at low speed

The inverter comes with an implemented compensation for low speed. If the motor is driven with frequencies lower than 40 Hz, the speed compensation in [0x2D4B:002 \(P308.02\)](#) should be set to "On [0]" (default setting). This setting serves to reduce the release time of the monitoring at low speed to consider the reduced natural ventilation at AC motors. The speed compensation for UL-compliant operation in [0x2D4B:002 \(P308.02\)](#) must be set to "On [0]" as well.

If the speed compensation is activated, the release time is reduced as follows:

- With an output frequency < 40 Hz: Reduced release time to $62.5\% + 37.5\% \cdot \text{output frequency [Hz]} / 40 \text{ [Hz]}$
- With an output frequency ≥ 40 Hz: No reduced release time

The following diagram shows the reduced release time with activated speed compensation.

- Maximum utilisation [0x2D4B:001 \(P308.01\)](#) = 150 %
- Speed compensation [0x2D4B:002 \(P308.02\)](#) = "On [0]"

Release time

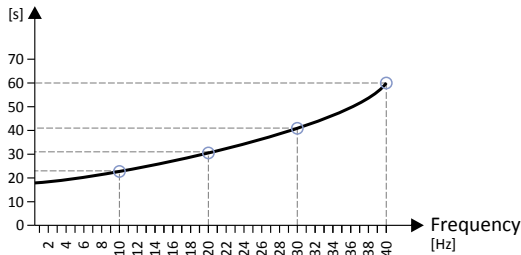

Output frequency	Release time
40 Hz	60 s
30 Hz	≈ 41 s
20 Hz	≈ 31 s
10 Hz	≈ 23 s

The following diagram shows the possible permanent load with activated speed compensation without the monitoring being triggered.

- Maximum utilisation [0x2D4B:001 \(P308.01\)](#) = 150 %
- Speed compensation [0x2D4B:002 \(P308.02\)](#) = "On [0]"

Load

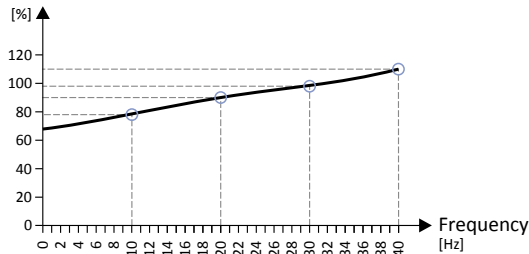

Output frequency	Possible permanent load
40 Hz	110 %
30 Hz	99 %
20 Hz	90 %
10 Hz	79 %

In case of 0 Hz, only a load of 62.7 % ($\approx 62.5\%$) with regard to the load at 40 Hz or above is possible ($69 / 110 \cdot 100\% = 62.7\%$). In case of a deviating setting in [0x2D4B:001 \(P308.01\)](#), the maximum possible motor load changes proportionately.

Parameter	Name / value range / [default setting]	Info
0x2D4B:001 (P308.01)	Motor overload monitoring ($i^2 \cdot t$): Maximum utilisation [60 s] (Motor overload: Max.load.for 60s) 30 ... [150] ... 200 %	Maximum permissible thermal motor utilisation (max. permissible motor current for 60 seconds). <ul style="list-style-type: none"> • 100 % \equiv rated motor current 0x6075 (P323.00) • If the motor is actuated with the current set here for 60 seconds, the maximum permissible thermal motor utilisation is reached and the response set in 0x2D4B:003 (P308.03) is executed. • If the motor is actuated with a different current, the time period until the motor overload monitoring function is activated is different. Generally the following applies: the lower the current, the lower the thermal utilisation and the later the monitoring function is triggered.



Motor control

Motor protection

Motor overload monitoring (i²*t)

Parameter	Name / value range / [default setting]	Info
0x2D4B:002 (P308.02)	Motor overload monitoring (i ² *t): Speed compensation (Motor overload: Speed comp.)	Use this function to protect motors that are actuated at a speed below 40 Hz. <ul style="list-style-type: none"> UL-compliant operation requires the setting "On [0]"!
	0 On	Release time for motor overload monitoring is reduced in order to compensate for the reduced cooling of naturally ventilated AC induction motors during operation at low speed.
	1 Off	Function deactivated, no reduction of the motor overload monitoring release time.
0x2D4B:003 (P308.03)	Motor overload monitoring (i ² *t): Response (Motor overload: Response) <ul style="list-style-type: none"> For possible settings see description for 0x2D45:001 (P310.01), 133 	Selection of the response to the triggering of motor overload monitoring. <ul style="list-style-type: none"> UL-compliant operation requires the setting "Error [3]"!
	3 Fault	▶ Error types 83
0x2D4B:005	Motor overload monitoring (i ² *t): Thermal load <ul style="list-style-type: none"> Read only 	Display of the value of the internal i ² *t integrator. <ul style="list-style-type: none"> 37500 ≙ 100 % thermal load When power is switched off, this value is saved in the internal EEPROM. When power is switched on, the saved value is reloaded into the i²*t integrator.

Motor control

Motor protection
Current limits



7.7.2 Current limits

For the purpose of current limitation, a maximum overload current can be set for the inverter. If the current consumption of the motor exceeds this current limit, the inverter changes its dynamic behaviour, in order to counteract this exceedance.

Details

- The maximum overload current of the inverter can be set in [0x6073 \(P324.00\)](#).
- Reference for the percentage setting of the maximum overload current is the rated motor current set in [0x6075 \(P323.00\)](#).
- The actual motor current is displayed in [0x2D88 \(P104.00\)](#).



If the change in the dynamic behaviour carried out by the inverter does not result in exiting the overcurrent state, the inverter outputs an error.

Load behaviour	Impact
Overload during acceleration in motor mode	A longer time than is required for reaching the frequency setpoint is set.
Overload during deceleration in generator mode	A longer time than is required for reaching standstill is set.
Increasing load at constant frequency	If the motor current limit value is reached: <ul style="list-style-type: none"> • The inverter reduces the effective speed setpoint until a stable working is set or an effective speed setpoint of 0 rpm is reached. • If the load is reduced, the inverter increases the effective speed setpoint until the setpoint speed is reached or the load reaches the current limit value again.
	When the generator current limit value is reached: <ul style="list-style-type: none"> • The inverter increases the effective speed setpoint until a stable working point is reached or up to the maximum permissible output frequency 0x2916 (P211.00). • If the load is reduced, the inverter reduces the effective speed setpoint until the setpoint speed is reached or the load reaches the current limit value again.
	If an abrupt load is building at the motor shaft (e.g. drive is blocked), the overcurrent switch-off function may respond.

Example: Overcurrent switch-off in case of a sudden load at the motor shaft

Frequency setpoint selection

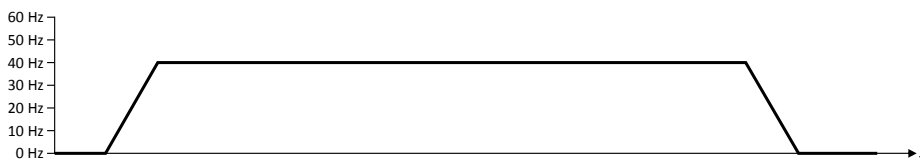

Output frequency

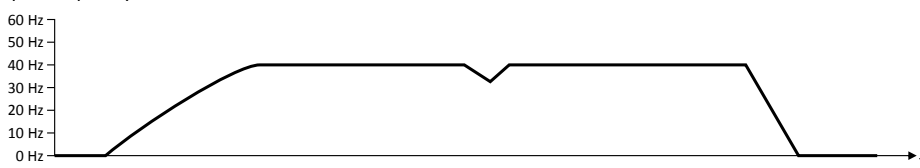

Motor load

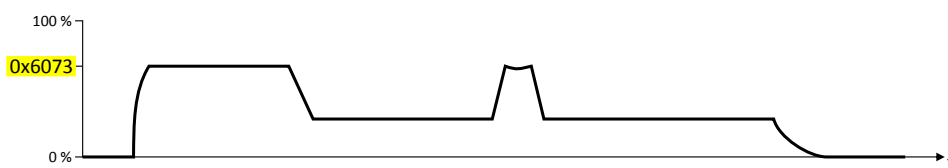



Motor control

Motor protection Current limits

Parameter	Name / value range / [default setting]	Info
0x6073 (P324.00)	Max current (Max current) 0.0 ... [200.0] ... 3000.0 %	<p>Maximum overload current of the inverter.</p> <ul style="list-style-type: none"> • 100 % \equiv Motor rated current 0x6075 (P323.00) • If the current consumption of the motor exceeds this current limit, the inverter changes its dynamic behaviour, in order to counteract this exceedance. • If the change in the dynamic behaviour carried out by the inverter does not result in exiting the overcurrent state, the inverter outputs an error. <p>Note! This parameter is not identical to the so-called ultimate motor current I_{ULT}!</p> <ul style="list-style-type: none"> • The ultimate motor current set in 0x2D46:001 (P353.01) is a limit value for synchronous motors that serves to protect their magnets. • The value to be set here should always be considerably below the ultimate motor current!
0x2D88 (P104.00)	Motor current (Motor current) • Read only: x.x A	Display des present current-r.m.s. value.
0x6078 (P103.00)	Current actual value (Current actual) • Read only: x.x %	<p>Display of the present motor current.</p> <ul style="list-style-type: none"> • 100 % \equiv Motor rated current 0x6075 (P323.00)

Motor control

Motor protection
Overcurrent monitoring



7.7.3 Overcurrent monitoring

This function monitors the instantaneous value of the motor current and serves as motor protection.

i NOTICE

With an incorrect parameterisation, the maximum permissible motor current may be exceeded in the process.

Possible consequence: irreversible damage of the motor.

- ▶ The setting of the threshold for the overcurrent monitoring in [0x2D46:001 \(P353.01\)](#) must be adapted to the connected motor.
- ▶ Set the maximum output current of the inverter in [0x6073 \(P324.00\)](#) much lower than the threshold for overcurrent monitoring.

Details

The inverter monitors its output current. This monitoring takes place irrespective of the settings for the current limiting function. ▶ [Current limits](#) [130](#)

- If the instantaneous value of the motor current exceeds the threshold set in [0x2D46:001 \(P353.01\)](#), the response set in [0x2D46:002 \(P353.02\)](#) takes place.
- With the setting [0x2D46:002 \(P353.02\)](#) = "No response [0]", the monitoring function is deactivated.

The threshold for the overcurrent monitoring is preset to four times the rated motor current. This presetting is overwritten in case a motor in the engineering tool is selected from the "motor catalog" or the automatic identification or calibration of the motor data is carried out. For a suitable protection, the automatically adapted setting should be used. If disturbances occur during operation, the value can be increased.

Parameter	Name / value range / [default setting]	Info
0x2D46:001 (P353.01)	Overcurrent monitoring: Threshold (Overcurr. monit.: Threshold) 0.0 ... [6.8]* ... 1000.0 A <ul style="list-style-type: none">• Default setting depending on the size.• From version 02.00	Warning/error threshold for motor current monitoring. <ul style="list-style-type: none">• If the instantaneous value of the motor current exceeds the threshold set, the response set in 0x2D46:002 (P353.02) is effected for the purpose of motor protection.• The parameter is calculated and set in the course of the automatic identification of the motor data.• The parameter can also be set and thus overwritten by selecting a motor in the engineering tool from the "motor catalog" or calibrating the motor data. ▶ Automatic identification of the motor data 103
0x2D46:002 (P353.02)	Overcurrent monitoring: Response (Overcurr. monit.: Response) <ul style="list-style-type: none">• For possible settings see description for 0x2D45:001 (P310.01). 133 3 Fault	Selection of the response to the triggering of motor current monitoring. Associated error code: <ul style="list-style-type: none">• 29056 0x7180 - Motor overcurrent ▶ Error types 83



7.7.4 Motor phase failure detection

The motor phase failure detection function can be activated for both synchronous and asynchronous motors.

Preconditions

Phase failure detection during operation is basically only suitable for applications which are operated with a constant load and speed. In all other cases, transient processes or unfavourable operating points can cause maloperation.

Details

If a current-carrying motor phase (U, V, W) fails during operation, the response selected in [0x2D45:001 \(P310.01\)](#) is tripped if the following two conditions are met:

- Condition 1: detection is activated. See [0x2D45:002 \(P310.02\)](#)
- Condition 2: a specific commutation angle (approx. 150° electrically) has been covered without the detection of a current flow.

Parameter	Name / value range / [default setting]	Info
0x2D45:001 (P310.01)	Motor phase failure detection: Response (Mot.phase.fail.: Response)	Selection of the response following the detection of a motor phase failure. Associated error codes: <ul style="list-style-type: none"> • 65289 0xFF09 - Motor phase failure • 65290 0xFF0A - Motor phase failure phase U • 65291 0xFF0B - Motor phase failure phase V • 65292 0xFF0C - Motor phase failure phase W
	0 No response	▶ Error types 83
	1 Warning	
	2 Trouble	
	3 Fault	
0x2D45:002 (P310.02)	Motor phase failure detection: Current threshold (Mot.phase.fail.: Current thresh.) 1.0 ... [5.0] ... 10.0 %	Current threshold for the activation of the motor phase failure detection function. <ul style="list-style-type: none"> • 100 % ≡ Maximum current 0x2DDF:002 • Background: in order to be able to reliably detect the failure of a motor phase, first a certain must flow for the current sensor system. The detection function is therefore only activated if the actual value of the motor current has exceeded the current threshold set here. • Display of the present motor current in 0x2D88 (P104.00).
0x2D45:003 (P310.03)	Motor phase failure detection: Voltage threshold (Mot.phase.fail.: Voltage thresh.) 0.0 ... [10.0] ... 100.0 V	Voltage threshold for the monitoring of several motor phases. <ul style="list-style-type: none"> • The V/f characteristic control enables the detection of several failed motor phases during operation. • Monitoring with regard to the failure of several motor phases is active if a response that is not "0: No response" is set in 0x2D45:001 (P310.01) and if the motor voltage exceeds the voltage threshold set here. • The monitoring function is triggered if the level of the motor current is lower than the device-dependent threshold for longer than 20 ms. • The monitoring function for the failure of several motor phases can be deactivated if the value "100.0 V" is set here.

Motor control

Motor protection
Motor speed monitoring



7.7.5 Motor speed monitoring

This function monitors the motor speed during operation.

Preconditions

- In order to detect the current motor speed, the inverter must be enabled and the motor must rotate.
- For an exact monitoring, rated motor speed [0x2C01:004 \(P320.04\)](#) and rated motor frequency [0x2C01:005 \(P320.05\)](#) must be set correctly.

Details

- If the motor speed reaches the threshold set in [0x2D44:001 \(P350.01\)](#), the response set in [0x2D44:002 \(P350.02\)](#) takes place.
- With the setting [0x2D44:002 \(P350.02\)](#) = "No response [0]", the monitoring function is deactivated.

Parameter	Name / value range / [default setting]	Info
0x2D44:001 (P350.01)	Overspeed monitoring: Threshold (Overspeed monit.: Threshold) 50 ... [8000] ... 50000 rpm	Warning/error threshold for motor speed monitoring. <ul style="list-style-type: none"> • If the motor speed reaches the threshold set, the response selected in 0x2D44:002 (P350.02) is effected. • The parameter is calculated and set in the course of the automatic identification of the motor data. • The parameter can also be set and thus overwritten by selecting a motor in the engineering tool from the "motor catalog" or calibrating the motor data. ▶ Automatic identification of the motor data □ 103
0x2D44:002 (P350.02)	Overspeed monitoring: Response (Overspeed monit.: Response) <ul style="list-style-type: none"> • For possible settings see description for 0x2D45:001 (P310.01). □ 133 	Selection of the response to the triggering of motor speed monitoring. Associated error code: <ul style="list-style-type: none"> • 65286 0xFF06 - Motor overspeed
	3 Fault	▶ Error types □ 83

7.7.6 Motor torque monitoring

This function monitors the motor torque during operation.

Preconditions

The motor torque monitoring can only be used for control modes with speed controller. Thus, the selection "V/f characteristic control (VFC open loop) [6]" must not be set in .

Details

This function sets the internal status signal "Torque limit reached [79]" = TRUE if the maximum possible torque has been reached.

- The status signal is set irrespective of the response [0x2D67:001 \(P329.01\)](#) and delay time [0x2D67:002 \(P329.02\)](#) set for this monitoring.
- The user can use the status signal to activate certain functions. [▶ Flexible I/O configuration](#) [□ 292](#)
- The status signal also serves to set a digital output or a bit of the NetWordOUT1 status word. [▶ Configuration of digital outputs](#) [□ 355](#)

Parameter	Name / value range / [default setting]	Info
0x2D67:001 (P329.01)	Maximum torque monitoring: Response (MaxTrq.Monitor: Response) <ul style="list-style-type: none"> • From version 02.00 	Selection of response to reaching the maximum possible torque. <ul style="list-style-type: none"> • The selected response takes place if the status signal "Torque limit reached [79]" = TRUE and the deceleration time set in 0x2D67:002 (P329.02) has elapsed. Associated error code: <ul style="list-style-type: none"> • 33553 0x8311 - Torque limit reached
	0 No reaction	▶ Error types □ 83
	1 Warning	
	2 Trouble	
	3 Fault	



Motor control

Motor protection

Motor torque monitoring

Parameter	Name / value range / [default setting]	Info
0x2D67:002 (P329.02)	Maximum torque monitoring: Triggering delay (MaxTrq.Monitor: Triggering delay) 0.000 ... [0.000] ... 10.000 s <ul style="list-style-type: none"> From version 02.00 	Optional setting of a deceleration for triggering the response selected in 0x2D67:001 (P329.01) . Typical application: <ul style="list-style-type: none"> The motor should be driven at the torque limit for a short time without triggering the selected response. Only after a longer operation (> set deceleration) at the torque limit, the selected response is to take place.
0x6072 (P326.00)	Max torque (Max torque) 0.0 ... [250.0] ... 3000.0 % <ul style="list-style-type: none"> From version 02.00 	Symmetrical selection of the maximum permissible torque. <ul style="list-style-type: none"> 100 % ≡ Motor rated torque 0x6076 (P325.00) This parameter serves to implement a statically and bipolarly acting torque limitation. This can be used, for instance, as overload protection of the mechanical transmission path/elements starting at the motor shaft. This limitation acts irrespective of the torque limitations acting in unipolar mode that are set in 0x60E0 and 0x60E1.
0x60E0	Positive torque limit 0.0 ... [250.0] ... 3276.7 % <ul style="list-style-type: none"> From version 02.00 	Positive torque limit source for speed control with torque limitation. <ul style="list-style-type: none"> 100 % ≡ Motor rated torque 0x6076 (P325.00)
0x60E1	Negative torque limit 0.0 ... [250.0] ... 3276.7 % <ul style="list-style-type: none"> From version 02.00 	Negative torque limit source for speed control with torque limitation. <ul style="list-style-type: none"> 100 % ≡ Motor rated torque 0x6076 (P325.00)



8 Configuring the network

The inverter is available in a version with CANopen[®] and Modbus network option.

- [General network settings](#) 137
- [Predefined process data words](#) 149
- [Acyclic data exchange](#) 157
- [CANopen](#) 158
- [Modbus](#) 184
- [Wireless LAN \(WLAN\)](#) 196



8.1 General network settings

Activate network control

In order to be able to control the inverter via network, a trigger must be first assigned in [0x2631:037 \(P400.37\)](#) to the "Activate network control" function.

- This trigger can for instance be the constant value "TRUE" or a digital input.
- If the assigned trigger is = TRUE, the motor can only be started via the network control word (exception: Jog operation; see chapter "[Start / stop motor](#)" [□ 299](#)).

In case of an activated network control, the following functions are still active:

- [0x2631:001 \(P400.01\)](#): Enable inverter
- [0x2631:002 \(P400.02\)](#): Run
- [0x2631:003 \(P400.03\)](#): Activate quick stop
- [0x2631:004 \(P400.04\)](#): Reset fault
- [0x2631:005 \(P400.05\)](#): Activate DC braking
- [0x2631:010 \(P400.10\)](#): Jog forward (CW)
- [0x2631:011 \(P400.11\)](#): Jog reverse (CCW)
- [0x2631:012 \(P400.12\)](#): Activate keypad control
- [0x2631:037 \(P400.37\)](#): Activate network control

All other functions configurable via [0x2631:xx \(P400.xx\)](#) are deactivated in case of network control. ▶ [Flexible I/O configuration](#) [□ 292](#)

Network control word and status word

For establishing a simple network connection, the inverter provides predefined control and status words for device profile CiA 402, AC drive profile as well as in LECOM format. For implementing your own formats, the data words NetWordIN1 and NetWordOUT1 are available. By means of data mapping to a network register, each of these words can be transferred as process data via network.

Name	Parameter	Associated mapping entry *	Further information
CiA: Controlword	0x6040	0x60400010	▶ Device profile CiA 402 □ 150
CiA: Statusword	0x6041 (P780.00)	0x60410010	
AC Drive control word	0x400B:001 (P592.01)	0x400B0110	▶ AC Drive Profile □ 151
AC Drive status word	0x400C:001 (P593.01)	0x400C0110	
LECOM control word	0x400B:002 (P592.02)	0x400B0210	▶ Lenze LECOM profile □ 152
LECOM status word	0x400C:002 (P593.02)	0x400C0210	
NetWordIN1	0x4008:001 (P590.01)	0x40080110	For implementing an individual control word format. The functions that are to be triggered via bits 0 ... 15 of the NetWordIN1 data word are defined in 0x400E:001 (P505.01) ... 0x400E:016 (P505.16) .
NetWordOUT1	0x400A:001 (P591.01)	0x400A0110	For implementing an individual status word format. The triggers for bits 0 ... 15 of the NetWordOUT1 data word are defined in 0x2634:010 (P420.10) ... 0x2634:025 (P420.25) .

* A mapping entry consists of index, subindex and data length in bits of the parameter to be mapped.

General information about the process of data mapping can be found in the chapter of the same name for the corresponding network.

Configuring the network

General network settings



Network setpoint

In order to generally set the network as standard setpoint source, go to [0x2860:001 \(P201.01\)](#) and select "Network [5]".

- If the network control is not active ([0x2631:037 \(P400.37\)](#) = "FALSE"), the "Activate network setpoint" function serves to change over to the network setpoint. The setpoint change-over only takes place if no setpoint source with a higher priority has been selected.
 - ▶ [Priority of the setpoint sources](#) [□ 314](#)
- If the network control is activated ([0x2631:037 \(P400.37\)](#) = "TRUE"), a change-over to the network setpoint is possible via the used network control word:

Network control word	Change-over to network setpoint															
NetWordIN1 data word 0x4008:001 (P590.01)	Assign the function "Activate network setpoint [17]" to the bit that is to be used for activating the network setpoint. <ul style="list-style-type: none"> • The functions that are to be triggered via bits 0 ... 15 of the NetWordIN1 data word are defined in 0x400E:001 (P505.01) ... 0x400E:016 (P505.16). <table border="1"> <thead> <tr> <th>Bit x</th> <th>Selection:</th> </tr> </thead> <tbody> <tr> <td>0</td> <td>Standard setpoint source selected in 0x2860:001 (P201.01).</td> </tr> <tr> <td>1</td> <td>Network setpoint</td> </tr> </tbody> </table>	Bit x	Selection:	0	Standard setpoint source selected in 0x2860:001 (P201.01) .	1	Network setpoint									
Bit x	Selection:															
0	Standard setpoint source selected in 0x2860:001 (P201.01) .															
1	Network setpoint															
AC drive control word 0x400B:001 (P592.01)	The network setpoint is activated via bit 6 of the AC Drive control word: <table border="1"> <thead> <tr> <th>Bit 6</th> <th>Selection:</th> </tr> </thead> <tbody> <tr> <td>0</td> <td>Standard setpoint source selected in 0x2860:001 (P201.01).</td> </tr> <tr> <td>1</td> <td>Network setpoint</td> </tr> </tbody> </table>	Bit 6	Selection:	0	Standard setpoint source selected in 0x2860:001 (P201.01) .	1	Network setpoint									
Bit 6	Selection:															
0	Standard setpoint source selected in 0x2860:001 (P201.01) .															
1	Network setpoint															
LECOM control word 0x400B:002 (P592.02)	The setpoint is selected via bit 0 and bit 1 of the LECOM control word: <table border="1"> <thead> <tr> <th>Bit 1</th> <th>Bit 0</th> <th>Selection:</th> </tr> </thead> <tbody> <tr> <td>0</td> <td>0</td> <td>Standard setpoint source selected in 0x2860:001 (P201.01).</td> </tr> <tr> <td>0</td> <td>1</td> <td>Frequency setpoint preset 1 0x2911:001 (P450.01)</td> </tr> <tr> <td>1</td> <td>0</td> <td>Frequency setpoint preset 2 0x2911:002 (P450.02)</td> </tr> <tr> <td>1</td> <td>1</td> <td>Frequency setpoint preset 3 0x2911:003 (P450.03)</td> </tr> </tbody> </table>	Bit 1	Bit 0	Selection:	0	0	Standard setpoint source selected in 0x2860:001 (P201.01) .	0	1	Frequency setpoint preset 1 0x2911:001 (P450.01)	1	0	Frequency setpoint preset 2 0x2911:002 (P450.02)	1	1	Frequency setpoint preset 3 0x2911:003 (P450.03)
Bit 1	Bit 0	Selection:														
0	0	Standard setpoint source selected in 0x2860:001 (P201.01) .														
0	1	Frequency setpoint preset 1 0x2911:001 (P450.01)														
1	0	Frequency setpoint preset 2 0x2911:002 (P450.02)														
1	1	Frequency setpoint preset 3 0x2911:003 (P450.03)														
CiA 402 Controlword 0x6040	In case of control via device profile CiA 402: <ul style="list-style-type: none"> • In the operating mode "CiA: Velocity mode [2]", the setpoint speed defined via the "Target velocity" 0x6042 (P781.00) parameter is used. ▶ Device profile CiA 402 □ 262 • A change-over to an alternative setpoint source via the CiA 402 Controlword is not possible. 															

Parameter	Name / value range / [default setting]	Info
0x231F:001 (P500.01)	Module ID: Active module ID (Module ID: Active module ID)	Display of the network options currently configured in the inverter. <ul style="list-style-type: none"> • When the "Load default settings" device command 0x2022:001 (P700.01) or "Accept new inverter hardware" 0x2022:027 (P700.27) is executed, the module ID is stored in the memory module. • With the help of this module ID, the keypad only shows the communication parameters relevant to the respective network. Note! When the inverter is switched on, it checks whether the parameter settings stored in the memory module match the network option available in the inverter. If not, the inverter changes to the error status. The error status can only be quit if all parameters are initialised for the new (available) network option. ▶ Initialising the network interface □ 221
	• Read only	
	• Default setting depending on the size.	
	48 No network	
	65 AS-Interface <ul style="list-style-type: none"> • From version 02.00 	
	67 CANopen	
	71 EtherNet/IP <ul style="list-style-type: none"> • From version 02.00 	
	80 PROFIBUS	
82 ProfiNet <ul style="list-style-type: none"> • From version 02.00 		
84 EtherCAT <ul style="list-style-type: none"> • From version 02.00 		
87 Modbus		



Configuring the network

General network settings

Parameter	Name / value range / [default setting]	Info
0x231F:002 (P500.02)	Module ID: Module ID connected (Module ID: Module ID conn.) • Read only	Display of the network option currently available in the inverter.
	48 No network	Note! When the inverter is switched on, it checks whether the parameter settings stored in the memory module match the network option available in the inverter. If not, the inverter changes to the error status. The error status can only be quit if all parameters are initialised for the new (available) network option. ▶ Initialising the network interface □ 221
	65 AS-Interface • From version 02.00	
	67 CANopen	
	71 EtherNet/IP • From version 02.00	
	80 PROFIBUS	
	82 ProfiNet • From version 02.00	
	84 EtherCAT • From version 02.00	
	87 Modbus	

Configuring the network

General network settings



Parameter	Name / value range / [default setting]	Info
0x400E:001 (P505.01)	NetWordIN1 function: Bit 0 (NetWordIN1 fct.: NetWordIN1.00) <ul style="list-style-type: none"> Setting can only be changed if the inverter is inhibited. 	Definition of the function that is to be triggered via bit 0 of the mappable NetWordIN1 data word.
	0 Not active	Trigger bit without any function.
	1 Disable inverter	Trigger bit = 0-1 edge: The inverter is disabled. Trigger bit = 0: The inverter is enabled (unless there is another cause for inverter disable). Notes: <ul style="list-style-type: none"> In all device states, a 0-1 edge causes an immediate change to the inhibited state with one exception: If the inverter is in the error status and the error condition still exists, the inverter remains in the error status. Changing to the disabled state causes an immediate stop of the motor, regardless of the stop method set in 0x2838:003 (P203.03). The motor coasts down as a function of the mass inertia of the machine. In the disabled state, the motor cannot be started. After the inverter disable is deactivated, a renewed start command is required to restart the motor. The cause(s) that are active for the disabled state are shown in 0x282A:001 (P126.01).
	2 Stopping	Trigger bit = 1: Motor is stopped. Trigger bit = 0: No action / Deactivate stop again. Notes: <ul style="list-style-type: none"> The stop method can be selected in 0x2838:003 (P203.03).
	3 Activate quick stop	Trigger bit = 1: "Quick stop" function activated. Trigger bit = 0: no action / deactivate function again. Notes: <ul style="list-style-type: none"> The "Quick stop" function brings the motor to a standstill within the deceleration time set in 0x291C (P225.00). The "Quick stop" function has a higher priority than the "Run" function.
	4 Reset error	Trigger bit = 0-1 edge: Active error is reset (acknowledged) if the error condition is not active anymore and the error is resettable. Trigger bit = 0: No action. Notes: <ul style="list-style-type: none"> After resetting the error, a new enable/start command is required to restart the motor.
	5 Activate DC braking	Trigger bit = 1: "DC braking" function activated. Trigger bit = 0: no action / deactivate function again.
	8 Run forward (CW)	Trigger bit = 0-1 edge: Motor is started in forward rotating direction (CW). Trigger bit = 1-0 edge: Motor is stopped again. Notes: <ul style="list-style-type: none"> The stop method can be selected in 0x2838:003 (P203.03). In the case of a bipolar setpoint selection (e.g. ± 10 V), the function is executed irrespective of the rotating direction. The rotating direction is determined by the sign of the setpoint. The function also serves to realise an automatic start after switch-on. <ul style="list-style-type: none"> ▶ Starting performance 91 The "Invert rotation [13]" function can be used in connection with this function.



Parameter	Name / value range / [default setting]	Info
	9 Run reverse (CCW)	<p>Trigger bit = 0-1 edge: Motor is started in backward rotating direction (CCW).</p> <p>Trigger bit = 1-0 edge: Motor is stopped again.</p> <p>Notes:</p> <ul style="list-style-type: none"> The stop method can be selected in 0x2838:003 (P203.03). In the case of a bipolar setpoint selection (e.g. ± 10 V), the function is executed irrespective of the rotating direction. The rotating direction is determined by the sign of the setpoint. The function also serves to realise an automatic start after switch-on. <ul style="list-style-type: none"> ▶ Starting performance □91 The "Invert rotation [13]" function can be used in connection with this function.
	13 Invert rotation	<p>Trigger bit = 1: the setpoint specified is inverted (i. e. the sign is inverted).</p> <p>Trigger bit = 0: no action / deactivate function again.</p>
	14 Activate AI1 setpoint	<p>Trigger bit = 1: analog input 1 is used as setpoint source (if the trigger bit assigned has the highest setpoint priority).</p> <p>Trigger bit = 0: no action / deactivate function again.</p>
	15 Activate AI2 setpoint	<p>Trigger bit = 1: analog input 2 is used as setpoint source (if the trigger bit assigned has the highest setpoint priority).</p> <p>Trigger bit = 0: no action / deactivate function again.</p>
	17 Activate network setpoint	<p>Trigger bit = 1: the network is used as setpoint source (if the trigger bit assigned has the highest setpoint priority).</p> <p>Trigger bit = 0: no action / deactivate function again.</p>
	18 Activate preset (bit 0)	Selection bit with the valency 2^0 for the bit-coded selection and activation of a parameterisable setpoint (preset value).
	19 Activate preset (bit 1)	Selection bit with the valency 2^1 for the bit-coded selection and activation of a parameterisable setpoint (preset value).
	20 Activate preset (bit 2)	Selection bit with the valency 2^2 for the bit-coded selection and activation of a parameterisable setpoint (preset value).
	21 Activate preset (bit 3)	Selection bit with the valency 2^3 for the bit-coded selection and activation of a parameterisable setpoint (preset value).
	39 Activate ramp 2	<p>Trigger bit = 1: activate acceleration time 2 and deceleration time 2 manually.</p> <p>Trigger bit = 0: no action / deactivate function again.</p>
	40 Load parameter set	<p>Trigger bit = 0-1 edge: parameter change-over to the value set selected via "Select parameter set (bit 0)" and "Select parameter set (bit 1)".</p> <p>Trigger bit = 0: no action.</p> <p>Notes:</p> <ul style="list-style-type: none"> The activation method for the "Parameter change-over" function can be selected in 0x4046 (P755.00).
	41 Select parameter set (bit 0)	Selection bit with the valency 2^0 for "Parameter change-over" function.
	42 Select parameter set (bit 1)	Selection bit with the valency 2^1 for "Parameter change-over" function.
	43 Activate fault 1	<p>Trigger bit = 1: Trigger user-defined error 1.</p> <p>Trigger bit = 0: no action.</p> <p>Notes:</p> <ul style="list-style-type: none"> After the error is triggered, the motor is brought to a standstill with the quick stop ramp. The inverter is then disabled. <p>Associated error code:</p> <ul style="list-style-type: none"> 25249 0x62A1 - Network: user fault 1
	44 Activate fault 2	<p>Trigger bit = 1: Trigger user-defined error 2.</p> <p>Trigger bit = 0: no action.</p> <p>Notes:</p> <ul style="list-style-type: none"> After the error is triggered, the motor is brought to a standstill with the quick stop ramp. The inverter is then disabled. <p>Associated error code:</p> <ul style="list-style-type: none"> 25250 0x62A2 - Network: user fault 2

Configuring the network

General network settings



Parameter	Name / value range / [default setting]	Info
	45 Deactivate PID controlling	Trigger bit = 1: If PID control is activated, ignore PID control and drive the motor in speed-controlled manner. Trigger bit = 0: If PID control is activated, drive the motor with PID control. Notes: • The PID control can be activated in 0x4020:001 (P600.01) .
	46 Set PID output to 0	Trigger bit = 1: If PID control is activated, I component and the output of the PID controller are set to 0 and the internal control algorithm is stopped. The PID control remains active. Trigger bit = 0: No action / deactivate function again.
	47 Inhibit PID I-component	Trigger bit = 1: If the PID control is activated, the I component of the PID controller is set to 0 and the integration process is stopped. Trigger bit = 0: No action / deactivate function again. Notes: • The reset time can be set in 0x4049 (P602.00) .
	48 Activate PID influence ramp	Trigger bit = 1: the influence of the process controller is shown by means of a ramp. Trigger bit = 0 or not connected: the influence of the process controller is shown by means of a ramp. Notes: • The influence of the process controller is always active (not only when PID control is activated). • Acceleration time for showing the influence of the process controller can be set in 0x404C:001 (P607.01) . • Deceleration time for hiding the influence of the process controller can be set in 0x404C:002 (P607.02) .
0x400E:002 (P505.02)	NetWordIN1 function: Bit 1 (NetWordIN1 fct.: NetWordIN1.01) • Setting can only be changed if the inverter is inhibited. • For possible settings see description for 0x400E:001 (P505.01) . 140	Definition of the function that is to be triggered via bit 1 of the mappable NetWordIN1 data word.
	00 Not active	Trigger bit without any function.
0x400E:003 (P505.03)	NetWordIN1 function: Bit 2 (NetWordIN1 fct.: NetWordIN1.02) • Setting can only be changed if the inverter is inhibited. • For possible settings see description for 0x400E:001 (P505.01) . 140	Definition of the function that is to be triggered via bit 2 of the mappable NetWordIN1 data word.
	03 Activate quick stop	Trigger bit = 1: "Quick stop" function activated. Trigger bit = 0: no action / deactivate function again. Notes: • The "Quick stop" function brings the motor to a standstill within the deceleration time set in 0x291C (P225.00) . • The "Quick stop" function has a higher priority than the "Run" function.
0x400E:004 (P505.04)	NetWordIN1 function: Bit 3 (NetWordIN1 fct.: NetWordIN1.03) • Setting can only be changed if the inverter is inhibited. • For possible settings see description for 0x400E:001 (P505.01) . 140	Definition of the function that is to be triggered via bit 3 of the mappable NetWordIN1 data word.
	00 Not active	Trigger bit without any function.



Configuring the network

General network settings

Parameter	Name / value range / [default setting]	Info
0x400E:005 (P505.05)	NetWordIN1 function: Bit 4 (NetWordIN1 fct.: NetWordIN1.04) <ul style="list-style-type: none"> Setting can only be changed if the inverter is inhibited. For possible settings see description for 0x400E:001 (P505.01). 140 	Definition of the function that is to be triggered via bit 4 of the mappable NetWordIN1 data word.
	8 Run forward (CW)	Trigger bit = 0-1 edge: Motor is started in forward rotating direction (CW). Trigger bit = 1-0 edge: Motor is stopped again. Notes: <ul style="list-style-type: none"> The stop method can be selected in 0x2838:003 (P203.03). In the case of a bipolar setpoint selection (e.g. ±10 V), the function is executed irrespective of the rotating direction. The rotating direction is determined by the sign of the setpoint. The function also serves to realise an automatic start after switch-on. <ul style="list-style-type: none"> ▶ Starting performance 91 The "Invert rotation [13]" function can be used in connection with this function.
0x400E:006 (P505.06)	NetWordIN1 function: Bit 5 (NetWordIN1 fct.: NetWordIN1.05) <ul style="list-style-type: none"> Setting can only be changed if the inverter is inhibited. For possible settings see description for 0x400E:001 (P505.01). 140 	Definition of the function that is to be triggered via bit 5 of the mappable NetWordIN1 data word.
	18 Activate preset (bit 0)	Selection bit with the valency 2 ⁰ for the bit-coded selection and activation of a parameterisable setpoint (preset value).
0x400E:007 (P505.07)	NetWordIN1 function: Bit 6 (NetWordIN1 fct.: NetWordIN1.06) <ul style="list-style-type: none"> Setting can only be changed if the inverter is inhibited. For possible settings see description for 0x400E:001 (P505.01). 140 	Definition of the function that is to be triggered via bit 6 of the mappable NetWordIN1 data word.
	19 Activate preset (bit 1)	Selection bit with the valency 2 ¹ for the bit-coded selection and activation of a parameterisable setpoint (preset value).
0x400E:008 (P505.08)	NetWordIN1 function: Bit 7 (NetWordIN1 fct.: NetWordIN1.07) <ul style="list-style-type: none"> Setting can only be changed if the inverter is inhibited. For possible settings see description for 0x400E:001 (P505.01). 140 	Definition of the function that is to be triggered via bit 7 of the mappable NetWordIN1 data word.
	04 Reset error	Trigger bit = 0-1 edge: Active error is reset (acknowledged) if the error condition is not active anymore and the error is resettable. Trigger bit = 0: No action. Notes: <ul style="list-style-type: none"> After resetting the error, a new enable/start command is required to restart the motor.
0x400E:009 (P505.09)	NetWordIN1 function: Bit 8 (NetWordIN1 fct.: NetWordIN1.08) <ul style="list-style-type: none"> Setting can only be changed if the inverter is inhibited. For possible settings see description for 0x400E:001 (P505.01). 140 	Definition of the function that is to be triggered via bit 8 of the mappable NetWordIN1 data word.
	00 Not active	Trigger bit without any function.
0x400E:010 (P505.10)	NetWordIN1 function: Bit 9 (NetWordIN1 fct.: NetWordIN1.09) <ul style="list-style-type: none"> Setting can only be changed if the inverter is inhibited. For possible settings see description for 0x400E:001 (P505.01). 140 	Definition of the function that is to be triggered via bit 9 of the mappable NetWordIN1 data word.
	05 Activate DC braking	Trigger bit = 1: "DC braking" function activated. Trigger bit = 0: no action / deactivate function again.

Configuring the network

General network settings



Parameter	Name / value range / [default setting]	Info
0x400E:011 (P505.11)	NetWordIN1 function: Bit 10 (NetWordIN1 fct.: NetWordIN1.10) <ul style="list-style-type: none"> Setting can only be changed if the inverter is inhibited. For possible settings see description for 0x400E:001 (P505.01). □ 140 	Definition of the function that is to be triggered via bit 10 of the mappable NetWordIN1 data word.
	00 Not active	Trigger bit without any function.
0x400E:012 (P505.12)	NetWordIN1 function: Bit 11 (NetWordIN1 fct.: NetWordIN1.11) <ul style="list-style-type: none"> Setting can only be changed if the inverter is inhibited. For possible settings see description for 0x400E:001 (P505.01). □ 140 	Definition of the function that is to be triggered via bit 11 of the mappable NetWordIN1 data word.
	00 Not active	Trigger bit without any function.
0x400E:013 (P505.13)	NetWordIN1 function: Bit 12 (NetWordIN1 fct.: NetWordIN1.12) <ul style="list-style-type: none"> Setting can only be changed if the inverter is inhibited. For possible settings see description for 0x400E:001 (P505.01). □ 140 	Definition of the function that is to be triggered via bit 12 of the mappable NetWordIN1 data word.
	13 Invert rotation	Trigger bit = 1: the setpoint specified is inverted (i. e. the sign is inverted). Trigger bit = 0: no action / deactivate function again.
0x400E:014 (P505.14)	NetWordIN1 function: Bit 13 (NetWordIN1 fct.: NetWordIN1.13) <ul style="list-style-type: none"> Setting can only be changed if the inverter is inhibited. For possible settings see description for 0x400E:001 (P505.01). □ 140 	Definition of the function that is to be triggered via bit 13 of the mappable NetWordIN1 data word.
	00 Not active	Trigger bit without any function.
0x400E:015 (P505.15)	NetWordIN1 function: Bit 14 (NetWordIN1 fct.: NetWordIN1.14) <ul style="list-style-type: none"> Setting can only be changed if the inverter is inhibited. For possible settings see description for 0x400E:001 (P505.01). □ 140 	Definition of the function that is to be triggered via bit 14 of the mappable NetWordIN1 data word.
	00 Not active	Trigger bit without any function.
0x400E:016 (P505.16)	NetWordIN1 function: Bit 15 (NetWordIN1 fct.: NetWordIN1.15) <ul style="list-style-type: none"> Setting can only be changed if the inverter is inhibited. For possible settings see description for 0x400E:001 (P505.01). □ 140 	Definition of the function that is to be triggered via bit 15 of the mappable NetWordIN1 data word.
	00 Not active	Trigger bit without any function.
0x2022:027 (P700.27)	Device commands: Accept new inverter hardware (Device commands: Accept new HW) <ul style="list-style-type: none"> Setting can only be changed if the inverter is inhibited. 	1 = initialise parameters for a new network option.
	0 Off / ready	
	1 On / start	



Configuring the network

General network settings

Parameter	Name / value range / [default setting]	Info
0x2631:037 (P400.37)	Function list: Activate network control (Function list: Network control)	Assignment of a trigger for the "Activate network control" function. Trigger = TRUE: Activate network control. Trigger = FALSE: No action / deactivate network control again.
	0 Not connected	No trigger assigned (trigger is constantly FALSE).
	1 Constant TRUE	Trigger is constantly TRUE.
	11 Digital input 1	State of X3/DI1, taking an inversion set in 0x2632:001 (P411.01) into consideration.
	12 Digital input 2	State of X3/DI2, taking an inversion set in 0x2632:002 (P411.02) into consideration.
	13 Digital input 3	State of X3/DI3, taking an inversion set in 0x2632:003 (P411.03) into consideration.
	14 Digital input 4	State of X3/DI4, taking an inversion set in 0x2632:004 (P411.04) into consideration.
	15 Digital input 5	State of X3/DI5, taking an inversion set in 0x2632:005 (P411.05) into consideration.
	50 Running	TRUE if inverter and start are enabled and output frequency > 0.2 Hz. Otherwise FALSE.
	51 Ready for operation	TRUE if inverter is ready for operation (no error active, no STO active and DC-bus voltage ok). Otherwise FALSE.
	53 Stop active	TRUE if inverter is enabled and motor is not started and output frequency = 0.
	54 Quick stop active	TRUE if quick stop is active. Otherwise FALSE.
	58 Device warning active	TRUE if warning is active. Otherwise FALSE. <ul style="list-style-type: none"> A warning has no impact on the operating status of the inverter. A warning is reset automatically if the cause has been eliminated.
	59 Device fault active	TRUE if a fault is active. Otherwise FALSE. <ul style="list-style-type: none"> In the event of a fault, the motor is brought to a standstill with the quick stop ramp. The inverter is then disabled. Exception: In case of a serious fault, the inverter is disabled immediately. The motor becomes torqueless (coasts). The error state will be left automatically if the error condition is not active anymore. The restart behaviour after trouble can be configured. ▶ Automatic restart □ 281
	60 Heatsink temperature warning active	TRUE if current heatsink temperature > warning threshold for temperature monitoring. Otherwise FALSE. <ul style="list-style-type: none"> Display of the current heatsink temperature in 0x2D84:001 (P117.01). Setting of the warning threshold in 0x2D84:002.
	69 Rotational direction reversed	TRUE if output frequency is negative. Otherwise FALSE.
	70 Frequency threshold exceeded	TRUE if current output frequency > frequency threshold. Otherwise FALSE. <ul style="list-style-type: none"> Display of the current output frequency in 0x2DDD (P100.00). Setting Frequency threshold in 0x4005 (P412.00). ▶ Frequency threshold for "Frequency threshold exceeded" trigger □ 347
	71 Actual speed = 0	TRUE if current output frequency = 0 Hz (± 0.01 Hz), irrespective of the operating mode. Otherwise FALSE. <ul style="list-style-type: none"> Display of the current output frequency in 0x2DDD (P100.00).
	78 Current limit reached	TRUE if current motor current ≥ maximum current. Otherwise FALSE. <ul style="list-style-type: none"> Display of the present motor current in 0x2D88 (P104.00). Setting for the maximum current in 0x6073 (P324.00).
	79 Torque limit reached <ul style="list-style-type: none"> From version 02.00 	TRUE if torque limit has been reached or exceeded. Otherwise FALSE. <ul style="list-style-type: none"> Setting "Positive torque limit" in 0x60E0. Setting "Negative torque limit" in 0x60E1.
80 Follower signal (4 ... 20 mA) lost	Reserve (do not use trigger)	
81 Error of analog input 1 active	TRUE if the monitoring of the input signal at the analog input 1 has responded. Otherwise FALSE. <p>This trigger is set as a function of the following settings:</p> <ul style="list-style-type: none"> Monitoring threshold 0x2636:008 (P430.08) Monitoring condition 0x2636:009 (P430.09) <p>The setting of the Error response in 0x2636:010 (P430.10) has no effect on this trigger.</p> <p>▶ Analog input 1 □ 349</p>	

Configuring the network

General network settings



Parameter	Name / value range / [default setting]	Info
	82 Error of analog input 2 active	TRUE if the monitoring of the input signal at the analog input 2 has responded. Otherwise FALSE. This trigger is set as a function of the following settings: <ul style="list-style-type: none"> Monitoring threshold 0x2637:008 (P431.08) Monitoring condition 0x2637:009 (P431.09) The setting of the Error response in 0x2637:010 (P431.10) has no effect on this trigger. ▶ Analog input 2 □ 353
	83 Load loss detected	TRUE if actual motor current < threshold for load loss detection after delay time of the load loss detection has elapsed. Otherwise FALSE. <ul style="list-style-type: none"> Display of the present motor current in 0x6078 (P103.00). Setting Threshold in 0x4006:001 (P710.01). Setting Deceleration in 0x4006:002 (P710.02). ▶ Load loss detection □ 232
	104 Local control active	TRUE if local keypad control ("LOC") active. Otherwise FALSE.
	105 Remote control active	TRUE if remote control ("REM") via terminals, network, etc. active. Otherwise FALSE.
	106 Manual setpoint selection active	TRUE if manual setpoint selection ("MAN") via keypad active. Otherwise FALSE. <ul style="list-style-type: none"> Selection of the trigger for the "Activate keypad setpoint" function in 0x2631:016 (P400.16).
	107 Automatic setpoint selection active	TRUE if automatic setpoint selection ("AUTO") via terminals, network, etc. active. Otherwise FALSE.
	114 Network control active <ul style="list-style-type: none"> From version 02.00 	TRUE if network control activated. Otherwise FALSE.
0x2860:001 (P201.01)	Frequency control: Default setpoint source (Std. setpoints: Freq. setp. src.)	Selection of the standard setpoint source for operating mode "MS: Velocity mode". <ul style="list-style-type: none"> The selected standard setpoint source is always active in the operating mode 0x6060 (P301.00) = "MS: Velocity mode [-2]" when no setpoint change-over to another setpoint source via corresponding triggers/functions is active. ▶ Setpoint change-over □ 313
	1 Keypad	The setpoint is specified locally by the keypad. <ul style="list-style-type: none"> Default setting: 0x2601:001 (P202.01) Use the ↑ and ↓ navigation keys to change the keypad setpoint (also during running operation).
	2 Analog input 1	The setpoint is specified analogously via X3/AI1. ▶ Analog input 1 □ 349
	3 Analog input 2	The setpoint is specified analogously via X3/AI2. ▶ Analog input 2 □ 353
	5 Network	The setpoint is specified via network. ▶ Configuring the network □ 136
	11 Frequency preset 1	For the setpoint selection, preset values can be parameterised and selected. ▶ Setpoint source of preset setpoints □ 320
	12 Frequency preset 2	
	13 Frequency preset 3	
	14 Frequency preset 4	
	15 Frequency preset 5	
	16 Frequency preset 6	
	17 Frequency preset 7	
	18 Frequency preset 8	
	19 Frequency preset 9	
	20 Frequency preset 10	
	21 Frequency preset 11	
	22 Frequency preset 12	
	23 Frequency preset 13	
	24 Frequency preset 14	
	25 Frequency preset 15	
	50 Motor potentiometer	The setpoint is generated by the "Motor potentiometer" function. ▶ Motor potentiometer setpoint source (MOP) □ 325



Parameter	Name / value range / [default setting]	Info
0x2860:002 (P201.02)	PID control: Default setpoint source (Std. setpoints: PID setp. src.)	Selection of the standard setpoint source for the reference value of the PID control. <ul style="list-style-type: none"> The selected standard setpoint source is always active with an activated PID control when no setpoint change-over to another setpoint source via corresponding triggers/functions is active.
	1 Keypad	The setpoint is specified locally by the keypad. <ul style="list-style-type: none"> Default setting: 0x2601:002 (P202.02) Use the ↑ and ↓ navigation keys to change the keypad setpoint (also during running operation).
	2 Analog input 1	The setpoint is specified analogously via X3/AI1. ▶ Analog input 1 □ 349
	3 Analog input 2	The setpoint is specified analogously via X3/AI2. ▶ Analog input 2 □ 353
	5 Network	The setpoint is specified via network. Configuring the network □ 136
	11 PID preset 1	For the setpoint selection, preset values can be parameterised and selected. ▶ Setpoint source of preset setpoints □ 320
	12 PID preset 2	
	13 PID preset 3	
	14 PID preset 4	
	15 PID preset 5	
	16 PID preset 6	
	17 PID preset 7	
	18 PID preset 8	
	31 Segment preset 1 • From version 02.00	
	32 Segment preset 2 • From version 02.00	
	33 Segment preset 3 • From version 02.00	
	34 Segment preset 4 • From version 02.00	
	35 Segment preset 5 • From version 02.00	
	36 Segment preset 6 • From version 02.00	
	37 Segment preset 7 • From version 02.00	
38 Segment preset 8 • From version 02.00		
50 Motor potentiometer	The setpoint is generated by the "Motor potentiometer" function. ▶ Motor potentiometer setpoint source (MOP) □ 325	



8.2 Predefined process data words

Process data are exchanged via cyclic data exchange between the network master and the inverter.

Details

For the cyclic data exchange, the inverter is provided with 24 network registers.

- 12 network registers are provided as input registers for data words from the network master to the inverter.
- 12 network registers are provided as output registers for data words from the inverter to the network master.
- Each network register is provided with a corresponding code that defines which parameters (or other data codes) are mapped to the network register.
- The input and output registers are divided into three blocks (A, B, C) in each case, featuring 4 successive data words, respectively:

Network register	
Input register	Output register
Network IN A0	Network OUT A0
Network IN A1	Network OUT A1
Network IN A2	Network OUT A2
Network IN A3	Network OUT A3
Network IN B0	Network OUT B0
Network IN B1	Network OUT B1
Network IN B2	Network OUT B2
Network IN B3	Network OUT B3
Network IN C0	Network OUT C0
Network IN C1	Network OUT C1
Network IN C2	Network OUT C2
Network IN C3	Network OUT C3

The terms "input" and "output" refer to the point of view of the inverter:

- Input data are transmitted by the network master and received by the inverter.
- Output data are transmitted by the inverter and received by the network master.



The exact assignment of the network registers and the number of data words that can be transmitted cyclically varies according to the network/communication protocol. You can find some detailed information in the documentation for the respective communication protocol.

Data mapping

For establishing a simple network connection, the inverter provides predefined control and status words for device profile CiA 402, AC drive profile as well as in LECOM format. By means of data mapping to a network register, each of these words can be transferred as process data via network. Additionally, further mappable data words are provided to individually control the inverter. The mappable data words are described in detail in the following subchapters.



Data mapping cannot be applied to all parameters. The mappable parameters are marked correspondingly in the parameter attribute list.



8.2.1 Device profile CiA 402

For control via device profile CiA 402, the parameters listed in the following can be mapped to network register.

Details

- The mapping entry for the CiA 402 control word is 0x60400010.
- The mapping entry for the CiA 402 status word is 0x60410010.
- General information about the process of data mapping can be found in the chapter of the same name for the corresponding network.
- For further CiA 402 parameters, see chapter "[Device profile CiA 402](#)". [262](#)

Parameter	Name / value range / [default setting]	Info
0x6040	CiA: Controlword 0 ... [0] ... 65535	Mappable CiA 402 control word with bit assignment according to device profile CiA 402.
	Bit 0 Switch on	1 = switch-on
	Bit 1 Enable voltage	1 = DC bus: Establish readiness for operation
	Bit 2 Quick stop	0 = activate quick stop
	Bit 3 Enable operation	1 = enable operation
	Bit 4 Operation mode specific	Bits are not supported.
	Bit 5 Operation mode specific	
	Bit 6 Operation mode specific	
	Bit 7 Fault reset	0-1 edge = reset error
	Bit 8 Reserved	Bit is not supported.
	Bit 9 Operation mode specific	Operating mode dependent
	Bit 10 Reserved	
	Bit 11 Override coast	
	Bit 12 Autolnit	
	Bit 13 Reserved	
	Bit 14 Release holding brake	1 = releasing holding brake manually Notes: <ul style="list-style-type: none"> • The manually triggered "Release holding brake" command has a direct impact on the "Release holding brake [115]" trigger. Thus, the holding brake can be manually released if the power section is switched off. • The responsibility for a manual release of the holding brake has the external trigger source for the "Release holding brake" command. ▶ Holding brake control 266
Bit 15 Reserved		
0x6041 (P780.00)	CiA: Statusword (CiA: Statusword) • Read only	Mappable CiA 402 status word with bit assignment according to device profile CiA 402.
	Bit 0 Ready to switch on	1 ≡ drive ready to start
	Bit 1 Switched on	1 ≡ drive switched-on
	Bit 2 Operation enabled	1 ≡ operation enabled
	Bit 3 Fault	1 ≡ fault or trouble active
	Bit 4 Voltage enabled	1 ≡ DC bus ready for operation
	Bit 5 Quick stop	0 ≡ quick stop active
	Bit 6 Switch on disabled	1 ≡ operation inhibited
	Bit 7 Warning	1 ≡ warning active
	Bit 8 RPDOs deactivated	1 ≡ cyclic PDOs have been deactivated.
	Bit 9 Remote	1 ≡ inverter can receive commands via network.
	Bit 10 Target reached	1 ≡ the actual position is in the window.
	Bit 11 Internal limit active	1 ≡ internal limitation of a setpoint active.
	Bit 12 Operation mode active	1 ≡ operation enabled and no test mode activated. (no internal setpoint generation active.)
	Bit 13 Following error	1 ≡ following error active
	Bit 14 Holding brake released	1 ≡ holding brake released
Bit 15 Safe torque off (STO) not active	0 ≡ STO active 1 ≡ STO not active	

Configuring the network

Predefined process data words
AC Drive Profile



8.2.2 AC Drive Profile

For control via AC drive profile, the parameters listed in the following can be mapped to network registers.

Details

- The mapping entry for the AC Drive control word is 0x400B0110.
- The mapping entry for the AC Drive status word is 0x400C0110.
- General information about the process of data mapping can be found in the chapter of the same name for the corresponding network.

Parameter	Name / value range / [default setting]	Info
0x400B:001 (P592.01)	Process input data: AC Drive control word (Process data IN: AC control word) 0x0000 ... [0x0000] ... 0xFFFF	Mappable control word with bit assignment in compliance with EtherNet/IP™ AC drive profile.
	Bit 0 Run forward (CW)	
	Bit 1 Run reverse (CCW)	
	Bit 2 Reset error (0-1 edge)	
	Bit 3 Reserved	
	Bit 4 Reserved	
	Bit 5 Activate network control	
	Bit 6 Activate network setpoint	
	Bit 7 Reserved	
	Bit 8 Reserved	
	Bit 9 Reserved	
	Bit 10 Reserved	
	Bit 11 Reserved	
	Bit 12 Disable inverter	
	Bit 13 Activate quick stop	
	Bit 14 Deactivate PID controlling	
Bit 15 Activate DC braking		
0x400C:001 (P593.01)	Process output data: AC Drive status word (Process data OUT: AC status word) • Read only	Mappable status word with bit assignment in compliance with EtherNet/IP™ AC drive profile.
	Bit 0 Fault/Trip active	
	Bit 1 Reserved	
	Bit 2 Running forward	
	Bit 3 Running reverse	
	Bit 4 Ready	
	Bit 5 Network control active	
	Bit 6 Network setpoint active	
	Bit 7 At Reference	
	Bit 8 Reserved	
	Bit 9 Reserved	
	Bit 10 Reserved	
	Bit 11 Reserved	
	Bit 12 Process controller active	
	Bit 13 Torque mode active	
	Bit 14 Current limit reached	
Bit 15 DC braking active		
0x6402	Motor type • From version 02.00	AC motor type • Motor Data Object (0x28) - instance attribute 3
	3 PM synchronous	
	6 Wound rotor induction	
	7 Squirrel cage induction	



8.2.3 Lenze LECOM profile

For connection to Lenze inverters with a LECOM control word (C135) and LECOM status word (C150), the parameters listed in the following can be mapped to network registers.

Details

- The mapping entry for the LECOM control word is 0x400B0210.
- The mapping entry for the LECOM status word is 0x400C0210.
- General information about the process of data mapping can be found in the chapter of the same name for the corresponding network.

Parameter	Name / value range / [default setting]	Info
0x400B:002 (P592.02)	Process input data: LECOM control word (Process data IN: LECOM ctrl word) 0x0000 ... [0x0000] ... 0xFFFF	Mappable control word with bit assignment in compliance with code C135 of the 8200 Lenze inverter.
	Bit 0 Activate preset (bit 0)	
	Bit 1 Activate preset (bit 1)	
	Bit 2 Reversal rotation direction	
	Bit 3 Activate quick stop	
	Bit 4 Reserved	
	Bit 5 Reserved	
	Bit 6 Reserved	
	Bit 7 Reserved	
	Bit 8 Reserved	
	Bit 9 Disable inverter	
	Bit 10 Activate fault	
	Bit 11 Reset error (0-1 edge)	
	Bit 12 Reserved	
	Bit 13 Reserved	
Bit 14 Activate DC braking		
Bit 15 Reserved		
0x400C:002 (P593.02)	Process output data: LECOM status word (Process data OUT: LECOM stat. word) • Read only	Mappable status word with bit assignment in compliance with code C150 of the 8200 Lenze inverter.
	Bit 0 Active parameter set (0 = set 1 or 3; 1 = set 2 or 4)	
	Bit 1 Power section inhibited	
	Bit 2 Current or Torque limit reached	
	Bit 3 Frequency setpoint reached	
	Bit 4 Ramp generator (input = output)	
	Bit 5 Frequency < frequency threshold	
	Bit 6 Actual frequency = 0	
	Bit 7 Inverter disabled	
	Bit 8 Coded status bit 0	
	Bit 9 Coded status bit 1	
	Bit 10 Coded status bit 2	
	Bit 11 Coded status bit 3	
	Bit 12 Overtemperature warning	
	Bit 13 DC-bus overvoltage	
Bit 14 Rotational direction reversed		
Bit 15 Ready for Operation		

Configuring the network

Predefined process data words
Further process data



8.2.4 Further process data

The parameters listed in the following can also be mapped to network registers, in order to transmit control and status information as well as setpoints and actual values as process data.

Details

- The following parameters are always available irrespective of the network option.
- The use of these parameters for the transmission of process data is optional. It is also possible to only use part of the parameters. For the transmission of the frequency setpoint and actual value, for instance several parameters with a different resolution can be selected.
- Via the parameters, at the same time the general network activity can be diagnosed.

NetWordIN1 ... NetWordIN4

These four mappable data words are provided to individually control the inverter:

- NetWordIN1: for the implementation of an individual control word format. ▶ [General network settings](#) 137
- NetWordIN2: for control of the digital outputs via network. ▶ [Configuration of digital outputs](#) 355
- NetWordIN3 and NetWordIN4: for control of the analog outputs via network. ▶ [Configuration of analog outputs](#) 362

NetWordOUT1 and NetWordOUT2

These two mappable data words are provided to output status messages to the network master:

- NetWordOUT1: for the implementation of an individual status word format. ▶ [NetWordOUT1 status word](#) 359
- NetWordOUT2: for the output of messages of the "Sequencer" function (in preparation).

Parameter	Name / value range / [default setting]	Info	
0x4008:001 (P590.01)	Process input words: NetWordIN1 (NetWordINx: NetWordIN1) 0x0000 ... [0x0000] ... 0xFFFF	Mappable data word for flexible control of the inverter via network.	
	Bit 0	Mapping bit 0	Assignment of the function: 0x400E:001 (P505.01)
	Bit 1	Mapping bit 1	Assignment of the function: 0x400E:002 (P505.02)
	Bit 2	Mapping bit 2	Assignment of the function: 0x400E:003 (P505.03)
	Bit 3	Mapping bit 3	Assignment of the function: 0x400E:004 (P505.04)
	Bit 4	Mapping bit 4	Assignment of the function: 0x400E:005 (P505.05)
	Bit 5	Mapping bit 5	Assignment of the function: 0x400E:006 (P505.06)
	Bit 6	Mapping bit 6	Assignment of the function: 0x400E:007 (P505.07)
	Bit 7	Mapping bit 7	Assignment of the function: 0x400E:008 (P505.08)
	Bit 8	Mapping bit 8	Assignment of the function: 0x400E:009 (P505.09)
	Bit 9	Mapping bit 9	Assignment of the function: 0x400E:010 (P505.10)
	Bit 10	Mapping bit 10	Assignment of the function: 0x400E:011 (P505.11)
	Bit 11	Mapping bit 11	Assignment of the function: 0x400E:012 (P505.12)
	Bit 12	Mapping bit 12	Assignment of the function: 0x400E:013 (P505.13)
	Bit 13	Mapping bit 13	Assignment of the function: 0x400E:014 (P505.14)
	Bit 14	Mapping bit 14	Assignment of the function: 0x400E:015 (P505.15)
Bit 15	Mapping bit 15	Assignment of the function: 0x400E:016 (P505.16)	



Configuring the network

Predefined process data words
Further process data

Parameter	Name / value range / [default setting]	Info
0x4008:002 (P590.02)	Process input words: NetWordIN2 (NetWordINx: NetWordIN2) 0x0000 ... [0x0000] ... 0xFFFF	Mappable data word for optional control of the digital outputs via network. Assignment of the digital outputs: <ul style="list-style-type: none"> Relay: 0x2634:001 (P420.01) / selection [34] ... [49] Digital output 1: 0x2634:002 (P420.02) / selection [34] ... [49] Digital output 2: / selection [34] ... [49]
	Bit 0 Mapping bit 0	
	Bit 1 Mapping bit 1	
	Bit 2 Mapping bit 2	
	Bit 3 Mapping bit 3	
	Bit 4 Mapping bit 4	
	Bit 5 Mapping bit 5	
	Bit 6 Mapping bit 6	
	Bit 7 Mapping bit 7	
	Bit 8 Mapping bit 8	
	Bit 9 Mapping bit 9	
	Bit 10 Mapping bit 10	
	Bit 11 Mapping bit 11	
	Bit 12 Mapping bit 12	
	Bit 13 Mapping bit 13	
	Bit 14 Mapping bit 14	
Bit 15 Mapping bit 15		
0x4008:003 (P590.03)	Process input words: NetWordIN3 (NetWordINx: NetWordIN3) 0.0 ... [0.0] ... 100.0 %	Mappable data word for optional control of an analog output via network. Assignment of the analog outputs: <ul style="list-style-type: none"> Analog output 1: 0x2639:002 (P440.02) = "NetWordIN3 [20]" Analog output 2: = "NetWordIN3 [20]"
0x4008:004 (P590.04)	Process input words: NetWordIN4 (NetWordINx: NetWordIN4) 0.0 ... [0.0] ... 100.0 %	Mappable data word for optional control of an analog output via network. Assignment of the analog outputs: <ul style="list-style-type: none"> Analog output 1: 0x2639:002 (P440.02) = "NetWordIN4 [21]" Analog output 2: = "NetWordIN4 [21]"

Configuring the network

Predefined process data words
Further process data



Parameter	Name / value range / [default setting]	Info
0x400A:001 (P591.01)	Process output words: NetWordOUT1 (NetWordOUTx: NetWordOUT1) • Read only	Mappable data word for the output of status messages of the inverter via network.
Bit 0	Mapping bit 0	Mappable data word for the output of status messages of the inverter via network. Assignment of the status message: 0x2634:010 (P420.10)
Bit 1	Mapping bit 1	Mappable data word for the output of status messages of the inverter via network. Assignment of the status message: 0x2634:011 (P420.11)
Bit 2	Mapping bit 2	Mappable data word for the output of status messages of the inverter via network. Assignment of the status message: 0x2634:012 (P420.12)
Bit 3	Mapping bit 3	Mappable data word for the output of status messages of the inverter via network. Assignment of the status message: 0x2634:013 (P420.13)
Bit 4	Mapping bit 4	Mappable data word for the output of status messages of the inverter via network. Assignment of the status message: 0x2634:014 (P420.14)
Bit 5	Mapping bit 5	Mappable data word for the output of status messages of the inverter via network. Assignment of the status message: 0x2634:015 (P420.15)
Bit 6	Mapping bit 6	Mappable data word for the output of status messages of the inverter via network. Assignment of the status message: 0x2634:016 (P420.16)
Bit 7	Mapping bit 7	Mappable data word for the output of status messages of the inverter via network. Assignment of the status message: 0x2634:017 (P420.17)
Bit 8	Mapping bit 8	Mappable data word for the output of status messages of the inverter via network. Assignment of the status message: 0x2634:018 (P420.18)
Bit 9	Mapping bit 9	Mappable data word for the output of status messages of the inverter via network. Assignment of the status message: 0x2634:019 (P420.19)
Bit 10	Mapping bit 10	Mappable data word for the output of status messages of the inverter via network. Assignment of the status message: 0x2634:020 (P420.20)
Bit 11	Mapping bit 11	Mappable data word for the output of status messages of the inverter via network. Assignment of the status message: 0x2634:021 (P420.21)
Bit 12	Mapping bit 12	Mappable data word for the output of status messages of the inverter via network. Assignment of the status message: 0x2634:022 (P420.22)
Bit 13	Mapping bit 13	Mappable data word for the output of status messages of the inverter via network. Assignment of the status message: 0x2634:023 (P420.23)
Bit 14	Mapping bit 14	Mappable data word for the output of status messages of the inverter via network. Assignment of the status message: 0x2634:024 (P420.24)
Bit 15	Mapping bit 15	Mappable data word for the output of status messages of the inverter via network. Assignment of the status message: 0x2634:025 (P420.25)



Configuring the network

Predefined process data words

Further process data

Parameter	Name / value range / [default setting]	Info
0x400A:002 (P591.02)	Process output words: NetWordOUT2 (NetWordOUTx: NetWordOUT2)	Mappable data word for the output of messages of the "Sequencer" function via network.
	• Read only	
	Bit 0 Mapping bit 0	
	Bit 1 Mapping bit 1	
	Bit 2 Mapping bit 2	
	Bit 3 Mapping bit 3	
	Bit 4 Mapping bit 4	
	Bit 5 Mapping bit 5	
	Bit 6 Mapping bit 6	
	Bit 7 Mapping bit 7	
	Bit 8 Mapping bit 8	
	Bit 9 Mapping bit 9	
	Bit 10 Mapping bit 10	
	Bit 11 Mapping bit 11	
	Bit 12 Mapping bit 12	
	Bit 13 Mapping bit 13	
Bit 14 Mapping bit 14		
Bit 15 Mapping bit 15		
0x400B:003 (P592.03)	Process input data: Network setpoint frequency (Process data IN: Net.freq. 0.1Hz) 0.0 ... [0.0] ... 599.0 Hz	Mappable parameter for specifying the frequency setpoint in [0.1 Hz] via network. <ul style="list-style-type: none"> The specification is made without sign (irrespective of the rotating direction). The rotating direction is specified via the control word. Example: 456 ≙ 45.6 Hz
0x400B:004 (P592.04)	Process input data: Network setpoint speed (Process data IN: Net.setp. speed) 0 ... [0] ... 50000 rpm	Mappable parameter for specifying the setpoint as speed in [rpm] via network. <ul style="list-style-type: none"> The specification is made without sign (irrespective of the rotating direction). The rotating direction is specified via the control word. Example: 456 ≙ 456 rpm
0x400B:005 (P592.05)	Process input data: Network setpoint frequency (Process data IN: Net.freq.0.01Hz) 0.00 ... [0.00] ... 599.00 Hz	Mappable parameter for specifying the frequency setpoint in [0.01 Hz] via network. <ul style="list-style-type: none"> The specification is made without sign (irrespective of the rotating direction). The rotating direction is specified via the control word. Example: 456 ≙ 4.56 Hz
0x400B:009 (P592.09)	Process input data: Torque scaling (Process data IN: Torque scaling) -128 ... [0] ... 127 <ul style="list-style-type: none"> From version 02.00 	Scaling factor for torque setpoint and actual torque value 0x400C:007 (P593.07) via network. <ul style="list-style-type: none"> With the setting 0, no scaling takes place.
0x400C:003 (P593.03)	Process output data: Frequency [0.1 Hz] (Process data OUT: Frequency 0.1Hz) <ul style="list-style-type: none"> Read only: x.x Hz 	Mappable parameter for the output of the actual frequency value in [0.1 Hz] via network. <ul style="list-style-type: none"> The output is effected without sign (irrespective of the rotating direction). The rotating direction is specified via the status word. Example: 456 ≙ 45.6 Hz
0x400C:004 (P593.04)	Process output data: Motor speed (Process data OUT: Motor speed) <ul style="list-style-type: none"> Read only: x rpm 	Mappable parameter for the output of the actual value as speed in [rpm] via network. <ul style="list-style-type: none"> The output is effected without sign (irrespective of the rotating direction). The rotating direction is specified via the status word. Example: 456 ≙ 456 rpm

Configuring the network

Predefined process data words



Parameter	Name / value range / [default setting]	Info
0x400C:005 (P593.05)	Process output data: Drive status (Process data OUT: Drive status) • Read only	Mappable status word (Modbus Legacy Register 2003).
	0 Error (non-resettable) active	
	1 Error active	
	2 Waiting for start	
	3 Identification not executed	
	4 Inverter disabled	
	5 Stop active	
	7 Identification active	
	8 Running	
	9 Acceleration active	
	10 Deceleration active	
	11 Deceleration override active	
	12 DC braking active	
	13 Flying start active	
14 Current limit reached		
16 Process controller idle state		
0x400C:006 (P593.06)	Process output data: Frequency [0.01 Hz] (Process data OUT: Frequency 0.01Hz) • Read only: x.xx Hz	Mappable parameter for the output of the actual frequency value in [0.01 Hz] via network. • The output is effected without sign (irrespective of the rotating direction). • The rotating direction is specified via the status word. • Example: 456 ≙ 4.56 Hz
0x400C:007 (P593.07)	Process output data: Torque scaled (Process data OUT: Torque scaled) • Read only • From version 02.00	Mappable parameter for the output of the actual torque value in [Nm / 2 ^{scaling factor}] via network. • The scaling factor can be set in 0x400B:009 (P592.09) . • Actual torque value = scaled actual torque value (0x400C:007) / 2 ^{scaling factor} Example: • Scaled actual torque value (0x400C:007) = 345 [Nm] • Scaling factor (0x400B:009) = 3 • Actual torque value = 345 [Nm] / 2 ³ = 43.125 [Nm]

8.3 Acyclic data exchange

The acyclic data exchange is normally used for transmitting parameter data the transmission of which is not time-critical. Such parameter data are for example operating parameters, motor data, and diagnostic information.

Details

- The acyclic data exchange enables access to all parameters of the inverter.
- For all communication protocols except Modbus, the parameter is addressed directly via the index and subindex.
- The parameter attribute list contains a list of all inverter parameters. This list in particular includes some information that is relevant to the reading and writing of parameters via the network.



8.4 CANopen



CANopen® is an internationally approved communication protocol which is designed for commercial and industrial automation applications. High data transfer rates in connection with efficient data formatting provide for the coordination of motion control devices in multi-axis applications.

- Detailed information on CANopen can be found on the web page of the CAN in Automation (CiA) user organisation: <http://www.can-cia.org>
- Information about the dimensioning of a CANopen network can be found in the configuration document for the inverter.
- CANopen® is a registered community trademark of the CAN in Automation e. V user organisation.



Information about the dimensioning of a CANopen network can be found in the configuration document for the inverter.

CANopen® is a registered community trademark of the CAN user organisation CiA® (CAN in Automation e. V.).

Preconditions

- Control unit (CU) of the inverter is provided with Modbus/CANopen.
- Modbus/CANopen selector at the inverter front is set to "CANopen".

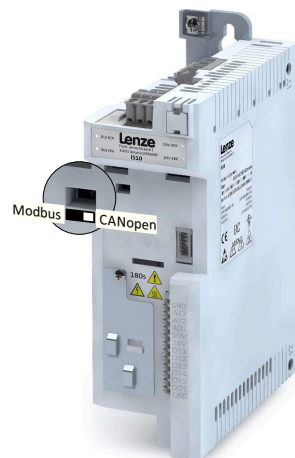

- The EDS device description files for CANopen can be found here:
<http://www.lenze.com/application-knowledge-base/artikel/200413930/0/>

8.4.1 CANopen introduction

- The implementation of the CANopen communication profile (CiA DS301, version 4.02) enables baud rates of 20 kbps to 1 Mbps.
- For establishing a simple network connection, the inverter provides predefined control and status words for device profile CiA 402, AC-drive profile and in LECOMformat. Additionally, further mappable data words are provided to individually control the inverter.
- The inverter control is preconfigured via a CiA 402-compliant control word.

Configuring the network

CANopen
CANopen node address



8.4.2 CANopen node address

Each network node must be provided with a unique node address.

Details

- The node address can be set in [0x2301:001 \(P510.01\)](#).
- The setting that is active when the inverter is switched on is the effective setting.
- The active node address is shown in [0x2302:001 \(P511.01\)](#).

Parameter	Name / value range / [default setting]	Info
0x2301:001 (P510.01)	CANopen settings: Node ID (CANopen sett.: Node ID) 1 ... [1] ... 127	Setting of the node address. <ul style="list-style-type: none">• A change in the node address will not be effective until a CAN Reset Node is performed.
0x2302:001 (P511.01)	Active CANopen settings: Active node ID (CANopen diag.: Active node ID) <ul style="list-style-type: none">• Read only	Display of the active node address.
0x2303 (P509.00)	CANopen switch position (CANopen switch) <ul style="list-style-type: none">• Read only	Display of the DIP switch setting at the last mains power-on.

8.4.3 CANopen baud rate

All network nodes must be set to the same baud rate.

Details

- The baud rate can be set in [0x2301:002 \(P510.02\)](#).
- The setting that is active when the inverter is switched on is the effective setting.
- The active baud rate is displayed in [0x2302:002 \(P511.02\)](#).

Parameter	Name / value range / [default setting]	Info
0x2301:002 (P510.02)	CANopen settings: Baud rate (CANopen sett.: Baud rate)	Setting of the baud rate. <ul style="list-style-type: none">• A change in the baud rate will not be effective until a CAN reset node is performed.
	1 20 kbps	
	2 50 kbps	
	3 125 kbps	
	4 250 kbps	
	5 500 kbps	
	6 800 kbps	
	7 1 Mbps	
0x2302:002 (P511.02)	Active CANopen settings: Active baud rate (CANopen diag.: Active baud rate) <ul style="list-style-type: none">• Read only	Display of the active baud rate.
	1 20 kbps	
	2 50 kbps	
	3 125 kbps	
	4 250 kbps	
	5 500 kbps	
	6 800 kbps	
	7 1 Mbps	



8.4.4 CANopen initialisation

If the initialisation of the CANopen network and the associated status change from "Pre-Operational" to "Operational" is not effected by a higher-level host system, the inverter can instead be defined as a "mini" master to execute this task.

Details

The inverter is configured as mini master in [0x2301:003 \(P510.03\)](#).

- In the default setting, the inverter is configured as slave and waits for the NMT telegram "Start Remote Node" from the master/host system after being switched on.
- Configured as mini master, the inverter changes to the "Operational" state after being switched on and sets all nodes connected to the CAN bus (broadcast telegram) to the "Operational" communication state using the "Start Remote Node" NMT telegram after the deceleration time set in [0x2301:004 \(P510.04\)](#) has elapsed. Only this communication status enables data exchange via the process data objects.



The change of the master/slave operation only becomes effective by renewed mains switching of the inverter or by sending the NMT telegram "Reset Node" or "Reset Communication" to the inverter. Alternatively, the CAN communication can be restarted via [0x2300 \(P508.00\)](#). [▶ Resetting the CANopen interface](#)
[180](#)

Parameter	Name / value range / [default setting]	Info
0x2301:003 (P510.03)	CANopen settings: Slave/Master (CANopen sett.: Slave/Master)	1 = after mains switching, inverter starts as mini-master.
	0 Slave	
	1 Mini-master	
0x2301:004 (P510.04)	CANopen settings: Start remote delay (CANopen sett.: Start rem. delay) 0 ... [3000] ... 65535 ms	If the inverter has been defined as mini-master, a delay time can be set here, which has to elapse after mains switching before the inverter deposits the "Start Remote Node" NMT telegram on the CAN bus.

Configuring the network

CANopen

CANopen diagnostics



8.4.5 CANopen diagnostics

For the purpose of diagnostics, the inverter provides several status words via which the CAN bus status, the CAN bus controller status, and the status of different time monitoring functions can be queried.



Configuring the network

CANopen
CANopen diagnostics

Parameter	Name / value range / [default setting]	Info
0x2307 (P515.00)	CANopen time-out status (Time-out status) • Read only	Bit-coded status display of the CAN time monitoring functions.
	Bit 0 RPDO1-Timeout	1 ≡ RPDO1 was not received within the monitoring time or not with the sync configured. • Status is reset automatically after the RPDO has been received again. • Setting of monitoring time for RPDO1 in 0x1400:005 (P540.05) .
	Bit 1 RPDO2-Timeout	1 ≡ RPDO2 was not received within the monitoring time or not with the sync configured. • Status is reset automatically after the RPDO has been received again. • Setting of monitoring time for RPDO2 in 0x1401:005 (P541.05) .
	Bit 2 RPDO3-Timeout	1 ≡ RPDO3 was not received within the monitoring time or not with the sync configured. • Status is reset automatically after the RPDO has been received again. • Setting of monitoring time for RPDO3 in 0x1402:005 (P542.05) .
	Bit 3 Reserved	-
	Bit 4 Reserved	-
	Bit 5 Reserved	-
	Bit 6 Reserved	-
	Bit 7 Reserved	-
	Bit 8 Heartbeat-Timeout Consumer 1	1 ≡ within the "Heartbeat Consumer Time", no heartbeat telegram was received from node 1 to be monitored. • Status can only be reset by mains switching or error reset. • "Heartbeat Consumer Time" setting in 0x1016:001 (P520.01) .
	Bit 9 Heartbeat-Timeout Consumer 2	1 ≡ within the "Heartbeat Consumer Time", no heartbeat telegram was received from node 2 to be monitored. • Status can only be reset by mains switching or error reset. • "Heartbeat Consumer Time" setting in 0x1016:002 (P520.02) .
	Bit 10 Heartbeat-Timeout Consumer 3	1 ≡ within the "Heartbeat Consumer Time", no heartbeat telegram was received from node 3 to be monitored. • Status can only be reset by mains switching or error reset. • "Heartbeat Consumer Time" setting in 0x1016:003 (P520.03) .
	Bit 11 Heartbeat-Timeout Consumer 4	1 ≡ within the "Heartbeat Consumer Time", no heartbeat telegram was received from node 4 to be monitored. • Status can only be reset by mains switching or error reset. • "Heartbeat Consumer Time" setting in 0x1016:004 (P520.04) .
	Bit 12 Reserved	-
	Bit 13 Reserved	-
	Bit 14 Reserved	-
	Bit 15 Reserved	-
	Bit 16 Reserved	-
	Bit 17 Reserved	-
	Bit 18 Reserved	-
	Bit 19 Reserved	-
	Bit 20 Reserved	-
	Bit 21 Reserved	-
	Bit 22 Reserved	-
	Bit 23 Reserved	-
	Bit 24 Reserved	-
	Bit 25 Reserved	-
	Bit 26 Reserved	-
	Bit 27 Reserved	-
	Bit 28 Reserved	-
	Bit 29 Reserved	-
	Bit 30 Reserved	-
Bit 31 Reserved	-	

Configuring the network

CANopen

CANopen emergency telegram



Parameter	Name / value range / [default setting]	Info
0x2308 (P516.00)	CANopen status (CANopen status) • Read only	Display of the current CAN bus state.
	0 Initialisation	CAN bus initialisation active. • The initialisation is started automatically at mains connection. During this phase, the inverter is not involved in the data exchange process on the CAN bus. • All CAN-relevant parameters are initialised with the saved settings. • When the initialisation process has been completed, the inverter automatically adopts the "Pre-Operational" state.
	1 Reset node	"Reset Node" NMT command active. • All parameters are initialised with the saved settings (not only the CAN-relevant parameters).
	2 Reset communication	"Reset Communication" NMT command active. • Initialisation of all CAN-relevant parameters with the values stored.
	4 Stopped	Only network management telegrams can be received.
	5 Operational	Parameter data and process data can be received. If defined, process data is sent as well.
	127 Pre-Operational	Parameter data can be received, process data are ignored.
0x2309 (P517.00)	CANopen controller status (CAN contr.status) • Read only	Status display of the internal CANopen controller.
	1 Error active	The inverter is a fully-fledged communication node at the CANopen network. It is able to transmit and receive data and to report faults.
	2 Error passive	The inverter can only passively indicate faulty reception via the ACK field.
	3 Bus off	The inverter is electrically separated from the CANopen network. In order to exit this state, the CANopen interface must be reset. An automatic restart is implemented.

8.4.6 CANopen emergency telegram

If the error status changes when an internal device error occurs or is remedied, an emergency telegram is sent to the NMT master once.

Details

- The identifier for the emergency telegram is fixedly defined and is shown in [0x1014](#).
- In [0x1015](#), a blocking time can be set, in order to limit the bus load in the case of emergency telegrams following quickly in succession.

Parameter	Name / value range / [default setting]	Info
0x1014	COB-ID EMCY • Read only	Display of the identifier for emergency telegrams.
0x1015	Inhibit time EMCY 0.0 ... [0.0] ... 6553.5 ms	Blocking time which can be set in order to limit the bus load in the case of emergency telegrams following quickly in succession.



8.4.7 CANopen heartbeat protocol

The heartbeat protocol can be used for node monitoring purposes within a CAN network.

Details

Basic procedure:

1. A heartbeat producer cyclically sends a heartbeat telegram to one or several receivers (consumers).
2. The consumer(s) monitor(s) the heartbeat telegram for arrival on a regular basis.

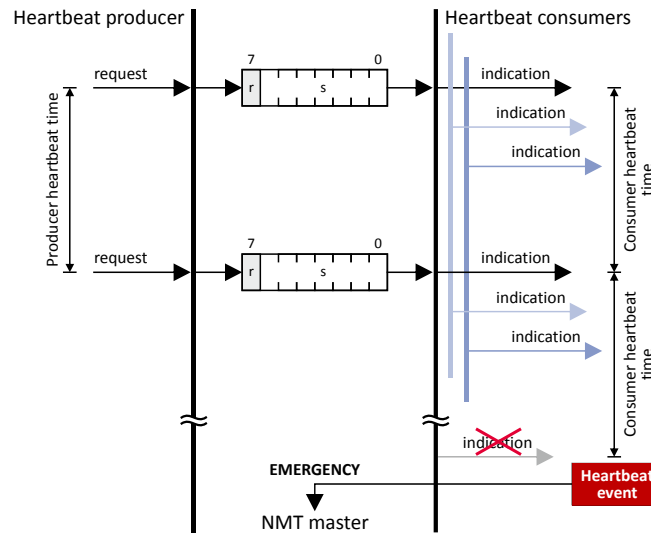

The inverter can be configured as producer or as consumer to monitor up to four other nodes.

Parameter	Name / value range / [default setting]	Info
0x1016:000 (P520.00)	Consumer heartbeat time: Highest sub-index supported (Cons. heartbeat: Highest subindex) • Read only	Highest subindex, permanently set to 4. Corresponds at the same time to the maximum possible number of nodes to be monitored.
0x1016:001 (P520.01)	Consumer heartbeat time: Consumer heartbeat time 1 (Cons. heartbeat: Cons. heartbeat1) 0x00000000 ... [0x00000000] ... 0x00FFFFFF	Node ID and heartbeat time of node 1 which is to be monitored. • Format: 0x00nnhhhh (nn = node ID, hhhh = heartbeat time in [ms])
0x1016:002 (P520.02)	Consumer heartbeat time: Consumer heartbeat time 2 (Cons. heartbeat: Cons. heartbeat2) 0x00000000 ... [0x00000000] ... 0x00FFFFFF	Node ID and heartbeat time of node 2 which is to be monitored. • Format: 0x00nnhhhh (nn = node ID, hhhh = heartbeat time in [ms])
0x1016:003 (P520.03)	Consumer heartbeat time: Consumer heartbeat time 3 (Cons. heartbeat: Cons. heartbeat3) 0x00000000 ... [0x00000000] ... 0x00FFFFFF	Node ID and heartbeat time of node 3 which is to be monitored. • Format: 0x00nnhhhh (nn = node ID, hhhh = heartbeat time in [ms])
0x1016:004 (P520.04)	Consumer heartbeat time: Consumer heartbeat time 4 (Cons. heartbeat: Cons. heartbeat4) 0x00000000 ... [0x00000000] ... 0x00FFFFFF	Node ID and heartbeat time of node 4 which is to be monitored. • Format: 0x00nnhhhh (nn = node ID, hhhh = heartbeat time in [ms])
0x1017 (P522.00)	Producer heartbeat time (Prod. heartbeat) 0 ... [0] ... 65535 ms	Time interval for the transmission of the heartbeat telegram to the consumer(s). • The heartbeat telegram is sent automatically as soon as a time > 0 ms is set. • The set time is internally rounded up to the next multiple of 10 ms.

Configuring the network

CANopen
CANopen process data objects



8.4.8 CANopen process data objects

Process data objects (PDOs) are used for the cyclic transmission of (process) data via CANopen. PDOs only contain data and an identifier. They do not contain any information about the sender or receiver and are therefore very efficient.

Details

- Process data objects which the inverter receives via the network are referred to as "Receive PDOs" (RPDOs).
- Process data objects which the inverter sends via the network are referred to as "Transmit PDOs" (TPDOs).
- The maximum length of a PDO is 8 bytes (4 data words).
- Each PDO requires a unique identifier ("COB-ID") for the purpose of identification within the network.
- Communication parameters such as the transmission type and cycle time for each PDO can be set freely and independently of the settings of other PDOs

Transmission type

Process data objects can be transmitted in an event-controlled or time-controlled manner. The below table shows that it is possible to combine the different methods by means of logic operations (AND, OR):

- Event-controlled: The PDO is sent if a special device-internal event has occurred, for instance, if the data contents of the TPDO have changed or if a transmission cycle time has elapsed.
- Synchronous transmission: Transmission of a TPDOs or reception of an RPDO is effected after the inverter has received a sync telegram (COB-ID 0x80).
- Cyclic transmission: The cyclic transmission of PDOs is effected when the transmission cycle time has elapsed.
- Polled via RTR: Transmission of a TPDO is carried out on request by another device via data request frame (RTR remote transmit request). For this, the data requester (e.g. master) sends the data request frame with the COB-ID of the TPDO that is to be requested to transmit. The receiver recognises the RTR and carries out the transmission.

Transmission type	PDO transmission			Logic combination of different transmission types
	cyclic	synchronous	event-controlled	
0		●	●	AND
1 ... 240		●		-
254, 255	●		●	OR

Transmission type	Description
0	Synchronous and acyclic <ul style="list-style-type: none"> • The PDO is transmitted on an event-controlled basis with every sync (e.g. when a bit change occurs in the PDO).
1 ... 240	Synchronous and cyclic (sync-controlled with a response) <ul style="list-style-type: none"> • Selection n = 1: The PDO is transmitted with every sync. • Selection 1 < n ≤ 240: The PDO is transmitted with every n-th sync.
241 ... 251	Reserved
252	Synchronous - RTR only
253	Asynchronous - RTR only
254, 255	Asynchronous - manufacturer-specific / device profile-specific <ul style="list-style-type: none"> • If one of these values is entered, the PDO is transferred in an event-controlled or cyclic manner. (The values "254" and "255" are equivalent). • For a cyclic transmission, a cycle time must be entered for the respective PDO. In this case, cyclic transmission takes place in addition to event-controlled transmission.



Synchronisation of PDOs via sync telegram

During cyclic transmission, one or more PDOs are transmitted/received in fixed time intervals. An additional specific telegram, the so-called sync telegram, is used for synchronising cyclic process data.

- The sync telegram is the trigger point for the transmission of process data from the slaves to the master and for the acceptance of process data from the master in the slaves.
- For sync-controlled process data processing, the sync telegram must be generated accordingly.
- The response to a sync telegram is determined by the transmission type selected.

Generating the sync telegram:

- **0x1005** can be used to activate the generation of sync telegrams and to write the identifier value.
- Sync telegrams are created when bit 30 (see below) is set to "1".
- The interval between sync telegrams is to be set in **0x1006**.

Writing identifiers:

- To receive sync telegrams, the value 0x80 must be entered in the 11-bit identifier in the default setting (and in compliance with the CANopen specification). This means that all inverters are set to the same sync telegram by default.
- If sync telegrams are only to be received by specific nodes, their identifiers can be entered with a value of up to and including 0x07FF.
- The identifier can only be changed if the inverter does not send any sync telegrams (**0x1005**, Bit 30 = "0").

Data telegram assignment

8th byte (data 4)		7th byte (data 3)	6th byte (data 2)	5th byte (data 1)
Bit 31	Bit 30	Bit 29 ... bit 11		Bit 10 ... bit 0
x	0/1	Extended identifier*		11-bit identifier

* The extended identifier is not supported. Bit 11 ... bit 29 must be set to "0".

Parameter	Name / value range / [default setting]	Info
0x1005	COB-ID SYNC 0x00000000 ... [0x00000080] ... 0xFFFFFFFF	Identifier for sync telegram. How to change the identifier: 1. Deactivate Sync: Set bit 30 to "0". 2. Change identifier. 3. Activate Sync: Set bit 30 to "1".
0x1006	Communication cyclic period 0 ... [0] ... 65535000 us	Cycle time for sync telegrams. <ul style="list-style-type: none"> • With the setting "0", no sync telegrams are generated. • The set time is internally rounded up to the next multiple of 10 ms. The shortest possible cycle time thus is 10 ms.
0x1400:000	RPDO1 communication parameter: Highest sub-index supported <ul style="list-style-type: none"> • Read only 	

Configuring the network

CANopen

CANopen process data objects



Parameter	Name / value range / [default setting]	Info
0x1400:001 (P540.01)	RPDO1 communication parameter: COB-ID (RPDO1 config.: COB-ID) 0x00000000 ... [0x00000200] ... 0xFFFFFFFF	RPDO1: identifier How to change the identifier: 1. Set PDO to "invalid": Set bit 31 to "1". 2. Change identifier and reset PDO to "valid" (bit 31 = "0").
	Bit 0 COB-ID bit 0	
	Bit 1 COB-ID bit 1	
	Bit 2 COB-ID bit 2	
	Bit 3 COB-ID bit 3	
	Bit 4 COB-ID bit 4	
	Bit 5 COB-ID bit 5	
	Bit 6 COB-ID bit 6	
	Bit 7 COB-ID bit 7	
	Bit 8 COB-ID bit 8	
	Bit 9 COB-ID bit 9	
	Bit 10 COB-ID bit 10	
	Bit 11 Reserved	
	Bit 12 Reserved	
	Bit 13 Reserved	
	Bit 14 Reserved	
	Bit 15 Reserved	
	Bit 16 Reserved	
	Bit 17 Reserved	
	Bit 18 Reserved	
	Bit 19 Reserved	
	Bit 20 Reserved	
	Bit 21 Reserved	
	Bit 22 Reserved	
	Bit 23 Reserved	
	Bit 24 Reserved	
	Bit 25 Reserved	
	Bit 26 Reserved	
	Bit 27 Reserved	
	Bit 28 Reserved	
	Bit 29 Reserved	
	Bit 30 Reserved	
Bit 31 PDO invalid		
0x1400:002 (P540.02)	RPDO1 communication parameter: Transmission type (RPDO1 config.: Transm. type) 0 ... [255] ... 255	RPDO1: transmission type in compliance with DS301 V4.02
0x1400:005 (P540.05)	RPDO1 communication parameter: Event timer (RPDO1 config.: Event timer) 0 ... [100] ... 65535 ms	RPDO1: time-out for the monitoring of data reception.



Configuring the network

CANopen
CANopen process data objects

Parameter	Name / value range / [default setting]	Info
0x1401:001 (P541.01)	RPDO2 communication parameter: COB-ID (RPDO2 config.: COB-ID) 0x00000000 ... [0x80000300] ... 0xFFFFFFFF	RPDO2: identifier How to change the identifier: 1. Set PDO to "invalid": Set bit 31 to "1". 2. Change identifier and reset PDO to "valid" (bit 31 = "0").
	Bit 0 COB-ID bit 0	
	Bit 1 COB-ID bit 1	
	Bit 2 COB-ID bit 2	
	Bit 3 COB-ID bit 3	
	Bit 4 COB-ID bit 4	
	Bit 5 COB-ID bit 5	
	Bit 6 COB-ID bit 6	
	Bit 7 COB-ID bit 7	
	Bit 8 COB-ID bit 8	
	Bit 9 COB-ID bit 9	
	Bit 10 COB-ID bit 10	
	Bit 11 Reserved	
	Bit 12 Reserved	
	Bit 13 Reserved	
	Bit 14 Reserved	
	Bit 15 Reserved	
	Bit 16 Reserved	
	Bit 17 Reserved	
	Bit 18 Reserved	
	Bit 19 Reserved	
	Bit 20 Reserved	
	Bit 21 Reserved	
	Bit 22 Reserved	
	Bit 23 Reserved	
	Bit 24 Reserved	
	Bit 25 Reserved	
	Bit 26 Reserved	
	Bit 27 Reserved	
	Bit 28 Reserved	
	Bit 29 Reserved	
	Bit 30 Reserved	
	Bit 31 PDO invalid	
0x1401:002 (P541.02)	RPDO2 communication parameter: Transmission type (RPDO2 config.: Transm. type) 0 ... [255] ... 255	RPDO2: transmission type in compliance with DS301 V4.02
0x1401:005 (P541.05)	RPDO2 communication parameter: Event timer (RPDO2 config.: Event timer) 0 ... [100] ... 65535 ms	RPDO2: time-out for the monitoring of data reception.

Configuring the network

CANopen

CANopen process data objects



Parameter	Name / value range / [default setting]	Info
0x1402:001 (P542.01)	RPDO3 communication parameter: COB-ID (RPDO3 config.: COB-ID) 0x00000000 ... [0x80000400] ... 0xFFFFFFFF	RPDO3: identifier How to change the identifier: 1. Set PDO to "invalid": Set bit 31 to "1". 2. Change identifier and reset PDO to "valid" (bit 31 = "0").
	Bit 0 COB-ID bit 0	
	Bit 1 COB-ID bit 1	
	Bit 2 COB-ID bit 2	
	Bit 3 COB-ID bit 3	
	Bit 4 COB-ID bit 4	
	Bit 5 COB-ID bit 5	
	Bit 6 COB-ID bit 6	
	Bit 7 COB-ID bit 7	
	Bit 8 COB-ID bit 8	
	Bit 9 COB-ID bit 9	
	Bit 10 COB-ID bit 10	
	Bit 11 Reserved	
	Bit 12 Reserved	
	Bit 13 Reserved	
	Bit 14 Reserved	
	Bit 15 Reserved	
	Bit 16 Reserved	
	Bit 17 Reserved	
	Bit 18 Reserved	
	Bit 19 Reserved	
	Bit 20 Reserved	
	Bit 21 Reserved	
	Bit 22 Reserved	
	Bit 23 Reserved	
	Bit 24 Reserved	
	Bit 25 Reserved	
	Bit 26 Reserved	
	Bit 27 Reserved	
	Bit 28 Reserved	
	Bit 29 Reserved	
	Bit 30 Reserved	
Bit 31 PDO invalid		
0x1402:002 (P542.02)	RPDO3 communication parameter: Transmission type (RPDO3 config.: Transm. type) 0 ... [255] ... 255	RPDO3: transmission type in compliance with DS301 V4.02
0x1402:005 (P542.05)	RPDO3 communication parameter: Event timer (RPDO3 config.: Event timer) 0 ... [100] ... 65535 ms	RPDO3: time-out for the monitoring of data reception.
0x1800:000	TPDO1 communication parameter: Highest sub-index supported • Read only	The value "5" is permanently set.



Configuring the network

CANopen
CANopen process data objects

Parameter	Name / value range / [default setting]	Info
0x1800:001 (P550.01)	TPDO1 communication parameter: COB-ID (TPDO1 config.: COB-ID) 0x00000001 ... [0x40000180] ... 0xFFFFFFFF	TPDO1: identifier How to change the identifier: 1. Set PDO to "invalid": Set bit 31 to "1". 2. Change identifier and reset PDO to "valid" (bit 31 = "0").
	Bit 0 COB-ID bit 0	
	Bit 1 COB-ID bit 1	
	Bit 2 COB-ID bit 2	
	Bit 3 COB-ID bit 3	
	Bit 4 COB-ID bit 4	
	Bit 5 COB-ID bit 5	
	Bit 6 COB-ID bit 6	
	Bit 7 COB-ID bit 7	
	Bit 8 COB-ID bit 8	
	Bit 9 COB-ID bit 9	
	Bit 10 COB-ID bit 10	
	Bit 11 Reserved	
	Bit 12 Reserved	
	Bit 13 Reserved	
	Bit 14 Reserved	
	Bit 15 Reserved	
	Bit 16 Reserved	
	Bit 17 Reserved	
	Bit 18 Reserved	
	Bit 19 Reserved	
	Bit 20 Reserved	
	Bit 21 Reserved	
	Bit 22 Reserved	
	Bit 23 Reserved	
	Bit 24 Reserved	
	Bit 25 Reserved	
	Bit 26 Reserved	
	Bit 27 Reserved	
	Bit 28 Reserved	
	Bit 29 Reserved	
	Bit 30 RTR not allowed	
Bit 31 PDO invalid		
0x1800:002 (P550.02)	TPDO1 communication parameter: Transmission type (TPDO1 config.: Transm. type) 0 ... [255] ... 255	TPDO1: transmission type in compliance with DS301 V4.02
0x1800:003 (P550.03)	TPDO1 communication parameter: Inhibit time (TPDO1 config.: Inhibit time) 0.0 ... [0.0] ... 6553.5 ms	TPDO1: minimum time between the transmission of two identical PDOs (see DS301 V4.02).
0x1800:005 (P550.05)	TPDO1 communication parameter: Event timer (TPDO1 config.: Event timer) 0 ... [20] ... 65535 ms	TPDO1: Cycle time for PDO transmission with transmission type "254" or "255". <ul style="list-style-type: none"> The set time is internally rounded up to the next multiple of 10 ms.
0x1801:000	TPDO2 communication parameter: Highest sub-index supported <ul style="list-style-type: none"> Read only 	The value "5" is permanently set.

Configuring the network

CANopen

CANopen process data objects



Parameter	Name / value range / [default setting]	Info
0x1801:001 (P551.01)	TPDO2 communication parameter: COB-ID (TPDO2 config.: COB-ID) 0x00000001 ... [0xC0000280] ... 0xFFFFFFFF	TPDO2: identifier How to change the identifier: 1. Set PDO to "invalid": Set bit 31 to "1". 2. Change identifier and reset PDO to "valid" (bit 31 = "0").
	Bit 0 COB-ID bit 0	
	Bit 1 COB-ID bit 1	
	Bit 2 COB-ID bit 2	
	Bit 3 COB-ID bit 3	
	Bit 4 COB-ID bit 4	
	Bit 5 COB-ID bit 5	
	Bit 6 COB-ID bit 6	
	Bit 7 COB-ID bit 7	
	Bit 8 COB-ID bit 8	
	Bit 9 COB-ID bit 9	
	Bit 10 COB-ID bit 10	
	Bit 11 Reserved	
	Bit 12 Reserved	
	Bit 13 Reserved	
	Bit 14 Reserved	
	Bit 15 Reserved	
	Bit 16 Reserved	
	Bit 17 Reserved	
	Bit 18 Reserved	
	Bit 19 Reserved	
	Bit 20 Reserved	
	Bit 21 Reserved	
	Bit 22 Reserved	
	Bit 23 Reserved	
	Bit 24 Reserved	
	Bit 25 Reserved	
	Bit 26 Reserved	
	Bit 27 Reserved	
	Bit 28 Reserved	
	Bit 29 Reserved	
	Bit 30 RTR not allowed	
Bit 31 PDO invalid		
0x1801:002 (P551.02)	TPDO2 communication parameter: Transmission type (TPDO2 config.: Transm. type) 0 ... [255] ... 255	TPDO2: transmission type in compliance with DS301 V4.02
0x1801:003 (P551.03)	TPDO2 communication parameter: Inhibit time (TPDO2 config.: Inhibit time) 0.0 ... [0.0] ... 6553.5 ms	TPDO2: minimum time between the transmission of two identical PDOs (see DS301 V4.02).
0x1801:005 (P551.05)	TPDO2 communication parameter: Event timer (TPDO2 config.: Event timer) 0 ... [0] ... 65535 ms	TPDO2: Cycle time for PDO transmission with transmission type "254" or "255". <ul style="list-style-type: none"> The set time is internally rounded up to the next multiple of 10 ms.
0x1802:000	TPDO3 communication parameter: Highest sub-index supported <ul style="list-style-type: none"> Read only 	The value "5" is permanently set.



Configuring the network

CANopen
CANopen process data objects

Parameter	Name / value range / [default setting]	Info
0x1802:001 (P552.01)	TPDO3 communication parameter: COB-ID (TPDO3 config.: COB-ID) 0x00000001 ... [0xC0000380] ... 0xFFFFFFFF	TPDO3: identifier How to change the identifier: 1. Set PDO to "invalid": Set bit 31 to "1". 2. Change identifier and reset PDO to "valid" (bit 31 = "0").
	Bit 0 COB-ID bit 0	
	Bit 1 COB-ID bit 1	
	Bit 2 COB-ID bit 2	
	Bit 3 COB-ID bit 3	
	Bit 4 COB-ID bit 4	
	Bit 5 COB-ID bit 5	
	Bit 6 COB-ID bit 6	
	Bit 7 COB-ID bit 7	
	Bit 8 COB-ID bit 8	
	Bit 9 COB-ID bit 9	
	Bit 10 COB-ID bit 10	
	Bit 11 Reserved	
	Bit 12 Reserved	
	Bit 13 Reserved	
	Bit 14 Reserved	
	Bit 15 Reserved	
	Bit 16 Reserved	
	Bit 17 Reserved	
	Bit 18 Reserved	
	Bit 19 Reserved	
	Bit 20 Reserved	
	Bit 21 Reserved	
	Bit 22 Reserved	
	Bit 23 Reserved	
	Bit 24 Reserved	
	Bit 25 Reserved	
	Bit 26 Reserved	
	Bit 27 Reserved	
	Bit 28 Reserved	
	Bit 29 Reserved	
	Bit 30 RTR not allowed	
Bit 31 PDO invalid		
0x1802:002 (P552.02)	TPDO3 communication parameter: Transmission type (TPDO3 config.: Transm. type) 0 ... [255] ... 255	TPDO3: transmission type in compliance with DS301 V4.02
0x1802:003 (P552.03)	TPDO3 communication parameter: Inhibit time (TPDO3 config.: Inhibit time) 0.0 ... [0.0] ... 6553.5 ms	TPDO3: minimum time between the transmission of two identical PDOs (see DS301 V4.02).
0x1802:005 (P552.05)	TPDO3 communication parameter: Event timer (TPDO3 config.: Event timer) 0 ... [0] ... 65535 ms	TPDO3: Cycle time for PDO transmission with transmission type "254" or "255". <ul style="list-style-type: none"> The set time is internally rounded up to the next multiple of 10 ms.

Configuring the network

CANopen
CANopen data mapping



8.4.9 CANopen data mapping

Data mapping serves to define which process data are transmitted cyclically via the process data channels.

Details

Data mapping (in the case of CANopen also referred to as "PDO mapping") is preconfigured for control of the inverter via the device profile CiA 402:

- RPDO1 = CiA 402 control word **0x6040** and Target velocity **0x6042 (P781.00)**.
- TPDO1 = CiA 402 status word **0x6041 (P780.00)** and Velocity actual value **0x6044 (P783.00)**.

Variable PDO mapping

For individual drive solutions, the inverter supports "variable PDO mapping", providing 8 mapping entries in each case to assign 8-bit, 16-bit, and 32-bit parameters to a PDO in an optional order. The total length of the parameters mapped, however, must not exceed 8 bytes.



The process of PDO mapping cannot be applied to all parameters. The mappable parameters are marked correspondingly in the parameter attribute list.

The process of variable PDO mapping only allows the following procedure:

1. Set PDO to "invalid": set bit 31 in the corresponding identifier (0x1400:1 ... 0x1402:1 or 0x1800:1 ... 0x1802:1) to "1".
2. Set PDO mapping to "invalid": Set subindex 0 in the mapping parameter (0x1600 ... 0x1602 or 0x1A00 ... 0x1A02) to "0".
3. Set desired PDO mapping via the corresponding mapping entries.
format: 0xiiiiissll (iiii = hexadecimal index, ss = hexadecimal subindex, ll = hexadecimal data length)
4. Set subindex 0 in the mapping parameter (0x1600 ... 0x1602 or 0x1A00 ... 0x1A02) to a valid value (number of parameters mapped).
5. Reset PDO to "valid": set bit 31 in the corresponding identifier (0x1400:1 ... 0x1402:1 or 0x1800:1 ... 0x1802:1) to "0".

Parameter	Name / value range / [default setting]	Info
0x1600:000	RPDO1 mapping parameter: Number of mapped application objects in PDO 0 ... [2] ... 8	Number of objects mapped in RPDO1.
0x1600:001	RPDO1 mapping parameter: Application object 1 0x00000000 ... [0x60400010] ... 0xFFFFFFFF	Mapping entry 1 for RPDO1.
0x1600:002	RPDO1 mapping parameter: Application object 2 0x00000000 ... [0x60420010] ... 0xFFFFFFFF	Mapping entry 2 for RPDO1.
0x1600:003	RPDO1 mapping parameter: Application object 3 0x00000000 ... [0x00000000] ... 0xFFFFFFFF	Mapping entry 3 for RPDO1.
0x1600:004	RPDO1 mapping parameter: Application object 4 0x00000000 ... [0x00000000] ... 0xFFFFFFFF	Mapping entry 4 for RPDO1.
0x1600:005	RPDO1 mapping parameter: Application object 5 0x00000000 ... [0x00000000] ... 0xFFFFFFFF	Mapping entry 5 for RPDO1.
0x1600:006	RPDO1 mapping parameter: Application object 6 0x00000000 ... [0x00000000] ... 0xFFFFFFFF	Mapping entry 6 for RPDO1.
0x1600:007	RPDO1 mapping parameter: Application object 7 0x00000000 ... [0x00000000] ... 0xFFFFFFFF	Mapping entry 7 for RPDO1.
0x1600:008	RPDO1 mapping parameter: Application object 8 0x00000000 ... [0x00000000] ... 0xFFFFFFFF	Mapping entry 8 for RPDO1.
0x1601:000	RPDO2 mapping parameter: Number of mapped application objects in PDO 0 ... [0] ... 8	Number of objects mapped in RPDO2.
0x1601:001	RPDO2 mapping parameter: Application object 1 0x00000000 ... [0x00000000] ... 0xFFFFFFFF	Mapping entry 1 for RPDO2.
0x1601:002	RPDO2 mapping parameter: Application object 2 0x00000000 ... [0x00000000] ... 0xFFFFFFFF	Mapping entry 2 for RPDO2.



Configuring the network

CANopen
CANopen data mapping

Parameter	Name / value range / [default setting]	Info
0x1601:003	RPDO2 mapping parameter: Application object 3 0x00000000 ... [0x00000000] ... 0xFFFFFFFF	Mapping entry 3 for RPDO2.
0x1601:004	RPDO2 mapping parameter: Application object 4 0x00000000 ... [0x00000000] ... 0xFFFFFFFF	Mapping entry 4 for RPDO2.
0x1601:005	RPDO2 mapping parameter: Application object 5 0x00000000 ... [0x00000000] ... 0xFFFFFFFF	Mapping entry 5 for RPDO2.
0x1601:006	RPDO2 mapping parameter: Application object 6 0x00000000 ... [0x00000000] ... 0xFFFFFFFF	Mapping entry 6 for RPDO2.
0x1601:007	RPDO2 mapping parameter: Application object 7 0x00000000 ... [0x00000000] ... 0xFFFFFFFF	Mapping entry 7 for RPDO2.
0x1601:008	RPDO2 mapping parameter: Application object 8 0x00000000 ... [0x00000000] ... 0xFFFFFFFF	Mapping entry 8 for RPDO2.
0x1602:000	RPDO3 mapping parameter: Number of mapped application objects in PDO 0 ... [0] ... 8	Number of objects mapped in RPDO3.
0x1602:001	RPDO3 mapping parameter: Application object 1 0x00000000 ... [0x00000000] ... 0xFFFFFFFF	Mapping entry 1 for RPDO3.
0x1602:002	RPDO3 mapping parameter: Application object 2 0x00000000 ... [0x00000000] ... 0xFFFFFFFF	Mapping entry 2 for RPDO3.
0x1602:003	RPDO3 mapping parameter: Application object 3 0x00000000 ... [0x00000000] ... 0xFFFFFFFF	Mapping entry 3 for RPDO3.
0x1602:004	RPDO3 mapping parameter: Application object 4 0x00000000 ... [0x00000000] ... 0xFFFFFFFF	Mapping entry 4 for RPDO3.
0x1602:005	RPDO3 mapping parameter: Application object 5 0x00000000 ... [0x00000000] ... 0xFFFFFFFF	Mapping entry 5 for RPDO3.
0x1602:006	RPDO3 mapping parameter: Application object 6 0x00000000 ... [0x00000000] ... 0xFFFFFFFF	Mapping entry 6 for RPDO3.
0x1602:007	RPDO3 mapping parameter: Application object 7 0x00000000 ... [0x00000000] ... 0xFFFFFFFF	Mapping entry 7 for RPDO3.
0x1602:008	RPDO3 mapping parameter: Application object 8 0x00000000 ... [0x00000000] ... 0xFFFFFFFF	Mapping entry 8 for RPDO3.
0x1A00:000	TPDO1 mapping parameter: Number of mapped application objects in TPDO 0 ... [2] ... 8	Number of objects mapped in TPDO1.
0x1A00:001	TPDO1 mapping parameter: Application object 1 0x00000000 ... [0x60410010] ... 0xFFFFFFFF	Mapping entry 1 for TPDO1.
0x1A00:002	TPDO1 mapping parameter: Application object 2 0x00000000 ... [0x60440010] ... 0xFFFFFFFF	Mapping entry 2 for TPDO1.
0x1A00:003	TPDO1 mapping parameter: Application object 3 0x00000000 ... [0x00000000] ... 0xFFFFFFFF	Mapping entry 3 for TPDO1.
0x1A00:004	TPDO1 mapping parameter: Application object 4 0x00000000 ... [0x00000000] ... 0xFFFFFFFF	Mapping entry 4 for TPDO1.
0x1A00:005	TPDO1 mapping parameter: Application object 5 0x00000000 ... [0x00000000] ... 0xFFFFFFFF	Mapping entry 5 for TPDO1.
0x1A00:006	TPDO1 mapping parameter: Application object 6 0x00000000 ... [0x00000000] ... 0xFFFFFFFF	Mapping entry 6 for TPDO1.
0x1A00:007	TPDO1 mapping parameter: Application object 7 0x00000000 ... [0x00000000] ... 0xFFFFFFFF	Mapping entry 7 for TPDO1.
0x1A00:008	TPDO1 mapping parameter: Application object 8 0x00000000 ... [0x00000000] ... 0xFFFFFFFF	Mapping entry 8 for TPDO1.
0x1A01:000	TPDO2 mapping parameter: Number of mapped application objects in TPDO 0 ... [0] ... 8	Number of objects mapped in TPDO2.
0x1A01:001	TPDO2 mapping parameter: Application object 1 0x00000000 ... [0x00000000] ... 0xFFFFFFFF	Mapping entry 1 for TPDO2.
0x1A01:002	TPDO2 mapping parameter: Application object 2 0x00000000 ... [0x00000000] ... 0xFFFFFFFF	Mapping entry 2 for TPDO2.
0x1A01:003	TPDO2 mapping parameter: Application object 3 0x00000000 ... [0x00000000] ... 0xFFFFFFFF	Mapping entry 3 for TPDO2.
0x1A01:004	TPDO2 mapping parameter: Application object 4 0x00000000 ... [0x00000000] ... 0xFFFFFFFF	Mapping entry 4 for TPDO2.

Configuring the network

CANopen

CANopen data mapping



Parameter	Name / value range / [default setting]	Info
0x1A01:005	TPDO2 mapping parameter: Application object 5 0x00000000 ... [0x00000000] ... 0xFFFFFFFF	Mapping entry 5 for TPDO2.
0x1A01:006	TPDO2 mapping parameter: Application object 6 0x00000000 ... [0x00000000] ... 0xFFFFFFFF	Mapping entry 6 for TPDO2.
0x1A01:007	TPDO2 mapping parameter: Application object 7 0x00000000 ... [0x00000000] ... 0xFFFFFFFF	Mapping entry 7 for TPDO2.
0x1A01:008	TPDO2 mapping parameter: Application object 8 0x00000000 ... [0x00000000] ... 0xFFFFFFFF	Mapping entry 8 for TPDO2.
0x1A02:000	TPDO3 mapping parameter: Number of mapped application objects in TPDO 0 ... [0] ... 8	Number of objects mapped in TPDO3.
0x1A02:001	TPDO3 mapping parameter: Application object 1 0x00000000 ... [0x00000000] ... 0xFFFFFFFF	Mapping entry 1 for TPDO3.
0x1A02:002	TPDO3 mapping parameter: Application object 2 0x00000000 ... [0x00000000] ... 0xFFFFFFFF	Mapping entry 2 for TPDO3.
0x1A02:003	TPDO3 mapping parameter: Application object 3 0x00000000 ... [0x00000000] ... 0xFFFFFFFF	Mapping entry 3 for TPDO3.
0x1A02:004	TPDO3 mapping parameter: Application object 4 0x00000000 ... [0x00000000] ... 0xFFFFFFFF	Mapping entry 4 for TPDO3.
0x1A02:005	TPDO3 mapping parameter: Application object 5 0x00000000 ... [0x00000000] ... 0xFFFFFFFF	Mapping entry 5 for TPDO3.
0x1A02:006	TPDO3 mapping parameter: Application object 6 0x00000000 ... [0x00000000] ... 0xFFFFFFFF	Mapping entry 6 for TPDO3.
0x1A02:007	TPDO3 mapping parameter: Application object 7 0x00000000 ... [0x00000000] ... 0xFFFFFFFF	Mapping entry 7 for TPDO3.
0x1A02:008	TPDO3 mapping parameter: Application object 8 0x00000000 ... [0x00000000] ... 0xFFFFFFFF	Mapping entry 8 for TPDO3.



8.4.10 CANopen service data objects

Service data objects (SDOs) make it possible to read and write all parameters of the inverter via CANopen.

Details

- Two independent SDO channels are provided at the same time. SDO channel 1 is always active. SDO channel 2 can be activated via [0x2301:005 \(P510.05\)](#).
- The identifiers for SDO1 and SDO2 are generated from the basic identifier (in compliance with the "Predefined Connection Set") and the node address set.
- An SDO is always transmitted with confirmation, i. e. the reception of an SDO frame is acknowledged by the receiver.

Structure of the SDO frame user data

The user data are shown in Motorola format:

1st byte	2nd byte	3rd byte	4th byte	5th byte	6th byte	7th byte	8th byte
Command	Index		Subindex	Data 1	Data 2	Data 3	Data 4
See table below.	LOW byte	HIGH byte		LOW word		HIGH word	
	Address of the parameter to be read or written.			LOW byte	HIGH byte	LOW byte	HIGH byte

The following commands can be transmitted or received for writing and reading the parameters:

Command	1st byte		Data length	Info
	hex	dec		
Write request	0x23	35	4 bytes	Writing of a parameter to the inverter.
	0x2B	43	2 bytes	
	0x2F	47	1 byte	
	0x21	33	Block	
Write response	0x60	96	4 bytes	Inverter acknowledges a write request.
Read request	0x40	64	4 bytes	Reading of a parameter from the inverter.
Read response	0x43	67	4 bytes	Inverter response to a read request with the current parameter value.
	0x4B	75	2 bytes	
	0x4F	79	1 byte	
	0x41	65	Block	
Error response	0x80	128	4 bytes	Inverter response to the incorrect execution of the read/write request.

More precisely, the command byte comprises the following information:

Command	1st byte							
	Command specifier (cs)			Toggle (t)	Length*		e	s
	Bit 7	Bit 6	Bit 5	Bit 4	Bit 3	Bit 2	Bit 1	Bit 0
Write request	0	0	1	0	0/1	0/1	1	1
Write response	0	1	1	0	0	0	0	0
Read request	0	1	0	0	0	0	0	0
Read response	0	1	0	0	0/1	0/1	1	1
Error response	1	0	0	0	0	0	0	0

*Bit coding of the length: 00 = 4 bytes, 01 = 3 bytes, 10 = 2 bytes, 11 = 1 byte
e: expedited (shortened block service)
s: segmented (normal block service)

More commands are defined in the DS301 V4.02 CANopen specification (e.g. segmented transfer).

Configuring the network

CANopen
CANopen error responses



Maximally 4 bytes are available for parameter value entries. Depending on the data format, they are assigned as follows:

5th byte	6th byte	7th byte	8th byte
Parameter value (1 byte)	0x00	0x00	0x00
Parameter value (2 bytes)		0x00	0x00
LOW byte	HIGH byte		
Parameter value (4 bytes)			
LOW word		HIGH word	
LOW byte	HIGH byte	LOW byte	HIGH byte



The parameter attribute list in the annex also specifies a scaling factor. The scaling factor is relevant to the transmission of parameter values which are represented with one or several decimal positions in the parameter list. If the scaling factor is > 1, before the transmission, the value must be multiplied with the scaling factor specified, so that the value can be transferred completely (as an integer value). On the SDO-client side, the integer value must then be divided by the scaling factor again, in order to receive the original value with decimal positions.

Parameter	Name / value range / [default setting]	Info
0x1200:000	SDO1 server parameter: Highest sub-index supported • Read only	
0x1200:001	SDO1 server parameter: COB-ID client -> server (rx) • Read only	Display of the receive identifier for SDO server channel 1 (basic SDO channel). • According to DS301 V4.02, the basic SDO channel can neither be changed nor deactivated.
0x1200:002	SDO1 server parameter: COB-ID server -> client (tx) • Read only	Display of the transmit identifier for SDO server channel 1 (basic SDO channel). • According to DS301 V4.02, the basic SDO channel can neither be changed nor deactivated.
0x1201:000	SDO2 server parameter: Highest sub-index supported • Read only	
0x1201:001	SDO2 server parameter: COB-ID client -> server (rx) 0x00000000 ... [0x80000640] ... 0xFFFFFFFF	Specification of the receive identifier for SDO server channel 2. • If SDO server channel 2 is activated via 0x2301:005 (P510.05), this parameter is set to the value "node address + 0x640". This default setting can be changed.
0x1201:002	SDO2 server parameter: COB-ID server -> client (tx) 0x00000000 ... [0x800005C0] ... 0xFFFFFFFF	Specification of the transmit identifier for SDO server channel 2. • If SDO server channel 2 is activated via 0x2301:005 (P510.05), this parameter is set to the value "node address + 0x5C0". This default setting can be changed.
0x1201:003	SDO2 server parameter: Node-ID of the SDO client 1 ... [0] ... 127	Specification of the node address for the SDO client.
0x2301:005 (P510.05)	CANopen settings: Activate SDO2 channel (CANopen sett.: SDO2 channel)	1 = activate SDO server channel 2.
	0 Not active	
	1 Active	

8.4.11 CANopen error responses

The response to CANopen errors such as missing PDOs or heartbeat frames can be configured via the following parameters.

Parameter	Name / value range / [default setting]	Info
0x1029:000	Error behavior: Highest sub-index supported • Read only	



Configuring the network

CANopen CANopen error responses

Parameter	Name / value range / [default setting]	Info
0x1029:001	Error behavior: Communication error	Selection of the NMT state to which the inverter is to change automatically if a failure of a CANopen node or an internal error is detected in the "Operational" state. These also include the following communication errors: <ul style="list-style-type: none"> • Change-over of the CAN interface to the "Bus-off" state. • Occurrence of a "Heartbeat Event".
	0 Status -> Pre-operational	In the "Pre-operational" state, network management, sync, and emergency telegrams as well as parameter data can be received; process data, however, are ignored.
	1 No status change	
	2 Status -> Stopped	In the "Stopped" state, only network management telegrams can be received.
0x2857:001	CANopen monitoring: RPDO1-Timeout <ul style="list-style-type: none"> • For possible settings see description for 0x2D45:001 (P310.01). 133 	Selection of the response to triggering the RPDO1 time monitoring. Associated error code: <ul style="list-style-type: none"> • 33425 0x8291 - CAN: RPDO1 time-out
	3 Fault	▶ Error types 83
0x2857:002	CANopen monitoring: RPDO2-Timeout <ul style="list-style-type: none"> • For possible settings see description for 0x2D45:001 (P310.01). 133 	Selection of the response to triggering the RPDO2 time monitoring. Associated error code: <ul style="list-style-type: none"> • 33426 0x8292 - CAN: RPDO2 time-out
	3 Fault	▶ Error types 83
0x2857:003	CANopen monitoring: RPDO3-Timeout <ul style="list-style-type: none"> • For possible settings see description for 0x2D45:001 (P310.01). 133 	Selection of the response to triggering the RPDO3 time monitoring. Associated error code: <ul style="list-style-type: none"> • 33427 0x8293 - CAN: RPDO3 time-out
	3 Fault	▶ Error types 83
0x2857:005	CANopen monitoring: Heartbeat-Timeout Consumer 1 <ul style="list-style-type: none"> • For possible settings see description for 0x2D45:001 (P310.01). 133 	Selection of the response with "Heartbeat Event" in consumer 1. Associated error code: <ul style="list-style-type: none"> • 33156 0x8184 - CAN: heartbeat time-out consumer 1
	3 Fault	▶ Error types 83
0x2857:006	CANopen monitoring: Heartbeat-Timeout Consumer 2 <ul style="list-style-type: none"> • For possible settings see description for 0x2D45:001 (P310.01). 133 	Selection of the response with "Heartbeat Event" in consumer 2. Associated error code: <ul style="list-style-type: none"> • 33157 0x8185 - CAN: heartbeat time-out consumer 2
	3 Fault	▶ Error types 83
0x2857:007	CANopen monitoring: Heartbeat-Timeout Consumer 3 <ul style="list-style-type: none"> • For possible settings see description for 0x2D45:001 (P310.01). 133 	Selection of the response with "Heartbeat Event" in consumer 3. Associated error code: <ul style="list-style-type: none"> • 33158 0x8186 - CAN: heartbeat time-out consumer 3
	3 Fault	▶ Error types 83
0x2857:008	CANopen monitoring: Heartbeat-Timeout Consumer 4 <ul style="list-style-type: none"> • For possible settings see description for 0x2D45:001 (P310.01). 133 	Selection of the response with "Heartbeat Event" in consumer 4. Associated error code: <ul style="list-style-type: none"> • 33159 0x8187 - CAN: heartbeat time-out consumer 4
	3 Fault	▶ Error types 83
0x2857:010	CANopen monitoring: "Bus-off" state change <ul style="list-style-type: none"> • For possible settings see description for 0x2D45:001 (P310.01). 133 	Selection of the response to changing to the "Bus off" state. Associated error code: <ul style="list-style-type: none"> • 33154 0x8182 - CAN: bus off
	2 Trouble	▶ Error types 83
0x2857:011	CANopen monitoring: Warning	Selection of the response that is executed in the case of too many incorrectly sent or received CAN telegrams (> 96). Associated error code: <ul style="list-style-type: none"> • 33155 0x8183 - CAN: warning
	0 No response	▶ Error types 83
	1 Warning	
	2 Trouble	
	3 Fault	

Configuring the network

CANopen
CANopen diagnostic counter



8.4.12 CANopen diagnostic counter

The following parameters serve to diagnose the communication activities between the inverter and the CANopen network. The counters are free-running, i. e. when the maximum value has been reached, the respective counter starts at 0 again.

Parameter	Name / value range / [default setting]	Info
0x230A:000	CANopen statistics: Highest subindex • Read only	Number of frame and error counters.
0x230A:001 (P580.01)	CANopen statistics: PDO1 received (CAN statistics: PDO1 received) • Read only	Display of the number of PDO1 telegrams received.
0x230A:002 (P580.02)	CANopen statistics: PDO2 received (CAN statistics: PDO2 received) • Read only	Display of the number of PDO2 telegrams received.
0x230A:003 (P580.03)	CANopen statistics: PDO3 received (CAN statistics: PDO3 received) • Read only	Display of the number of PDO3 telegrams received.
0x230A:005 (P580.05)	CANopen statistics: PDO1 transmitted (CAN statistics: PDO1 transmitted) • Read only	Display of the number of PDO1 telegrams sent.
0x230A:006 (P580.06)	CANopen statistics: PDO2 transmitted (CAN statistics: PDO2 transmitted) • Read only	Display of the number of PDO2 telegrams sent.
0x230A:007 (P580.07)	CANopen statistics: PDO3 transmitted (CAN statistics: PDO3 transmitted) • Read only	Display of the number of PDO3 telegrams sent.
0x230A:009 (P580.09)	CANopen statistics: SDO1 telegrams (CAN statistics: SDO1 counter) • Read only	Display of the number of SDO1 telegrams.
0x230A:010 (P580.10)	CANopen statistics: SDO2 telegrams (CAN statistics: SDO2 counter) • Read only	Display of the number of SDO2 telegrams.
0x230B (P518.00)	CANopen error counter (CAN errorcounter) • Read only	Display of the total number of CAN faults that have occurred.





8.4.13 CANopen LED status displays

Information about the CAN bus status can be obtained quickly via the "CAN-RUN" and "CAN-ERR" LED displays on the front of the inverter.



The meaning can be seen from the tables below.

Inverter not active on the CAN bus (yet)



LED "CAN-RUN"	LED "CAN-ERR"	Meaning
off	off	Inverter is not active on the CAN bus.
	 on	"Bus Off" state.
 Both LEDs are flickering alternately		Automatic baud rate detection active.

Inverter active on the CAN bus

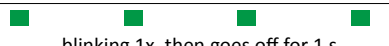
The green "CAN-RUN" LED indicates the CANopen state:

LED "CAN-RUN"	CANopen state
 blinking fast (5 Hz)	Pre-Operational
 on	Operational
 blinking 1x, then goes off for 1 s	Stopped

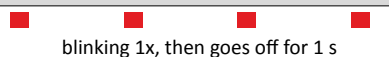
The red "CAN-ERR" LED indicates a CANopen error:

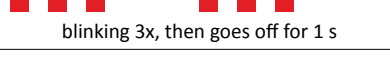
LED "CAN-ERR"	CANopen error
 blinking 1x, then goes off for 1 s	Warning Limit reached
 blinking 2x, then goes off for 1 s	Heartbeat Event
 blinking 3x, then goes off for 1 s	Sync message error (only possible in the "Operational" state)

8.4.14 Resetting the CANopen interface

The following parameter can be used to restart or stop CAN communication. Optionally it is also possible to reset all CAN parameters to the default state.

Parameter	Name / value range / [default setting]	Info
0x2300 (P508.00)	CANopen communication (CANopen comm.) • Setting can only be changed if the inverter is inhibited.	Restart / stop CAN communication. • After successful execution, the value 0 is shown.
	0 No action/no error	Only status feedback.
	1 Restart with current values	Restart CAN communication with the current values.
	2 Restart with default values	Restart CAN communication with the standard values of the CAN parameters (0x1000 ... 0x1FFF und 0x2301).
	5 Stop network communication	Stop CAN communication. • The "Stop Remote Node" NMT command is executed. After successful execution of this command, only the reception of network management frames is possible.
	10 In progress	Only status feedback.
	11 Action cancelled	
	12 Error	

Configuring the network

CANopen
CANopen - short setup



8.4.15 CANopen - short setup

In the following, the steps required for controlling the inverter via CANopen are described.

Parameterisation required

1. Set the CANopen node address.
 - Each network node must be provided with a unique node address.
 - Details: [▶ CANopen node address](#) [📖 158](#)
2. Set the CANopen baud rate.
 - Default setting: 500 kbps
 - Details: [▶ CANopen baud rate](#) [📖 158](#)
3. Optional: Configure inverter as "mini master".
 - Required if the initialisation of the CANopen network and the associated status change from "Pre-Operational" to "Operational" is not effected by a higher-level host system.
 - Details: [▶ CANopen initialisation](#) [📖 159](#)
4. Optional: Change the response of the inverter to the triggering of the RPDO time monitoring.
 - Default setting: In case of missing RPDOs, an error is triggered.
 - Details: [▶ CANopen error responses](#) [📖 176](#)
5. Save parameter settings: [0x2022:003 \(P700.03\)](#) = "On / start [1]".
6. Switch the inverter off and then on again in order that the changed communication settings can get effective.
7. Program the master so that the following SDO messages are sent to the inverter:
 1. [0x2631:037 \(P400.37\)](#) = 1 (activate network control)
 2. [0x2860:001 \(P201.01\)](#) = 5 (set network as standard setpoint source)
 3. PDO mapping and configuration of the process data objects RPDO1 and TPDO1 (see the sections "[RPDO1 mapping](#)" and "[TPDO1 mapping](#)").
8. Control inverter via RPDO1 (and evaluate the current status via TPDO1).
 - For assignment of the control word and setpoint selection, see section "[RPDO1 mapping](#)".
 - For assignment of the status word and actual value output, see section "[TPDO1 mapping](#)".
 - Acceleration [0x2917 \(P220.00\)](#) and deceleration [0x2918 \(P221.00\)](#) can be set/changed via SDO messages.



In the default setting, the digital input DI1 is assigned with the "Run" function. If the network control is activated, this function serves as "start enable" for start commands via network. Hence, the digital input DI1 must be set to HIGH level in order that the motor can be started via network. [▶ Start / stop motor](#) [📖 299](#)



RPDO1 mapping

The RPDO1 is used to control the inverter.

Changing the identifier (COB-ID) and the PDO mapping only allows the following procedure:

1. Set RPDO1 to "invalid": Set bit 31 in the identifier [0x1400:001 \(P540.01\)](#) to "1".
2. Set RPDO1 mapping to "invalid": [0x1600:000](#) = set 0.
3. Map NetWordIN1 data word [0x4008:001 \(P590.01\)](#) to RPDO1:
[0x1600:001](#) = set 0x40080110.
4. Map Network setpoint frequency [0x400B:003 \(P592.03\)](#) to RPDO1:
[0x1600:002](#) = set 0x400B0310.
5. Set RPDO1 mapping to "valid" again: [0x1600:000](#) = set 2 (number of mapped parameters).
6. Optional: Set time-out time for monitoring the data reception in [0x1400:005 \(P540.05\)](#) in [ms].
 - Default setting: 100 ms
7. Change identifier for RPDO1 (optional) and set RPDO1 to "valid" again: Write the new identifier into [0x1400:001 \(P540.01\)](#) and simultaneously set bit 31 to "0".
 - Default setting: 0x200 + node address (hex)
 - Example: Node address = 10 (0xA) and basic identifier = default setting:
Identifier to be written into [0x1400:001 \(P540.01\)](#) = 0x200 + 0xA = 0x20A (0b0011 0000 1010)

Function assignment of the NetWordIN1 data word (byte 1+2 of the RPDO1)

Bit	Default setting	For details and configuration, see
0	Not active (reserve)	0x400E:001 (P505.01)
1	Not active (reserve)	0x400E:002 (P505.02)
2	Activate quick stop	0x400E:003 (P505.03)
3	Not active (reserve)	0x400E:004 (P505.04)
4	Run forward (CW)	0x400E:005 (P505.05)
5	Activate preset (bit 0)	0x400E:006 (P505.06)
6	Activate preset (bit 1)	0x400E:007 (P505.07)
7	Reset error	0x400E:008 (P505.08)
8	Not active (reserve)	0x400E:009 (P505.09)
9	Activate DC braking	0x400E:010 (P505.10)
10	Not active (reserve)	0x400E:011 (P505.11)
11	Not active (reserve)	0x400E:012 (P505.12)
12	Invert rotation	0x400E:013 (P505.13)
13	Not active (reserve)	0x400E:014 (P505.14)
14	Not active (reserve)	0x400E:015 (P505.15)
15	Not active (reserve)	0x400E:016 (P505.16)

Specifying the frequency setpoint (byte 3+4 of the RPDO1)

- The specification is made unsigned (independent of the direction of rotation) as integer in the resolution [0.1 Hz].
- The direction of rotation is defined in the default setting via bit 12 of the NetWordIN1 data word.
- Example: 456 ≙ 45.6 Hz

Configuring the network

CANopen
CANopen - short setup



TPDO1 mapping

The TPDO1 is used for the output of status information and the actual frequency value.

Changing the identifier (COB-ID) and the PDO mapping only allows the following procedure:

1. Set TPDO1 to "invalid": Set bit 31 in the identifier [0x1800:001 \(P550.01\)](#) to "1".
2. Set TPDO1 mapping to "invalid": [0x1A00:000](#) = set 0.
3. Map NetWordOUT1 data word [0x400A:001 \(P591.01\)](#) to TPDO1:
[0x1A00:001](#) = set 0x400A0110.
4. MapFrequency [0.1 Hz] [0x400B:003 \(P592.03\)](#) to TPDO1:
[0x1A00:002](#) = set 0x400C0310.
5. Set TPDO1 mapping to "valid" again: [0x1A00:000](#) = set 2 (number of mapped parameters).
6. Optional: Set Transmission type in [0x1800:002 \(P550.02\)](#) and Event timer in [0x1800:005 \(P550.05\)](#).
 - Default setting: Cyclic transmission every 20 ms.
7. Change identifier for TPDO1 (optional) and set TPDO1 to "valid" again: Write the new identifier into [0x1800:001 \(P550.01\)](#) and simultaneously set bit 31 to "0".
 - Default setting: 0x40000180 + node address (hex)
 - Example: Node address = 10 (0xA) and TPDO1 basic identifier = default setting:
Identifier to be written into [0x1800:001 \(P550.01\)](#) = 0x40000180 + 0xA = 0x4000018A
(0b0100 0000 0000 0000 0000 0001 1000 1010)

Status assignment of the NetWordOUT1 data word (byte 1+2 of the TPDO1)

Bit	Default setting	For details and configuration, see
0	Ready for operation	0x2634:010 (P420.10)
1	Not connected	0x2634:011 (P420.11)
2	Operation enabled	0x2634:012 (P420.12)
3	Error active	0x2634:013 (P420.13)
4	Not connected	0x2634:014 (P420.14)
5	Quick stop active	0x2634:015 (P420.15)
6	Running	0x2634:016 (P420.16)
7	Device warning active	0x2634:017 (P420.17)
8	Not connected	0x2634:018 (P420.18)
9	Not connected	0x2634:019 (P420.19)
10	Setpoint speed reached	0x2634:020 (P420.20)
11	Current limit reached	0x2634:021 (P420.21)
12	Actual speed = 0	0x2634:022 (P420.22)
13	Rotational direction reversed	0x2634:023 (P420.23)
14	Release holding brake	0x2634:024 (P420.24)
15	Safe torque off (STO) active	0x2634:025 (P420.25)

Output of the actual frequency value (byte 3+4 of the TPDO1)

- The output is made unsigned (independent of the direction of rotation) as integer in the resolution [0.1 Hz].
- An active reversal is displayed via bit 13 of the NetWordOUT1 data word.
- Example: 456 ≙ 45.6 Hz



8.5 Modbus



Modbus is an internationally approved, asynchronous, serial communication protocol, designed for commercial and industrial automation applications.

- Detailed information on the Modbus can be found on the web page of the international Modbus Organization, USA, who also further develop the Modbus protocol: <http://www.modbus.org>
- Information about the dimensioning of a Modbus network can be found in the configuration document for the inverter.



Information about the dimensioning of a Modbus network can be found in the configuration document for the inverter.

Preconditions

- Control unit (CU) of the inverter is provided with Modbus/CANopen.
- Modbus/CANopen selector at the inverter front is set to "Modbus".

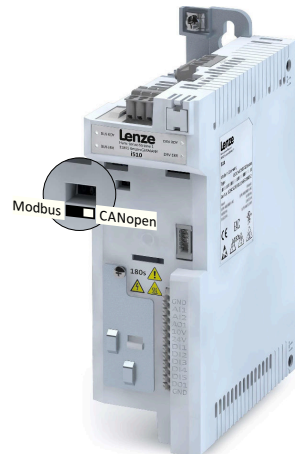

8.5.1 Modbus introduction

- The process of data transmission distinguishes between three different operating modes: Modbus ASCII, Modbus RTU, and Modbus TCP. The inverter supports the Modbus RTU operating mode ("Remote Terminal Unit").
- The Modbus protocol is based on a master/slave architecture where the inverter always works as slave.
- The Modbus network only permits one master (at a time) sending commands and requests. The master is also the sole instance to be allowed to initiate Modbus communication. No direct communication takes place between the slaves.
- The physical interface corresponds to TIA/EIA-485-A which is very common and suitable for the industrial environment. This interface enables baud rates from 2400 to 115200 kbps.
- The inverter supports Modbus function codes 3, 6, 16 (0x10) and 23 (0x17).

Configuring the network

Modbus
Modbus node address



8.5.2 Modbus node address

Each network node must be provided with a unique node address.

Details

- The node address can be set in [0x2321:001 \(P510.01\)](#).
- The setting that is active when the inverter is switched on is the effective setting.
- The node address 0 is reserved for messages to all nodes ("Broadcast").
- The active node address is shown in [0x2322:001 \(P511.01\)](#).

Parameter	Name / value range / [default setting]	Info
0x2321:001 (P510.01)	Modbus settings: Node ID (Modbus sett.: Node ID) 1 ... [1] ... 247	Setting of the node address. <ul style="list-style-type: none">• A change in the node address only becomes effective after a restart of Modbus communication.
0x2323 (P509.00)	Modbus switch position (Modbus switch) <ul style="list-style-type: none">• Read only	Display of the DIP switch setting at the last mains power-on.

8.5.3 Modbus baud rate

All network nodes must be set to the same baud rate.

Details

- The node address can be set in [0x2321:002 \(P510.02\)](#).
- If the automatic baud rate detection function is activated, the first 5 ... 10 messages are lost after switch-on.
- The active baud rate is displayed in [0x2322:002 \(P511.02\)](#).

Parameter	Name / value range / [default setting]	Info
0x2321:002 (P510.02)	Modbus settings: Baud rate (Modbus sett.: Baud rate)	Setting of the baud rate. <ul style="list-style-type: none">• A change in the baud rate only becomes effective after a restart of Modbus communication.• If the automatic baud rate detection function is activated, the first 5 ... 10 messages are lost after switch-on.
	0 Automatic	
	1 2400 kbps	
	2 4800 kbps	
	3 9600 kbps	
	4 19200 kbps	
	5 38400 kbps	
	6 57600 kbps	
7 115200 kbps		
0x2323 (P509.00)	Modbus switch position (Modbus switch) <ul style="list-style-type: none">• Read only	Display of the DIP switch setting at the last mains power-on.

8.5.4 Modbus data format

All network nodes must be set to the same data format.

Details

- The data format can be set in [0x2321:003 \(P510.03\)](#).
- If the automatic data format detection function is activated, the first 5 ... 10 messages are lost after switch-on.
- The active data format is displayed in [0x2322:003 \(P511.03\)](#).

Parameter	Name / value range / [default setting]	Info
0x2321:003 (P510.03)	Modbus settings: Data format (Modbus sett.: Data format)	Definition of the parity and stop bits.
	0 Automatic	Automatic data format detection. <ul style="list-style-type: none">• With this setting, the first 5 ... 10 messages are lost after switch-on.
	1 8, E, 1	8 data bits, even parity, 1 stop bit
	2 8, O, 1	8 data bits, odd parity, 1 stop bit
	3 8, N, 2	8 data bits, no parity bit, 2 stop bits
0x2323 (P509.00)	Modbus switch position (Modbus switch) <ul style="list-style-type: none">• Read only	Display of the DIP switch setting at the last mains power-on.



8.5.5 Modbus time-out monitoring

The response to the missing Modbus messages can be configured via the following parameters.

Parameter	Name / value range / [default setting]	Info
0x2858:001 (P515.01)	Modbus monitoring: Response to time-out (Modbus monit.: Resp. Time-out) <ul style="list-style-type: none"> For possible settings see description for 0x2D45:001 (P310.01). □ 133 	Selection of the response executed if no valid messages have been received via the Modbus for a longer time than the time-out period set in 0x2858:002 (P515.02) . Associated error code: <ul style="list-style-type: none"> 33185 0x81A1 - Modbus: network time-out
	3 Fault	▶ Error types □ 83
0x2858:002 (P515.02)	Modbus monitoring: Time-out time (Modbus monit.: Time-out time) 0.0 ... [2.0] ... 300.0 s	Time-out period for monitoring the message reception via Modbus.

8.5.6 Modbus diagnostics

The following parameters serve to diagnose the communication activities between the inverter and the Modbus network.

Parameter	Name / value range / [default setting]	Info
0x2322:001 (P511.01)	Active Modbus settings: Active node ID (Modbus diag.: Active node ID) <ul style="list-style-type: none"> Read only 	Display of the active node address.
0x2322:002 (P511.02)	Active Modbus settings: Active baud rate (Modbus diag.: Active baud rate) <ul style="list-style-type: none"> Read only 	Display of the active baud rate.
0x2322:003 (P511.03)	Active Modbus settings: Data format (Modbus diag.: Data format) <ul style="list-style-type: none"> Read only 	Display of the active data format.
0x232A:001 (P580.01)	Modbus statistics: Messages received (Modbus statistic: Mess. received) <ul style="list-style-type: none"> Read only 	Display of the total number of messages received. <ul style="list-style-type: none"> This counter counts both valid and invalid messages. After the maximum value has been reached, the counter starts again "0".
0x232A:002 (P580.02)	Modbus statistics: Valid messages received (Modbus statistic: Val. mess. rec.) <ul style="list-style-type: none"> Read only 	Display of the number of valid messages received. <ul style="list-style-type: none"> After the maximum value has been reached, the counter starts again "0".
0x232A:003 (P580.03)	Modbus statistics: Messages with exceptions (Modbus statistic: Mess. w. exc.) <ul style="list-style-type: none"> Read only 	Display of the number of messages with exceptions that have been received. <ul style="list-style-type: none"> After the maximum value has been reached, the counter starts again "0".
0x232A:004 (P580.04)	Modbus statistics: Messages with errors (Modbus statistic: Mess. w. errors) <ul style="list-style-type: none"> Read only 	Display of the number of messages received with a faulty data integrity (parity, CRC). <ul style="list-style-type: none"> After the maximum value has been reached, the counter starts again "0".
0x232A:005 (P580.05)	Modbus statistics: Messages sent (Modbus statistic: Messages sent) <ul style="list-style-type: none"> Read only 	Display of the total number of messages sent. <ul style="list-style-type: none"> After the maximum value has been reached, the counter starts again "0".
0x232E:001 (P583.01)	Modbus diagnostics of last Rx data: Offset (Rx data diagn.: Rx data offset) 0 ... [0] ... 240	For purposes of diagnostics, the last message received (max. 16 bytes) is shown in 0x232E:002 (P583.02) ... 0x232E:017 (P583.17) . For longer messages, an offset can be specified here, indicating from which byte of the message the display of the 16 bytes is to start.

Configuring the network

Modbus

Modbus diagnostics



Parameter	Name / value range / [default setting]	Info
0x232E:002 (P583.02)	Modbus diagnostics of last Rx data: Data byte 0 (Rx data diagn.: Last RxD byte0) • Read only	Display of the message received last.
0x232E:003 (P583.03)	Modbus diagnostics of last Rx data: Data byte 1 (Rx data diagn.: Last RxD byte2) • Read only	
0x232E:004 (P583.04)	Modbus diagnostics of last Rx data: Data byte 2 (Rx data diagn.: Last RxD byte4) • Read only	
0x232E:005 (P583.05)	Modbus diagnostics of last Rx data: Data byte 3 (Rx data diagn.: Last RxD byte6) • Read only	
0x232E:006 (P583.06)	Modbus diagnostics of last Rx data: Data byte 4 (Rx data diagn.: Last RxD byte8) • Read only	
0x232E:007 (P583.07)	Modbus diagnostics of last Rx data: Data byte 5 (Rx data diagn.: Last RxD byte10) • Read only	
0x232E:008 (P583.08)	Modbus diagnostics of last Rx data: Data byte 6 (Rx data diagn.: Last RxD byte12) • Read only	
0x232E:009 (P583.09)	Modbus diagnostics of last Rx data: Data byte 7 (Rx data diagn.: Last RxD byte14) • Read only	
0x232E:010 (P583.10)	Modbus diagnostics of last Rx data: Data byte 8 (Rx data diagn.: Last RxD byte16) • Read only	
0x232E:011 (P583.11)	Modbus diagnostics of last Rx data: Data byte 9 (Rx data diagn.: Last RxD byte18) • Read only	
0x232E:012 (P583.12)	Modbus diagnostics of last Rx data: Data byte 10 (Rx data diagn.: Last RxD byte20) • Read only	
0x232E:013 (P583.13)	Modbus diagnostics of last Rx data: Data byte 11 (Rx data diagn.: Last RxD byte22) • Read only	
0x232E:014 (P583.14)	Modbus diagnostics of last Rx data: Data byte 12 (Rx data diagn.: Last RxD byte24) • Read only	
0x232E:015 (P583.15)	Modbus diagnostics of last Rx data: Data byte 13 (Rx data diagn.: Last RxD byte26) • Read only	
0x232E:016 (P583.16)	Modbus diagnostics of last Rx data: Data byte 14 (Rx data diagn.: Last RxD byte28) • Read only	
0x232E:017 (P583.17)	Modbus diagnostics of last Rx data: Data byte 15 (Rx data diagn.: Last RxD byte30) • Read only	
0x232F:001 (P585.01)	Modbus diagnostics of last Tx data: Offset (Tx data diagn.: Tx data offset) 0 ... [0] ... 240	



Configuring the network

Modbus Modbus diagnostics

Parameter	Name / value range / [default setting]	Info
0x232F:002 (P585.02)	Modbus diagnostics of last Tx data: Data byte 0 (Tx data diagn.: Last TxD byte0) <ul style="list-style-type: none">• Read only	Display of the message sent last.
0x232F:003 (P585.03)	Modbus diagnostics of last Tx data: Data byte 1 (Tx data diagn.: Last TxD Byte1) <ul style="list-style-type: none">• Read only	
0x232F:004 (P585.04)	Modbus diagnostics of last Tx data: Data byte 2 (Tx data diagn.: Last TxD byte2) <ul style="list-style-type: none">• Read only	
0x232F:005 (P585.05)	Modbus diagnostics of last Tx data: Data byte 3 (Tx data diagn.: Last TxD byte3) <ul style="list-style-type: none">• Read only	
0x232F:006 (P585.06)	Modbus diagnostics of last Tx data: Data byte 4 (Tx data diagn.: Last TxD byte4) <ul style="list-style-type: none">• Read only	
0x232F:007 (P585.07)	Modbus diagnostics of last Tx data: Data byte 5 (Tx data diagn.: Last TxD byte5) <ul style="list-style-type: none">• Read only	
0x232F:008 (P585.08)	Modbus diagnostics of last Tx data: Data byte 6 (Tx data diagn.: Last TxD byte6) <ul style="list-style-type: none">• Read only	
0x232F:009 (P585.09)	Modbus diagnostics of last Tx data: Data byte 7 (Tx data diagn.: Last TxD byte7) <ul style="list-style-type: none">• Read only	
0x232F:010 (P585.10)	Modbus diagnostics of last Tx data: Data byte 8 (Tx data diagn.: Last TxD byte8) <ul style="list-style-type: none">• Read only	
0x232F:011 (P585.11)	Modbus diagnostics of last Tx data: Data byte 9 (Tx data diagn.: Last TxD byte9) <ul style="list-style-type: none">• Read only	
0x232F:012 (P585.12)	Modbus diagnostics of last Tx data: Data byte 10 (Tx data diagn.: Last TxD byte10) <ul style="list-style-type: none">• Read only	
0x232F:013 (P585.13)	Modbus diagnostics of last Tx data: Data byte 11 (Tx data diagn.: Last TxD byte11) <ul style="list-style-type: none">• Read only	
0x232F:014 (P585.14)	Modbus diagnostics of last Tx data: Data byte 12 (Tx data diagn.: Last TxD byte12) <ul style="list-style-type: none">• Read only	
0x232F:015 (P585.15)	Modbus diagnostics of last Tx data: Data byte 13 (Tx data diagn.: Last TxD byte13) <ul style="list-style-type: none">• Read only	
0x232F:016 (P585.16)	Modbus diagnostics of last Tx data: Data byte 14 (Tx data diagn.: Last TxD byte14) <ul style="list-style-type: none">• Read only	
0x232F:017 (P585.17)	Modbus diagnostics of last Tx data: Data byte 15 (Tx data diagn.: Last TxD byte15) <ul style="list-style-type: none">• Read only	

Configuring the network

Modbus
Modbus function codes



8.5.7 Modbus function codes

The mode of access to inverter data (parameters) is controlled via function codes.

Details

The inverter supports the following function codes:

Function code	Function name	Description
3	0x03	Read Holding Registers
6	0x06	Preset Single Register
16	0x10	Preset Multiple Registers
23	0x17	Read/Write 4X Registers

Addressing

- The function codes listed above exclusively refer to 4X registers in Modbus addressing.
- All data in the inverter can only be accessed via 4X registers, i.e. via register addresses from 40001.
- The 4xxx reference is implicit, i. e. given by the function code used. In the frame therefore the leading 4 is omitted in the addressing process.
- The numbering of the registers starts with 1; addressing, however, starts with 0. Therefore, for instance, the address 0 is used in the frame when register 40001 is read.

Telegram structure

Communication is established on the basis of the central medium access method. Communication is always started by a master request. The inverter (slave) then either gives a valid response or outputs an error code (provided that the request has been received and evaluated as a valid Modbus frame). Error causes can be invalid CRC checksums, function codes that are not supported, or impermissible data access.

All Modbus frames have the following basic structure:

- A "frame" consists of a PDU (Protocol Data Unit) and an ADU (Application Data Unit).
- The PDU contains the function code and the data belonging to the function code.
- The ADU serves the purposes of addressing and error detection.
- The data are represented in Big Endian format (most significant byte first).

ADU (Application Data Unit)			
Slave address	Function code	Data	Checksum (CRC)
	PDU (Protocol Data Unit)		

Error codes

Error code	Name	Cause(s)
0x01	Invalid function code	The function code is not supported by the inverter, or the inverter is in a state in which the request is not permissible or in which it cannot be processed.
0x02	Invalid data address	The combination of a start address and the length of the data to be transmitted is invalid. Example: If you have a slave with 100 registers, the first register has the address 0 and the last register has the address 99. If there is a request of four registers now, from the start address 96, the request can be processed successfully (for registers 96, 97, 98, and 99). If, however, five registers from the start address 96 are queried, this error code is returned, since the slave has no register with the address 100.
0x03	Invalid data value	The cause, however, is not that a (parameter) value is written outside the valid setting range. As a matter of principle, the Modbus protocol has no information on valid setting ranges of individual registers or their meaning.
0x04	Slave device failure	A non-correctable error has occurred while the request was processed in the inverter.



8.5.8 Modbus data mapping

The process of data mapping is used for defining which Modbus registers read or write to which inverter parameters.

Details

- There are fixedly defined Modbus registers for common control and status words, which are located in coherent blocks, in order to facilitate communication with OPC servers and other Modbus masters. In order to access all relevant data of the inverter, only a minimum number of commands is required.
- In addition, 24 registers are provided for variable mapping, i. e. free assignment to inverter parameters.

Predefined Modbus control registers

- These registers are provided with write and read access.
- The cross-reference in column 2 leads to the detailed parameter description.

Modbus registers	Permanently assigned parameter	
	Address	Name
42101	0x400B:001 (P592.01)	AC Drive control word
42102	0x400B:005 (P592.05)	Network setpoint frequency
42103	0x4008:002 (P590.02)	NetWordIN2
42104	0x4008:003 (P590.03)	NetWordIN3
42105	0x400B:007 (P592.07)	PID setpoint
42106	0x6071	Target torque
42107	0x4008:001 (P590.01)	NetWordIN1
42108	0x4008:004 (P590.04)	NetWordIN4
42109 ... 42121	-	Reserved

Predefined Modbus status registers

- These registers are only provided with read access.
- The cross-reference in column 2 leads to the detailed parameter description.

Modbus registers	Permanently assigned parameter	
	Address	Name
42001	0x400C:001 (P593.01)	AC Drive status word
42002	0x400C:006 (P593.06)	Frequency [0.01 Hz]
42003	0x603F (P150.00)	Error code
42004	0x400C:005 (P593.05)	Drive status
42005	0x2D89 (P106.00)	Motor voltage
42006	0x2D88 (P104.00)	Motor current
42007	0x6078 (P103.00)	Current actual value
42008	0x2DA2:002 (P108.02)	Apparent power (42008 = High Word, 42009 = Low Word)
42009		
42010	0x2D84:001 (P117.01)	Heatsink temperature
42011	0x2D87 (P105.00)	DC-bus voltage
42012	0x60FD (P118.00)	Digital inputs (only bit 16 ... bit 31)
42013	0x6077 (P107.00)	Torque actual value
42014 ... 42021	-	Reserved

Variable mapping

- Via [0x232B:1 ... 24](#), 24 registers can be mapped variably to parameters of the inverter. Format: [0xiiii:ss00](#) (iiii = hexadecimal index, ss = hexadecimal subindex)
- The display of the internal Modbus register numbers in [0x232C:1 ... 24](#) is generated automatically. Since 32-bit parameters require two registers, there is no 1:1 assignment.
- For the mappable registers, a CRC (Cyclic Redundancy Check) is executed. The checksum determined is displayed in [0x232D \(P532.00\)](#). The user can read this "validation code" and use it for comparison in the Modbus master. In this way it can be checked whether the inverter currently queried is configured correctly for the respective application.

Configuring the network

Modbus

Modbus data mapping



Parameter	Name / value range / [default setting]	Info
0x232B:001 (P530.01)	Modbus parameter mapping: Parameter 1 (Para. mapping: Parameter 1) 0x00000000 ... [0x00000000] ... 0xFFFFFFFF00	Mapping entry for Modbus register 40103.
0x232B:002 (P530.02)	Modbus parameter mapping: Parameter 2 (Para. mapping: Parameter 2) 0x00000000 ... [0x00000000] ... 0xFFFFFFFF00	Mapping entry for Modbus register 40105.
0x232B:003 (P530.03)	Modbus parameter mapping: Parameter 3 (Para. mapping: Parameter 3) 0x00000000 ... [0x00000000] ... 0xFFFFFFFF00	Mapping entry for Modbus register 40107.
0x232B:004 (P530.04)	Modbus parameter mapping: Parameter 4 (Para. mapping: Parameter 4) 0x00000000 ... [0x00000000] ... 0xFFFFFFFF00	Mapping entry for Modbus register 40109.
0x232B:005 (P530.05)	Modbus parameter mapping: Parameter 5 (Para. mapping: Parameter 5) 0x00000000 ... [0x00000000] ... 0xFFFFFFFF00	Mapping entry for Modbus register 40111.
0x232B:006 (P530.06)	Modbus parameter mapping: Parameter 6 (Para. mapping: Parameter 6) 0x00000000 ... [0x00000000] ... 0xFFFFFFFF00	Mapping entry for Modbus register 40113.
0x232B:007 (P530.07)	Modbus parameter mapping: Parameter 7 (Para. mapping: Parameter 7) 0x00000000 ... [0x00000000] ... 0xFFFFFFFF00	Mapping entry for Modbus register 40115.
0x232B:008 (P530.08)	Modbus parameter mapping: Parameter 8 (Para. mapping: Parameter 8) 0x00000000 ... [0x00000000] ... 0xFFFFFFFF00	Mapping entry for Modbus register 40117.
0x232B:009 (P530.09)	Modbus parameter mapping: Parameter 9 (Para. mapping: Parameter 9) 0x00000000 ... [0x00000000] ... 0xFFFFFFFF00	Mapping entry for Modbus register 40119.
0x232B:010 (P530.10)	Modbus parameter mapping: Parameter 10 (Para. mapping: Parameter 10) 0x00000000 ... [0x00000000] ... 0xFFFFFFFF00	Mapping entry for Modbus register 40121.
0x232B:011 (P530.11)	Modbus parameter mapping: Parameter 11 (Para. mapping: Parameter 11) 0x00000000 ... [0x00000000] ... 0xFFFFFFFF00	Mapping entry for Modbus register 40123.
0x232B:012 (P530.12)	Modbus parameter mapping: Parameter 12 (Para. mapping: Parameter 12) 0x00000000 ... [0x00000000] ... 0xFFFFFFFF00	Mapping entry for Modbus register 40125.
0x232B:013 (P530.13)	Modbus parameter mapping: Parameter 13 (Para. mapping: Parameter 13) 0x00000000 ... [0x00000000] ... 0xFFFFFFFF00	Mapping entry for Modbus register 40127.
0x232B:014 (P530.14)	Modbus parameter mapping: Parameter 14 (Para. mapping: Parameter 14) 0x00000000 ... [0x00000000] ... 0xFFFFFFFF00	Mapping entry for Modbus register 40129.
0x232B:015 (P530.15)	Modbus parameter mapping: Parameter 15 (Para. mapping: Parameter 15) 0x00000000 ... [0x00000000] ... 0xFFFFFFFF00	Mapping entry for Modbus register 40131.
0x232B:016 (P530.16)	Modbus parameter mapping: Parameter 16 (Para. mapping: Parameter 16) 0x00000000 ... [0x00000000] ... 0xFFFFFFFF00	Mapping entry for Modbus register 40133.
0x232B:017 (P530.17)	Modbus parameter mapping: Parameter 17 (Para. mapping: Parameter 17) 0x00000000 ... [0x00000000] ... 0xFFFFFFFF00	Mapping entry for Modbus register 40135.
0x232B:018 (P530.18)	Modbus parameter mapping: Parameter 18 (Para. mapping: Parameter 18) 0x00000000 ... [0x00000000] ... 0xFFFFFFFF00	Mapping entry for Modbus register 40137.
0x232B:019 (P530.19)	Modbus parameter mapping: Parameter 19 (Para. mapping: Parameter 19) 0x00000000 ... [0x00000000] ... 0xFFFFFFFF00	Mapping entry for Modbus register 40139.
0x232B:020 (P530.20)	Modbus parameter mapping: Parameter 20 (Para. mapping: Parameter 20) 0x00000000 ... [0x00000000] ... 0xFFFFFFFF00	Mapping entry for Modbus register 40141.
0x232B:021 (P530.21)	Modbus parameter mapping: Parameter 21 (Para. mapping: Parameter 21) 0x00000000 ... [0x00000000] ... 0xFFFFFFFF00	Mapping entry for Modbus register 40143.



Configuring the network

Modbus Modbus data mapping

Parameter	Name / value range / [default setting]	Info
0x232B:022 (P530.22)	Modbus parameter mapping: Parameter 22 (Para. mapping: Parameter 22) 0x00000000 ... [0x00000000] ... 0xFFFFFFFF00	Mapping entry for Modbus register 40145.
0x232B:023 (P530.23)	Modbus parameter mapping: Parameter 23 (Para. mapping: Parameter 23) 0x00000000 ... [0x00000000] ... 0xFFFFFFFF00	Mapping entry for Modbus register 40147.
0x232B:024 (P530.24)	Modbus parameter mapping: Parameter 24 (Para. mapping: Parameter 24) 0x00000000 ... [0x00000000] ... 0xFFFFFFFF00	Mapping entry for Modbus register 40149.
0x232C:001 (P531.01)	Modbus register assignment: Register 1 (Reg. assigned: Register 1) • Read only	Display of the internal Modbus register number starting from which the parameter mapped in 0x232B:1 is stored. • For the first parameter mapped, always 2500.
0x232C:002 (P531.02)	Modbus register assignment: Register 2 (Reg. assigned: Register 2) • Read only	Display of the internal Modbus register number starting from which the parameter mapped in 0x232B:2 is stored. • 2500 + offset. The offset results from the data types of the previously mapped parameters.
0x232C:003 (P531.03)	Modbus register assignment: Register 3 (Reg. assigned: Register 3) • Read only	Display of the internal Modbus register number starting from which the parameter mapped in 0x232B:3 is stored. • 2500 + offset. The offset results from the data types of the previously mapped parameters.
0x232C:004 (P531.04)	Modbus register assignment: Register 4 (Reg. assigned: Register 4) • Read only	Display of the internal Modbus register number starting from which the parameter mapped in 0x232B:4 is stored. • 2500 + offset. The offset results from the data types of the previously mapped parameters.
0x232C:005 (P531.05)	Modbus register assignment: Register 5 (Reg. assigned: Register 5) • Read only	Display of the internal Modbus register number starting from which the parameter mapped in 0x232B:5 is stored. • 2500 + offset. The offset results from the data types of the previously mapped parameters.
0x232C:006 (P531.06)	Modbus register assignment: Register 6 (Reg. assigned: Register 6) • Read only	Display of the internal Modbus register number starting from which the parameter mapped in 0x232B:6 is stored. • 2500 + offset. The offset results from the data types of the previously mapped parameters.
0x232C:007 (P531.07)	Modbus register assignment: Register 7 (Reg. assigned: Register 7) • Read only	Display of the internal Modbus register number starting from which the parameter mapped in 0x232B:7 is stored. • 2500 + offset. The offset results from the data types of the previously mapped parameters.
0x232C:008 (P531.08)	Modbus register assignment: Register 8 (Reg. assigned: Register 8) • Read only	Display of the internal Modbus register number starting from which the parameter mapped in 0x232B:8 is stored. • 2500 + offset. The offset results from the data types of the previously mapped parameters.
0x232C:009 (P531.09)	Modbus register assignment: Register 9 (Reg. assigned: Register 9) • Read only	Display of the internal Modbus register number starting from which the parameter mapped in 0x232B:9 is stored. • 2500 + offset. The offset results from the data types of the previously mapped parameters.
0x232C:010 (P531.10)	Modbus register assignment: Register 10 (Reg. assigned: Register 10) • Read only	Display of the internal Modbus register number starting from which the parameter mapped in 0x232B:10 is stored. • 2500 + offset. The offset results from the data types of the previously mapped parameters.
0x232C:011 (P531.11)	Modbus register assignment: Register 11 (Reg. assigned: Register 11) • Read only	Display of the internal Modbus register number starting from which the parameter mapped in 0x232B:11 is stored. • 2500 + offset. The offset results from the data types of the previously mapped parameters.
0x232C:012 (P531.12)	Modbus register assignment: Register 12 (Reg. assigned: Register 12) • Read only	Display of the internal Modbus register number starting from which the parameter mapped in 0x232B:12 is stored. • 2500 + offset. The offset results from the data types of the previously mapped parameters.
0x232C:013 (P531.13)	Modbus register assignment: Register 13 (Reg. assigned: Register 13) • Read only	Display of the internal Modbus register number starting from which the parameter mapped in 0x232B:13 is stored. • 2500 + offset. The offset results from the data types of the previously mapped parameters.

Configuring the network

Modbus

Modbus data mapping



Parameter	Name / value range / [default setting]	Info
0x232C:014 (P531.14)	Modbus register assignment: Register 14 (Reg. assigned: Register 14) • Read only	Display of the internal Modbus register number starting from which the parameter mapped in 0x232B:14 is stored. • 2500 + offset. The offset results from the data types of the previously mapped parameters.
0x232C:015 (P531.15)	Modbus register assignment: Register 15 (Reg. assigned: Register 15) • Read only	Display of the internal Modbus register number starting from which the parameter mapped in 0x232B:15 is stored. • 2500 + offset. The offset results from the data types of the previously mapped parameters.
0x232C:016 (P531.16)	Modbus register assignment: Register 16 (Reg. assigned: Register 16) • Read only	Display of the internal Modbus register number starting from which the parameter mapped in 0x232B:16 is stored. • 2500 + offset. The offset results from the data types of the previously mapped parameters.
0x232C:017 (P531.17)	Modbus register assignment: Register 17 (Reg. assigned: Register 17) • Read only	Display of the internal Modbus register number starting from which the parameter mapped in 0x232B:17 is stored. • 2500 + offset. The offset results from the data types of the previously mapped parameters.
0x232C:018 (P531.18)	Modbus register assignment: Register 18 (Reg. assigned: Register 18) • Read only	Display of the internal Modbus register number starting from which the parameter mapped in 0x232B:18 is stored. • 2500 + offset. The offset results from the data types of the previously mapped parameters.
0x232C:019 (P531.19)	Modbus register assignment: Register 19 (Reg. assigned: Register 19) • Read only	Display of the internal Modbus register number starting from which the parameter mapped in 0x232B:19 is stored. • 2500 + offset. The offset results from the data types of the previously mapped parameters.
0x232C:020 (P531.20)	Modbus register assignment: Register 20 (Reg. assigned: Register 20) • Read only	Display of the internal Modbus register number starting from which the parameter mapped in 0x232B:20 is stored. • 2500 + offset. The offset results from the data types of the previously mapped parameters.
0x232C:021 (P531.21)	Modbus register assignment: Register 21 (Reg. assigned: Register 21) • Read only	Display of the internal Modbus register number starting from which the parameter mapped in 0x232B:21 is stored. • 2500 + offset. The offset results from the data types of the previously mapped parameters.
0x232C:022 (P531.22)	Modbus register assignment: Register 22 (Reg. assigned: Register 22) • Read only	Display of the internal Modbus register number starting from which the parameter mapped in 0x232B:22 is stored. • 2500 + offset. The offset results from the data types of the previously mapped parameters.
0x232C:023 (P531.23)	Modbus register assignment: Register 23 (Reg. assigned: Register 23) • Read only	Display of the internal Modbus register number starting from which the parameter mapped in 0x232B:23 is stored. • 2500 + offset. The offset results from the data types of the previously mapped parameters.
0x232C:024 (P531.24)	Modbus register assignment: Register 24 (Reg. assigned: Register 24) • Read only	Display of the internal Modbus register number starting from which the parameter mapped in 0x232B:24 is stored. • 2500 + offset. The offset results from the data types of the previously mapped parameters.
0x232D (P532.00)	Modbus verification code (Verificationcode) • Read only	
0x6071	Target torque -3276.8 ... [0.0] ... 3276.7 %	Setpoint torque for the "MS: Torque mode" operating mode. • 100 % ≙ Motor rated torque 0x6076 (P325.00)





8.5.9 Modbus LED status displays

Information about the Modbus status can be obtained quickly via the "MOD-RUN" and "MOD-ERR" LED displays on the front of the inverter.

The meaning can be seen from the tables below.

Inverter not active on the Modbus bus (yet)

LED "MOD-RUN"	LED "MOD-ERR"	Meaning
off	 on	Internal error
		Automatic detection of baud rate and data format active.

Inverter active on the Modbus

The green "MOD-RUN" LED indicates the communication status:

LED "MOD-RUN"	Communication status
off	No reception / no transmission
 on	Reception / transmission active

The red "MOD-ERR" LED indicates an error:

LED "MOD-ERR"	Error
off	No fault
 Blinking	Communication error

8.5.10 Reset Modbus interface

Parameter	Name / value range / [default setting]	Info
0x2320 (P508.00)	Modbus communication (Modbus comm.) 0 ... [0] ... 1	1 = activate network options.

8.5.11 Modbus response time

Parameter	Name / value range / [default setting]	Info
0x2321:004 (P510.04)	Modbus settings: Minimum response time (Modbus sett.: Min. resp. time) 0 ... [0] ... 1000 ms	Minimum time delay between the reception of a valid message and the response of the drive.

Configuring the network

Modbus
Short setup of Modbus



8.5.12 Short setup of Modbus

In the following, the steps required for controlling the inverter via Modbus are described.

Parameterisation required

1. Activate network control: `0x2631:037 (P400.37) = "TRUE [1]"`
2. Set network as standard setpoint source: `0x2860:001 (P201.01) = "Network [5]"`
3. Set Modbus node address.
 - Each network node must be provided with a unique node address.
 - Details: [▶ Modbus node address](#) 184
4. Set Modbus baud rate.
 - Default setting: Automatic detection.
 - If the automatic baud rate detection function is activated, the first 5 ... 10 messages are lost after switch-on.
 - Details: [▶ Modbus baud rate](#) 184
5. Set Modbus data format.
 - Default setting: Automatic detection.
 - If the automatic data format detection function is activated, the first 5 ... 10 messages are lost after switch-on.
 - Details: [▶ Modbus data format](#) 184



In the default setting, the digital input DI1 is assigned with the "Run" function. If the network control is activated, this function serves as "start enable" for start commands via network. Hence, the digital input DI1 must be set to HIGH level in order that the motor can be started via network. [▶ Start / stop motor](#) 299

Starting/stopping the drive via Modbus

For starting/stopping the drive, Modbus register 42101 can be used.

- Modbus register 42101 is permanently assigned to the AC Drive control word `0x400B:001 (P592.01)`.
- In the frame, the leading 4 is omitted in the addressing process. The numbering of the registers starts with 1; addressing, however starts with 0. Therefore the address 2100 (0x0834) is used in the frame when register 42101 is written.

Bits set in the AC drive control word:

- Bit 0 \equiv Run forward (CW)
- Bit 5 \equiv Activate network control
- Bit 6 \equiv Activate network setpoint

Example of an inverter with the node address 1:

Request frame by the master							
Slave address	Function code	Data				Checksum (CRC)	
		Register address		AC Drive control word			
0x01	0x06	0x08	0x34	0x00	0x61	0x0B	0x8C

If digital input DI1 ("Start enable") is set to HIGH level, the drive should start and the inverter should respond with the same frame as confirmation:

Response message from the inverter							
Slave address	Function code	Data				Checksum (CRC)	
		Register address		AC Drive control word			
0x01	0x06	0x08	0x34	0x00	0x61	0x0B	0x8C



8.6 Wireless LAN (WLAN)

The pluggable WLAN module enables

- an easy access to inverters that are installed in difficult access areas,
- an easy parameter setting without cable and instead of the keypad,
- a comfortable monitoring and adaptation of the machine.

The inverter can be accessed via WLAN with the following devices:

- Engineering PC (with WLAN functionality) and the »EASY Starter« engineering tool.
- Android smartphone with Lenze Smart Keypad App.

The Lenze Smart Keypad App is recommended for the adaptation of simple applications. The Lenze Smart Keypad App can be found in the Google Play Store.



8.6.1 LED status displays

Information on the WLAN module status can be obtained quickly via the LED displays "Power", "TX/RX" and "WLAN" on the front of the WLAN module.

The meaning can be seen from the table below.

LED "Power" (green)	LED "TX/RX" (yellow)	LED "WLAN" (green)	Status/meaning
off	off	off	No supply voltage.
on	on	on	Self-test (duration approx. 1 s)
on	off	off	Ready for operation — no active WLAN connection.
on	Flashing	on	Communication active.
on	off	Blinking	Client mode — waiting for connection.
Blinking	off	off	Trouble



After being plugged in, the WLAN module needs approx. 20 seconds until it is ready for operation.

Configuring the network

Wireless LAN (WLAN)
WLAN basic settings



8.6.2 WLAN basic settings

The WLAN functionality can be configured via the following parameters.

Preconditions

WLAN module has been plugged onto the interface X16 on the front of the inverter.

Details

- The WLAN module can be connected and removed during operation.
- The WLAN module can either create an own WLAN network (access point mode, default setting) or implement itself as a WLAN client in an already existing WLAN network. For details see the following subchapters.
- The WLAN connection is encrypted. The WLAN encryption can be selected in [0x2441:009](#).
- [0x2441:012](#) can be used to set that the name of the WLAN network, called SSID, is not visible for other WLAN devices. As a result, the number of WLAN networks displayed on smartphone or PC can be reduced.

Parameter	Name / value range / [default setting]	Info
0x2440	Initiate WLAN • From version 02.00	Restart WLAN network with default setting or current settings.
	0 No action/no error	Only status display.
	2 Restart with default values	Restart WLAN network with default setting of the WLAN parameters.
	11 Restart with current values	Restart WLAN network with current settings of the WLAN parameters. At the same time, the current settings are saved in the WLAN module.
0x2441:004	DHCP • From version 02.00	1 = Dynamic Host Configuration Protocol (DHCP) is enabled. • In the access point mode, the DHCP server of the WLAN module is activated. • In the client mode, the DHCP-client function is activated.
	0 Disabled	
	1 Enabled	
0x2441:005	DHCP start address 0 ... [0] ... 4294967295 • From version 02.00	Definition of the start address when the Dynamic Host Configuration Protocol (DHCP) is used. • Only relevant for access point mode. • When 0 is set, the active IP address + 1 is used as start address.
0x2441:006	WLAN operation mode • From version 02.00	Definition of the operating mode of the WLAN module.
	0 Access point mode	For a direct connection to another WLAN device, the WLAN module creates an own WLAN network. ▶ WLAN access point mode □ 200
	1 Client mode	The WLAN module can be integrated as WLAN client into an already existing WLAN network. ▶ WLAN client mode □ 205
0x2441:007	WLAN SSID ["i5"] • From version 02.00	Name (Service Set Identifier, SSID) of the WLAN network. • The preset name consists of the device name (iXXX) and the first 10 digits of the serial number. • Example: "i550_0123456789" • The serial number is displayed in 0x2000:002 (P190.02) .
0x2441:008	WLAN password ["password"] • From version 02.00	Password (WLAN network key) of the WLAN network. • This password serves to secure the WLAN connections. • The password must have a minimum length of 8 digits. Note! If the WLAN module is to be plugged onto the inverter for a longer period of time, it is important to select a safe password. Otherwise, a potential attacker might connect to the WLAN access point and attack the device and other connected devices or networks. Currently (status: 2016), a WLAN is considered as safe if the password • consists of more than 20 characters, • contains capital and small letters, numbers and special characters and • cannot be found in any dictionary.
0x2441:009	WLAN security • From version 02.00	Selection of the WLAN encryption.
	0 WPA	
	1 WPA2	



Configuring the network

Wireless LAN (WLAN)

WLAN basic settings

Parameter	Name / value range / [default setting]	Info
0x2441:010	WLAN access • From version 02.00	Switch on/off WLAN.
	0 Disabled (WLAN off)	
	1 Enabled (WLAN on)	
0x2441:011	WLAN channel • From version 02.00	Selection of the WLAN channel.
	1 Channel 1	
	2 Channel 2	
	3 Channel 3	
	4 Channel 4	
	5 Channel 5	
	6 Channel 6	
	7 Channel 7	
	8 Channel 8	
	9 Channel 9	
	10 Channel 10	
	11 Channel 11	
0x2441:012	WLAN SSID broadcast • From version 02.00	1 = the name of the WLAN network, called SSID, is not visible for other WLAN devices.
	0 Activated	
	1 Deactivated	
0x2442:004	Active module mode • Read only • From version 02.00	Display of the active WLAN settings. • This parameter indicates whether the settings used come from the inverter or from the WLAN module.
	0 Inverter	The WLAN settings saved in the inverter are used.
	1 Standalone	The WLAN settings saved in the WLAN module are used.
0x2442:005	MAC address • Read only • From version 02.00	Display of the MAC address of the WLAN module.
0x2449	WLAN error • Read only • From version 02.00	Bit coded display of WLAN errors.
	Bit 2 ERR_WIFI_ERROR	WLAN connection problem
	Bit 3 ERR_MEM_CHK_FAILED	Memory problem
	Bit 4 WIFI_CHK_FAILED	WLAN connection problem
	Bit 7 ERR_WIFI_OFF	
	Bit 9 ERR_CLIENT_MODE_OFF	WLAN-client-mode problem
Bit 12 ERR_TCPIP_CFG_FAIL	TCP/IP configuration error	

Configuring the network

Wireless LAN (WLAN)
WLAN basic settings



8.6.2.1 Resetting WLAN settings to default setting

Possible reasons:

- Password is not known anymore.
- WLAN SSID is not visible and not known anymore.
- WLAN module mode "stand-alone" shall be deactivated.

[0x2440](#) serves to reset all WLAN settings to the default setting. For this purpose, the inverter must be connected to the »EASY Starter« via the USB module or an existing network.

Option 1: Reset via USB module

How to reset the WLAN settings to default setting by means of the USB module:

Requirements:

- The inverter is ready for operation (supplied with voltage).

Required accessories:

- USB module
- USB 2.0 cable (A-plug on micro B-plug)
- PC with installed »EASY Starter« software

1. Remove the WLAN module from the inverter and plug on the USB module instead.
2. Establish a connection between inverter and »EASY Starter« via the USB module.
3. Set the parameter [0x2440](#) to "Restart with default values [2]".
4. Remove the USB module from the inverter and plug on the WLAN module instead again.

The default setting is loaded.

Option 2: Reset via network

How to reset the WLAN settings to default setting via network:

Requirements:

- The inverter is ready for operation (supplied with voltage).
- The inverter is connected to a functioning network.

Required accessories:

- PC with installed »EASY Starter«. Moreover, the PC must be connected to the network which also implements the inverter.

1. Establish a connection between the inverter and »EASY Starter« via the used network.
2. Set the parameter [0x2440](#) to "Restart with default values [2]".

The default setting is loaded.



8.6.3 WLAN access point mode

In the presetting, the WLAN module is configured as WLAN access point because this is the most frequent application. In this operating mode, the WLAN module creates its own WLAN network for a direct connection to other WLAN devices.

The supported WLAN devices are:

- Android smartphone with Lenze Smart Keypad App.
- Engineering PC (with WLAN functionality) and the »EASY Starter« engineering tool.

Details

- In default setting, every inverter with WLAN functionality comes with an individual network name, called SSID.
- The preset network name consists of the device name (iXXX) and the first 10 digits of the serial number (example: "i550_0123456789").
- In the default setting, the password for the WLAN network is called "password" and can be changed in `0x2441:008`.



If the WLAN module is to be plugged onto the inverter for a longer period of time, it is important to select a safe password. Otherwise, a potential attacker might connect to the WLAN access point and attack the device and other connected devices or networks. Currently (status: 2016), a WLAN is considered as safe if the password consists of more than 20 characters, contains capital and small letters, numbers and special characters and cannot be found in any dictionary.

The following illustration displays the SSIDs as examples only:

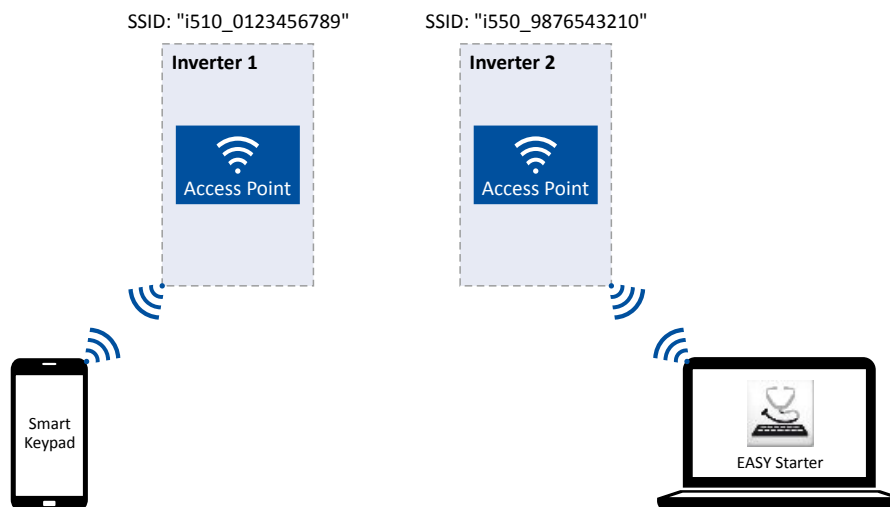

For establishing a WLAN connection, only a few settings are required. The respective setting is described in the following subchapters:

- [Establishing a direct WLAN connection between smartphone and inverter](#) 201
- [Using the smartphone as "Smart Keypad"](#) 202
- [Establishing a direct WLAN connection between Engineering PC and inverter](#) 203

Configuring the network

Wireless LAN (WLAN)
WLAN access point mode



8.6.3.1 Establishing a direct WLAN connection between smartphone and inverter

How to establish a direct WLAN connection to the inverter on the smartphone:

Requirements:

- The functional test described in the mounting and switch-on instructions has been completed successfully (without any errors or faults).
- The inverter is ready for operation (supplied with voltage).

Required accessories:

- WLAN module
- Android smartphone
- Lenze Smart Keypad App (available free of charge in the Google Play Store)

1. Plug the WLAN module onto the front of the inverter (interface X16).
2. Unless already activated, activate the WLAN function on the smartphone under "Settings" → "WLAN".

The WLAN networks available in your range are now displayed.

3. Select the WLAN network established by the inverter.
4. Enter the password for the WLAN network (default setting "password") and click "Connect".

The connection to the WLAN network of the inverter is now established.

5. Start the Lenze Smart Keypad App on the Android smartphone.

If a WLAN connection to the inverter has been established, the Lenze Smart Keypad App serves to

- read out diagnostics parameters of the inverter,
- change parameter settings of the inverter and
- transmit parameter sets.



8.6.3.2 Using the smartphone as "Smart Keypad"

In the default setting, the WLAN settings of the inverters are used. If the WLAN module is plugged onto another inverter, the WLAN connection must be set up again because the replugging causes a change of the network name.

For using the smartphone as "Smart Keypad", the WLAN module can be configured such that the WLAN settings are saved locally in the WLAN module and only these settings are used. In this "standalone" mode, the WLAN module remains permanently coupled to the smartphone because after replugging onto another inverter, the login data for the WLAN network (SSID and password) is the same:

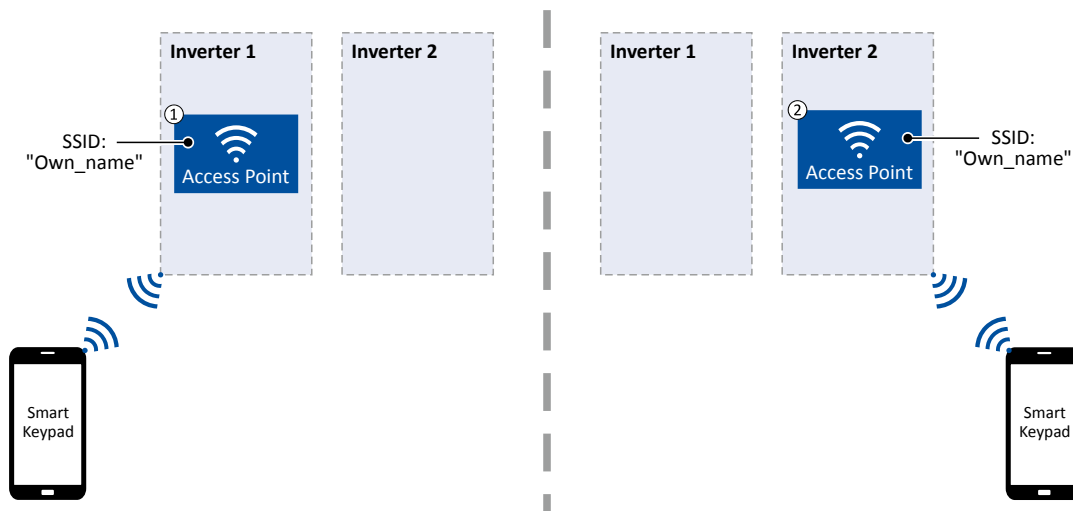

- ① WLAN module is plugged onto the inverter 1. After the connection to the smartphone has been established, the inverter 1 can be diagnosed or parameterised with the Lenze Smart Keypad App.
- ② WLAN module is plugged onto the inverter 2. After the WLAN network is restarted, a connection is established again to the smartphone because the WLAN settings are identical. Now, the inverter 2 can be diagnosed or parameterised with the Lenze Smart Keypad App.

How to configure the WLAN module for a "Smart Keypad" use:

Requirements:

- The WLAN settings of the inverter can be accessed via the Lenze Smart Keypad App or »EASY Starter«.

1. Define your own network name (SSID) in [0x2441:007](#).
2. Define your own password in [0x2441:008](#).
3. Set the selection "Restart with current values [11]" in [0x2440](#).

The defined network name and the password are saved locally in the WLAN module. The WLAN network is restarted with the current settings.

If the WLAN module is then plugged onto another inverter, the settings that are locally saved in the WLAN module are used (irrespective of the WLAN settings of the inverter).

- The active mode ("Inverter" or "Standalone") is displayed in [0x2442:004](#).
- In order to return to the standard mode "Inverter", the selection "Restart with default values [2]" must be set in [0x2440](#).

Configuring the network

Wireless LAN (WLAN)
WLAN access point mode



8.6.3.3 Establishing a direct WLAN connection between Engineering PC and inverter

How to establish a direct WLAN connection to the inverter on the Engineering PC:

Requirements:

- The functional test described in the mounting and switch-on instructions has been completed successfully (without any errors or faults).
- The inverter is ready for operation (supplied with voltage).

Required accessories:

- WLAN module
- PC (with WLAN functionality) and installed »EASY Starter«

1. Plug the WLAN module onto the front of the inverter (interface X16).
2. Open the network settings on the Engineering PC: "Control panel" → "Network and sharing center".
3. Select the "Set up a new connection or network" option under "Change your network settings".

The "Set Up a Connection or Network" dialog box is displayed.

4. Select the "Manually connect to a wireless network" connection option and click the "Next" button.

The "Manually connect to a wireless network" dialog box is displayed.

5. Enter the SSID of the inverter as network name.
6. Select "WPA2-Personal" as safety type.
7. Select "AES" as encryption type.
8. Enter the password as safety key for the WLAN network (default setting "password").
9. Tick "Start this connection automatically".
10. Click "Next".

A note indicates that the connection has been added successfully.

11. Click "Close".
12. Start »EASY Starter«.

The "Add devices" dialog is shown.

13. Select the "Ethernet" connection:

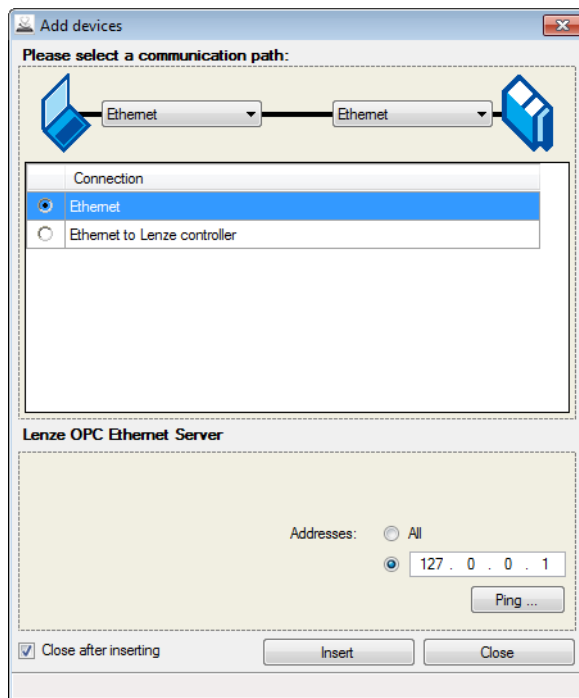

14. Click the **Insert** button.



»EASY Starter« searches for connected devices via the communication path selected.

When the connection has been established successfully, the inverter is displayed in the device list of »EASY Starter«. The inverter parameters can now be accessed via the tabs of »EASY Starter«.



Configuring the network

Wireless LAN (WLAN)
WLAN access point mode

Recommendation: Click the button in the toolbar of the »EASY Starter«  to start visual tracking. This function serves to quickly check whether the connection to the correct device has been established. ▶ [Optical device identification](#)  98

Configuring the network

Wireless LAN (WLAN)
WLAN client mode



8.6.4 WLAN client mode

The WLAN module can be optionally configured as a WLAN client. In this operating mode, the WLAN module can be implemented into an already existing WLAN network.

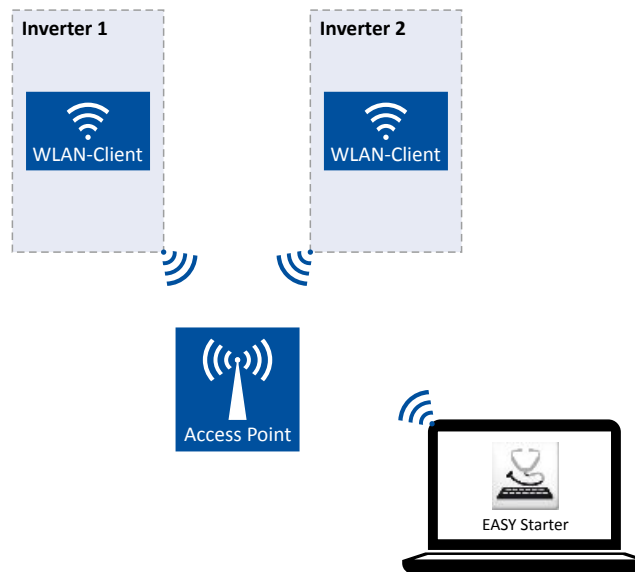

How to configure the WLAN module as WLAN client:

Requirements:

- The WLAN settings of the inverter can be accessed via »EASY Starter«.
- Name (SSID) and password of the external WLAN network are known.

1. Set the selection "Client mode [1]" in [0x2441:006](#).
2. Set the name (SSID) of the external WLAN network in [0x2441:007](#).
3. Set the password of the external WLAN network in [0x2441:008](#).
4. .



Before activating the changed WLAN settings in the next step: Make sure that the name (SSID) and the password of the external WLAN network are set correctly. The restart of the WLAN module in the client mode causes a termination of an existing WLAN connection in the access point mode!

5. Restart the inverter or remove and replug the WLAN module to activate the changed WLAN settings.

The WLAN module now tries as a client to establish a connection to the set external WLAN network.

Notes:

- In the default setting, the WLAN client is configured as DHCP client in [0x2441:004](#).
 - Settings as IP address, subnetwork mask and gateway are automatically made by the DHCP server of the external WLAN network.
 - The active settings are displayed in [0x2442:001](#), [0x2442:002](#) and [0x2442:003](#).
- A static IP configuration can be made via the parameters [0x2441:001](#), [0x2441:002](#) and [0x2441:003](#).

Parameter	Name / value range / [default setting]	Info
0x2441:001	IP address 0 ... [28485824] ... 4294967295 • From version 02.00	Definition of the IP address for the WLAN access point. <ul style="list-style-type: none">• In the client mode, a static IP address can be set here for the WLAN client. In order that the static configuration becomes effective, DHCP must be disabled in 0x2441:004.• Byte order is "Big-Endian": 192.168.178.01 \equiv 0x01B2A8C0 (= 28485824)



Configuring the network

Wireless LAN (WLAN)

WLAN client mode

Parameter	Name / value range / [default setting]	Info
0x2441:002	Netmask 0 ... [16777215] ... 4294967295 • From version 02.00	Definition of the network mask for the WLAN access point. • In the client mode, a static network mask can be set here for the WLAN client. In order that the static configuration becomes effective, DHCP must be disabled in 0x2441:004. • Byte order is "Big-Endian": 255.255.255.0 \equiv 0x00FFFFFF (= 16777215)
0x2441:003	Gateway 0 ... [28485824] ... 4294967295 • From version 02.00	Definition of the gateway for the WLAN access point. • In the client mode, a static gateway can be set here for the WLAN client. In order that the static configuration becomes effective, DHCP must be disabled in 0x2441:004. • Byte order is "Big-Endian": 192.168.178.1 \equiv 0x01B2A8C0 (= 28485824)
0x2442:001	Active IP address • Read only • From version 02.00	Display of the active IP address. • If DHCP is activated, the active IP address usually derives from the configured static IP address of the device.
0x2442:002	Active netmask • Read only • From version 02.00	Display of the active netmask.
0x2442:003	Active gateway • Read only • From version 02.00	Display of the active gateway IP address.
0x2448:001	WLAN status: Connection time • Read only • From version 02.00	Display of the connection time in [s] since the current connection was established.
0x2448:002	WLAN status: Number of connections • Read only • From version 02.00	In access point mode: Display of the number of currently connected clients. In client mode: 0 \equiv not connected; 1 \equiv connected with external WLAN network.
0x2448:003	WLAN status: Rx frame counter • Read only • From version 02.00	Display of the number of request received via WLAN.
0x2448:004	WLAN status: Error statistics • Read only • From version 02.00	Display of the quality of the WLAN connection. A display value > 0 indicates communication problems.



9 Configuring the process controller

By means of the process controller, a process variable can be regulated, for instance the pressure of a pump. The process controller is also referred to as "PID controller" (PID controller = proportional, integral and differential controller).

The process controller is part of a closed control loop. The variable to be influenced (controlled variable) is measured continuously by means of a sensor and supplied to the inverter as an analog signal (actual value) which, in the inverter, is then compared to the reference value (setpoint). The system deviation resulting therefrom is supplied to the process controller which, on this basis, decelerates or accelerates the motor speed according to the desired dynamic performance of the control loop, so that, for instance, a pump always generates the desired pressure.

Connection plan (example)

The following sample connection plan shows the control of a pump ①. The feedback of the variable (here: pressure) takes place via a pressure transducer ② connected to the analog input 1.

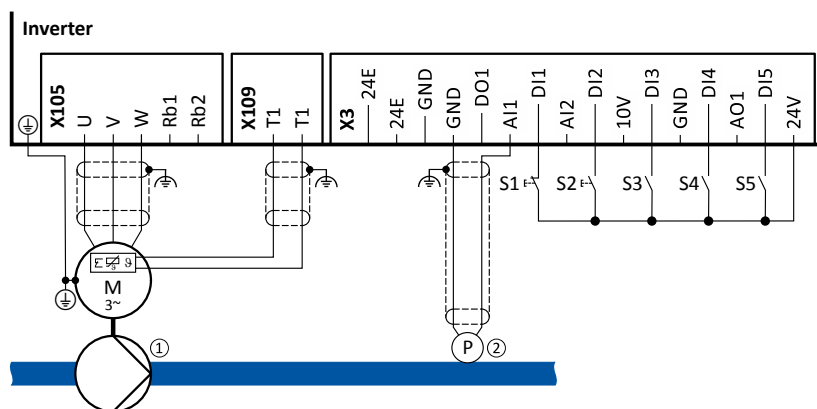

The digital inputs can be used to activate functions of the process controller. The specific assignment of the digital inputs and type of the contacts (switches or buttons, normally-closed contacts or normally-open contacts) depends on the application.

General information on the setting

- The basic setting of the process controller is described in the following subchapter.
 - ▶ [Basic process controller settings](#) 208
- Optionally, the motor can be put into an energy-saving idle state if no power is required.
 - ▶ [Process controller idle state](#) 214
- The rinsing function which can be activated in addition accelerates the motor in idle state to a defined speed at regular intervals. The rinsing of a pipe system with a pump that has been in an inactive state for a longer period is a typical application.
 - ▶ [Process controller rinse function](#) 215



9.1 Basic process controller settings

The process controller is set in two steps:

1. Basic settings
2. Fine adjustment of the PID controller for an optimum control mode

Basic settings

Based on the default setting, we recommend the following proceeding:

1. Activate PID control: Set the desired operating mode (normal or reverse operation) in [0x4020:001 \(P600.01\)](#).
2. If the feedback of the variable is to take place via analog input 2 instead of analog input 1: Set [0x4020:002 \(P600.02\)](#) = "analog input 2 [2]".
3. Configure used analog input:
 - Configure input range.
 - Configure setting range for the PID control.
 - Adapt filter time to minimise impacts of the noise on the variable.
 - Set monitoring response to "No response [0]".
 - ▶ [Configuration of analog inputs](#) 349
4. If a (temporary) change-over to a speed-controlled operation is to be possible via a digital input:
 - Assign a free digital input to the control function "Deactivate PID controller" in [0x2631:045 \(P400.45\)](#). As long as the digital input provides a TRUE signal, the PID control is ignored and the motor is driven in a speed-controlled way.
 - Set acceleration time [0x4021:001 \(P606.01\)](#) and deceleration time [0x4021:002 \(P606.02\)](#) for speed-controlled drive control.
5. Select the standard setpoint source for the reference value in [0x2860:002 \(P201.02\)](#).
 - Functions for setpoint change-over can be used as well. ▶ [Setpoint change-over](#) 313
 - The keypad setpoint can be preset in [0x2601:002 \(P202.02\)](#).
 - If process controller presets are used, they have to be set in [0x4022:001 \(P451.01\)](#) ... [0x4022:008 \(P451.08\)](#).
 - If the analog input is used as setpoint source, it must be configured accordingly. ▶ [Configuration of analog inputs](#) 349
 - If the motor potentiometer is used as setpoint source, this function must be configured accordingly. ▶ [Motor potentiometer setpoint source \(MOP\)](#) 325
6. Set the speed range to be controlled in [0x4020:003 \(P600.03\)](#).
7. Try out the following parameters with the default setting and only adapt them if required:
 - [0x404B \(P604.00\)](#): Setpoint ramp
 - [0x404C:001 \(P607.01\)](#): Acceleration time for showing the process controller influence
 - [0x404C:002 \(P607.02\)](#): Deceleration for hiding the process controller influence
8. Diagnostics: Check current reference value and feedback of the variable:
 - The current reference value (setpoint) is displayed in [0x401F:001 \(P121.01\)](#).
 - The current variable (actual value) is displayed in [0x401F:002 \(P121.02\)](#).

After the basic setting of the process controller has been carried out, a fine adjustment of the PID controller must be executed for an optimum control mode (see the following section).

Configuring the process controller

Basic process controller settings



Fine adjustment of the PID controller

The dynamics of the PID controller is parameterised based on the gain of the P component [0x4048 \(P601.00\)](#), the reset time for the I component [0x4049 \(P602.00\)](#) and the gain of the D component [0x404A \(P603.00\)](#). In the default setting, the process controller operates as PI controller, the D component is deactivated.

Basics

- If only the P component is used and the system operates in a steady-state status (reference value is constant and process variable is controlled to a fixed value), a certain system deviation always continues to exist. This remaining system deviation is also called "stationary deviation".
- The I component ensures that no permanent system deviation remains. Here, the reset time [0x4049 \(P602.00\)](#) determines how much the duration of the control deviation influences the control. A high reset time means a lower influence of the I component and vice versa.
- The D component does not respond to the height of the system deviation but to their rate of change only. The D component acts as a "damper" for overshoots. Overshoots may occur if the control tries to respond quickly to changes in the system deviation or the reference value. Thus, the D component reduces the risk of instabilities due to overshoots.



For most applications, the setting of the gain of the P component and the reset time for the I component is sufficient for the fine adjustment. The setting of the gain of the D component may be required for a further stabilisation of the system especially if a quick response to system deviations is to take place.

Execute fine adjustment:

1. Set the reset time for the I component to 6000 ms in [0x4049 \(P602.00\)](#) to deactivate the I component.
 - With this setting and the default setting of [0x404A \(P603.00\)](#), the process controller operates as P controller.
2. Increase gain of the P component step by step in [0x4048 \(P601.00\)](#) until the system gets instable.
3. Reduce gain again until the system is stable again.
4. Reduce gain by another 15 %.
5. Set reset time for the I component in [0x4049 \(P602.00\)](#).
 - With this setting it should be noted that a too low reset time may cause overshoots, especially in case of high steps of the system deviation.
6. Set optional gain of D component in [0x404A \(P603.00\)](#).
 - With this setting it should be noted that the D component responds very sensitively to electrical disturbance on the feedback as well as digitisation errors.



Internal signal flow

The following illustration shows the internal signal flow of the process controller (without the additional functions "idle state" and "rinsing function"):

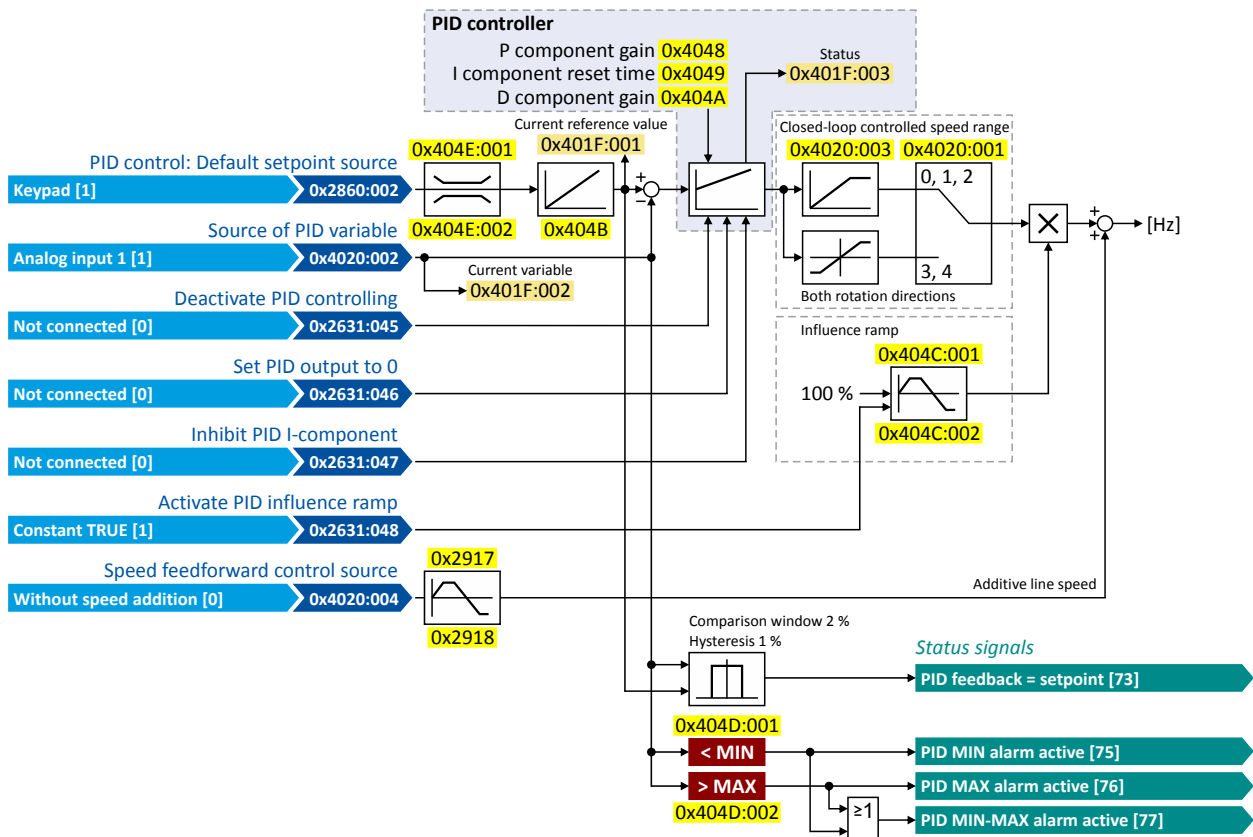

Control functions

The flexible I/O configuration serves to configure different control functions for the process controller:

- 0x2631:045 (P400.45): Deactivate PID controller
- 0x2631:046 (P400.46): Set process controller output to 0
- 0x2631:047 (P400.47): Inhibit process controller I-component
- 0x2631:048 (P400.48): Activate process controller influence ramp

For details see chapter "Process controller function selection". [344](#)

Status signals for configurable outputs

The process controller provides different internal status signals. These status signals can be assigned to the relay, the digital outputs or the NetWordOUT1 status word.

For details see chapter "Configuration of digital outputs". [355](#)

Configuring the process controller

Basic process controller settings



Parameter	Name / value range / [default setting]	Info
0x4020:001 (P600.01)	Process controller: Operating mode (Process control.: Operating mode)	Selection of the process controller operating mode.
	0 Inhibited	Process controller deactivated.
	1 Normal operation	The setpoint is higher than the fed back variable (actual value). If the system deviation increases, the motor speed is increased. Example: pressure-controlled booster pumps (increase in the motor speed produces an increase in pressure.)
	2 Reverse operation	The setpoint is lower than the fed back variable (actual value). If the system deviation increases, the motor speed is increased. Example: temperature-controlled cooling water pump (increase in motor speed produces decrease in temperature.)
	3 Normal bi-directional	The direction of rotation corresponds to the sign of the system deviation. If the system deviation increases, the motor speed is increased.
0x4020:002 (P600.02)	4 Reverse bi-directional	A negative system deviation causes a positive direction of rotation. If the system deviation increases, the motor speed is increased.
	Process controller: PID process variable (Process control.: PID process var.)	Selection of the source via which the feedback of the controlled variable (actual value) for the process controller is effected.
	1 Analog input 1	
	2 Analog input 2	
	3 DC-bus voltage • From version 02.00	
0x4020:003 (P600.03)	4 Motor Current • From version 02.00	
	5 Network • From version 02.00	
0x4020:003 (P600.03)	Process controller: Closed-loop controlled speed range (Process control.: PID speed range) 0 ... [100] ... 100 %	Setting of the maximum output frequency up to which the process controller carries out regulation. • 100 % ≡ upper frequency limit value 0x2916 (P211.00) .
0x4020:004 (P600.04)	Process controller: Speed feedforward control source (Process control.: PID line speed)	Optional selection of a speed feedforward control source for the process controller.
	0 Without speed addition	• Is advisable, for instance, for dancer position controls if the motor speed must not fall below line speed (process controller output value = line speed + controlled motor speed). • Standard applications usually do not require a speed feedforward control; therefore it is deactivated in the default setting.
	1 Keypad frequency setpoint	
	2 Analog input 1	
	3 Analog input 2	
	4 Frequency preset 1	
	5 Frequency preset 2	
	6 Frequency preset 3	
	7 Frequency preset 4	
8 Network		
0x4021:001 (P606.01)	PID speed operation: Acceleration time (PID speed op.: Accel. time) 0.0 ... [1.0] ... 3600.0 s	Acceleration time for (temporary) speed-controlled drive control in process controller mode. • The acceleration time takes effect at the output of the process controller.
0x4021:002 (P606.02)	PID speed operation: Deceleration time (PID speed op.: Decel. time) 0.0 ... [1.0] ... 3600.0 s	Deceleration time for (temporary) speed-controlled drive control in process controller mode. • The deceleration time takes effect at the output of the process controller.
0x4048 (P601.00)	PID P-component (PID P-component) 0.0 ... [5.0] ... 1000.0 %	Output frequency of the process controller per 1 % system deviation. • 100 % ≡ maximum frequency 0x2916 (P211.00) .
0x4049 (P602.00)	PID I-component (PID I-component) 20 ... [400] ... 6000 ms	Reset time for system deviation. • With the setting "6000 ms", the I component is deactivated. • The I component can also be deactivated via the "Inhibit process controller I-component" 0x2631:047 (P400.47) function.
0x404A (P603.00)	PID D-component (PID D-component) 0.0 ... [0.0] ... 20.0 s	D component, does not respond to the rate of the system deviation, but only to its rate of change.
0x404B (P604.00)	PID setpoint ramp (PID setp.ramp) 0.0 ... [20.0] ... 100.0 s	Acceleration time and deceleration time for the process controller setpoint, relating to the entire setting range of the process controller.



Configuring the process controller

Basic process controller settings

Parameter	Name / value range / [default setting]	Info
0x404C:001 (P607.01)	PID influence: Acceleration time for showing (PID influence: Show time) 0.0 ... [5.0] ... 999.9 s	If the trigger assigned in 0x2631:048 (P400.48) of the "Activate process controller influence ramp" function is TRUE, the influence of the process controller is shown by means of a ramp with the acceleration time set here.
0x404C:002 (P607.02)	PID influence: Deceleration time for masking out (PID influence: Mask out time) 0.0 ... [5.0] ... 999.9 s	If the trigger assigned in 0x2631:048 (P400.48) of the "Activate process controller influence ramp" function is FALSE, the influence of the process controller is hidden via a ramp with the deceleration time set here.
0x404D:001 (P608.01)	PID alarms: MIN alarm threshold (PID alarms: MIN alarm thrsh.) -300.00 ... [0.00] ... 300.00 PID unit	Trigger threshold for the status signal "PID MIN alarm active [75]". <ul style="list-style-type: none"> The "PID MIN alarm active [75]" status signal is TRUE if the fed back variable (with activated PID control) is lower than the threshold set here. The status signal can be assigned to the relay, a digital output of the NetWordOUT1 status word. ▶ Configuration of digital outputs 355
0x404D:002 (P608.02)	PID alarms: MAX alarm threshold (PID alarms: MAX alarm thrsh.) -300.00 ... [100.00] ... 300.00 PID unit	Trigger threshold for the status signal "PID MAX alarm active [76]". <ul style="list-style-type: none"> The "PID MAX alarm active [76]" status signal is TRUE if the fed back variable (with activated PID control) is higher than the threshold set here. The status signal can be assigned to the relay, a digital output of the NetWordOUT1 status word. ▶ Configuration of digital outputs 355
0x404E:001 (P605.01)	PID setpoint limits: Minimum setpoint (PID setp. limit: Minimum setpoint) -300.00 ... [-300.00] ... 300.00 PID unit	Minimum value of the process controller setpoint.
0x404E:002 (P605.02)	PID setpoint limits: Maximum setpoint (PID setp. limit: Maximum setpoint) -300.00 ... [300.00] ... 300.00 PID unit	Maximum value of the process controller setpoint.

Configuring the process controller

Basic process controller settings



Parameter	Name / value range / [default setting]	Info
0x2860:002 (P201.02)	PID control: Default setpoint source (Std. setpoints: PID setp. src.)	Selection of the standard setpoint source for the reference value of the PID control. <ul style="list-style-type: none"> The selected standard setpoint source is always active with an activated PID control when no setpoint change-over to another setpoint source via corresponding triggers/functions is active.
	1 Keypad	The setpoint is specified locally by the keypad. <ul style="list-style-type: none"> Default setting: 0x2601:002 (P202.02) Use the ↑ and ↓ navigation keys to change the keypad setpoint (also during running operation).
	2 Analog input 1	The setpoint is specified analogously via X3/AI1. ▶ Analog input 1 349
	3 Analog input 2	The setpoint is specified analogously via X3/AI2. ▶ Analog input 2 353
	5 Network	The setpoint is specified via network. Configuring the network 136
	11 PID preset 1	For the setpoint selection, preset values can be parameterised and selected. ▶ Setpoint source of preset setpoints 320
	12 PID preset 2	
	13 PID preset 3	
	14 PID preset 4	
	15 PID preset 5	
	16 PID preset 6	
	17 PID preset 7	
	18 PID preset 8	
	31 Segment preset 1 • From version 02.00	
	32 Segment preset 2 • From version 02.00	
	33 Segment preset 3 • From version 02.00	
	34 Segment preset 4 • From version 02.00	
	35 Segment preset 5 • From version 02.00	
	36 Segment preset 6 • From version 02.00	
37 Segment preset 7 • From version 02.00		
38 Segment preset 8 • From version 02.00		
50 Motor potentiometer	The setpoint is generated by the "Motor potentiometer" function. ▶ Motor potentiometer setpoint source (MOP) 325	
0x401F:003 (P121.03)	Process controller diagnostics: Status (PID diagnostics: PID status) • Read only	Bit-coded status display of the process controller.
	Bit 0 Process controller off	
	Bit 1 PID output set to 0	
	Bit 2 PID I-component set to 0	
	Bit 3 PID influence shown	
	Bit 4 Setpoint = actual value	
	Bit 5 Idle state active	
	Bit 6 Reserved	
	Bit 7 Reserved	



Configuring the process controller

Process controller - idle state and rinse function
Process controller idle state

9.2 Process controller - idle state and rinse function

9.2.1 Process controller idle state

If the PID control is activated, this function sets the drive in process controller mode to an energy-saving idle state when no power is required.

Details

A typical application for this function is a booster pump for water in a high-rise building. If no tenant opens the water tap or uses the shower for a longer period of time, the pump changes to the energy-saving idle state. This usually happens at night. The idle state automatically ends as soon as a tenant opens the tap again. The pumps operates normally again until the condition for the idle state is pending again.

The conditions for activating and terminating the idle state can be set independently of one another:

- [0x4023:001 \(P610.01\)](#): Condition for activating the idle state
- [0x4023:006 \(P610.06\)](#): Condition for terminating the idle state

Parameter	Name / value range / [default setting]	Info
0x4023:001 (P610.01)	PID sleep mode: Activation (PID sleep mode: Activation)	Selection of the condition for activating the idle state.
	0 Disabled	Idle state deactivated.
	1 Setpoint < threshold	Activation of idle state if process controller correcting variable < frequency threshold 0x4023:003 (P610.03) longer than the deceleration time 0x4023:005 (P610.05) .
	2 Setpoint < threshold OR process variable > feedback threshold	Activation of idle state if <ul style="list-style-type: none"> • Process controller correcting variable < frequency threshold 0x4023:003 (P610.03) longer than the deceleration time 0x4023:005 (P610.05) OR • fed back variable > feedback threshold 0x4023:004 (P610.04) longer than the deceleration time 0x4023:005 (P610.05).
3 Setpoint < threshold OR process variable < feedback threshold	Activation of idle state if <ul style="list-style-type: none"> • Process controller correcting variable < frequency threshold 0x4023:003 (P610.03) longer than the deceleration time 0x4023:005 (P610.05) OR • fed back variable < feedback threshold 0x4023:004 (P610.04) longer than the deceleration time 0x4023:005 (P610.05). 	
0x4023:002 (P610.02)	PID sleep mode: Stop method (PID sleep mode: Stop method)	Selection of the stop method after activation of the idle state.
	0 Coasting	The motor becomes torqueless (coasts down to standstill).
	1 Deceleration to standstill	The motor is brought to a standstill with deceleration time 1 (or deceleration time 2, if activated). <ul style="list-style-type: none"> • Deceleration time 1 can be set in 0x2918 (P221.00). • Deceleration time 2 can be set in 0x291A (P223.00). ▶ Frequency limits and ramp times □ 92
2 Stop method set	The stop method set in 0x2838:003 (P203.03) is used.	
0x4023:003 (P610.03)	PID sleep mode: Frequency threshold (PID sleep mode: Freq. thresh.) 0.0 ... [0.0] ... 599.0 Hz	Frequency threshold for the activation of the idle state. <ul style="list-style-type: none"> • For comparing "process controller correcting variable < frequency threshold 0x4023:003 (P610.03)" in case of selection 1 ... 3 in 0x4023:001 (P610.01).
0x4023:004 (P610.04)	PID sleep mode: Feedback threshold (PID sleep mode: Feedback thresh.) -300.00 ... [0.00] ... 300.00 PID unit	Feedback threshold for the activation of the idle state. <ul style="list-style-type: none"> • For comparing "fed back variable > feedback threshold 0x4023:004 (P610.04)" in case of selection 2 in 0x4023:001 (P610.01). • For comparing "fed back variable < feedback threshold 0x4023:004 (P610.04)" in case of selection 3 in 0x4023:001 (P610.01).
0x4023:005 (P610.05)	PID sleep mode: Delay time (PID sleep mode: Delay time) 0.0 ... [0.0] ... 300.0 s	Minimum time for which the respective threshold must be underrun or exceeded before the idle state is activated.

Configuring the process controller

Process controller - idle state and rinse function
Process controller rinse function



Parameter	Name / value range / [default setting]	Info
0x4023:006 (P610.06)	PID sleep mode: Recovery (PID sleep mode: Recovery)	Selection of the condition for terminating the idle state.
	0 Setpoint > threshold OR system deviation > bandwidth	Completion of idle state if <ul style="list-style-type: none"> frequency setpoint > (frequency threshold 0x4023:003 (P610.03) + 2 Hz hysteresis) OR in case of active PID control system deviation > bandwidth 0x4023:007 (P610.07) and bandwidth 0x4023:007 (P610.07) <> 0.
	1 Process variable < recovery threshold	Completion of idle state if the controlled variable fed back < completion threshold 0x4023:008 (P610.08).
	2 Process variable > recovery threshold	Completion of idle state if the controlled variable fed back > completion threshold 0x4023:008 (P610.08).
0x4023:007 (P610.07)	PID sleep mode: Bandwidth (PID sleep mode: Bandwidth) 0.00 ... [0.00] ... 300.00 PID unit	Range around the process controller setpoint for terminating the idle state.
0x4023:008 (P610.08)	PID sleep mode: Recovery threshold (PID sleep mode: Recovery thresh.) -300.00 ... [0.00] ... 300.00 PID unit	Termination threshold for idle state.

9.2.2 Process controller rinse function

This function accelerates the motor in idle state of the process controller at regular intervals to a defined speed.

Details

A typical application for this function is the rinsing of a pipe system with a pump that has been in an inactive state for a longer period to prevent deposits.

- In order to activate the rinsing function, set the selection "Enabled [1]" in 0x4024:001 (P615.01).
- The following diagram demonstrates the function:

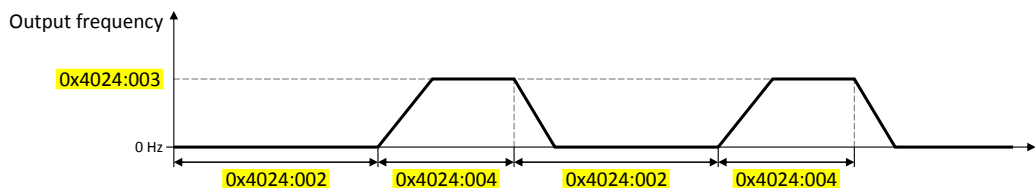

- The rinsing function uses the ramp times set for the "MS: Velocity mode". ▶ [Frequency limits and ramp times](#) 92

Parameter	Name / value range / [default setting]	Info
0x4024:001 (P615.01)	Automatic rinsing: Rinsing in idle state (Auto-rinsing: Rinsing in idle)	1 = activate automatic rinsing in idle state.
	0 Inhibited	
	1 Enabled	
0x4024:002 (P615.02)	Automatic rinsing: Rinse interval (Auto-rinsing: Rinse interval) 0.0 ... [30.0] ... 6000.0 min	Time interval between two rinsing processes.
0x4024:003 (P615.03)	Automatic rinsing: Rinse speed (Auto-rinsing: Rinse speed) -599.0 ... [0.0] ... 599.0 Hz	Speed setpoint for rinse function.
0x4024:004 (P615.04)	Automatic rinsing: Rinse period (Auto-rinsing: Rinse period) 0.0 ... [0.0] ... 6000.0 s	Duration of a rinsing process.



10 Additional functions

- [Device Commands](#) 217
- [Keypad](#) 223
- [DC braking](#) 224
- [Brake energy management](#) 229
- [Load loss detection](#) 232
- [Access protection](#) 233
- [Favorites](#) 242
- [Parameter change-over](#) 247
- [Device profile CiA 402](#) 262
- [Holding brake control](#) 266
- [Flying restart circuit](#) 278
- [Timeout für fault reaction](#) 280
- [Automatic restart](#) 281
- [Mains failure control](#) 282
- [Firmware download](#) 287
- [Additive voltage impression](#) 288
- [Parameter for engineering tools](#) 290

Additional functions

Device Commands
Reset parameters to default



10.1 Device Commands

Device commands are commands for calling organisational functions of the inverter, e.g. saving and loading of parameter settings, or restoring the default setting.

10.1.1 Reset parameters to default

With the "Load default settings" device command, all parameters can be reset to the default setting.



By executing this device command, all parameter settings made by the user are lost!

Details

- All parameters in the RAM memory of the inverter are set to the default setting stored in the firmware of the inverter. (The persistent parameters in the memory module remain unaffected by this measure.)

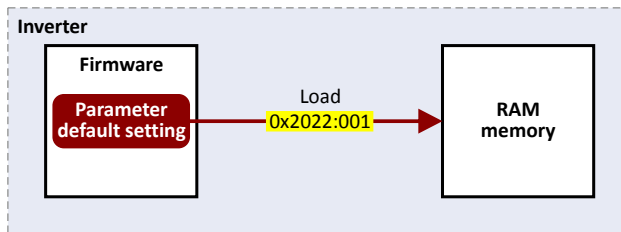

- Afterwards the inverter can be parameterised again on the basis of this initial state.
- Typical application: incorrect or unknown parameter settings.
- The device command only has an effect on the RAM. For a permanent acceptance of the changes made, the data must be saved in the memory module. [▶ Saving/loading the parameter settings](#) □ 218

Parameter	Name / value range / [default setting]	Info
0x2022:001 (P700.01)	Device commands: Load default settings (Device commands: Load def. sett.) <ul style="list-style-type: none"> Setting can only be changed if the inverter is inhibited. 	<ul style="list-style-type: none"> 1 ≙ reset all parameters in the RAM memory of the inverter to the default setting that is stored in the inverter firmware. All parameter changes made by the user are lost during this process! It may take some seconds to execute the task. When the task has been executed successfully, the value 0 is shown. Loading parameters has a direct effect on the cyclic communication: The data exchange for control is interrupted and a communication error is generated.
	0 Off / ready	Only status feedback.
	1 On / start	Execute device command.
	2 In progress	Only status feedback.
	3 Action cancelled	
	4 No access	
	5 No access (Inverter disabled)	



10.1.2 Saving/loading the parameter settings

If parameter settings of the inverter are changed, these changes at first are only made in the RAM memory of the inverter. In order to save the parameter settings with mains failure protection, the inverter is provided with a pluggable memory module and corresponding device commands.

Details

The memory module is provided with two memories, the user memory and the OEM memory.

User memory

The user memory is used as power-failure-proof storage of parameter settings made by the user during commissioning/operation.

- The SET display is blinking on the keypad if a parameter setting has been changed but has not been saved in the memory module with mains failure protection. In order to save parameter settings in the user memory of the memory module, press the keypad "Enter" key > 3 s.

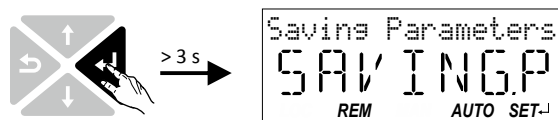

- Parameter settings carried out with »EASY Starter« or via network must be explicitly saved in the user memory by means of the "Save user data" device command, so that the changes carried out are not lost when the mains of the inverter are switched.
- Saving can also be made in the »EASY Starter« via the button  or the <F6> function key.
- The device command "Load user data" serves to reload the data from the user memory into the RAM.

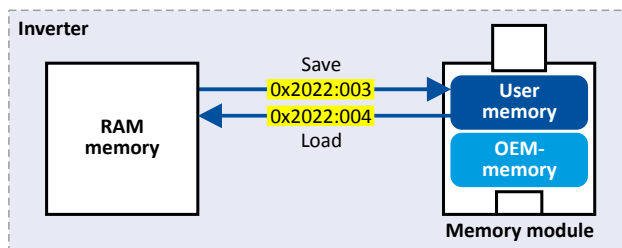

OEM memory

The OEM memory is provided for the storage of customised parameter settings by the OEM/mechanical engineer. If the user carries out parameter settings with the keypad, they are always saved in the user memory if the keypad Enter key is clicked longer than 3 s. The OEM memory remains unaffected by these changes.

- With the "Load OEM data" device command, the parameter settings preconfigured by the OEM/mechanical engineer can be reloaded to the RAM memory of the inverter anytime, if required.
- Parameter settings can only be stored in the OEM memory with »EASY Starter« or via network. This explicitly requires execution of the "Save OEM data" device command. At the same time, the parameter settings are stored in the user memory.

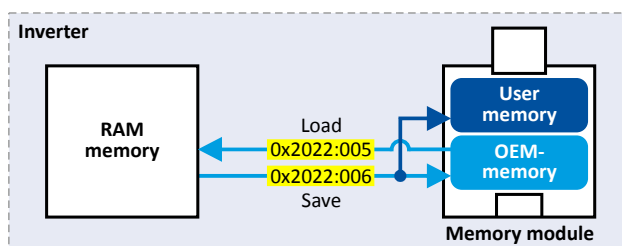

Additional functions

Device Commands

Saving/loading the parameter settings



Response after initial switch-on of the inverter

After switch-on, the inverter first tries to load the parameter settings stored in the user memory. If the user memory is empty or damaged, an error message is output and the user must intervene:

- Option 1 = user memory empty: → default setting is loaded automatically from the firmware → data are saved automatically in the user memory of the memory module.
- Option 2 = user- memory damaged: → Error message → default setting is loaded automatically → data are saved automatically in the user memory of the memory module.
- Option 3 = OEM memory empty/damaged: → error message → data are loaded automatically from the user memory of the memory module.

Parameter	Name / value range / [default setting]	Info
0x2022:003 (P700.03)	Device commands: Save user data (Device commands: Save user data)	1 = save current parameter settings in the main memory of the memory module with mains failure protection. <ul style="list-style-type: none"> • It may take some seconds to execute the task. When the task has been executed successfully, the value 0 is shown. • Do not switch off the supply voltage during the saving process and do not unplug the memory module from the inverter! • When the inverter is switched on, all parameters are automatically loaded from the main memory of the memory module to the RAM memory of the inverter.
	0 Off / ready	Only status feedback.
	1 On / start	Execute device command.
	2 In progress	Only status feedback.
	3 Action cancelled	
	4 No access	
5 No access (Inverter disabled)		
0x2022:004 (P700.04)	Device commands: Load user data (Device commands: Load user data) <ul style="list-style-type: none"> • Setting can only be changed if the inverter is inhibited. 	1 = load data from the main memory of the memory module to the RAM memory of the inverter. <ul style="list-style-type: none"> • When the device command has been executed successfully, the value 0 is shown. • Loading parameters has a direct effect on the cyclic communication: The data exchange for control is interrupted and a communication error is generated.
	0 Off / ready	Only status feedback.
	1 On / start	Execute device command.
	2 In progress	Only status feedback.
	3 Action cancelled	
	4 No access	
5 No access (Inverter disabled)		
0x2022:005 (P700.05)	Device commands: Load OEM data (Device commands: Load OEM data) <ul style="list-style-type: none"> • Setting can only be changed if the inverter is inhibited. 	1 = load data from the OEM memory of the memory module to the RAM memory of the inverter. <ul style="list-style-type: none"> • When the device command has been executed successfully, the value 0 is shown. • Loading parameters has a direct effect on the cyclic communication: The data exchange for control is interrupted and a communication error is generated.
	0 Off / ready	Only status feedback.
	1 On / start	Execute device command.
	2 In progress	Only status feedback.
	3 Action cancelled	
	4 No access	
5 No access (Inverter disabled)		



Additional functions

Device Commands Device commands for parameter change-over

Parameter	Name / value range / [default setting]	Info
0x2022:006 (P700.06)	Device commands: Save OEM data (Device commands: Save OEM data)	1 = save current parameter settings in the OEM memory of the memory module with mains failure protection. <ul style="list-style-type: none"> At the same time, the parameter settings are saved in the main memory of the memory module. After successful execution, the value 0 is shown.
	0 Off / ready	Only status feedback.
	1 On / start	Execute device command.
	2 In progress	Only status feedback.
	3 Action cancelled	
	4 No access	
5 No access (Inverter disabled)		
0x2829 (P732.00)	Automatic storage in the memory module (Auto-Save EPM)	1 = activate automatic saving of parameters in the memory module. <ul style="list-style-type: none"> With the setting 0, the "Save user data" 0x2022:003 (P700.03) device command must be explicitly executed, or the "Enter" keypad key must be pressed for longer than 3 s to save the current parameter settings in the memory module of the inverter with mains failure protection.
	0 Inhibit	
	1 Enable	

10.1.3 Device commands for parameter change-over

The inverter supports several parameter sets. The parameter set can be selected by means of the device commands "Load parameter set 1" ... "Load parameter set 4".

DANGER!

Changed parameter settings can become effective immediately depending on the activating method set in [0x4046 \(P755.00\)](#).

The possible consequence is an unexpected response of the motor shaft while the inverter is enabled.

- ▶ If possible, only carry out parameter changes while the inverter is disabled.
- ▶ Certain device commands or settings which might cause a critical state of the drive behaviour can generally only be carried out when the inverter is inhibited.

Details

The "parameter change-over" function provides a change-over between four sets with different parameter values for up to 32 freely selectable parameters. For details on the compilation of the parameters and setting of the value sets, see the chapter "[Parameter change-over](#)".

[📖 247](#)

The change-over via the device commands depends on the activation method set in [0x4046 \(P755.00\)](#):

- Activation method = 1 or 3: Change-over takes place immediately.
- Activation method = 0 or 2: The respective device command is only executed if the inverter is disabled.

Parameter	Name / value range / [default setting]	Info
0x2022:007 (P700.07)	Device commands: Load parameter set 1 (Device commands: Load par. set 1)	1 = load value set 1 of the "Parameter change-over" function. <ul style="list-style-type: none"> The parameters specified in 0x4041/1...32 are set to the values set in 0x4042/1...32. After successful execution, the value 0 is shown. ▶ Parameter change-over 📖 247
	0 Off / ready	Only status feedback.
	1 On / start	Execute device command.
	2 In progress	Only status feedback.
	3 Action cancelled	
	4 No access	
5 No access (Inverter disabled)		

Additional functions

Device Commands
Initialising the network interface



Parameter	Name / value range / [default setting]	Info
0x2022:008 (P700.08)	Device commands: Load parameter set 2 (Device commands: Load par. set 2)	1 = load value set 2 of the "Parameter change-over" function. <ul style="list-style-type: none"> The parameters specified in 0x4041/1...32 are set to the values set in 0x4043/1...32. After successful execution, the value 0 is shown. ▶ Parameter change-over □ 247
	0 Off / ready	Only status feedback.
	1 On / start	Execute device command.
	2 In progress	Only status feedback.
	3 Action cancelled	
	4 No access	
5 No access (Inverter disabled)		
0x2022:009 (P700.09)	Device commands: Load parameter set 3 (Device commands: Load par. set 3)	1 = load value set 3 of the "Parameter change-over" function. <ul style="list-style-type: none"> The parameters specified in 0x4041/1...32 are set to the values set in 0x4044/1...32. After successful execution, the value 0 is shown. ▶ Parameter change-over □ 247
	0 Off / ready	Only status feedback.
	1 On / start	Execute device command.
	2 In progress	Only status feedback.
	3 Action cancelled	
	4 No access	
5 No access (Inverter disabled)		
0x2022:010 (P700.10)	Device commands: Load parameter set 4 (Device commands: Load par. set 4)	1 = load value set 4 of the "Parameter change-over" function. <ul style="list-style-type: none"> The parameters specified in 0x4041/1...32 are set to the values set in 0x4045/1...32. After successful execution, the value 0 is shown. ▶ Parameter change-over □ 247
	0 Off / ready	Only status feedback.
	1 On / start	Execute device command.
	2 In progress	Only status feedback.
	3 Action cancelled	
	4 No access	
5 No access (Inverter disabled)		

10.1.4 Initialising the network interface

When the inverter is switched on, it checks whether the parameter settings stored in the memory module match the network option available in the inverter. If not, the inverter changes to the error status. The error status can only be quit if the currently available network option is accepted as new hardware.

Details

In order to accept the currently available network option as new hardware, [0x2022:027 \(P700.27\)](#) must be set to "1". When this device command is executed, all parameters are initialised for the new network option.

Diagnostic parameters:

- The network option currently configured in the inverter is displayed in [0x231F:001 \(P500.01\)](#).
- The network option currently available in the inverter is displayed in [0x231F:002 \(P500.02\)](#).

Parameter	Name / value range / [default setting]	Info
0x2022:027 (P700.27)	Device commands: Accept new inverter hardware (Device commands: Accept new HW) <ul style="list-style-type: none"> Setting can only be changed if the inverter is inhibited. 	1 = initialise parameters for a new network option.
	0 Off / ready	
	1 On / start	



10.1.5 Delete logbook

By means of the "Delete logbook" device command, all logbook entries can be deleted.

Parameter	Name / value range / [default setting]	Info
0x2022:015 (P700.15)	Device commands: Delete logbook (Device commands: Delete logbook) <ul style="list-style-type: none">Setting can only be changed if the inverter is inhibited.	1 = delete all entries in the logbook.
	0 Off / ready	
	1 On / start	

Additional functions

Keypad
Keypad language selection



10.2 Keypad

For the keypad various settings can be made, which are described in detail in the following subchapters.

10.2.1 Keypad language selection

Parameter	Name / value range / [default setting]	Info
0x2863 (P705.00)	Keypad language selection (KP language)	Language selection for the keypad display.
	0 No language selected	
	1 English	
	2 German	

10.2.2 Keypad setpoint increment

Parameter	Name / value range / [default setting]	Info
0x2862 (P701.00)	Keypad setpoint increment (KP setp. incr.) 1 ... [1] ... 100	<p>Adaptation of the increment for keypad setpoints when a keypad arrow key is pressed once. The value set serves as a multiplier for the preset increments.</p> <p>Preset increments:</p> <ul style="list-style-type: none"> • 0.1 Hz for frequency setpoint 0x2601:001 (P202.01). • 0.01 PUnit for process controller setpoint 0x2601:002 (P202.02). • 1 % for torque setpoint . <p>Notes:</p> <ul style="list-style-type: none"> • With a setting > 1, the option of repeatedly changing the setpoint by pressing the key for a longer time is deactivated. • The setting only has an impact on the keypad setpoints. <p>Example: with the setting "5", the keypad frequency setpoint is increased/decreased by 0.5 Hz every time the key is pressed.</p>

10.2.3 Keypad scaling of speed display

Parameter	Name / value range / [default setting]	Info
0x4002 (P702.00)	Speed display scaling (Scal.speed fact.) 0.00 ... [0.00] ... 650.00	<p>Factor for the scaling of the speed display in 0x400D (P101.00).</p> <ul style="list-style-type: none"> • With the setting "0.00", no scaling takes place. • Example: with the "16.50" and the actual frequency = 50 Hz, 0x400D (P101.00) shows the speed "825 rpm".
0x400D (P101.00)	Scaled actual value (Scaled act value) • Read only: x Units	Display of the current speed in application units.

10.2.4 Keypad status display

During operation, the keypad displays the output frequency of the inverter, or with an active PID control it shows the process controller setpoint. Alternatively, an optional diagnostic parameter can be displayed during operation.

Parameter	Name / value range / [default setting]	Info
0x2864 (P703.00)	Keypad status display (KP status displ.) 0x00000000 ... [0x00000000] ... 0xFFFFFFFF00	<p>0 = normal display depending on the operating mode</p> <ul style="list-style-type: none"> • In case of an active frequency control, the keypad displays the output frequency of the inverter. • In case of active PID control, the keypad displays the current Process controller setpoint in [P-Unit]. <p>As an alternative, an optional diagnostic parameter can be set here, which is to be shown on the keypad during operation.</p> <ul style="list-style-type: none"> • Format: 0xiiii00 (iiii = hexadecimal index, ss = hexadecimal subindex) • The lowest byte is always 0x00. • The keypad can be used to select the desired diagnostics parameter from a list.



10.3 DC braking

The "DC braking" function generates a braking torque by injecting a DC current into the motor. The function can be used to shorten the braking of a load with high mass inertia. Another application is holding the motor shaft either before starting or while stopping.

i NOTICE

Avoid long-time activation of the "DC braking" function with a high braking current or a high braking voltage!

Possible consequence: thermal motor overload.

- ▶ Only use the "DC braking" function in applications in which the load is only exceptionally stopped.
- ▶ Do not activate the "DC braking" function longer than necessary.

Preconditions

The "DC braking" function is only possible if the inverter is enabled.

Details

The function can be used as follows:

1. Automatically when the motor is started.
2. Automatically when the motor is stopped.
3. Manually (via the flexible I/O configuration).

The three options can also be combined, for instance automatic DC braking when starting and stopping the motor.

For further details and configuration examples, see the following chapter:

- ▶ [Example 1: Automatic DC braking when the motor is started](#) 📖 226
- ▶ [Example 2: Automatic DC braking when the motor is stopped](#) 📖 227
- ▶ [Activating DC braking manually](#) 📖 331

Parameter	Name / value range / [default setting]	Info
0x2B84:001 (P704.01)	DC braking: Current (DC braking: Current) 0.0 ... [0.0] ... 200.0 %	Braking current for DC braking. • 100 % ≙ rated motor current 0x6075 (P323.00)
0x2B84:002 (P704.02)	DC braking: Automatic hold time (DC braking: Hold time autom.) 0.0 ... [0.0] ... 999.9 s	Hold time for automatic DC braking. • The "Automatic DC braking" function is active for the time set here.
0x2B84:003 (P704.03)	DC braking: Automatic operating threshold (DC braking: Threshold autom.) 0.0 ... [0.0] ... 599.0 Hz	Operating threshold for automatic DC braking. • With the setting 0, the "Automatic DC braking" function is deactivated.
0x2631:005 (P400.05)	Function list: Activate DC braking (Function list: DC braking) • For possible settings see description for 0x2631:001 (P400.01) . 📖 300	Assignment of a trigger for the "Activate DC braking" function. Trigger = TRUE: Activate DC braking. Trigger = FALSE: Deactivate DC braking. ⚠ CAUTION! DC braking remains active as long as the trigger is set to TRUE. ▶ DC braking 📖 223
	00 Not connected	No trigger assigned (trigger is constantly FALSE).

Additional functions

DC braking
Keypad status display



Parameter	Name / value range / [default setting]	Info
0x2838:001 (P203.01)	Start/stop configuration: Start method (Start/stop cfg: Start method) <ul style="list-style-type: none"> Setting can only be changed if the inverter is inhibited. 	Behaviour after start command.
	0 Normal	After start command, the standard ramps are active. <ul style="list-style-type: none"> Acceleration time 1 can be set in 0x2917 (P220.00). Deceleration time 1 can be set in 0x2918 (P221.00).
	1 DC braking	After start command, the "DC braking" function is active for the time set in 0x2B84:002 (P704.02) . ▶ DC braking □ 223
	2 Flying restart circuit	After the start command, the flying restart circuit is active. The flying restart function makes it possible to restart a coasting motor during operation without speed feedback. Synchronicity between the inverter and motor is coordinated so that the transition to the rotating motor is effected without jerk at the time of connection. ▶ Flying restart circuit □ 278
0x2838:003 (P203.03)	Start/stop configuration: Stop method (Start/stop cfg: Stop method)	Behaviour after the "Stop" command.
	0 Coasting	The motor becomes torqueless (coasts down to standstill).
	1 Standard ramp	The motor is brought to a standstill with deceleration time 1 (or deceleration time 2, if activated). <ul style="list-style-type: none"> Deceleration time 1 can be set in 0x2918 (P221.00). Deceleration time 2 can be set in 0x291A (P223.00). ▶ Frequency limits and ramp times □ 92
	2 Quick stop ramp	The motor is brought to a standstill with the deceleration time set for the "Quick stop" function. <ul style="list-style-type: none"> Deceleration time for quick stop can be set in 0x291C (P225.00). The "quick stop" function can also be activated manually, for instance via a digital input. ▶ Quick stop □ 95



10.3.1 Example 1: Automatic DC braking when the motor is started

In order that the DC braking is automatically active when the motor is started, the start method "DC braking [1]" must be set in `0x2838:001 (P203.01)`.

- The DC braking is carried out with the braking current set in `0x2B84:001 (P704.01)`.
- Only after the hold time `0x2B84:002 (P704.02)` has elapsed, the motor is accelerated to the setpoint.

Parameter	Name	Setting for this example
<code>0x2631:001 (P400.01)</code>	Enable inverter	Digital input 1 [11]
<code>0x2631:002 (P400.02)</code>	Run	Digital input 2 [12]
<code>0x2631:004 (P400.04)</code>	Reset fault	Not connected [0]
<code>0x2838:001 (P203.01)</code>	Start method	DC braking [1]
<code>0x2860:001 (P201.01)</code>	Frequency control: Default setpoint source	Frequency preset 1 [11]
<code>0x2911:001 (P450.01)</code>	Frequency setpoint presets: Preset 1	40 Hz
<code>0x2B84:001 (P704.01)</code>	Current	50 %
<code>0x2B84:002 (P704.02)</code>	Automatic hold time	10 s

Input signals

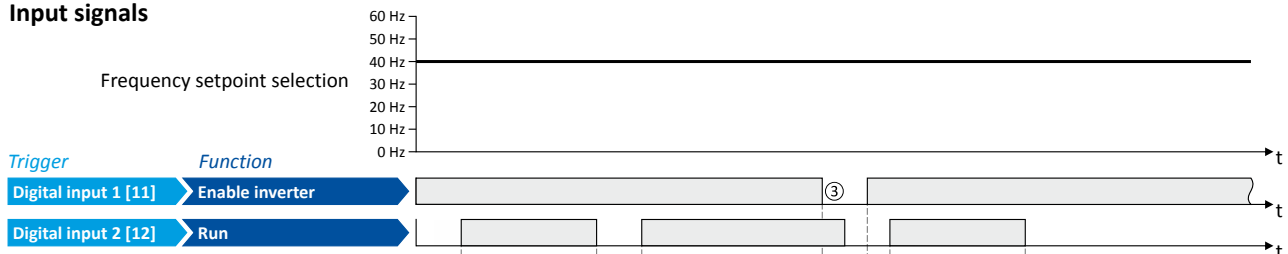

Output signals

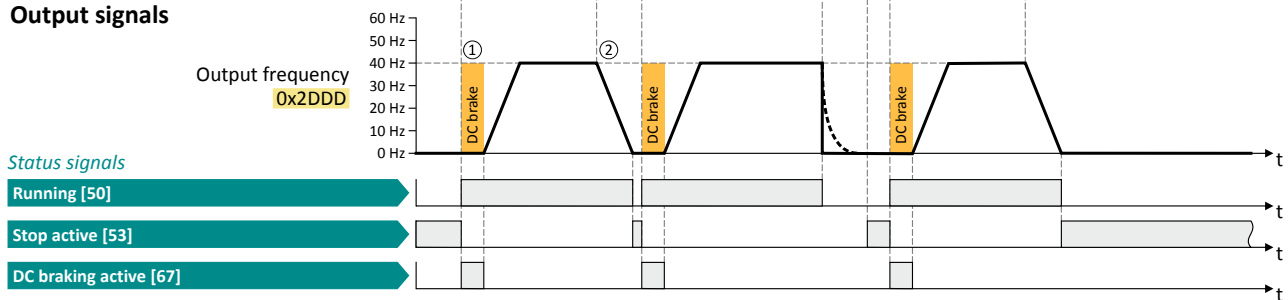

The status signals can be assigned to digital outputs. ▶ [Configuration of digital outputs](#) 355

- ① After the start command, the DC braking is active. Only after the hold time `0x2B84:002 (P704.02)` has elapsed, the motor is accelerated to the setpoint.
- ② The motor is stopped with the stop method set in `0x2838:003 (P203.03)`. In the example: Stop with standard ramp.
- ③ If the inverter is disabled, the motor coasts.

Additional functions

DC braking

Example 2: Automatic DC braking when the motor is stopped



10.3.2 Example 2: Automatic DC braking when the motor is stopped

In order that the DC braking is automatically active when the motor is stopped, the corresponding operating threshold must be set in [0x2B84:003 \(P704.03\)](#).

- After a stop command, the motor is first decelerated as set. Only if the output frequency falls below the set operating threshold, the inverter stops the deceleration and activates DC braking.
- DC braking is carried out with the braking current set in [0x2B84:001 \(P704.01\)](#) for the hold time set in [0x2B84:002 \(P704.02\)](#).
- The exact behaviour depends on the stop method set in [0x2838:003 \(P203.03\)](#).

Stop method = "Standard ramp [1]"

Parameter	Name	Setting for this example
0x2631:001 (P400.01)	Enable inverter	Digital input 1 [11]
0x2631:002 (P400.02)	Run	Digital input 2 [12]
0x2631:004 (P400.04)	Reset fault	Not connected [0]
0x2838:003 (P203.03)	Stop method	Standard ramp [1]
0x2860:001 (P201.01)	Frequency control: Default setpoint source	Frequency preset 1 [11]
0x2911:001 (P450.01)	Frequency setpoint presets: Preset 1	40 Hz
0x2B84:001 (P704.01)	Current	50 %
0x2B84:002 (P704.02)	Automatic hold time	10 s
0x2B84:003 (P704.03)	Automatic operating threshold	15 Hz

Input signals

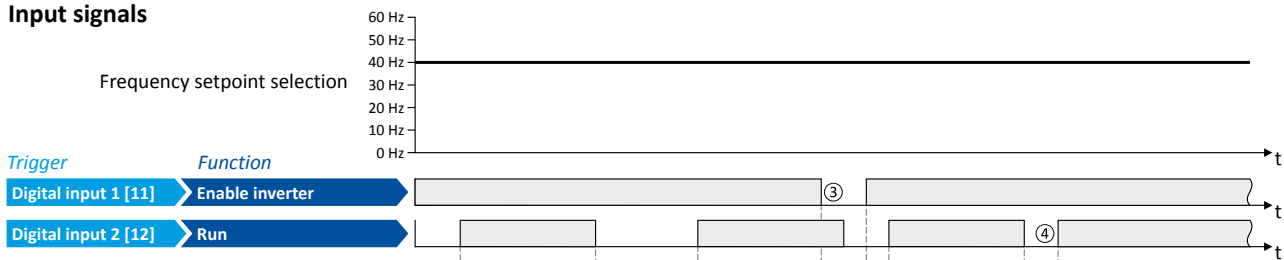

Output signals

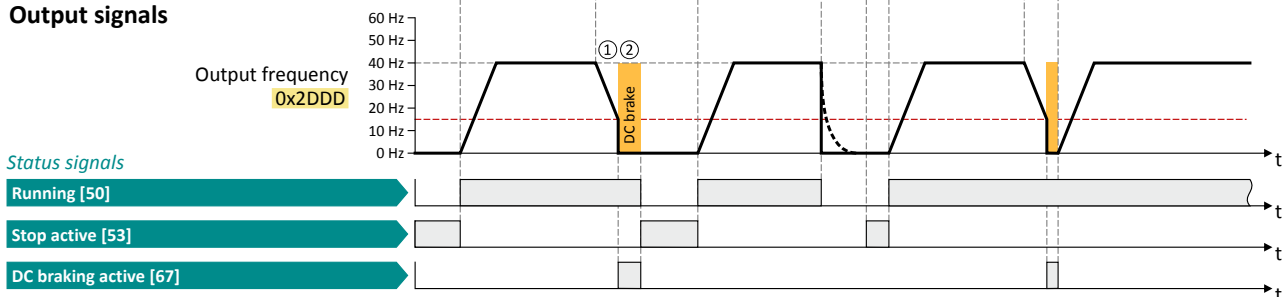

The status signals can be assigned to digital outputs. ▶ [Configuration of digital outputs](#) □ 355

- ① With the stop method "Standard ramp [1]", the motor is first decelerated normally until the value falls below the operating threshold set in [0x2B84:003 \(P704.03\)](#).
- ② The DC braking becomes active for the hold time set in [0x2B84:002 \(P704.02\)](#).
- ③ If the inverter is disabled, the motor coasts. (DC braking is only possible if the inverter is enabled.)
- ④ If there is a new start command within the hold time, the DC braking is cancelled. The motor is accelerated to the setpoint again.



Additional functions

DC braking

Example 2: Automatic DC braking when the motor is stopped

Stop method = "Coasting [0]"

Parameter	Name	Setting for this example
0x2631:001 (P400.01)	Enable inverter	Digital input 1 [11]
0x2631:002 (P400.02)	Run	Digital input 2 [12]
0x2838:003 (P203.03)	Stop method	Coasting [0]
0x2860:001 (P201.01)	Frequency control: Default setpoint source	Frequency preset 1 [11]
0x2911:001 (P450.01)	Frequency setpoint presets: Preset 1	40 Hz
0x2B84:001 (P704.01)	Current	50 %
0x2B84:002 (P704.02)	Automatic hold time	10 s
0x2B84:003 (P704.03)	Automatic operating threshold	15 Hz

Input signals

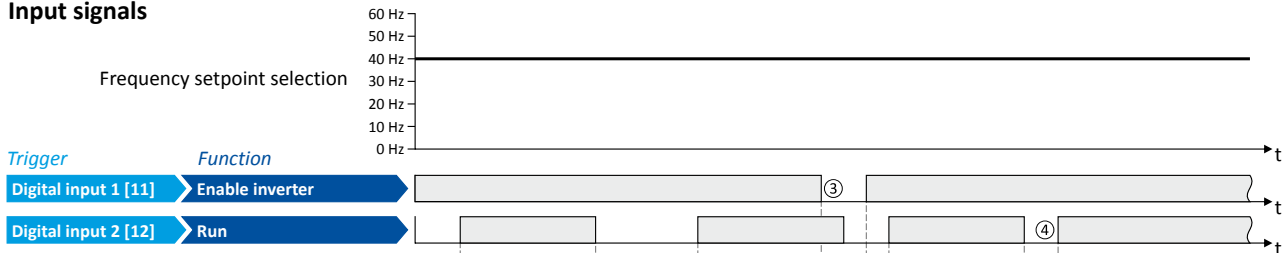

Output signals

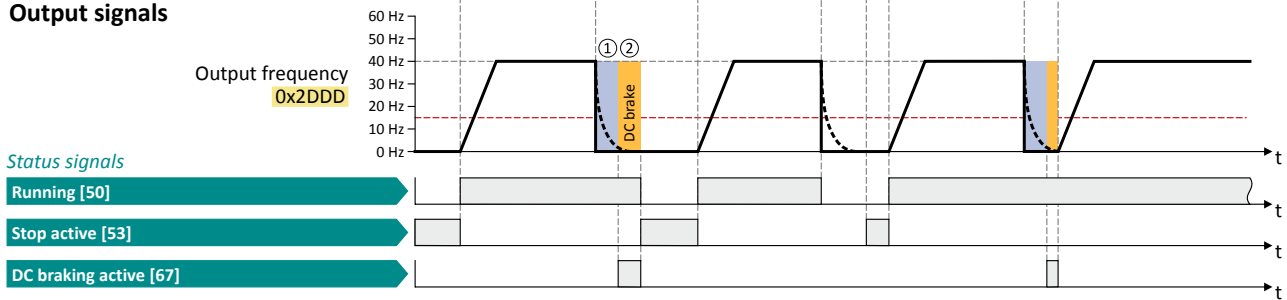

The status signals can be assigned to digital outputs. ▶ [Configuration of digital outputs](#) 355

- ① With the stop method "Coasting [0]", the motor first coasts for a specified time. This "demagnetising time" serves to reduce the induced voltage.
- ② The DC braking becomes active for the hold time set in [0x2B84:002 \(P704.02\)](#).
- ③ If the inverter is disabled, the motor coasts. (DC braking is only possible if the inverter is enabled.)
- ④ If there is a new start command within the hold time, the DC braking is cancelled. The motor is accelerated to the setpoint again.

Additional functions

Brake energy management

Example 2: Automatic DC braking when the motor is stopped



10.4 Brake energy management

When braking electrical motors, the kinetic energy of the drive train is fed back regeneratively to the DC bus. This energy causes a DC-bus voltage boost. If the energy fed back is too high, the inverter reports an error.

Several different strategies can serve to avoid DC-bus overvoltage:

- Stopping the deceleration ramp function generator when the active voltage threshold for the brake operation is exceeded
- Use of the "Inverter motor brake" function
- Combination of the above named options

Details

The voltage threshold for braking operation results on the basis of the rated mains voltage set:

Rated mains voltage	Voltage threshold for braking operation
230 V	DC 380 V
400 V	DC 725 V
480 V	DC 775 V

The voltage threshold for braking operation can be reduced by 0 ... 100 V. The reduction required must be set in [0x2541:003 \(P706.03\)](#). However, the reduction must be made to such an extent that the reduced voltage threshold is still above the normal stationary DC-bus voltage.

If the DC-bus voltage exceeds the voltage threshold for braking operation, the braking method selected in [0x2541:001 \(P706.01\)](#) is applied.

- Stopping the deceleration ramp function generator enables smoother deceleration with lower torque oscillation.
- The "Inverter motor brake" function allows for quick braking. For process-related reasons, torque oscillations may occur.

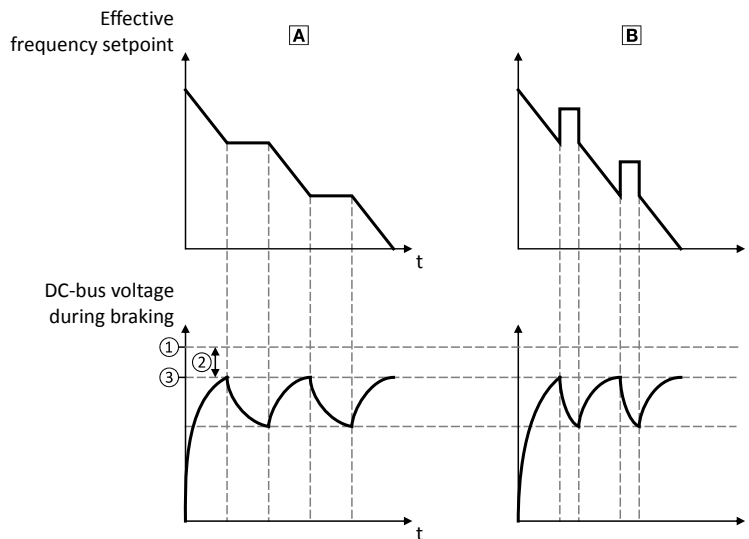

- ① Voltage threshold for braking operation
- ② Reduced threshold [0x2541:003 \(P706.03\)](#)
- ③ Active threshold [0x2541:002 \(P706.02\)](#)

- Ⓐ [Stopping the deceleration ramp function generator](#) [□ 230](#)
- Ⓑ [Inverter motor brake](#) [□ 231](#)

Parameter	Name / value range / [default setting]	Info
0x2541:001 (P706.01)	Brake energy management: Operating mode (Brake management: Operating mode)	Selection of the braking method. <ul style="list-style-type: none"> • The braking method(s) selected is/are activated if the DC-bus voltage exceeds the voltage threshold for the braking operation shown in 0x2541:002 (P706.02).
	1 Ramp function generator stop (RFGS)	The deceleration ramp function generator is stopped. <ul style="list-style-type: none"> ▶ Stopping the deceleration ramp function generator □ 230
	3 Inverter motor brake (IMB) + RFGS	Braking with the "Inverter motor brake" braking method in connection with "Deceleration ramp function generator stop" is executed. <ul style="list-style-type: none"> ▶ Inverter motor brake □ 231



Additional functions

Brake energy management Stopping the deceleration ramp function generator

Parameter	Name / value range / [default setting]	Info
0x2541:002 (P706.02)	Brake energy management: Active threshold (Brake management: Active threshold) • Read only: x V	Display of the active voltage threshold for the braking operation. • The voltage threshold shown depends on the mains voltage selected in 0x2540:001 (P208.01) and the voltage value set in 0x2541:003 (P706.03) . • The voltage threshold must be higher than the stationary DC voltage in the DC bus.
0x2541:003 (P706.03)	Brake energy management: Reduced threshold (Brake management: Red. threshold) 0 ... [0] ... 100 V	The voltage threshold for the braking operation is reduced by the voltage value set here.
0x2541:005 (P706.05)	Brake energy management: Deceleration override time (Brake management: Del. overr. time) 0.0 ... [2.0] ... 60.0 s	Maximum permissible time for the deceleration override by means of the braking method selected in 0x2541:001 (P706.01) . • If the DC-bus voltage does not fall below the voltage threshold for braking operation shown in 0x2541:002 (P706.02) within this time, the motor is decelerated further. • The time is only reset if the voltage threshold shown in 0x2541:002 (P706.02) is not reached.
0x2540:001 (P208.01)	Mains settings: Rated mains voltage (Mains settings: Mains voltage) • Setting can only be changed if the inverter is inhibited.	Selection of the mains voltage for actuating the inverter.
	0 230 Veff	
	1 400 Veff	
	2 480 Veff	

10.4.1 Stopping the deceleration ramp function generator

The deceleration ramp function generator is stopped for a short time if the voltage threshold for braking operation is exceeded.

Details

When this braking method is selected, the maximum permissible time for the deceleration override has to be set in [0x2541:005 \(P706.05\)](#).

- If the DC-bus voltage does not fall below the voltage threshold for braking operation shown in [0x2541:002 \(P706.02\)](#) within this time, the motor is decelerated further.
- The time is only reset if the voltage threshold shown in [0x2541:002 \(P706.02\)](#) is not reached.

Additional functions

Brake energy management
Inverter motor brake



10.4.2 Inverter motor brake

With this braking method, which can be selected in [0x2541:001 \(P706.01\)](#), the regenerative energy in the motor is converted as a result of dynamic acceleration/deceleration with down-ramping of the ramp function generator.

i NOTICE

Too frequent braking may cause thermal overload of the motor.

- ▶ Avoid activating the "Inverter motor brake" function over a longer time!
- ▶ In applications with a high mass inertia and long braking times (> 2 s), use the "DC braking" function.

Preconditions

- The "Inverter motor brake" braking method must not be used with vertical conveyors (hoists) or with active loads!
- The "inverter motor brake" braking method only works in operating mode [0x6060 \(P301.00\)](#) = "MS: Velocity mode [-2]".
- When this braking method is used, the motor overload monitoring is not adapted. A too frequent use of the inverter motor brake may cause an incorrect operation of the motor overload monitoring. ▶ [Motor overload monitoring \(i²*t\)](#) [□ 126](#)

Details

During the deceleration process, the ramp function generator is stopped. The frequency set in [0x2541:004 \(P706.04\)](#) is added to the frequency setpoint, taking the sign of the current actual frequency into consideration. Furthermore the ramp function generator is stopped in a state of overvoltage. If the DC-bus voltage falls below a defined DC-bus voltage potential, the additional frequency connected is reduced again and the ramp function generator is re-activated. By the alternating acceleration and deceleration resulting from this circuit, the energy is converted thermally in the motor. For process-related reasons, torque oscillations may occur.

Setting instructions

Generally, the smallest value possible required by the application for being able to still traverse the load to be moved in a controlled fashion should be set as additional frequency. Greater mass inertia values require an increase in the rated motor frequency set. Increasing the rated motor frequency, however, causes greater torque oscillations. A possible consequence is the reduced service life of mechanical components. Furthermore an increase in the rated motor frequency also increases the energy converted into heat in the motor. A possible consequence is the reduced service life of the motor.

Parameter	Name / value range / [default setting]	Info
0x2541:004 (P706.04)	Brake energy management: Additional frequency (Brake management: Add.frequency) 0.0 ... [0.0] ... 10.0 Hz	Frequency deviation which is connected to the deceleration ramp in a pulsative fashion when the "Inverter motor brake" braking method is used.
0x2C01:005 (P320.05)	Motor parameters: Rated frequency (Motor parameters: Rated frequency) 1.0 ... [50.0] ... 1000.0 Hz	General motor data. Carry out settings as specified by motor nameplate data.
0x6060 (P301.00)	Modes of operation (Modes of op.) • Setting can only be changed if the inverter is inhibited.	Selection of the operating mode.
	-2 MS: Velocity mode	Vendor specific velocity mode
	0 No mode change/no mode assigned	No operating mode (standstill)
	2 CiA: Velocity mode	CiA 402 velocity mode



10.5 Load loss detection

This function serves to detect a load loss during operation and to then activate a specific function, for instance the switching of the relay.

Details

If, during operation, the current motor current falls below the threshold set in [0x4006:001 \(P710.01\)](#) for at least the time set in [0x4006:002 \(P710.02\)](#), the internal status signal "Load loss detected [83]" is set to TRUE:

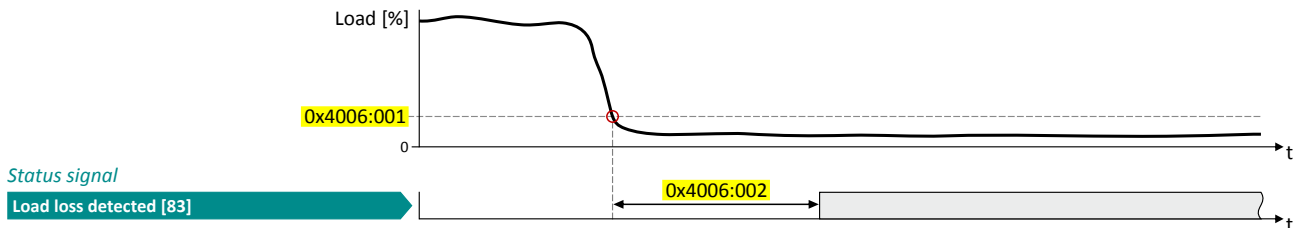

- The threshold is set in percent with reference to the rated motor current "Motor rated current" [0x6075 \(P323.00\)](#).
- The status signal "Load loss detected [83]" can be assigned, for instance, to a digital output or the relay via the flexible I/O configuration. ▶ [Configuration of digital outputs](#) [355](#)
- The load loss detection is not active with active DC braking.

Parameter	Name / value range / [default setting]	Info
0x4006:001 (P710.01)	Load loss detection: Threshold (Load loss detect: Threshold) 0.0 ... [0.0] ... 200.0 %	Threshold for load loss detection. • 100 % ≙ rated motor current 0x6075 (P323.00)
0x4006:002 (P710.02)	Load loss detection: Deceleration (Load loss detect: Deceleration) 0.0 ... [0.0] ... 300.0 s	Tripping delay for load loss detection.
0x6075 (P323.00)	Motor rated current (Motor current) 0.001 ... [1.700]* ... 500.000 A • Default setting depending on the size. • Setting can only be changed if the inverter is inhibited.	The rated motor current to be set here serves as a reference value for different parameters with a setting/display in percent. Relevant parameters: • DC braking: Current 0x2B84:001 (P704.01) • Flying restart circuit: Current 0x2BA1:001 (P718.01) • Motor overload monitoring ($i^2 \cdot t$): Maximum utilisation [60 s] 0x2D4B:001 (P308.01) • Load loss detection: Threshold 0x4006:001 (P710.01) • Max current 0x6073 (P324.00) • Current actual value 0x6078 (P103.00)
0x6078 (P103.00)	Current actual value (Current actual) • Read only: x.x %	Display of the present motor current. • 100 % ≙ Motor rated current 0x6075 (P323.00)

Additional functions

Access protection
Write access protection



10.6 Access protection

10.6.1 Write access protection

Optionally a write access protection can be installed for the inverter parameters.



Write access protection only restricts parameterisation via keypad and »EASY Starter«. Write access protection via network is not restricted. Irrespective of the write access protection that is currently set, a higher-level controller, OPC-UA server, or any other communication partner connected to the inverter is always provided with full read/write access to all parameters of the inverter.



After activating the write access protection, you have to enter a valid PIN to remove the write access protection. Note down the defined PIN(s) and keep this information in a safe place! If you lose the PIN(s), the inverter can only be disabled by resetting it to the delivery status. This means, all parameter settings made by the user get lost! [▶ Reset parameters to default](#) [□ 216](#)

Details

Usually the write access protection function is implemented by the mechanical engineer/OEM, for example to protect the inverter against incorrect parameterisation by non-authorised persons. For diagnostic purposes, a read access to all parameters is always possible.

The write access protection allows for the following configurations:

- Full write access
- Write access only to favorites or (when knowing PIN1) to all parameters
- No write access or (when knowing PIN2) full write access
- No write access or (when knowing PIN1) write access only to favorites or (when knowing PIN2) to all parameters

The following table compares the four possible configurations:

PIN1 setting	PIN2 setting	Log-in	Status display after log-in	Active write access protection (via keypad/»EASY Starter«)
0x203D (P730.00)	0x203E (P731.00)	0x203F	0x2040 (P197.00)	
0	0	-	0	No access protection configured.
Access →				
		Diagnostics (read access)	Favorites	All parameters
> 0	0	0 or wrong PIN	2	Write access only possible to favorites.
		Correct PIN1	0	Write access to all parameters possible.
Access →				
		Diagnostics (read access)	Favorites	PIN1 All parameters
0	> 0	0 or wrong PIN	1	No write access.
		Correct PIN2	0	Write access to all parameters possible.
Access →				
		Diagnostics (read access)	PIN2 Favorites	All parameters
> 0	> 0	0 or wrong PIN	1	No write access.
		Correct PIN1	2	Write access only possible to favorites.
		Correct PIN2	0	Write access to all parameters possible.
Access →				
		Diagnostics (read access)	PIN1 Favorites	PIN2 All parameters
If PIN1 and PIN2 are set identically, a write access to all parameters is possible after the PIN has been entered correctly.				



Additional functions

Access protection
Write access protection

Notes:

- The firmware of the inverter does only support the protection status.
- The access protection is realised by the keypad and engineering tools as "clients" themselves based on the current protection status [0x2040 \(P197.00\)](#).

More details on how to configure the write access protection with the respective client can be found in the following subchapters:

▶ [Write access protection in the »EASY Starter«](#) [📖 235](#)

▶ [Write access protection in the keypad](#) [📖 238](#)

Parameter	Name / value range / [default setting]	Info																																
0x203D (P730.00)	PIN1 access protection (PIN1 protection) -1 ... [0] ... 9999	PIN definition for write access protection. <ul style="list-style-type: none"> • 1 ... 9999 = set/change PIN. • 0 = delete PIN (deactivate access protection). 																																
0x203E (P731.00)	PIN2 access protection (PIN2 protection) -1 ... [0] ... 9999	<ul style="list-style-type: none"> • When the PIN has been set successfully, the value -1 is shown; otherwise 0. • Setting/changing the PIN via keypad/»EASY Starter« only possible if no write access protection is active. • Settings/changes via »EASY Starter« become effective immediately; via keypad they only become effective when the parameter group has been exited. 																																
0x203F	PIN1/PIN2 log-in -32768 ... [0] ... 32767	Parameter for PIN entry for the purpose of deactivating an active access protection temporarily. <ul style="list-style-type: none"> • 1 ... 9999 = log-in (deactivate access protection temporarily). • 0 = log-out (reactivate access protection). • After having logged in successfully, the value 0 is shown; otherwise -1. • After 10 invalid entries, the log-in function is inhibited. In order to remove the log-in inhibit, the inverter must be switched off and on again. 																																
0x2040 (P197.00)	Access protection status (Protect. status) <ul style="list-style-type: none"> • Read only <table border="1"> <tr><td>Bit 0</td><td>No write access</td></tr> <tr><td>Bit 1</td><td>Only favorites changeable</td></tr> <tr><td>Bit 2</td><td>Reserved</td></tr> <tr><td>Bit 3</td><td>Reserved</td></tr> <tr><td>Bit 4</td><td>Reserved</td></tr> <tr><td>Bit 5</td><td>Reserved</td></tr> <tr><td>Bit 6</td><td>Reserved</td></tr> <tr><td>Bit 7</td><td>Reserved</td></tr> <tr><td>Bit 8</td><td>Reserved</td></tr> <tr><td>Bit 9</td><td>Reserved</td></tr> <tr><td>Bit 10</td><td>Reserved</td></tr> <tr><td>Bit 11</td><td>Reserved</td></tr> <tr><td>Bit 12</td><td>Reserved</td></tr> <tr><td>Bit 13</td><td>Reserved</td></tr> <tr><td>Bit 14</td><td>Reserved</td></tr> <tr><td>Bit 15</td><td>Reserved</td></tr> </table>	Bit 0	No write access	Bit 1	Only favorites changeable	Bit 2	Reserved	Bit 3	Reserved	Bit 4	Reserved	Bit 5	Reserved	Bit 6	Reserved	Bit 7	Reserved	Bit 8	Reserved	Bit 9	Reserved	Bit 10	Reserved	Bit 11	Reserved	Bit 12	Reserved	Bit 13	Reserved	Bit 14	Reserved	Bit 15	Reserved	Bit-coded display of the active access protection after login by PIN1/PIN2.
Bit 0	No write access																																	
Bit 1	Only favorites changeable																																	
Bit 2	Reserved																																	
Bit 3	Reserved																																	
Bit 4	Reserved																																	
Bit 5	Reserved																																	
Bit 6	Reserved																																	
Bit 7	Reserved																																	
Bit 8	Reserved																																	
Bit 9	Reserved																																	
Bit 10	Reserved																																	
Bit 11	Reserved																																	
Bit 12	Reserved																																	
Bit 13	Reserved																																	
Bit 14	Reserved																																	
Bit 15	Reserved																																	



Additional functions

Access protection
Write access protection



10.6.1.1 Write access protection in the »EASY Starter«

If a write access protection is active for the online connected inverter, it is displayed in the status bar of the »EASY Starter«:

Display	Representation of the parameters in the »EASY Starter«
 No write access	All parameters in all dialogs are displayed as read-only parameters.
 Only favorites	Except for the favorites, all parameters in all dialogs are displayed as read-only parameters.

An active write access protection can be removed when the PIN is known.

How to remove an active write access protection temporarily:

1. Click the symbol  in the toolbar.

The "Log in / Log off" dialog box is displayed:

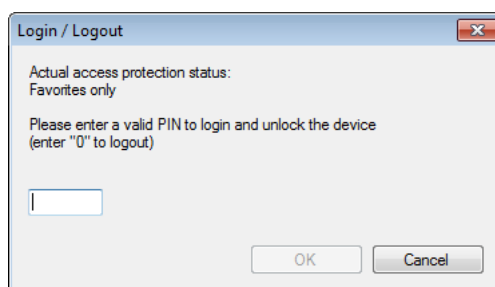

2. Enter the valid PIN and confirm with **OK**.



After 10 invalid entries, the log-in function is inhibited. In order to remove the log-in inhibit, the inverter must be switched off and on again.

The write access protection gets active again:

- Automatically 10 minutes after the last log-in.
- Automatically after the mains voltage is switched on again.
- Manually by entering a "0" in the dialog box "Log in / Log off" (see above).



Configuring the write access protection with »EASY Starter«

The write access protection is activated by specifying PIN1 and/or PIN2 (depending on the desired configuration of the write access protection).

How to activate the write access protection:

1. Go to the "Settings" tab and navigate to the "Access protection" parameterisation dialog:

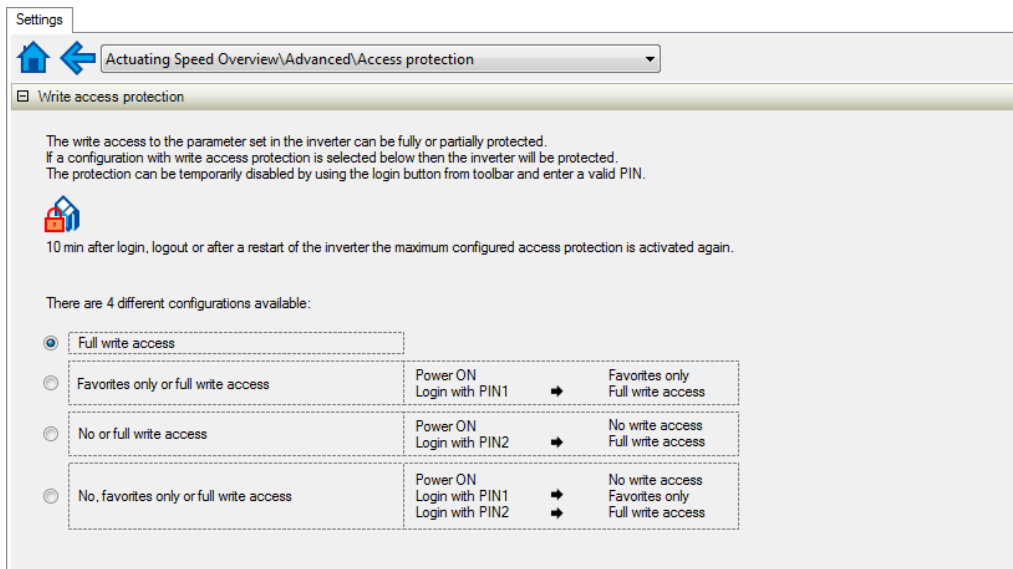

2. Select the desired configuration of the write access protection.

The "PIN definition" dialog box is displayed. The possible entries depend on the selected configuration.

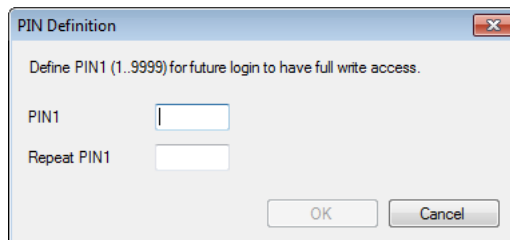

3. Enter the desired PIN(s) and confirm with **OK**.

After successful execution, the write access protection is immediately effective and is displayed in the »EASY Starter« status bar.

4. For a permanent acceptance of the configuration: Save parameter settings in the device.

How to change already defined PIN(s):

1. Remove the active write access protection temporarily (see above).
2. Select the "Full write access" configuration in the "Access protection" parameterisation dialog.
3. Select again the desired configuration of the write access protection.
4. Enter new PIN(s) and confirm with **OK**.
5. Save parameter settings in the device.

How to remove a configured write access protection permanently:

1. Remove the active write access protection temporarily (see above).
2. Select the "Full write access" configuration in the "Access protection" parameterisation dialog.
3. Save parameter settings in the device.

Additional functions

Access protection
Write access protection



Impact of the write access protection on EASY Starter« functions

The following »EASY Starter« functions are not supported when write access protection is active:

- Parameter set download
- Definition of the "Favorites" parameters.
- Definition of the parameters for the "Parameter change-over" function

The following »EASY Starter« functions are supported irrespective of whether write access protection is active:

- Optical device identification [0x2021:001 \(P230.01\)](#)
- Enable/inhibit inverter [0x2822:001](#)
- Reset parameters to default [0x2022:001 \(P700.01\)](#)
- Save parameter set [0x2022:003 \(P700.03\)](#)
- Load user parameter [0x2022:004 \(P700.04\)](#)
- Load OEM parameter [0x2022:005 \(P700.05\)](#)
- Reset error [0x2631:004 \(P400.04\)](#)



10.6.1.2 Write access protection in the keypad

If a write access protection is active for the inverter, the keypad automatically displays a log-in when changing to the parameterisation mode. You can either skip the log-in and thus keep the access protection active or remove it temporarily by entering a valid PIN.

Option 1 - skip log-in and keep access protection active

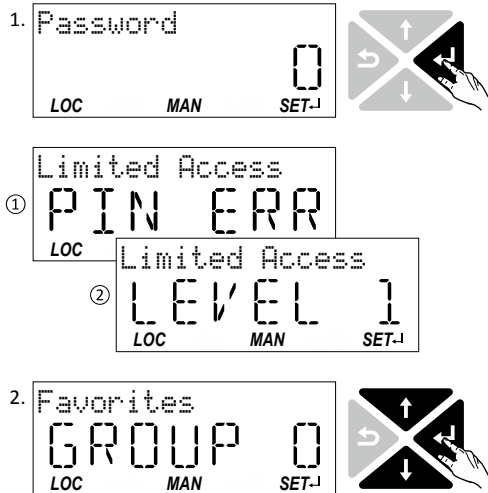

- Use the \leftarrow key to skip the log-in.
The configured access protection remains active and is briefly displayed:
① PIN ERR: No write access
② LEVEL 1: Write access only to favorites
You are now in the group level.
- You can now use the navigation keys \uparrow and \downarrow to select the desired group and with key \leftarrow navigate one level lower to the parameter level.
Note: By using the \rightarrow key you can navigate one level upwards again anytime.

Option 2 - remove access protection temporarily by entering a valid PIN

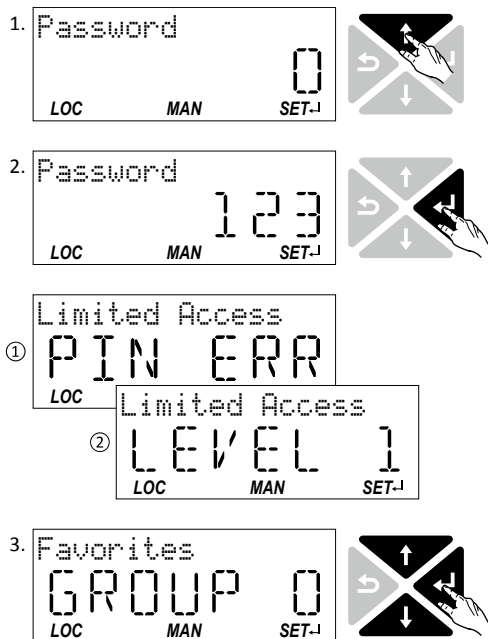

- Use the \uparrow key to enter the defined PIN.
- Use the \leftarrow key to accept the changed setting.
If the access remains restricted, it is briefly displayed:
① PIN ERR: No write access
② LEVEL 1: Write access only to favorites
You are now in the group level.
- You can now use the navigation keys \uparrow and \downarrow to select the desired group and with key \leftarrow navigate one level lower to the parameter level.
Note: By using the \rightarrow key you can navigate one level upwards again anytime.



After 10 invalid entries, the log-in function is inhibited. In order to remove the log-in inhibit, the inverter must be switched off and on again.

The write access protection gets active again:

- Automatically 10 minutes after the last log-in or the last keypad entry.
- Automatically after the mains voltage is switched on again.

Additional functions

Access protection
Write access protection



Configuring the write access protection with the keypad

The write access protection is activated by defining PIN1 in P730.00 and/or PIN2 in P731.00 (depending on the desired configuration of the write access protection).

In the following example, the write access protection is configured in such a way that a write access to the favorites only is possible or (when knowing PIN) to all parameters. This configuration only requires the definition of PIN1 (here: "123").

1.		
2.		
3.		
4.		
5.		
6.		
7.		

Defining PIN1:





1. Use the key in the operating mode to navigate to the parameterisation mode one level below.
You are now in the group level.
Note: By using the key you can navigate one level upwards again anytime.
2. Use the navigation key to select group 7.
3. Use the key to navigate to one level below.
You are now in the parameter level of the group selected.
4. Use the navigation key to select the P730.00 parameter.
5. Use the key to navigate to one level below.
You are now in the editing mode.
6. Use the navigation key to set PIN1 to the value "123".
7. Use the key to accept the changed setting.
The editing mode is exited.
Note: The configured access protection only gets effective after the parameter group is quit.









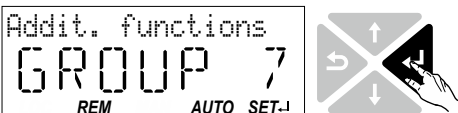
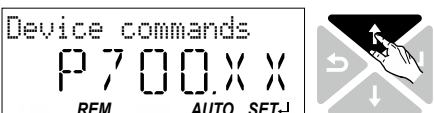
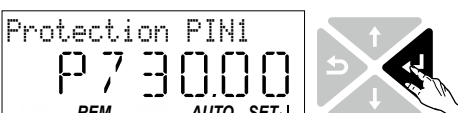
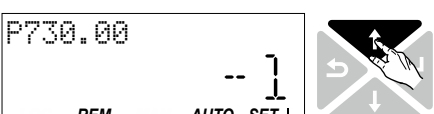
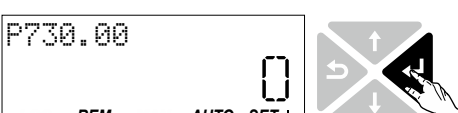
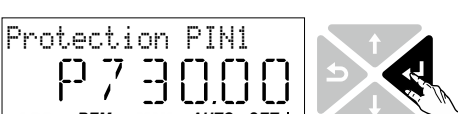
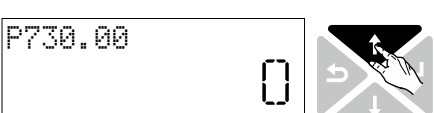
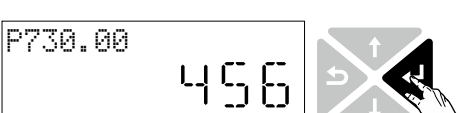





Additional functions

Access protection
Write access protection

In the following example, PIN1 is changed from "123" to "456". For this purpose, the defined PIN must first be deleted by the setting "0".

1. 
2. 
3. 
4. 
5. 
6. 
7. 
8. 
9. 
10. 
11. 
12. 

Change defined PIN1:

1. Use the  key in the operating mode to navigate to the parameterisation mode one level below. Since the access protection is active, the input dialog for the PIN is displayed.
 2. Use the  navigation key to set PIN "123" to remove the access protection temporarily.
 3. Use the  key to accept the entered PIN. You are now in the group level.
 4. Use the  to select group 7.
 5. Use the  key to navigate to one level below. You are now in the parameter level of the group selected.
 6. Use the  to select the P730.00 parameter.
 7. Use the  key to navigate to one level below. You are now in the editing mode.
 8. Use the  key to set PIN1 to the value "0". This setting first deletes PIN1.
 9. Use the  key to accept the changed setting. The editing mode is exited.
 10. Use the  key to navigate again one level below to the editing mode.
 11. Use the  navigation key to set the previously deleted PIN1 to the new value "456".
 12. Use the  key to accept the changed setting. The editing mode is exited.
- Note: The configured access protection only gets effective after the parameter group is quit.

Additional functions

Access protection
Write access protection



How to remove a configured write access protection permanently:

1. Remove the active write access protection temporarily (see above).
2. Set PIN1 (P730.00) and PIN2 (P731.00) to the value "0" (see instructions for changing the PIN).

Impact of the write access protection to the keypad functions

The following keypad functions are supported irrespective of the active write access protection:

- Optical device identification [0x2021:001 \(P230.01\)](#)
- Reset parameters to default [0x2022:001 \(P700.01\)](#)
- Load user parameter [0x2022:004 \(P700.04\)](#)
- Load OEM parameter [0x2022:005 \(P700.05\)](#)



10.7 Favorites

In order to gain quick access using »EASY Starter« or the keypad, frequently used parameters of the inverter can be defined as "Favorites".

- »EASY Starter« provides quick access to the "Favorites" via the *Favorites* tab.
- On the keypad, the "Favorites" can be found in group 0.

10.7.1 Accessing the "Favorites" with the keypad

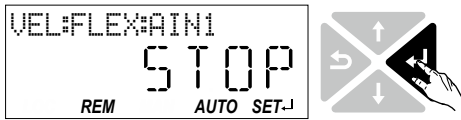
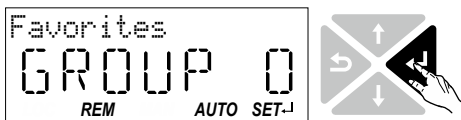
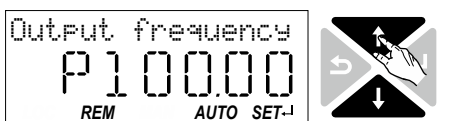
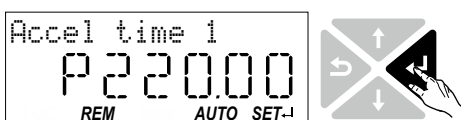
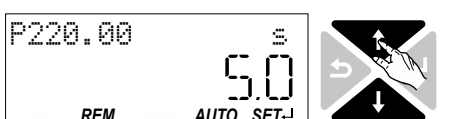
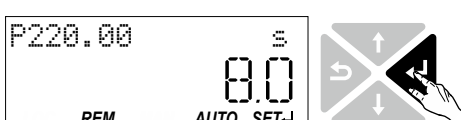
- 
- 
- 
- 
- 
- 

1. Use the **STOP** key in the operating mode to navigate to the parameterisation mode one level below.
You are now in the group level. All parameters of the inverter are divided into different groups according to their function.
Group 0 contains the "Favorites".
Note: By using the **GROUP 0** key you can navigate one level upwards again anytime.
2. Use the **STOP** key to navigate to one level below.
You are now in the parameter level of the group selected.
3. Use the **UP** and **DOWN** navigation keys to select the desired parameter.
4. Use the **STOP** key to navigate to one level below.
You are now in the editing mode.
5. Set the desired value using the **UP** and **DOWN** navigation keys.
6. Use the **STOP** key to accept the changed setting.
The editing mode is exited.
Note: By using the **GROUP 0** key you can exit the editing mode without accepting the new setting (abort).

Additional functions

Favorites

Favorites parameter list (default setting)



10.7.2 Favorites parameter list (default setting)

In the default setting, the most common parameters for the solution of typical applications are defined as "Favorites":

No.	Display code	Name	Default setting	Setting range	Info
1	P100.00	Output frequency	x.x Hz	- (Read only)	0x2DDD (P100.00)
2	P103.00	Current actual	x.x %	- (Read only)	0x6078 (P103.00)
3	P106.00	Motor voltage	x VAC	- (Read only)	0x2D89 (P106.00)
4	P150.00	Error code	-	- (Read only)	0x603F (P150.00)
5	P200.00	Control select.	Flexible I/O [0]	Selection list	0x2824 (P200.00)
6	P201.01	Freq. setp. src.	Analog input 1 [2]	Selection list	0x2860:001 (P201.01)
7	P203.01	Start method	Normal [0]	Selection list	0x2838:001 (P203.01)
8	P203.03	Stop method	Standard ramp [1]	Selection list	0x2838:003 (P203.03)
9	P208.01	Mains voltage	230 Veff [0]	Selection list	0x2540:001 (P208.01)
10	P210.00	Min. frequency	0.0 Hz	0.0 ... 599.0 Hz	0x2915 (P210.00)
11	P211.00	Max. frequency	50.0 Hz	0.0 ... 599.0 Hz	0x2916 (P211.00)
12	P220.00	Accelerat.time 1	5.0 s	0.0 ... 3600.0 s	0x2917 (P220.00)
13	P221.00	Decelerat.time 1	5.0 s	0.0 ... 3600.0 s	0x2918 (P221.00)
14	P300.00	Motor ctrl mode	VFC open loop [6]	Selection list	0x2C00 (P300.00)
15	P302.00	V/f charac.shape	Linear [0]	Selection list	0x2B00 (P302.00)
16	P303.01	Base voltage	230 V	0 ... 5000 V	0x2B01:001 (P303.01)
17	P303.02	Base frequency	50 Hz	0 ... 599 Hz	0x2B01:002 (P303.02)
18	P304.00	Limit. rotation	Both directions [1]	Selection list	0x283A (P304.00)
19	P305.00	Switching freq.	8kHz var/opt/4 [21]	Selection list	0x2939 (P305.00)
20	P308.01	Max.load.for 60s	150 %	30 ... 200 %	0x2D4B:001 (P308.01)
21	P316.01	Fixed V/f boost	2.5 %	0.0 ... 20.0 %	0x2B12:001 (P316.01)
22	P324.00	Max current	200.0 %	0.0 ... 3000.0 %	0x6073 (P324.00)
23	P400.01	Enable inverter	TRUE [1]	Selection list	0x2631:001 (P400.01)
24	P400.02	Run	Digital input 1 [11]	Selection list	0x2631:002 (P400.02)
25	P400.03	Quick stop	Not connected [0]	Selection list	0x2631:003 (P400.03)
26	P400.04	Reset fault	Digital input 2 [12]	Selection list	0x2631:004 (P400.04)
27	P400.05	DC braking	Not connected [0]	Selection list	0x2631:005 (P400.05)
28	P400.06	Start forward	Not connected [0]	Selection list	0x2631:006 (P400.06)
29	P400.07	Start reverse	Not connected [0]	Selection list	0x2631:007 (P400.07)
30	P400.08	Run forward	Not connected [0]	Selection list	0x2631:008 (P400.08)
31	P400.09	Run reverse	Not connected [0]	Selection list	0x2631:009 (P400.09)
32	P400.13	Invert rotation	Digital input 3 [13]	Selection list	0x2631:013 (P400.13)
33	P400.18	Setp. Preset b0	Digital input 4 [14]	Selection list	0x2631:018 (P400.18)
34	P400.19	Setp. Preset b1	Digital input 5 [15]	Selection list	0x2631:019 (P400.19)
35	P400.20	Setp. Preset b2	Not connected [0]	Selection list	0x2631:020 (P400.20)
36	P420.01	Relay function	Rdy for operat. [51]	Selection list	0x2634:001 (P420.01)
37	P420.02	DO1 function	Release brake [115]	Selection list	0x2634:002 (P420.02)
38	P430.01	AI1 input range	0 ... 10 VDC [0]	Selection list	0x2636:001 (P430.01)
39	P430.02	AI1 freq @ min	0.0 Hz	-1000.0 ... 1000.0 Hz	0x2636:002 (P430.02)
40	P430.03	AI1 freq @ max	50.0 Hz	-1000.0 ... 1000.0 Hz	0x2636:003 (P430.03)
41	P440.01	AO1 outp. range	0 ... 10 VDC [1]	Selection list	0x2639:001 (P440.01)
42	P440.02	AO1 function	Outp. frequency [1]	Selection list	0x2639:002 (P440.02)
43	P440.03	AO1 min. signal	0	-2147483648 ... 2147483647	0x2639:003 (P440.03)
44	P440.04	AO1 max. signal	1000	-2147483648 ... 2147483647	0x2639:004 (P440.04)
45	P450.01	Freq. preset 1	20.0 Hz	0.0 ... 599.0 Hz	0x2911:001 (P450.01)
46	P450.02	Freq. preset 2	40.0 Hz	0.0 ... 599.0 Hz	0x2911:002 (P450.02)
47	P450.03	Freq. preset 3	50.0 Hz	0.0 ... 599.0 Hz	0x2911:003 (P450.03)
48	P450.04	Freq. preset 4	0.0 Hz	0.0 ... 599.0 Hz	0x2911:004 (P450.04)
49	-	-	-	-	not assigned
50	-	-	-	-	not assigned



10.7.3 Configuring the "Favorites"

The "Favorites" can be configured by the user.

Details

A maximum number of 50 parameters can be defined as "Favorites".

The easiest way to process the selection of the favorites is via the parameterisation dialog in the »EASY Starter«:

1. Change to the "Parameter list" tab.
2. Select group 0 - Favorites.
3. Click the  button.
4. Process favorites:

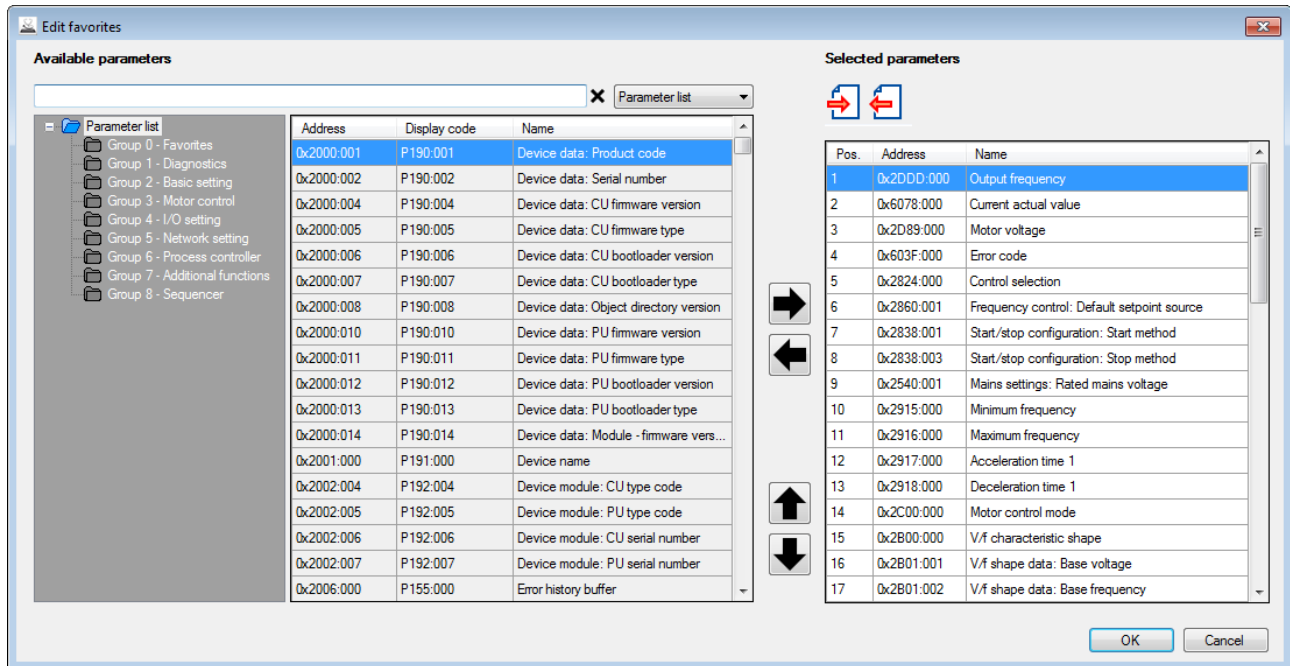

Default favorites can be changed with the keypad or via network via the following parameters:

Parameter	Name / value range / [default setting]	Info
0x261C:001 (P740.01)	Favorites settings: Parameter 1 (Favorites sett.: Parameter 1) 0x00000000 ... [0x2DD00000] ... 0xFFFFFFFF00	Definition of the "Favorites" parameters. <ul style="list-style-type: none"> • Format: 0xiiiiSS00 (iiii = hexadecimal index, ss = hexadecimal subindex) • The lowest byte is always 0x00. • The keypad can be used to select the desired parameter from a list.
0x261C:002 (P740.02)	Favorites settings: Parameter 2 (Favorites sett.: Parameter 2) 0x00000000 ... [0x60780000] ... 0xFFFFFFFF00	
0x261C:003 (P740.03)	Favorites settings: Parameter 3 (Favorites sett.: Parameter 3) 0x00000000 ... [0x2D890000] ... 0xFFFFFFFF00	
0x261C:004 (P740.04)	Favorites settings: Parameter 4 (Favorites sett.: Parameter 4) 0x00000000 ... [0x603F0000] ... 0xFFFFFFFF00	
0x261C:005 (P740.05)	Favorites settings: Parameter 5 (Favorites sett.: Parameter 5) 0x00000000 ... [0x28240000] ... 0xFFFFFFFF00	
0x261C:006 (P740.06)	Favorites settings: Parameter 6 (Favorites sett.: Parameter 6) 0x00000000 ... [0x28600100] ... 0xFFFFFFFF00	
0x261C:007 (P740.07)	Favorites settings: Parameter 7 (Favorites sett.: Parameter 7) 0x00000000 ... [0x28380100] ... 0xFFFFFFFF00	
0x261C:008 (P740.08)	Favorites settings: Parameter 8 (Favorites sett.: Parameter 8) 0x00000000 ... [0x28380300] ... 0xFFFFFFFF00	

Additional functions

Favorites

Configuring the "Favorites"



Parameter	Name / value range / [default setting]	Info
0x261C:009 (P740.09)	Favorites settings: Parameter 9 (Favorites sett.: Parameter 9) 0x00000000 ... [0x25400100] ... 0xFFFFFFFF00	
0x261C:010 (P740.10)	Favorites settings: Parameter 10 (Favorites sett.: Parameter 10) 0x00000000 ... [0x29150000] ... 0xFFFFFFFF00	
0x261C:011 (P740.11)	Favorites settings: Parameter 11 (Favorites sett.: Parameter 11) 0x00000000 ... [0x29160000] ... 0xFFFFFFFF00	
0x261C:012 (P740.12)	Favorites settings: Parameter 12 (Favorites sett.: Parameter 12) 0x00000000 ... [0x29170000] ... 0xFFFFFFFF00	
0x261C:013 (P740.13)	Favorites settings: Parameter 13 (Favorites sett.: Parameter 13) 0x00000000 ... [0x29180000] ... 0xFFFFFFFF00	
0x261C:014 (P740.14)	Favorites settings: Parameter 14 (Favorites sett.: Parameter 14) 0x00000000 ... [0x2C000000] ... 0xFFFFFFFF00	
0x261C:015 (P740.15)	Favorites settings: Parameter 15 (Favorites sett.: Parameter 15) 0x00000000 ... [0x2B000000] ... 0xFFFFFFFF00	
0x261C:016 (P740.16)	Favorites settings: Parameter 16 (Favorites sett.: Parameter 16) 0x00000000 ... [0x2B010100] ... 0xFFFFFFFF00	
0x261C:017 (P740.17)	Favorites settings: Parameter 17 (Favorites sett.: Parameter 17) 0x00000000 ... [0x2B010200] ... 0xFFFFFFFF00	
0x261C:018 (P740.18)	Favorites settings: Parameter 18 (Favorites sett.: Parameter 18) 0x00000000 ... [0x283A0000] ... 0xFFFFFFFF00	
0x261C:019 (P740.19)	Favorites settings: Parameter 19 (Favorites sett.: Parameter 19) 0x00000000 ... [0x29390000] ... 0xFFFFFFFF00	
0x261C:020 (P740.20)	Favorites settings: Parameter 20 (Favorites sett.: Parameter 20) 0x00000000 ... [0x2D4B0100] ... 0xFFFFFFFF00	
0x261C:021 (P740.21)	Favorites settings: Parameter 21 (Favorites sett.: Parameter 21) 0x00000000 ... [0x2B120100] ... 0xFFFFFFFF00	
0x261C:022 (P740.22)	Favorites settings: Parameter 22 (Favorites sett.: Parameter 22) 0x00000000 ... [0x60730000] ... 0xFFFFFFFF00	
0x261C:023 (P740.23)	Favorites settings: Parameter 23 (Favorites sett.: Parameter 23) 0x00000000 ... [0x26310100] ... 0xFFFFFFFF00	
0x261C:024 (P740.24)	Favorites settings: Parameter 24 (Favorites sett.: Parameter 24) 0x00000000 ... [0x26310200] ... 0xFFFFFFFF00	
0x261C:025 (P740.25)	Favorites settings: Parameter 25 (Favorites sett.: Parameter 25) 0x00000000 ... [0x26310300] ... 0xFFFFFFFF00	
0x261C:026 (P740.26)	Favorites settings: Parameter 26 (Favorites sett.: Parameter 26) 0x00000000 ... [0x26310400] ... 0xFFFFFFFF00	
0x261C:027 (P740.27)	Favorites settings: Parameter 27 (Favorites sett.: Parameter 27) 0x00000000 ... [0x26310500] ... 0xFFFFFFFF00	
0x261C:028 (P740.28)	Favorites settings: Parameter 28 (Favorites sett.: Parameter 28) 0x00000000 ... [0x26310600] ... 0xFFFFFFFF00	
0x261C:029 (P740.29)	Favorites settings: Parameter 29 (Favorites sett.: Parameter 29) 0x00000000 ... [0x26310700] ... 0xFFFFFFFF00	



Additional functions

Favorites
Configuring the "Favorites"

Parameter	Name / value range / [default setting]	Info
0x261C:030 (P740.30)	Favorites settings: Parameter 30 (Favorites sett.: Parameter 30) 0x00000000 ... [0x26310800] ... 0xFFFFFFFF00	
0x261C:031 (P740.31)	Favorites settings: Parameter 31 (Favorites sett.: Parameter 31) 0x00000000 ... [0x26310900] ... 0xFFFFFFFF00	
0x261C:032 (P740.32)	Favorites settings: Parameter 32 (Favorites sett.: Parameter 32) 0x00000000 ... [0x26310D00] ... 0xFFFFFFFF00	
0x261C:033 (P740.33)	Favorites settings: Parameter 33 (Favorites sett.: Parameter 33) 0x00000000 ... [0x26311200] ... 0xFFFFFFFF00	
0x261C:034 (P740.34)	Favorites settings: Parameter 34 (Favorites sett.: Parameter 34) 0x00000000 ... [0x26311300] ... 0xFFFFFFFF00	
0x261C:035 (P740.35)	Favorites settings: Parameter 35 (Favorites sett.: Parameter 35) 0x00000000 ... [0x26311400] ... 0xFFFFFFFF00	
0x261C:036 (P740.36)	Favorites settings: Parameter 36 (Favorites sett.: Parameter 36) 0x00000000 ... [0x26340100] ... 0xFFFFFFFF00	
0x261C:037 (P740.37)	Favorites settings: Parameter 37 (Favorites sett.: Parameter 37) 0x00000000 ... [0x26340200] ... 0xFFFFFFFF00	
0x261C:038 (P740.38)	Favorites settings: Parameter 38 (Favorites sett.: Parameter 38) 0x00000000 ... [0x26360100] ... 0xFFFFFFFF00	
0x261C:039 (P740.39)	Favorites settings: Parameter 39 (Favorites sett.: Parameter 39) 0x00000000 ... [0x26360200] ... 0xFFFFFFFF00	
0x261C:040 (P740.40)	Favorites settings: Parameter 40 (Favorites sett.: Parameter 40) 0x00000000 ... [0x26360300] ... 0xFFFFFFFF00	
0x261C:041 (P740.41)	Favorites settings: Parameter 41 (Favorites sett.: Parameter 41) 0x00000000 ... [0x26390100] ... 0xFFFFFFFF00	
0x261C:042 (P740.42)	Favorites settings: Parameter 42 (Favorites sett.: Parameter 42) 0x00000000 ... [0x26390200] ... 0xFFFFFFFF00	
0x261C:043 (P740.43)	Favorites settings: Parameter 43 (Favorites sett.: Parameter 43) 0x00000000 ... [0x26390300] ... 0xFFFFFFFF00	
0x261C:044 (P740.44)	Favorites settings: Parameter 44 (Favorites sett.: Parameter 44) 0x00000000 ... [0x26390400] ... 0xFFFFFFFF00	
0x261C:045 (P740.45)	Favorites settings: Parameter 45 (Favorites sett.: Parameter 45) 0x00000000 ... [0x29110100] ... 0xFFFFFFFF00	
0x261C:046 (P740.46)	Favorites settings: Parameter 46 (Favorites sett.: Parameter 46) 0x00000000 ... [0x29110200] ... 0xFFFFFFFF00	
0x261C:047 (P740.47)	Favorites settings: Parameter 47 (Favorites sett.: Parameter 47) 0x00000000 ... [0x29110300] ... 0xFFFFFFFF00	
0x261C:048 (P740.48)	Favorites settings: Parameter 48 (Favorites sett.: Parameter 48) 0x00000000 ... [0x29110400] ... 0xFFFFFFFF00	
0x261C:049 (P740.49)	Favorites settings: Parameter 49 (Favorites sett.: Parameter 49) 0x00000000 ... [0x00000000] ... 0xFFFFFFFF00	
0x261C:050 (P740.50)	Favorites settings: Parameter 50 (Favorites sett.: Parameter 50) 0x00000000 ... [0x00000000] ... 0xFFFFFFFF00	

Additional functions

Parameter change-over
Configuring the "Favorites"



10.8 Parameter change-over

For up to 32 freely selectable parameters, this function provides a change-over between four sets with different parameter values.

⚠ DANGER!

Changed parameter settings are effective immediately.

The possible consequence is an unexpected response of the motor shaft while the inverter is enabled.

- ▶ If possible, only carry out parameter changes while the inverter is disabled.
- ▶ Certain device commands or settings which might cause a critical state of the drive behaviour can generally only be carried out when the inverter is inhibited.

Details

The parameter list is compiled in the same way as that of the "Favorites" via configuration. »EASY Starter« provides a user-friendly parameterisation dialog for this purpose.

Change-over to another value set can optionally be effected via corresponding device commands and/or special functions/triggers:

▶ [Device commands for parameter change-over](#) 219

▶ [Functions for parameter change-over](#) 338

Parameter	Name / value range / [default setting]	Info
0x2022:011 (P700.11)	Device commands: Save parameter set 1 (Device commands: Save par. set 1)	1 = save value set 1 of the "Parameter change-over" function. • When the device command has been executed successfully, the value 0 is shown.
	0 Off / ready	Only status feedback.
	1 On / start	Execute device command.
	2 In progress	Only status feedback.
	3 Action cancelled	
	4 No access	
5 No access (Inverter disabled)		
0x2022:012 (P700.12)	Device commands: Save parameter set 2 (Device commands: Save par. set 2)	1 = save value set 2 of the "Parameter change-over" function. • When the device command has been executed successfully, the value 0 is shown.
	0 Off / ready	Only status feedback.
	1 On / start	Execute device command.
	2 In progress	Only status feedback.
	3 Action cancelled	
	4 No access	
5 No access (Inverter disabled)		
0x2022:013 (P700.13)	Device commands: Save parameter set 3 (Device commands: Save par. set 3)	1 = save value set 3 of the "Parameter change-over" function. • When the device command has been executed successfully, the value 0 is shown.
	0 Off / ready	Only status feedback.
	1 On / start	Execute device command.
	2 In progress	Only status feedback.
	3 Action cancelled	
	4 No access	
5 No access (Inverter disabled)		



Additional functions

Parameter change-over
Configuring the "Favorites"

Parameter	Name / value range / [default setting]	Info
0x2022:014 (P700.14)	Device commands: Save parameter set 4 (Device commands: Save par. set 4)	1 = save value set 3 of the "Parameter change-over" function. • When the device command has been executed successfully, the value 0 is shown.
	0 Off / ready	Only status feedback.
	1 On / start	Execute device command.
	2 In progress	Only status feedback.
	3 Action cancelled	
	4 No access	
	5 No access (Inverter disabled)	

Additional functions

Parameter change-over Configuring the "Favorites"



Parameter	Name / value range / [default setting]	Info
0x4041:001 (P750.01)	Parameter change-over: Parameter 1 (Param.set setup: Parameter 1) 0x00000000 ... [0x00000000] ... 0xFFFFFFFF00	Definition of the parameter list for the "Parameter change-over" function. <ul style="list-style-type: none"> Format: 0xiiiiSS00 (iiii = hexadecimal index, ss = hexadecimal subindex) The lowest byte is always 0x00.
0x4041:002 (P750.02)	Parameter change-over: Parameter 2 (Param.set setup: Parameter 2) 0x00000000 ... [0x00000000] ... 0xFFFFFFFF00	
0x4041:003 (P750.03)	Parameter change-over: Parameter 3 (Param.set setup: Parameter 3) 0x00000000 ... [0x00000000] ... 0xFFFFFFFF00	
0x4041:004 (P750.04)	Parameter change-over: Parameter 4 (Param.set setup: Parameter 4) 0x00000000 ... [0x00000000] ... 0xFFFFFFFF00	
0x4041:005 (P750.05)	Parameter change-over: Parameter 5 (Param.set setup: Parameter 5) 0x00000000 ... [0x00000000] ... 0xFFFFFFFF00	
0x4041:006 (P750.06)	Parameter change-over: Parameter 6 (Param.set setup: Parameter 6) 0x00000000 ... [0x00000000] ... 0xFFFFFFFF00	
0x4041:007 (P750.07)	Parameter change-over: Parameter 7 (Param.set setup: Parameter 7) 0x00000000 ... [0x00000000] ... 0xFFFFFFFF00	
0x4041:008 (P750.08)	Parameter change-over: Parameter 8 (Param.set setup: Parameter 8) 0x00000000 ... [0x00000000] ... 0xFFFFFFFF00	
0x4041:009 (P750.09)	Parameter change-over: Parameter 9 (Param.set setup: Parameter 9) 0x00000000 ... [0x00000000] ... 0xFFFFFFFF00	
0x4041:010 (P750.10)	Parameter change-over: Parameter 10 (Param.set setup: Parameter 10) 0x00000000 ... [0x00000000] ... 0xFFFFFFFF00	
0x4041:011 (P750.11)	Parameter change-over: Parameter 11 (Param.set setup: Parameter 11) 0x00000000 ... [0x00000000] ... 0xFFFFFFFF00	
0x4041:012 (P750.12)	Parameter change-over: Parameter 12 (Param.set setup: Parameter 12) 0x00000000 ... [0x00000000] ... 0xFFFFFFFF00	
0x4041:013 (P750.13)	Parameter change-over: Parameter 13 (Param.set setup: Parameter 13) 0x00000000 ... [0x00000000] ... 0xFFFFFFFF00	
0x4041:014 (P750.14)	Parameter change-over: Parameter 14 (Param.set setup: Parameter 14) 0x00000000 ... [0x00000000] ... 0xFFFFFFFF00	
0x4041:015 (P750.15)	Parameter change-over: Parameter 15 (Param.set setup: Parameter 15) 0x00000000 ... [0x00000000] ... 0xFFFFFFFF00	
0x4041:016 (P750.16)	Parameter change-over: Parameter 16 (Param.set setup: Parameter 16) 0x00000000 ... [0x00000000] ... 0xFFFFFFFF00	
0x4041:017 (P750.17)	Parameter change-over: Parameter 17 (Param.set setup: Parameter 17) 0x00000000 ... [0x00000000] ... 0xFFFFFFFF00	
0x4041:018 (P750.18)	Parameter change-over: Parameter 18 (Param.set setup: Parameter 18) 0x00000000 ... [0x00000000] ... 0xFFFFFFFF00	
0x4041:019 (P750.19)	Parameter change-over: Parameter 19 (Param.set setup: Parameter 19) 0x00000000 ... [0x00000000] ... 0xFFFFFFFF00	
0x4041:020 (P750.20)	Parameter change-over: Parameter 20 (Param.set setup: Parameter 20) 0x00000000 ... [0x00000000] ... 0xFFFFFFFF00	
0x4041:021 (P750.21)	Parameter change-over: Parameter 21 (Param.set setup: Parameter 21) 0x00000000 ... [0x00000000] ... 0xFFFFFFFF00	



Additional functions

Parameter change-over
Configuring the "Favorites"

Parameter	Name / value range / [default setting]	Info
0x4041:022 (P750.22)	Parameter change-over: Parameter 22 (Param.set setup: Parameter 22) 0x00000000 ... [0x00000000] ... 0xFFFFFFFF00	
0x4041:023 (P750.23)	Parameter change-over: Parameter 23 (Param.set setup: Parameter 23) 0x00000000 ... [0x00000000] ... 0xFFFFFFFF00	
0x4041:024 (P750.24)	Parameter change-over: Parameter 24 (Param.set setup: Parameter 24) 0x00000000 ... [0x00000000] ... 0xFFFFFFFF00	
0x4041:025 (P750.25)	Parameter change-over: Parameter 25 (Param.set setup: Parameter 25) 0x00000000 ... [0x00000000] ... 0xFFFFFFFF00	
0x4041:026 (P750.26)	Parameter change-over: Parameter 26 (Param.set setup: Parameter 26) 0x00000000 ... [0x00000000] ... 0xFFFFFFFF00	
0x4041:027 (P750.27)	Parameter change-over: Parameter 27 (Param.set setup: Parameter 27) 0x00000000 ... [0x00000000] ... 0xFFFFFFFF00	
0x4041:028 (P750.28)	Parameter change-over: Parameter 28 (Param.set setup: Parameter 28) 0x00000000 ... [0x00000000] ... 0xFFFFFFFF00	
0x4041:029 (P750.29)	Parameter change-over: Parameter 29 (Param.set setup: Parameter 29) 0x00000000 ... [0x00000000] ... 0xFFFFFFFF00	
0x4041:030 (P750.30)	Parameter change-over: Parameter 30 (Param.set setup: Parameter 30) 0x00000000 ... [0x00000000] ... 0xFFFFFFFF00	
0x4041:031 (P750.31)	Parameter change-over: Parameter 31 (Param.set setup: Parameter 31) 0x00000000 ... [0x00000000] ... 0xFFFFFFFF00	
0x4041:032 (P750.32)	Parameter change-over: Parameter 32 (Param.set setup: Parameter 32) 0x00000000 ... [0x00000000] ... 0xFFFFFFFF00	

Additional functions

Parameter change-over
Configuring the "Favorites"



Parameter	Name / value range / [default setting]	Info
0x4042:001 (P751.01)	Parameter value set 1: Value of parameter 1 (Par. value set 1: Set 1 - Value 1) -2147483648 ... [0] ... 2147483647	Value set 1 for the parameter list defined in 0x4041:001 (P750.01).
0x4042:002 (P751.02)	Parameter value set 1: Value of parameter 2 (Par. value set 1: Set 1 - Value 2) -2147483648 ... [0] ... 2147483647	
0x4042:003 (P751.03)	Parameter value set 1: Value of parameter 3 (Par. value set 1: Set 1 - Value 3) -2147483648 ... [0] ... 2147483647	
0x4042:004 (P751.04)	Parameter value set 1: Value of parameter 4 (Par. value set 1: Set 1 - Value 4) -2147483648 ... [0] ... 2147483647	
0x4042:005 (P751.05)	Parameter value set 1: Value of parameter 5 (Par. value set 1: Set 1 - Value 5) -2147483648 ... [0] ... 2147483647	
0x4042:006 (P751.06)	Parameter value set 1: Value of parameter 6 (Par. value set 1: Set 1 - Value 6) -2147483648 ... [0] ... 2147483647	
0x4042:007 (P751.07)	Parameter value set 1: Value of parameter 7 (Par. value set 1: Set 1 - Value 7) -2147483648 ... [0] ... 2147483647	
0x4042:008 (P751.08)	Parameter value set 1: Value of parameter 8 (Par. value set 1: Set 1 - Value 8) -2147483648 ... [0] ... 2147483647	
0x4042:009 (P751.09)	Parameter value set 1: Value of parameter 9 (Par. value set 1: Set 1 - Value 9) -2147483648 ... [0] ... 2147483647	
0x4042:010 (P751.10)	Parameter value set 1: Value of parameter 10 (Par. value set 1: Set 1 - Value 10) -2147483648 ... [0] ... 2147483647	
0x4042:011 (P751.11)	Parameter value set 1: Value of parameter 11 (Par. value set 1: Set 1 - Value 11) -2147483648 ... [0] ... 2147483647	
0x4042:012 (P751.12)	Parameter value set 1: Value of parameter 12 (Par. value set 1: Set 1 - Value 12) -2147483648 ... [0] ... 2147483647	
0x4042:013 (P751.13)	Parameter value set 1: Value of parameter 13 (Par. value set 1: Set 1 - Value 13) -2147483648 ... [0] ... 2147483647	
0x4042:014 (P751.14)	Parameter value set 1: Value of parameter 14 (Par. value set 1: Set 1 - Value 14) -2147483648 ... [0] ... 2147483647	
0x4042:015 (P751.15)	Parameter value set 1: Value of parameter 15 (Par. value set 1: Set 1 - Value 15) -2147483648 ... [0] ... 2147483647	
0x4042:016 (P751.16)	Parameter value set 1: Value of parameter 16 (Par. value set 1: Set 1 - Value 16) -2147483648 ... [0] ... 2147483647	
0x4042:017 (P751.17)	Parameter value set 1: Value of parameter 17 (Par. value set 1: Set 1 - Value 17) -2147483648 ... [0] ... 2147483647	
0x4042:018 (P751.18)	Parameter value set 1: Value of parameter 18 (Par. value set 1: Set 1 - Value 18) -2147483648 ... [0] ... 2147483647	
0x4042:019 (P751.19)	Parameter value set 1: Value of parameter 19 (Par. value set 1: Set 1 - Value 19) -2147483648 ... [0] ... 2147483647	
0x4042:020 (P751.20)	Parameter value set 1: Value of parameter 20 (Par. value set 1: Set 1 - Value 20) -2147483648 ... [0] ... 2147483647	
0x4042:021 (P751.21)	Parameter value set 1: Value of parameter 21 (Par. value set 1: Set 1 - Value 21) -2147483648 ... [0] ... 2147483647	



Additional functions

Parameter change-over
Configuring the "Favorites"

Parameter	Name / value range / [default setting]	Info
0x4042:022 (P751.22)	Parameter value set 1: Value of parameter 22 (Par. value set 1: Set 1 - Value 22) -2147483648 ... [0] ... 2147483647	
0x4042:023 (P751.23)	Parameter value set 1: Value of parameter 23 (Par. value set 1: Set 1 - Value 23) -2147483648 ... [0] ... 2147483647	
0x4042:024 (P751.24)	Parameter value set 1: Value of parameter 24 (Par. value set 1: Set 1 - Value 24) -2147483648 ... [0] ... 2147483647	
0x4042:025 (P751.25)	Parameter value set 1: Value of parameter 25 (Par. value set 1: Set 1 - Value 25) -2147483648 ... [0] ... 2147483647	
0x4042:026 (P751.26)	Parameter value set 1: Value of parameter 26 (Par. value set 1: Set 1 - Value 26) -2147483648 ... [0] ... 2147483647	
0x4042:027 (P751.27)	Parameter value set 1: Value of parameter 27 (Par. value set 1: Set 1 - Value 27) -2147483648 ... [0] ... 2147483647	
0x4042:028 (P751.28)	Parameter value set 1: Value of parameter 28 (Par. value set 1: Set 1 - Value 28) -2147483648 ... [0] ... 2147483647	
0x4042:029 (P751.29)	Parameter value set 1: Value of parameter 29 (Par. value set 1: Set 1 - Value 29) -2147483648 ... [0] ... 2147483647	
0x4042:030 (P751.30)	Parameter value set 1: Value of parameter 30 (Par. value set 1: Set 1 - Value 30) -2147483648 ... [0] ... 2147483647	
0x4042:031 (P751.31)	Parameter value set 1: Value of parameter 31 (Par. value set 1: Set 1 - Value 31) -2147483648 ... [0] ... 2147483647	
0x4042:032 (P751.32)	Parameter value set 1: Value of parameter 32 (Par. value set 1: Set 1 - Value 32) -2147483648 ... [0] ... 2147483647	

Additional functions

Parameter change-over
Configuring the "Favorites"



Parameter	Name / value range / [default setting]	Info
0x4043:001 (P752.01)	Parameter value set 2: Value of parameter 1 (Param. set 2: Set 2 - Value 1) -2147483648 ... [0] ... 2147483647	Value set 2 for the parameter list defined in 0x4041:001 (P750.01).
0x4043:002 (P752.02)	Parameter value set 2: Value of parameter 2 (Param. set 2: Set 2 - Value 2) -2147483648 ... [0] ... 2147483647	
0x4043:003 (P752.03)	Parameter value set 2: Value of parameter 3 (Param. set 2: Set 2 - Value 3) -2147483648 ... [0] ... 2147483647	
0x4043:004 (P752.04)	Parameter value set 2: Value of parameter 4 (Param. set 2: Set 2 - Value 4) -2147483648 ... [0] ... 2147483647	
0x4043:005 (P752.05)	Parameter value set 2: Value of parameter 5 (Param. set 2: Set 2 - Value 5) -2147483648 ... [0] ... 2147483647	
0x4043:006 (P752.06)	Parameter value set 2: Value of parameter 6 (Param. set 2: Set 2 - Value 6) -2147483648 ... [0] ... 2147483647	
0x4043:007 (P752.07)	Parameter value set 2: Value of parameter 7 (Param. set 2: Set 2 - Value 7) -2147483648 ... [0] ... 2147483647	
0x4043:008 (P752.08)	Parameter value set 2: Value of parameter 8 (Param. set 2: Set 2 - Value 8) -2147483648 ... [0] ... 2147483647	
0x4043:009 (P752.09)	Parameter value set 2: Value of parameter 9 (Param. set 2: Set 2 - Value 9) -2147483648 ... [0] ... 2147483647	
0x4043:010 (P752.10)	Parameter value set 2: Value of parameter 10 (Param. set 2: Set 2 - Value 10) -2147483648 ... [0] ... 2147483647	
0x4043:011 (P752.11)	Parameter value set 2: Value of parameter 11 (Param. set 2: Set 2 - Value 11) -2147483648 ... [0] ... 2147483647	
0x4043:012 (P752.12)	Parameter value set 2: Value of parameter 12 (Param. set 2: Set 2 - Value 12) -2147483648 ... [0] ... 2147483647	
0x4043:013 (P752.13)	Parameter value set 2: Value of parameter 13 (Param. set 2: Set 2 - Value 13) -2147483648 ... [0] ... 2147483647	
0x4043:014 (P752.14)	Parameter value set 2: Value of parameter 14 (Param. set 2: Set 2 - Value 14) -2147483648 ... [0] ... 2147483647	
0x4043:015 (P752.15)	Parameter value set 2: Value of parameter 15 (Param. set 2: Set 2 - Value 15) -2147483648 ... [0] ... 2147483647	
0x4043:016 (P752.16)	Parameter value set 2: Value of parameter 16 (Param. set 2: Set 2 - Value 16) -2147483648 ... [0] ... 2147483647	
0x4043:017 (P752.17)	Parameter value set 2: Value of parameter 17 (Param. set 2: Set 2 - Value 17) -2147483648 ... [0] ... 2147483647	
0x4043:018 (P752.18)	Parameter value set 2: Value of parameter 18 (Param. set 2: Set 2 - Value 18) -2147483648 ... [0] ... 2147483647	
0x4043:019 (P752.19)	Parameter value set 2: Value of parameter 19 (Param. set 2: Set 2 - Value 19) -2147483648 ... [0] ... 2147483647	
0x4043:020 (P752.20)	Parameter value set 2: Value of parameter 20 (Param. set 2: Set 2 - Value 20) -2147483648 ... [0] ... 2147483647	
0x4043:021 (P752.21)	Parameter value set 2: Value of parameter 21 (Param. set 2: Set 2 - Value 21) -2147483648 ... [0] ... 2147483647	



Additional functions

Parameter change-over
Configuring the "Favorites"

Parameter	Name / value range / [default setting]	Info
0x4043:022 (P752.22)	Parameter value set 2: Value of parameter 22 (Param. set 2: Set 2 - Value 22) -2147483648 ... [0] ... 2147483647	
0x4043:023 (P752.23)	Parameter value set 2: Value of parameter 23 (Param. set 2: Set 2 - Value 23) -2147483648 ... [0] ... 2147483647	
0x4043:024 (P752.24)	Parameter value set 2: Value of parameter 24 (Param. set 2: Set 2 - Value 24) -2147483648 ... [0] ... 2147483647	
0x4043:025 (P752.25)	Parameter value set 2: Value of parameter 25 (Param. set 2: Set 2 - Value 25) -2147483648 ... [0] ... 2147483647	
0x4043:026 (P752.26)	Parameter value set 2: Value of parameter 26 (Param. set 2: Set 2 - Value 26) -2147483648 ... [0] ... 2147483647	
0x4043:027 (P752.27)	Parameter value set 2: Value of parameter 27 (Param. set 2: Set 2 - Value 27) -2147483648 ... [0] ... 2147483647	
0x4043:028 (P752.28)	Parameter value set 2: Value of parameter 28 (Param. set 2: Set 2 - Value 28) -2147483648 ... [0] ... 2147483647	
0x4043:029 (P752.29)	Parameter value set 2: Value of parameter 29 (Param. set 2: Set 2 - Value 29) -2147483648 ... [0] ... 2147483647	
0x4043:030 (P752.30)	Parameter value set 2: Value of parameter 30 (Param. set 2: Set 2 - Value 30) -2147483648 ... [0] ... 2147483647	
0x4043:031 (P752.31)	Parameter value set 2: Value of parameter 31 (Param. set 2: Set 2 - Value 31) -2147483648 ... [0] ... 2147483647	
0x4043:032 (P752.32)	Parameter value set 2: Value of parameter 32 (Param. set 2: Set 2 - Value 32) -2147483648 ... [0] ... 2147483647	

Additional functions

Parameter change-over
Configuring the "Favorites"



Parameter	Name / value range / [default setting]	Info
0x4044:001 (P753.01)	Parameter value set 3: Value of parameter 1 (Param. set 3: Set 3 - Value 1) -2147483648 ... [0] ... 2147483647	Value set 3 for the parameter list defined in 0x4041:001 (P750.01).
0x4044:002 (P753.02)	Parameter value set 3: Value of parameter 2 (Param. set 3: Set 3 - Value 2) -2147483648 ... [0] ... 2147483647	
0x4044:003 (P753.03)	Parameter value set 3: Value of parameter 3 (Param. set 3: Set 3 - Value 3) -2147483648 ... [0] ... 2147483647	
0x4044:004 (P753.04)	Parameter value set 3: Value of parameter 4 (Param. set 3: Set 3 - Value 4) -2147483648 ... [0] ... 2147483647	
0x4044:005 (P753.05)	Parameter value set 3: Value of parameter 5 (Param. set 3: Set 3 - Value 5) -2147483648 ... [0] ... 2147483647	
0x4044:006 (P753.06)	Parameter value set 3: Value of parameter 6 (Param. set 3: Set 3 - Value 6) -2147483648 ... [0] ... 2147483647	
0x4044:007 (P753.07)	Parameter value set 3: Value of parameter 7 (Param. set 3: Set 3 - Value 7) -2147483648 ... [0] ... 2147483647	
0x4044:008 (P753.08)	Parameter value set 3: Value of parameter 8 (Param. set 3: Set 3 - Value 8) -2147483648 ... [0] ... 2147483647	
0x4044:009 (P753.09)	Parameter value set 3: Value of parameter 9 (Param. set 3: Set 3 - Value 9) -2147483648 ... [0] ... 2147483647	
0x4044:010 (P753.10)	Parameter value set 3: Value of parameter 10 (Param. set 3: Set 3 - Value 10) -2147483648 ... [0] ... 2147483647	
0x4044:011 (P753.11)	Parameter value set 3: Value of parameter 11 (Param. set 3: Set 3 - Value 11) -2147483648 ... [0] ... 2147483647	
0x4044:012 (P753.12)	Parameter value set 3: Value of parameter 12 (Param. set 3: Set 3 - Value 12) -2147483648 ... [0] ... 2147483647	
0x4044:013 (P753.13)	Parameter value set 3: Value of parameter 13 (Param. set 3: Set 3 - Value 13) -2147483648 ... [0] ... 2147483647	
0x4044:014 (P753.14)	Parameter value set 3: Value of parameter 14 (Param. set 3: Set 3 - Value 14) -2147483648 ... [0] ... 2147483647	
0x4044:015 (P753.15)	Parameter value set 3: Value of parameter 15 (Param. set 3: Set 3 - Value 15) -2147483648 ... [0] ... 2147483647	
0x4044:016 (P753.16)	Parameter value set 3: Value of parameter 16 (Param. set 3: Set 3 - Value 16) -2147483648 ... [0] ... 2147483647	
0x4044:017 (P753.17)	Parameter value set 3: Value of parameter 17 (Param. set 3: Set 3 - Value 17) -2147483648 ... [0] ... 2147483647	
0x4044:018 (P753.18)	Parameter value set 3: Value of parameter 18 (Param. set 3: Set 3 - Value 18) -2147483648 ... [0] ... 2147483647	
0x4044:019 (P753.19)	Parameter value set 3: Value of parameter 19 (Param. set 3: Set 3 - Value 19) -2147483648 ... [0] ... 2147483647	
0x4044:020 (P753.20)	Parameter value set 3: Value of parameter 20 (Param. set 3: Set 3 - Value 20) -2147483648 ... [0] ... 2147483647	
0x4044:021 (P753.21)	Parameter value set 3: Value of parameter 21 (Param. set 3: Set 3 - Value 21) -2147483648 ... [0] ... 2147483647	



Additional functions

Parameter change-over
Configuring the "Favorites"

Parameter	Name / value range / [default setting]	Info
0x4044:022 (P753.22)	Parameter value set 3: Value of parameter 22 (Param. set 3: Set 3 - Value 22) -2147483648 ... [0] ... 2147483647	
0x4044:023 (P753.23)	Parameter value set 3: Value of parameter 23 (Param. set 3: Set 3 - Value 23) -2147483648 ... [0] ... 2147483647	
0x4044:024 (P753.24)	Parameter value set 3: Value of parameter 24 (Param. set 3: Set 3 - Value 24) -2147483648 ... [0] ... 2147483647	
0x4044:025 (P753.25)	Parameter value set 3: Value of parameter 25 (Param. set 3: Set 3 - Value 25) -2147483648 ... [0] ... 2147483647	
0x4044:026 (P753.26)	Parameter value set 3: Value of parameter 26 (Param. set 3: Set 3 - Value 26) -2147483648 ... [0] ... 2147483647	
0x4044:027 (P753.27)	Parameter value set 3: Value of parameter 27 (Param. set 3: Set 3 - Value 27) -2147483648 ... [0] ... 2147483647	
0x4044:028 (P753.28)	Parameter value set 3: Value of parameter 28 (Param. set 3: Set 3 - Value 28) -2147483648 ... [0] ... 2147483647	
0x4044:029 (P753.29)	Parameter value set 3: Value of parameter 29 (Param. set 3: Set 3 - Value 29) -2147483648 ... [0] ... 2147483647	
0x4044:030 (P753.30)	Parameter value set 3: Value of parameter 30 (Param. set 3: Set 3 - Value 30) -2147483648 ... [0] ... 2147483647	
0x4044:031 (P753.31)	Parameter value set 3: Value of parameter 31 (Param. set 3: Set 3 - Value 31) -2147483648 ... [0] ... 2147483647	
0x4044:032 (P753.32)	Parameter value set 3: Value of parameter 32 (Param. set 3: Set 3 - Value 32) -2147483648 ... [0] ... 2147483647	

Additional functions

Parameter change-over
Configuring the "Favorites"



Parameter	Name / value range / [default setting]	Info
0x4045:001 (P754.01)	Parameter value set 4: Value of parameter 1 (Param. set 4: Set 4 - Value 1) -2147483648 ... [0] ... 2147483647	Value set 4 for the parameter list defined in 0x4041:001 (P750.01).
0x4045:002 (P754.02)	Parameter value set 4: Value of parameter 2 (Param. set 4: Set 4 - Value 2) -2147483648 ... [0] ... 2147483647	
0x4045:003 (P754.03)	Parameter value set 4: Value of parameter 3 (Param. set 4: Set 4 - Value 3) -2147483648 ... [0] ... 2147483647	
0x4045:004 (P754.04)	Parameter value set 4: Value of parameter 4 (Param. set 4: Set 4 - Value 4) -2147483648 ... [0] ... 2147483647	
0x4045:005 (P754.05)	Parameter value set 4: Value of parameter 5 (Param. set 4: Set 4 - Value 5) -2147483648 ... [0] ... 2147483647	
0x4045:006 (P754.06)	Parameter value set 4: Value of parameter 6 (Param. set 4: Set 4 - Value 6) -2147483648 ... [0] ... 2147483647	
0x4045:007 (P754.07)	Parameter value set 4: Value of parameter 7 (Param. set 4: Set 4 - Value 7) -2147483648 ... [0] ... 2147483647	
0x4045:008 (P754.08)	Parameter value set 4: Value of parameter 8 (Param. set 4: Set 4 - Value 8) -2147483648 ... [0] ... 2147483647	
0x4045:009 (P754.09)	Parameter value set 4: Value of parameter 9 (Param. set 4: Set 4 - Value 9) -2147483648 ... [0] ... 2147483647	
0x4045:010 (P754.10)	Parameter value set 4: Value of parameter 10 (Param. set 4: Set 4 - Value 10) -2147483648 ... [0] ... 2147483647	
0x4045:011 (P754.11)	Parameter value set 4: Value of parameter 11 (Param. set 4: Set 4 - Value 11) -2147483648 ... [0] ... 2147483647	
0x4045:012 (P754.12)	Parameter value set 4: Value of parameter 12 (Param. set 4: Set 4 - Value 12) -2147483648 ... [0] ... 2147483647	
0x4045:013 (P754.13)	Parameter value set 4: Value of parameter 13 (Param. set 4: Set 4 - Value 13) -2147483648 ... [0] ... 2147483647	
0x4045:014 (P754.14)	Parameter value set 4: Value of parameter 14 (Param. set 4: Set 4 - Value 14) -2147483648 ... [0] ... 2147483647	
0x4045:015 (P754.15)	Parameter value set 4: Value of parameter 15 (Param. set 4: Set 4 - Value 15) -2147483648 ... [0] ... 2147483647	
0x4045:016 (P754.16)	Parameter value set 4: Value of parameter 16 (Param. set 4: Set 4 - Value 16) -2147483648 ... [0] ... 2147483647	
0x4045:017 (P754.17)	Parameter value set 4: Value of parameter 17 (Param. set 4: Set 4 - Value 17) -2147483648 ... [0] ... 2147483647	
0x4045:018 (P754.18)	Parameter value set 4: Value of parameter 18 (Param. set 4: Set 4 - Value 18) -2147483648 ... [0] ... 2147483647	
0x4045:019 (P754.19)	Parameter value set 4: Value of parameter 19 (Param. set 4: Set 4 - Value 19) -2147483648 ... [0] ... 2147483647	
0x4045:020 (P754.20)	Parameter value set 4: Value of parameter 20 (Param. set 4: Set 4 - Value 20) -2147483648 ... [0] ... 2147483647	
0x4045:021 (P754.21)	Parameter value set 4: Value of parameter 21 (Param. set 4: Set 4 - Value 21) -2147483648 ... [0] ... 2147483647	



Additional functions

Parameter change-over Configuring the "Favorites"

Parameter	Name / value range / [default setting]	Info
0x4045:022 (P754.22)	Parameter value set 4: Value of parameter 22 (Param. set 4: Set 4 - Value 22) -2147483648 ... [0] ... 2147483647	
0x4045:023 (P754.23)	Parameter value set 4: Value of parameter 23 (Param. set 4: Set 4 - Value 23) -2147483648 ... [0] ... 2147483647	
0x4045:024 (P754.24)	Parameter value set 4: Value of parameter 24 (Param. set 4: Set 4 - Value 24) -2147483648 ... [0] ... 2147483647	
0x4045:025 (P754.25)	Parameter value set 4: Value of parameter 25 (Param. set 4: Set 4 - Value 25) -2147483648 ... [0] ... 2147483647	
0x4045:026 (P754.26)	Parameter value set 4: Value of parameter 26 (Param. set 4: Set 4 - Value 26) -2147483648 ... [0] ... 2147483647	
0x4045:027 (P754.27)	Parameter value set 4: Value of parameter 27 (Param. set 4: Set 4 - Value 27) -2147483648 ... [0] ... 2147483647	
0x4045:028 (P754.28)	Parameter value set 4: Value of parameter 28 (Param. set 4: Set 4 - Value 28) -2147483648 ... [0] ... 2147483647	
0x4045:029 (P754.29)	Parameter value set 4: Value of parameter 29 (Param. set 4: Set 4 - Value 29) -2147483648 ... [0] ... 2147483647	
0x4045:030 (P754.30)	Parameter value set 4: Value of parameter 30 (Param. set 4: Set 4 - Value 30) -2147483648 ... [0] ... 2147483647	
0x4045:031 (P754.31)	Parameter value set 4: Value of parameter 31 (Param. set 4: Set 4 - Value 31) -2147483648 ... [0] ... 2147483647	
0x4045:032 (P754.32)	Parameter value set 4: Value of parameter 32 (Param. set 4: Set 4 - Value 32) -2147483648 ... [0] ... 2147483647	
0x4046 (P755.00)	Activation of parameter set (PSet activation)	Selection of the activation method for the parameter change-over. <ul style="list-style-type: none"> If the selection is changed from "Via command... [0]/[1]" to "If the selection is changed...[2]/[3]" after switch-on, the parameter set selected via the functions "Select parameter set (bit 0)" and "Select parameter set (bit 1)" is activated immediately. In case of selection [2], however, this only takes place if the inverter is disabled, the motor is stopped or an error is active.
	0 Via command (disable required)	The parameter set selected via the functions "Select parameter set (bit 0)" and "Select parameter set (bit 1)" is activated if the trigger assigned to the "Load parameter set" function in 0x2631:040 (P400.40) provides a FALSE-TRUE edge AND the inverter is inhibited, the motor is stopped or an error is active.
	1 Via command (immediately)	The parameter set selected via the functions "Select parameter set (bit 0)" and "Select parameter set (bit 1)" is immediately activated if the trigger assigned to the "Load parameter set" function in 0x2631:040 (P400.40) provides a FALSE-TRUE edge.
	2 If the selection is changed (disable required)	The parameter set selected via the functions "Select parameter set (bit 0)" and "Select parameter set (bit 1)" is activated if the state of these selection bits changes AND the inverter is inhibited, the motor is stopped or an error is active.
	3 If the selection is changed (immediately)	The parameter set selected via the functions "Select parameter set (bit 0)" and "Select parameter set (bit 1)" is activated immediately if the state of these selection bits is changed.

Additional functions

Parameter change-over Configuring the "Favorites"



Parameter	Name / value range / [default setting]	Info
0x4047:001 (P756.01)	Parameter change-over error message: Status (PSet error msg.: Status) • Read only	Error message for the "parameter change-over" function. <ul style="list-style-type: none"> In the event of an error, an error status is shown here, and in 0x4047:002 (P756.02) the number of the list entry in which the error has occurred is displayed (in connection with the value set selected). If several errors occur at the same time, only the first incorrect list entry will be displayed. Hence, after elimination of the displayed error and repeated activation, more errors may be displayed. The parameter list will always be processed from beginning to end, even if errors occur in the meantime.
	0 No fault	
	33803 Invalid data type	
	33804 Range violation	
	33806 Invalid index	
	33813 No element selected	
	33815 Writing impermissible	
	33816 Device not inhibited	
	33829 Invalid subindex	
	33837 Access impermissible	
	33860 Parameter not mappable	
33865 No subindexes		
33876 Parameter not changeable		
0x4047:002 (P756.02)	Parameter change-over error message: List entry (PSet error msg.: List entry) • Read only	Error message for the "Parameter set changeover" function. <ul style="list-style-type: none"> In the event of an error, the number of the list entry for which the error displayed in 0x4047:001 (P756.01) has occurred is shown here.
0x2631:040 (P400.40)	Function list: Load parameter set (Function list: Load param.set) • Setting can only be changed if the inverter is inhibited. • For possible settings see description for 0x2631:001 (P400.01) . 300	Assignment of a trigger for the "Load parameter set" function. Trigger = FALSE-TRUE edge: parameter change-over to the value set selected via "Select parameter set (bit 0)" and "Select parameter set (bit 1)". Trigger = FALSE: no action. Notes: <ul style="list-style-type: none"> The activation method for the "Parameter change-over" function can be selected in 0x4046 (P755.00).
	00 Not connected	No trigger assigned (trigger is constantly FALSE).
0x2631:041 (P400.41)	Function list: Select parameter set (bit 0) (Function list: Sel. paramset b0) • Setting can only be changed if the inverter is inhibited. • For possible settings see description for 0x2631:001 (P400.01) . 300	Assignment of a trigger for the "Select parameter set (bit 0)" function. Selection bit with the valency 2^0 for "Parameter change-over" function. Trigger = FALSE: selection bit = "0". Trigger = TRUE: selection bit = "1".
	00 Not connected	No trigger assigned (trigger is constantly FALSE).
0x2631:042 (P400.42)	Function list: Select parameter set (bit 1) (Function list: Sel. paramset b1) • Setting can only be changed if the inverter is inhibited. • For possible settings see description for 0x2631:001 (P400.01) . 300	Assignment of a trigger for the "Select parameter set (bit 1)" function. Selection bit with the valency 2^1 for "Parameter change-over" function. Trigger = FALSE: selection bit = "0". Trigger = TRUE: selection bit = "1".
	00 Not connected	No trigger assigned (trigger is constantly FALSE).



Additional functions

Parameter change-over

Example: Selective control of several motors with one inverter

10.8.1 Example: Selective control of several motors with one inverter

A typical application for the parameter change-over is an application/machine in which several axes must be triggered successively but a simultaneous operation of several motors is not required. In this case, one and the same inverter can trigger the motors in succession. Advantages of this solution are the reduced amount of components (inverters) and thus a reduced energy consumption.

Principle:

- The motor to be currently controlled is connected to the inverter via motor contactors. (The contactor system can, for instance, be controlled via the digital outputs of the inverter.)
- At the same time, the motor and control settings suitable for motor are activated in the inverter by means of parameter change-over. ▶ [Functions for parameter change-over](#)

338

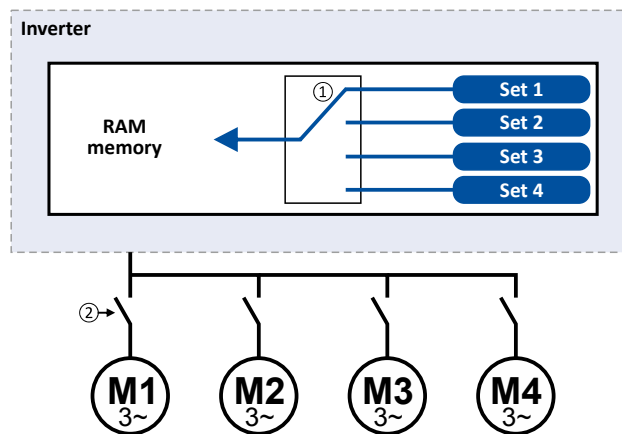

- ① Motor data change-over (via the "parameter change-over" function)
- ② Motor change-over (e.g. via motor contactors)

The following table lists all parameters that require different settings for the four motors:

#	Parameter	Name	Setting			
			M1	M2	M3	M4
1	0x2B00 (P302.00)	V/f characteristic shape	Linear [0]	Square-law [1]	Linear [0]	Linear [0]
2	0x2B01:002 (P303.02)	Base frequency	60 Hz	60 Hz	60 Hz	50 Hz
3	0x2D4B:001 (P308.01)	Maximum utilisation [60 s]	150 %	120 %	150 %	150 %
4	0x2B12:001 (P316.01)	Fixed boost	2.5 %	0.0 %	4.0 %	2.0 %
5	0x2C01:004 (P320.04)	Rated speed	1745	3450	1750	1450
6	0x2C01:005 (P320.05)	Rated frequency	60.0 Hz	60.0 Hz	60.0 Hz	50.0 Hz
7	0x2C01:006 (P320.06)	Rated power	0.75 kW	0.75 kW	0.75 kW	1.50 kW
8	0x2C01:007 (P320.07)	Rated voltage	480 V	480 V	480 V	400 V
9	0x6075 (P323.00)	Motor rated current	2,200 A	2,100 A	2,200 A	3,500 A
10	0x6073 (P324.00)	Max current	200.0 %	150.0 %	200.0 %	200.0 %

Additional functions

Parameter change-over

Example: Selective control of several motors with one inverter



Settings required for the "parameter change-over" function

The easiest way to make the required settings is via the parameterisation dialog in the »EASY Starter«:

1. Click the button to first select the 10 relevant parameters.
2. Set values for motor M1 ... M4 in the corresponding fields:

Zeile	Adresse	Display Code	Name	Einheit	Aktiver Wert	Wert 1	Wert 2	Wert 3	Wert 4
1	0x2B00:000	P302:000	V/f characteristic shape		Linear [0]	Linear [0]	Quadratic [1]	Linear [0]	Linear [0]
2	0x2B01:002	P303:002	V/f shape data: Base frequency	Hz	50	50	50	50	50
3	0x2D4B:001	P308:001	Motor overload monit. (i ²): Maxim...	%	150	150	150	150	150
4	0x2B12:001	P316:001	V/f voltage boost: Fixed boost	%	2.5	2.5	0.0	4.0	2.0
5	0x2C01:004	P320:004	Motor parameters: Rated speed	rpm	1745	1745	3450	1750	1450
6	0x2C01:005	P320:005	Motor parameters: Rated frequency	Hz	60.0	60.0	60.0	60.0	50.0
7	0x2C01:006	P320:006	Motor parameters: Rated power	kW	0.75	0.75	0.75	0.75	1.50
8	0x2C01:007	P320:007	Motor parameters: Rated voltage	V	480	480	480	480	400
9	0x6075:000	P323:000	Motor rated current	A	2.200	2.200	2.100	2.200	3.500
10	0x6073:000	P324:000	Max current	%	200.0	200.0	150.0	200.0	200.0
11									
12									

Status:

List entry:

In case of a direct setting in the parameters of the "parameter change-over" function:

- The addresses must be set with the following format: 0xiiii00 (iiii = index hexadecimal, ss = subindex hexadecimal). The keypad serves to select the desired parameter from a list.
- The values for the motors must be set as integer values. The integer value results from the multiplication of the actual setting value by the factor of the respective parameter. In the , the factor for each parameter must be given.

The following table shows the required settings:

#	Address 0x4041:x (PAR 750/x)		Name	Value 1 0x4042:x (PAR 752/x)	Value 2 0x4043:x (PAR 753/x)	Value 3 0x4044:x (PAR 754/x)	Value 4 0x4045:x (PAR 755/x)
	hex	decimal					
1	0x2B000000	721420288	V/f characteristic shape	0	1	0	0
2	0x2B010200	721486336	Base frequency	60	60	60	50
3	0x2D4B0100	759890176	Maximum utilisation [60 s]	150	120	150	150
4	0x2B120100	722600192	Fixed boost	25	0	40	20
5	0x2C010400	738264064	Rated speed	1745	3450	1750	1450
6	0x2C010500	738264320	Rated frequency	600	600	600	500
7	0x2C010600	738264576	Rated power	75	75	75	150
8	0x2C010700	738264832	Rated voltage	480	480	480	400
9	0x60750000	1618280448	Motor rated current	2200	2100	2200	3500
10	0x60730000	1618149376	Max current	2000	1500	2000	2000



10.9 Device profile CiA 402

The CiA® 402 device profile defines the functional behaviour of stepping motors, servo drives, and frequency inverters. In order to be able to describe the different drive types, various operating modes and device parameters are specified in the device profile. Each operating mode provides objects (e.g. for the setpoint speed, acceleration and deceleration) to generate the desired drive behaviour.

Details

The CiA 402 operating mode "CiA: Velocity mode" is activated by the setting **0x6060 (P301.00)** = "CiA: Velocity mode [2]".



More details can be found in the CiA 402 specification (CANopen device profile for drives and Motion Control) of the CAN in Automation (CiA) user organisation.

<http://www.can-cia.org>

CiA® is a registered community trademark of the CAN in Automation e. V user organisation.

Parameter	Name / value range / [default setting]	Info
0x6042 (P781.00)	Target velocity (Target velocity) -32768 ... [0] ... 32767 rpm	Setpoint speed (velocity mode).
0x6043 (P782.00)	Velocity demand (Velocity demand) • Read only: x rpm	Display of the setpoint velocity (velocity mode).
0x6044 (P783.00)	Velocity actual value (Velocity actual) • Read only: x rpm	Display of the actual speed (velocity mode).
0x6046:001 (P784.01)	Velocity min max amount: Velocity min amount (Vel. min max: Vel. min amount) 0 ... [0] ... 480000 rpm	Minimum speed (velocity mode).
0x6046:002 (P784.02)	Velocity min max amount: Velocity max amount (Vel. min max: Vel. max amount) 0 ... [2147483647] ... 2147483647 rpm	Maximum speed (velocity mode).
0x6048:001 (P785.01)	Velocity acceleration: Delta speed (Vel.acceleration: Delta speed) 0 ... [3000] ... 2147483647 rpm	Acceleration: speed interval
0x6048:002 (P785.02)	Velocity acceleration: Delta time (Vel.acceleration: Delta time) 0 ... [10] ... 65535 s	Acceleration: time interval
0x6049:001 (P786.01)	Velocity deceleration: Delta speed (Vel.deceleration: Delta speed) 0 ... [3000] ... 2147483647 rpm	Deceleration: speed interval
0x6049:002 (P786.02)	Velocity deceleration: Delta time (Vel.deceleration: Delta time) 0 ... [10] ... 65535 s	Deceleration: time interval
0x605A	Quick stop option code	Device status after exiting the quick stop ramp. • Setting is only effective in the operating mode 0x6060 (P301.00) = "CiA: Velocity mode [2]".
	2 Quick stop ramp -> switch-on inhibited	Automatic change to the "Switch-on inhibited" device state. • The "Quick stop active [54]" status is reset to FALSE after ramp-down to standstill.
	6 Quick stop ramp -> quick stop active	The inverter remains in the "Quick stop active" device state. • The "Quick stop active [54]" status remains TRUE until the "Quick stop" function is activated.
0x6060 (P301.00)	Modes of operation (Modes of op.) • Setting can only be changed if the inverter is inhibited.	Selection of the operating mode.
	-2 MS: Velocity mode	Vendor specific velocity mode
	0 No mode change/no mode assigned	No operating mode (standstill)
	2 CiA: Velocity mode	CiA 402 velocity mode

Additional functions

Device profile CiA 402



Parameter	Name / value range / [default setting]	Info
0x6061 (P788.00)	Modes of operation display (Modes of op. dis) • Read only	Display of the current operating mode.
	-2 MS: Velocity mode	Vendor specific velocity mode
	0 No mode change/no mode assigned	No operating mode (standstill)
	2 CiA: Velocity mode	CiA 402 velocity mode
	8 Cyclic sync position mode • From version 02.00	- (not supported)
	9 Cyclic sync velocity mode • From version 02.00	
10 Cyclic sync torque mode • From version 02.00		
0x6071	Target torque -3276.8 ... [0.0] ... 3276.7 %	Setpoint torque for the "MS: Torque mode" operating mode. • 100 % ≡ Motor rated torque 0x6076 (P325.00)
0x6074	Torque demand value • Read only: x.x % • From version 02.00	Display of the setpoint torque in the "MS: Torque mode" operating mode. • 100 % ≡ Motor rated torque 0x6076 (P325.00)
0x6079	DC link circuit voltage • Read only: x.xxx V • From version 02.00	Display of the current DC-bus voltage.
0x6085 (P790.00)	Quick stop deceleration (Quick stop dec.) 0 ... [546000] ... 2147483647 pos. unit/s ²	Change in velocity used for deceleration to a standstill if quick stop is activated. • Setting is only effective in the operating mode 0x6060 (P301.00) = "CiA: Velocity mode [2]". • In operating mode 0x6060 (P301.00) = "MS: Velocity mode [-2]", the deceleration time set in 0x291C (P225.00) is effective. $0x6085 = ((\text{initial speed of the motor [rpm]}) / (\text{duration of the ramp until standstill [s]})) * 1092$



Parameter	Name / value range / [default setting]	Info	
0x6502 (P789.00)	Supported drive modes (Supported modes) • Read only	Bit-coded display of the operating modes supported.	
	Bit 0 Reserved	-	
	Bit 1 CiA: Velocity mode	1 ≡ CiA 402 velocity mode is supported.	
	Bit 2 Reserved	-	
	Bit 3 Reserved		
	Bit 4 Reserved		
	Bit 5 Reserved		
	Bit 6 Reserved		
	Bit 7 Cyclic sync position mode	Always 0 (not supported).	
	Bit 8 Cyclic sync velocity mode		
	Bit 9 Cyclic sync torque mode		
	Bit 10 Reserved	-	
	Bit 11 Reserved		
	Bit 12 Reserved		
	Bit 13 Reserved		
	Bit 14 Reserved		
	Bit 15 Reserved		
	Bit 16 Reserved		
	Bit 17 MS: Velocity mode		1 ≡ vendor specific velocity mode is supported.
	Bit 18 Reserved		-
	Bit 19 Reserved		
	Bit 20 Reserved		
	Bit 21 Reserved		
	Bit 22 Reserved		
	Bit 23 Reserved		
	Bit 24 Reserved		
	Bit 25 Reserved		
	Bit 26 Reserved		
	Bit 27 Reserved		
	Bit 28 Reserved		
	Bit 29 Reserved		
	Bit 30 Reserved		
Bit 31 Reserved			

Additional functions

Device profile CiA 402



Parameter	Name / value range / [default setting]	Info
0x6040	CiA: Controlword 0 ... [0] ... 65535	Mappable CiA 402 control word with bit assignment according to device profile CiA 402.
	Bit 0 Switch on	1 = switch-on
	Bit 1 Enable voltage	1 = DC bus: Establish readiness for operation
	Bit 2 Quick stop	0 = activate quick stop
	Bit 3 Enable operation	1 = enable operation
	Bit 4 Operation mode specific	Bits are not supported.
	Bit 5 Operation mode specific	
	Bit 6 Operation mode specific	
	Bit 7 Fault reset	0-1 edge = reset error
	Bit 8 Reserved	Bit is not supported.
	Bit 9 Operation mode specific	Operating mode dependent
	Bit 10 Reserved	
	Bit 11 Override coast	
	Bit 12 Autolnit	
	Bit 13 Reserved	
	Bit 14 Release holding brake	1 = releasing holding brake manually Notes: <ul style="list-style-type: none"> The manually triggered "Release holding brake" command has a direct impact on the "Release holding brake [115]" trigger. Thus, the holding brake can be manually released if the power section is switched off. The responsibility for a manual release of the holding brake has the external trigger source for the "Release holding brake" command. ▶ Holding brake control 266
Bit 15 Reserved		
0x6041 (P780.00)	CiA: Statusword (CiA: Statusword) • Read only	Mappable CiA 402 status word with bit assignment according to device profile CiA 402.
	Bit 0 Ready to switch on	1 ≡ drive ready to start
	Bit 1 Switched on	1 ≡ drive switched-on
	Bit 2 Operation enabled	1 ≡ operation enabled
	Bit 3 Fault	1 ≡ fault or trouble active
	Bit 4 Voltage enabled	1 ≡ DC bus ready for operation
	Bit 5 Quick stop	0 ≡ quick stop active
	Bit 6 Switch on disabled	1 ≡ operation inhibited
	Bit 7 Warning	1 ≡ warning active
	Bit 8 RPDOs deactivated	1 ≡ cyclic PDOs have been deactivated.
	Bit 9 Remote	1 ≡ inverter can receive commands via network.
	Bit 10 Target reached	1 ≡ the actual position is in the window.
	Bit 11 Internal limit active	1 ≡ internal limitation of a setpoint active.
	Bit 12 Operation mode active	1 ≡ operation enabled and no test mode activated. (no internal setpoint generation active.)
	Bit 13 Following error	1 ≡ following error active
	Bit 14 Holding brake released	1 ≡ holding brake released
Bit 15 Safe torque off (STO) not active	0 ≡ STO active 1 ≡ STO not active	



10.10 Holding brake control

This function is used for low-wear control of a holding brake.

Preconditions

- Observe that the holding brake is an important element of the machine's safety concept as a whole. Therefore be sure to carry out commissioning of this system part with particular care!
- Holding brakes are not intended for braking during operation. The increased wear caused by braking during operation may destroy the holding brake prematurely!
- Ensure that the inverter builds up a sufficient torque in the motor when releasing and applying the holding brake, in order to hold the load. For this purpose, a voltage boost can for instance be set for the V/f characteristic control. ▶ [V/f voltage boost](#) ☰ 113
- If the holding brake is to be controlled via a digital output, the use of an additional relay or power contactor is required. The digital output is not suited for direct control of a holding brake.
- When a power contactor is used, the response time and release time of the contactor is added to the application and release time of the holding brake. Both times must also be taken into consideration for parameterising the application and release time of the holding brake.
- If, instead of an electrically releasing (self-holding) holding brake, an electrically holding (self-releasing) holding brake is to be controlled, a signal inversion for the digital output used or for the relay is to be set! ▶ [Configuration of digital outputs](#) ☰ 355

Details

Holding brakes are used for locking axes if the inverter is disabled or if the system is in the "mains off" state. This is not only important for vertical axes but, for instance, also for horizontal axes which may cause various problems with uncontrolled movements.

Examples:

- Loss of the reference information after mains OFF and further spinning of the drive.
- Collision with other moving machine parts.

The holding brake can be triggered automatically depending on the device state and manually via an external control signal. For more details see the following subchapters:

- ["Automatic" brake mode \(automatic operation\)](#) ☰ 269
- [Manual release of the holding brake](#) ☰ 277

In the default setting [0x2820:001 \(P712.01\)](#) = "Off [2]", the holding brake control is deactivated.

The holding brake control itself only outputs a digital trigger for releasing the holding brake. This trigger can be assigned to a digital output or, in the simplest case, to the relay which then switches the brake supply.

Configuration examples:

- Assignment of the trigger to the relay: [0x2634:001 \(P420.01\)](#) = "Release holding brake [115]".
- Assignment of the trigger to the digital output 1: [0x2634:002 \(P420.02\)](#) = "Release holding brake [115]".

▶ [Configuration of digital outputs](#) ☰ 355

Additional functions

Holding brake control



Parameter	Name / value range / [default setting]	Info
0x2820:001 (P712.01)	Holding brake control: Brake mode (Brake control: Brake mode)	Selecting how the "Release holding brake" command is to be triggered.
	0 Automatically (via device state)	<p>"Automatic operation": The "Release holding brake" command is automatically carried out as a function of the device state and further conditions.</p> <p>Additionally, the "Release holding brake" command can be manually initiated by the following external triggers:</p> <ul style="list-style-type: none"> Via the trigger assigned to the "Release holding brake" function in 0x2631:049 (P400.49) if the network control is not active. Via bit 14 in the CiA 402 control word 0x6040 if the network control is active. <p>Notes:</p> <ul style="list-style-type: none"> The manually triggered "Release holding brake" command has a direct impact on the "Release holding brake [115]" trigger. Thus, the holding brake can be manually released if the power section is switched off. The responsibility for a manual release of the holding brake has the external trigger source for the "Release holding brake" command.
	1 Manually	<p>The "Release holding brake" command can also be initiated by the following external triggers:</p> <ul style="list-style-type: none"> Via the trigger assigned to the "Release holding brake" function in 0x2631:049 (P400.49) if the network control is not active. Via bit 14 in the CiA 402 control word 0x6040 if the network control is active. <p>Notes:</p> <ul style="list-style-type: none"> The manually triggered "Release holding brake" command has a direct impact on the "Release holding brake [115]" trigger. Thus, the holding brake can be manually released if the power section is switched off. The responsibility for a manual release of the holding brake has the external trigger source for the "Release holding brake" command.
2 Off	The holding brake is deactivated.	
0x2820:002 (P712.02)	Holding brake control: Brake closing time (Brake control: Closing time) 0 ... [100] ... 10000 ms	<p>Application time (engagement time) of the holding brake.</p> <ul style="list-style-type: none"> Only effective in automatic operation.
0x2820:003 (P712.03)	Holding brake control: Brake opening time (Brake control: Opening time) 0 ... [100] ... 10000 ms	<p>Release time (disengagement time) of the holding brake.</p> <ul style="list-style-type: none"> Only effective in automatic operation.
0x2820:007 (P712.07)	Holding brake control: Brake closing threshold (Brake control: Closing thresh.) 0.0 ... [0.2] ... 599.0 Hz	<p>Threshold for applying the holding brake for automatic operation without feedforward control (typically for horizontal applications).</p> <ul style="list-style-type: none"> Only effective if the holding load in 0x2820:008 (P712.08) is set to 0 %. By setting a threshold, the holding brake can be triggered to close before the output frequency has reached the value 0 Hz. In order that the brake can work correctly, the threshold for closing the brake must be set to a value that is greater than or that equals the minimum frequency 0x2915 (P210.00).
0x2820:008 (P712.08)	Holding brake control: Brake holding load (Brake control: Holding load) -500.0 ... [0.0] ... 500.0 %	<p>Holding load for automatic operation (typically for vertical applications).</p> <ul style="list-style-type: none"> 100 % ≙ slip frequency 0x2C02:004 (P351.04) For vertical applications we recommend starting with the setting 100 % and then reducing the setting value, if required.
0x2820:015 (P712.15)	Holding brake control: Brake status (Brake control: Brake status)	<p>Display of the holding brake status.</p> <ul style="list-style-type: none"> The status is also displayed via bit 14 in the CiA: Statusword 0x6041 (P780.00).
	0 Active	Holding brake is applied.
	1 Brake released	Holding brake is released.



Additional functions

Holding brake control

Parameter	Name / value range / [default setting]	Info
0x2631:049 (P400.49)	Function list: Release holding brake (Function list: Release brake) <ul style="list-style-type: none"> • Setting can only be changed if the inverter is inhibited. • For possible settings see description for 0x2631:001 (P400.01). □ 300 	Assignment of a trigger for the "Release holding brake" function. Trigger = TRUE: Release holding brake (immediately). Trigger = FALSE: no action. Notes: <ul style="list-style-type: none"> • Function is only executed if the brake mode 0x2820:001 (P712.01) is set to "Automatic [0]" or "Manual [1]". • The manually triggered "Release holding brake" command has a direct impact on the "Release holding brake [115]" trigger. Thus, the holding brake can be manually released if the power section is switched off. • The responsibility for a manual release of the holding brake has the external trigger source for the "Release holding brake" command!
	00 Not connected	No trigger assigned (trigger is constantly FALSE).

Additional functions

Holding brake control

"Automatic" brake mode (automatic operation)



10.10.1 "Automatic" brake mode (automatic operation)

In automatic operation, the "Release holding brake [115]" trigger is set as a function of certain conditions as for instance:

- frequency setpoint
- Current output frequency
- Device status

In automatic operation, the holding brake is always closed if the power section is switched off (exception: The holding brake is released manually). In addition, the holding brake control can disable the switch-on of the power section.

DANGER!

Manual release of the holding brake

Also in automatic operation, a manual release of the holding brake is possible. The manually triggered "Release holding brake" command has a direct impact on the "Release holding brake [115]" trigger. Thus, the holding brake can be manually released if the power section is switched off.

- ▶ The responsibility for a manual release of the holding brake has the external trigger source for the "Release holding brake" command!

Preconditions

Automatic operation is only available if the operating mode "MS: Velocity mode [-2]" is set in [0x6060 \(P301.00\)](#).

General operating mode of the automatic mode

- The threshold for releasing the holding brake either results from the holding load set in [0x2820:008 \(P712.08\)](#) or from the threshold for closing the holding brake set in [0x2820:007 \(P712.07\)](#) if the holding load is set to 0 %.
- The threshold has a permanent hysteresis of 1 Hz to prevent a constant change-over (exception: If the threshold = 0 Hz, the hysteresis is also = 0 Hz).
- The power section remains disabled as long as the conditions for releasing the holding brake are not fulfilled.
- The holding brake is released if the frequency setpoint exceeds the threshold for release (plus hysteresis).
- The holding brake is closed if both frequency setpoint and output frequency are lower than or equal to the threshold.
- The expiration of the release time [0x2820:003 \(P712.03\)](#) only starts after the power section has been switched on and the motor has been magnetised.
- The acceleration to the frequency setpoint starts after the release time has expired.
- If a holding load is set in [0x2820:008 \(P712.08\)](#), the resulting frequency value is used for feedforward control during the release time and application time. The sign of the holding load determines the direction of the feedforward control.
- After the application time [0x2820:002 \(P712.02\)](#) has expired, the output frequency is set to zero (holding brake closed).



Additional functions

Holding brake control
"Automatic" brake mode (automatic operation)

Automatic operation without feedforward control

Typical applications for automatic operation without feedforward control are horizontal applications.

- If the holding load is set to 0 % in [0x2820:008 \(P712.08\)](#), there will be no feedforward control during the release time (disengagement time) and application time (engagement time).
- If the holding brake is to be closed before the output frequency reaches 0 Hz, the corresponding threshold must be set in [Hz] in [0x2820:007 \(P712.07\)](#).

Process - Release holding brake:

1. If the frequency setpoint exceeds the threshold for release, the power section is enabled and the motor is magnetised.
2. After the fixed delay for magnetising the motor, the trigger "Release holding brake [115]" is set to TRUE.
3. After the release time [0x2820:003 \(P712.03\)](#) has elapsed, the output frequency is accelerated to the frequency setpoint. The brake status is set to "Brake released [1]" in [0x2820:015 \(P712.15\)](#).

Process - close holding brake:

1. If the frequency setpoint and the output frequency reach the threshold for release, the trigger "Release holding brake [115]" is reset to FALSE.
2. After the application time [0x2820:002 \(P712.02\)](#) has elapsed, the brake status is set to "Active [0]" in [0x2820:015 \(P712.15\)](#). With a short delay, the holding brake control disables the power section again.

Also see the following examples:

- ▶ [Example 1: Forward motion without feedforward control](#) 272
- ▶ [Example 2: Forward motion without feedforward control with reversal](#) 273

Additional functions

Holding brake control

"Automatic" brake mode (automatic operation)



Automatic operation with feedforward control

Typical applications for the automatic operation with feedforward control are vertical applications.

- The required holding load must be set in [0x2820:008 \(P712.08\)](#) in percent with reference to the slip frequency [0x2C02:004 \(P351.04\)](#).
- The slip frequency depends on the motor power.
- Typical slip frequencies of AC motors:
 - 0.25 kW ... 3.0 kW: 3.0 Hz (6.0 %)
 - 4.0 kW ... 7.5 kW: 1.8 Hz (3.5 %)
 - 11 kW ... 22 kW: 1.4 Hz (2.7 %)
 - 30 kW ... 45 kW: 1.0 Hz (2.0 %)
 - 55 kW ... 90 kW: 0.6 Hz (1.2 %)



For vertical applications we recommend starting with the setting [0x2820:008 \(P712.08\)](#) = 100 % and then reducing the setting value, if required.

Process - Release holding brake:

1. If the frequency setpoint exceeds the holding load, the power section is enabled and the motor is magnetised.
2. After the fixed delay for magnetising the motor, the trigger "Release holding brake [115]" is set to TRUE. At the same time, the output frequency is set to the holding load for the purpose of the feedforward control.
3. After the release time [0x2820:003 \(P712.03\)](#) has elapsed, the output frequency is accelerated to the frequency setpoint. The brake status is set to "Brake released [1]" in [0x2820:015 \(P712.15\)](#).

Process - close holding brake:

1. If the frequency setpoint and the output frequency reach the holding load, the trigger "Release holding brake [115]" is reset to FALSE. The output frequency remains set to the holding load for the purpose of the feedforward control.
2. After the application time [0x2820:002 \(P712.02\)](#) has elapsed, the brake status is set to "Active [0]" in [0x2820:015 \(P712.15\)](#). With a short delay, the holding brake control disables the power section again.

Also see the following examples:

- ▶ [Example 3: Upward motion with feedforward control](#) 274
- ▶ [Example 4: Upward motion with feedforward control and inverted rotation](#) 275
- ▶ [Example 5: Downward motion with feedforward control](#) 276



Additional functions

Holding brake control

Example 1: Forward motion without feedforward control

10.10.2 Example 1: Forward motion without feedforward control

Requirements:

- In `0x6060 (P301.00)`, the operating mode "MS: Velocity mode [-2]" is set.
- In `0x2820:001 (P712.01)`, the brake mode "Automatically (via device state) [0]" is set.
- In `0x2820:008 (P712.08)`, the holding load is set to 0 %.
- The trigger "Release holding brake [115]" is assigned to a digital output or, in the simplest case, to the relay which then switches the brake supply. ▶ [Configuration of digital outputs](#)

355

Input signals

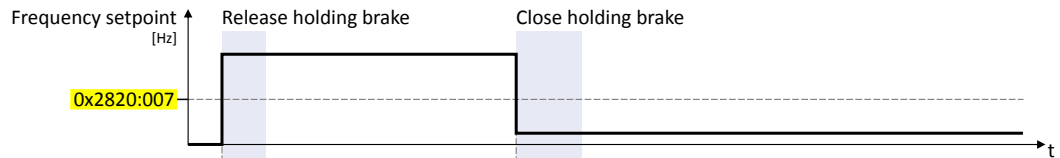

Output signals

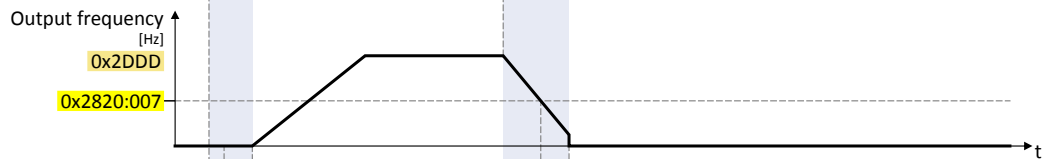

Output trigger

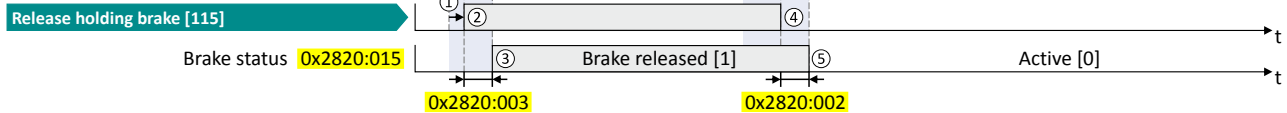

Release holding brake:

- ① If the frequency setpoint exceeds the threshold `0x2820:007 (P712.07)`, the power section is enabled and the motor is magnetised.
- ② After the fixed delay for magnetising the motor, the trigger "Release holding brake [115]" is set to TRUE.
- ③ After the release time `0x2820:003 (P712.03)` has elapsed, the output frequency is accelerated to the frequency setpoint. The brake status is set to "Brake released [1]" in `0x2820:015 (P712.15)`.

Close holding brake:

- ④ If the frequency setpoint and the output frequency reach the threshold `0x2820:007 (P712.07)`, the trigger "Release holding brake [115]" is reset to FALSE.
- ⑤ After the application time `0x2820:002 (P712.02)` has elapsed, the brake status is set to "Active [0]" in `0x2820:015 (P712.15)`. With a short delay, the holding brake control disables the power section again.

Additional functions

Holding brake control

Example 2: Forward motion without feedforward control with reversal



10.10.3 Example 2: Forward motion without feedforward control with reversal

Requirements:

- In `0x6060 (P301.00)`, the operating mode "MS: Velocity mode [-2]" is set.
- In `0x2820:001 (P712.01)`, the brake mode "Automatically (via device state) [0]" is set.
- In `0x2820:008 (P712.08)`, the holding load is set to 0 %.
- The trigger "Release holding brake [115]" is assigned to a digital output or, in the simplest case, to the relay which then switches the brake supply. ▶ [Configuration of digital outputs](#) 355

Input signals

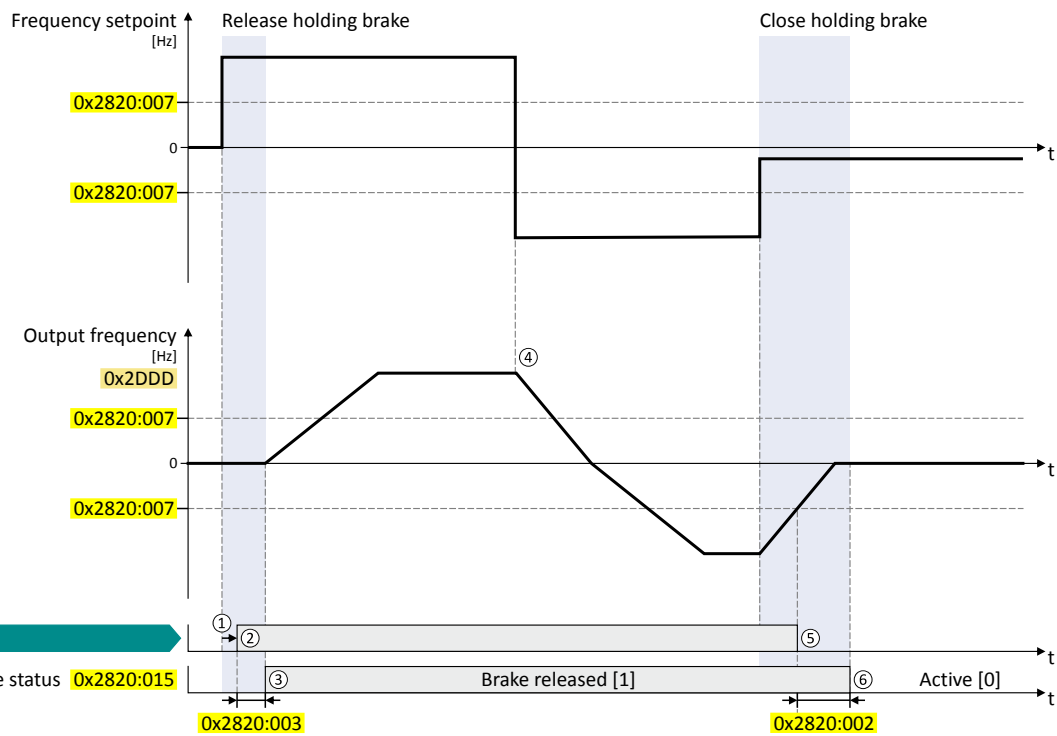

Output trigger

Release holding brake [115]

Release holding brake:

- ① If the frequency setpoint exceeds the threshold `0x2820:007 (P712.07)`, the power section is enabled and the motor is magnetised.
- ② After the fixed delay for magnetising the motor, the trigger "Release holding brake [115]" is set to TRUE.
- ③ After the release time `0x2820:003 (P712.03)` has elapsed, the output frequency is accelerated to the frequency setpoint. The brake status is set to "Brake released [1]" in `0x2820:015 (P712.15)`.

Invert rotation:

- ④ Activating the "Invert rotation" function does not close the holding brake because the frequency setpoint is still above the threshold `0x2820:007 (P712.07)`.

Close holding brake:

- ⑤ If the frequency setpoint and the output frequency reach the threshold `0x2820:007 (P712.07)`, the trigger "Release holding brake [115]" is reset to FALSE.
- ⑥ After the application time `0x2820:002 (P712.02)` has elapsed, the brake status is set to "Active [0]" in `0x2820:015 (P712.15)`. With a short delay, the holding brake control disables the power section again.



10.10.4 Example 3: Upward motion with feedforward control

Requirements:

- In `0x6060 (P301.00)`, the operating mode "MS: Velocity mode [-2]" is set.
- In `0x2820:001 (P712.01)`, the brake mode "Automatically (via device state) [0]" is set.
- In `0x2820:008 (P712.08)`, the holding load required for the application is set.
- The trigger "Release holding brake [115]" is assigned to a digital output or, in the simplest case, to the relay which then switches the brake supply. ▶ [Configuration of digital outputs](#)

[355](#)

Input signals

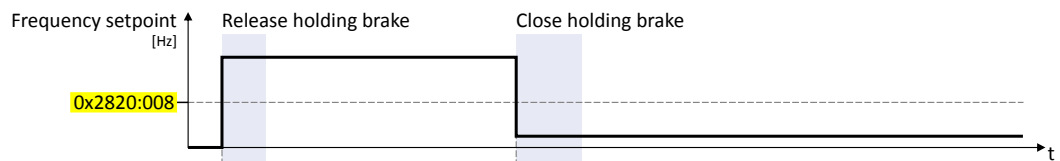

Output signals

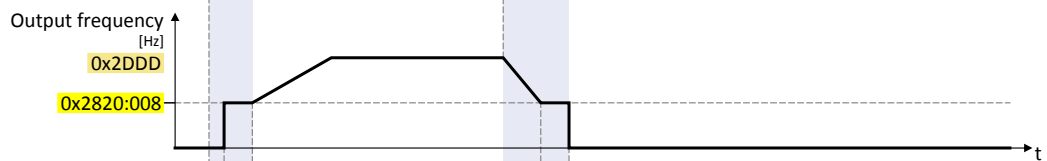

Output trigger

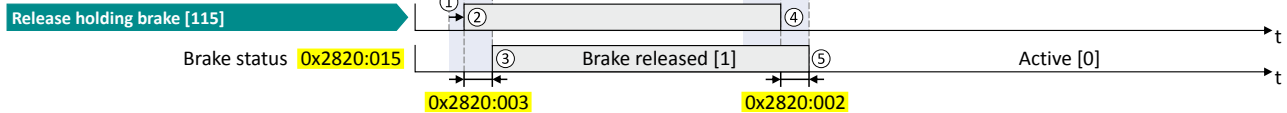

Release holding brake:

- ① If the frequency setpoint exceeds the holding load `0x2820:008 (P712.08)`, the power section is enabled and the motor is magnetised.
- ② After the fixed delay for magnetising the motor, the trigger "Release holding brake [115]" is set to TRUE. At the same time, the output frequency is set to the holding load for the purpose of the feedforward control.
- ③ After the release time `0x2820:003 (P712.03)` has elapsed, the output frequency is accelerated to the frequency setpoint. The brake status is set to "Brake released [1]" in `0x2820:015 (P712.15)`.

Close holding brake:

- ④ If the frequency setpoint and the output frequency reach the holding load `0x2820:008 (P712.08)`, the trigger "Release holding brake [115]" is reset to FALSE. The output frequency remains set to the holding load for the purpose of the feedforward control.
- ⑤ After the application time `0x2820:002 (P712.02)` has elapsed, the brake status is set to "Active [0]" in `0x2820:015 (P712.15)`. With a short delay, the holding brake control disables the power section again.

Additional functions

Holding brake control

Example 4: Upward motion with feedforward control and inverted rotation



10.10.5 Example 4: Upward motion with feedforward control and inverted rotation

Requirements:

- In **0x6060 (P301.00)**, the operating mode "MS: Velocity mode [-2]" is set.
- In **0x2820:001 (P712.01)**, the brake mode "Automatically (via device state) [0]" is set.
- In **0x2820:008 (P712.08)**, the holding load required for the application is set.
- The trigger "Release holding brake [115]" is assigned to a digital output or, in the simplest case, to the relay which then switches the brake supply. ▶ [Configuration of digital outputs](#)

355

Input signals

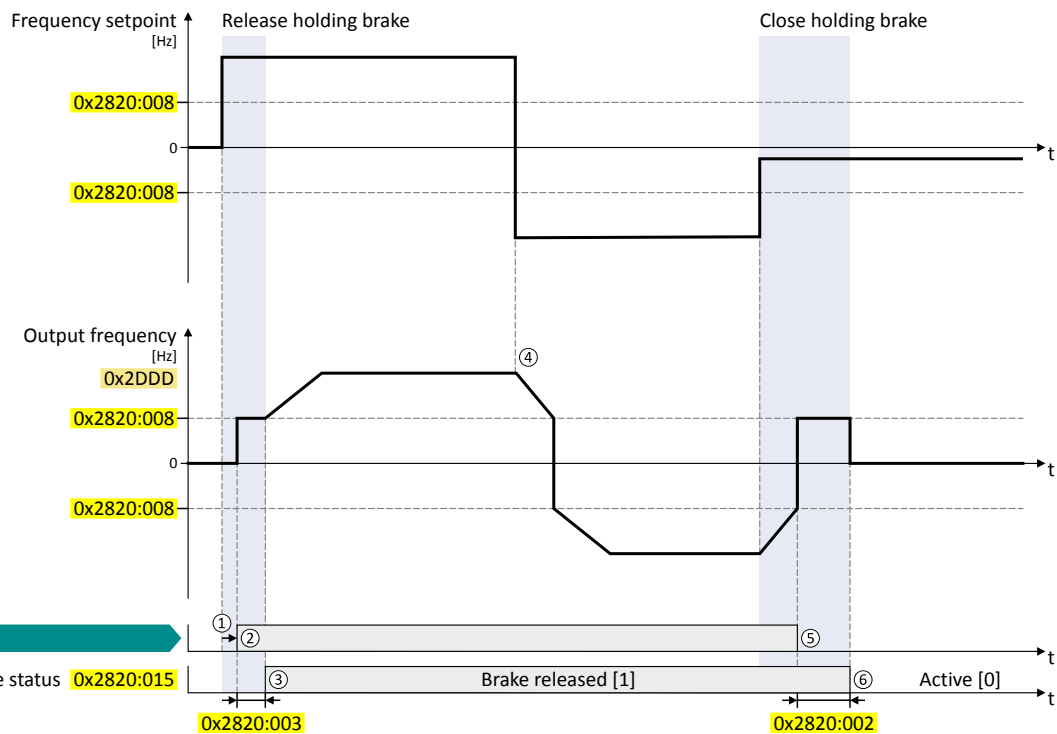

Output signals

Release holding brake:

- ① If the frequency setpoint exceeds the holding load **0x2820:008 (P712.08)**, the power section is enabled and the motor is magnetised.
- ② After the fixed delay for magnetising the motor, the trigger "Release holding brake [115]" is set to TRUE. At the same time, the output frequency is set to the holding load for the purpose of the feedforward control.
- ③ After the release time **0x2820:003 (P712.03)** has elapsed, the output frequency is accelerated to the frequency setpoint. The brake status is set to "Brake released [1]" in **0x2820:015 (P712.15)**.

Invert rotation:

- ④ Activating the "Invert rotation" function does not close the holding brake because the frequency setpoint is still above the holding load **0x2820:008 (P712.08)**.

Close holding brake:

- ⑤ If the frequency setpoint and the output frequency reach the holding load **0x2820:008 (P712.08)**, the trigger "Release holding brake [115]" is reset to FALSE. The output frequency remains set to the holding load for the purpose of the feedforward control.
- ⑥ After the application time **0x2820:002 (P712.02)** has elapsed, the brake status is set to "Active [0]" in **0x2820:015 (P712.15)**. With a short delay, the holding brake control disables the power section again.



10.10.6 Example 5: Downward motion with feedforward control

Requirements:

- In `0x6060 (P301.00)`, the operating mode "MS: Velocity mode [-2]" is set.
- In `0x2820:001 (P712.01)`, the brake mode "Automatically (via device state) [0]" is set.
- In `0x2820:008 (P712.08)`, the holding load required for the application is set.
- The trigger "Release holding brake [115]" is assigned to a digital output or, in the simplest case, to the relay which then switches the brake supply. ▶ [Configuration of digital outputs](#)

[355](#)

Input signals

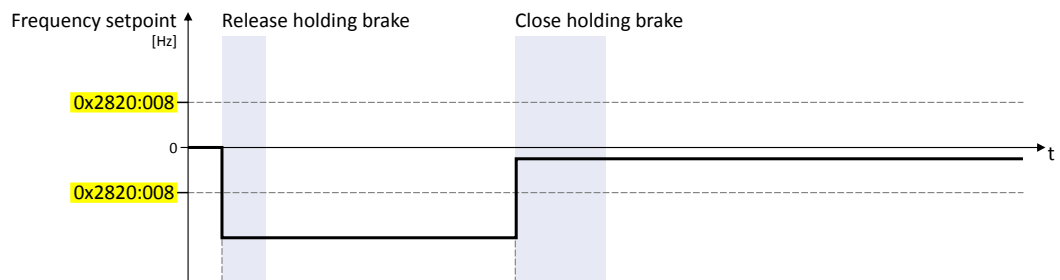

Output signals

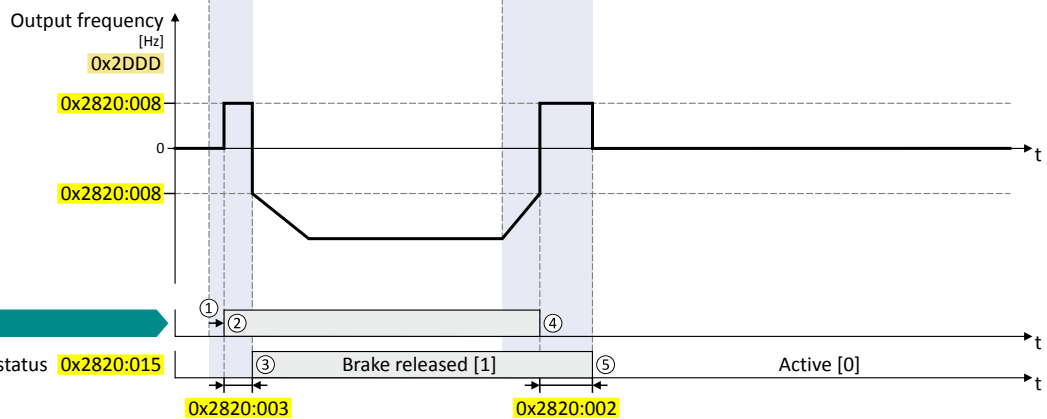

Release holding brake:

- ① If the frequency setpoint exceeds the holding load `0x2820:008 (P712.08)`, the power section is enabled and the motor is magnetised.
- ② After the fixed delay for magnetising the motor, the trigger "Release holding brake [115]" is set to TRUE. At the same time, the output frequency is set to the positive holding load for the purpose of the feedforward control.
- ③ After the release time `0x2820:003 (P712.03)` has elapsed, the negative output frequency is accelerated to the frequency setpoint. The brake status is set to "Brake released [1]" in `0x2820:015 (P712.15)`.

Close holding brake:

- ④ If the frequency setpoint and the output frequency fall below the holding load `0x2820:008 (P712.08)`, the trigger "Release holding brake [115]" is reset to FALSE. The output frequency remains set to the positive holding load for the purpose of the feedforward control.
- ⑤ After the application time `0x2820:002 (P712.02)` has elapsed, the brake status is set to "Active [0]" in `0x2820:015 (P712.15)`. With a short delay, the holding brake control disables the power section again.

Additional functions

Holding brake control

Manual release of the holding brake



10.10.7 Manual release of the holding brake

A manual release of the holding brake is possible in the modes "Automatic [0]" and "Manual [1]" via the following external triggers:

- Via bit 14 in the CiA 402 Controlword [0x6040](#).
- Via the trigger assigned in [0x2631:049 \(P400.49\)](#) of the "Release holding brake" function.
 - ▶ [Example for operating mode](#) [333](#)

DANGER!

Manual release of the holding brake

The manually triggered "Release holding brake" command has a direct impact on the "Release holding brake [115]" trigger. Thus, the holding brake can be manually released if the power section is switched off.

- ▶ The responsibility for a manual release of the holding brake has the external trigger source for the "Release holding brake" command!
-



10.11 Flying restart circuit

The flying restart function makes it possible to restart a coasting motor on the fly during operation without speed feedback. Synchronicity between the inverter and the motor is coordinated so that the transition to the rotating drive is effected without jerk at the time of connection.

Preconditions

- The flying restart circuit is only suitable for asynchronous motors.
- Drive systems with speed feedback do not need a flying restart circuit because there is always a jerk-free synchronisation to the feedback speed.
- The flying restart circuit operates safely and reliably in case of drives with high centrifugal masses. If several motors with different centrifugal masses are connected to the inverter, the flying restart circuit must not be used.
- The flying restart circuit serves to identify rotating field frequencies of up to maximally ± 200 Hz.

Required settings before the flying restart circuit is used:

1. The motor data must be set correctly. ▶ [Motor data](#) 100
2. The settings for the current controller and the flying restart controller must be adapted to the motor. For this purpose, you have to carry out an automatic identification of the motor data. ▶ [Automatic identification of the motor data](#) 103

Details

The inverter determines synchronicity by identifying the synchronous rotating field frequency. The "search" starts in positive direction.

Duration:

- The flying restart process is determined within approx. 0.5 ... 1.5 seconds.
- The duration is influenced by the start frequency [0x2BA1:001 \(P718.01\)](#).
- If the rotating field frequency is unknown, a fixed start frequency of 20 Hz (or -20 Hz for systems rotating in the negative direction) is recommended.

Setting the function:

1. As starting performance, set the selection "Flying restart circuit [2]" in [0x2838:001 \(P203.01\)](#).
 - Thus, every inverter enable causes a synchronisation to the rotating or standing drive.
 - After the inverter has been enabled, the motor can temporarily start or reverse if drives with low friction and low mass inertia are used.
 - If the inverter is operated with the default settings, no further settings are required for most applications.
2. If required, adapt the current [0x2BA1:001 \(P718.01\)](#) and the start frequency [0x2BA1:002 \(P718.02\)](#) for the flying restart circuit.
 - Setting notes can be found in the "Info" column for the respective parameter.

For diagnostic purposes, the frequency detected when the motor has been restarted on the fly is displayed in [0x2BA1:008 \(P718.08\)](#).

Parameter	Name / value range / [default setting]	Info
0x2BA1:001 (P718.01)	Flying restart circuit: Current (Flying restart: Current) 0 ... [30] ... 100 %	The current set here is injected into the motor during the flying restart process for the identification of the rotating field frequency. <ul style="list-style-type: none">• 100 % \equiv Motor rated current 0x6075 (P323.00)• Reducing the current causes a reduction of the motor torque during the flying restart process. A short-time starting action or reversing of the motor is prevented with low flying restart currents.• If the current is set too low, the rotating field frequency cannot be identified correctly.• If the current is increased, this improves the robustness of the flying restart circuit.

Additional functions

Flying restart circuit



Parameter	Name / value range / [default setting]	Info
0x2BA1:002 (P718.02)	Flying restart circuit: Start frequency (Flying restart: Start frequency) -599.0 ... [20.0] ... 599.0 Hz	The frequency set here defines the starting point for the flying restart process. <ul style="list-style-type: none">• The search starts in positive direction.• The default setting is adjusted to standard asynchronous motors.• In case of systems with a known search speed (e.g. torque-controlled drive systems that are to synchronise to a defined speed), the start frequency can be adapted for reducing the flying restart time.
0x2BA1:003 (P718.03)	Flying restart circuit: Restart time (Flying restart: Restart time) 1 ... [5911]* ... 60000 ms <ul style="list-style-type: none">• Default setting depending on the size.	Integration time for controlling the flying restart circuit. <ul style="list-style-type: none">• The parameter is calculated and set in the course of the automatic identification of the motor data. The same applies if an automatic calibration of the motor data is carried out. ▶ Automatic identification of the motor data □ 103
0x2BA1:008 (P718.08)	Flying restart circuit: Flying restart frequency (Flying restart: Fl.res.frequency) <ul style="list-style-type: none">• Read only: x.x Hz	Display of the found frequency at which the motor has been successfully restarted on the fly.



10.12 Timeout für fault reaction

If an error occurs that does not immediately cause a switch-off, the "Fault reaction active" device status becomes initially active. The motor is brought to a standstill with quick stop ramp. The change to the device status "Fault" is only made after the quick stop (motor at standstill) has been executed or after an adjustable timeout time has expired.

Details

In the device status "Fault reaction active"

- only the parameters of the inverter can be changed that do not require an inverter disable.
- a holding brake in brake mode `0x2820:001 (P712.01)` = "Automatically (via device state) [0]" is triggered for closing.
- the motor control continues to be operable.

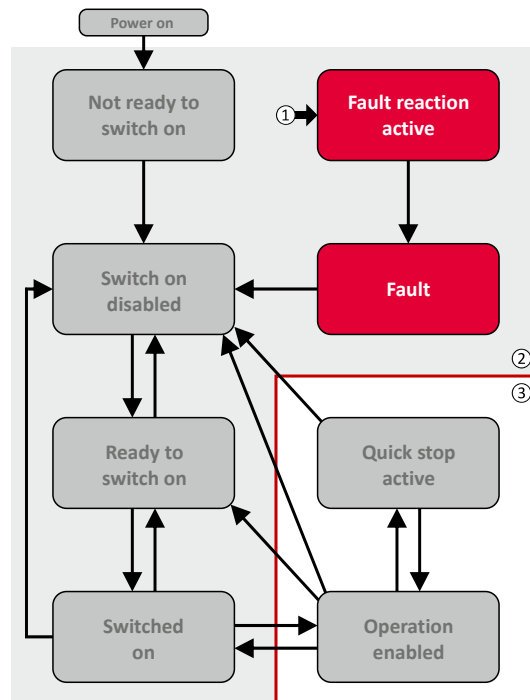

- ① From all states
- ② Power section inhibited (pulse inhibit)
- ③ Power section enabled

Diagnostic parameters:

- `0x282A:005 (P126.05)` displays the current device status of the inverter

Parameter	Name / value range / [default setting]	Info
0x2826	Time-out for error response 0.0 ... [6.0] ... 100.0 s	This timer is started when a change-over to the "Fault reaction active" device status takes place. If the motor is still rotating after the time-out time has elapsed, a change-over to the "Fault" device status takes place. <ul style="list-style-type: none"> • In case of a serious error, an immediate change-over to the "Fault" device status takes place. ⚠ CAUTION! Changing this parameter may cause a longer ramptime in the event of an error. This must be considered when changing this parameter.
0x2839:002 (P760.02)	Fault configuration: Restart delay (Fault config.: Restart delay) 0.0 ... [3.0] ... 1000.0 s	If a fault occurs, a restart is possible at the earliest after the time set here has elapsed.
0x2839:003 (P760.03)	Fault configuration: Number of restart attempts (Fault config.: Restart counter) 0 ... [5] ... 255	Number of restart attempts after a fault. <ul style="list-style-type: none"> • 255 = unlimited number of restart attempts.
0x2839:004 (P760.04)	Fault configuration: Trouble counter reset time (Fault config.: Tro.count r.time) 0.1 ... [5.0] ... 3600.0 s	Time of trouble-free operation after the expiry of which the fault counter is decreased by 1.

Additional functions

Timeout für fault reaction



Parameter	Name / value range / [default setting]	Info
0x2839:005 (P760.05)	Fault configuration: Trouble counter (Fault config.: Trouble counter) <ul style="list-style-type: none">• Read only	Display of the current fault counter content. <ul style="list-style-type: none">• The counter content is increased by 1 after each restart attempt.

Related topics

▶ [Error handling](#) 83

▶ [Automatic restart](#) 281

10.13 Automatic restart

Configuration of the restart behaviour after a fault.



The settings have no impact on errors and warnings of the inverter.

Parameter	Name / value range / [default setting]	Info
0x2839:002 (P760.02)	Fault configuration: Restart delay (Fault config.: Restart delay) 0.0 ... [3.0] ... 1000.0 s	If a fault occurs, a restart is possible at the earliest after the time set here has elapsed.
0x2839:003 (P760.03)	Fault configuration: Number of restart attempts (Fault config.: Restart counter) 0 ... [5] ... 255	Number of restart attempts after a fault. <ul style="list-style-type: none">• 255 = unlimited number of restart attempts.
0x2839:004 (P760.04)	Fault configuration: Trouble counter reset time (Fault config.: Tro.count r.time) 0.1 ... [5.0] ... 3600.0 s	Time of trouble-free operation after the expiry of which the fault counter is decreased by 1.
0x2839:005 (P760.05)	Fault configuration: Trouble counter (Fault config.: Trouble counter) <ul style="list-style-type: none">• Read only	Display of the current fault counter content. <ul style="list-style-type: none">• The counter content is increased by 1 after each restart attempt.

Related topics

▶ [Error handling](#) 83

▶ [Timeout für fault reaction](#) 279



10.14 Mains failure control

In case of power failure, this function can decelerate the motor and use its rotational energy to maintain the DC-bus voltage for a certain period of time. This makes it possible to continue to let the motor run during a short-term failure of the mains voltage. After mains recovery, the operating status that was active before the failure is adopted again.

Details

A failure of the mains voltage causes a continuous DC-bus voltage drop. If the mains failure control is enabled in **0x2D66:001 (P721.01)**, it will get active if the DC-bus voltage falls below the activation threshold set in **0x2D66:002 (P721.02)**.

As soon as the mains failure control is active, the motor is decelerated. Now the rotational energy of the motor is used to maintain the DC-bus voltage above the error threshold for undervoltage until the motor is decelerated to standstill in a controlled way. This process is controlled by the DC-bus voltage controller.

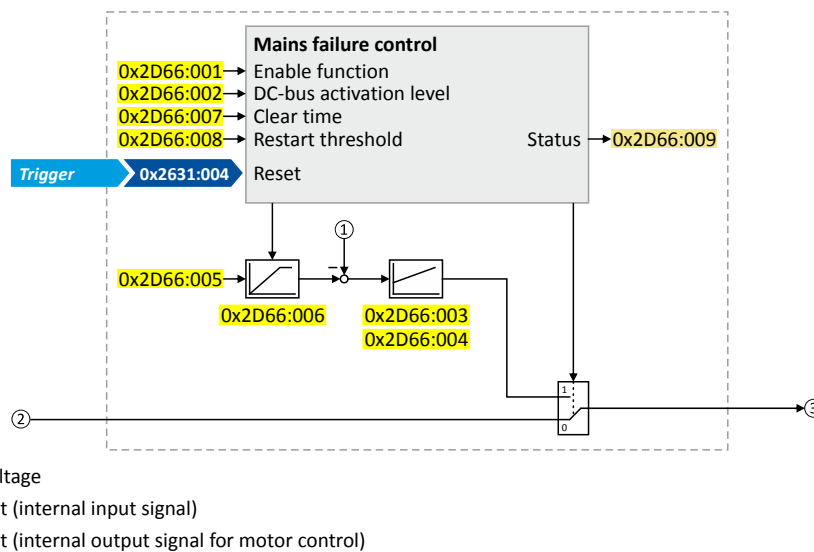

The activation and commissioning of the mains failure control are described in detail in the following subchapters.

Parameter	Name / value range / [default setting]	Info
0x2D66:001 (P721.01)	Mains failure control: Enable function (Mains fail. ctrl: Enable function) • From version 02.00 0 Disabled 1 Enabled	1 = enable mains failure control.
0x2D66:002 (P721.02)	Mains failure control: DC-bus activation level (Mains fail. ctrl: DC-bus act.level) 60 ... [0]* ... 90 % • Default setting depending on the size. • From version 02.00	Threshold below which the mains failure control is activated if it is enabled (0x2D66:001 (P721.01) = 1). • 100 % ≙ nominal DC-bus voltage Recommended setting: • In general: 5 ... 10 % above the error threshold for undervoltage (display in 0x2540:003 (P208.03)). • 230-V devices: 72 % • 400/480-V devices: 82 %
0x2D66:003 (P721.03)	Mains failure control: Gain V-controller (Mains fail. ctrl: Gain V-ctrl) 0.00001 ... [0.01000] ... 0.50000 Hz/V • From version 02.00	Proportional gain of the DC-bus voltage controller.
0x2D66:004 (P721.04)	Mains failure control: Reset time V-controller (Mains fail. ctrl: Res. time V-ctrl) 5 ... [20] ... 2000 ms • From version 02.00	Reset time of the DC-bus voltage controller.

Additional functions

Mains failure control



Parameter	Name / value range / [default setting]	Info
0x2D66:005 (P721.05)	Mains failure control: DC voltage setpoint (Mains fail. ctrl: DC voltage setp.) 80 ... [100] ... 110 % • From version 02.00	Voltage setpoint onto which the DC-bus voltage is to be maintained. • 100 % ≙ nominal DC-bus voltage
0x2D66:006 (P721.06)	Mains failure control: Setpoint ramp (Mains fail. ctrl: Setp. ramp) 1 ... [20] ... 16000 ms • From version 02.00	Acceleration time for the voltage setpoint set in 0x2D66:005 (P721.05) . • The set acceleration time refers to the acceleration from 0 to 100 % of the nominal DC-bus voltage.
0x2D66:007 (P721.07)	Mains failure control: Clear time (Mains fail. ctrl: Clear time) 1 ... [20] ... 60000 ms • From version 02.00	After the DC-bus voltage has exceeded the activation threshold 0x2D66:002 (P721.02) (+hysteresis) again, the time set here must be elapsed before the mains failure control is deactivated again if the restart protection is not activated (default setting).
0x2D66:008 (P721.08)	Mains failure control: Restart threshold (Mains fail. ctrl: Restart level) 0.0 ... [0.0] ... 599.0 Hz • From version 02.00	Threshold for restart protection. Below the threshold set here no restart takes place after mains recovery.
0x2D66:009 (P721.09)	Mains failure control: Status mains failure control (Mains fail. ctrl: RERT:Status) • Read only • From version 02.00	Bit coded display of the mains failure control status.
	Bit 0 Control active	1 ≙ mains failure control active. • The DC-bus voltage has fallen below the activation threshold 0x2D66:002 (P721.02) . • The bit is reset to 0 after the DC-bus voltage has exceeded the activation threshold (+hysteresis) again and the clear time set in 0x2D66:007 (P721.07) has elapsed.
	Bit 1 I-Reset active	1 ≙ I component of the speed controller of the motor control is reset. • Bit is set to 1 if bit 0 is set to 1 (mains failure control active). • Bit is reset to 0 if the frequency setpoint falls below 0.1 Hz.
	Bit 2 Reserved	-
	Bit 3 Reserved	-
	Bit 4 Reserved	-
	Bit 5 Reserved	-
	Bit 6 Reserved	-
Bit 7 Reserved	-	
0x2B01:002 (P303.02)	V/f shape data: Base frequency (V/f shape data: Base frequency) 0 ... [50]* ... 599 Hz • Default setting depending on the size.	Base voltage and base frequency define the V/f ratio and thus the gradient of the V/f characteristic. • The V/f base voltage is usually set to the rated motor voltage 0x2C01:007 (P320.07) . • The V/f base frequency is usually set to the rated motor frequency 0x2C01:005 (P320.05) .



10.14.1 Activating the mains failure control

1. Set the selection "Enabled [1]" in [0x2D66:001 \(P721.01\)](#).
2. Set the activation threshold in [%] with reference to the nominal DC-bus voltage in [0x2D66:002 \(P721.02\)](#).
 - Recommended setting: 5 ... 10 % above the error threshold for undervoltage (display in [0x2540:003 \(P208.03\)](#)).
3. Set the voltage setpoint onto which the DC-bus voltage is to be maintained in [0x2D66:005 \(P721.05\)](#).
 - Recommended setting: 95 ... 100 % (of the nominal DC-bus voltage).

The mains failure control gets active with these settings if the DC-bus voltage falls below the activation threshold. The DC-bus voltage controller now generates the required operational energy from the rotational energy of the motor. The motor is decelerated by the mains failure control. Thus, the deceleration ramp is shorter than the one of a non-guided system (coasting drive).

After the mains failure control has been activated:

1. The DC-bus voltage is controlled with the acceleration time set in [0x2D66:006 \(P721.06\)](#) to the setpoint set in [0x2D66:005 \(P721.05\)](#).
2. An internally generated frequency setpoint is transferred to the motor control which enables the motor (via the frequency setpoint) to be decelerated to a frequency close to "0 Hz".
 - Starting value for the guided deceleration is the current output frequency.
 - The deceleration ramp (and hence the braking torque) results from the moment of inertia of the load machine(s), the power loss of the drive (system) and the set parameterisation.

Behaviour after mains recovery

If, after mains recovery, the DC-bus voltage has exceeded the activation threshold (+hysteresis) again, an internal timing element is started. After the time period set in [0x2D66:007 \(P721.07\)](#) has elapsed, the mains failure control is stopped if the restart protection is not activated (default setting).

▶ [Restart protection](#)  285

▶ [Fast mains recovery](#)  285

Additional functions

Mains failure control
Restart protection



10.14.2 Restart protection

The integrated restart protection is to prevent a restart in the lower frequency range if the mains voltage was only interrupted briefly (mains recovery before the motor stands still).

- In the default setting [0x2D66:008 \(P721.08\)](#) = 0 Hz, the restart protection is deactivated.
- In order to activate the restart protection, set the restart threshold in [Hz] in [0x2D66:008 \(P721.08\)](#) below which no automatic start shall take place after mains recovery.
- If, in case of mains recovery, the output frequency is below the restart threshold, the restart protection gets active:
 - If the current DC-bus voltage is lower than the voltage setpoint [0x2D66:005 \(P721.05\)](#), the motor is continued to be decelerated (until frequency 0 Hz).
 - If the current DC-bus voltage is higher than the voltage setpoint [0x2D66:005 \(P721.05\)](#), the motor is accelerated in a controlled way until the output frequency exceeds the restart threshold.
- If, in case of mains recovery, the output frequency is above the restart threshold, the motor is accelerated again to the frequency setpoint. ▶ [Fast mains recovery](#) 285

Diagnostic parameters:

- An active restart protection is displayed via the status bit 0 in [0x2D66:009 \(P721.09\)](#) if the mains failure control is not active.

Terminating the active restart protection

If, after mains recovery, the restart protection is active, it can be terminated by the following actions:

- Error reset via the trigger set in [0x2631:004 \(P400.04\)](#).
- Short-time inverter disable via the trigger set in [0x2631:001 \(P400.01\)](#).
- Restart via the trigger set in [0x2631:002 \(P400.02\)](#).

10.14.3 Fast mains recovery

A fast mains recovery is caused by a short interruption at the energy supply company (for instance due to a thunderstorm) and by faulty components in the supply cables (for instance slip rings).

The fast mains recovery causes a restart of the motor

- if the restart protection is deactivated ([0x2D66:008 \(P721.08\)](#) = 0 Hz, default setting)
or
- the restart protection does not get active (output frequency > [0x2D66:008 \(P721.08\)](#)).

If this behaviour is not desired, you can decelerate the restart by setting a switch-off time in [0x2D66:007 \(P721.07\)](#) or prevent it in connection with the restart protection. ▶ [Restart protection](#) 284



10.14.4 Commissioning the mains failure control

Commissioning should be executed with motors without load:

1. Let the motor rotate with a rated frequency of 100 %.
2. Disable the inverter and measure the time until the motor has reached standstill.
 - The time can be measured with a stop watch or similar.
 - If a motor encoder is connected to the inverter and set as feedback system for the motor control, this signal can be output at the analog output and measured with an oscilloscope.
3. Set the acceleration time for the voltage setpoint in [0x2D66:006 \(P721.06\)](#) to approx. 1/10 of the time measured before.
4. Set the switch-off time in [0x2D66:007 \(P721.07\)](#) to the time measured before.

Fine adjustment of the mains failure control

For the fine adjustment, you must repeat the following points several times:

1. An end frequency as low as possible should be reached before the inverter reaches the error threshold for undervoltage:
 - Increase the proportional gain of the DC-bus voltage controller in [0x2D66:003 \(P721.03\)](#).
 - Reduce the reset time of the DC-bus voltage controller in [0x2D66:004 \(P721.04\)](#).
2. If, during the mains failure control, monitoring for overvoltage in the DC bus is triggered:
 - Increase the reset time again in [0x2D66:004 \(P721.04\)](#) until monitoring is not triggered anymore.
 - If required, additionally reduce the voltage setpoint in [0x2D66:005 \(P721.05\)](#) onto which the DC-bus voltage is to be controlled.
3. Increasing the delay time or reducing the braking torque is only possible to a limited extent:
 - Increasing the acceleration time in [0x2D66:006 \(P721.06\)](#) reduces the initial braking torque and simultaneously increases the deceleration time.
 - Increasing the reset time of the DC-bus voltage controller in [0x2D66:004 \(P721.04\)](#) reduces the braking torque and simultaneously increases the deceleration time. If the reset time is too high, the inverter reaches the error threshold for undervoltage before standstill is reached. From this point on, the motor is not guided anymore.

Signal flow - DC-bus voltage controller

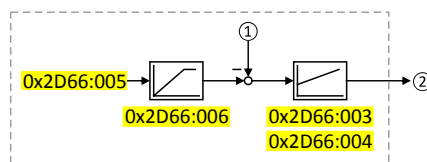

① Current DC-bus voltage

② Internally generated frequency setpoint that is transferred to the motor control in case of an active mains failure control.

Additional functions

Firmware download

Firmware download with »EASY Starter (Firmware loader)«



10.15 Firmware download

The device firmware is continuously improved by the manufacturer. New firmware versions contain error corrections, function extensions and simplify the handling.

A new firmware is always compatible with the older version:

- A device with updated firmware and unchanged parameter settings shows the same behaviour as before.
- Parameter settings must only be adapted if new functions are used.

10.15.1 Firmware download with »EASY Starter (Firmware loader)«

The »EASY Starter (firmware loader)« is a PC software which serves to update the firmware of the inverter.

Preconditions

- For the firmware download, we recommend a direct USB connection to the device. For this purpose, the USB module and a USB 2.0 cable (A plug on Micro-B plug) are required. The voltage supply of the control electronics also takes place via the USB connection.
- The control electronics of the inverter must be supplied with voltage. Either via the USB connection or via the external 24-V voltage supply.
- Voltage supply and communication must not be interrupted during the firmware download.



10.16 Additive voltage impression

This function serves to boost (or lower) the motor voltage from the process via an additive voltage setpoint in order to realise a load adjustment (for instance in case of winder applications).

i NOTICE

A too high boost of the motor voltage may cause the motor to heat up strongly due to the resulting current.

► Avoid a too high boost of the motor voltage!

Details

At a constant field frequency, the output voltage of the inverter can be changed within a wide range.

Example: Adaptation of the voltage characteristic in case of V/f characteristic control as a function of the load:

- Clockwise rotation (CW) is operation in motor mode: Boost voltage.
- Counter-clockwise rotation (CCW) is operation in generator mode: Lower voltage.

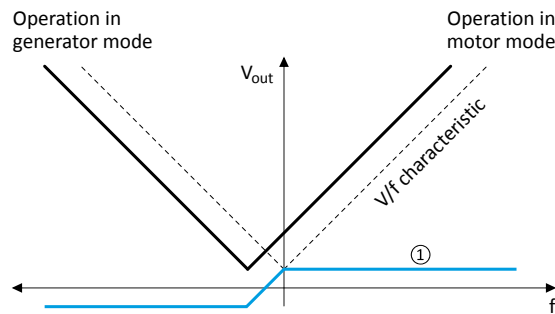

① Selecting an additive voltage setpoint

A detailed configuration example for this function can be found in the following subchapter.

Parameter	Name / value range / [default setting]	Info
0x2B13:001	Additive voltage impression: Enable Function • From version 02.00	1 = enable function.
	0 Disable 1 Enable	
0x2B13:002	Additive voltage impression: Setpoint source • From version 02.00	Selection of the source for specifying the additive voltage setpoint. • 100 % ≙ Rated voltage 0x2C01:007 (P320.07)
	1 Analog input 1 2 Analog input 2	
0x2B13:003	Additive voltage impression: Actual voltage • Read only: x V • From version 02.00	Display of the current (boosted or lowered) voltage.

Additional functions

Additive voltage impression

Example: Using the function with a 400-V inverter



10.16.1 Example: Using the function with a 400-V inverter

With the settings indicated below, the motor is accelerated after the start to 50 Hz. As the base frequency, however, is set very high (here: 599 Hz), the motor voltage at 50 Hz only amounts to 20 VAC.

Now, the analog input 1 serves to change the motor voltage at constant frequency within a wide range:

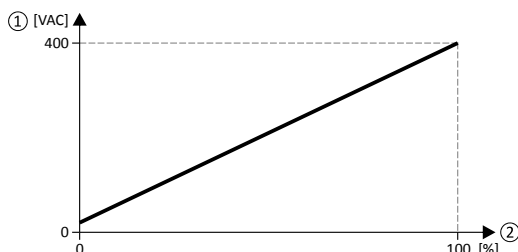

- ① Motor voltage
- ② Selection of an additive voltage setpoint in percent via analog input 1

Parameter	Name	Setting for this example
0x2636:004 (P430.04)	Min PID value	0 %
0x2636:005 (P430.05)	Max PID value	100 %
0x2860:001 (P201.01)	Frequency control: Default setpoint source	Frequency preset 1 [11]
0x2911:001 (P450.01)	Frequency setpoint presets: Preset 1	50 Hz
0x2B01:002 (P303.02)	Base frequency	599 Hz
0x2B13:001	Enable Function	Enable [1]
0x2B13:002	Setpoint source	Analog input 1 [1]



10.17 Parameter for engineering tools

The following parameters are required for an interaction of the engineering tools with the inverter connected online. They are not relevant for the user and only reported here for the sake of completeness.

Parameter	Name / value range / [default setting]	Info
0x2022:032	Device commands: Deactivate PDO Communication	Parameters for interaction with engineering tools.
	0 Off / ready	
	1 On / start	
	2 In progress	
	3 Action cancelled	
	4 No access	
	5 No access (Inverter disabled)	
0x2022:033	Device commands: Activate PDO Communication	
	0 Off / ready	
	1 On / start	
	2 In progress	
	3 Action cancelled	
	4 No access	
	5 No access (Inverter disabled)	
0x2822:001	Axis commands: Enable inverter	
	0 Inverter inhibited	
	1 Inverter enabled	
0x2822:002	Axis commands: Activate quick stop 0 ... [0] ... 1	
0x2822:003	Axis commands: Reset error 0 ... [0] ... 1	
0x2822:028	Axis commands: Initialize device controller 0 ... [0] ... 1	
0x2823:001	Last subindex • Read only	
0x2823:002	Status of last axis command • Read only	
	0 Successful	
	1 Unknown command	
	2 No access	
	3 Time-out	
	4 Error	
	5 Command server assigned	
	6 Disable inverter required	
	7 Enable inverter required	
	8 Command is executed	
	10 Memory module link invalid	
	11 Password too short	
	12 Wrong password	
	13 Password set	
	14 Password assigned	
15 Command aborted		

Additional functions

Parameter for engineering tools



Parameter	Name / value range / [default setting]	Info	
0x2832	Motor identification status		
	• Read only		
	• From version 02.00		
	Bit 0		Identification enabled
	Bit 1		Identification active
	Bit 2		Identification completed
	Bit 3		Identification failed
	Bit 4		Reserved
	Bit 5		Reserved
	Bit 6		Reserved
	Bit 7		Reserved
	Bit 8		Reserved
	Bit 9		Reserved
	Bit 10		Reserved
Bit 11	Reserved		
Bit 12	Reserved		
Bit 13	Reserved		
Bit 14	Reserved		
Bit 15	Reserved		
0x2EFF:001	Bootloader activation key 1 0 ... [0] ... 4294967295 • Setting can only be changed if the inverter is inhibited.		
0x2EFF:002	Bootloader activation key 2 0 ... [0] ... 4294967295 • Setting can only be changed if the inverter is inhibited.		
0x2EFF:003	Bootloader activation key 3 0 ... [0] ... 4294967295 • Setting can only be changed if the inverter is inhibited.		



11 Flexible I/O configuration

Use parameter 0x2631 (P400xx) to individually adapt the inverter control to the respective application. This is basically effected by assigning digital signal sources ("triggers") to functions of the inverter.

i NOTICE

A digital signal source can be assigned to several functions.
Possible consequence: unforeseeable behaviour of the drive in case of incorrect assignment
► Carry out assignment of a digital signal source to several functions with greater care.

Details

- Each subcode of 0x2631 (P400) is permanently assigned to a specific function. Functions are for example "Enable inverter", "Activate quick stop" or "Start forward (CW)".
- For a function, exactly one (digital) trigger can be set:



- Possible triggers to be selected are for example the digital input and internal status signals of the inverter.
- A list of all triggers available can be found in the description for the parameter [0x2631:001 \(P400.01\)](#).
- If the trigger condition is met, the corresponding function is executed. More details with regard to the respective trigger conditions can be gathered from the functional descriptions in the following subchapters.

Example: changing the function assignment of a digital input

Task for this example:

1. The preset assignment of the digital input 3 for "Invert rotation" function is to be cancelled.
2. Instead, the digital input 3 is to be assigned to the "Activate DC braking" function.

For this purpose, the following two settings are required:

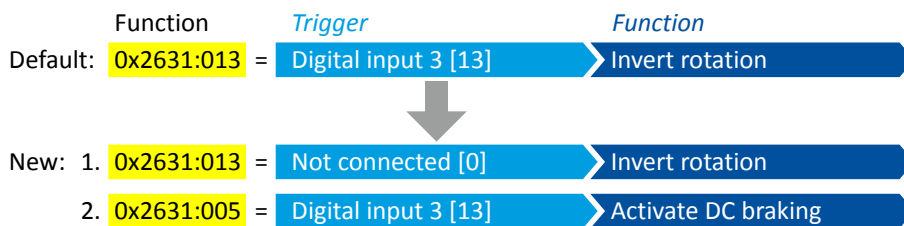

Flexible I/O configuration

Control source change-over



11.1 Control source change-over

The term "control sources" in this connection refers to the digital signal sources from which the inverter receives its start, stop, and reversal commands.

Possible control sources are:

- Digital inputs
- Keypad
- Network

Details

First, select in [0x2824 \(P200.00\)](#) whether the start of the motor is to be configured flexibly (default setting) or exclusively via the keypad. ▶ [Control source selection](#) [□ 88](#)

If "Flexible I/O configuration" is set, a change-over from one control source to another can be effected during operation via the functions listed in the following table. The inverter not only supports such a change-over via its digital inputs, but also as a function of internal inverter states.

Activate keypad control 0x2631:012 (P400.12)	Activate network control 0x2631:037 (P400.37)	Active control source
FALSE / Not connected	FALSE / Not connected	Flexible I/O configuration (default setting) <ul style="list-style-type: none"> • The motor is controlled via the digital inputs. • For preconfigured assignment of the digital inputs, see chapter "Function assignment of the inputs and outputs". □ 38 • For description of the basic functions for controlling the motor, see chapter "Start / stop motor". □ 299
TRUE	Any	Keypad <ul style="list-style-type: none"> • Starting the motor is only possible via the I keypad key. • Exception: Jog operation; see chapter "Start / stop motor". □ 299 ▶ Example 1: Change-over from terminal control to keypad control □ 297
FALSE / Not connected	TRUE	Network <ul style="list-style-type: none"> • Starting the motor is only possible via the network control word. • Exception: Jog operation; see chapter "Start / stop motor". □ 299 ▶ Example 2: Change-over from terminal control to network control □ 298

The following signal flow shows the internal control logics:

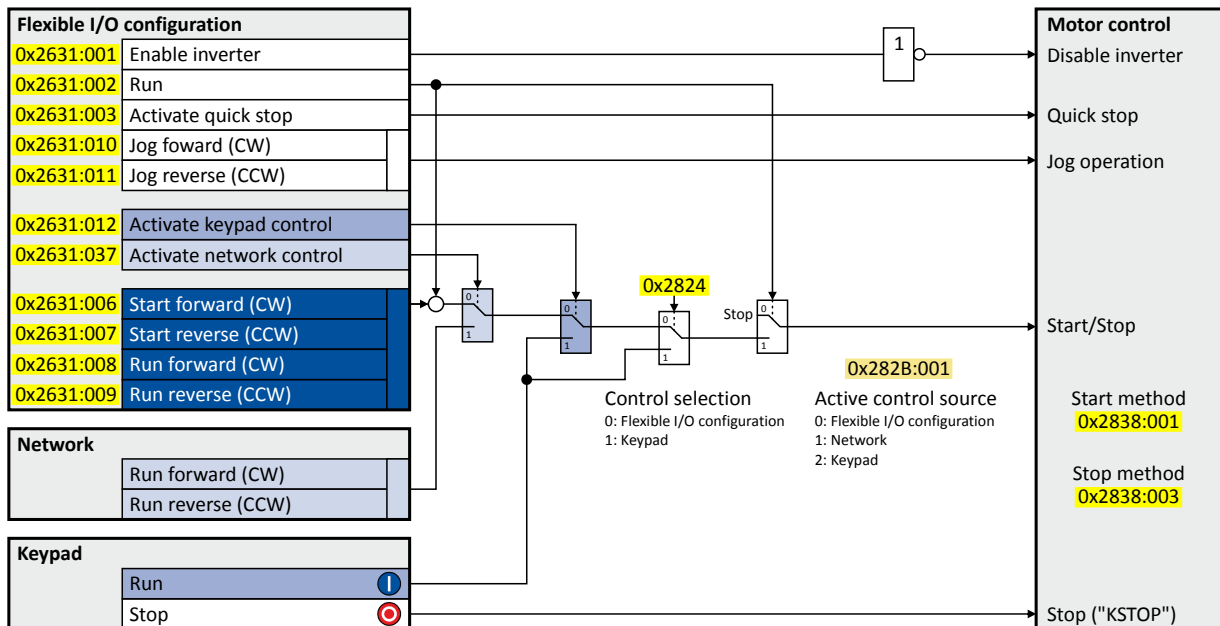



The "Enable inverter" [0x2631:001 \(P400.01\)](#) function must be set to TRUE to start the motor. Either via digital input or by default setting "Constant TRUE [1]". If the function is set to FALSE, the inverter is disabled. The motor becomes torqueless (coasts).

In case of an activated keypad or network control, the "Run" [0x2631:002 \(P400.02\)](#) function must be additionally set to TRUE to start the motor. Either via digital input or by the "Constant TRUE [1]" setting.

Notes:

- In case of an activated keypad or network control, the following functions are still active:
 - [0x2631:001 \(P400.01\)](#): Enable inverter
 - [0x2631:002 \(P400.02\)](#): Run
 - [0x2631:003 \(P400.03\)](#): Activate quick stop
 - [0x2631:004 \(P400.04\)](#): Reset fault
 - [0x2631:005 \(P400.05\)](#): Activate DC braking
 - [0x2631:010 \(P400.10\)](#): Jog forward (CW)
 - [0x2631:011 \(P400.11\)](#): Jog reverse (CCW)
 - [0x2631:012 \(P400.12\)](#): Activate keypad control
 - [0x2631:037 \(P400.37\)](#): Activate network control
- In case of an activated network control, the following additional functions are still active:
 - [0x2631:013 \(P400.13\)](#): Invert rotation
 - The functions for setpoint change-over. ▶ [Setpoint change-over](#) [313](#)

All other functions configurable via [0x2631:xx \(P400.xx\)](#) are deactivated in case of keypad or network control.

Diagnostic parameters:

- [0x282A:001 \(P126.01\)](#): Cause of disable
- [0x282A:002 \(P126.02\)](#): Cause of quick stop
- [0x282A:003 \(P126.03\)](#): Cause of stop
- [0x282B:001 \(P125.01\)](#): Active control source

For description of the basic functions for controlling the motor, see chapter "[Start / stop motor](#)". [299](#)

Parameter	Name / value range / [default setting]	Info
0x2631:012 (P400.12)	Function list: Activate keypad control (Function list: Keypad control) <ul style="list-style-type: none"> For possible settings see description for 0x2631:001 (P400.01). 300 	Assignment of a trigger for the "Activate keypad control" function. Trigger = TRUE: activate keypad as control source. Trigger = FALSE: no action / deactivate keypad as control source again.
	00 Not connected	No trigger assigned (trigger is constantly FALSE).

Flexible I/O configuration

Control source change-over



Parameter	Name / value range / [default setting]	Info
0x2631:037 (P400.37)	Function list: Activate network control (Function list: Network control)	Assignment of a trigger for the "Activate network control" function. Trigger = TRUE: Activate network control. Trigger = FALSE: No action / deactivate network control again.
	0 Not connected	No trigger assigned (trigger is constantly FALSE).
	1 Constant TRUE	Trigger is constantly TRUE.
	11 Digital input 1	State of X3/DI1, taking an inversion set in 0x2632:001 (P411.01) into consideration.
	12 Digital input 2	State of X3/DI2, taking an inversion set in 0x2632:002 (P411.02) into consideration.
	13 Digital input 3	State of X3/DI3, taking an inversion set in 0x2632:003 (P411.03) into consideration.
	14 Digital input 4	State of X3/DI4, taking an inversion set in 0x2632:004 (P411.04) into consideration.
	15 Digital input 5	State of X3/DI5, taking an inversion set in 0x2632:005 (P411.05) into consideration.
	50 Running	TRUE if inverter and start are enabled and output frequency > 0.2 Hz. Otherwise FALSE.
	51 Ready for operation	TRUE if inverter is ready for operation (no error active, no STO active and DC-bus voltage ok). Otherwise FALSE.
	53 Stop active	TRUE if inverter is enabled and motor is not started and output frequency = 0.
	54 Quick stop active	TRUE if quick stop is active. Otherwise FALSE.
	58 Device warning active	TRUE if warning is active. Otherwise FALSE. <ul style="list-style-type: none"> A warning has no impact on the operating status of the inverter. A warning is reset automatically if the cause has been eliminated.
	59 Device fault active	TRUE if a fault is active. Otherwise FALSE. <ul style="list-style-type: none"> In the event of a fault, the motor is brought to a standstill with the quick stop ramp. The inverter is then disabled. Exception: In case of a serious fault, the inverter is disabled immediately. The motor becomes torqueless (coasts). The error state will be left automatically if the error condition is not active anymore. The restart behaviour after trouble can be configured. ▶ Automatic restart □ 280
	60 Heatsink temperature warning active	TRUE if current heatsink temperature > warning threshold for temperature monitoring. Otherwise FALSE. <ul style="list-style-type: none"> Display of the current heatsink temperature in 0x2D84:001 (P117.01). Setting of the warning threshold in 0x2D84:002.
	69 Rotational direction reversed	TRUE if output frequency is negative. Otherwise FALSE.
	70 Frequency threshold exceeded	TRUE if current output frequency > frequency threshold. Otherwise FALSE. <ul style="list-style-type: none"> Display of the current output frequency in 0x2DDD (P100.00). Setting Frequency threshold in 0x4005 (P412.00). ▶ Frequency threshold for "Frequency threshold exceeded" trigger □ 347
	71 Actual speed = 0	TRUE if current output frequency = 0 Hz (± 0.01 Hz), irrespective of the operating mode. Otherwise FALSE. <ul style="list-style-type: none"> Display of the current output frequency in 0x2DDD (P100.00).
	78 Current limit reached	TRUE if current motor current ≥ maximum current. Otherwise FALSE. <ul style="list-style-type: none"> Display of the present motor current in 0x2D88 (P104.00). Setting for the maximum current in 0x6073 (P324.00).
	79 Torque limit reached • From version 02.00	TRUE if torque limit has been reached or exceeded. Otherwise FALSE. <ul style="list-style-type: none"> Setting "Positive torque limit" in 0x60E0. Setting "Negative torque limit" in 0x60E1.
80 Follower signal (4 ... 20 mA) lost	Reserve (do not use trigger)	
81 Error of analog input 1 active	TRUE if the monitoring of the input signal at the analog input 1 has responded. Otherwise FALSE. This trigger is set as a function of the following settings: <ul style="list-style-type: none"> Monitoring threshold 0x2636:008 (P430.08) Monitoring condition 0x2636:009 (P430.09) The setting of the Error response in 0x2636:010 (P430.10) has no effect on this trigger. ▶ Analog input 1 □ 349	



Flexible I/O configuration

Control source change-over

Parameter	Name / value range / [default setting]	Info
	82 Error of analog input 2 active	TRUE if the monitoring of the input signal at the analog input 2 has responded. Otherwise FALSE. This trigger is set as a function of the following settings: <ul style="list-style-type: none"> Monitoring threshold 0x2637:008 (P431.08) Monitoring condition 0x2637:009 (P431.09) The setting of the Error response in 0x2637:010 (P431.10) has no effect on this trigger. ▶ Analog input 2 □ 353
	83 Load loss detected	TRUE if actual motor current < threshold for load loss detection after delay time of the load loss detection has elapsed. Otherwise FALSE. <ul style="list-style-type: none"> Display of the present motor current in 0x6078 (P103.00). Setting Threshold in 0x4006:001 (P710.01). Setting Deceleration in 0x4006:002 (P710.02). ▶ Load loss detection □ 231
	104 Local control active	TRUE if local keypad control ("LOC") active. Otherwise FALSE.
	105 Remote control active	TRUE if remote control ("REM") via terminals, network, etc. active. Otherwise FALSE.
	106 Manual setpoint selection active	TRUE if manual setpoint selection ("MAN") via keypad active. Otherwise FALSE. <ul style="list-style-type: none"> Selection of the trigger for the "Activate keypad setpoint" function in 0x2631:016 (P400.16).
	107 Automatic setpoint selection active	TRUE if automatic setpoint selection ("AUTO") via terminals, network, etc. active. Otherwise FALSE.
	114 Network control active <ul style="list-style-type: none"> From version 02.00 	TRUE if network control activated. Otherwise FALSE.
0x2824 (P200.00)	Control selection (Control select.)	Selection of the type of inverter control.
	0 Flexible I/O configuration	This selection enables a flexible assignment of the start, stop, and rotating direction commands with digital signal sources. <ul style="list-style-type: none"> Digital signal sources can be digital inputs, network and keypad. The I/O configuration is made via the parameters 0x2631:xx (P400.xx).
	1 Keypad	This selection enables the motor to be started exclusively via the start key of the keypad. Other signal sources for starting the motor are ignored. <input checked="" type="radio"/> Start motor <input type="radio"/> Stop motor Note! <ul style="list-style-type: none"> The functions "Enable inverter" 0x2631:001 (P400.01) and "Run" 0x2631:002 (P400.02) must be set to TRUE to start the motor. If jog operation is active, the motor cannot be stopped via the <input checked="" type="radio"/> keypad key.

Flexible I/O configuration

Control source change-over

Example 1: Change-over from terminal control to keypad control



11.1.1 Example 1: Change-over from terminal control to keypad control

- The control is executed primarily via the I/O terminals: Switch S1 serves to start and stop the motor.
- Switch S2 serves to optionally change over to local keypad control. In case of activated keypad control, the motor can only be started via the ① keypad key. However, the condition is that switch S1 is closed.
- If switch S1 is opened again or the ② keypad key is pressed, the motor is stopped (irrespective of the active control source).

Connection plan	function
	Potentiometer R1: Frequency setpoint selection
	Switch S1: Run
	Switch S2: Activate keypad control

Parameter	Name	Setting for this example
0x2631:001 (P400.01)	Enable inverter	Constant TRUE [1]
0x2631:002 (P400.02)	Run	Digital input 1 [11]
0x2631:004 (P400.04)	Reset fault	Not connected [0]
0x2631:012 (P400.12)	Activate keypad control	Digital input 2 [12]
0x2824 (P200.00)	Control selection	Flexible I/O configuration [0]

Input signals

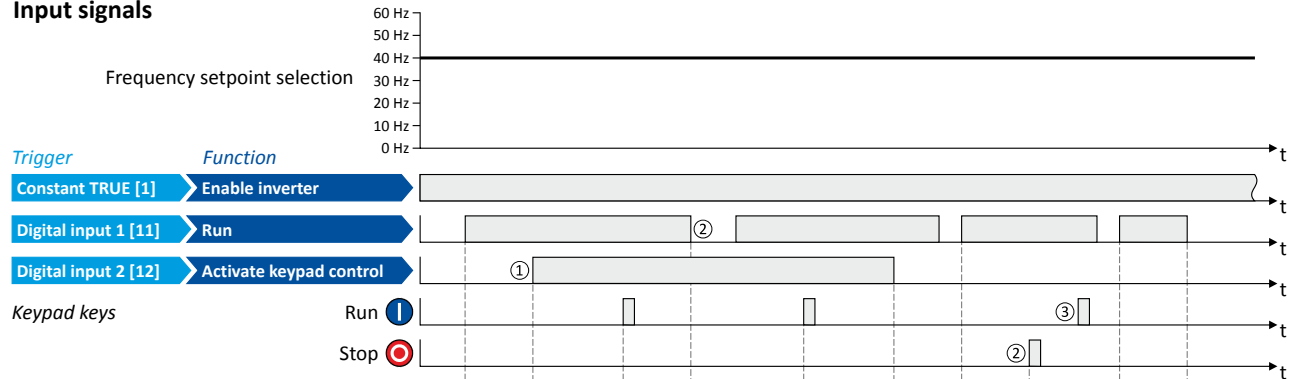

Output signals

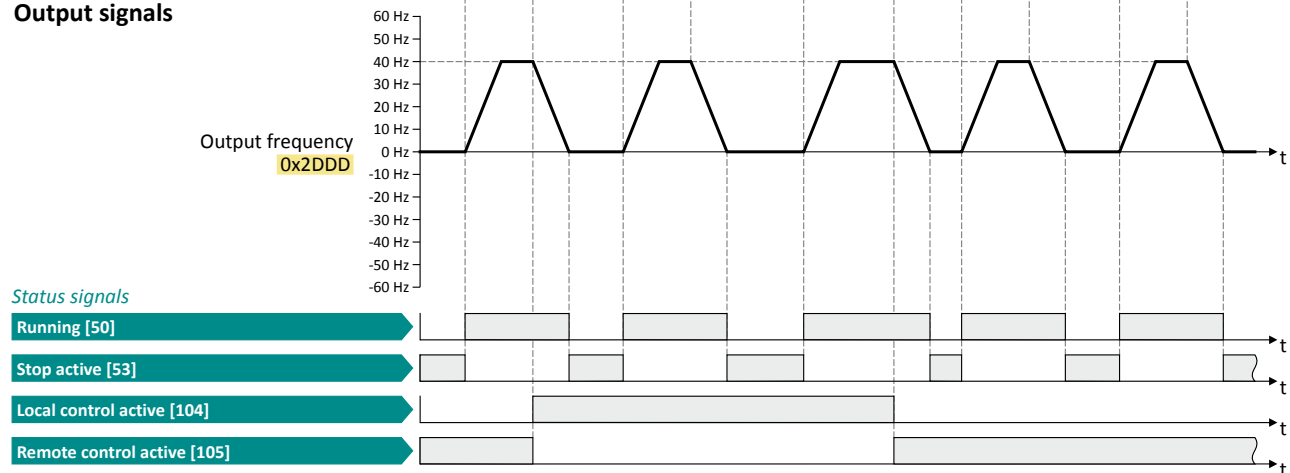

The status signals can be assigned to digital outputs. ▶ [Configuration of digital outputs](#) 355

- When changing over to another control source, the motor is first stopped with the stop method set in 0x2838:003 (P203.03).
- The motor will also be stopped if the "Run" function is deactivated or the ② keypad key is pressed (irrespective of the active control source).
- After stopping with the ② keypad key and before a renewed start command from another control source, the ① key on the keypad must be pressed to cancel the keypad stop again ("KSTOP").



Flexible I/O configuration

Control source change-over

Example 2: Change-over from terminal control to network control

11.1.2 Example 2: Change-over from terminal control to network control

- The control is executed primarily via the I/O terminals: Switch S1 serves to start and stop the motor.
- Switch S2 serves to activate the network control. In case of activated keypad control, the motor can only be started via the network control word. However, the condition is that switch S1 is closed.
- If switch S1 is opened again, the motor is stopped (irrespective of the active control source).

Connection plan	function
	Potentiometer R1: Frequency setpoint selection
	Switch S1: Run
	Switch S2: Activate network control

Parameter	Name	Setting for this example
0x2631:001 (P400.01)	Enable inverter	Constant TRUE [1]
0x2631:002 (P400.02)	Run	Digital input 1 [11]
0x2631:004 (P400.04)	Reset fault	Not connected [0]
0x2631:037 (P400.37)	Activate network control	Digital input 2 [12]
0x2824 (P200.00)	Control selection	Flexible I/O configuration [0]

Input signals

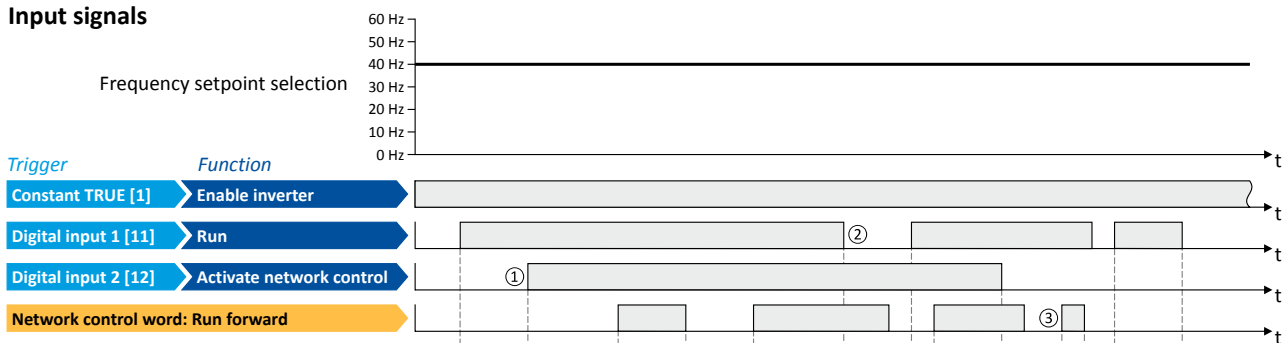

Output signals

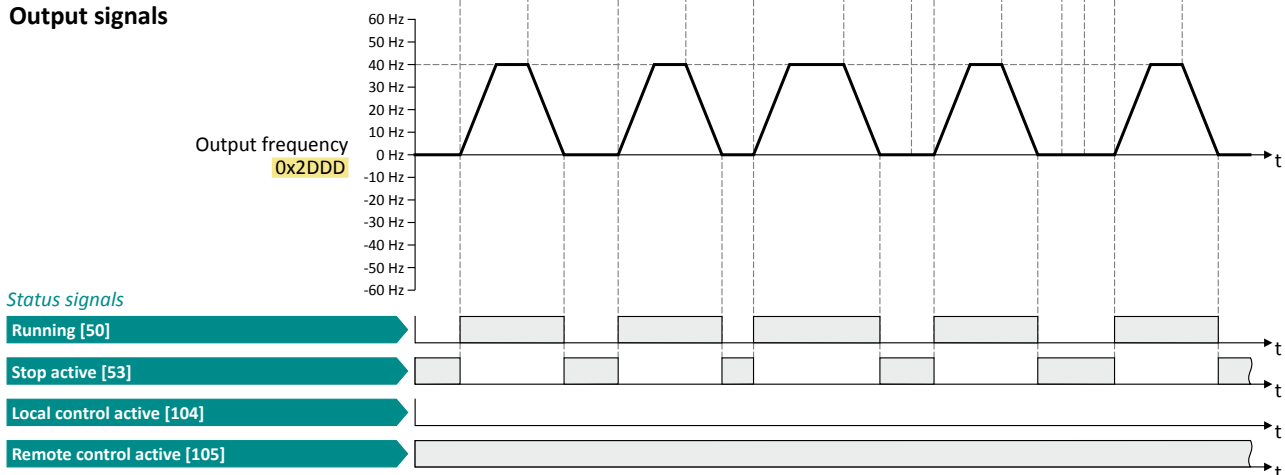

The status signals can be assigned to digital outputs. [► Configuration of digital outputs 355](#)

- ① When changing over to another control source, the motor is first stopped with the stop method set in [0x2838:003 \(P203.03\)](#).
- ② The motor will also be stopped if the "Run" function is deactivated (irrespective of the active control source).
- ③ Commands via network are ignored if the network control is not active.

Flexible I/O configuration

Start / stop motor

Example 2: Change-over from terminal control to network control



11.2 Start / stop motor

Configuration of the triggers for the basic functions for controlling the motor.

Details

The following table contains a short overview of the basic functions. For more details see the following parameter descriptions.

function	Info
Enable inverter 0x2631:001 (P400.01)	<p>Enable/disable operation.</p> <ul style="list-style-type: none"> The function must be set to TRUE to start the motor. Either via digital input or by default setting "Constant TRUE [1]". If the function is set to FALSE, the inverter is disabled. The motor becomes torqueless (coasts). <p>▶ Example 6: Enable inverter □ 312</p>
Run 0x2631:002 (P400.02)	<p>Function 1: Start / stop motor (default setting)</p> <ul style="list-style-type: none"> Function 1 is active if no further start commands (start forward/start reverse) have been connected to triggers, no keypad control is active and no network control is active. <p>TRUE: Let motor rotate forward (CW). FALSE: Stop motor.</p> <p>▶ Example 1: Start/stop (1 signal) and reversal □ 304</p> <p>Function 2: Start enable/stop motor</p> <ul style="list-style-type: none"> Function 2 is active if further start commands have been connected to triggers, keypad control is active or network control is active. <p>TRUE: Start commands of the active control source are enabled. FALSE: Stop motor.</p> <p>▶ Example 2: Start forward/start reverse/stop (edge-controlled) □ 305 ▶ Example 3: Run forward/Run reverse/stop (status-controlled) □ 307</p>
Activate quick stop 0x2631:003 (P400.03)	<p>Bring motor to a standstill in best time.</p> <p>▶ Example 4: Quick stop □ 309</p>
Start forward (CW) 0x2631:006 (P400.06)	<p>Start motor edge-controlled.</p> <ul style="list-style-type: none"> In order to be able to start the motor, the "Run" function must be set to TRUE. The motor is stopped by resetting the "Run" function to FALSE. Functions are deactivated in case of keypad or network control. <p>▶ Example 2: Start forward/start reverse/stop (edge-controlled) □ 305</p>
Start reverse (CCW) 0x2631:007 (P400.07)	
Run forward (CW) 0x2631:008 (P400.08)	<p>Let the motor rotate in a status-controlled way.</p> <ul style="list-style-type: none"> In order to be able to start the motor, the "Run" function must be set to TRUE. Functions are deactivated in case of keypad or network control. <p>▶ Example 3: Run forward/Run reverse/stop (status-controlled) □ 307</p>
Run reverse (CCW) 0x2631:009 (P400.09)	
Jog forward (CW) 0x2631:010 (P400.10)	<p>Jog operation: Let the motor rotate in a status-controlled way with setpoint preset.</p> <p>⚠ CAUTION!</p> <p>The jog operation has a higher priority than the "Run" function, all other start commands and the keypad key .</p> <ul style="list-style-type: none"> If jog operation is active, the motor cannot be stopped with the previously mentioned functions! However, jog operation can be interrupted by the "Quick stop" function. Jog operation can always be activated, even in case of keypad or network control. <p>▶ Example 5: Jog forward/Jog reverse □ 310</p>
Jog reverse (CCW) 0x2631:011 (P400.11)	
Invert rotation 0x2631:013 (P400.13)	<p>Invert frequency setpoint.</p> <ul style="list-style-type: none"> Function can be used in combination with all start commands. Function is deactivated in case of network control. <p>▶ Example 1: Start/stop (1 signal) and reversal □ 304</p>

Assignment guidelines

The error message "Trigger/functions connected incorrectly" (error code [25216 | 0x6280](#)) is output if one of the following assignment guidelines is not observed:

- If the "flexible I/O configuration" is active as control source, the "Enable inverter" function or the "Run" function must be connected to a digital input in order that the motor can be stopped again any time!
- In case of keypad or network control, the two functions "Enable inverter" and "Run" can also be set to "Constant TRUE [1]" to start the motor.
- The use of the "Start forward (CW)" and "Start reverse (CCW)" functions excludes the use of the "Run forward (CW)" and "Run reverse (CCW)" and vice versa.



Flexible I/O configuration

Start / stop motor

Example 2: Change-over from terminal control to network control

Parameter	Name / value range / [default setting]	Info	
0x2631:001 (P400.01)	Function list: Enable inverter (Function list: Enable inverter) <ul style="list-style-type: none"> Setting can only be changed if the inverter is inhibited. 	Assignment of a trigger for the "Enable inverter" function. Trigger = TRUE: The inverter is enabled (unless there is another cause for inverter disable). Trigger = FALSE: The inverter is disabled. Notes: <ul style="list-style-type: none"> This function must be set to TRUE to start the motor. Either via an assigned digital input or by default setting "Constant TRUE [1]". Changing to the inhibited state causes an immediate stop of the motor, regardless of the stop method set in 0x2838:003 (P203.03). The motor becomes torqueless and coasts down as a function of the mass inertia of the machine. The cause(s) that are active for the disabled state are shown in 0x282A:001 (P126.01). 	
	0	Not connected	No trigger assigned (trigger is constantly FALSE).
	1	Constant TRUE	Trigger is constantly TRUE.
	11	Digital input 1	State of X3/DI1, taking an inversion set in 0x2632:001 (P411.01) into consideration.
	12	Digital input 2	State of X3/DI2, taking an inversion set in 0x2632:002 (P411.02) into consideration.
	13	Digital input 3	State of X3/DI3, taking an inversion set in 0x2632:003 (P411.03) into consideration.
	14	Digital input 4	State of X3/DI4, taking an inversion set in 0x2632:004 (P411.04) into consideration.
	15	Digital input 5	State of X3/DI5, taking an inversion set in 0x2632:005 (P411.05) into consideration.
	50	Running	TRUE if inverter and start are enabled and output frequency > 0.2 Hz. Otherwise FALSE.
	51	Ready for operation	TRUE if inverter is ready for operation (no error active, no STO active and DC-bus voltage ok). Otherwise FALSE.
	53	Stop active	TRUE if inverter is enabled and motor is not started and output frequency = 0.
	54	Quick stop active	TRUE if quick stop is active. Otherwise FALSE.
	58	Device warning active	TRUE if warning is active. Otherwise FALSE. <ul style="list-style-type: none"> A warning has no impact on the operating status of the inverter. A warning is reset automatically if the cause has been eliminated.
	59	Device fault active	TRUE if a fault is active. Otherwise FALSE. <ul style="list-style-type: none"> In the event of a fault, the motor is brought to a standstill with the quick stop ramp. The inverter is then disabled. Exception: In case of a serious fault, the inverter is disabled immediately. The motor becomes torqueless (coasts). The error state will be left automatically if the error condition is not active anymore. The restart behaviour after trouble can be configured. ▶ Automatic restart □ 280
	60	Heatsink temperature warning active	TRUE if current heatsink temperature > warning threshold for temperature monitoring. Otherwise FALSE. <ul style="list-style-type: none"> Display of the current heatsink temperature in 0x2D84:001 (P117.01). Setting of the warning threshold in 0x2D84:002.
	69	Rotational direction reversed	TRUE if output frequency is negative. Otherwise FALSE.
70	Frequency threshold exceeded	TRUE if current output frequency > frequency threshold. Otherwise FALSE. <ul style="list-style-type: none"> Display of the current output frequency in 0x2DDD (P100.00). Setting Frequency threshold in 0x4005 (P412.00). ▶ Frequency threshold for "Frequency threshold exceeded" trigger □ 347 	
71	Actual speed = 0	TRUE if current output frequency = 0 Hz (± 0.01 Hz), irrespective of the operating mode. Otherwise FALSE. <ul style="list-style-type: none"> Display of the current output frequency in 0x2DDD (P100.00). 	
78	Current limit reached	TRUE if current motor current ≥ maximum current. Otherwise FALSE. <ul style="list-style-type: none"> Display of the present motor current in 0x2D88 (P104.00). Setting for the maximum current in 0x6073 (P324.00). 	

Flexible I/O configuration

Start / stop motor

Example 2: Change-over from terminal control to network control



Parameter	Name / value range / [default setting]	Info
	79 Torque limit reached • From version 02.00	TRUE if torque limit has been reached or exceeded. Otherwise FALSE. • Setting "Positive torque limit" in 0x60E0 . • Setting "Negative torque limit" in 0x60E1 .
	80 Follower signal (4 ... 20 mA) lost	Reserve (do not use trigger)
	81 Error of analog input 1 active	TRUE if the monitoring of the input signal at the analog input 1 has responded. Otherwise FALSE. This trigger is set as a function of the following settings: • Monitoring threshold 0x2636:008 (P430.08) • Monitoring condition 0x2636:009 (P430.09) The setting of the Error response in 0x2636:010 (P430.10) has no effect on this trigger. ▶ Analog input 1 □ 349
	82 Error of analog input 2 active	TRUE if the monitoring of the input signal at the analog input 2 has responded. Otherwise FALSE. This trigger is set as a function of the following settings: • Monitoring threshold 0x2637:008 (P431.08) • Monitoring condition 0x2637:009 (P431.09) The setting of the Error response in 0x2637:010 (P431.10) has no effect on this trigger. ▶ Analog input 2 □ 353
	83 Load loss detected	TRUE if actual motor current < threshold for load loss detection after delay time of the load loss detection has elapsed. Otherwise FALSE. • Display of the present motor current in 0x6078 (P103.00) . • Setting Threshold in 0x4006:001 (P710.01) . • Setting Deceleration in 0x4006:002 (P710.02) . ▶ Load loss detection □ 231
	104 Local control active	TRUE if local keypad control ("LOC") active. Otherwise FALSE.
	105 Remote control active	TRUE if remote control ("REM") via terminals, network, etc. active. Otherwise FALSE.
	106 Manual setpoint selection active	TRUE if manual setpoint selection ("MAN") via keypad active. Otherwise FALSE. • Selection of the trigger for the "Activate keypad setpoint" function in 0x2631:016 (P400.16) .
	107 Automatic setpoint selection active	TRUE if automatic setpoint selection ("AUTO") via terminals, network, etc. active. Otherwise FALSE.
0x2631:002 (P400.02)	Function list: Run (Function list: Run) • Setting can only be changed if the inverter is inhibited. • For possible settings see description for 0x2631:001 (P400.01) . □ 299	Assignment of a trigger for the "Run" function. Function 1: Start / stop motor (default setting) Function 1 is active if no further start commands (start forward/start reverse) have been connected to triggers, no keypad control is active and no network control is active. Trigger = TRUE: Let motor rotate forward (CW). Trigger = FALSE: Stop motor. Notes to function 1: • If "Enable inverter" 0x2631:001 (P400.01) is set = "Constant TRUE [1]", the only permissible trigger for this function is a digital input in order that the motor can be stopped again any time. • The stop method can be selected in 0x2838:003 (P203.03) . • The function also serves to realise an automatic start after switch-on. ▶ Starting performance □ 91 Function 2: Start enable/stop motor Function 2 is active if further start commands have been connected to triggers, keypad control is active or network control is active. Trigger = TRUE: Start commands of the active control source are enabled. Trigger = FALSE: Stop motor. Notes to function 2: • If no separate start enable is required for the application, the trigger "Constant TRUE [1]" must be set. • The stop method can be selected in 0x2838:003 (P203.03) .
	11 Digital input 1	State of X3/DI1, taking an inversion set in 0x2632:001 (P411.01) into consideration.



Flexible I/O configuration

Start / stop motor

Example 2: Change-over from terminal control to network control

Parameter	Name / value range / [default setting]	Info
0x2631:003 (P400.03)	Function list: Activate quick stop (Function list: Quick stop) <ul style="list-style-type: none"> Setting can only be changed if the inverter is inhibited. For possible settings see description for 0x2631:001 (P400.01). □ 299 	Assignment of a trigger for the "Activate quick stop" function. Trigger = TRUE: Activate quick stop. Trigger = FALSE: Deactivate quick stop. Notes: <ul style="list-style-type: none"> The "Quick stop" function brings the motor to a standstill within the deceleration time set in 0x291C (P225.00).
	00 Not connected	No trigger assigned (trigger is constantly FALSE).
0x2631:006 (P400.06)	Function list: Start forward (CW) (Function list: Start forward) <ul style="list-style-type: none"> Setting can only be changed if the inverter is inhibited. For possible settings see description for 0x2631:001 (P400.01). □ 299 	Assignment of a trigger for the "Start forward (CW)" function. Trigger = FALSE \nearrow TRUE (edge): Let motor rotate forward. Trigger = TRUE \searrow FALSE (edge): No action. Notes: <ul style="list-style-type: none"> In order to start the motor, "Enable inverter" 0x2631:001 (P400.01) and "Run" 0x2631:002 (P400.02) must be set to TRUE. After the start, the motor runs until "Run" is set to FALSE, another stop command is given or the inverter is disabled. In the case of a bipolar setpoint selection (e.g ± 10 V), the function is executed irrespective of the rotating direction. The rotating direction is determined by the sign of the setpoint.
	00 Not connected	No trigger assigned (trigger is constantly FALSE).
0x2631:007 (P400.07)	Function list: Start reverse (CCW) (Function list: Start reverse) <ul style="list-style-type: none"> Setting can only be changed if the inverter is inhibited. For possible settings see description for 0x2631:001 (P400.01). □ 299 	Assignment of a trigger for the "Start reverse (CCW)" function Trigger = FALSE \nearrow TRUE (edge): Let motor rotate backward. Trigger = TRUE \searrow FALSE (edge): No action. Notes: <ul style="list-style-type: none"> In order to start the motor, "Enable inverter" 0x2631:001 (P400.01) and "Run" 0x2631:002 (P400.02) must be set to TRUE. After the start, the motor runs until "Run" is set to FALSE, another stop command is given or the inverter is disabled. In the case of a bipolar setpoint selection (e.g ± 10 V), the function is executed irrespective of the rotating direction. The rotating direction is determined by the sign of the setpoint.
	00 Not connected	No trigger assigned (trigger is constantly FALSE).
0x2631:008 (P400.08)	Function list: Run forward (CW) (Function list: Run forward) <ul style="list-style-type: none"> Setting can only be changed if the inverter is inhibited. For possible settings see description for 0x2631:001 (P400.01). □ 299 	Assignment of a trigger for the "Run forward (CW)" function. Trigger = TRUE: Let motor rotate forward. Trigger = FALSE: Stop motor. Notes: <ul style="list-style-type: none"> In order to start the motor, "Enable inverter" 0x2631:001 (P400.01) and "Run" 0x2631:002 (P400.02) must be set to TRUE. The inverter always responds to the run command detected last (if start enable is available). The stop method can be selected in 0x2838:003 (P203.03). In the case of a bipolar setpoint selection (e.g ± 10 V), the function is executed irrespective of the rotating direction. The rotating direction is determined by the sign of the setpoint. The "Run forward (CW)" function also serves to realise an automatic start after switch-on. ▶ Starting performance □ 91
	00 Not connected	No trigger assigned (trigger is constantly FALSE).
0x2631:009 (P400.09)	Function list: Run reverse (CCW) (Function list: Run reverse) <ul style="list-style-type: none"> Setting can only be changed if the inverter is inhibited. For possible settings see description for 0x2631:001 (P400.01). □ 299 	Assignment of a trigger for the "Run reverse (CCW)" function. Trigger = TRUE: Let motor rotate backward. Trigger = FALSE: Stop motor. Notes: <ul style="list-style-type: none"> In order to start the motor, "Enable inverter" 0x2631:001 (P400.01) and "Run" 0x2631:002 (P400.02) must be set to TRUE. The inverter always responds to the run command detected last (if start enable is available). The stop method can be selected in 0x2838:003 (P203.03). In the case of a bipolar setpoint selection (e.g ± 10 V), the function is executed irrespective of the rotating direction. The rotating direction is determined by the sign of the setpoint. The "Run reverse (CCW)" function also serves to realise an automatic start after switch-on. ▶ Starting performance □ 91
	00 Not connected	No trigger assigned (trigger is constantly FALSE).

Flexible I/O configuration

Start / stop motor

Example 2: Change-over from terminal control to network control



Parameter	Name / value range / [default setting]	Info
0x2631:010 (P400.10)	Function list: Jog forward (CW) (Function list: Jog forward) <ul style="list-style-type: none"> Setting can only be changed if the inverter is inhibited. For possible settings see description for 0x2631:001 (P400.01). □ 299 	Assignment of a trigger for the "Jog forward (CW)" function. Trigger = TRUE: Let motor rotate forward with preset 5. Trigger = FALSE: Stop motor. ⚠ CAUTION! The jog operation has a higher priority than the "Run" function, all other start commands and the keypad key ⏏ . <ul style="list-style-type: none"> If jog operation is active, the motor cannot be stopped with the previously mentioned functions! However, jog operation can be interrupted by the "Quick stop" function. Notes: <ul style="list-style-type: none"> The preset value 5 can be set in 0x2911:005 (P450.05). The stop method can be selected in 0x2838:003 (P203.03). If "Jog forward (CW)" and "Jog reverse (CCW)" are activated at the same time, the motor is stopped using the stop method and jog operation must be triggered again. Jog operation cannot be started automatically. The "Start at power-up" option in 0x2838:002 (P203.02) does not apply to jog operation.
	00 Not connected	No trigger assigned (trigger is constantly FALSE).
0x2631:011 (P400.11)	Function list: Jog reverse (CCW) (Function list: Jog reverse) <ul style="list-style-type: none"> Setting can only be changed if the inverter is inhibited. For possible settings see description for 0x2631:001 (P400.01). □ 299 	Assignment of a trigger for the "Jog reverse (CCW)" function. Trigger = TRUE: Let motor rotate backward with preset 6. Trigger = FALSE: Stop motor. ⚠ CAUTION! The jog operation has a higher priority than the "Run" function, all other start commands and the keypad key ⏏ . <ul style="list-style-type: none"> If jog operation is active, the motor cannot be stopped with the previously mentioned functions! However, jog operation can be interrupted by the "Quick stop" function. Notes: <ul style="list-style-type: none"> The preset value 6 can be set in 0x2911:006 (P450.06). The stop method can be selected in 0x2838:003 (P203.03). If "Jog forward (CW)" and "Jog reverse (CCW)" are activated at the same time, the motor is stopped using the stop method and jog operation must be triggered again. Jog operation cannot be started automatically. The "Start at power-up" option in 0x2838:002 (P203.02) does not apply to jog operation.
	00 Not connected	No trigger assigned (trigger is constantly FALSE).
0x2631:013 (P400.13)	Function list: Invert rotation (Function list: Invert rotation) <ul style="list-style-type: none"> Setting can only be changed if the inverter is inhibited. For possible settings see description for 0x2631:001 (P400.01). □ 299 	Assignment of a trigger for the "Invert rotation" function. Trigger = TRUE: the setpoint specified is inverted (i. e. the sign is inverted). Trigger = FALSE: no action / deactivate function again.
	13 Digital input 3	State of X3/DI3, taking an inversion set in 0x2632:003 (P411.03) into consideration.



11.2.1 Example 1: Start/stop (1 signal) and reversal

This example shows a simple control option via two switches which should be sufficient for many applications:

- Switch S1 starts the motor in forward direction of rotation. Switch S1 in the initial position stops the motor again.
- Switch S2 switches the direction of rotation.

Connection plan	function
	Potentiometer R1: Frequency setpoint selection
	Switch S1: Run
	Switch S2: Invert rotation

The example uses the preset I/O configuration of the inverter:

Parameter	Name	Setting for this example (corresponds to default setting)
0x2631:001 (P400.01)	Enable inverter	Constant TRUE [1]
0x2631:002 (P400.02)	Run	Digital input 1 [11]
0x2631:013 (P400.13)	Invert rotation	Digital input 3 [13]

Input signals

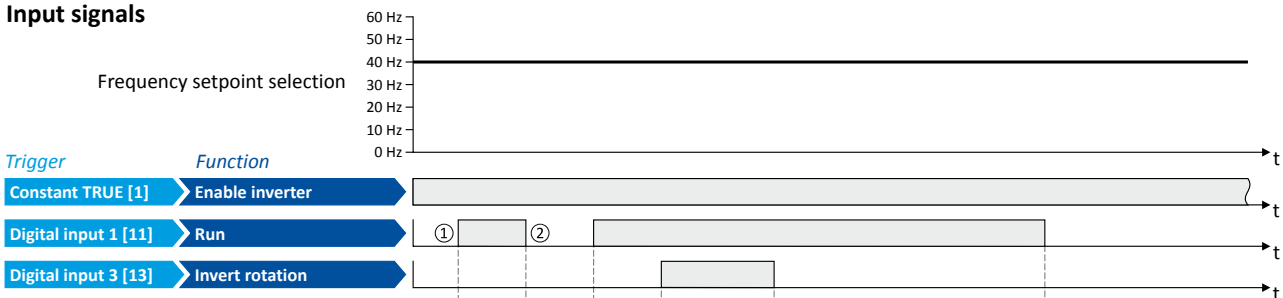

Output signals

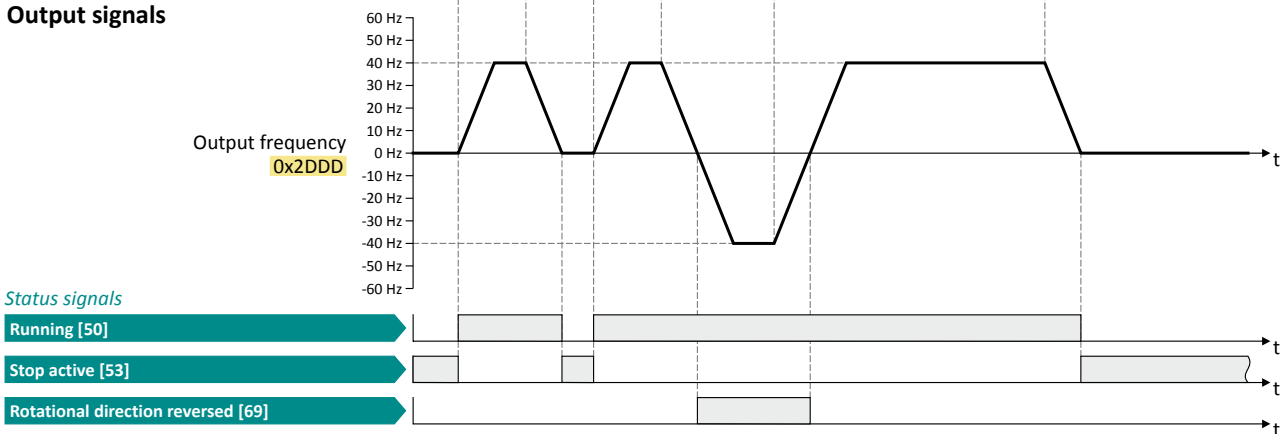

The status signals can be assigned to digital outputs. [► Configuration of digital outputs □ 355](#)

- ① If the inverter is enabled and no error is active, the motor can be started with the "Run" function in forward rotating direction.
- ② If "Run" is set to FALSE, the motor is stopped with the stop method set in 0x2838:003 (P203.03). In the example: Stop with standard ramp.

Flexible I/O configuration

Start / stop motor

Example 2: Start forward/start reverse/stop (edge-controlled)



11.2.2 Example 2: Start forward/start reverse/stop (edge-controlled)



The "Run" function automatically becomes a "start enable" if the functions "Start forward (CW)" / "Start reverse (CCW)" are connected to triggers.

This example shows an edge-controlled start/stop via three buttons:

- In the non-operating state of button S1 (normally-closed contact), there is already a start enable.
- Button S2 starts the motor in forward rotating direction.
- Button S3 starts the motor in backward rotating direction.
- Button S1 (normally-closed contact) stops the motor by (short-time) cancellation of the start command. The inverter then waits for the next start command via button S2/S3.

Connection plan	function	
	Potentiometer R1	Frequency setpoint selection
	Button S1	Stopping
	Button S2	Start forward (CW)
	Button S3	Start reverse (CCW)

Parameter	Name	Setting for this example
0x2631:001 (P400.01)	Enable inverter	Constant TRUE [1]
0x2631:002 (P400.02)	Run	Digital input 1 [11]
0x2631:004 (P400.04)	Reset fault	Not connected [0]
0x2631:006 (P400.06)	Start forward (CW)	Digital input 2 [12]
0x2631:007 (P400.07)	Start reverse (CCW)	Digital input 3 [13]
0x2631:013 (P400.13)	Invert rotation	Not connected [0]



Flexible I/O configuration

Start / stop motor

Example 2: Start forward/start reverse/stop (edge-controlled)

Input signals

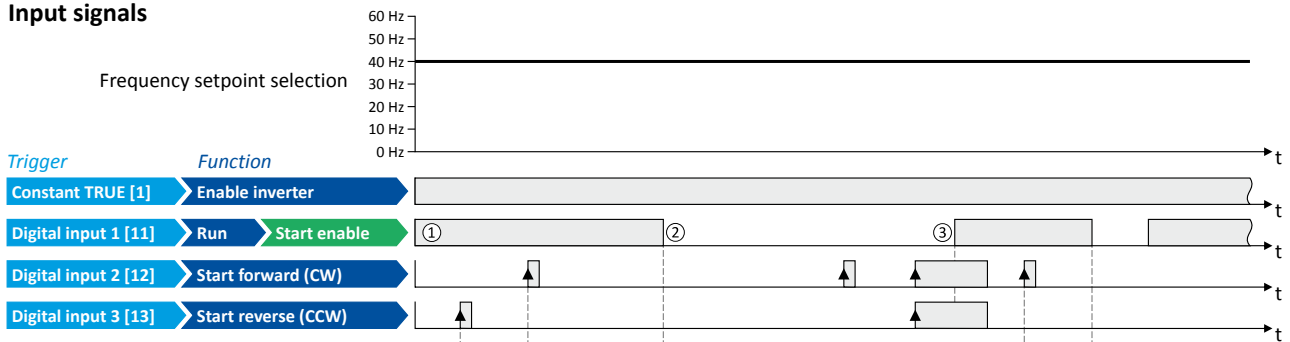

Output signals

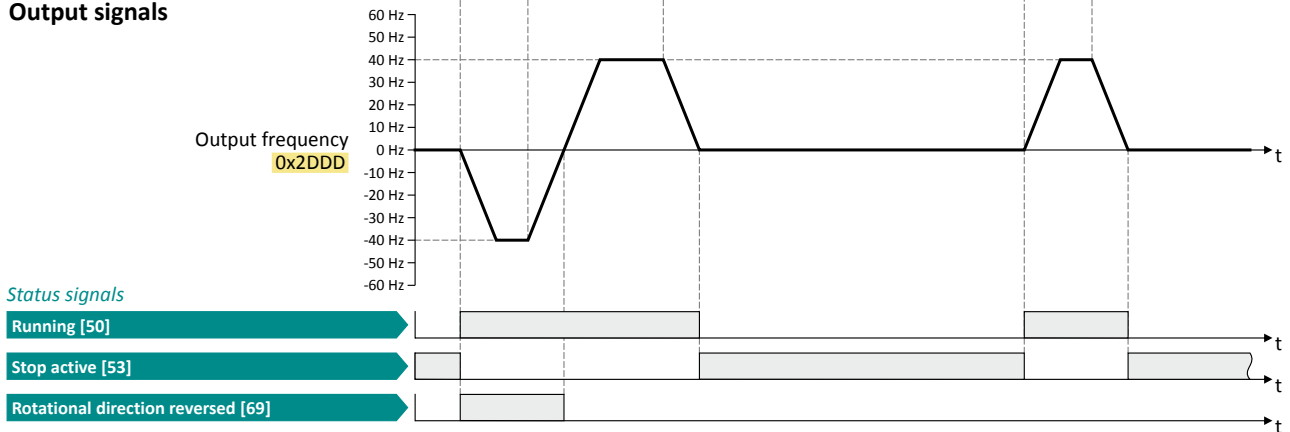

The status signals can be assigned to digital outputs. ▶ [Configuration of digital outputs](#) 355

- ① The "Run" functions serves as start enable for the functions "Start forward (CW)" and "Start reverse (CCW)". Without start enable, the motor cannot be started.
- ② If the start command is cancelled, the motor is stopped with the stop method set in [0x2838:003 \(P203.03\)](#). In the example: Stop with standard ramp.
- ③ If, at start enable, "Start forward (CW)" and "Start reverse (CCW)" are already set to TRUE, the motor remains stopped and the inverter waits for the next valid start edge.

Flexible I/O configuration

Start / stop motor

Example 3: Run forward/Run reverse/stop (status-controlled)



11.2.3 Example 3: Run forward/Run reverse/stop (status-controlled)



The "Run" function automatically becomes a "start enable" if the functions "Run forward (CW)"/"Run reverse (CCW)" are connected to triggers.

This example shows a status-controlled start/stop via three switches:

- Switch S1 enables the start. Without start enable, the motor cannot be started.
- Switch S2 starts the motor in forward direction of rotation.
- Switch S3 starts the motor in backward direction of rotation.
- The motor is stopped by cancelling the run commands (switches S2 and S3 open) or by cancelling the start enable (switch S1 open).

Connection plan		function	
		Potentiometer R1	Frequency setpoint selection
		Switch S1	Start enable
		Switch S2	Run forward (CW)
		Switch S3	Run reverse (CCW)
Parameter	Name	Setting for this example	
0x2631:001 (P400.01)	Enable inverter	Constant TRUE [1]	
0x2631:002 (P400.02)	Run	Digital input 1 [11]	
0x2631:004 (P400.04)	Reset fault	Not connected [0]	
0x2631:008 (P400.08)	Run forward (CW)	Digital input 2 [12]	
0x2631:009 (P400.09)	Run reverse (CCW)	Digital input 3 [13]	
0x2631:013 (P400.13)	Invert rotation	Not connected [0]	



Flexible I/O configuration

Start / stop motor

Example 3: Run forward/Run reverse/stop (status-controlled)

Input signals

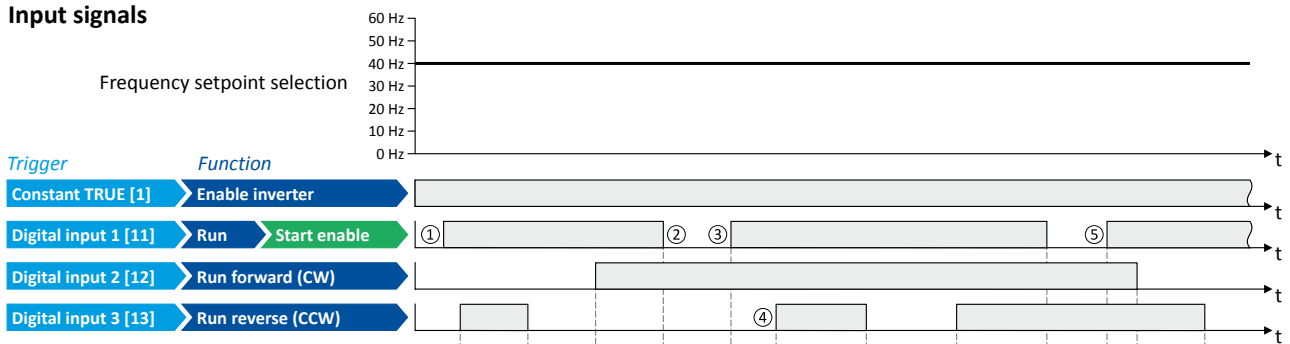

Output signals

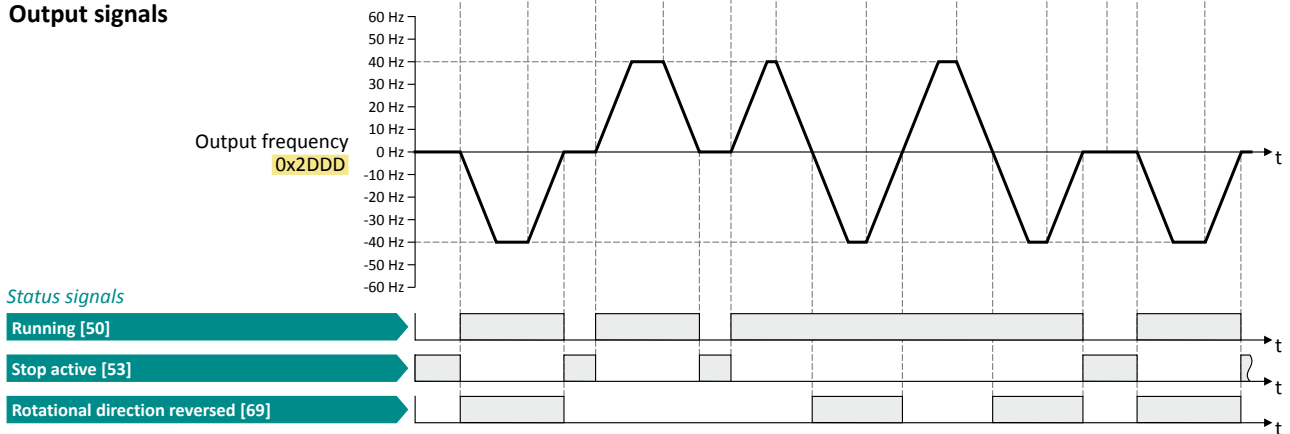

The status signals can be assigned to digital outputs. ▶ [Configuration of digital outputs](#) 355

- ① The "Run" functions serves as start enable for the functions "Run forward (CW)" and "Run reverse (CCW)". Without start enable, the motor cannot be started.
- ② If the start command is cancelled, the motor is stopped with the stop method set in [0x2838:003 \(P203.03\)](#). In the example: Stop with standard ramp. After a renewed start enable, the inverter waits for the next run command.
- ③ If, at start enable, either "Run forward (CW)" or "Run reverse (CCW)" is set to TRUE, the motor starts into the triggered direction.
- ④ The inverter always responds to the run command detected last (if start enable is available). In the example, the "Run reverse (CCW)" command replaces the still active "Run forward (CW)" command.
- ⑤ If, at start enable, both run commands are set to TRUE, the motor remains stopped until only one valid run command is available.

Flexible I/O configuration

Start / stop motor
Example 4: Quick stop



11.2.4 Example 4: Quick stop

This example illustrates the "quick stop" function. If quick stop is activated, the motor is brought to a standstill within the deceleration time set in [0x291C \(P225.00\)](#).

- Switch S1 starts the motor in forward direction of rotation. Switch S1 in the initial position stops the motor again.
- Switch S2 activates the "quick stop" function.



Canceling the quick stop causes a restart of the motor if "Run" is still active (switch S1 closed)!

Connection plan	function	
	Potentiometer R1	Frequency setpoint selection
	Switch S1	Run
	Switch S2	Activate quick stop

Parameter	Name	Setting for this example
0x2631:001 (P400.01)	Enable inverter	Constant TRUE [1]
0x2631:002 (P400.02)	Run	Digital input 1 [11]
0x2631:003 (P400.03)	Activate quick stop	Digital input 2 [12]
0x2631:004 (P400.04)	Reset fault	Not connected [0]
0x2917 (P220.00)	Acceleration time 1	3.0 s
0x2918 (P221.00)	Deceleration time 1	3.0 s
0x291C (P225.00)	Quick stop deceleration time	1.0 s

Input signals

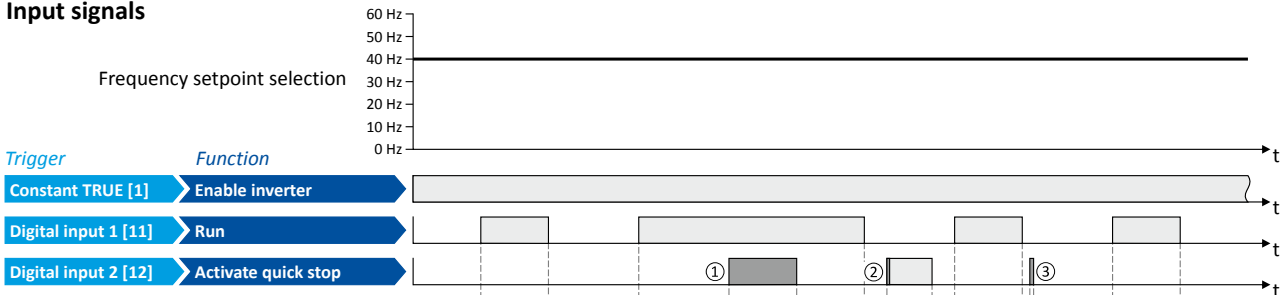

Output signals

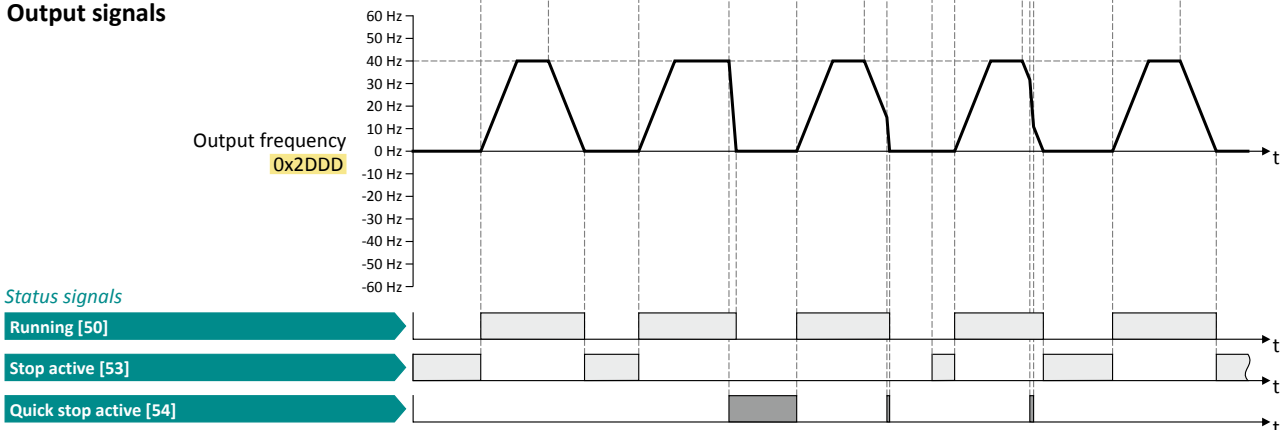

The status signals can be assigned to digital outputs. ▶ [Configuration of digital outputs](#) 355

- ① If quick stop is activated, the motor is decelerated to the frequency setpoint 0 Hz within a short period of time. The "Quick stop active [54]" status is set as long as quick stop is activated. The "Stop active [53]" status is not set.
- ② An active stop command is interrupted by a quick stop.
- ③ If quick stop is cancelled again before standstill is reached, stopping is continued with the stop method set in [0x2838:003 \(P203.03\)](#). In the example: Stop with standard ramp.



11.2.5 Example 5: Jog forward/Jog reverse

This example illustrates the functions "Jog forward (CW)" and "Jog reverse (CCW)" for Jog operation.

- Switch S1 starts the motor in forward direction of rotation. Switch S1 in the initial position stops the motor again.
- Button S2 starts the motor in forward direction of rotation with frequency preset 5.
- Button S3 starts the motor in backward direction of rotation with frequency preset 6.
- The motor rotates in jog operation as long as the respective button is pressed. If both buttons are pressed at the same time, the motor is stopped.

i NOTICE

The jog operation has a higher priority than the "Run" function, all other start commands and the keypad key .

If jog operation is active, the motor cannot be stopped with the previously mentioned functions!

- ▶ The jog operation is stopped by cancelling the functions "Jog forward (CW)"/"Jog reverse (CCW)".
- ▶ The jog operation can be interrupted with the "Activate quick stop" [0x2631:003 \(P400.03\)](#) function.

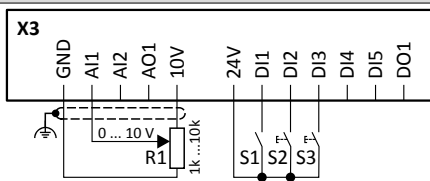
Connection plan	function
	Potentiometer R1
	Frequency setpoint selection
	Switch S1
	Run
	Button S2
	Jog forward (CW)
	Button S3
	Jog reverse (CCW)

Parameter	Name	Setting for this example
0x2631:001 (P400.01)	Enable inverter	Constant TRUE [1]
0x2631:002 (P400.02)	Run	Digital input 1 [11]
0x2631:004 (P400.04)	Reset fault	Not connected [0]
0x2631:010 (P400.10)	Jog forward (CW)	Digital input 2 [12]
0x2631:011 (P400.11)	Jog reverse (CCW)	Digital input 3 [13]
0x2631:013 (P400.13)	Invert rotation	Not connected [0]
0x2911:005 (P450.05)	Frequency setpoint presets: Preset 5	15 Hz (is used for jog forward)
0x2911:006 (P450.06)	Frequency setpoint presets: Preset 6	10 Hz (is used for jog reverse)

Flexible I/O configuration

Start / stop motor

Example 5: Jog forward/Jog reverse



Input signals

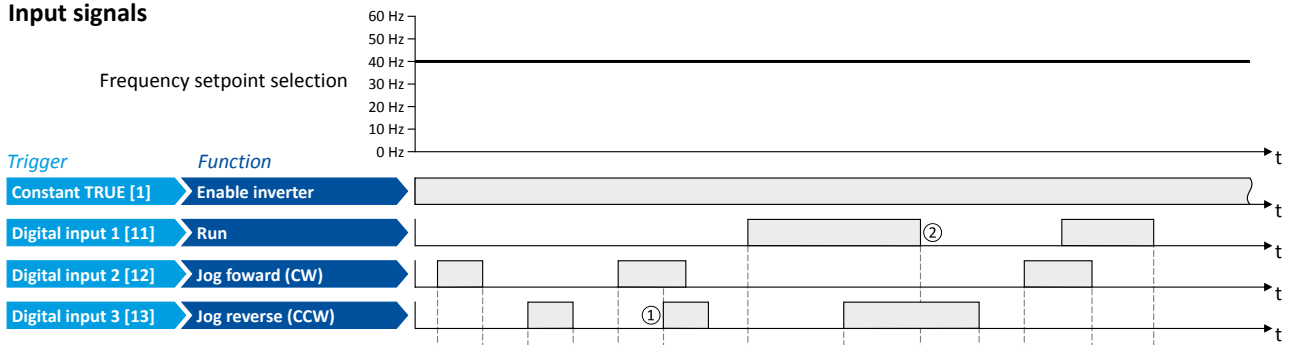

Output signals

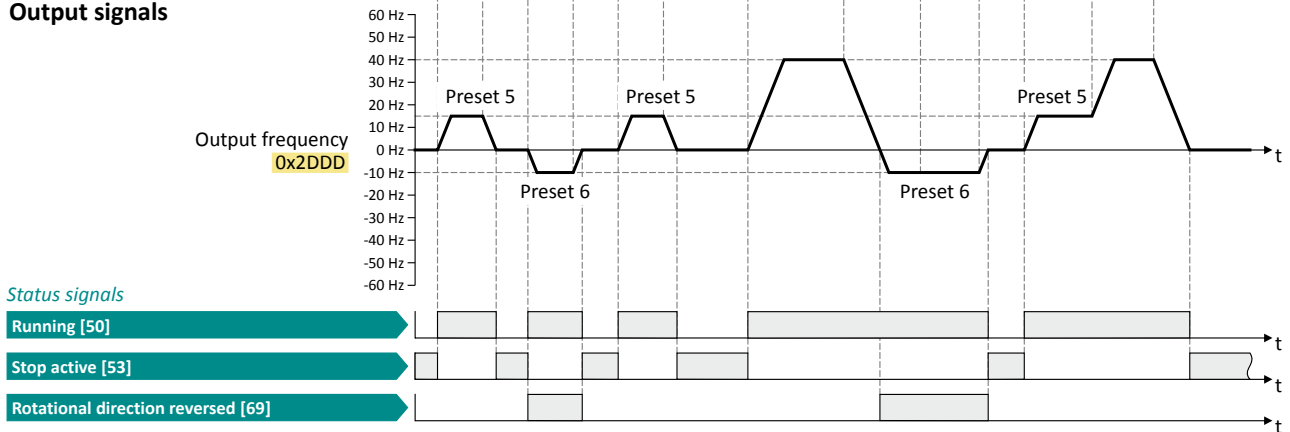

The status signals can be assigned to digital outputs. ▶ [Configuration of digital outputs](#) 355

- ① If "Jog forward (CW)" and "Jog reverse (CCW)" are activated at the same time, the motor is stopped with the stop method set in `0x2838:003` (`P203.03`) and the jog operation must be triggered again.
- ② The jog operation cannot be terminated with the "Run" function but only by cancelling the jog command.



Flexible I/O configuration

Start / stop motor
Example 6: Enable inverter

11.2.6 Example 6: Enable inverter

This example shows how to use the "Enable inverter" function for a separate enable input.

- In idle state of switch S1 (normally-closed contact), "Enable inverter" is already available.
- Switch S2 starts the motor in forward rotating direction (if switch S1 is closed). Switch S2 in initial position stops the motor again.
- Switch S1 disables the inverter. The motor becomes torqueless (coasts).

Connection plan	function
	Potentiometer R1: Frequency setpoint selection
	Switch S1: Disable inverter
	Switch S2: Run

Parameter	Name	Setting for this example
0x2631:001 (P400.01)	Enable inverter	Digital input 1 [11]
0x2631:002 (P400.02)	Run	Digital input 2 [12]
0x2631:004 (P400.04)	Reset fault	Not connected [0]

Input signals

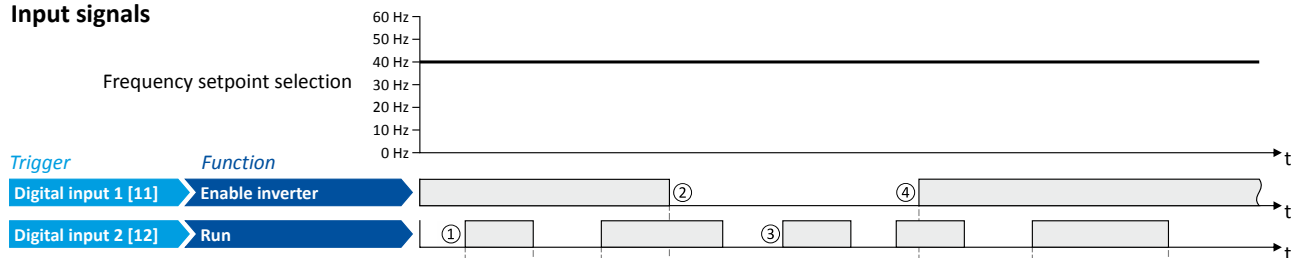

Output signals

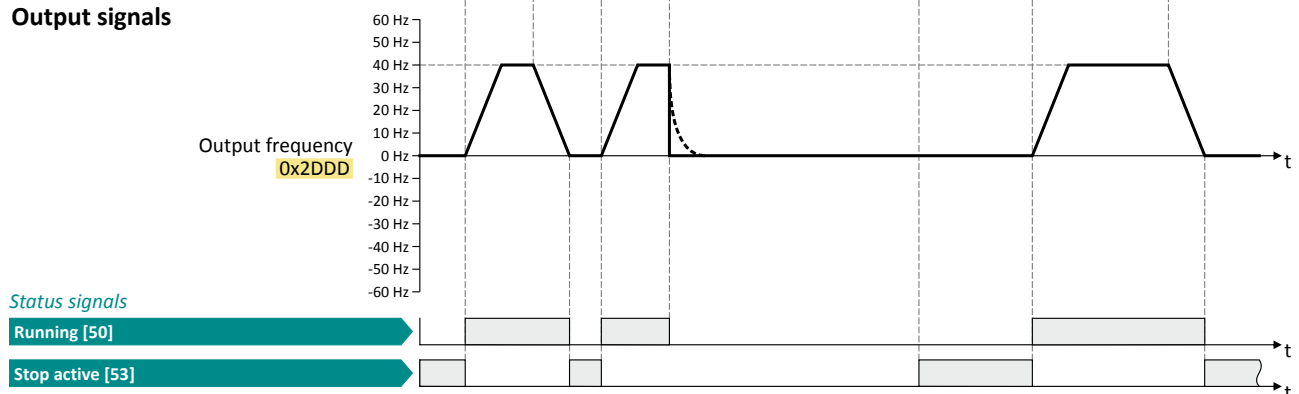

The status signals can be assigned to digital outputs. [► Configuration of digital outputs □ 355](#)

- ① If the inverter is enabled and no error is active, the motor can be started with the "Run" function in forward rotating direction.
- ② If "Enable inverter" is set to FALSE, the inverter is disabled. The motor becomes torqueless and coasts to standstill as a function of the mass inertia of the machine.
- ③ Without "Enable inverter", the motor cannot be started.
- ④ In the default setting, the motor does not start if the "Run" function is set to TRUE during "Enable inverter" . After "Enable inverter", must be retriggered to start the motor.
[► Starting performance □ 91](#)

Flexible I/O configuration

Setpoint change-over
Example 6: Enable inverter



11.3 Setpoint change-over

The inverter receives its setpoint from the selected standard setpoint source. Corresponding functions make it possible to change over to other setpoint sources during operation.

Possible setpoint sources are:

- Analog inputs
- Keypad
- Network
- Parameterisable setpoints (preset values)
- "Motor potentiometer" function

Details

For applications only requiring one setpoint it is sufficient to define the standard setpoint source in the following parameters:

- [0x2860:001 \(P201.01\)](#): Frequency control: Default setpoint source
- [0x2860:002 \(P201.02\)](#): PID control: Default setpoint source

For a setpoint change-over during operation, the following functions must be configured. For details and examples see the following subchapters.

function	Info
Activate AI1 setpoint 0x2631:014 (P400.14)	Activate analog input 1 / analog input 2 as setpoint source. ▶ Analog input setpoint source □ 315
Activate AI2 setpoint 0x2631:002 (P400.02)	
Activate keypad setpoint 0x2631:016 (P400.16)	Activate keypad as setpoint source. • The keypad setpoint can be changed in the operating mode via the navigation keys ↑ and ↓ keypad keys. ▶ Keypad setpoint source □ 317
Activate network setpoint	Activate network as setpoint source. ▶ Network setpoint source □ 319
Activate preset (bit 0) 0x2631:018 (P400.18)	Activate parameterisable setpoints (presets) as setpoint source. • 15 frequency setpoints and 8 PID setpoints can be set as presets. • A preset value can be selected binary-coded via the four functions "Activate preset (bit 0)" ... "Activate preset (bit 3)". ▶ Setpoint source of preset setpoints □ 320
Activate preset (bit 1) 0x2631:019 (P400.19)	
Activate preset (bit 2) 0x2631:020 (P400.20)	
Activate preset (bit 3) 0x2631:021 (P400.21)	
Activate MOP setpoint 0x2631:025 (P400.25)	The "Motor potentiometer" function can be used as an alternative setpoint control that is controlled via two functions: "MOP setpoint up" and "MOP setpoint down". ▶ Motor potentiometer setpoint source (MOP) □ 325

The following signal flow shows the internal setpoint logics:

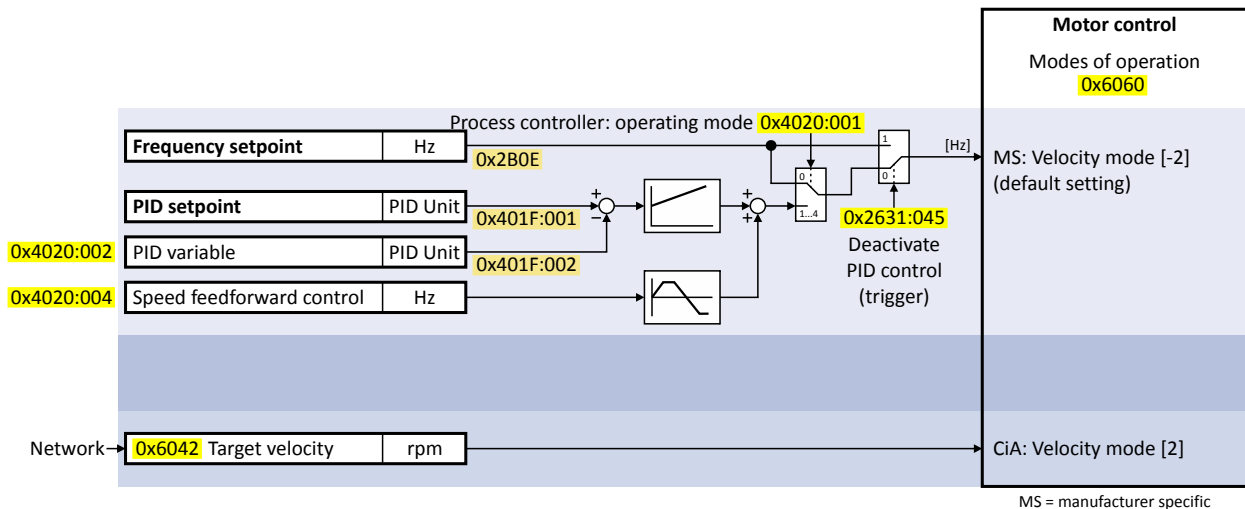



Notes:

- In case of an activated network control, the functions for setpoint change-over are not active! If in case of network control no setpoint is defined via the network control word, the standard setpoint source is active.
- The setpoint used by the motor control depends on the operating mode selected in [0x6060 \(P301.00\)](#):
 - "MS: Velocity mode [-2]": The active frequency setpoint is used. In addition, the PID control can be activated in [0x4020:001 \(P600.01\)](#). ▶ [Configuring the process controller](#) [206](#)
 - "CiA: Velocity mode [2]": The setpoint speed defined via the "Target velocity" [0x6042 \(P781.00\)](#) parameter is used. ▶ [Device profile CiA 402](#) [261](#)
- As only one setpoint source can be active at a time, priorities are assigned to the frequency and PID setpoint sources. For details see the following subchapter "[Priority of the setpoint sources](#)". [314](#).

Diagnostic parameters:

- [0x282B:002 \(P125.02\)](#): Active setpoint source

11.3.1 Priority of the setpoint sources

Since only one setpoint source can be active at a time, the following priorities apply:

Flexible I/O configuration or keypad control active 0x2631:037 (P400.37) = FALSE	Network control active = FALSE 0x2631:037 (P400.37) = TRUE
Prio 1: Functions for setpoint change-over The priority of the functions results from the assigned triggers (in the order of the selection list): 1. Constant TRUE [1] 2. Digital input 1 [11] 3. Digital input 2 [12] 4. Digital input 3 [13] 5. ... Prio 2: Set standard setpoint source <ul style="list-style-type: none"> • 0x2860:001 (P201.01): Frequency control: Default setpoint source • 0x2860:002 (P201.02): PID control: Default setpoint source ▶ Selection of setpoint source 89	Prio 1: Setpoint source selected via network control word ▶ General network settings 137 Prio 2: Set standard setpoint source <ul style="list-style-type: none"> • 0x2860:001 (P201.01): Frequency control: Default setpoint source • 0x2860:002 (P201.02): PID control: Default setpoint source ▶ Selection of setpoint source 89

Example of allocating priority

Parameter	Name	Setting for this example
0x2631:014 (P400.14)	Activate AI1 setpoint	Digital input 5 [15]
0x2631:016 (P400.16)	Activate keypad setpoint	Digital input 4 [14]

Digital input 4	Digital input 5	Active setpoint source
FALSE	FALSE	Standard setpoint source set in 0x2860:001 (P201.01)
FALSE	TRUE	Analog input 1
TRUE	FALSE	keypad
TRUE	TRUE	Keypad (since "Digital input 4" trigger is higher in the selection list than "Digital input 5" trigger)

Flexible I/O configuration

Setpoint change-over
Analog input setpoint source



11.3.2 Analog input setpoint source

The following functions are used to select analog input 1 or analog input 2 as setpoint source.

Preconditions

A setpoint change-over to the respective analog input is only effected if no setpoint source with a higher priority has been selected. ▶ [Priority of the setpoint sources](#) [313]

Parameter	Name / value range / [default setting]	Info
0x2631:014 (P400.14)	Function list: Activate AI1 setpoint (Function list: Setp: AI1) • For possible settings see description for 0x2631:001 (P400.01) . [299]	Assignment of a trigger for the "Activate AI1 setpoint" function. Trigger = TRUE: analog input 1 is used as setpoint source (if the trigger assigned has the highest setpoint priority). Trigger = FALSE: no action / deactivate function again. ▶ Analog input 1 [349]
	00 Not connected	No trigger assigned (trigger is constantly FALSE).
0x2631:015 (P400.15)	Function list: Activate AI2 setpoint (Function list: Setp: AI2) • For possible settings see description for 0x2631:001 (P400.01) . [299]	Assignment of a trigger for the "Activate AI2 setpoint" function. Trigger = TRUE: analog input 2 is used as setpoint source (if the trigger assigned has the highest setpoint priority). Trigger = FALSE: no action / deactivate function again. ▶ Analog input 2 [353]
	00 Not connected	No trigger assigned (trigger is constantly FALSE).

Example for operating mode

- The keypad is set as standard setpoint source.
- Switch S1 starts the motor in forward direction of rotation. Switch S1 in the initial position stops the motor again.
- Switch S2 switches the direction of rotation.
- Switch S3 activates analog input 1 as setpoint source.
- Switch S4 activates analog input 2 as setpoint source.



If S3 and S4 are operated at the same time, the analog input 1 is active as setpoint source since the digital input 3 assigned to this function has a higher priority than the digital input 4.

Connection plan	function
	Potentiometer R1 Frequency setpoint selection via AI1
	Potentiometer R2 Frequency setpoint selection via AI2
	Switch S1 Run
	Switch S2 Invert rotation
	Switch S3 Activate AI1 setpoint
	Switch S4 Activate AI2 setpoint

Parameter	Name	Setting for this example
0x2631:001 (P400.01)	Enable inverter	Constant TRUE [1]
0x2631:002 (P400.02)	Run	Digital input 1 [11]
0x2631:004 (P400.04)	Reset fault	Not connected [0]
0x2631:013 (P400.13)	Invert rotation	Digital input 2 [12]
0x2631:014 (P400.14)	Activate AI1 setpoint	Digital input 3 [13]
0x2631:015 (P400.15)	Activate AI2 setpoint	Digital input 4 [14]
0x2631:018 (P400.18)	Activate preset (bit 0)	Not connected [0]
0x2824 (P200.00)	Control selection	Flexible I/O configuration [0]
0x2838:003 (P203.03)	Stop method	Standard ramp [1]
0x2860:001 (P201.01)	Frequency control: Default setpoint source	Keypad [1]



Flexible I/O configuration

Setpoint change-over

Analog input setpoint source

Input signals

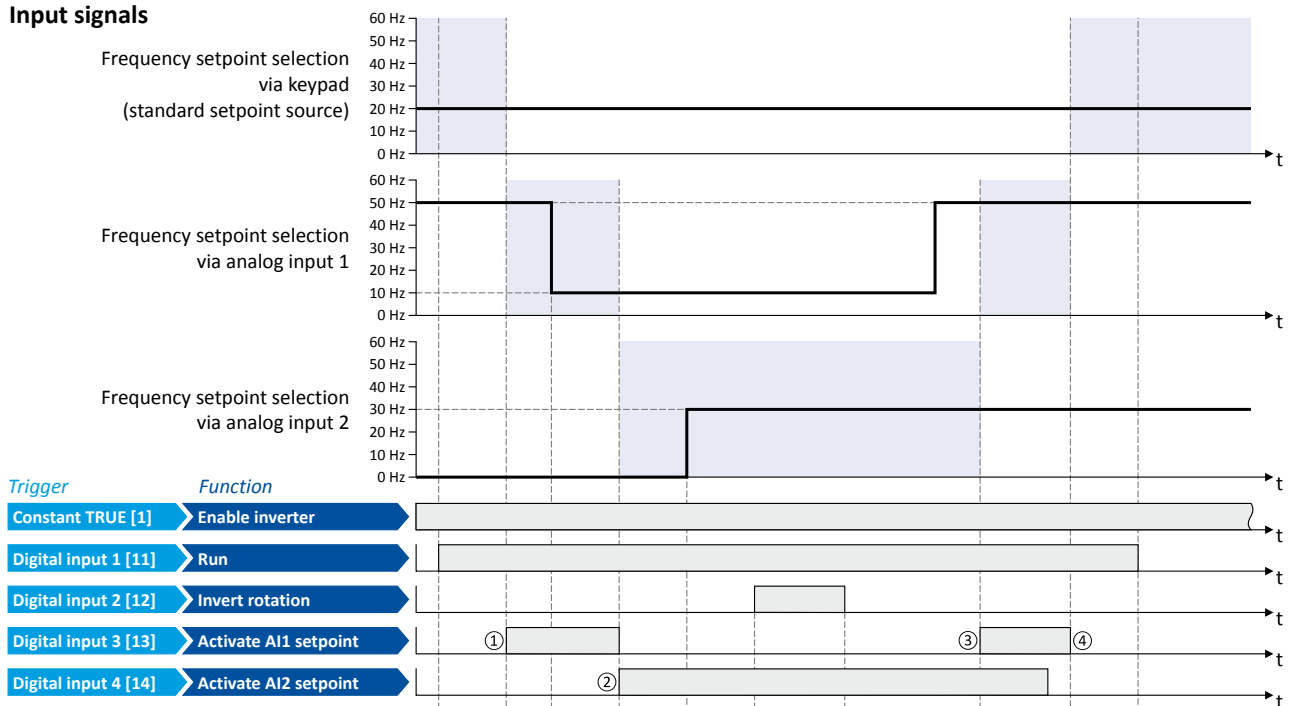

Output signals

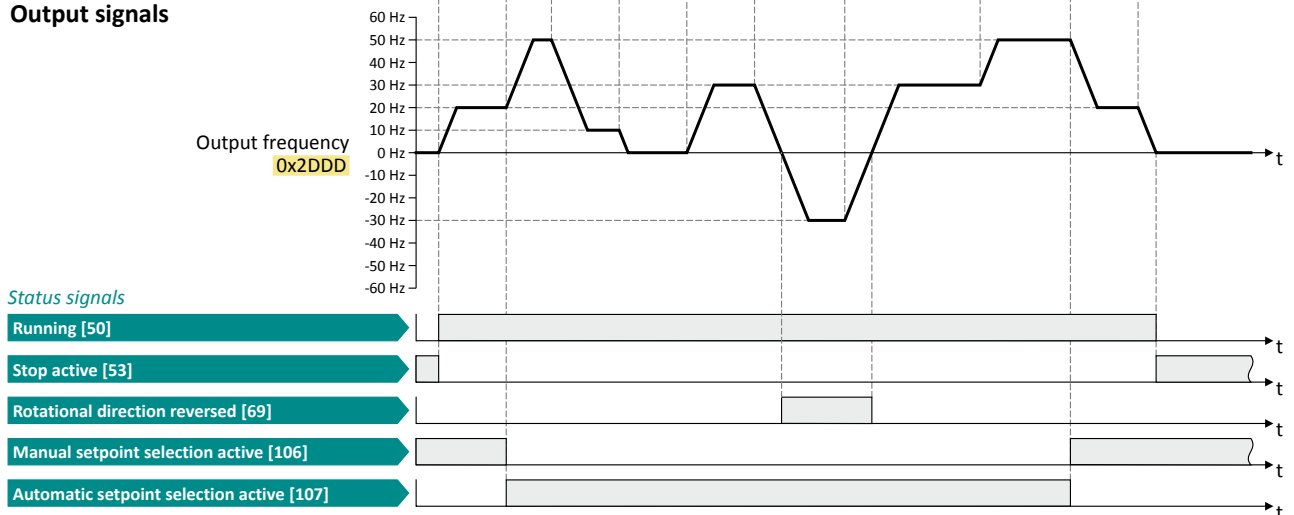

The status signals can be assigned to digital outputs. ▶ [Configuration of digital outputs](#) 355

- ① Change-over from keypad setpoint (standard setpoint source) to A1 setpoint.
- ② Change-over from A1 setpoint to A2 setpoint.
- ③ Change-over from A2 setpoint to A1 setpoint since the digital input 3 has a higher priority than the digital input 4.
- ④ Change-over to keypad setpoint (standard setpoint source).

Flexible I/O configuration

Setpoint change-over
Keypad setpoint source



11.3.3 Keypad setpoint source

The following function is used to select the keypad as setpoint source.

Preconditions

A setpoint change-over to the keypad is only effected if no setpoint source with a higher priority has been selected. ▶ [Priority of the setpoint sources](#) 313

Parameter	Name / value range / [default setting]	Info
0x2631:016 (P400.16)	Function list: Activate keypad setpoint (Function list: Setp: Keypad) <ul style="list-style-type: none"> For possible settings see description for 0x2631:001 (P400.01). 299 	Assignment of a trigger for the "Activate keypad setpoint" function. Trigger = TRUE: the keypad is used as setpoint source (if the trigger assigned has the highest setpoint priority). Trigger = FALSE: no action / deactivate function again. Notes: <ul style="list-style-type: none"> The default keypad setpoint can be changed in keypad operating mode via the arrow keys of the keypad.
	00 Not connected	No trigger assigned (trigger is constantly FALSE).

Keypad setpoint default setting

For the manual setpoint selection via keypad the following default settings are used:

- [0x2601:001 \(P202.01\)](#): Keypad setpoints: Frequency setpoint
- [0x2601:002 \(P202.02\)](#): Keypad setpoints: Process controller setpoint

The increment for keypad setpoints can be adapted in [0x2862 \(P701.00\)](#) by pressing a keypad arrow key once.

Example for operating mode

- The analog input 1 is set as standard setpoint source.
- Switch S1 starts the motor in forward direction of rotation. Switch S1 in the initial position stops the motor again.
- Switch S2 switches the direction of rotation.
- Switch S3 activates the keypad as setpoint source. The keypad setpoint can be changed in the operating mode via the navigation keys ↑ and ↓ keypad keys.

Connection plan	function
	Potentiometer R1 Frequency setpoint selection
	Switch S1 Run
	Switch S2 Invert rotation
	Switch S3 Activate keypad setpoint

Parameter	Name	Setting for this example
0x2601:001 (P202.01)	Keypad setpoints: Frequency setpoint	20.0 Hz
0x2631:001 (P400.01)	Enable inverter	Constant TRUE [1]
0x2631:002 (P400.02)	Run	Digital input 1 [11]
0x2631:004 (P400.04)	Reset fault	Not connected [0]
0x2631:013 (P400.13)	Invert rotation	Digital input 2 [12]
0x2631:016 (P400.16)	Activate keypad setpoint	Digital input 3 [13]
0x2824 (P200.00)	Control selection	Flexible I/O configuration [0]
0x2838:003 (P203.03)	Stop method	Standard ramp [1]
0x2860:001 (P201.01)	Frequency control: Default setpoint source	Analog input 1 [2]



Flexible I/O configuration

Setpoint change-over Keypad setpoint source

Input signals

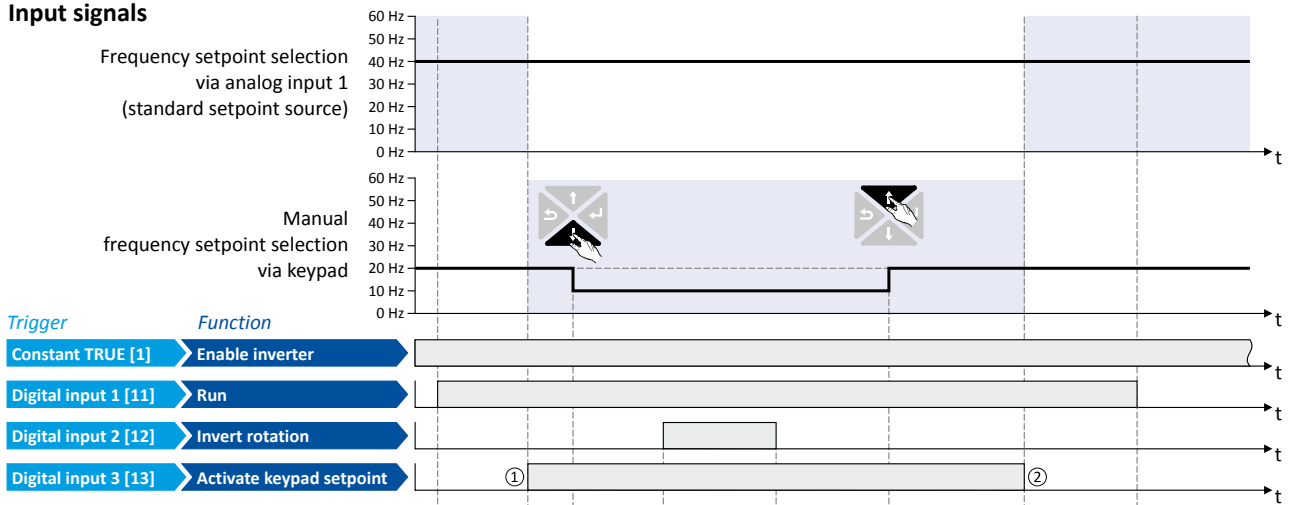

Output signals

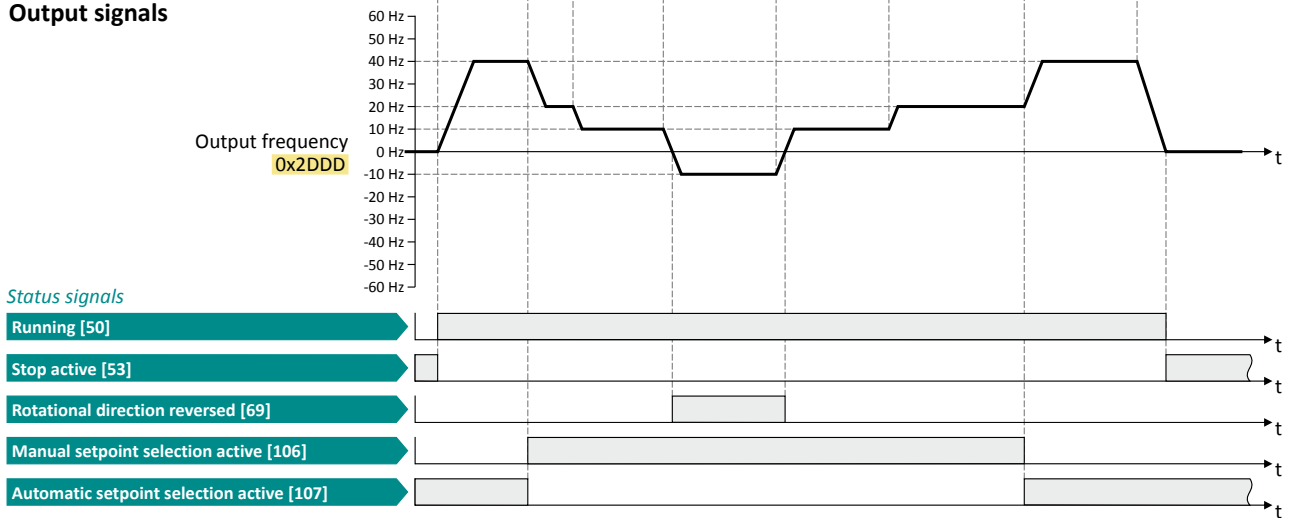

The status signals can be assigned to digital outputs. ▶ [Configuration of digital outputs](#) 355

- ① Change-over from analog input 1 (standard setpoint source) to keypad setpoint.
- ② Change-over from keypad setpoint back to analog input 1 (standard setpoint source).

Flexible I/O configuration

Setpoint change-over
Network setpoint source



11.3.4 Network setpoint source

The network can be set as standard setpoint source. Optionally, a change-over to the network setpoint is possible via the "Activate network setpoint" function (not if the network control is activated) or via the network control word (if the network control is activated).



If the network control is activated, all functions for setpoint change-over are inactive!

Details

In order to generally set the network as standard setpoint source, go to [0x2860:001 \(P201.01\)](#) and select "Network [5]".

- If the network control is not active ([0x2631:037 \(P400.37\)](#) = "FALSE"), the "Activate network setpoint" function serves to change over to the network setpoint. The setpoint change-over only takes place if no setpoint source with a higher priority has been selected.
 - ▶ [Priority of the setpoint sources](#) [□ 313](#)
- If the network control is activated ([0x2631:037 \(P400.37\)](#) = "TRUE"), a change-over to the network setpoint is possible via the used network control word:

Network control word	Change-over to network setpoint		
NetWordIN1 data word 0x4008:001 (P590.01)	Assign the function "Activate network setpoint [17]" to the bit that is to be used for activating the network setpoint.		
	• The functions that are to be triggered via bits 0 ... 15 of the NetWordIN1 data word are defined in 0x400E:001 (P505.01) ... 0x400E:016 (P505.16) .		
	Bit x	Selection:	
	0	Standard setpoint source selected in 0x2860:001 (P201.01) .	
	1	Network setpoint	
AC drive control word 0x400B:001 (P592.01)	The network setpoint is activated via bit 6 of the AC Drive control word:		
	Bit 6	Selection:	
	0	Standard setpoint source selected in 0x2860:001 (P201.01) .	
	1	Network setpoint	
LECOM control word 0x400B:002 (P592.02)	The setpoint is selected via bit 0 and bit 1 of the LECOM control word:		
	Bit 1	Bit 0	Selection:
	0	0	Standard setpoint source selected in 0x2860:001 (P201.01) .
	0	1	Frequency setpoint preset 1 0x2911:001 (P450.01)
	1	0	Frequency setpoint preset 2 0x2911:002 (P450.02)
	1	1	Frequency setpoint preset 3 0x2911:003 (P450.03)
CiA 402 Controlword 0x6040	In case of control via device profile CiA 402:		
	• In the operating mode "CiA: Velocity mode [2]", the setpoint speed defined via the "Target velocity" 0x6042 (P781.00) parameter is used. ▶ Device profile CiA 402 □ 261		
	• A change-over to an alternative setpoint source via the CiA 402 Controlword is not possible.		

▶ [General network settings](#) [□ 137](#)



11.3.5 Setpoint source of preset setpoints

The four functions "Activate preset (bit 0)" ... "Activate preset (bit 3)" enable change-over of the setpoint to a parameterisable setpoint (preset value).

Preconditions

A setpoint change-over to the respective preset is only effected if no setpoint source with a higher priority has been selected. ▶ [Priority of the setpoint sources](#) 313

Details

A preset value is selected in a binary-coded fashion via the triggers assigned to the four functions "Activate preset (bit 0)" ... "Activate preset (bit 3)" in compliance with the following truth table:

Activate preset				Selection		
Bit 3 0x2631:021 (P400.21)	Bit 2 0x2631:020 (P400.20)	Bit 1 0x2631:019 (P400.19)	Bit 0 0x2631:018 (P400.18)	Preset	frequency setpoint	PID setpoint
FALSE	FALSE	FALSE	FALSE	No preset selected.		
FALSE	FALSE	FALSE	TRUE	Preset value 1	0x2911:001 (P450.01)	0x4022:001 (P451.01)
FALSE	FALSE	TRUE	FALSE	Preset value 2	0x2911:002 (P450.02)	0x4022:002 (P451.02)
FALSE	FALSE	TRUE	TRUE	Preset value 3	0x2911:003 (P450.03)	0x4022:003 (P451.03)
FALSE	TRUE	FALSE	FALSE	Preset value 4	0x2911:004 (P450.04)	0x4022:004 (P451.04)
FALSE	TRUE	FALSE	TRUE	Preset 5	0x2911:005 (P450.05)	0x4022:005 (P451.05)
FALSE	TRUE	TRUE	FALSE	Preset 6	0x2911:006 (P450.06)	0x4022:006 (P451.06)
FALSE	TRUE	TRUE	TRUE	Preset value 7	0x2911:007 (P450.07)	0x4022:007 (P451.07)
TRUE	FALSE	FALSE	FALSE	Preset value 8	0x2911:008 (P450.08)	0x4022:008 (P451.08)
TRUE	FALSE	FALSE	TRUE	Preset value 9	0x2911:009 (P450.09)	
...				
TRUE	TRUE	TRUE	TRUE	Preset value 15	0x2911:015 (P450.15)	

Notes:

- The frequency setpoint preset 5 is also used for the "Jog forward (CW)" 0x2631:010 (P400.10) function.
- The frequency setpoint preset 6 is also used for the "Jog reverse (CCW)" 0x2631:011 (P400.11) function.

Parameter	Name / value range / [default setting]	Info
0x2631:018 (P400.18)	Function list: Activate preset (bit 0) (Function list: Setp: Preset b0) • For possible settings see description for 0x2631:001 (P400.01) . 299	Assignment of a trigger for the "Activate preset (bit 0)" function. Selection bit with the valency 20 for the bit-coded selection and activation of a parameterised setpoint (preset value). Trigger = FALSE: selection bit = "0". Trigger = TRUE: selection bit = "1".
	14 Digital input 4	State of X3/DI4, taking an inversion set in 0x2632:004 (P411.04) into consideration.
0x2631:019 (P400.19)	Function list: Activate preset (bit 1) (Function list: Setp: Preset b1) • For possible settings see description for 0x2631:001 (P400.01) . 299	Assignment of a trigger for the "Activate preset (bit 1)" function. Selection bit with the valency 21 for the bit-coded selection and activation of a parameterised setpoint (preset value). Trigger = FALSE: selection bit = "0". Trigger = TRUE: selection bit = "1".
	15 Digital input 5	State of X3/DI5, taking an inversion set in 0x2632:005 (P411.05) into consideration.

Flexible I/O configuration

Setpoint change-over

Setpoint source of preset setpoints



Parameter	Name / value range / [default setting]	Info
0x2631:020 (P400.20)	Function list: Activate preset (bit 2) (Function list: Setp: Preset b2) • For possible settings see description for 0x2631:001 (P400.01) . □ 299	Assignment of a trigger for the "Activate preset (bit 2)" function. Selection bit with the valency 22 for the bit-coded selection and activation of a parameterised setpoint (preset value). Trigger = FALSE: selection bit = "0". Trigger = TRUE: selection bit = "1".
	00 Not connected	No trigger assigned (trigger is constantly FALSE).
0x2631:021 (P400.21)	Function list: Activate preset (bit 3) (Function list: Setp: Preset b3) • For possible settings see description for 0x2631:001 (P400.01) . □ 299	Assignment of a trigger for the "Activate preset (bit 3)" function. Selection bit with the valency 2 ³ for the bit-coded selection and activation of a parameterised setpoint (preset value). Trigger = FALSE: selection bit = "0". Trigger = TRUE: selection bit = "1".
	00 Not connected	No trigger assigned (trigger is constantly FALSE).
0x2911:001 (P450.01)	Frequency setpoint presets: Preset 1 (Freq. presets: Freq. preset 1) 0.0 ... [20.0] ... 599.0 Hz	Parameterisable frequency setpoints (presets) for operating mode "MS: Velocity mode".
0x2911:002 (P450.02)	Frequency setpoint presets: Preset 2 (Freq. presets: Freq. preset 2) 0.0 ... [40.0] ... 599.0 Hz	
0x2911:003 (P450.03)	Frequency setpoint presets: Preset 3 (Freq. presets: Freq. preset 3) 0.0 ... [50.0] ... 599.0 Hz	
0x2911:004 (P450.04)	Frequency setpoint presets: Preset 4 (Freq. presets: Freq. preset 4) 0.0 ... [0.0] ... 599.0 Hz	
0x2911:005 (P450.05)	Frequency setpoint presets: Preset 5 (Freq. presets: Freq. preset 5) 0.0 ... [0.0] ... 599.0 Hz	
0x2911:006 (P450.06)	Frequency setpoint presets: Preset 6 (Freq. presets: Freq. preset 6) 0.0 ... [0.0] ... 599.0 Hz	
0x2911:007 (P450.07)	Frequency setpoint presets: Preset 7 (Freq. presets: Freq. preset 7) 0.0 ... [0.0] ... 599.0 Hz	
0x2911:008 (P450.08)	Frequency setpoint presets: Preset 8 (Freq. presets: Freq. preset 8) 0.0 ... [0.0] ... 599.0 Hz	
0x2911:009 (P450.09)	Frequency setpoint presets: Preset 9 (Freq. presets: Freq. preset 9) 0.0 ... [0.0] ... 599.0 Hz	
0x2911:010 (P450.10)	Frequency setpoint presets: Preset 10 (Freq. presets: Freq. preset 10) 0.0 ... [0.0] ... 599.0 Hz	
0x2911:011 (P450.11)	Frequency setpoint presets: Preset 11 (Freq. presets: Freq. preset 11) 0.0 ... [0.0] ... 599.0 Hz	
0x2911:012 (P450.12)	Frequency setpoint presets: Preset 12 (Freq. presets: Freq. preset 12) 0.0 ... [0.0] ... 599.0 Hz	
0x2911:013 (P450.13)	Frequency setpoint presets: Preset 13 (Freq. presets: Freq. preset 13) 0.0 ... [0.0] ... 599.0 Hz	
0x2911:014 (P450.14)	Frequency setpoint presets: Preset 14 (Freq. presets: Freq. preset 14) 0.0 ... [0.0] ... 599.0 Hz	
0x2911:015 (P450.15)	Frequency setpoint presets: Preset 15 (Freq. presets: Freq. preset 15) 0.0 ... [0.0] ... 599.0 Hz	



Flexible I/O configuration

Setpoint change-over
Setpoint source of preset setpoints

Parameter	Name / value range / [default setting]	Info
0x4022:001 (P451.01)	PID setpoint presets: Preset 1 (PID presets: PID preset 1) -300.00 ... [0.00] ... 300.00 PID unit	Parameterisable process controller setpoints (presets) for PID control.
0x4022:002 (P451.02)	PID setpoint presets: Preset 2 (PID presets: PID preset 2) -300.00 ... [0.00] ... 300.00 PID unit	
0x4022:003 (P451.03)	PID setpoint presets: Preset 3 (PID presets: PID preset 3) -300.00 ... [0.00] ... 300.00 PID unit	
0x4022:004 (P451.04)	PID setpoint presets: Preset 4 (PID presets: PID preset 4) -300.00 ... [0.00] ... 300.00 PID unit	
0x4022:005 (P451.05)	PID setpoint presets: Preset 5 (PID presets: PID preset 5) -300.00 ... [0.00] ... 300.00 PID unit	
0x4022:006 (P451.06)	PID setpoint presets: Preset 6 (PID presets: PID preset 6) -300.00 ... [0.00] ... 300.00 PID unit	
0x4022:007 (P451.07)	PID setpoint presets: Preset 7 (PID presets: PID preset 7) -300.00 ... [0.00] ... 300.00 PID unit	
0x4022:008 (P451.08)	PID setpoint presets: Preset 8 (PID presets: PID preset 8) -300.00 ... [0.00] ... 300.00 PID unit	

Flexible I/O configuration

Setpoint change-over
Setpoint source of preset setpoints



Example for operating mode

- The keypad is set as standard setpoint source.
- Switch S1 starts the motor in forward direction of rotation. Switch S1 in the initial position stops the motor again.
- The switches S2 ... S4 serve to switch over to the presets 1 ... 7 (see the following table).

Connection plan	function				
	Switch S1	Run			
	Switches S2 ... S4	Preset selection:			
		S2	S3	S4	
		Off	Off	Off	Keypad setpoint
		On	Off	Off	Preset value 1
		Off	On	Off	Preset value 2
		On	On	Off	Preset value 3
		Off	Off	On	Preset value 4
	On	Off	On	Preset 5	
	Off	On	On	Preset 6	
	On	On	On	Preset value 7	

Parameter	Name	Setting for this example
0x2631:001 (P400.01)	Enable inverter	Constant TRUE [1]
0x2631:002 (P400.02)	Run	Digital input 1 [11]
0x2631:004 (P400.04)	Reset fault	Not connected [0]
0x2631:013 (P400.13)	Invert rotation	Not connected [0]
0x2631:018 (P400.18)	Activate preset (bit 0)	Digital input 2 [12]
0x2631:019 (P400.19)	Activate preset (bit 1)	Digital input 3 [13]
0x2631:020 (P400.20)	Activate preset (bit 2)	Digital input 4 [14]
0x2824 (P200.00)	Control selection	Flexible I/O configuration [0]
0x2838:003 (P203.03)	Stop method	Standard ramp [1]
0x2860:001 (P201.01)	Frequency control: Default setpoint source	Keypad [1]
0x2911:001 (P450.01)	Frequency setpoint presets: Preset 1	10 Hz
0x2911:002 (P450.02)	Frequency setpoint presets: Preset 2	15 Hz
0x2911:003 (P450.03)	Frequency setpoint presets: Preset 3	20 Hz
0x2911:004 (P450.04)	Frequency setpoint presets: Preset 4	25 Hz
0x2911:005 (P450.05)	Frequency setpoint presets: Preset 5	30 Hz
0x2911:006 (P450.06)	Frequency setpoint presets: Preset 6	35 Hz
0x2911:007 (P450.07)	Frequency setpoint presets: Preset 7	40 Hz



If the frequency presets 8 ... 15 are required as well, the digital input 5 must be additionally assigned to the "Activate preset (bit 3)" function and the terminal DI5 must be interconnected accordingly.



Flexible I/O configuration

Setpoint change-over

Setpoint source of preset setpoints

Input signals

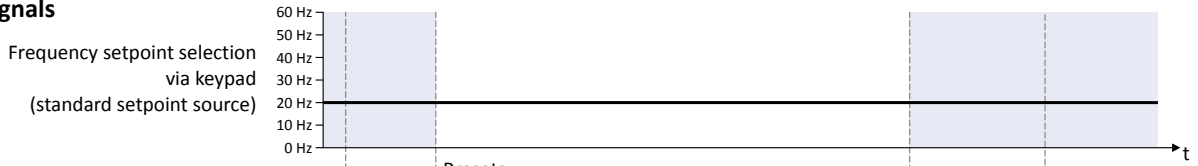

Presets						
0x2911:1	0x2911:2	0x2911:3	0x2911:4	0x2911:5	0x2911:6	0x2911:7
10 Hz	15 Hz	20 Hz	25 Hz	30 Hz	35 Hz	40 Hz

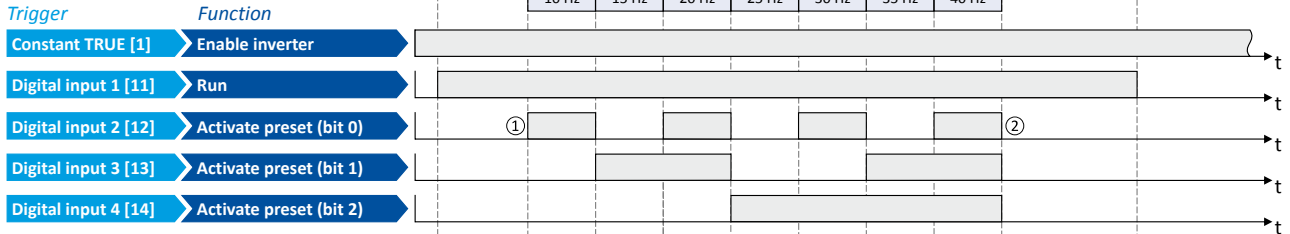

Output signals

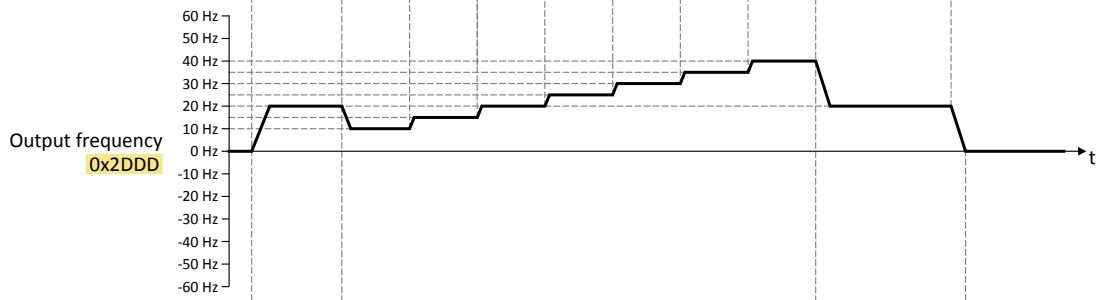

Status signals

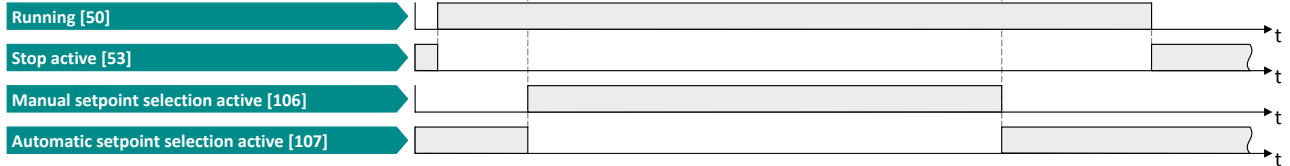

The status signals can be assigned to digital outputs. ▶ [Configuration of digital outputs](#) □ 355

- ① Change-over from keypad setpoint (standard setpoint source) to presets (first, preset 1 is selected).
- ② Change-over back to keypad setpoint since no preset is selected anymore (digital inputs 2 ... 4 = FALSE).

Flexible I/O configuration

Setpoint change-over
Motor potentiometer setpoint source (MOP)



11.3.6 Motor potentiometer setpoint source (MOP)

The "Motor potentiometer" function can be used as an alternative setpoint control that is controlled via two functions: "MOP setpoint up" and "MOP setpoint down".

- The "Activate MOP setpoint" function enables a setpoint change-over to the motor potentiometer.
- The motor potentiometer can also be defined as standard setpoint source. ▶ [Selection of setpoint source](#) 📖 89

Preconditions

A setpoint change-over to the motor potentiometer is only effected if

- no setpoint source with a higher priority has been selected. ▶ [Priority of the setpoint sources](#) 📖 313
- no jog operation is active ("Jog forward (CW)" and "Jog reverse (CCW)" functions).

Details

If the motor potentiometer is active as setpoint source, the setpoint generated by this function ("MOP value") can be changed according to the truth table via the triggers assigned to the two "MOP setpoint up" and "MOP setpoint down" functions:

MOP setpoint up 0x2631:023 (P400.23)	MOP setpoint down 0x2631:024 (P400.24)	Response of the function
FALSE	FALSE	Last MOP value is maintained.
TRUE	FALSE	MOP value is increased to a maximum of the upper range limit with acceleration time 2. (The motor follows the setpoint change with acceleration time 1.)
FALSE	TRUE	MOP value is decreased to a maximum of the lower range limit with deceleration time 2. (The motor follows the setpoint change with deceleration time 1.)
TRUE	TRUE	Last MOP value is maintained.

Starting performance

- In the default setting, the last MOP value is used as initial value. As an alternative, an adjustable initial value or the minimum value can be used for starting. The starting performance can be selected in [0x4003 \(P413.00\)](#).
- The last MOP value is still provided after switching the mains voltage off and on again.

Range limits, acceleration times, and deceleration times

Parameter	MS: Velocity mode	PID control
Lower range limit	Minimum frequency 0x2915 (P210.00)	PID setpoint limits: Minimum setpoint 0x404E:001 (P605.01)
Upper range limit	Maximum frequency 0x2916 (P211.00)	PID setpoint limits: Maximum setpoint 0x404E:002 (P605.02)
Acceleration time	Acceleration time 2 0x2919 (P222.00)	PID setpoint ramp 0x404B (P604.00)
Deceleration time	Deceleration time 2 0x291A (P223.00)	PID setpoint ramp 0x404B (P604.00)

Parameter	Name / value range / [default setting]	Info
0x2631:023 (P400.23)	Function list: MOP setpoint up (Function list: MOP up) • For possible settings see description for 0x2631:001 (P400.01) . 📖 299	Assignment of a trigger for the "MOP setpoint up" function. Trigger = TRUE: setpoint generated by the "Motor potentiometer" function ("MOP value") is maximally increased to the upper range limit with acceleration time 2. Trigger = FALSE: last MOP value is maintained. Notes: • If the "MOP setpoint up" and "MOP setpoint down" functions are active at the same time, the last MOP value is maintained. • Acceleration time 2 can be set in 0x2919 (P222.00) .
	00 Not connected	No trigger assigned (trigger is constantly FALSE).



Flexible I/O configuration

Setpoint change-over Motor potentiometer setpoint source (MOP)

Parameter	Name / value range / [default setting]	Info
0x2631:024 (P400.24)	Function list: MOP setpoint down (Function list: MOP down) • For possible settings see description for 0x2631:001 (P400.01) . □ 299	Assignment of a trigger for the "MOP setpoint down" function. Trigger = TRUE: setpoint generated by the "Motor potentiometer" function ("MOP value") is maximally decreased to the lower range limit with deceleration time 2. Trigger = FALSE: last MOP value is maintained. Notes: • If the "MOP setpoint up" and "MOP setpoint down" functions are active at the same time, the last MOP value is maintained. • Deceleration time 2 can be set in 0x291A (P223.00) .
	00 Not connected	No trigger assigned (trigger is constantly FALSE).
0x2631:025 (P400.25)	Function list: Activate MOP setpoint (Function list: Setp: MOP) • For possible settings see description for 0x2631:001 (P400.01) . □ 299	Assignment of a trigger for the "Activate MOP setpoint" function. Trigger = TRUE: the "Motor potentiometer" function is used as setpoint source (if the trigger assigned has the highest setpoint priority). Trigger = FALSE: no action / deactivate function again.
	00 Not connected	No trigger assigned (trigger is constantly FALSE).
0x4003 (P413.00)	MOP starting mode (MOP startmode)	Selection of the initial value which is used after activation of the function.
	0 Last value	The last MOP value is used as initial value. It is still provided after the mains voltage has been switched off and on again.
	1 Starting value	Depending on the operating mode, the value set in 0x4004:1...3 is used as initial value.
	2 Minimum value	The minimum value of the corresponding operating mode is used as initial value: • Minimum frequency 0x2915 (P210.00) • PID setpoint limits: Minimum setpoint 0x404E:001 (P605.01)
0x4004:001 (P414.01)	MOP starting values: Frequency (MOP start value: Frequency) 0.0 ... [0.0] ... 599.0 Hz	Initial value for "MS: Velocity mode". Only relevant if 0x4003 = 1.
0x4004:002 (P414.02)	MOP starting values: PID value (MOP start value: PID value) -300.00 ... [0.00] ... 300.00 PID unit	Initial value for reference value of the PID control. Only relevant if 0x4003 = 1.
0x4004:003 (P414.03)	MOP starting values: Torque (MOP start value: Torque) 0.0 ... [0.0] ... 1000.0 %	Initial value for "Torque mode". Only relevant if 0x4003 = 1.
0x4009:001	MOP values saved: Frequency • Read only: x.x Hz	Display of the last MOP value saved internally. • This value is used as initial value in the "MS: Velocity mode" if 0x4003 is set = 0.
0x4009:002	MOP values saved: PID value • Read only: x.xx PID unit	Display of the last MOP value saved internally. • This value is used as initial value for the PID control if 0x4003 is set = 0.
0x4009:003	MOP values saved: Torque • Read only: x.x %	Display of the last MOP value saved internally. • This value is set as initial value in the "torque mode" if 0x4003 is set = 0.
0x2915 (P210.00)	Minimum frequency (Min. frequency) 0.0 ... [0.0] ... 599.0 Hz	Lower limit value for all frequency setpoints.
0x2916 (P211.00)	Maximum frequency (Max. frequency) 0.0 ... [50.0] ... 599.0 Hz	Upper limit value for all frequency setpoints.
0x2919 (P222.00)	Acceleration time 2 (Accelerat.time 2) 0.0 ... [5.0] ... 3600.0 s	Acceleration time 2 for the operating mode "MS: Velocity mode". • The acceleration time set refers to the acceleration from standstill to the maximum frequency set. In the case of a lower setpoint selection, the actual acceleration time is reduced accordingly. • The acceleration time 2 is active if the frequency setpoint (absolute value) ≥ auto switching threshold 0x291B (P224.00) or the trigger assigned to the function "Activate ramp 2" in 0x2631:039 (P400.39) = TRUE. • The acceleration time 2 is also used for changing the MOP setpoint generated by the "motor potentiometer" function. • Setting is not effective in the operating mode 0x6060 (P301.00) = "CiA: Velocity mode [2]". ▶ Device profile CiA 402 □ 261

Flexible I/O configuration

Setpoint change-over

Motor potentiometer setpoint source (MOP)



Parameter	Name / value range / [default setting]	Info
0x291A (P223.00)	Deceleration time 2 (Decelerat.time 2) 0.0 ... [5.0] ... 3600.0 s	Deceleration time 2 for the operating mode "MS: Velocity mode". <ul style="list-style-type: none"> The deceleration time set refers to the deceleration from the maximum frequency set to standstill. In the case of a lower actual frequency, the actual deceleration time is reduced accordingly. The deceleration time 2 is active if the frequency setpoint (absolute value) \geq auto change-over threshold 0x291B (P224.00) or the trigger assigned to the function "Activate ramp 2" in 0x2631:039 (P400.39) = TRUE. The deceleration time 2 is also used for changing the MOP setpoint generated by the "motor potentiometer" function. Setting is not effective in the operating mode 0x6060 (P301.00) = "CiA: Velocity mode [2]". ▶ Device profile CiA 402 □ 261

Example for operating mode

- The analog input 1 is set as standard setpoint source.
- Switch S1 starts the motor in forward direction of rotation. Switch S1 in the initial position stops the motor again.
- Switch S2 activates the motor potentiometer as setpoint source. The MOP setpoint can then be increased via button S3 and reduced via button S4. If both buttons are pressed at the same time, the MOP setpoint remains unchanged.
- Switch S5 switches the direction of rotation.

Connection plan	function
	Potentiometer R1 Frequency setpoint selection
	Switch S1 Run
	Switch S2 Activate MOP setpoint
	Button S3 MOP setpoint up
	Button S4 MOP setpoint down
	Switch S5 Invert rotation

Parameter	Name	Setting for this example
0x2631:001 (P400.01)	Enable inverter	Constant TRUE [1]
0x2631:002 (P400.02)	Run	Digital input 1 [11]
0x2631:025 (P400.25)	Activate MOP setpoint	Digital input 2 [12]
0x2631:023 (P400.23)	MOP setpoint up	Digital input 3 [13]
0x2631:024 (P400.24)	MOP setpoint down	Digital input 4 [14]
0x2631:013 (P400.13)	Invert rotation	Digital input 5 [15]
0x2824 (P200.00)	Control selection	Flexible I/O configuration [0]
0x2838:003 (P203.03)	Stop method	Standard ramp [1]
0x2860:001 (P201.01)	Frequency control: Default setpoint source	Analog input 1 [2]
0x2917 (P220.00)	Acceleration time 1	1.0 s
0x2918 (P221.00)	Deceleration time 1	1.0 s
0x2919 (P222.00)	Acceleration time 2	4.0 s (for MOP setpoint change)
0x291A (P223.00)	Deceleration time 2	4.0 s (for MOP setpoint change)
0x4003 (P413.00)	MOP starting mode	Starting value [1]
0x4004:001 (P414.01)	MOP starting values: Frequency	20 Hz



Flexible I/O configuration

Setpoint change-over Motor potentiometer setpoint source (MOP)

Input signals

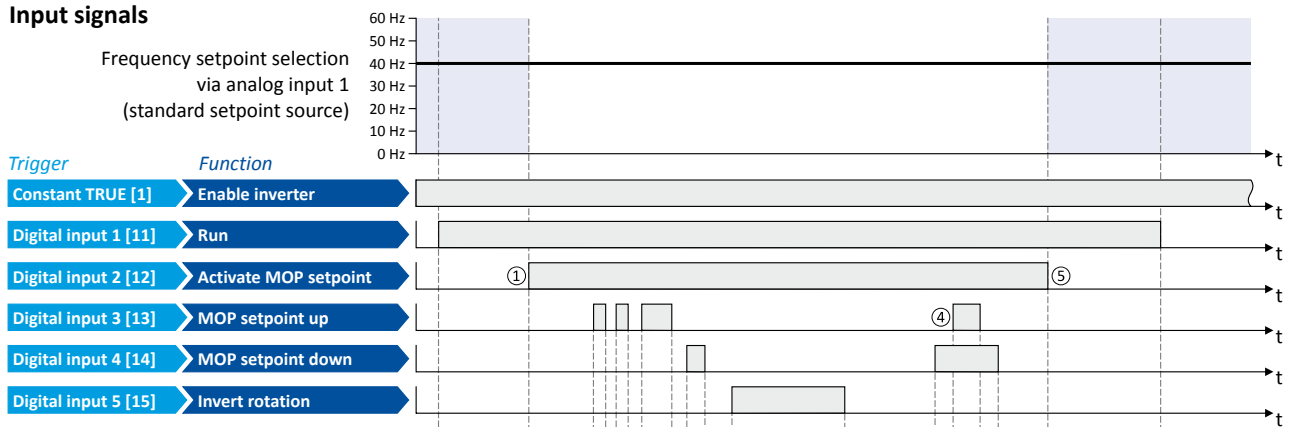

Output signals

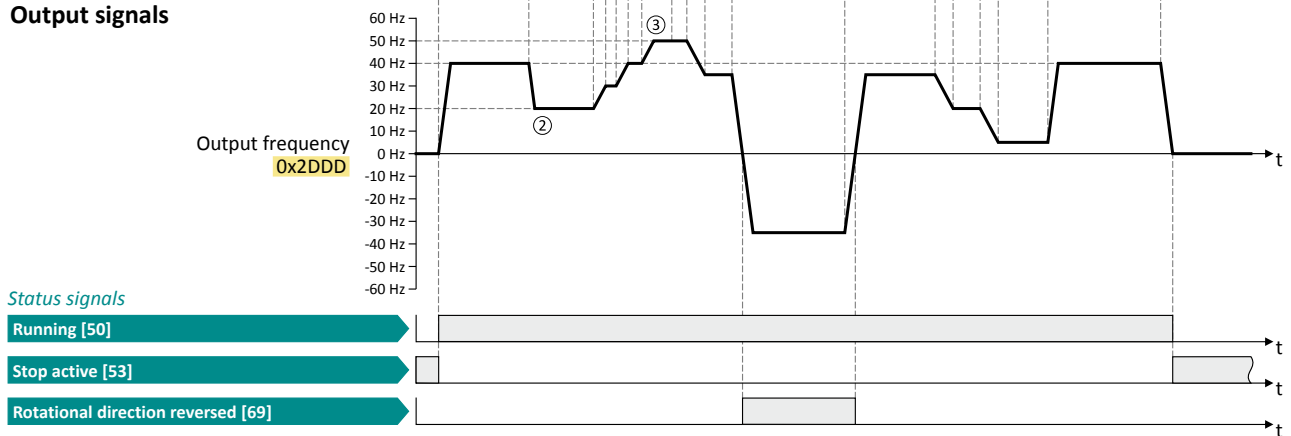

The status signals can be assigned to digital outputs. ▶ [Configuration of digital outputs](#) □ 355

- ① Change-over from analog input 1 (standard setpoint source) to MOP setpoint.
- ② The initial value for the motor potentiometer function depends on the setting in [0x4003 \(P413.00\)](#). In this example, the "starting value" set in [0x4004:001 \(P414.01\)](#) is used (here: 20 Hz).
- ③ The MOP setpoint is maximally increased to the maximum frequency set in [0x2916 \(P211.00\)](#) (here: 50 Hz).
- ④ If "MOP setpoint up" and "MOP setpoint down" are requested at the same time, the MOP setpoint remains unchanged.
- ⑤ Change-over from MOP setpoint back to analog input 1 (standard setpoint source).



11.4 Reset error

By means of the "Reset fault" function, an active error can be reset (acknowledged).

Preconditions

The error can only be reset if the error cause has been eliminated.

Parameter	Name / value range / [default setting]	Info
0x2631:004 (P400.04)	Function list: Reset fault (Function list: Reset fault) • For possible settings see description for 0x2631:001 (P400.01) . □ 299	Assignment of a trigger for the "Reset fault" function. Trigger = FALSE \nearrow TRUE (edge): Active error is reset (acknowledged) if the error condition is not active anymore and the error is resettable. Trigger = FALSE: no action.
	12 Digital input 2	State of X3/DI2, taking an inversion set in 0x2632:002 (P411.02) into consideration.

Further options for resetting an error

In addition to the "Reset error" function, there are the following options to reset an error:

function	Required state change to reset an error:
Enable inverter 0x2631:001 (P400.01)	TRUE \searrow FALSE (edge)
Run 0x2631:002 (P400.02)	TRUE \searrow FALSE (edge); see the following example
Keypad key	Keystroke

Example for operating mode

- Switch S1 starts the motor in forward direction of rotation. Switch S1 in the initial position stops the motor again.
- Switch S2 resets the current error if the error condition is not active anymore and the error is resettable.
- The switches/sensors S3 and S4 serve to set the inverter from the process to the error status. [▶ Triggering a user-defined fault □ 337](#)

Connection plan	function	
	Potentiometer R1	Frequency setpoint selection
	Switch S1	Run
	Switch S2	Reset fault
	Switch S3	Activate fault 1
	Switch S4	Activate fault 2

Parameter	Name	Setting for this example
0x2631:001 (P400.01)	Enable inverter	Constant TRUE [1]
0x2631:002 (P400.02)	Run	Digital input 1 [11]
0x2631:004 (P400.04)	Reset fault	Digital input 2 [12]
0x2631:013 (P400.13)	Invert rotation	Not connected [0]
0x2631:018 (P400.18)	Activate preset (bit 0)	Not connected [0]
0x2631:043 (P400.43)	Activate fault 1	Digital input 3 [13]
0x2631:044 (P400.44)	Activate fault 2	Digital input 4 [14]
0x2824 (P200.00)	Control selection	Flexible I/O configuration [0]
0x2838:003 (P203.03)	Stop method	Standard ramp [1]
0x2860:001 (P201.01)	Frequency control: Default setpoint source	Analog input 1 [2]
0x2918 (P221.00)	Deceleration time 1	5.0 s
0x291C (P225.00)	Quick stop deceleration time	1.0 s



The following signal flow illustrates the reset of an error both with the "Reset error" function ② and by cancelling the start command ④:

Input signals

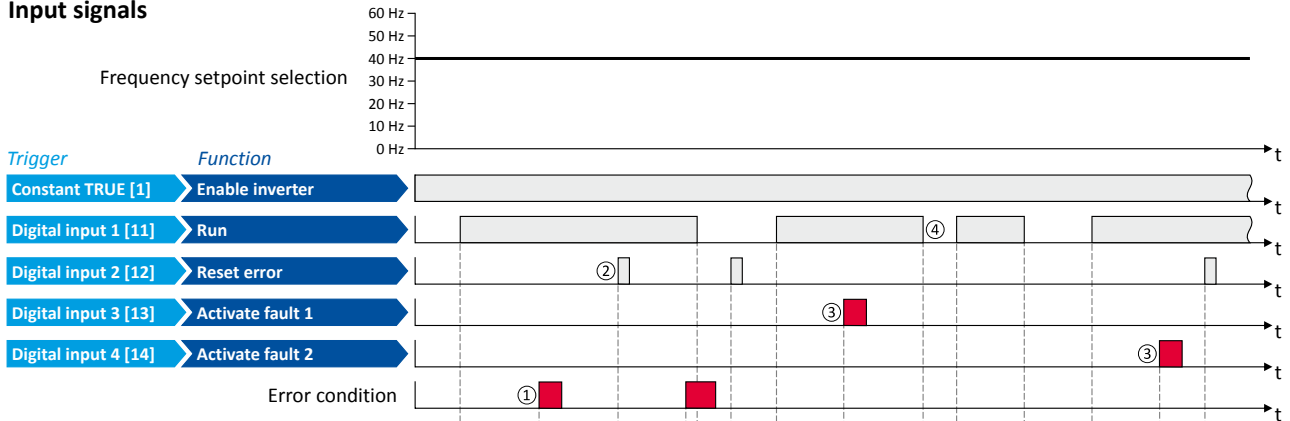

Output signals

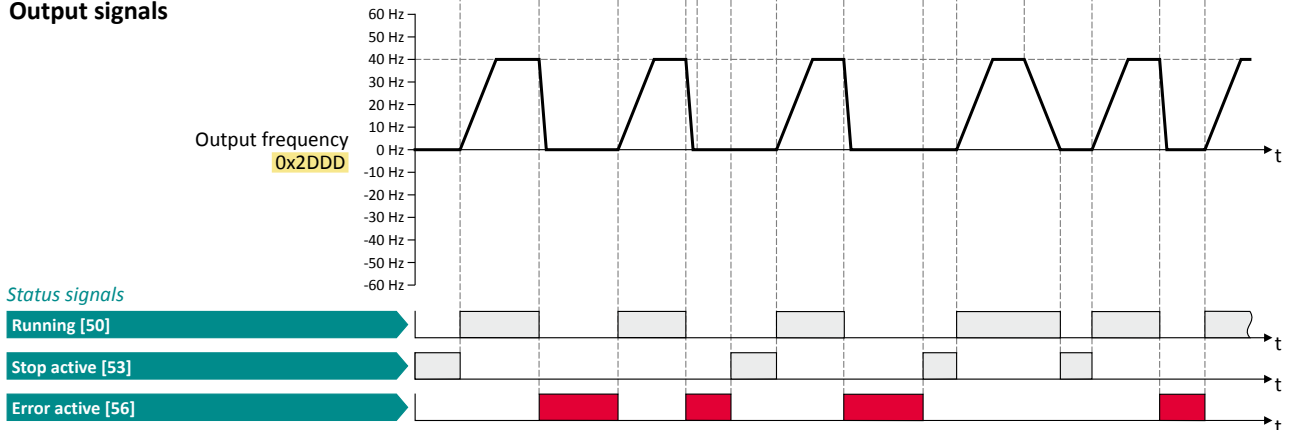

The status signals can be assigned to digital outputs. ▶ [Configuration of digital outputs](#) 355

- ① If an error condition is active in the inverter, the motor is brought to a standstill with the quick stop ramp. The inverter is then disabled. Exception: In case of a serious error, the inverter is disabled immediately. The motor becomes torqueless (coasts).
- ② If the error can be reset, the error state can be left again with the "Reset fault" function (if the error condition no longer exists). The motor accelerates again to the setpoint since the start command is still active.
- ③ The functions "Activate fault 1" and "Activate fault 2" serve to set the inverter from the process to the error status.
- ④ If the error can be reset, the cancelled start command results in leaving the error state (if the error condition no longer exists).

Related topics

▶ [Error handling](#) 83

Flexible I/O configuration

Activating DC braking manually



11.5 Activating DC braking manually

By means of the "Activate DC braking" function, DC braking can be activated manually.

Preconditions

The current for DC braking must be set > 0 % so that the function can be executed.

Parameter	Name / value range / [default setting]	Info
0x2631:005 (P400.05)	Function list: Activate DC braking (Function list: DC braking) • For possible settings see description for 0x2631:001 (P400.01) . □ 299	Assignment of a trigger for the "Activate DC braking" function. Trigger = TRUE: Activate DC braking. Trigger = FALSE: Deactivate DC braking. ⚠ CAUTION! DC braking remains active as long as the trigger is set to TRUE. ▶ DC braking □ 223
	00 Not connected	No trigger assigned (trigger is constantly FALSE).
0x2B84:001 (P704.01)	DC braking: Current (DC braking: Current) 0.0 ... [0.0] ... 200.0 %	Braking current for DC braking. • 100 % ≙ rated motor current 0x6075 (P323.00)

Example for operating mode

- Switch S1 starts the motor in forward direction of rotation. Switch S1 in the initial position stops the motor again.
- Switch S2 activates DC braking.

Connection plan	function
	Potentiometer R1 Frequency setpoint selection
	Switch S1 Run
	Switch S2 Activate DC braking

Parameter	Name	Setting for this example
0x2631:001 (P400.01)	Enable inverter	Constant TRUE [1]
0x2631:002 (P400.02)	Run	Digital input 1 [11]
0x2631:004 (P400.04)	Reset fault	Not connected [0]
0x2631:005 (P400.05)	Activate DC braking	Digital input 2 [12]
0x2824 (P200.00)	Control selection	Flexible I/O configuration [0]
0x2838:003 (P203.03)	Stop method	Standard ramp [1]
0x2860:001 (P201.01)	Frequency control: Default setpoint source	Analog input 1 [2]
0x2B84:001 (P704.01)	DC braking: Current	10 %



Flexible I/O configuration

Activating DC braking manually

Input signals

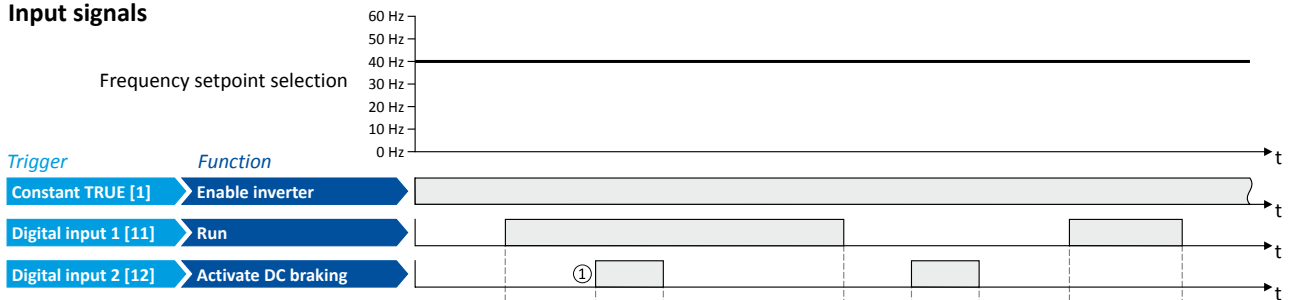

Output signals

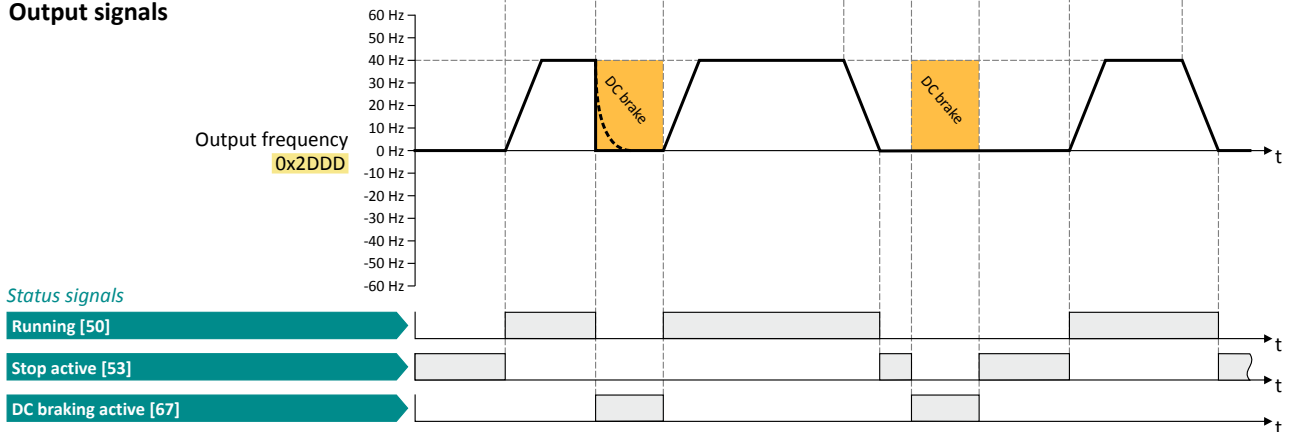

The status signals can be assigned to digital outputs. ▶ [Configuration of digital outputs](#) 355

- ① If DC braking is activated while the motor is running, the output pulses of the inverter are disabled immediately. For stopping the motor, the current set in 0x2B84:001 (P704.01) is injected. The exact drive behaviour depends on the settings for the "DC braking" function and the load properties.

Flexible I/O configuration

Releasing holding brake manually



11.6 Releasing holding brake manually

The "Release holding brake" function serves to release the holding brake immediately. Brake application time and brake opening time as well as the conditions for the automatic operation are not effective.

Preconditions

- Observe setting and application notes in the "Holding brake control" chapter! [265](#)
- The brake mode "Automatic [0]" or "Manual [1]" must be set in [0x2820:001 \(P712.01\)](#).
- The "Release holding brake [115]" trigger has to be assigned to a digital output or, in the simplest case, to the relay which then switches the brake supply.

Details

Detailed information about the function and configuration of the holding brake control can be found in the "Holding brake control" chapter. [265](#)

Parameter	Name / value range / [default setting]	Info
0x2631:049 (P400.49)	Function list: Release holding brake (Function list: Release brake) <ul style="list-style-type: none"> • Setting can only be changed if the inverter is inhibited. • For possible settings see description for 0x2631:001 (P400.01). 299 	Assignment of a trigger for the "Release holding brake" function. Trigger = TRUE: Release holding brake (immediately). Trigger = FALSE: no action. Notes: <ul style="list-style-type: none"> • Function is only executed if the brake mode 0x2820:001 (P712.01) is set to "Automatic [0]" or "Manual [1]". • The manually triggered "Release holding brake" command has a direct impact on the "Release holding brake [115]" trigger. Thus, the holding brake can be manually released if the power section is switched off. • The responsibility for a manual release of the holding brake has the external trigger source for the "Release holding brake" command!
	00 Not connected	No trigger assigned (trigger is constantly FALSE).

Example for operating mode

- Switch S1 starts the motor in forward direction of rotation. Switch S1 in the initial position stops the motor again.
- Switch S2 releases the holding brake. For this purpose, in this example, trigger "Release holding brake [115]" is assigned to the relay that switches the brake supply.

Connection plan	function
	Potentiometer R1 Frequency setpoint selection
	Switch S1 Run
	Switch S2 Release holding brake

Parameter	Name	Setting for this example
0x2631:001 (P400.01)	Enable inverter	Constant TRUE [1]
0x2631:002 (P400.02)	Run	Digital input 1 [11]
0x2631:004 (P400.04)	Reset fault	Not connected [0]
0x2631:049 (P400.49)	Release holding brake	Digital input 2 [12]
0x2634:001 (P420.01)	Relay	Release holding brake [115]
0x2824 (P200.00)	Control selection	Flexible I/O configuration [0]
0x2838:003 (P203.03)	Stop method	Standard ramp [1]
0x2860:001 (P201.01)	Frequency control: Default setpoint source	Analog input 1 [2]



Flexible I/O configuration

Releasing holding brake manually

Input signals

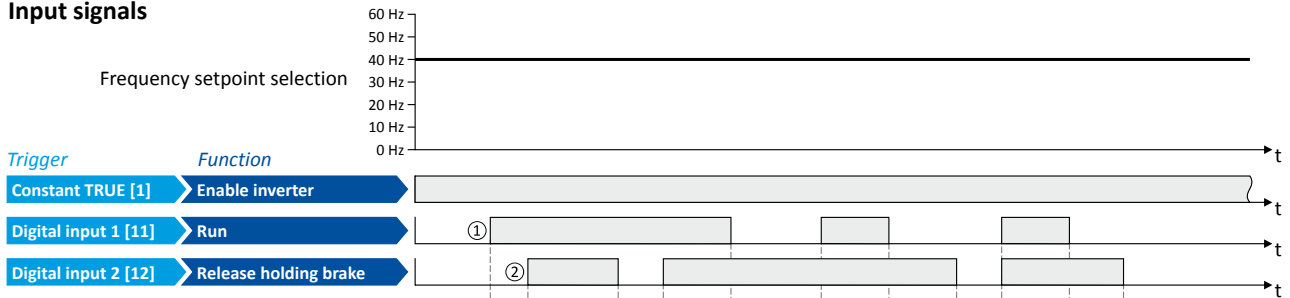

Output signals

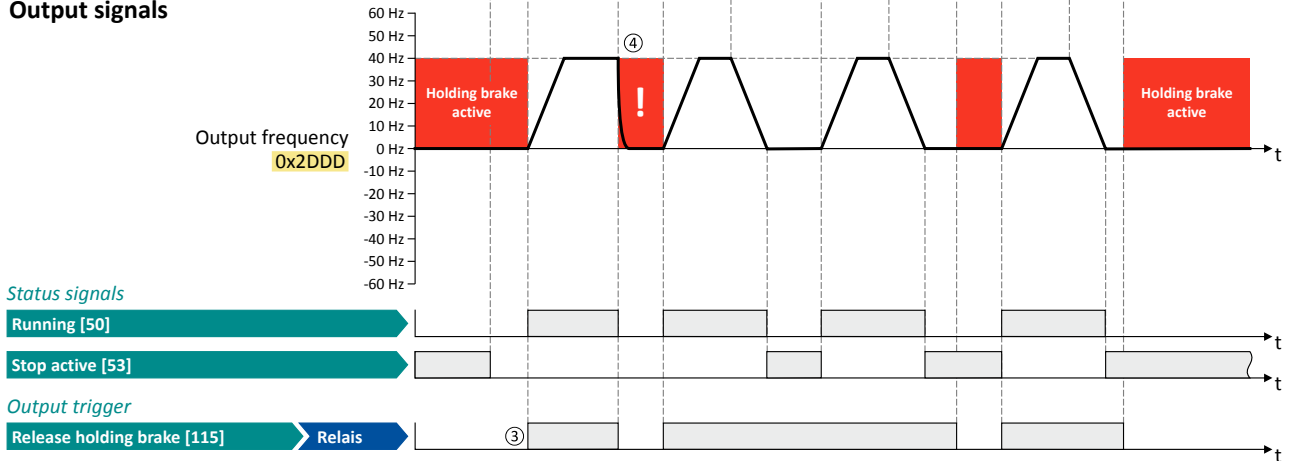

The status signals can be assigned to digital outputs. ▶ [Configuration of digital outputs](#) 355

- ① As the holding brake is active, the motor does not yet start to rotate after the start command.
- ② The holding brake is released. The motor is led to the setpoint.
- ③ In this example, the "Release holding brake [115]" trigger is assigned to the relay that switches the brake supply. In idle state, the holding brake is applied. If the relay is energised, the holding brake is released.
- ④ **Note:** Holding brakes are not intended for braking during operation. The increased wear caused by braking during operation may destroy the holding brakes prematurely!



11.7 Activating ramp 2 manually

The "Activate ramp 2" function serves to manually activate acceleration time 2 and deceleration time 2.

Parameter	Name / value range / [default setting]	Info
0x2631:039 (P400.39)	Function list: Activate ramp 2 (Function list: Activ. ramp 2) <ul style="list-style-type: none"> For possible settings see description for 0x2631:001 (P400.01). □ 299 	Assignment of a trigger for the "Activate ramp 2" function. Trigger = TRUE: activate acceleration time 2 and deceleration time 2 manually. Trigger = FALSE: no action / deactivate function again. Notes: <ul style="list-style-type: none"> If the function is used and the assigned trigger = TRUE, the auto change-over threshold 0x291B (P224.00) for ramp 2 is deactivated. Acceleration time 2 can be set in 0x2919 (P222.00). Deceleration time 2 can be set in 0x291A (P223.00).
	00 Not connected	No trigger assigned (trigger is constantly FALSE).
0x2917 (P220.00)	Acceleration time 1 (Accelerat.time 1) 0.0 ... [5.0] ... 3600.0 s	Acceleration time 1 for the operating mode "MS: Velocity mode". <ul style="list-style-type: none"> The acceleration time set refers to the acceleration from standstill to the maximum frequency set. In the case of a lower setpoint selection, the actual acceleration time is reduced accordingly. Setting is not effective in the operating mode 0x6060 (P301.00) = "CiA: Velocity mode [2]". ▶ Device profile CiA 402 □ 261
0x2918 (P221.00)	Deceleration time 1 (Decelerat.time 1) 0.0 ... [5.0] ... 3600.0 s	Deceleration time 1 for the operating mode "MS: Velocity mode". <ul style="list-style-type: none"> The deceleration time set refers to the deceleration from the maximum frequency set to standstill. In the case of a lower actual frequency, the actual deceleration time is reduced accordingly. Setting is not effective in the operating mode 0x6060 (P301.00) = "CiA: Velocity mode [2]". ▶ Device profile CiA 402 □ 261
0x2919 (P222.00)	Acceleration time 2 (Accelerat.time 2) 0.0 ... [5.0] ... 3600.0 s	Acceleration time 2 for the operating mode "MS: Velocity mode". <ul style="list-style-type: none"> The acceleration time set refers to the acceleration from standstill to the maximum frequency set. In the case of a lower setpoint selection, the actual acceleration time is reduced accordingly. The acceleration time 2 is active if the frequency setpoint (absolute value) \geq auto switching threshold 0x291B (P224.00) or the trigger assigned to the function "Activate ramp 2" in 0x2631:039 (P400.39) = TRUE. The acceleration time 2 is also used for changing the MOP setpoint generated by the "motor potentiometer" function. Setting is not effective in the operating mode 0x6060 (P301.00) = "CiA: Velocity mode [2]". ▶ Device profile CiA 402 □ 261
0x291A (P223.00)	Deceleration time 2 (Decelerat.time 2) 0.0 ... [5.0] ... 3600.0 s	Deceleration time 2 for the operating mode "MS: Velocity mode". <ul style="list-style-type: none"> The deceleration time set refers to the deceleration from the maximum frequency set to standstill. In the case of a lower actual frequency, the actual deceleration time is reduced accordingly. The deceleration time 2 is active if the frequency setpoint (absolute value) \geq auto change-over threshold 0x291B (P224.00) or the trigger assigned to the function "Activate ramp 2" in 0x2631:039 (P400.39) = TRUE. The deceleration time 2 is also used for changing the MOP setpoint generated by the "motor potentiometer" function. Setting is not effective in the operating mode 0x6060 (P301.00) = "CiA: Velocity mode [2]". ▶ Device profile CiA 402 □ 261



Example for operating mode

- Switch S1 starts the motor in forward direction of rotation. Switch S1 in the initial position stops the motor again.
- Switch S2 activates the acceleration time 2 and deceleration time 2.

Connection plan	function	
	Potentiometer R1	Frequency setpoint selection
	Switch S1	Run
	Switch S2	Activate ramp 2

Parameter	Name	Setting for this example
0x2631:001 (P400.01)	Enable inverter	Constant TRUE [1]
0x2631:002 (P400.02)	Run	Digital input 1 [11]
0x2631:004 (P400.04)	Reset fault	Not connected [0]
0x2631:039 (P400.39)	Activate ramp 2	Digital input 2 [12]
0x2824 (P200.00)	Control selection	Flexible I/O configuration [0]
0x2838:003 (P203.03)	Stop method	Standard ramp [1]
0x2860:001 (P201.01)	Frequency control: Default setpoint source	Analog input 1 [2]
0x2917 (P220.00)	Acceleration time 1	10.0 s
0x2918 (P221.00)	Deceleration time 1	10.0 s
0x2919 (P222.00)	Acceleration time 2	5.0 s
0x291A (P223.00)	Deceleration time 2	5.0 s

Input signals

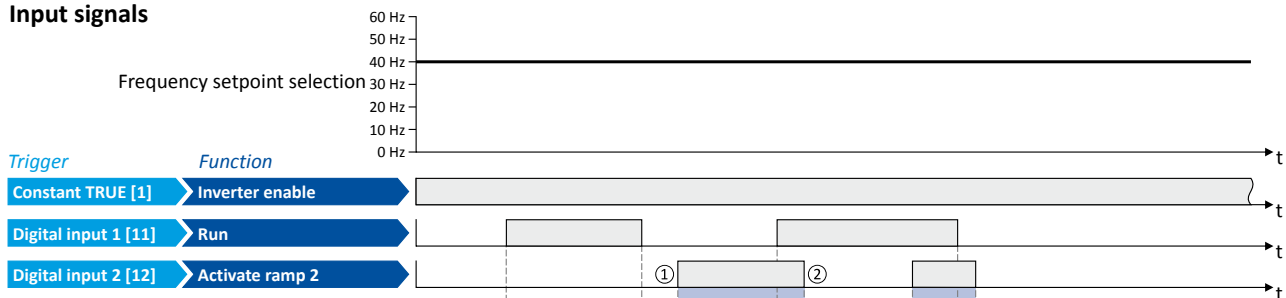

Output signals

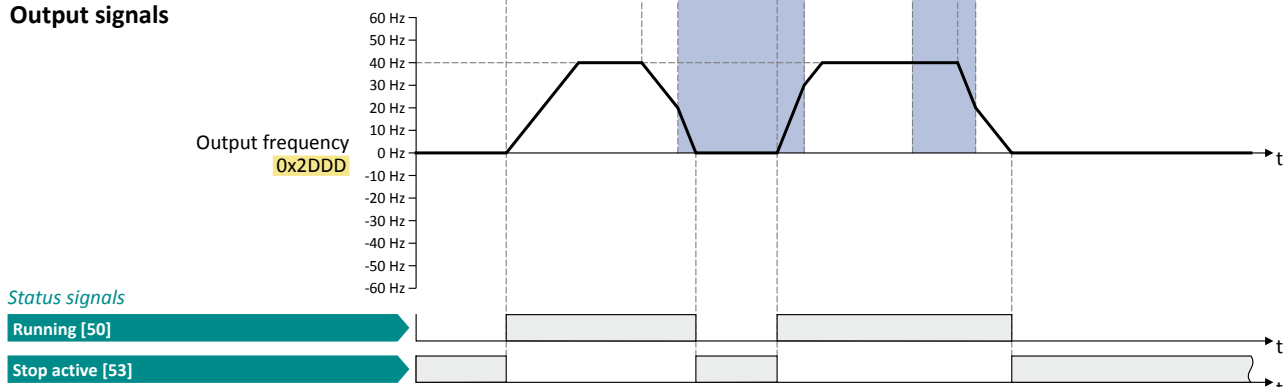

The status signals can be assigned to digital outputs. ▶ [Configuration of digital outputs](#) 355

- ① Change-over to deceleration time 2 during the deceleration phase.
- ② Change-over to acceleration time 1 during the acceleration phase.



11.8 Triggering a user-defined fault

The "Activate fault 1" and "Activate fault 2" functions serve to set the inverter from the process to the error status.

Details

If, for instance, sensors or switches are provided for process monitoring, which are designed to stop the process (and thus the drive) under certain conditions, these sensors/switches can be connected to free digital inputs of the inverter. The digital inputs used for the sensors/switches then have to be assigned to the functions "Activate fault 1" and "Activate fault 2" as triggers.

Parameter	Name / value range / [default setting]	Info
0x2631:043 (P400.43)	Function list: Activate fault 1 (Function list: Fault 1) <ul style="list-style-type: none"> For possible settings see description for 0x2631:001 (P400.01). ↗ 299 	Assignment of a trigger for the "Activate fault 1" function. Trigger = TRUE: Trigger user-defined error 1. Trigger = FALSE: no action. Notes: <ul style="list-style-type: none"> After the error is triggered, the motor is brought to a standstill with the quick stop ramp. The inverter is then disabled. Associated error code: <ul style="list-style-type: none"> 25217 0x6281 - User-defined fault 1
	00 Not connected	No trigger assigned (trigger is constantly FALSE).
0x2631:044 (P400.44)	Function list: Activate fault 2 (Function list: Fault 2) <ul style="list-style-type: none"> For possible settings see description for 0x2631:001 (P400.01). ↗ 299 	Assignment of a trigger for the "Activate fault 2" function. Trigger = TRUE: Trigger user-defined error 2. Trigger = FALSE: no action. Notes: <ul style="list-style-type: none"> After the error is triggered, the motor is brought to a standstill with the quick stop ramp. The inverter is then disabled. Associated error code: <ul style="list-style-type: none"> 25218 0x6282 - User-defined fault 2
	00 Not connected	No trigger assigned (trigger is constantly FALSE).

Example

An example of the operating mode can be found in the chapter "[Reset error](#)". [↗ 328](#)

Related topics

▶ [Error handling](#) [↗ 83](#)



11.9 Functions for parameter change-over

The inverter supports several parameter sets. The parameter set can be selected by means of the "Select parameter set (bit 0)" and "Select parameter set (bit 1)" functions.

⚠ DANGER!

Changed parameter settings can become effective immediately depending on the activating method set in [0x4046 \(P755.00\)](#).

The possible consequence is an unexpected response of the motor shaft while the inverter is enabled.

- ▶ If possible, only carry out parameter changes while the inverter is disabled.
- ▶ Certain device commands or settings which might cause a critical state of the drive behaviour can generally only be carried out when the inverter is inhibited.

Details

The "parameter change-over" function provides a change-over between four sets with different parameter values for up to 32 freely selectable parameters. For details on the compilation of the parameters and setting of the value sets, see the chapter "[Parameter change-over](#)".

[246](#)

A value set is selected in a binary-coded fashion via the triggers assigned to the two Select parameter set (bit 0)" and "Select parameter set (bit 1)" functions in compliance with the following truth table:

Select parameter set (bit 0) 0x2631:042 (P400.42)	Select parameter set (bit 1) 0x2631:041 (P400.41)	Selection
FALSE	FALSE	Value set 1
FALSE	TRUE	Value set 2
TRUE	FALSE	Value set 3
TRUE	TRUE	Value set 4

Change-over is effected depending on the activation method selected in [0x4046 \(P755.00\)](#) when a state change of the selection inputs takes place or via the trigger assigned to the "Load parameter set" function.

Parameter	Name / value range / [default setting]	Info
0x2631:040 (P400.40)	Function list: Load parameter set (Function list: Load param.set) <ul style="list-style-type: none"> • Setting can only be changed if the inverter is inhibited. • For possible settings see description for 0x2631:001 (P400.01). 299 	Assignment of a trigger for the "Load parameter set" function. Trigger = FALSE-TRUE edge: parameter change-over to the value set selected via "Select parameter set (bit 0)" and "Select parameter set (bit 1)". Trigger = FALSE: no action. Notes: <ul style="list-style-type: none"> • The activation method for the "Parameter change-over" function can be selected in 0x4046 (P755.00).
	00 Not connected	No trigger assigned (trigger is constantly FALSE).
0x2631:041 (P400.41)	Function list: Select parameter set (bit 0) (Function list: Sel. paramset b0) <ul style="list-style-type: none"> • Setting can only be changed if the inverter is inhibited. • For possible settings see description for 0x2631:001 (P400.01). 299 	Assignment of a trigger for the "Select parameter set (bit 0)" function. Selection bit with the valency 2^0 for "Parameter change-over" function. Trigger = FALSE: selection bit = "0". Trigger = TRUE: selection bit = "1".
	00 Not connected	No trigger assigned (trigger is constantly FALSE).
0x2631:042 (P400.42)	Function list: Select parameter set (bit 1) (Function list: Sel. paramset b1) <ul style="list-style-type: none"> • Setting can only be changed if the inverter is inhibited. • For possible settings see description for 0x2631:001 (P400.01). 299 	Assignment of a trigger for the "Select parameter set (bit 1)" function. Selection bit with the valency 2^1 for "Parameter change-over" function. Trigger = FALSE: selection bit = "0". Trigger = TRUE: selection bit = "1".
	00 Not connected	No trigger assigned (trigger is constantly FALSE).

Flexible I/O configuration

Functions for parameter change-over



Parameter	Name / value range / [default setting]	Info
0x4046 (P755.00)	Activation of parameter set (PSet activation)	Selection of the activation method for the parameter change-over. <ul style="list-style-type: none"> If the selection is changed from "Via command... [0]/[1]" to "If the selection is changed...[2]/[3]" after switch-on, the parameter set selected via the functions "Select parameter set (bit 0)" and "Select parameter set (bit 1)" is activated immediately. In case of selection [2], however, this only takes place if the inverter is disabled, the motor is stopped or an error is active.
	0 Via command (disable required)	The parameter set selected via the functions "Select parameter set (bit 0)" and "Select parameter set (bit 1)" is activated if the trigger assigned to the "Load parameter set" function in 0x2631:040 (P400.40) provides a FALSE-TRUE edge AND the inverter is inhibited, the motor is stopped or an error is active.
	1 Via command (immediately)	The parameter set selected via the functions "Select parameter set (bit 0)" and "Select parameter set (bit 1)" is immediately activated if the trigger assigned to the "Load parameter set" function in 0x2631:040 (P400.40) provides a FALSE-TRUE edge.
	2 If the selection is changed (disable required)	The parameter set selected via the functions "Select parameter set (bit 0)" and "Select parameter set (bit 1)" is activated if the state of these selection bits changes AND the inverter is inhibited, the motor is stopped or an error is active.
	3 If the selection is changed (immediately)	The parameter set selected via the functions "Select parameter set (bit 0)" and "Select parameter set (bit 1)" is activated immediately if the state of these selection bits is changed.



Flexible I/O configuration

Functions for parameter change-over
 Example 1: Activation via command (only when disabled)

11.9.1 Example 1: Activation via command (only when disabled)

Activation method 0x4046 (P755.00) = "Via command (disable required) [0]":

- Switches S3 and S4 serve to select the parameter set (see the following table).
- Switch S2 activates the change-over. Since the change-over is activated with a rising edge, a button (normally-open contact) can be used instead of a switch.
- Change-over is only possible if the motor is not started (switch S1 open).

Connection plan	function															
	Switch S1 Run															
	Switch S2 Load parameter set															
	Switches S3 ... S4 Parameter set selection:															
	<table border="1"> <thead> <tr> <th>S3</th> <th>S4</th> <th></th> </tr> </thead> <tbody> <tr> <td>Off</td> <td>Off</td> <td>Parameter set 1</td> </tr> <tr> <td>On</td> <td>Off</td> <td>Parameter set 2</td> </tr> <tr> <td>Off</td> <td>On</td> <td>Parameter set 3</td> </tr> <tr> <td>On</td> <td>On</td> <td>Parameter set 4</td> </tr> </tbody> </table>	S3	S4		Off	Off	Parameter set 1	On	Off	Parameter set 2	Off	On	Parameter set 3	On	On	Parameter set 4
	S3	S4														
	Off	Off	Parameter set 1													
On	Off	Parameter set 2														
Off	On	Parameter set 3														
On	On	Parameter set 4														

Parameter	Name	Setting for this example
0x2631:001 (P400.01)	Enable inverter	Constant TRUE [1]
0x2631:002 (P400.02)	Run	Digital input 1 [11]
0x2631:004 (P400.04)	Reset fault	Not connected [0]
0x2631:013 (P400.13)	Invert rotation	Not connected [0]
0x2631:018 (P400.18)	Activate preset (bit 0)	Not connected [0]
0x2631:040 (P400.40)	Load parameter set	Digital input 2 [12]
0x2631:041 (P400.41)	Select parameter set (bit 0)	Digital input 3 [13]
0x2631:042 (P400.42)	Select parameter set (bit 1)	Digital input 4 [14]
0x2824 (P200.00)	Control selection	Flexible I/O configuration [0]
0x4046 (P755.00)	Activation of parameter set	Via command (disable required) [0]

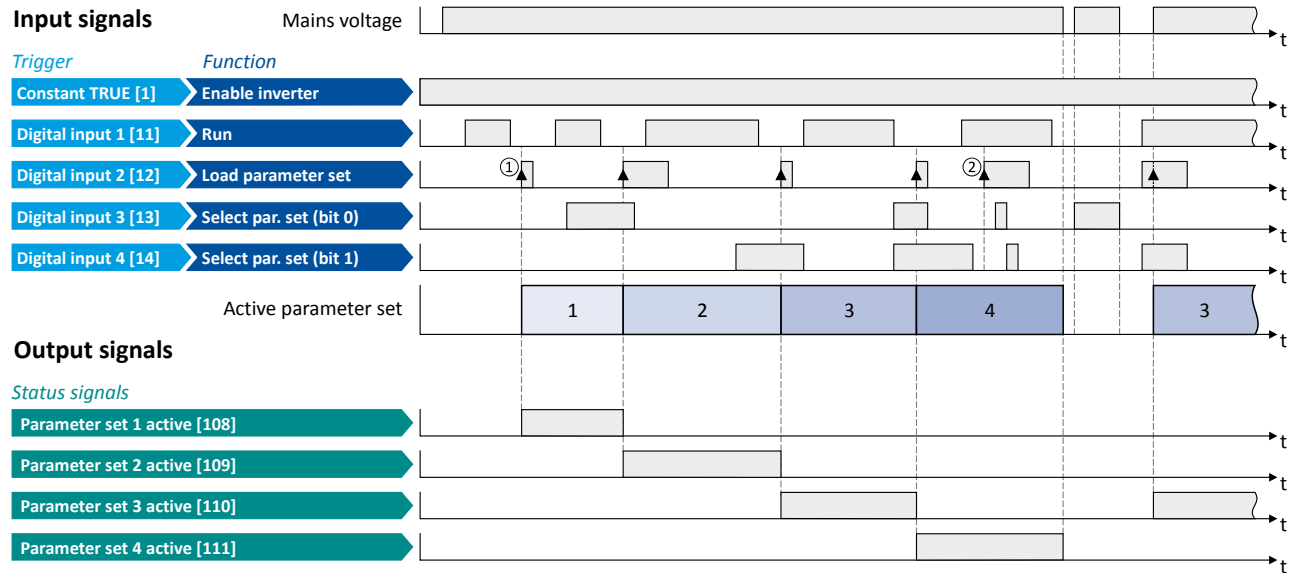

The status signals can be assigned to digital outputs. ▶ [Configuration of digital outputs](#) 355

- ① The change-over is activated with the "Load parameter set" function (FALSE/TRUE edge).
- ② If the inverter is enabled and the motor is started, a change-over is not possible.

Flexible I/O configuration

Functions for parameter change-over

Example 2: Activation via command (immediately)



11.9.2 Example 2: Activation via command (immediately)

Activation method 0x4046 (P755.00) = "Via command (immediately) [1]":

- Switches S3 and S4 serve to select the parameter set (see the following table).
- Switch S2 activates the change-over. Since the change-over is activated with a rising edge, a button (normally-open contact) can be used instead of a switch.
- Change-over takes place immediately, even if the motor is started (switch S1 closed).

Connection plan	function															
	Switch S1 Run															
	Switch S2 Load parameter set															
	Switches S3 ... S4 Parameter set selection:															
	<table border="1"> <thead> <tr> <th>S3</th> <th>S4</th> <th></th> </tr> </thead> <tbody> <tr> <td>Off</td> <td>Off</td> <td>Parameter set 1</td> </tr> <tr> <td>On</td> <td>Off</td> <td>Parameter set 2</td> </tr> <tr> <td>Off</td> <td>On</td> <td>Parameter set 3</td> </tr> <tr> <td>On</td> <td>On</td> <td>Parameter set 4</td> </tr> </tbody> </table>	S3	S4		Off	Off	Parameter set 1	On	Off	Parameter set 2	Off	On	Parameter set 3	On	On	Parameter set 4
	S3	S4														
Off	Off	Parameter set 1														
On	Off	Parameter set 2														
Off	On	Parameter set 3														
On	On	Parameter set 4														

Parameter	Name	Setting for this example
0x2631:001 (P400.01)	Enable inverter	Constant TRUE [1]
0x2631:002 (P400.02)	Run	Digital input 1 [11]
0x2631:004 (P400.04)	Reset fault	Not connected [0]
0x2631:018 (P400.18)	Activate preset (bit 0)	Not connected [0]
0x2631:040 (P400.40)	Load parameter set	Digital input 2 [12]
0x2631:041 (P400.41)	Select parameter set (bit 0)	Digital input 3 [13]
0x2631:042 (P400.42)	Select parameter set (bit 1)	Digital input 4 [14]
0x2824 (P200.00)	Control selection	Flexible I/O configuration [0]
0x4046 (P755.00)	Activation of parameter set	Via command (immediately) [1]

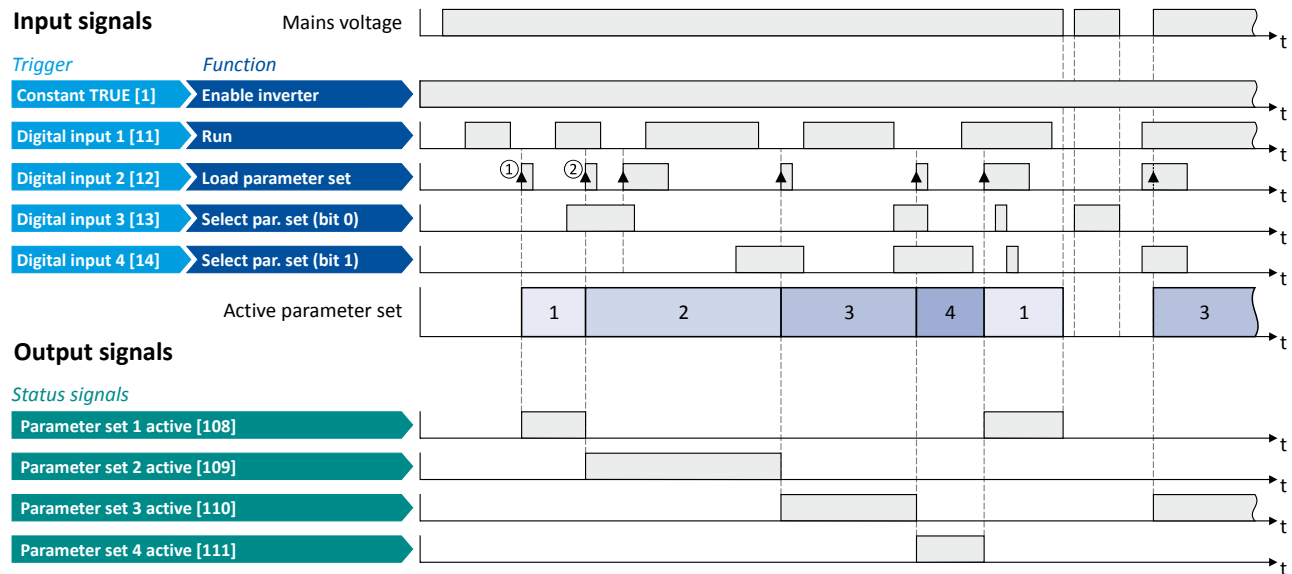

The status signals can be assigned to digital outputs. ▶ [Configuration of digital outputs](#) 355

- ① The change-over is activated with the "Load parameter set" function (FALSE/TRUE edge).
- ② Change-over is also possible if the inverter is enabled and the motor is started.



Flexible I/O configuration

Functions for parameter change-over

Example 3: Activation if the selection is changed (only if the inverter is disabled)

11.9.3 Example 3: Activation if the selection is changed (only if the inverter is disabled)

Activation method 0x4046 (P755.00) = "If the selection is changed (disable required) [2]":

- Switches S3 and S4 serve to select the parameter set (see the following table). At the same time, the change-over is activated by a status change of the selection inputs.
- Change-over is only possible if the motor is not started (switch S1 open).
- Switch S2 ("Load parameter set") is ignored in this configuration.

Connection plan	function															
	Switch S1 Run															
	Switch S2 Load parameter set (is ignored in this configuration)															
	Switches S3 ... S4 Parameter set selection and activation at the same time:															
	<table border="1"> <thead> <tr> <th>S3</th> <th>S4</th> <th></th> </tr> </thead> <tbody> <tr> <td>Off</td> <td>Off</td> <td>Parameter set 1</td> </tr> <tr> <td>On</td> <td>Off</td> <td>Parameter set 2</td> </tr> <tr> <td>Off</td> <td>On</td> <td>Parameter set 3</td> </tr> <tr> <td>On</td> <td>On</td> <td>Parameter set 4</td> </tr> </tbody> </table>	S3	S4		Off	Off	Parameter set 1	On	Off	Parameter set 2	Off	On	Parameter set 3	On	On	Parameter set 4
	S3	S4														
Off	Off	Parameter set 1														
On	Off	Parameter set 2														
Off	On	Parameter set 3														
On	On	Parameter set 4														

Parameter	Name	Setting for this example
0x2631:001 (P400.01)	Enable inverter	Constant TRUE [1]
0x2631:002 (P400.02)	Run	Digital input 1 [11]
0x2631:004 (P400.04)	Reset fault	Not connected [0]
0x2631:013 (P400.13)	Invert rotation	Not connected [0]
0x2631:018 (P400.18)	Activate preset (bit 0)	Not connected [0]
0x2631:040 (P400.40)	Load parameter set	Digital input 2 [12]
0x2631:041 (P400.41)	Select parameter set (bit 0)	Digital input 3 [13]
0x2631:042 (P400.42)	Select parameter set (bit 1)	Digital input 4 [14]
0x2824 (P200.00)	Control selection	Flexible I/O configuration [0]
0x4046 (P755.00)	Activation of parameter set	If the selection is changed (disable required) [2]

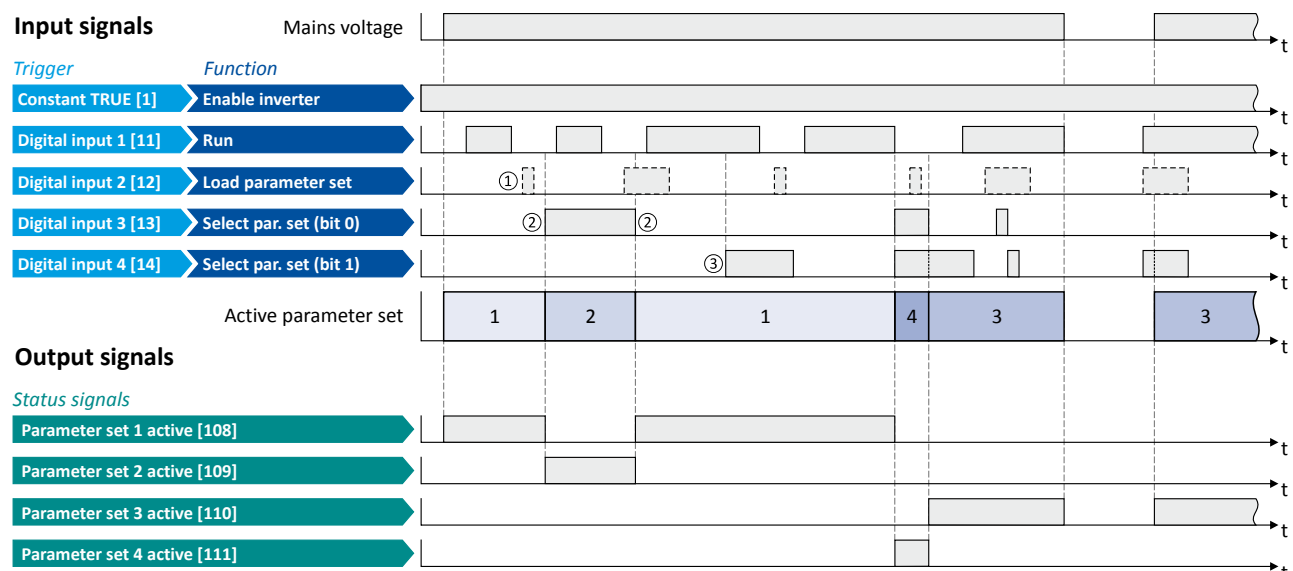

The status signals can be assigned to digital outputs. [► Configuration of digital outputs 355](#)

- ① The "Load parameter set" function is ignored in this configuration.
- ② Change-over takes place by a status change of the selection inputs.
- ③ If the inverter is enabled and the motor is started, a change-over is not possible.

Flexible I/O configuration

Functions for parameter change-over

Example 4: Activation if the selection is changed (immediately)



11.9.4 Example 4: Activation if the selection is changed (immediately)

Activation method 0x4046 (P755.00) = "If the selection is changed (immediately) [3]":

- Switches S3 and S4 serve to select the parameter set (see the following table). At the same time, the change-over is activated by a status change of the selection inputs.
- Change-over takes place immediately, even if the motor is started (switch S1 closed).
- Switch S2 ("Load parameter set") is ignored in this configuration.

Connection plan	function															
	Switch S1 Run															
	Switch S2 Load parameter set (is ignored in this configuration)															
	Switches S3 ... S4 Parameter set selection and activation at the same time:															
	<table border="1"> <thead> <tr> <th>S3</th> <th>S4</th> <th></th> </tr> </thead> <tbody> <tr> <td>Off</td> <td>Off</td> <td>Parameter set 1</td> </tr> <tr> <td>On</td> <td>Off</td> <td>Parameter set 2</td> </tr> <tr> <td>Off</td> <td>On</td> <td>Parameter set 3</td> </tr> <tr> <td>On</td> <td>On</td> <td>Parameter set 4</td> </tr> </tbody> </table>	S3	S4		Off	Off	Parameter set 1	On	Off	Parameter set 2	Off	On	Parameter set 3	On	On	Parameter set 4
	S3	S4														
Off	Off	Parameter set 1														
On	Off	Parameter set 2														
Off	On	Parameter set 3														
On	On	Parameter set 4														

Parameter	Name	Setting for this example
0x2631:001 (P400.01)	Enable inverter	Constant TRUE [1]
0x2631:002 (P400.02)	Run	Digital input 1 [11]
0x2631:004 (P400.04)	Reset fault	Not connected [0]
0x2631:013 (P400.13)	Invert rotation	Not connected [0]
0x2631:018 (P400.18)	Activate preset (bit 0)	Not connected [0]
0x2631:040 (P400.40)	Load parameter set	Digital input 2 [12]
0x2631:041 (P400.41)	Select parameter set (bit 0)	Digital input 3 [13]
0x2631:042 (P400.42)	Select parameter set (bit 1)	Digital input 4 [14]
0x2824 (P200.00)	Control selection	Flexible I/O configuration [0]
0x4046 (P755.00)	Activation of parameter set	If the selection is changed (immediately) [3]

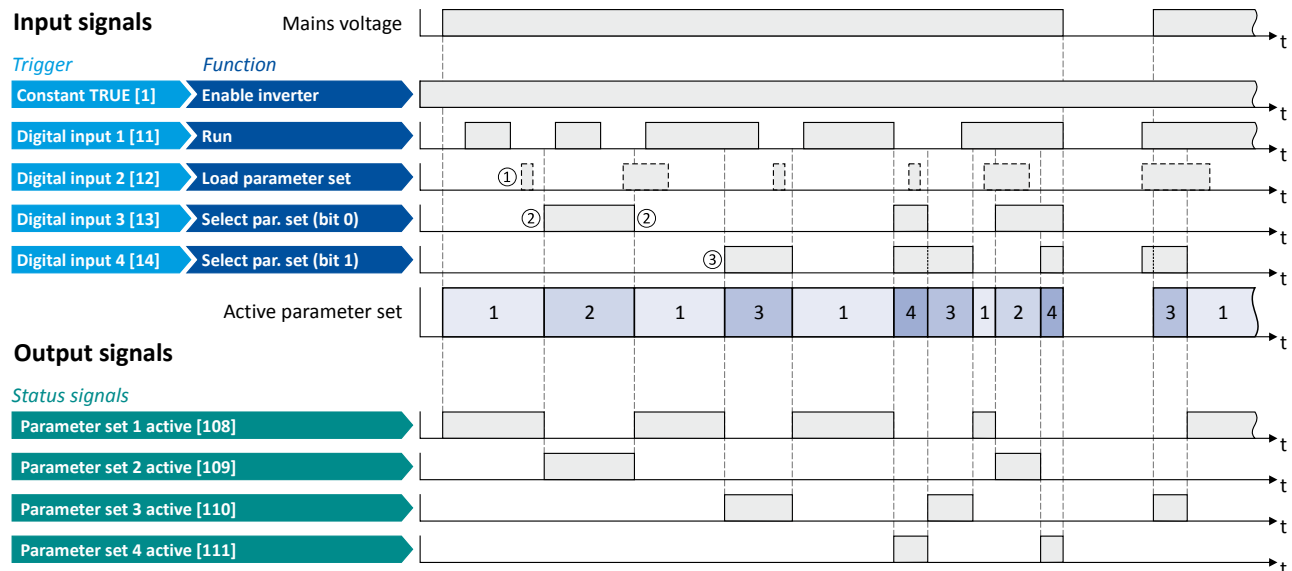

The status signals can be assigned to digital outputs. [► Configuration of digital outputs 355](#)

- ① The "Load parameter set" function is ignored in this configuration.
- ② Change-over takes place by a status change of the selection inputs.
- ③ Change-over is also possible if the inverter is enabled and the motor is started.



11.10 Process controller function selection

By means of the following functions, the response of the inverter can be controlled when PID control is activated. ▶ [Configuring the process controller](#) 206

Parameter	Name / value range / [default setting]	Info
0x2631:045 (P400.45)	Function list: Deactivate PID controller (Function list: PID off) • For possible settings see description for 0x2631:001 (P400.01) . 299	Assignment of a trigger for the "Deactivate PID controller" function. Trigger = TRUE: If PID control is activated, ignore PID control and drive the motor in speed-controlled manner. Trigger = FALSE: If PID control is activated, drive the motor with PID control. Notes: • The PID control mode can be selected in 0x4020:001 (P600.01) .
	00 Not connected	No trigger assigned (trigger is constantly FALSE).
0x2631:046 (P400.46)	Function list: Set process controller output to 0 (Function list: PID output=0) • For possible settings see description for 0x2631:001 (P400.01) . 299	Assignment of a trigger for the "Set process controller output to 0" function. Trigger = TRUE: If PID control is activated, I component and the output of the PID controller are set to 0 and the internal control algorithm is stopped. The PID control remains active. Trigger = FALSE: no action / deactivate function again.
	00 Not connected	No trigger assigned (trigger is constantly FALSE).
0x2631:047 (P400.47)	Function list: Inhibit process controller I-component (Function list: PID-I inhibited) • For possible settings see description for 0x2631:001 (P400.01) . 299	Assignment of a trigger for the "Inhibit process controller I-component" function. Trigger = TRUE: If PID control is activated, the I component of the PID controller is set to 0 and the integration process is stopped. Trigger = FALSE: no action / deactivate function again. Notes: • The reset time can be set in 0x4049 (P602.00) .
	00 Not connected	No trigger assigned (trigger is constantly FALSE).
0x2631:048 (P400.48)	Function list: Activate process controller influence ramp (Function list: PID-Inf ramp on) • For possible settings see description for 0x2631:001 (P400.01) . 299	Assignment of a trigger for the "Activate process controller influence ramp" function. Trigger = TRUE: the influence of the process controller is shown via a ramp. Trigger = FALSE or not connected: the influence of the process controller is hidden via ramp. Notes: • The influence of the process controller is always active (not only when PID control is activated). • Acceleration time for showing the influence of the process controller can be set in 0x404C:001 (P607.01) . • Deceleration time for hiding the influence of the process controller can be set in 0x404C:002 (P607.02) .
	01 Constant TRUE	Trigger is constantly TRUE.
0x4020:001 (P600.01)	Process controller: Operating mode (Process control.: Operating mode)	Selection of the process controller operating mode.
	0 Inhibited	Process controller deactivated.
	1 Normal operation	The setpoint is higher than the fed back variable (actual value). If the system deviation increases, the motor speed is increased. Example: pressure-controlled booster pumps (increase in the motor speed produces an increase in pressure.)
	2 Reverse operation	The setpoint is lower than the fed back variable (actual value). If the system deviation increases, the motor speed is increased. Example: temperature-controlled cooling water pump (increase in motor speed produces decrease in temperature.)
	3 Normal bi-directional	The direction of rotation corresponds to the sign of the system deviation. If the system deviation increases, the motor speed is increased.
4 Reverse bi-directional	A negative system deviation causes a positive direction of rotation. If the system deviation increases, the motor speed is increased.	
0x4049 (P602.00)	PID I- component (PID I- component) 20 ... [400] ... 6000 ms	Reset time for system deviation. • With the setting "6000 ms", the I component is deactivated. • The I component can also be deactivated via the "Inhibit process controller I-component" 0x2631:047 (P400.47) function.

Flexible I/O configuration

Process controller function selection



Parameter	Name / value range / [default setting]	Info
0x404C:001 (P607.01)	PID influence: Acceleration time for showing (PID influence: Show time) 0.0 ... [5.0] ... 999.9 s	If the trigger assigned in 0x2631:048 (P400.48) of the "Activate process controller influence ramp" function is TRUE, the influence of the process controller is shown by means of a ramp with the acceleration time set here.
0x404C:002 (P607.02)	PID influence: Deceleration time for masking out (PID influence: Mask out time) 0.0 ... [5.0] ... 999.9 s	If the trigger assigned in 0x2631:048 (P400.48) of the "Activate process controller influence ramp" function is FALSE, the influence of the process controller is hidden via a ramp with the deceleration time set here.

Example for operating mode

In the following example, the "Deactivate PID controller" function is used to deactivate the PID control temporarily:

- As standard setpoint source, the frequency preset 1 is set to 20 Hz.
- Switch S1 starts the motor in forward direction of rotation. Switch S1 in the initial position stops the motor again.
- Switch S2 deactivates the PID control. The motor is then driven in a speed-controlled way.

Connection plan	function
	Switch S1 Run
	Switch S2 Deactivate PID controller

Parameter	Name	Setting for this example
0x2631:001 (P400.01)	Enable inverter	Constant TRUE [1]
0x2631:002 (P400.02)	Run	Digital input 1 [11]
0x2631:004 (P400.04)	Reset fault	Not connected [0]
0x2631:045 (P400.45)	Deactivate PID controller	Digital input 2 [12]
0x2824 (P200.00)	Control selection	Flexible I/O configuration [0]
0x2838:003 (P203.03)	Stop method	Standard ramp [1]
0x2860:001 (P201.01)	Frequency control: Default setpoint source	Frequency preset 1 [11]
0x2911:001 (P450.01)	Frequency setpoint presets: Preset 1	20 Hz
0x2916 (P211.00)	Maximum frequency	50 Hz



The example assumes that the process controller has been configured accordingly. ▶ [Configuring the process controller](#) 206



Flexible I/O configuration

Process controller function selection

Input signals

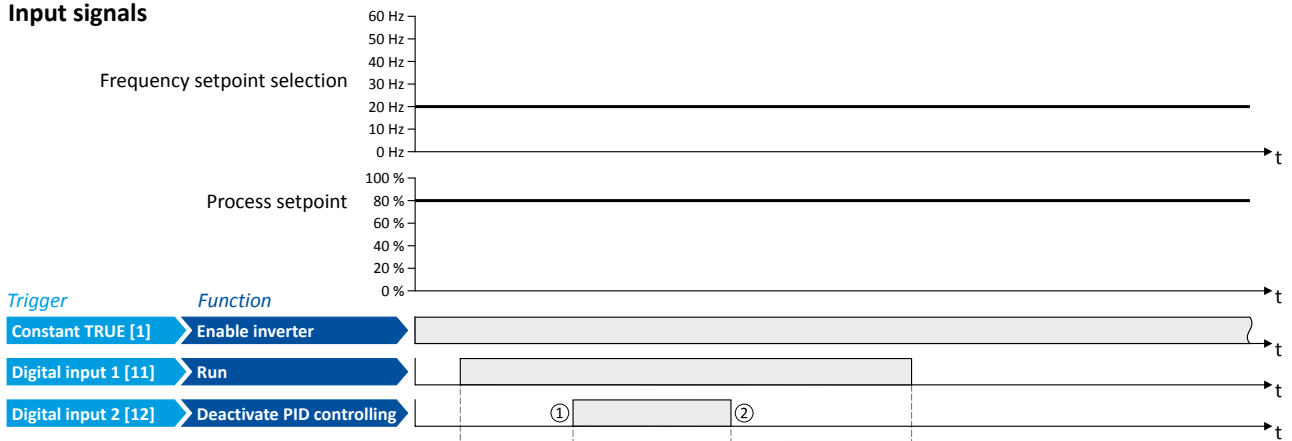

Output signals

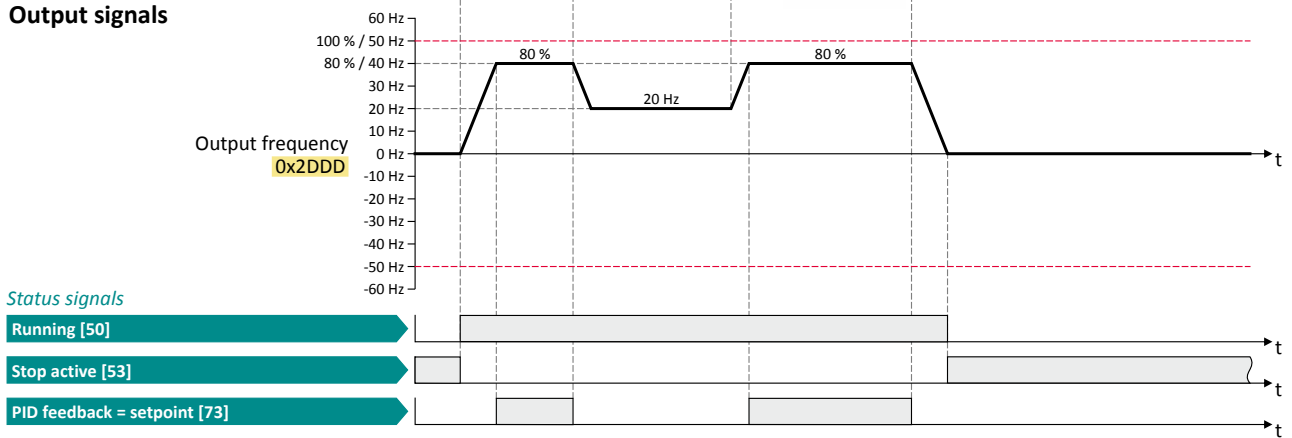

The status signals can be assigned to digital outputs. ▶ [Configuration of digital outputs](#) □ 355

- ① PID control is deactivated: Change-over from the configured PID control to the speed-controlled operation.
- ② PID control is activated again: Change-over from the speed-controlled operation to the configured PID control.

Flexible I/O configuration

Frequency threshold for "Frequency threshold exceeded" trigger



11.11 Frequency threshold for "Frequency threshold exceeded" trigger

As a function of the current output frequency, the adjustable frequency threshold serves to trigger a certain function or set a digital output.

Parameter	Name / value range / [default setting]	Info
0x4005 (P412.00)	Frequency threshold (Freq. threshold) 0.0 ... [0.0] ... 599.0 Hz	Threshold for the "Frequency threshold exceeded [70]" trigger. <ul style="list-style-type: none"> The "Frequency threshold exceeded [70]" trigger is TRUE if the current output frequency is higher than the set threshold. The trigger can be assigned to a function or to a digital output.

Example for operating mode

In the following example, the digital output 1 is set to TRUE if the output frequency is higher than 20 Hz.

- The analog input 1 is set as standard setpoint source.
- Switch S1 starts the motor in forward direction of rotation. Switch S1 in the initial position stops the motor again.

Connection plan	function
	Potentiometer R1 Frequency setpoint selection
	Switch S1 Run

Parameter	Name	Setting for this example
0x2631:001 (P400.01)	Enable inverter	Constant TRUE [1]
0x2631:002 (P400.02)	Run	Digital input 1 [11]
0x2634:002 (P420.02)	Digital outputs function: Digital output 1	Frequency threshold exceeded [70]
0x2824 (P200.00)	Control selection	Flexible I/O configuration [0]
0x2860:001 (P201.01)	Frequency control: Default setpoint source	Analog input 1 [2]
0x4005 (P412.00)	Frequency threshold	20 Hz

Input signals

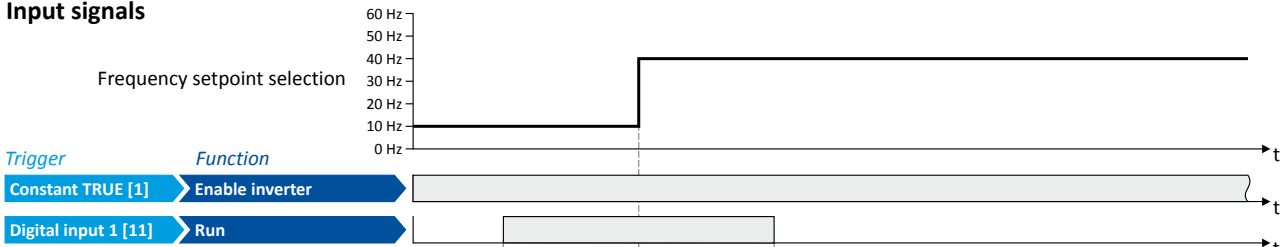

Output signals

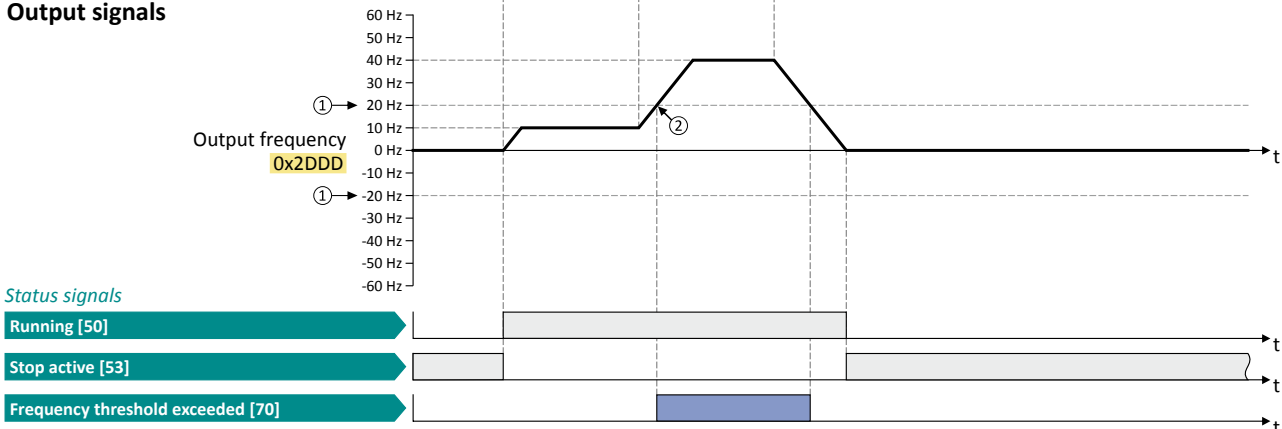

The status signals can be assigned to digital outputs. ▶ [Configuration of digital outputs](#) 355

- ① Frequency threshold 0x4005 (P412.00)
- ② Frequency threshold exceeded: Via trigger "Frequency threshold exceeded [70]", the digital output 1 is set to TRUE.



11.12 Configuration of digital inputs

Settings for digital inputs 1 ... 5.

Parameter	Name / value range / [default setting]	Info
0x2630:002 (P410.02)	Settings for digital inputs: Input function (DI settings: Input function)	Input function of the digital terminals DI3 and DI4.
	0 Digital input	DI3 = digital input DI4 = digital input
0x2632:001 (P411.01)	Inversion of digital inputs: Digital input 1 (DI inversion: DI1 inversion)	Inversion of digital input 1
	0 Not inverted	
	1 Inverted	
0x2632:002 (P411.02)	Inversion of digital inputs: Digital input 2 (DI inversion: DI2 inversion)	Inversion of digital input 2
	0 Not inverted	
	1 Inverted	
0x2632:003 (P411.03)	Inversion of digital inputs: Digital input 3 (DI inversion: DI3 inversion)	Inversion of digital input 3
	0 Not inverted	
	1 Inverted	
0x2632:004 (P411.04)	Inversion of digital inputs: Digital input 4 (DI inversion: DI4 inversion)	Inversion of digital input 4
	0 Not inverted	
	1 Inverted	
0x2632:005 (P411.05)	Inversion of digital inputs: Digital input 5 (DI inversion: DI5 inversion)	Inversion of digital input 5
	0 Not inverted	
	1 Inverted	
0x2633:001	Digital input debounce time: Digital input 1 1 ... [1] ... 50 ms	Debounce time of digital input 1
0x2633:002	Digital input debounce time: Digital input 2 1 ... [1] ... 50 ms	Debounce time of digital input 2
0x2633:003	Digital input debounce time: Digital input 3 1 ... [1] ... 50 ms	Debounce time of digital input 3
0x2633:004	Digital input debounce time: Digital input 4 1 ... [1] ... 50 ms	Debounce time of digital input 4
0x2633:005	Digital input debounce time: Digital input 5 1 ... [1] ... 50 ms	Debounce time of digital input 5

Example: Activating two functions simultaneously via digital input 4

The principle of assigning triggers to functions also enables a digital input to be assigned to several functions. The wiring complexity is reduced since there is no necessity to interconnect several digital inputs.

If, for instance, the frequency preset 1 is to be selected via the digital input 4 and a change-over to the acceleration time 2 and deceleration time 2 is to take place at the same time, this can be easily realised by the following parameter setting:

Parameter	Name	Setting for this example
0x2631:018 (P400.18)	Activate preset (bit 0)	Digital input 4 [14]
0x2631:039 (P400.39)	Activate ramp 2	Digital input 4 [14]



In order to achieve the desired behaviour, the digital input 4 must not be assigned to any further functions!

Flexible I/O configuration

Configuration of analog inputs
Analog input 1



11.13 Configuration of analog inputs

11.13.1 Analog input 1

Settings for analog input 1.

Details

The analog input 1 can be used as setpoint source. ▶ [Selection of setpoint source](#) 89

For the process controller, the analog input can be used for the feedback of the variable (actual value) or speed feedforward control. ▶ [Basic process controller settings](#) 207

The following settings are possible for the analog input:

- Definition of the input range ①
- Filter time for low-pass filters ②
- Monitoring of the input signal ③
- Dead band for eliminating the smallest signal levels ④
- Definition of the setting range ⑤

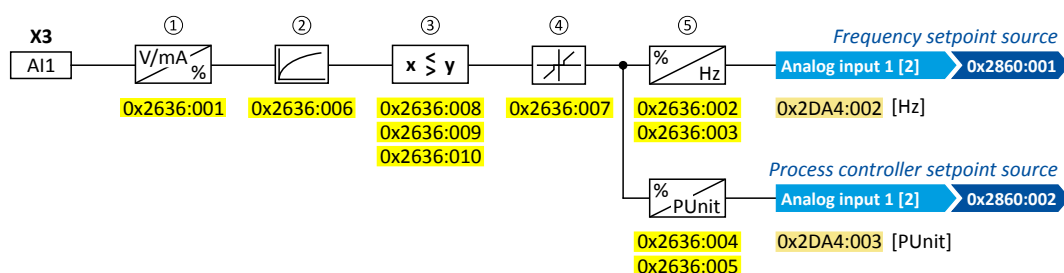

Diagnostic parameters:

- The frequency value is displayed in [0x2DA4:002 \(P110.02\)](#).
- The process controller value is displayed in [0x2DA4:003 \(P110.03\)](#).

Definition of the input range

The analog input can be configured as voltage or current input. Internally, the signal is always converted to a value in percent.

Definition of the setting range

The setting range results from the set min and max value for the respective mode.

Configuration examples

Detailed configuration examples can be found in the following subchapters:

- ▶ [Example 1: Input range 0 ... 10 V ≙ setting range 0 ... 50 Hz](#) 351
- ▶ [Example 2: Input range 0 ... 10 V ≙ setting range -40 ... +40 Hz](#) 351
- ▶ [Example 3: Error detection](#) 352

Parameter	Name / value range / [default setting]	Info
0x2636:001 (P430.01)	Analog input 1: Input range (Analog input 1: AI1 input range) 0 0 ... 10 VDC 1 0 ... 5 VDC 2 2 ... 10 VDC 4 4 ... 20 mA 5 0 ... 20 mA	Definition of the input range.
0x2636:002 (P430.02)	Analog input 1: Min frequency value (Analog input 1: AI1 freq @ min) -1000.0 ... [0.0] ... 1000.0 Hz	Definition of the setting range for operating mode "MS: Velocity mode". • Direction of rotation according to sign.
0x2636:003 (P430.03)	Analog input 1: Max frequency value (Analog input 1: AI1 freq @ max) -1000.0 ... [50.0] ... 1000.0 Hz	



Flexible I/O configuration

Configuration of analog inputs

Analog input 1

Parameter	Name / value range / [default setting]	Info
0x2636:004 (P430.04)	Analog input 1: Min PID value (Analog input 1: AI1 PID @ min) -300.00 ... [0.00] ... 300.00 PID unit/%	Definition of the setting range for PID control.
0x2636:005 (P430.05)	Analog input 1: Max PID value (Analog input 1: AI1 PID @ max) -300.00 ... [100.00] ... 300.00 PID unit/%	
0x2636:006 (P430.06)	Analog input 1: Filter time (Analog input 1: AI1 filter time) 0 ... [10] ... 10000 ms	PT1 time constant for low-pass filter. <ul style="list-style-type: none"> By the use of a low-pass filter, the impacts of noise to an analog signal can be minimised. For an optimum filter effect, first the noise frequency has to be determined. The time constant then has to be set so that it equals the reciprocal value of the double frequency.
0x2636:007 (P430.07)	Analog input 1: Dead band (Analog input 1: AI1 dead band) 0.0 ... [0.0] ... 100.0 %	Optional setting of a dead band that is placed symmetrically around the frequency zero point. <ul style="list-style-type: none"> The value set defines half the width of the dead band in [%]. Example: Setting 2 % results in a dead band of 4 %. If the analog input value is within the dead band, the output value for the motor control is set to "0".
0x2636:008 (P430.08)	Analog input 1: Monitoring threshold (Analog input 1: AI1 monit.level) -100.0 ... [0.0] ... 100.0 %	Monitoring threshold for analog input 1. <ul style="list-style-type: none"> 100 % \equiv 10 V (with configuration as voltage input) 100 % \equiv 20 mA (with configuration as current loop)
0x2636:009 (P430.09)	Analog input 1: Monitoring condition (Analog input 1: AI1 monit.cond.) 0 Input value < trigger threshold 1 Input value > trigger threshold	Monitoring condition for analog input 1. <ul style="list-style-type: none"> If the selected condition is met, the "Error of analog input 1 active [81]" trigger is set to TRUE. The trigger can be assigned to a function or a digital output. If the selected condition is met for at least 500 ms, the error response set in 0x2636:010 (P430.10) takes place.
0x2636:010 (P430.10)	Analog input 1: Error response (Analog input 1: AI1 error resp.) <ul style="list-style-type: none"> For possible settings see description for 0x2D45:001 (P310.01). □ 133 3 Fault	Error response for analog input 1. <ul style="list-style-type: none"> The selected response takes place if the monitoring condition selected in 0x2636:009 (P430.09) is met for at least 500 ms. Associated error code: <ul style="list-style-type: none"> 28801 0x7081 - Analog input 1 fault ▶ Error types □ 83

Flexible I/O configuration

Configuration of analog inputs
Analog input 1



11.13.1.1 Example 1: Input range 0 ... 10 V \equiv setting range 0 ... 50 Hz

In this configuration, for instance, a frequency setpoint between 0 and 50 Hz can be set with a potentiometer connected to the analog input.

Connection plan	function
	Potentiometer R1 Frequency setpoint selection (Input voltage 1 V \equiv 5 Hz)

Parameter	Name	Setting for this example
0x2636:001 (P430.01)	Analog input 1: Input range	0 ... 10 VDC [0]
0x2636:002 (P430.02)	Analog input 1: Min frequency value	0.0 Hz
0x2636:003 (P430.03)	Analog input 1: Max frequency value	50.0 Hz
0x2636:006 (P430.06)	Analog input 1: Filter time	10 ms

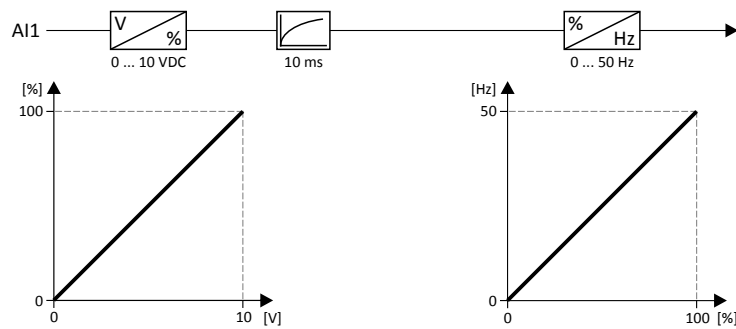

11.13.1.2 Example 2: Input range 0 ... 10 V \equiv setting range -40 ... +40 Hz

In this example, a bipolar setting range and a dead band with 2 % are configured.

Parameter	Name	Setting for this example
0x2636:001 (P430.01)	Analog input 1: Input range	0 ... 10 VDC [0]
0x2636:002 (P430.02)	Analog input 1: Min frequency value	-40.0 Hz
0x2636:003 (P430.03)	Analog input 1: Max frequency value	40.0 Hz
0x2636:006 (P430.06)	Analog input 1: Filter time	10 ms
0x2636:007 (P430.07)	Analog input 1: Dead band	2.0 %

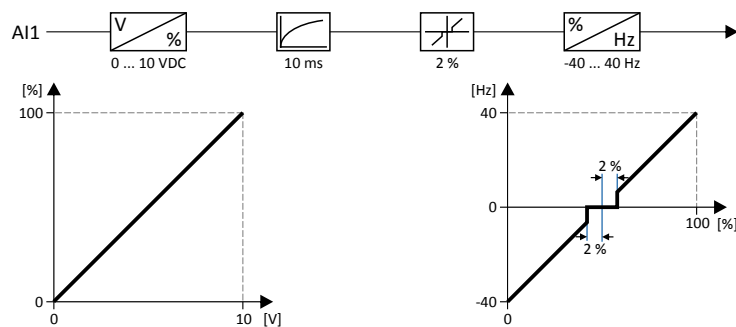



11.13.1.3 Example 3: Error detection

In this example, the digital output 1 is set via the trigger "Error of analog input 1 active [81]" if the percentage input value is lower than 10 %. Additionally, a warning is output.

Parameter	Name	Setting for this example
0x2634:002 (P420.02)	Digital outputs function: Digital output 1	Error of analog input 1 active [81]
0x2636:001 (P430.01)	Analog input 1: Input range	0 ... 10 VDC [0]
0x2636:002 (P430.02)	Analog input 1: Min frequency value	0.0 Hz
0x2636:003 (P430.03)	Analog input 1: Max frequency value	40.0 Hz
0x2636:006 (P430.06)	Analog input 1: Filter time	10 ms
0x2636:008 (P430.08)	Analog input 1: Monitoring threshold	10.0 %
0x2636:009 (P430.09)	Analog input 1: Monitoring condition	Input value < trigger threshold [0]
0x2636:010 (P430.10)	Analog input 1: Error response	Warning [1]

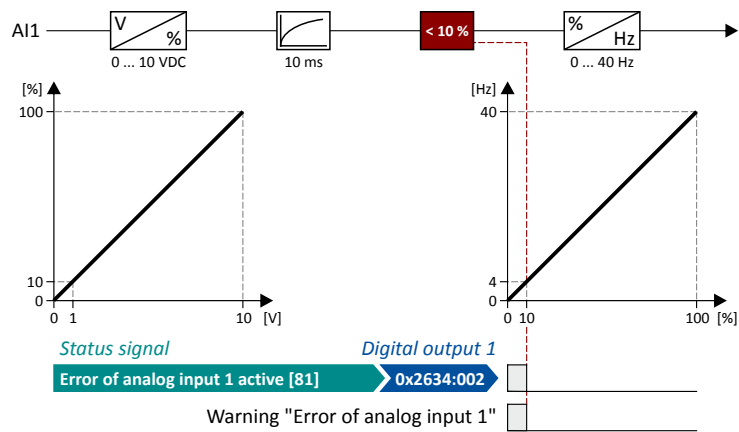

Flexible I/O configuration

Configuration of analog inputs
Analog input 2



11.13.2 Analog input 2

Settings for analog input 2.

Details

The analog input 2 can be used as setpoint source. ▶ [Selection of setpoint source](#) 89

For the process controller, the analog input can be used for the feedback of the variable (actual value) or speed feedforward control. ▶ [Basic process controller settings](#) 207

The following settings are possible for the analog input:

- Definition of the input range ①
- Filter time for low-pass filters ②
- Monitoring of the input signal ③
- dead band for eliminating the smallest signal levels ④
- Definition of the setting range ⑤

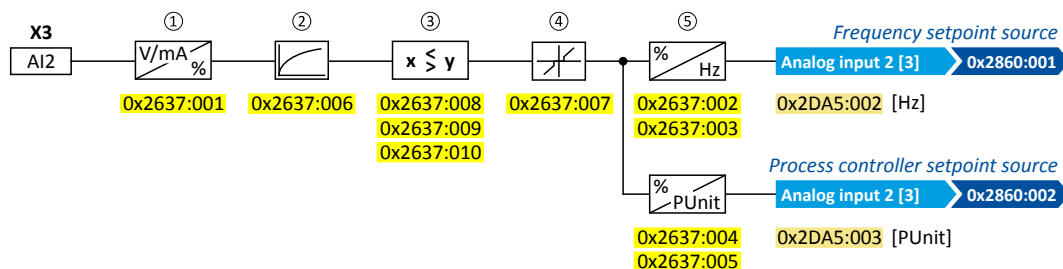

Diagnostic parameters:

- The frequency value is displayed in [0x2DA5:002 \(P111.02\)](#).
- The process controller value is displayed in [0x2DA5:003 \(P111.03\)](#).

For further details and configuration examples, see chapter "[Analog input 1](#)". 348

Parameter	Name / value range / [default setting]	Info
0x2637:001 (P431.01)	Analog input 2: Input range (Analog input 2: AI2 input range)	Definition of the input range.
	0 0 ... 10 VDC	
	1 0 ... 5 VDC	
	2 2 ... 10 VDC	
0x2637:002 (P431.02)	Analog input 2: Min frequency value (Analog input 2: AI2 freq @ min) -1000.0 ... [0.0] ... 1000.0 Hz	Definition of the setting range for operating mode "MS: Velocity mode". • Direction of rotation according to sign.
0x2637:003 (P431.03)	Analog input 2: Max frequency value (Analog input 2: AI2 freq @ max) -1000.0 ... [50.0] ... 1000.0 Hz	
0x2637:004 (P431.04)	Analog input 2: Min PID value (Analog input 2: AI2 PID @ min) -300.00 ... [0.00] ... 300.00 PID unit/%	Definition of the setting range for PID control.
0x2637:005 (P431.05)	Analog input 2: Max PID value (Analog input 2: AI2 PID @ max) -300.00 ... [100.00] ... 300.00 PID unit/%	
0x2637:006 (P431.06)	Analog input 2: Filter time (Analog input 2: AI2 filter time) 0 ... [10] ... 10000 ms	PT1 time constant for low-pass filter. • By the use of a low-pass filter, the impacts of noise to an analog signal can be minimised. • For an optimum filter effect, first the noise frequency has to be determined. The time constant then has to be set so that it equals the reciprocal value of the double frequency.
0x2637:007 (P431.07)	Analog input 2: Dead band (Analog input 2: AI2 dead band) 0.0 ... [0.0] ... 100.0 %	Optional setting of a dead band that is placed symmetrically around the frequency zero point. • The value set defines half the width of the dead band in [%]. • Example: Setting 2 % results in a dead band of 4 %. • If the analog input value is within the dead band, the output value for the motor control is set to "0".
0x2637:008 (P431.08)	Analog input 2: Monitoring threshold (Analog input 2: AI2 monit.level) -100.0 ... [0.0] ... 100.0 %	Monitoring threshold for analog input 2. Trigger threshold for monitoring the analog input. • 100 % ≙ 10 V (with configuration as voltage input) • 100 % ≙ 20 mA (with configuration as current loop)



Flexible I/O configuration

Configuration of analog inputs

Analog input 2

Parameter	Name / value range / [default setting]	Info
0x2637:009 (P431.09)	Analog input 2: Monitoring condition (Analog input 2: AI2 error resp.)	Monitoring condition for analog input 2. Trigger condition for monitoring the analog input. <ul style="list-style-type: none"> If the selected condition is met, the "Error of analog input 2 active [82]" trigger is set to TRUE. The trigger can be assigned to a function or a digital output. If the selected condition is met for at least 500 ms, the error response set in 0x2637:010 (P431.10) takes place. If the trigger condition is met for at least 500 ms, the response set in subindex 10 is effected.
	0 Input value < trigger threshold	Monitoring condition for analog input 2. <ul style="list-style-type: none"> If the selected condition is met, the "Error of analog input 2 active [82]" trigger is set to TRUE. The trigger can be assigned to a function or a digital output. If the selected condition is met for at least 500 ms, the error response set in 0x2637:010 (P431.10) takes place.
	1 Input value > trigger threshold	Monitoring condition for analog input 2. <ul style="list-style-type: none"> If the selected condition is met, the "Error of analog input 2 active [82]" trigger is set to TRUE. The trigger can be assigned to a function or a digital output. If the selected condition is met for at least 500 ms, the error response set in 0x2637:010 (P431.10) takes place.
0x2637:010 (P431.10)	Analog input 2: Error response (Analog input 2: AI2 error resp.) <ul style="list-style-type: none"> For possible settings see description for 0x2D45:001 (P310.01). □ 133 	Error response for analog input 2. <ul style="list-style-type: none"> The selected response takes place if the monitoring condition selected in 0x2637:009 (P431.09) is met for at least 500 ms. Associated error code: <ul style="list-style-type: none"> 28802 0x7082 - Analog input 2 fault
	3 Fault	▶ Error types □ 83

Flexible I/O configuration

Configuration of digital outputs

Relay



11.14 Configuration of digital outputs

11.14.1 Relay

Settings for the relay.



Relay is not suitable for direct switching of an electromechanical holding brake!

Use a corresponding suppressor circuit in case of an inductive or capacitive load!

Parameter	Name / value range / [default setting]	Info
0x2634:001 (P420.01)	Digital outputs function: Relay (Dig.out.function: Relay function)	Assignment of a trigger to the relay. Trigger = FALSE: X9/NO-COM open and NC-COM closed. Trigger = TRUE: X9/NO-COM closed and NC-COM open. Notes: • An inversion set in 0x2635:001 (P421.01) is taken into consideration here.
	0 Not connected	No trigger assigned (trigger is constantly FALSE).
	1 Constant TRUE	Trigger is constantly TRUE.
	11 Digital input 1	State of X3/DI1, taking an inversion set in 0x2632:001 (P411.01) into consideration.
	12 Digital input 2	State of X3/DI2, taking an inversion set in 0x2632:002 (P411.02) into consideration.
	13 Digital input 3	State of X3/DI3, taking an inversion set in 0x2632:003 (P411.03) into consideration.
	14 Digital input 4	State of X3/DI4, taking an inversion set in 0x2632:004 (P411.04) into consideration.
	15 Digital input 5	State of X3/DI5, taking an inversion set in 0x2632:005 (P411.05) into consideration.
	34 NetWordIN2 - bit 0	State of NetWordIN2/bit 0. • Display of NetWordIN2 in 0x4008:002 (P590.02) . • For controlling the digital outputs via network, NetWordIN2 can be mapped to a process data input word.
	35 NetWordIN2 - bit 1	State of NetWordIN2/bit 1.
	36 NetWordIN2 - bit 2	State of NetWordIN2/bit 2.
	37 NetWordIN2 - bit 3	State of NetWordIN2/bit 3.
	38 NetWordIN2 - bit 4	State of NetWordIN2/bit 4.
	39 NetWordIN2 - bit 5	State of NetWordIN2/bit 5.
	40 NetWordIN2 - bit 6	State of NetWordIN2/bit 6.
	41 NetWordIN2 - bit 7	State of NetWordIN2/bit 7.
	42 NetWordIN2 - bit 8	State of NetWordIN2/bit 8.
	43 NetWordIN2 - bit 9	State of NetWordIN2/bit 9.
	44 NetWordIN2 - bit 10	State of NetWordIN2/bit 10.
	45 NetWordIN2 - bit 11	State of NetWordIN2/bit 11.
	46 NetWordIN2 - bit 12	State of NetWordIN2/bit 12.
	47 NetWordIN2 - bit 13	State of NetWordIN2/bit 13.
	48 NetWordIN2 - bit 14	State of NetWordIN2/bit 14.
	49 NetWordIN2 - bit 15	State of NetWordIN2/bit 15.
	50 Running	TRUE if inverter and start are enabled and output frequency > 0.2 Hz. Otherwise FALSE.
	51 Ready for operation	TRUE if inverter is ready for operation (no error active, no STO active and DC-bus voltage ok). Otherwise FALSE.
	52 Operation enabled	TRUE if inverter and start are enabled. Otherwise FALSE.
53 Stop active	TRUE if inverter is enabled and motor is not started and output frequency = 0.	
54 Quick stop active	TRUE if quick stop is active. Otherwise FALSE.	
55 Safe torque off (STO) active	TRUE if the integrated safety system has triggered the "Safe torque off (STO)" function. Otherwise FALSE.	
56 Error active	TRUE if error is active. Otherwise FALSE.	



Flexible I/O configuration

Configuration of digital outputs

Relay

Parameter	Name / value range / [default setting]	Info
	57 Error (non-resettable) active	TRUE if non-resettable error is active. Otherwise FALSE.
	58 Device warning active	TRUE if warning is active. Otherwise FALSE. <ul style="list-style-type: none"> • A warning has no impact on the operating status of the inverter. • A warning is reset automatically if the cause has been eliminated.
	59 Device fault active	TRUE if a fault is active. Otherwise FALSE. <ul style="list-style-type: none"> • In the event of a fault, the motor is brought to a standstill with the quick stop ramp. The inverter is then disabled. • Exception: In case of a serious fault, the inverter is disabled immediately. The motor becomes torqueless (coasts). • The error state will be left automatically if the error condition is not active anymore. • The restart behaviour after trouble can be configured. ▶ Automatic restart □ 280
	60 Heatsink temperature warning active	TRUE if current heatsink temperature > warning threshold for temperature monitoring. Otherwise FALSE. <ul style="list-style-type: none"> • Display of the current heatsink temperature in 0x2D84:001 (P117.01). • Setting of the warning threshold in 0x2D84:002.
	65 Motor PTC error active	- (reserved)
	66 Flying restart circuit active	TRUE if flying restart circuit active is active. Otherwise FALSE. <ul style="list-style-type: none"> ▶ Flying restart circuit □ 277
	67 DC braking active	TRUE if DC braking is active. Otherwise FALSE. <ul style="list-style-type: none"> ▶ DC braking □ 223
	69 Rotational direction reversed	TRUE if output frequency is negative. Otherwise FALSE.
	70 Frequency threshold exceeded	TRUE if current output frequency > frequency threshold. Otherwise FALSE. <ul style="list-style-type: none"> • Display of the current output frequency in 0x2DDD (P100.00). • Setting Frequency threshold in 0x4005 (P412.00). ▶ Frequency threshold for "Frequency threshold exceeded" trigger □ 346
	71 Actual speed = 0	TRUE if current output frequency = 0 Hz (± 0.01 Hz), irrespective of the operating mode. Otherwise FALSE. <ul style="list-style-type: none"> • Display of the current output frequency in 0x2DDD (P100.00).
	72 Setpoint speed reached	TRUE if frequency setpoint reached. Otherwise FALSE.
	73 PID feedback = setpoint	TRUE if the controlled variable fed back = process controller setpoint. Otherwise FALSE. <ul style="list-style-type: none"> ▶ Basic process controller settings □ 207
	74 PID idle state active	TRUE if the inverter is in "PID idle state". Otherwise FALSE. <ul style="list-style-type: none"> ▶ Process controller idle state □ 213
	75 PID MIN alarm active	TRUE if fed back variable (with activated PID control) < MIN alarm threshold. Otherwise FALSE. <ul style="list-style-type: none"> • Setting of MIN alarm threshold in 0x404D:001 (P608.01). ▶ Basic process controller settings □ 207
	76 PID MAX alarm active	TRUE if the fed back variable (with activated PID control) > MAX alarm threshold. Otherwise FALSE. <ul style="list-style-type: none"> • Setting of MAX alarm threshold in 0x404D:002 (P608.02). ▶ Basic process controller settings □ 207
	77 PID MIN-MAX alarm active	TRUE if no PID alarm is active with activated PID control (MIN alarm threshold < fed back variable < MAX alarm threshold). Otherwise FALSE. <ul style="list-style-type: none"> • Setting of MIN alarm threshold in 0x404D:001 (P608.01). • Setting of MAX alarm threshold in 0x404D:002 (P608.02). ▶ Basic process controller settings □ 207
	78 Current limit reached	TRUE if current motor current ≥ maximum current. Otherwise FALSE. <ul style="list-style-type: none"> • Display of the present motor current in 0x2D88 (P104.00). • Setting for the maximum current in 0x6073 (P324.00).
	79 Torque limit reached	TRUE if torque limit has been reached or exceeded. Otherwise FALSE. <ul style="list-style-type: none"> • Setting "Positive torque limit" in 0x60E0. • Setting "Negative torque limit" in 0x60E1.
	80 Follower signal (4 ... 20 mA) lost	Reserve (do not use trigger)

Flexible I/O configuration

Configuration of digital outputs

Relay



Parameter	Name / value range / [default setting]	Info
	81 Error of analog input 1 active	TRUE if the monitoring of the input signal at the analog input 1 has responded. Otherwise FALSE. This trigger is set as a function of the following settings: <ul style="list-style-type: none"> Monitoring threshold 0x2636:008 (P430.08) Monitoring condition 0x2636:009 (P430.09) The setting of the Error response in 0x2636:010 (P430.10) has no effect on this trigger. ▶ Analog input 1 □ 348
	82 Error of analog input 2 active	TRUE if the monitoring of the input signal at the analog input 2 has responded. Otherwise FALSE. This trigger is set as a function of the following settings: <ul style="list-style-type: none"> Monitoring threshold 0x2637:008 (P431.08) Monitoring condition 0x2637:009 (P431.09) The setting of the Error response in 0x2637:010 (P431.10) has no effect on this trigger. ▶ Analog input 2 □ 352
	83 Load loss detected	TRUE if actual motor current < threshold for load loss detection after delay time of the load loss detection has elapsed. Otherwise FALSE. <ul style="list-style-type: none"> Display of the present motor current in 0x6078 (P103.00). Setting Threshold in 0x4006:001 (P710.01). Setting Deceleration in 0x4006:002 (P710.02). ▶ Load loss detection □ 231
	104 Local control active	TRUE if local keypad control ("LOC") active. Otherwise FALSE.
	105 Remote control active	TRUE if remote control ("REM") via terminals, network, etc. active. Otherwise FALSE.
	106 Manual setpoint selection active	TRUE if manual setpoint selection ("MAN") via keypad active. Otherwise FALSE. <ul style="list-style-type: none"> Selection of the trigger for the "Activate keypad setpoint" function in 0x2631:016 (P400.16).
	107 Automatic setpoint selection active	TRUE if automatic setpoint selection ("AUTO") via terminals, network, etc. active. Otherwise FALSE.
	108 Parameter set 1 active	TRUE if parameter set 1 is loaded and active. Otherwise FALSE.
	109 Parameter set 2 active	TRUE if parameter set 2 is loaded and active. Otherwise FALSE.
	110 Parameter set 3 active	TRUE if parameter set 3 is loaded and active. Otherwise FALSE.
	111 Parameter set 4 active	TRUE if parameter set 4 is loaded and active. Otherwise FALSE.
	112 Parameter set load OK	TRUE after any parameter set has been loaded. Otherwise FALSE.
	113 Parameter set load fail	TRUE if any of the parameter sets could not be loaded. Otherwise FALSE.
	114 Network control active	Reserve (do not use trigger)
	115 Release holding brake	Trigger signal for releasing the holding brake (TRUE = release holding brake). ▶ Holding brake control □ 265
0x2635:001 (P421.01)	Inversion of digital outputs: Relay (DO inversion: Relay inverted)	Relay inversion
	0 Not inverted	
	1 Inverted	
0x4018:003	Relay: Switch-off delay 0.000 ... [0.020] ... 65.535 s	Switch-off delay for the relay.
0x4018:004	Relay: Switch-on delay 0.000 ... [0.020] ... 65.535 s	Switch-on delay for the relay.
0x4018:005	Relay: Relay state • Read only	Display of the logic state of the relay.
	0 FALSE	
	1 TRUE	
0x4018:006	Relay: Trigger signal state • Read only	Display of the logic state of the trigger signal for the relay (without taking a ON/OFF delay set and inversion into consideration).
	0 FALSE	
	1 TRUE	
0x4018:007	Relay: Switching cycles • Read only	Display of the previous relay switching cycles.



11.14.2 Digital output 1

Settings for digital output 1.

Parameter	Name / value range / [default setting]	Info
0x2634:002 (P420.02)	Digital outputs function: Digital output 1 (Dig.out.function: DO1 function) <ul style="list-style-type: none"> For possible settings see description for 0x2634:001 (P420.01). 354 	Assignment of a trigger to digital output 1. Trigger = FALSE: X3/DO1 set to LOW level. Trigger = TRUE: X3/DO1 set to HIGH level. Notes: <ul style="list-style-type: none"> An inversion set in 0x2635:002 (P421.02) is taken into consideration here.
	115 Release holding brake	Trigger signal for releasing the holding brake (TRUE = release holding brake). ▶ Holding brake control 3265
0x2635:002 (P421.02)	Inversion of digital outputs: Digital output 1 (DO inversion: DO1 inversion)	Inversion of digital output 1
	0 Not inverted	
	1 Inverted	
0x4016:003	Digital output 1: Cutout delay 0.000 ... [0.020] ... 65.535 s	Switch-off delay for digital output 1.
0x4016:004	Digital output 1: Switch-on delay 0.000 ... [0.020] ... 65.535 s	Switch-on delay for digital output 1.
0x4016:005	Digital output 1: Terminal state <ul style="list-style-type: none"> Read only 	Display of the logic state of output terminal X3/DO1.
	0 FALSE	
	1 TRUE	
0x4016:006	Digital output 1: Trigger signal state <ul style="list-style-type: none"> Read only 	Display of the logic state of the trigger signal for digital output 1 (without taking a ON/OFF delay set and inversion into consideration).
	0 FALSE	
	1 TRUE	

Flexible I/O configuration

Configuration of digital outputs
NetWordOUT1 status word



11.14.3 NetWordOUT1 status word

Assignment of digital triggers to bit 0 ... bit 15 of the NetWordOUT1 status word.

Details

The following table shows the preset status assignment of the NetWordOUT1 data word:

Bit	Default setting	For details and configuration, see
0	Ready for operation	0x2634:010 (P420.10)
1	Not connected	0x2634:011 (P420.11)
2	Operation enabled	0x2634:012 (P420.12)
3	Error active	0x2634:013 (P420.13)
4	Not connected	0x2634:014 (P420.14)
5	Quick stop active	0x2634:015 (P420.15)
6	Running	0x2634:016 (P420.16)
7	Device warning active	0x2634:017 (P420.17)
8	Not connected	0x2634:018 (P420.18)
9	Not connected	0x2634:019 (P420.19)
10	Setpoint speed reached	0x2634:020 (P420.20)
11	Current limit reached	0x2634:021 (P420.21)
12	Actual speed = 0	0x2634:022 (P420.22)
13	Rotational direction reversed	0x2634:023 (P420.23)
14	Release holding brake	0x2634:024 (P420.24)
15	Safe torque off (STO) active	0x2634:025 (P420.25)

The following parameters can be used to change the status assignment of the NetWordOUT1 data word.

Parameter	Name / value range / [default setting]	Info
0x2634:010 (P420.10)	Digital outputs function: NetWordOUT1 - bit 0 (Dig.out.function: NetWordOUT1.00) • For possible settings see description for 0x2634:001 (P420.01) . 354	Assignment of a trigger to bit 0 of NetWordOUT1. Trigger = FALSE: bit set to 0. Trigger = TRUE: bit set to 1.
	51 Ready for operation	TRUE if inverter is ready for operation (no error active, no STO active and DC-bus voltage ok). Otherwise FALSE.
0x2634:011 (P420.11)	Digital outputs function: NetWordOUT1 - bit 1 (Dig.out.function: NetWordOUT1.01) • For possible settings see description for 0x2634:001 (P420.01) . 354	Assignment of a trigger to bit 1 of NetWordOUT1. Trigger = FALSE: bit set to 0. Trigger = TRUE: bit set to 1.
	00 Not connected	No trigger assigned (trigger is constantly FALSE).
0x2634:012 (P420.12)	Digital outputs function: NetWordOUT1 - bit 2 (Dig.out.function: NetWordOUT1.02) • For possible settings see description for 0x2634:001 (P420.01) . 354	Assignment of a trigger to bit 2 of NetWordOUT1. Trigger = FALSE: bit set to 0. Trigger = TRUE: bit set to 1.
	52 Operation enabled	TRUE if inverter and start are enabled. Otherwise FALSE.
0x2634:013 (P420.13)	Digital outputs function: NetWordOUT1 - bit 3 (Dig.out.function: NetWordOUT1.03) • For possible settings see description for 0x2634:001 (P420.01) . 354	Assignment of a trigger to bit 3 of NetWordOUT1. Trigger = FALSE: bit set to 0. Trigger = TRUE: bit set to 1.
	56 Error active	TRUE if error is active. Otherwise FALSE.
0x2634:014 (P420.14)	Digital outputs function: NetWordOUT1 - bit 4 (Dig.out.function: NetWordOUT1.04) • For possible settings see description for 0x2634:001 (P420.01) . 354	Assignment of a trigger to bit 4 of NetWordOUT1. Trigger = FALSE: bit set to 0. Trigger = TRUE: bit set to 1.
	00 Not connected	No trigger assigned (trigger is constantly FALSE).
0x2634:015 (P420.15)	Digital outputs function: NetWordOUT1 - bit 5 (Dig.out.function: NetWordOUT1.05) • For possible settings see description for 0x2634:001 (P420.01) . 354	Assignment of a trigger to bit 5 of NetWordOUT1. Trigger = FALSE: bit set to 0. Trigger = TRUE: bit set to 1.
	54 Quick stop active	TRUE if quick stop is active. Otherwise FALSE.



Flexible I/O configuration

Configuration of digital outputs
NetWordOUT1 status word

Parameter	Name / value range / [default setting]	Info
0x2634:016 (P420.16)	Digital outputs function: NetWordOUT1 - bit 6 (Dig.out.function: NetWordOUT1.06) • For possible settings see description for 0x2634:001 (P420.01) . □ 354	Assignment of a trigger to bit 6 of NetWordOUT1. Trigger = FALSE: bit set to 0. Trigger = TRUE: bit set to 1.
	50 Running	TRUE if inverter and start are enabled and output frequency > 0.2 Hz. Otherwise FALSE.
0x2634:017 (P420.17)	Digital outputs function: NetWordOUT1 - bit 7 (Dig.out.function: NetWordOUT1.07) • For possible settings see description for 0x2634:001 (P420.01) . □ 354	Assignment of a trigger to bit 7 of NetWordOUT1. Trigger = FALSE: bit set to 0. Trigger = TRUE: bit set to 1.
	58 Device warning active	TRUE if warning is active. Otherwise FALSE. • A warning has no impact on the operating status of the inverter. • A warning is reset automatically if the cause has been eliminated.
0x2634:018 (P420.18)	Digital outputs function: NetWordOUT1 - bit 8 (Dig.out.function: NetWordOUT1.08) • For possible settings see description for 0x2634:001 (P420.01) . □ 354	Assignment of a trigger to bit 8 of NetWordOUT1. Trigger = FALSE: bit set to 0. Trigger = TRUE: bit set to 1.
	00 Not connected	No trigger assigned (trigger is constantly FALSE).
0x2634:019 (P420.19)	Digital outputs function: NetWordOUT1 - bit 9 (Dig.out.function: NetWordOUT1.09) • For possible settings see description for 0x2634:001 (P420.01) . □ 354	Assignment of a trigger to bit 9 of NetWordOUT1. Trigger = FALSE: bit set to 0. Trigger = TRUE: bit set to 1.
	00 Not connected	No trigger assigned (trigger is constantly FALSE).
0x2634:020 (P420.20)	Digital outputs function: NetWordOUT1 - bit 10 (Dig.out.function: NetWordOUT1.10) • For possible settings see description for 0x2634:001 (P420.01) . □ 354	Assignment of a trigger to bit 10 of NetWordOUT1. Trigger = FALSE: bit set to 0. Trigger = TRUE: bit set to 1.
	72 Setpoint speed reached	TRUE if frequency setpoint reached. Otherwise FALSE.
0x2634:021 (P420.21)	Digital outputs function: NetWordOUT1 - bit 11 (Dig.out.function: NetWordOUT1.11) • For possible settings see description for 0x2634:001 (P420.01) . □ 354	Assignment of a trigger to bit 11 of NetWordOUT1. Trigger = FALSE: bit set to 0. Trigger = TRUE: bit set to 1.
	78 Current limit reached	TRUE if current motor current \geq maximum current. Otherwise FALSE. • Display of the present motor current in 0x2D88 (P104.00) . • Setting for the maximum current in 0x6073 (P324.00) .
0x2634:022 (P420.22)	Digital outputs function: NetWordOUT1 - bit 12 (Dig.out.function: NetWordOUT1.12) • For possible settings see description for 0x2634:001 (P420.01) . □ 354	Assignment of a trigger to bit 12 of NetWordOUT1. Trigger = FALSE: bit set to 0. Trigger = TRUE: bit set to 1.
	71 Actual speed = 0	TRUE if current output frequency = 0 Hz (\pm 0.01 Hz), irrespective of the operating mode. Otherwise FALSE. • Display of the current output frequency in 0x2DDD (P100.00) .
0x2634:023 (P420.23)	Digital outputs function: NetWordOUT1 - bit 13 (Dig.out.function: NetWordOUT1.13) • For possible settings see description for 0x2634:001 (P420.01) . □ 354	Assignment of a trigger to bit 13 of NetWordOUT1. Trigger = FALSE: bit set to 0. Trigger = TRUE: bit set to 1.
	69 Rotational direction reversed	TRUE if output frequency is negative. Otherwise FALSE.
0x2634:024 (P420.24)	Digital outputs function: NetWordOUT1 - bit 14 (Dig.out.function: NetWordOUT1.14) • For possible settings see description for 0x2634:001 (P420.01) . □ 354	Assignment of a trigger to bit 14 of NetWordOUT1. Trigger = FALSE: bit set to 0. Trigger = TRUE: bit set to 1.
	115 Release holding brake	Trigger signal for releasing the holding brake (TRUE = release holding brake). ▶ Holding brake control □ 265
0x2634:025 (P420.25)	Digital outputs function: NetWordOUT1 - bit 15 (Dig.out.function: NetWordOUT1.15) • For possible settings see description for 0x2634:001 (P420.01) . □ 354	Assignment of a trigger to bit 15 of NetWordOUT1. Trigger = FALSE: bit set to 0. Trigger = TRUE: bit set to 1.
	55 Safe torque off (STO) active	TRUE if the integrated safety system has triggered the "Safe torque off (STO)" function. Otherwise FALSE.

Flexible I/O configuration

Configuration of digital outputs
NetWordOUT1 status word



Parameter	Name / value range / [default setting]	Info
0x2635:010	Inversion of digital outputs: NetWordOUT1.00	Inversion of bit 0 of NetWordOUT1.
	0 Not inverted	
	1 Inverted	
0x2635:011	Inversion of digital outputs: NetWordOUT1.01	Inversion of bit 1 of NetWordOUT1.
	0 Not inverted	
	1 Inverted	
0x2635:012	Inversion of digital outputs: NetWordOUT1.02	Inversion of bit 2 of NetWordOUT1.
	0 Not inverted	
	1 Inverted	
0x2635:013	Inversion of digital outputs: NetWordOUT1.03	Inversion of bit 3 of NetWordOUT1.
	0 Not inverted	
	1 Inverted	
0x2635:014	Inversion of digital outputs: NetWordOUT1.04	Inversion of bit 4 of NetWordOUT1.
	0 Not inverted	
	1 Inverted	
0x2635:015	Inversion of digital outputs: NetWordOUT1.05	Inversion of bit 5 of NetWordOUT1.
	0 Not inverted	
	1 Inverted	
0x2635:016	Inversion of digital outputs: NetWordOUT1.06	Inversion of bit 6 of NetWordOUT1.
	0 Not inverted	
	1 Inverted	
0x2635:017	Inversion of digital outputs: NetWordOUT1.07	Inversion of bit 7 of NetWordOUT1.
	0 Not inverted	
	1 Inverted	
0x2635:018	Inversion of digital outputs: NetWordOUT1.08	Inversion of bit 8 of NetWordOUT1.
	0 Not inverted	
	1 Inverted	
0x2635:019	Inversion of digital outputs: NetWordOUT1.09	Inversion of bit 9 of NetWordOUT1.
	0 Not inverted	
	1 Inverted	
0x2635:020	Inversion of digital outputs: NetWordOUT1.10	Inversion of bit 10 of NetWordOUT1.
	0 Not inverted	
	1 Inverted	
0x2635:021	Inversion of digital outputs: NetWordOUT1.11	Inversion of bit 11 of NetWordOUT1.
	0 Not inverted	
	1 Inverted	
0x2635:022	Inversion of digital outputs: NetWordOUT1.12	Inversion of bit 12 of NetWordOUT1.
	0 Not inverted	
	1 Inverted	
0x2635:023	Inversion of digital outputs: NetWordOUT1.13	Inversion of bit 13 of NetWordOUT1.
	0 Not inverted	
	1 Inverted	
0x2635:024	Inversion of digital outputs: NetWordOUT1.14	Inversion of bit 14 of NetWordOUT1.
	0 Not inverted	
	1 Inverted	
0x2635:025	Inversion of digital outputs: NetWordOUT1.15	Inversion of bit 15 of NetWordOUT1.
	0 Not inverted	
	1 Inverted	



11.15 Configuration of analog outputs

11.15.1 Analog output 1

Settings for analog input 1.

Details

The analog output 1 is controlled with the signal selected in [0x2639:002 \(P440.02\)](#).

The following settings are possible for the analog output:

- Definition of the signal range ①
- Definition of the output range ②

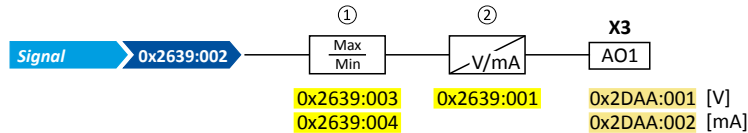

Diagnostic parameters:

- The current output voltage is displayed in [0x2DAA:001 \(P112.01\)](#).
- The actual output current is displayed in [0x2DAA:002 \(P112.02\)](#).

Definition of the signal range

The signal range results from the resolution of the selected signal multiplied by the set min and max signal value. Signals outside the signal range are cut off. For examples, see the following table:

Signal 0x2639:002 (P440.02)	Resolution	Min. signal 0x2639:003 (P440.03)	Max. signal 0x2639:004 (P440.04)	Signal range
output frequency	0.1 Hz	0	1000	0 ... 100.0 Hz
frequency setpoint	0.1 Hz	0	1000	0 ... 100.0 Hz
Analog input 1	0.1 %	0	1000	0 ... 100.0 %
Analog input 2	0.1 %	0	1000	0 ... 100.0 %
Motor current	0.1 A	0	100	0 ... 10.0 A
Output power	0.001 kW	0	250	0 ... 0.250 kW
NetWordIN3	0.1 %	200	500	20.0 ... 50.0 %
NetWordIN4	0.1 %	0	250	0 ... 25.0 %

Detailed configuration examples can be found in the following subchapters.

Definition of the output range

The analog output can be configured as voltage or current source. The output range selected in [0x2639:001 \(P440.01\)](#) then corresponds to the configured signal range.

Configuration examples

Detailed configuration examples can be found in the following subchapters:

- ▶ [Example 1: Output voltage 0 ... 10 V ≡ output frequency 0 ... 100 Hz](#) [363](#)
- ▶ [Example 2: Output voltage 2 ... 10 V ≡ output frequency 30 ... 60 Hz](#) [364](#)

Parameter	Name / value range / [default setting]	Info
0x2639:001 (P440.01)	Analog output 1: Output range (Analog output 1: AO1 outp. range)	Definition of the output range.
	0 Inhibited	
	1 0 ... 10 VDC	
	2 0 ... 5 VDC	
	3 2 ... 10 VDC	
	4 4 ... 20 mA	
	5 0 ... 20 mA	

Flexible I/O configuration

Configuration of analog outputs

Analog output 1



Parameter	Name / value range / [default setting]	Info
0x2639:002 (P440.02)	Analog output 1: Function (Analog output 1: AO1 function)	Selection of the signal to be shown at analog output 1.
	0 Not active	No output signal.
	1 Output frequency	Actual output frequency (resolution: 0.1 Hz).
	2 Frequency setpoint	Actual frequency setpoint (resolution: 0.1 Hz).
	3 Analog input 1	Input signal of analog input 1 (resolution: 0.1 %).
	4 Analog input 2	Input signal of analog input 2 (resolution: 0.1 %).
	5 Motor current	Actual motor current (resolution: 0.1 A).
	6 Output power	Actual output power (resolution: 0.001 kW).
	20 NetWordIN3	Actual value of the NetWordIN3 data word (resolution: 0.1 %). ▶ Further process data 152
21 NetWordIN4	Actual value of the NetWordIN4 data word (resolution: 0.1 %). ▶ Further process data 152	
0x2639:003 (P440.03)	Analog output 1: Min. signal (Analog output 1: AO1 min. signal) -2147483648 ... [0] ... 2147483647	Definition of the signal value that corresponds to the minimum value at analog output 1. Example: configuration of analog output 1 as a 4 ... 20 mA current loop: output current 4 mA \equiv 0x2639:003
0x2639:004 (P440.04)	Analog output 1: Max. signal (Analog output 1: AO1 max. signal) -2147483648 ... [1000] ... 2147483647	Definition of the signal value that corresponds to the maximum value at analog output 1. Example: configuration of analog output 1 as a 4 ... 20 mA current loop: output current 20 mA \equiv 0x2639:004
0x4008:003 (P590.03)	Process input words: NetWordIN3 (NetWordINx: NetWordIN3) 0.0 ... [0.0] ... 100.0 %	Mappable data word for optional control of an analog output via network. Assignment of the analog outputs: • Analog output 1: 0x2639:002 (P440.02) = "NetWordIN3 [20]" • Analog output 2: = "NetWordIN3 [20]"
0x4008:004 (P590.04)	Process input words: NetWordIN4 (NetWordINx: NetWordIN4) 0.0 ... [0.0] ... 100.0 %	Mappable data word for optional control of an analog output via network. Assignment of the analog outputs: • Analog output 1: 0x2639:002 (P440.02) = "NetWordIN4 [21]" • Analog output 2: = "NetWordIN4 [21]"

11.15.1.1 Example 1: Output voltage 0 ... 10 V \equiv output frequency 0 ... 100 Hz

In this configuration, a voltage is provided at the analog output proportionately to the current output frequency of the inverter (1 V \equiv 10 Hz, resolution 0.1 Hz).

Parameter	Name	Setting for this example
0x2639:001 (P440.01)	Analog output 1: Output range	0 ... 10 VDC [1]
0x2639:002 (P440.02)	Analog output 1: Function	Output frequency [1]
0x2639:003 (P440.03)	Analog output 1: Min. signal	0
0x2639:004 (P440.04)	Analog output 1: Max. signal	1000

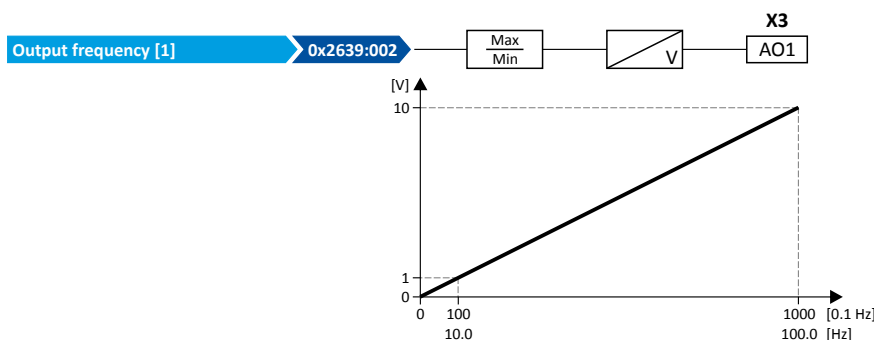



Flexible I/O configuration

Configuration of analog outputs
Analog output 1

11.15.1.2 Example 2: Output voltage 2 ... 10 V \equiv output frequency 30 ... 60 Hz

In this configuration, the output range 2 ... 10 V is used for the output of the output frequency (resolution: 0.1 Hz). The example shows how the signals outside the signal range (here: 30 ... 60 Hz) are cut off.

Parameter	Name	Setting for this example
0x2639:001 (P440.01)	Analog output 1: Output range	2 ... 10 VDC [3]
0x2639:002 (P440.02)	Analog output 1: Function	Output frequency [1]
0x2639:003 (P440.03)	Analog output 1: Min. signal	300
0x2639:004 (P440.04)	Analog output 1: Max. signal	600

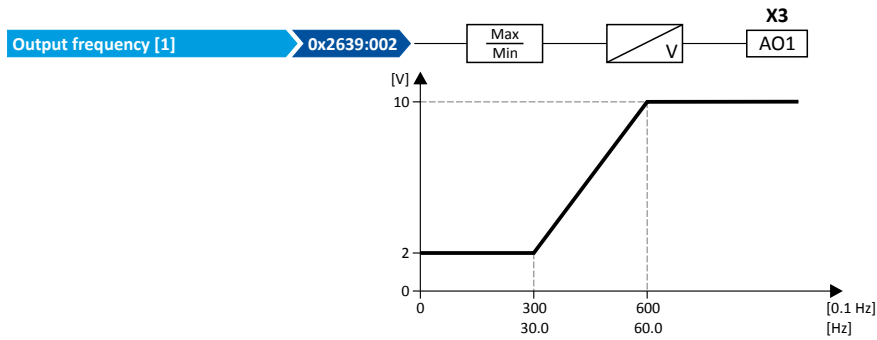

Technical data

Standards and operating conditions
Conformities/approvals



12 Technical data

12.1 Standards and operating conditions

12.1.1 Conformities/approvals

Conformities		
CE	2014/35/EU	Low-Voltage Directive
	2014/30/EU	EMC Directive (reference: CE-typical drive system)
EAC	TR TC 004/2011	Eurasian conformity: safety of low voltage equipment
	TP TC 020/2011	Eurasian conformity: electromagnetic compatibility of technical means
RoHS 2	2011/65/EU	Restrictions for the use of specific hazardous materials in electric and electronic devices
Approvals		
UL	UL 61800-5-1	for USA and Canada (requirements of the CSA 22.2 No. 274)

12.1.2 Protection of persons and device protection

Degree of protection		
IP20	EN 60529	
Type 1	NEMA 250	Protection against contact
Open type		only in UL-approved systems
Insulation resistance		
Overvoltage category III	EN 61800-5-1	0 ... 2000 m a.m.s.l.
Overvoltage category II		above 2000 m a.m.s.l.
Control circuit isolation		
Safe mains isolation by double/reinforced insulation	EN 61800-5-1	
Protective measures against		
Short circuit		Earth fault strength depends on the operating status
Earth fault		
Overvoltage		
Motor stalling		
Motor overtemperature		I ² xt monitoring
Leakage current		
> 3.5 mA AC, > 10 mA DC	EN 61800-5-1	Observe regulations and safety instructions!
Cyclic mains switching		
3 times per minute		Without restrictions
Starting current		
≤ 3 x rated mains current		

12.1.3 EMC data

Operation on public supply systems		
Implement measures to limit the radio interference to be expected:		The machine or plant manufacturer is responsible for compliance with the requirements for the machine/plant!
< 1 kW: with mains choke	EN 61000-3-2	
> 1 kW at mains current ≤ 16 A: without additional measures		
Mains current > 16 A: with mains choke or mains filter, with dimensioning for rated power. R _{sce} ≥ 120 is to be met.	EN 61000-3-12	RSCE: short-circuit power ratio at the connection point of the machine/plant to the public network.
Noise emission		
Category C2	EN 61800-3	Type-dependent, for motor cable lengths see rated data
Noise immunity		
Meets requirement in compliance with	EN 61800-3	



12.1.4 Motor connection

Requirements to the shielded motor cable		
Capacitance per unit length		
C-core-core/C-core-shield < 75/150 pF/m		≤ 2.5 mm ² / AWG 14
C-core-core/C-core-shield < 150/300 pF/m		≥ 4 mm ² / AWG 12
Electric strength		
U _o /U = 0.6/1.0 kV		U = r.m.s. value external conductor/external conductor
		U _o = r.m.s. value external conductor to PE
U ≥ 600 V	UL	U = r.m.s. value external conductor/external conductor

12.1.5 Environmental conditions

Energy efficiency		
Class IE2	EN 50598-2	Reference: Lenze setting (switching frequency 8 kHz variable)
Climate		
1K3 (-25 ... +60 °C)	EN 60721-3-1	Storage
2K3 (-25 ... +70 °C)	EN 60721-3-2	Transport
3K3 (-10 ... +55 °C)	EN 60721-3-3	Operation
		Operation at a switching frequency of 2 or 4 kHz: above +45°C, reduce rated output current by 2.5 %/°C
		Operation at a switching frequency of 8 or 16 kHz: above +40°C, reduce rated output current by 2.5 %/°C
Site altitude		
0 ... 1000 m a.m.s.l.		
1000 ... 4000 m a.m.s.l.		Reduce rated output current by 5 %/1000 m
Pollution		
Degree of pollution 2	EN 61800-5-1	
Vibration resistance		
Transport		
2M2 (sine, shock)	EN 60721-3-2	
Operation		
Amplitude 1 mm	Germanischer Lloyd	5 ... 13.2 Hz
Acceleration resistant up to 0.7 g		13.2 ... 100 Hz
Amplitude 0.075 mm	EN 61800-5-1	10 ... 57 Hz
Acceleration resistant up to 1 g		57 ... 150 Hz

12.1.6 Electrical supply conditions

Permissible mains systems		
TT		Voltage to earth/ground: max. 300 V
TN		
IT		Apply the measures described for IT systems!
		IT systems are not relevant for UL-approved systems

Technical data

1-phase mains connection 230/240 V

Rated data



12.2 1-phase mains connection 230/240 V

12.2.1 Rated data

Inverter		I51AE125B	I51AE137B	I51AE155B	I51AE175B	I51AE211B	I51AE215B	I51AE222B
Rated power	kW	0.25	0.37	0.55	0.75	1.1	1.5	2.2
Mains voltage range		1/N/PE AC 170 V ... 264 V, 45 Hz ... 65 Hz						
Rated mains current								
without mains choke	A	4	5.7	7.6	10	14.3	16.7	22.5
with mains choke	A	3.6	4.8	7.1	8.8	11.9	13.9	16.9
Apparent output power	kVA	0.6	0.9	1.2	1.6	2.2	2.6	3.6
Output current								
2 kHz	A	-	-	3.2	4.2	6	7	9.6
4 kHz	A	1.7	2.4	3.2	4.2	6	7	9.6
8 kHz	A	1.7	2.4	3.2	4.2	6	7	9.6
16 kHz	A	1.1	1.6	2.1	2.8	4	4.7	6.4
Power loss								
4 kHz	W	15	18	23	29	37	43	60
8 kHz	W	15	20	25	33	42	50	70
Overcurrent cycle 180 s								
Max. output current	A	2.55	3.6	4.8	6.3	9	10.5	14.4
Overload time	s	60	60	60	60	60	60	60
Recovery time	s	120	120	120	120	120	120	120
Max. output current during the recovery time	A	1.28	1.8	2.4	3.15	4.5	5.25	7.2
Overcurrent cycle 15 s								
Max. output current	A	3.4	4.8	6.4	8.4	12	14	19.2
Overload time	s	3	3	3	3	3	3	3
Recovery time	s	12	12	12	12	12	12	12
Max. output current during the recovery time	A	1.28	1.8	2.4	3.15	4.5	5.25	7.2
Max. motor cable length								
shielded, without EMC category	m	50						
C2 residential area / industrial premises	m	15			20			
Weight	kg	0.75		0.95		1.35		



12.3 1/3-phase mains connection 230/240 V



I5xAExxD inverters do not have an integrated EMC filter in the AC mains supply.

In order to comply with the EMC requirements according to EN 61800–3, an external EMC filter according to IEC EN 60939 has to be used.

The user must prove that the EN 61800–3 requirements for conformity are fulfilled.

12.3.1 Rated data

Inverter		I51AE125D	I51AE137D	I51AE155D	I51AE175D	I51AE211D	I51AE215D	I51AE222D
Rated power	kW	0.25	0.37	0.55	0.75	1.1	1.5	2.2
Mains voltage range		1/N/PE AC 170 V ... 264 V, 45 Hz ... 65 Hz						
Rated mains current								
without mains choke	A	4	5.7	7.6	10	14.3	16.7	22.5
with mains choke	A	3.6	4.8	7.1	8.8	11.9	13.9	16.9
Mains voltage range		3/PE AC 170 V ... 264 V, 45 Hz ... 65 Hz						
Rated mains current								
without mains choke	A	2.6	3.9	4.8	6.4	7.8	9.5	13.6
with mains choke	A	2	3	3.8	5.1	5.6	6.8	9.8
Apparent output power	kVA	0.6	0.9	1.2	1.6	2.2	2.6	3.6
Output current								
2 kHz	A	-	-	3.2	4.2	6	7	9.6
4 kHz	A	1.7	2.4	3.2	4.2	6	7	9.6
8 kHz	A	1.7	2.4	3.2	4.2	6	7	9.6
16 kHz	A	1.1	1.6	2.1	2.8	4	4.7	6.4
Power loss								
4 kHz	W	15	18	23	29	37	43	60
8 kHz	W	15	20	25	33	42	50	70
Overcurrent cycle 180 s								
Max. output current	A	2.55	3.6	4.8	6.3	9	10.5	14.4
Overload time	s	60	60	60	60	60	60	60
Recovery time	s	120	120	120	120	120	120	120
Max. output current during the recovery time	A	1.28	1.8	2.4	3.15	4.5	5.25	7.2
Overcurrent cycle 15 s								
Max. output current	A	3.4	4.8	6.4	8.4	12	14	19.2
Overload time	s	3	3	3	3	3	3	3
Recovery time	s	12	12	12	12	12	12	12
Max. output current during the recovery time	A	1.28	1.8	2.4	3.15	4.5	5.25	7.2
Max. motor cable length								
shielded, without EMC category	m	50						
Weight	kg	0.75		0.95		1.35		

Technical data

3-phase mains connection 400 V

Rated data



12.4 3-phase mains connection 400 V

12.4.1 Rated data

Inverter		I51AE137F	I51AE155F	I51AE175F	I51AE211F	I51AE215F	I51AE222F
Rated power	kW	0.37	0.55	0.75	1.1	1.5	2.2
Mains voltage range		3/PE AC 340 V ... 528 V, 45 Hz ... 65 Hz					
Rated mains current							
without mains choke	A	1.8	2.5	3.3	4.4	5.4	7.8
with mains choke	A	1.4	2	2.6	3	3.7	5.3
Apparent output power	kVA	0.9	1.2	1.6	2.2	2.6	3.6
Output current							
2 kHz	A	-	1.8	2.4	3.2	3.9	5.6
4 kHz	A	1.3	1.8	2.4	3.2	3.9	5.6
8 kHz	A	1.3	1.8	2.4	3.2	3.9	5.6
16 kHz	A	0.9	1.2	1.6	2.1	2.6	3.7
Power loss							
4 kHz	W	20	25	32	40	48	66
8 kHz	W	24	31	40	51	61	85
Overcurrent cycle 180 s							
Max. output current	A	1.95	2.7	3.6	4.8	5.85	8.4
Overload time	s	60	60	60	60	60	60
Recovery time	s	120	120	120	120	120	120
Max. output current during the recovery time	A	0.975	1.35	1.8	2.4	2.93	4.2
Overcurrent cycle 15 s							
Max. output current	A	2.6	3.6	4.8	6.4	7.8	11.2
Overload time	s	3	3	3	3	3	3
Recovery time	s	12	12	12	12	12	12
Max. output current during the recovery time	A	0.975	1.35	1.8	2.4	2.93	4.2
Max. motor cable length							
shielded, without EMC category	m	15	50				
C2 residential area / industrial premises	m	15			20		
Weight	kg	0.75	0.95		1.35		



12.5 3-phase mains connection 480 V

12.5.1 Rated data

Inverter		I51AE137F	I51AE155F	I51AE175F	I51AE211F	I51AE215F	I51AE222F
Rated power	kW	0.37	0.55	0.75	1.1	1.5	2.2
Mains voltage range		3/PE AC 340 V ... 528 V, 45 Hz ... 65 Hz					
Rated mains current							
without mains choke	A	1.5	2.1	2.8	3.7	4.5	6.5
with mains choke	A	1.2	1.7	2.2	2.5	3.1	4.4
Apparent output power	kVA	0.9	1.2	1.6	2.2	2.6	3.6
Output current							
2 kHz	A	-	1.6	2.1	3	3.5	4.8
4 kHz	A	1.1	1.6	2.1	3	3.5	4.8
8 kHz	A	1.1	1.6	2.1	3	3.5	4.8
16 kHz	A	0.7	1.1	1.4	2	2.3	3.2
Power loss							
4 kHz	W	20	25	32	40	48	66
8 kHz	W	24	31	40	51	61	85
Overcurrent cycle 180 s							
Max. output current	A	1.65	2.4	3.15	4.5	5.25	7.2
Overload time	s	60	60	60	60	60	60
Recovery time	s	120	120	120	120	120	120
Max. output current during the recovery time	A	0.825	1.2	1.58	2.25	2.63	3.6
Overcurrent cycle 15 s							
Max. output current	A	2.2	3.2	4.2	6	7	9.6
Overload time	s	3	3	3	3	3	3
Recovery time	s	12	12	12	12	12	12
Max. output current during the recovery time	A	0.825	1.2	1.58	2.25	2.63	3.6
Max. motor cable length							
shielded, without EMC category	m	15	50				
C2 residential area / industrial premises	m	15			20		
Weight	kg	0.75	0.95		1.35		

Appendix

Operate and parameterise the inverter with keypad



13 Appendix

13.1 Operate and parameterise the inverter with keypad

The keypad is an easy means for the local operation, parameterisation, and diagnostics of the inverter.



- The keypad is simply connected to the diagnostic interface on the front of the inverter.
- The keypad can also be connected and removed during operation.



13.1.1 Keypad operating mode

After switching on the inverter, the keypad plugged in is in "Operating mode" after a short initialisation phase.

13.1.1.1 Keypad status display

In the operating mode, the keypad displays information on the status of the inverter.

Keypad display	Display	Meaning		
<p>If the inverter is inhibited, the keypad shows "STOP":</p>	<p>① Active control mode:</p>	<p>VEL Speed mode</p> <p>PID Process controller mode</p> <p>TRQ Torque mode</p> <p>JOG Manual mode</p>		
<p>If the inverter is enabled, the keypad shows the output frequency of the inverter:</p>	<p>② Active control source:</p>	<p>FLEX Flexible I/O configuration</p> <p>KPD Keypad</p> <p>NET Network</p>		
<ul style="list-style-type: none"> In the process controller mode, instead of the output frequency, the process controller setpoint is displayed. The display can be configured in 0x2864 (P703.00). The language for the keypad display is preset to "English". The language can be changed in 0x2863 (P705.00). 	<p>③ Active setpoint source:</p>	<p>AINx Analog input x</p> <p>KPD Keypad</p> <p>NET Network</p> <p>FREQ Digital frequency</p> <p>PRx Preset setpoint x</p> <p>SEGx Segment x</p> <p>MOP Motor potentiometer</p>		
	<p>④ Current direction of rotation:</p>	<p>FWD Motor is rotating forwards</p> <p>REV Motor is rotating backwards</p>		
	<p>⑤ Lower status line:</p>	<p>LOC Local keypad control active.</p> <p>REM Remote control via terminals, network, etc. active.</p> <p>MAN Manual setpoint selection via keypad active.</p> <p>AUTO Automatic setpoint selection via terminals, network, etc. active.</p> <p>SET Blinking if one parameter setting has been changed but has not been saved in the memory module with mains failure protection. Save settings: Press keypad enter key longer than 3 s.</p>		
	<p>If an error is pending, the keypad shows the following information:</p>	<p>① Error text</p> <p>② Error type:</p>	<p>F Error</p> <p>T Trouble</p> <p>W Warning</p>	
	<ul style="list-style-type: none"> Faults (F) and trouble (T) are displayed continuously. Warnings (W) are only displayed every 2 seconds for a short time. 	<p>③ Error code (hexadecimal)</p>	<p>▶ Error codes □ 378</p> <p>▶ Error handling □ 83</p> <p>▶ Error reset with keypad □ 373</p>	
		<p>Restart Pending</p>	<p>After a disturbance, a restart is possible if the error condition is not active anymore. The keypad shows this by the "Restart Pending" note. The note is displayed in a 1-second interval alternating with the error text.</p> <p>▶ Automatic restart □ 280</p>	

Appendix

Operate and parameterise the inverter with keypad
Keypad operating mode



13.1.1.2 Function of keypad keys in operating mode

In the operating mode, the keypad can be used for local control and for manual setpoint selection.

Function of the keypad keys in operating mode	
	If local keypad control ("LOC" display) active: start motor. If remote control ("REM" display) active: cancel stop ("KSTOP" display) triggered via keypad again. The motor remains stopped ("STOP" display).
	Stop motor (is always possible irrespective of the active control source, exception: JOG operation).
	Briefly pressing the key: Change to parameterisation mode. ▶ Keypad parameterisation mode □ 374 Pressing the key longer than 3 s: Save parameter settings in the user memory of the memory module.
	If manual setpoint selection via keypad ("MAN" display) is active: Change frequency setpoint (see the following example).

Example: Change setpoint

If the setpoints are selected manually via keypad, the frequency setpoint can be changed in the operating mode via the arrow keys (even while the motor is running):

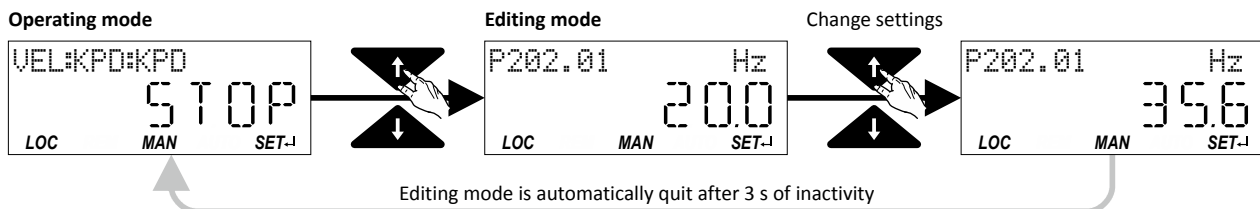

13.1.1.3 Error reset with keypad

Use the keypad key to reset a resettable error if the error condition no longer exists and no blocking time is active.

- The "Error codes" table gives the blocking time (if available) for each error. [□ 378](#)

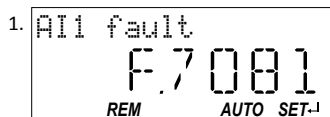

- Press keypad key.

The error is reset. The motor remains stopped via keypad (display "KSTOP").

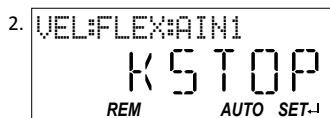

- In order to cancel the stop via keypad again: Press keypad key.

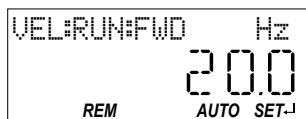



13.1.2 Keypad parameterisation mode

In the parameterisation mode of the keypad you can have actual values of the inverter displayed for purposes of diagnostics and change settings of the inverter.

Use the to change from operating mode to the parameterisation mode.

- If a write access protection is active for the inverter, the keypad automatically displays a log-in when changing to the parameterisation mode. You can either skip the log-in and thus keep the access protection active or remove it temporarily by entering a valid PIN.
 - ▶ [Write access protection](#) 232
- Use the to return to the operating mode.

13.1.2.1 Parameter groups

In order to provide for quick access, all parameters of the inverter are divided into different groups according to their function.

- Group 0 contains the configurable "Favorites". In the default setting these are the most common parameters for the solution of typical applications. ▶ [Favorites](#) 241
- Based on the hundreds digit of the display code (Pxxx) you can quickly see in which group the parameter is to be found on the keypad:

Parameter	Group/name	Description
P1xx	Group 1 - Diagnostics	Diagnostic/display parameters for displaying device-internal process factors, current actual values, and status messages. ▶ Diagnostics parameter 60
P2xx	Group 2 - Basic setting	Setting of the mains voltage, selection of the control and setpoint source, starting and stopping performance, frequency limits and ramp times. ▶ Basic setting 85
P3xx	Group 3 - Motor control	Configuration of the motor and motor control ▶ Motor control 99
P4xx	Group 4 - I/O setting	Function assignment and configuration of the inputs and outputs ▶ Flexible I/O configuration 291
P5xx	Group 5 - Network setting	Configuration of the network (if available) ▶ Configuring the network 136
P6xx	Group 6 - Process controller	Configuration of the process controller ▶ Configuring the process controller 206
P7xx	Group 7 - Additional functions	Parameterisable additional functions ▶ Additional functions 215







Appendix

Operate and parameterise the inverter with keypad
Keypad parameterisation mode



13.1.2.2 Function of the keypad keys in the parameterisation mode

In the parameterisation mode, the arrow keys serve to select and change parameters.

Function of the keypad keys in the parameterisation mode	
	If local keypad control ("LOC" display) active: start motor. If remote control ("REM" display) active: cancel stop ("KSTOP" display) triggered via keypad again. The motor remains stopped ("STOP" display).
	Stop motor (is always possible irrespective of the active control source, exception: JOG operation).
	Briefly pressing the key: Navigate one level lower: Group level → parameter level → [SUB parameter level] → editing mode Briefly pressing the key in editing mode: Exit editing mode and accept new setting. Pressing the key longer than 3 s: Save parameter settings in the user memory of the memory module.
	Navigate one level higher: [SUB parameter level] → parameter level → group level → operating mode In the editing mode: Exit editing mode without accepting the new setting (abort).
	In the group level/parameter level: Navigation (selection of the group/parameter). In the editing mode: Change setting of the parameter.
	



Changing inverter settings by means of the keypad (general operation)

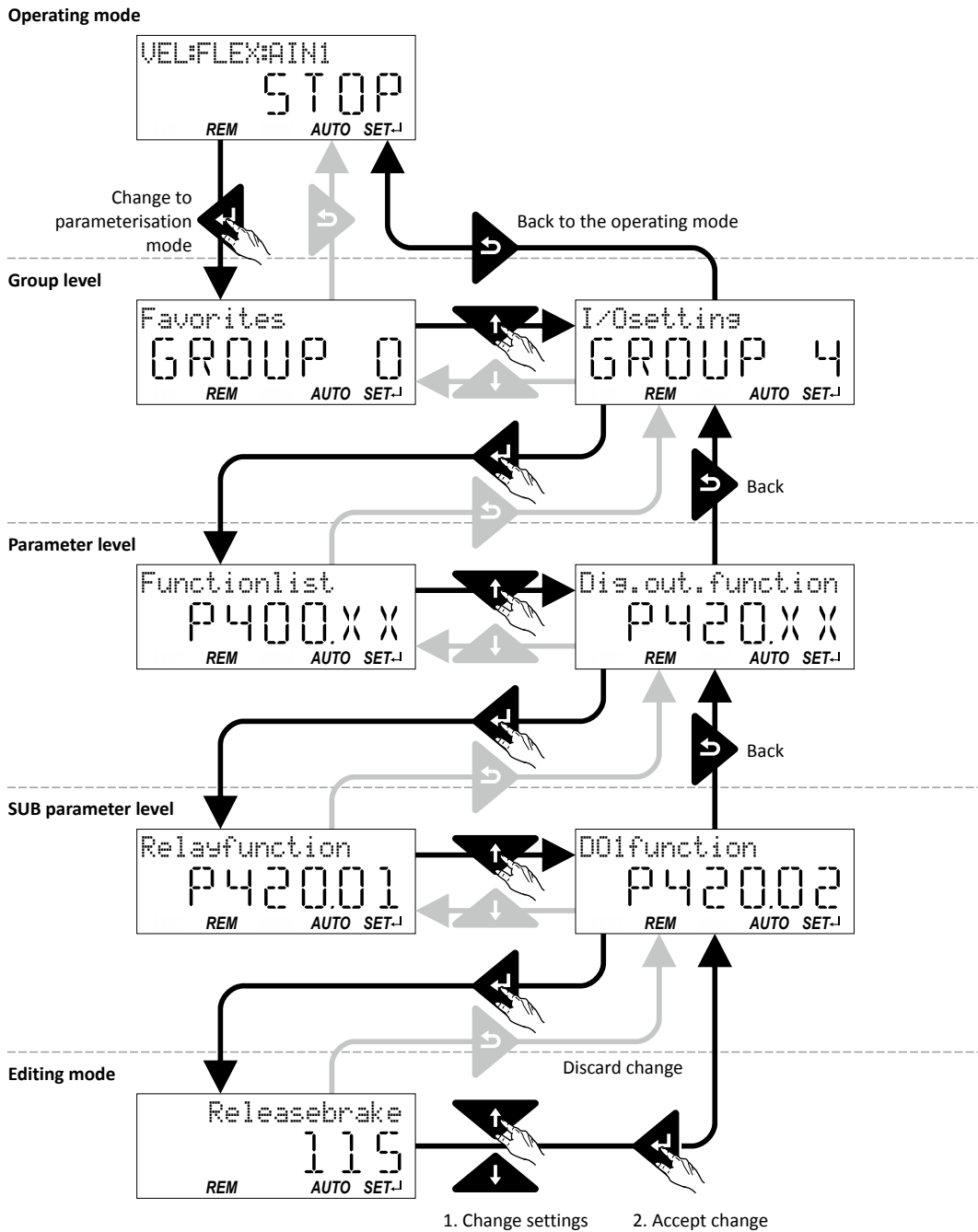

13.1.2.3 Save parameter settings with keypad

If one parameter setting has been changed with the keypad but has not been saved in the memory module with mains failure protection, the SET display is blinking.

In order to save parameter settings in the user memory of the memory module, press the keypad enter key longer than 3 s.



Appendix

Operate and parameterise the inverter with keypad
Keypad parameterisation mode



13.1.2.4 Display of status words on keypad

Some diagnostics parameters contain bit-coded status words. Each single bit has a certain meaning.

Display of 16-bit status words on the keypad

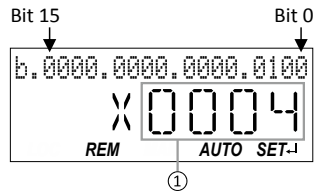

- ① Hexadecimal value

Display of 32-bit status words on the keypad

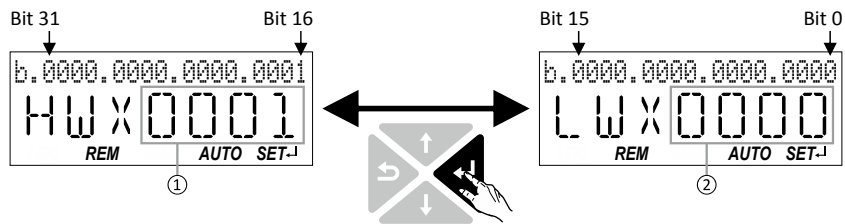

- ① Hexadecimal value High word (HW)
- ② Hexadecimal value Low word (LW)



13.2 Error codes

The following table contains all error codes of the inverter in ascending order.

Error code		Info		Error type	Adjustable in
dec	hex	Keypad display	Error message		
8784	0x2250	PU over current	CiA: Continuous over current (internal)	Error	-
This message contains three errors: 1. Continuous overcurrent on the inverter/motor side. 2. Overcurrent at the brake chopper (brake transistor). 3. DC bus relay has not been closed due to a malfunction. Response: <ul style="list-style-type: none"> • Serious error: The inverter is inhibited immediately. The motor becomes torqueless (coasts). • The error can only be reset after a blocking time of 5 s. 					
8992	0x2320	Earth leak	CiA: Short circuit/earth leakage (internal)	Error	-
Response: <ul style="list-style-type: none"> • Serious error: The inverter is inhibited immediately. The motor becomes torqueless (coasts). • The error can only be reset after a blocking time of 5 s. 					
9024	0x2340	Motor shorted	CiA: Short circuit (device internal)	Error	-
Response: <ul style="list-style-type: none"> • Serious error: The inverter is inhibited immediately. The motor becomes torqueless (coasts). • The error can only be reset after a blocking time of 5 s. 					
9040	0x2350	Motor i2t OL	CiA: i ² *t overload (thermal state)	Error	-
Response: <ul style="list-style-type: none"> • The motor is brought to a standstill with the quick stop ramp. The inverter is then disabled. • The error can only be reset after a blocking time of 5 s. 					
9090	0x2382	Ixt error	I*t error	Fault	0x2D40:005 (P135.05)
The device utilisation has exceeded the warning threshold set in 0x2D40:002 (default setting: 95 %). ▶ Device overload monitoring (i*t) □ 81 Response: <ul style="list-style-type: none"> • Serious error: The inverter is inhibited immediately. The motor becomes torqueless (coasts). • The error can only be reset after a blocking time of 3 s. 					
9091	0x2383	Ixt warning	I*t warning	Warning	-
The device utilisation has exceeded the permanent error threshold of 100 %. ▶ Device overload monitoring (i*t) □ 81 Response: <ul style="list-style-type: none"> • Logging only (Error history buffer/Logbook) 					
9095	0x2387	Clamp timeout	I _{max} : Clamp responded too often	Error	-
"Clamp" = short-time inhibit of the inverter in V/f operation when the current limit shown in 0x2DDF:002 is reached. Response: <ul style="list-style-type: none"> • Serious error: The inverter is inhibited immediately. The motor becomes torqueless (coasts). 					
12576	0x3120	Mains Phase fail	Mains phase fault	Error	-
Response: <ul style="list-style-type: none"> • Serious error: The inverter is inhibited immediately. The motor becomes torqueless (coasts). 					
12816	0x3210	DC Bus OV	DC bus overvoltage	Error	-
The DC-bus voltage of the inverter has exceeded the error threshold for overvoltage. The error threshold results from the setting of the rated mains voltage in 0x2540:001 (P208.01) . ▶ Mains voltage □ 86 Response: <ul style="list-style-type: none"> • Serious error: The inverter is inhibited immediately. The motor becomes torqueless (coasts). 					

Appendix

Error codes



Error code		Info		Error type	Adjustable in
dec	hex	Keypad display	Error message		
12817	0x3211	Warn.DC Bus OV	DC bus overvoltage warning The DC-bus voltage of the inverter has exceeded the warning threshold for overvoltage set in 0x2540:005 (P208.05) . ▶ Mains voltage ☐86 Response: • Logging only (Error history buffer/Logbook)	Warning	-
12832	0x3220	DC Bus UV	DC bus undervoltage The DC-bus voltage of the inverter has fallen below the error threshold for undervoltage. The error threshold results from the setting of the rated mains voltage in 0x2540:001 (P208.01) . ▶ Mains voltage ☐86 Response: • The motor is brought to a standstill with the quick stop ramp. The inverter is then inhibited. • The error can only be reset after a blocking time of 5 s.	Trouble	-
12833	0x3221	Warn.DC Bus UV	DC bus undervoltage warning The DC-bus voltage of the inverter has fallen below the warning threshold for undervoltage set in 0x2540:002 (P208.02) . ▶ Mains voltage ☐86 Response: • Logging only (Error history buffer/Logbook)	Warning	-
12834	0x3222	DC-bus on-UV	DC-bus voltage to low for power up Response: • Logging only (Error history buffer/Logbook)	Warning	-
16912	0x4210	PU Overtemp.	PU: overtemperature fault Response: • The motor is brought to a standstill with the quick stop ramp. The inverter is then disabled.	Error	-
17024	0x4280	Heatsink sensor	Heat sink temperature sensor fault Response: • The motor is brought to a standstill with the quick stop ramp. The inverter is then disabled.	Error	-
17025	0x4281	Heatsink fan	Heat sink fan warning Response: • Logging only (Error history buffer/Logbook)	Warning	-
17029	0x4285	Warn.PU Overtemp	PU overtemperature warning Response: • Logging only (Error history buffer/Logbook)	Warning	-
17168	0x4310	Overtemp. motor	Motor temperature error Response: • The motor is brought to a standstill with the quick stop ramp. The inverter is then disabled. • The error can only be reset after a blocking time of 5 s.	Fault	-
20754	0x5112	24V supply low	24 V supply critical Response: • Logging only (Error history buffer/Logbook)	Warning	-
21376	0x5380	Incomp. OEM HW	OEM hardware incompatible Response: • Serious error: The inverter is inhibited immediately. The motor becomes torqueless (coasts). • The error can only be reset by mains switching.	Error	-
24592	0x6010	Watchdog timeout	Watchdog time-out Response: • Logging only (Error history buffer/Logbook)	Warning	-
24961	0x6181	Timeout-125usTsk	Time-out in 125 us task Response: • Serious error: The inverter is inhibited immediately. The motor becomes torqueless (coasts). • The error can only be reset by mains switching.	Error	-



Error code		Info		Error type	Adjustable in
dec	hex	Keypad display	Error message		
24962	0x6182	Timeout-250usTsk	Time-out in 250 us task	Error	-
		Response: <ul style="list-style-type: none"> • Serious error: The inverter is inhibited immediately. The motor becomes torqueless (coasts). • The error can only be reset by mains switching. 			
24963	0x6183	Timeout-1ms-Task	Time-out in 1 ms task	Error	-
		Response: <ul style="list-style-type: none"> • Serious error: The inverter is inhibited immediately. The motor becomes torqueless (coasts). • The error can only be reset by mains switching. 			
24964	0x6184	Timeout-8ms-Task	Time-out in 8 ms task	Error	-
		Response: <ul style="list-style-type: none"> • Serious error: The inverter is inhibited immediately. The motor becomes torqueless (coasts). • The error can only be reset by mains switching. 			
24968	0x6188	Internal error	Internal error	Error	-
		Response: <ul style="list-style-type: none"> • Serious error: The inverter is inhibited immediately. The motor becomes torqueless (coasts). • The error can only be reset by mains switching. 			
24969	0x6189	PU Prog. error	PU: programming fault	Error	-
		Response: <ul style="list-style-type: none"> • Serious error: The inverter is inhibited immediately. The motor becomes torqueless (coasts). • The error can only be reset by mains switching. 			
24970	0x618A	Internal fan	Internal fan warning	Warning	-
		Response: <ul style="list-style-type: none"> • Logging only (Error history buffer/Logbook) 			
24976	0x6190	PU comm mismatch	PU: communication mismatch	Error	-
		Response: <ul style="list-style-type: none"> • The motor is brought to a standstill with the quick stop ramp. The inverter is then disabled. 			
24977	0x6191	PU Sync. Fault	PU: communication not synchronous	Trouble	-
		Response: <ul style="list-style-type: none"> • Serious fault: The inverter is inhibited immediately. The motor becomes torqueless (coasts). 			
24978	0x6192	Comm.error PU-CU	Communication error PU-CU	Trouble	-
		Response: <ul style="list-style-type: none"> • Serious fault: The inverter is inhibited immediately. The motor becomes torqueless (coasts). 			
24979	0x6193	PU comm error	PU: communication error	Error	-
		If this error occurs, the motor may not be able to be brought to standstill anymore. If communication is lost completely, the power output stage will switch off. Response: <ul style="list-style-type: none"> • Serious error: The inverter is inhibited immediately. The motor becomes torqueless (coasts). 			
24980	0x6194	PU SDO comm err.	SDO communication with PU aborted	Error	-
		Response: <ul style="list-style-type: none"> • Serious error: The inverter is inhibited immediately. The motor becomes torqueless (coasts). 			
24981	0x6195	I2C conn. error	I2C connection lost	Warning	-
		Response: <ul style="list-style-type: none"> • Logging only (Error history buffer/Logbook) 			
24982	0x6196	I2C bus error	I2C bus error	Warning	-
		Response: <ul style="list-style-type: none"> • Logging only (Error history buffer/Logbook) 			

Appendix

Error codes



Error code		Info		Error type	Adjustable in
dec	hex	Keypad display	Error message		
25008	0x61B0	PU uC supply err	PU: uC supply voltage drop down	Error	-
		Response: <ul style="list-style-type: none"> The motor is brought to a standstill with the quick stop ramp. The inverter is then disabled. 			
25009	0x61B1	PU general error	PU: general error	Error	-
		Response: <ul style="list-style-type: none"> Serious error: The inverter is inhibited immediately. The motor becomes torqueless (coasts). 			
25216	0x6280	P400 config err	Trigger/functions connected incorrectly	Error	-
		The assignment directives have not been observed: <ul style="list-style-type: none"> If the "flexible I/O configuration" is active as control source, the "Enable inverter" function or the "Run" function must be connected to a digital input in order that the motor can be stopped again any time! In case of keypad or network control, the two functions "Enable inverter" and "Run" can also be set to "Constant TRUE [1]" to start the motor. The use of the "Start forward (CW)" and "Start reverse (CCW)" functions excludes the use of the "Run forward (CW)" and "Run reverse (CCW)" and vice versa. <p>▶ Start / stop motor □ 298</p> Response: <ul style="list-style-type: none"> The motor is brought to a standstill with the quick stop ramp. The inverter is then disabled. 			
25217	0x6281	User fault 1	User-defined fault 1	Error	-
		The "Activate fault 1" function was triggered via the flexible I/O configuration. ▶ Triggering a user-defined fault □ 336 Response: <ul style="list-style-type: none"> The motor is brought to a standstill with the quick stop ramp. The inverter is then disabled. 			
25218	0x6282	User fault 2	User-defined fault 2	Error	-
		The "Activate fault 2" function was triggered via the flexible I/O configuration. ▶ Triggering a user-defined fault □ 336 Response: <ul style="list-style-type: none"> The motor is brought to a standstill with the quick stop ramp. The inverter is then disabled. 			
25232	0x6290	Invert rotation	Warning invert rotation	Warning	-
		The "Invert rotation" function was requested with an active limitation of rotation. ▶ Motor rotating direction □ 123 Response: <ul style="list-style-type: none"> Logging only (Error history buffer/Logbook) 			
25233	0x6291	Trouble overflow	Maximum allowed troubles exceeded	Error	-
		▶ Automatic restart □ 280 Response: <ul style="list-style-type: none"> The motor is brought to a standstill with the quick stop ramp. The inverter is then disabled. 			
25248	0x62A0	AC Dr. UserFault	AC Drive: user fault	Error	-
		Response: <ul style="list-style-type: none"> The motor is brought to a standstill with the quick stop ramp. The inverter is then disabled. 			
25249	0x62A1	Netw.UserFault 1	Network: user fault 1	Error	-
		The "Activate fault 1" function was triggered via the NetWordIN1 data word. ▶ Further process data □ 152 Response: <ul style="list-style-type: none"> The motor is brought to a standstill with the quick stop ramp. The inverter is then disabled. 			



Error code		Info		Error type	Adjustable in
dec	hex	Keypad display	Error message		
25250	0x62A2	Netw.UserFault 2	Network: user fault 2	Error	-
		<p>The "Activate fault 2" function was triggered via the NetWordIN1 data word.</p> <p>▶ Further process data □ 152</p> <p>Response:</p> <ul style="list-style-type: none"> The motor is brought to a standstill with the quick stop ramp. The inverter is then disabled. 			
25265	0x62B1	NetWordIN1 error	NetWordIN1 configuration incorrect	Error	-
		<p>Response:</p> <ul style="list-style-type: none"> The motor is brought to a standstill with the quick stop ramp. The inverter is then disabled. 			
25504	0x63A0	EEPROM fault	On-board EEPROM: access error	Error	-
		<p>Response:</p> <ul style="list-style-type: none"> Serious error: The inverter is inhibited immediately. The motor becomes torqueless (coasts). The error can only be reset by mains switching. 			
25505	0x63A1	CU ID tag error	CU: load error ID tag	Error	-
		<p>Response:</p> <ul style="list-style-type: none"> Serious error: The inverter is inhibited immediately. The motor becomes torqueless (coasts). The error can only be reset by mains switching. 			
25506	0x63A2	PU ID tag error	PU: load error ID tag	Error	-
		<p>Response:</p> <ul style="list-style-type: none"> Serious error: The inverter is inhibited immediately. The motor becomes torqueless (coasts). The error can only be reset by mains switching. 			
25507	0x63A3	PU unknown	Power unit unknown	Error	-
		<p>Response:</p> <ul style="list-style-type: none"> Serious error: The inverter is inhibited immediately. The motor becomes torqueless (coasts). The error can only be reset by mains switching. 			
25508	0x63A4	EEPROM overflow	On-board EEPROM: timer overflow	Warning	-
		<p>Response:</p> <ul style="list-style-type: none"> Logging only (Error history buffer/Logbook) 			
28800	0x7080	Assertionlevel	Assertion level monitoring (Low/High)	Error	-
		<p>The last setting of the connection level differs from the saved setting.</p> <p>Remedy:</p> <ol style="list-style-type: none"> Check setting in . Save parameter settings: 0x2022:003 (P700.03) = "On / start [1]". Switch inverter off and on again. <p>Response:</p> <ul style="list-style-type: none"> The motor is brought to a standstill with the quick stop ramp. The inverter is then disabled. 			
28801	0x7081	AI1 fault	Analog input 1 fault	Fault	0x2636:010 (P430.10)
		<p>Response:</p> <ul style="list-style-type: none"> The motor is brought to a standstill with the quick stop ramp. The inverter is then disabled. 			
28802	0x7082	AI2 fault	Analog input 2 fault	Fault	0x2637:010 (P431.10)
		<p>Response:</p> <ul style="list-style-type: none"> The motor is brought to a standstill with the quick stop ramp. The inverter is then disabled. 			
28833	0x70A1	AO1 fault	Analog output 1 fault	Warning	-
		<p>Response:</p> <ul style="list-style-type: none"> Logging only (Error history buffer/Logbook) 			
28834	0x70A2	AO2 fault	Analog output 2 fault	Warning	-
		<p>Response:</p> <ul style="list-style-type: none"> Logging only (Error history buffer/Logbook) 			

Appendix

Error codes



Error code		Info		Error type	Adjustable in
dec	hex	Keypad display	Error message		
28961	0x7121	Pole pos. error	Pole position identification fault	Error	-
		Response: • Serious error: The inverter is inhibited immediately. The motor becomes torqueless (coasts).			
29056	0x7180	Mot max current	Motor overcurrent	Fault	0x2D46:002 (P353.02)
		Response: • The motor is brought to a standstill with the quick stop ramp. The inverter is then disabled. • The error can only be reset after a blocking time of 1 s.			
30336	0x7680	EPM full	Memory module is full	Warning	-
		The memory module contains too many parameter settings. The inverter copies the current backup to the user memory without overwriting the data in the RAM. Remedy: Save parameter settings 0x2022:003 (P700.03) = "On / start [1]". The user memory is deleted and then created again with the current parameter settings. Response: • Logging only (Error history buffer/Logbook)			
30337	0x7681	EPM not present	Memory module not present	Error	-
		The default setting saved in the inverter firmware is loaded. The error cannot be reset by the user. Remedy: 1. Switch off inverter. 2. Plug the memory module into the inverter. 3. Switch the inverter on again. Response: • The motor is brought to a standstill with the quick stop ramp. The inverter is then disabled.			
30338	0x7682	EPM invalid data	Memory module invalid user data	Error	-
		The user parameter settings are invalid both in the user memory and in the backup. Thus, the user parameter settings are lost. The default setting is loaded automatically. Remedy: 1. Execute user parameter settings again. 2. Save parameter settings: 0x2022:003 (P700.03) = "On / start [1]". Response: • Serious error: The inverter is inhibited immediately. The motor becomes torqueless (coasts).			
30340	0x7684	Save incomplete	Data not compl. saved before powerdown	Warning	-
		Saving the parameter settings was interrupted by an unexpected disconnection. The user parameter settings were not saved completely. When the inverter is switched on the next time, the backup data is copied to the user memory. Remedy: 1. Check user parameter settings. (The loaded backup is an older version.) 2. If required, repeat the changes made last. 3. Save parameter settings: 0x2022:003 (P700.03) = "On / start [1]". Response: • Logging only (Error history buffer/Logbook)			
30342	0x7686	Net.config.error	Network: configuration error	Error	-
		Response: • Serious error: The inverter is inhibited immediately. The motor becomes torqueless (coasts).			
30343	0x7687	EPM timer overfl	Memory module: timer overflow	Warning	-
		Response: • Logging only (Error history buffer/Logbook)			



Error code		Info		Error type	Adjustable in
dec	hex	Keypad display	Error message		
30345	0x7689	OEM data invalid	Memory module: invalid OEM data	Warning	-
		<p>The OEM memory contains invalid parameter settings or is empty. The user parameter settings are loaded automatically.</p> <p>Remedy:</p> <ul style="list-style-type: none"> Save OEM parameter settings: 0x2022:007 (P700.07) = "On / start [1]". Thus, the user parameter settings get lost! <p>Response:</p> <ul style="list-style-type: none"> Logging only (Error history buffer/Logbook) 			
30346	0x768A	Wrong EPM	Memory module: wrong type	Error	-
		<p>Response:</p> <ul style="list-style-type: none"> The motor is brought to a standstill with the quick stop ramp. The inverter is then disabled. 			
30352	0x7690	OEM CU not match	EPM data: firmware version incompatible	Error	-
		<p>The parameter settings saved in the memory module do not match the firmware version.</p> <p>Remedy:</p> <ul style="list-style-type: none"> Load default settings: 0x2022:001 (P700.01) = "On / start [1]". <p>Response:</p> <ul style="list-style-type: none"> The motor is brought to a standstill with the quick stop ramp. The inverter is then disabled. 			
30353	0x7691	PUData not match	EPM data: firmware type incompatible	Error	-
		<p>The parameter settings saved in the memory module do not match the firmware type.</p> <p>Remedy:</p> <ul style="list-style-type: none"> Load default settings: 0x2022:001 (P700.01) = "On / start [1]". <p>Response:</p> <ul style="list-style-type: none"> The motor is brought to a standstill with the quick stop ramp. The inverter is then disabled. 			
30354	0x7692	UserCU not match	EPM data: new firmware type detected	Error	-
		<p>The parameter settings saved in the memory module do not match the inverter hardware.</p> <p>Remedy:</p> <ul style="list-style-type: none"> Accept new inverter hardware: 0x2022:027 (P700.27) = "On / start [1]". Optionally load default settings: 0x2022:001 (P700.01) = "On / start [1]". <p>Response:</p> <ul style="list-style-type: none"> The motor is brought to a standstill with the quick stop ramp. The inverter is then disabled. 			
30355	0x7693	EPM PU size inco	EPM data: PU size incompatible	Error	-
		<p>The parameter settings saved in the memory module do not match the power unit.</p> <p>Remedy:</p> <ul style="list-style-type: none"> Accept new inverter hardware: 0x2022:027 (P700.27) = "On / start [1]". Optionally load default settings: 0x2022:001 (P700.01) = "On / start [1]". <p>Response:</p> <ul style="list-style-type: none"> The motor is brought to a standstill with the quick stop ramp. The inverter is then disabled. 			
30356	0x7694	EPM new PU size	EPM data: new PU size detected	Error	-
		<p>Response:</p> <ul style="list-style-type: none"> The motor is brought to a standstill with the quick stop ramp. The inverter is then disabled. 			
30357	0x7695	InvalidChgovrCfg	Invalid parameter changeover configuration	Warning	-
		<p>One or several parameters cannot be used for the "parameter change-over" function. The parameter change-over is deactivated.</p> <p>Remedy:</p> <ul style="list-style-type: none"> Check error message for parameter change-over in 0x4047:001 (P756.01) and correct the list entry displayed in 0x4047:002 (P756.02). <p>Response:</p> <ul style="list-style-type: none"> Logging only (Error history buffer/Logbook) 			
30358	0x7696	Unkn. Par in EPM	EPM data: unknown parameter found	Warning	-
		<p>Response:</p> <ul style="list-style-type: none"> Logging only (Error history buffer/Logbook) 			

Appendix

Error codes



Error code		Info		Error type	Adjustable in
dec	hex	Keypad display	Error message		
33154	0x8182	CAN bus off	CAN: bus off	Trouble	0x2857:010
		Response: • The motor is brought to a standstill with the quick stop ramp. The inverter is then inhibited.			
33155	0x8183	CAN bus warning	CAN: warning	Warning	0x2857:011
		Response: • Logging only (Error history buffer/Logbook) • When the error type is set to "error" or "fault", the motor is brought to a standstill with the quick stop ramp. The inverter is then inhibited.			
33156	0x8184	CAN heartb. C1	CAN: heartbeat time-out consumer 1	Fault	0x2857:005
		Response: • The motor is brought to a standstill with the quick stop ramp. The inverter is then disabled.			
33157	0x8185	CAN heartb. C2	CAN: heartbeat time-out consumer 2	Fault	0x2857:006
		Response: • The motor is brought to a standstill with the quick stop ramp. The inverter is then disabled.			
33158	0x8186	CAN heartb. C3	CAN: heartbeat time-out consumer 3	Fault	0x2857:007
		Response: • The motor is brought to a standstill with the quick stop ramp. The inverter is then disabled.			
33159	0x8187	CAN heartb. C4	CAN: heartbeat time-out consumer 4	Fault	0x2857:008
		Response: • The motor is brought to a standstill with the quick stop ramp. The inverter is then disabled.			
33168	0x8190	Watchdog timeout	Network: watchdog timeout	Fault	-
		Response: • The motor is brought to a standstill with the quick stop ramp. The inverter is then disabled.			
33170	0x8192	Net. Init. error	Network: initialisation error	Fault	-
		Response: • The motor is brought to a standstill with the quick stop ramp. The inverter is then disabled.			
33171	0x8193	Inv. cyclic data	Network: invalid cyclic process data	Trouble	-
		Response: • The motor is brought to a standstill with the quick stop ramp. The inverter is then inhibited.			
33184	0x81A0	Modbus TX error	Modbus transmit message error	Warning	-
		Response: • Logging only (Error history buffer/Logbook)			
33185	0x81A1	Modbus time-out	Modbus: network time-out	Fault	0x2858:001 (P515.01)
		Response: • The motor is brought to a standstill with the quick stop ramp. The inverter is then disabled.			
33186	0x81A2	Modbus request	Modbus: incorrect request by master	Warning	-
		Response: • Logging only (Error history buffer/Logbook)			
33414	0x8286	PDO map error	Network: PDO mapping error	Fault	-
		Response: • The motor is brought to a standstill with the quick stop ramp. The inverter is then disabled.			
33425	0x8291	Timeout RPDO1	CAN: RPDO1 time-out	Fault	0x2857:001
		Response: • The motor is brought to a standstill with the quick stop ramp. The inverter is then disabled.			
33426	0x8292	Timeout RPDO2	CAN: RPDO2 time-out	Fault	0x2857:002
		Response: • The motor is brought to a standstill with the quick stop ramp. The inverter is then disabled.			



Error code		Info		Error type	Adjustable in
dec	hex	Keypad display	Error message		
33427	0x8293	Timeout RPDO3	CAN: RPDO3 time-out	Fault	0x2857:003
		Response: • The motor is brought to a standstill with the quick stop ramp. The inverter is then disabled.			
33553	0x8311	Torque limit	Torque limit reached	No reaction	0x2D67:001 (P329.01)
		Response: • When the error type is set to "error" or "fault", the motor is brought to a standstill with the quick stop ramp. The inverter is then inhibited.			
36992	0x9080	Keypad removed	Keypad removed	Error	-
		Response: • The motor is brought to a standstill with the quick stop ramp. The inverter is then disabled.			
65282	0xFF02	BrkResistor OL.F	Brake resistor: overload fault	Fault	-
		Response: • The motor is brought to a standstill with the quick stop ramp. The inverter is then disabled. • The error can only be reset after a blocking time of 5 s.			
65285	0xFF05	STO error	Safe Torque Off error	Error	-
		Response: • Serious error: The inverter is inhibited immediately. The motor becomes torqueless (coasts). • The error can only be reset by mains switching.			
65286	0xFF06	Motor overspeed	Motor overspeed	Fault	0x2D44:002 (P350.02)
		Response: • The motor is brought to a standstill with the quick stop ramp. The inverter is then disabled. • The error can only be reset after a blocking time of 1 s.			
65289	0xFF09	Mot.PhaseFailure	Motor phase failure	No response	0x2D45:001 (P310.01)
		Response: • When the error type is set to "error" or "fault", the motor is brought to a standstill with the quick stop ramp. The inverter is then inhibited. • The error can only be reset after a blocking time of 2 s.			
65290	0xFF0A	Phase U failure	Motor phase failure phase U	No response	0x2D45:001 (P310.01)
		Response: • When the error type is set to "error" or "fault", the motor is brought to a standstill with the quick stop ramp. The inverter is then inhibited. • The error can only be reset after a blocking time of 2 s.			
65291	0xFF0B	Phase V failure	Motor phase failure phase V	No response	0x2D45:001 (P310.01)
		Response: • When the error type is set to "error" or "fault", the motor is brought to a standstill with the quick stop ramp. The inverter is then inhibited. • The error can only be reset after a blocking time of 2 s.			
65292	0xFF0C	Phase W failure	Motor phase failure phase W	No response	0x2D45:001 (P310.01)
		Response: • When the error type is set to "error" or "fault", the motor is brought to a standstill with the quick stop ramp. The inverter is then inhibited. • The error can only be reset after a blocking time of 2 s.			
65305	0xFF19	Motor ID fault	Motor parameter identification fault	Error	-
		Response: • The motor is brought to a standstill with the quick stop ramp. The inverter is then disabled.			
65328	0xFF30	Tmonit. no resp.	Test monitor generated no reaction	Info	-
		Response: • Information only.			
65329	0xFF31	Tmonit. warning	Test monitor generated warning	Warning	-
		Response: • Logging only (Error history buffer/Logbook)			

Appendix

Error codes



Error code		Info		Error type	Adjustable in
dec	hex	Keypad display	Error message		
65330	0xFF32	Tmonit. trouble	Test monitor generated trouble	Trouble	-
		Response: <ul style="list-style-type: none"> The motor is brought to a standstill with the quick stop ramp. The inverter is then inhibited. 			
65331	0xFF33	Tmonit. fault	Test monitor generated fault	Error	-
		Response: <ul style="list-style-type: none"> The motor is brought to a standstill with the quick stop ramp. The inverter is then disabled. 			
65332	0xFF34	Tmon.Fault delay	Test monitor fault with fault reset delayed	Error	-
		Response: <ul style="list-style-type: none"> Serious error: The inverter is inhibited immediately. The motor becomes torqueless (coasts). The error can only be reset after a blocking time of 5 s. 			
65333	0xFF35	Tmon.Fault bloc	Test monitor fault with fault reset blocked	Error	-
		Response: <ul style="list-style-type: none"> The motor is brought to a standstill with the quick stop ramp. The inverter is then disabled. The error can only be reset by mains switching. 			
65334	0xFF36	BrkResistor OL.W	Brake resistor: overload warning	Warning	-
		Response: <ul style="list-style-type: none"> Logging only (Error history buffer/Logbook) 			
65335	0xFF37	Auto start disab	Automatic start disabled	Error	-
		When the mains power was switched on, there was already a start command and the automatic start at power-up is set to "Off [0]" in 0x2838:002 (P203.02) . Remedy: <ul style="list-style-type: none"> Deactivate start command and reset error. Response: <ul style="list-style-type: none"> The motor is brought to a standstill with the quick stop ramp. The inverter is then disabled. 			
65366	0xFF56	Warn. Max. Freq	Max. output frequency reached	Warning	-
		Response: <ul style="list-style-type: none"> Logging only (Error history buffer/Logbook) 			



13.3 Parameter attribute list

The parameter attribute list in particular contains some information required for reading and writing parameters via network.

- The parameter attribute list contains all parameters of the inverter.
- The parameter attribute list is sorted by addresses (index:subindex) in ascending order.

How to read the parameter attribute list:

Column	Meaning
Address	Address of the parameter in the object directory. Format: index:subindex If the parameter can also be accessed via keypad, the "Display Code" is given in addition in brackets.
Name	Parameter name
Default setting	Default setting of the parameter
Category	Functional assignment of the parameter, for example "motor control" or "CANopen".
Data type	Data type of the parameter:
	I8 1 byte, with sign
	I16 2 bytes with sign
	I32 4 bytes with sign
	I64 8 bytes with sign
	U8 1 byte without sign
	U16 2 bytes without sign
	U32 4 bytes without sign
	U64 8 bytes without sign
	REAL32 4 bytes floating point
	STRING[xx] ASCII string (with character length xx)
	OCTET[xx] OCTET string (with xx bytes)
	IDX 4 bytes without sign. Is used specially for addressing parameters.
Factor	Factor for data transmission via network, depending on the number of decimal positions:
	1 No decimal positions
	10 1 decimal position
	100 2 decimal positions
	1000 3 decimal positions
	10000 4 decimal positions
A	Attributes (combinations of several attributes also possible):
	C Setting can only be changed if the inverter is inhibited.
	E Value is displayed as IP address on the keypad.
	H Value is displayed as hexadecimal value on the keypad.
	I Parameter is not displayed.
	K Parameter is only displayed on the keypad.
	O Parameter can be recorded with the oscilloscope function.
	P Setting is saved in the memory module.
	X Parameter is not displayed in the engineering tools.
M	Mapping:
	r Receive mapping permissible.
	t Transmit mapping permissible.
	rt Receive and transmit mapping permissible.
	- Mapping not permissible.

Parameter attribute list (short overview of all parameter indexes)

Address	Name	Default setting	Category	Data type	Factor	A	M
0x1000	Device type	- (Read only)	CANopen	U32	1	H	-
0x1001	Error register	- (Read only)	CANopen	U8	1	H	t
0x1005	COB-ID SYNC	0x00000080	CANopen	U32	1	PH	-
0x1006	Communication cyclic period	0 us	CANopen	U32	1	P	-
0x1008	Manufacturer device name	- (Read only)	CANopen	STRING[50]	1	-	-
0x1009	Manufacturer hardware version	- (Read only)	CANopen	STRING[50]	1	-	-
0x100A	Manufacturer software version	- (Read only)	CANopen	STRING[50]	1	-	-

* Default setting depending on the size.

Firmware version 02.01.01.00

Appendix

Parameter attribute list



Address	Name	Default setting	Category	Data type	Factor	A	M
0x1014	COB-ID EMCY	- (Read only)	CANopen	U32	1	H	-
0x1015	Inhibit time EMCY	0.0 ms	CANopen	U16	10	P	-
0x1016:000 (P520.00)	Consumer heartbeat time: Highest sub-index supported	- (Read only)	CANopen	U8	1	-	-
0x1016:001 (P520.01)	Consumer heartbeat time: Consumer heartbeat time 1	0x00000000	CANopen	U32	1	PH	-
0x1016:002 (P520.02)	Consumer heartbeat time: Consumer heartbeat time 2	0x00000000	CANopen	U32	1	PH	-
0x1016:003 (P520.03)	Consumer heartbeat time: Consumer heartbeat time 3	0x00000000	CANopen	U32	1	PH	-
0x1016:004 (P520.04)	Consumer heartbeat time: Consumer heartbeat time 4	0x00000000	CANopen	U32	1	PH	-
0x1017 (P522.00)	Producer heartbeat time	0 ms	CANopen	U16	1	P	-
0x1018:001	Identity object: Vendor ID	- (Read only)	CANopen	U32	1	-	-
0x1018:002	Identity object: Product code	- (Read only)	CANopen	U32	1	H	-
0x1018:003	Identity object: Revision number	- (Read only)	CANopen	U32	1	-	-
0x1018:004	Identity object: Serial number	- (Read only)	CANopen	U32	1	-	-
0x1029:000	Error behavior: Highest sub-index supported	- (Read only)	CANopen	U8	1	-	-
0x1029:001	Error behavior: Communication error	Status -> Pre-operational [0]	CANopen	U8	1	P	-
0x1200:000	SDO1 server parameter: Highest sub-index supported	- (Read only)	CANopen	U8	1	-	-
0x1200:001	SDO1 server parameter: COB-ID client -> server (rx)	- (Read only)	CANopen	U32	1	H	-
0x1200:002	SDO1 server parameter: COB-ID server -> client (tx)	- (Read only)	CANopen	U32	1	H	-
0x1201:000	SDO2 server parameter: Highest sub-index supported	- (Read only)	CANopen	U8	1	-	-
0x1201:001	SDO2 server parameter: COB-ID client -> server (rx)	0x80000640	CANopen	U32	1	PH	-
0x1201:002	SDO2 server parameter: COB-ID server -> client (tx)	0x800005C0	CANopen	U32	1	PH	-
0x1201:003	SDO2 server parameter: Node-ID of the SDO client	0	CANopen	U8	1	P	-
0x1400:000	RPDO1 communication parameter: Highest sub-index supported	- (Read only)	CANopen	U8	1	-	-
0x1400:001 (P540.01)	RPDO1 communication parameter: COB-ID	0x00000200	CANopen	U32	1	PH	-
0x1400:002 (P540.02)	RPDO1 communication parameter: Transmission type	255	CANopen	U8	1	P	-
0x1400:005 (P540.05)	RPDO1 communication parameter: Event timer	100 ms	CANopen	U16	1	P	-
0x1401:001 (P541.01)	RPDO2 communication parameter: COB-ID	0x80000300	CANopen	U32	1	PH	-
0x1401:002 (P541.02)	RPDO2 communication parameter: Transmission type	255	CANopen	U8	1	P	-
0x1401:005 (P541.05)	RPDO2 communication parameter: Event timer	100 ms	CANopen	U16	1	P	-
0x1402:001 (P542.01)	RPDO3 communication parameter: COB-ID	0x80000400	CANopen	U32	1	PH	-
0x1402:002 (P542.02)	RPDO3 communication parameter: Transmission type	255	CANopen	U8	1	P	-
0x1402:005 (P542.05)	RPDO3 communication parameter: Event timer	100 ms	CANopen	U16	1	P	-
0x1600:000	RPDO1 mapping parameter: Number of mapped application objects in PDO	2	CANopen	U8	1	P	-
0x1600:001	RPDO1 mapping parameter: Application object 1	0x60400010	CANopen	U32	1	PH	-

* Default setting depending on the size.

Firmware version 02.01.01.00



Appendix

Parameter attribute list

Address	Name	Default setting	Category	Data type	Factor	A	M
0x1600:002	RPDO1 mapping parameter: Application object 2	0x60420010	CANopen	U32	1	PH	-
0x1600:003	RPDO1 mapping parameter: Application object 3	0x00000000	CANopen	U32	1	PH	-
0x1600:004	RPDO1 mapping parameter: Application object 4	0x00000000	CANopen	U32	1	PH	-
0x1600:005	RPDO1 mapping parameter: Application object 5	0x00000000	CANopen	U32	1	PH	-
0x1600:006	RPDO1 mapping parameter: Application object 6	0x00000000	CANopen	U32	1	PH	-
0x1600:007	RPDO1 mapping parameter: Application object 7	0x00000000	CANopen	U32	1	PH	-
0x1600:008	RPDO1 mapping parameter: Application object 8	0x00000000	CANopen	U32	1	PH	-
0x1601:000	RPDO2 mapping parameter: Number of mapped application objects in PDO	0	CANopen	U8	1	P	-
0x1601:001	RPDO2 mapping parameter: Application object 1	0x00000000	CANopen	U32	1	PH	-
0x1601:002	RPDO2 mapping parameter: Application object 2	0x00000000	CANopen	U32	1	PH	-
0x1601:003	RPDO2 mapping parameter: Application object 3	0x00000000	CANopen	U32	1	PH	-
0x1601:004	RPDO2 mapping parameter: Application object 4	0x00000000	CANopen	U32	1	PH	-
0x1601:005	RPDO2 mapping parameter: Application object 5	0x00000000	CANopen	U32	1	PH	-
0x1601:006	RPDO2 mapping parameter: Application object 6	0x00000000	CANopen	U32	1	PH	-
0x1601:007	RPDO2 mapping parameter: Application object 7	0x00000000	CANopen	U32	1	PH	-
0x1601:008	RPDO2 mapping parameter: Application object 8	0x00000000	CANopen	U32	1	PH	-
0x1602:000	RPDO3 mapping parameter: Number of mapped application objects in PDO	0	CANopen	U8	1	P	-
0x1602:001	RPDO3 mapping parameter: Application object 1	0x00000000	CANopen	U32	1	PH	-
0x1602:002	RPDO3 mapping parameter: Application object 2	0x00000000	CANopen	U32	1	PH	-
0x1602:003	RPDO3 mapping parameter: Application object 3	0x00000000	CANopen	U32	1	PH	-
0x1602:004	RPDO3 mapping parameter: Application object 4	0x00000000	CANopen	U32	1	PH	-
0x1602:005	RPDO3 mapping parameter: Application object 5	0x00000000	CANopen	U32	1	PH	-
0x1602:006	RPDO3 mapping parameter: Application object 6	0x00000000	CANopen	U32	1	PH	-
0x1602:007	RPDO3 mapping parameter: Application object 7	0x00000000	CANopen	U32	1	PH	-
0x1602:008	RPDO3 mapping parameter: Application object 8	0x00000000	CANopen	U32	1	PH	-
0x1800:000	TPDO1 communication parameter: Highest sub-index supported	-(Read only)	CANopen	U8	1	-	-
0x1800:001 (P550.01)	TPDO1 communication parameter: COB-ID	0x40000180	CANopen	U32	1	PH	-
0x1800:002 (P550.02)	TPDO1 communication parameter: Transmission type	255	CANopen	U8	1	P	-
0x1800:003 (P550.03)	TPDO1 communication parameter: Inhibit time	0.0 ms	CANopen	U16	10	P	-
0x1800:005 (P550.05)	TPDO1 communication parameter: Event timer	20 ms	CANopen	U16	1	P	-
0x1801:000	TPDO2 communication parameter: Highest sub-index supported	-(Read only)	CANopen	U8	1	-	-
0x1801:001 (P551.01)	TPDO2 communication parameter: COB-ID	0xC0000280	CANopen	U32	1	PH	-
0x1801:002 (P551.02)	TPDO2 communication parameter: Transmission type	255	CANopen	U8	1	P	-
0x1801:003 (P551.03)	TPDO2 communication parameter: Inhibit time	0.0 ms	CANopen	U16	10	P	-
0x1801:005 (P551.05)	TPDO2 communication parameter: Event timer	0 ms	CANopen	U16	1	P	-
0x1802:000	TPDO3 communication parameter: Highest sub-index supported	-(Read only)	CANopen	U8	1	-	-
0x1802:001 (P552.01)	TPDO3 communication parameter: COB-ID	0xC0000380	CANopen	U32	1	PH	-
0x1802:002 (P552.02)	TPDO3 communication parameter: Transmission type	255	CANopen	U8	1	P	-
0x1802:003 (P552.03)	TPDO3 communication parameter: Inhibit time	0.0 ms	CANopen	U16	10	P	-
0x1802:005 (P552.05)	TPDO3 communication parameter: Event timer	0 ms	CANopen	U16	1	P	-

* Default setting depending on the size.

Firmware version 02.01.01.00

Appendix

Parameter attribute list



Address	Name	Default setting	Category	Data type	Factor	A	M
0x1A00:000	TPDO1 mapping parameter: Number of mapped application objects in TPDO	2	CANopen	U8	1	P	-
0x1A00:001	TPDO1 mapping parameter: Application object 1	0x60410010	CANopen	U32	1	PH	-
0x1A00:002	TPDO1 mapping parameter: Application object 2	0x60440010	CANopen	U32	1	PH	-
0x1A00:003	TPDO1 mapping parameter: Application object 3	0x00000000	CANopen	U32	1	PH	-
0x1A00:004	TPDO1 mapping parameter: Application object 4	0x00000000	CANopen	U32	1	PH	-
0x1A00:005	TPDO1 mapping parameter: Application object 5	0x00000000	CANopen	U32	1	PH	-
0x1A00:006	TPDO1 mapping parameter: Application object 6	0x00000000	CANopen	U32	1	PH	-
0x1A00:007	TPDO1 mapping parameter: Application object 7	0x00000000	CANopen	U32	1	PH	-
0x1A00:008	TPDO1 mapping parameter: Application object 8	0x00000000	CANopen	U32	1	PH	-
0x1A01:000	TPDO2 mapping parameter: Number of mapped application objects in TPDO	0	CANopen	U8	1	P	-
0x1A01:001	TPDO2 mapping parameter: Application object 1	0x00000000	CANopen	U32	1	PH	-
0x1A01:002	TPDO2 mapping parameter: Application object 2	0x00000000	CANopen	U32	1	PH	-
0x1A01:003	TPDO2 mapping parameter: Application object 3	0x00000000	CANopen	U32	1	PH	-
0x1A01:004	TPDO2 mapping parameter: Application object 4	0x00000000	CANopen	U32	1	PH	-
0x1A01:005	TPDO2 mapping parameter: Application object 5	0x00000000	CANopen	U32	1	PH	-
0x1A01:006	TPDO2 mapping parameter: Application object 6	0x00000000	CANopen	U32	1	PH	-
0x1A01:007	TPDO2 mapping parameter: Application object 7	0x00000000	CANopen	U32	1	PH	-
0x1A01:008	TPDO2 mapping parameter: Application object 8	0x00000000	CANopen	U32	1	PH	-
0x1A02:000	TPDO3 mapping parameter: Number of mapped application objects in TPDO	0	CANopen	U8	1	P	-
0x1A02:001	TPDO3 mapping parameter: Application object 1	0x00000000	CANopen	U32	1	PH	-
0x1A02:002	TPDO3 mapping parameter: Application object 2	0x00000000	CANopen	U32	1	PH	-
0x1A02:003	TPDO3 mapping parameter: Application object 3	0x00000000	CANopen	U32	1	PH	-
0x1A02:004	TPDO3 mapping parameter: Application object 4	0x00000000	CANopen	U32	1	PH	-
0x1A02:005	TPDO3 mapping parameter: Application object 5	0x00000000	CANopen	U32	1	PH	-
0x1A02:006	TPDO3 mapping parameter: Application object 6	0x00000000	CANopen	U32	1	PH	-
0x1A02:007	TPDO3 mapping parameter: Application object 7	0x00000000	CANopen	U32	1	PH	-
0x1A02:008	TPDO3 mapping parameter: Application object 8	0x00000000	CANopen	U32	1	PH	-
0x2000:001 (P190.01)	Product code	- (Read only)	general	STRING[18]	1	-	-
0x2000:002 (P190.02)	Serial number	- (Read only)	general	STRING[50]	1	-	-
0x2000:004 (P190.04)	CU firmware version	- (Read only)	general	STRING[50]	1	-	-
0x2000:005 (P190.05)	CU firmware type	- (Read only)	general	STRING[50]	1	-	-
0x2000:006 (P190.06)	CU bootloader version	- (Read only)	general	STRING[50]	1	-	-
0x2000:007 (P190.07)	CU bootloader type	- (Read only)	general	STRING[50]	1	-	-
0x2000:008 (P190.08)	Object directory version	- (Read only)	general	U32	1	-	-
0x2000:010 (P190.10)	PU firmware version	- (Read only)	general	STRING[50]	1	-	-
0x2000:011 (P190.11)	PU firmware type	- (Read only)	general	STRING[50]	1	-	-
0x2000:012 (P190.12)	PU bootloader version	- (Read only)	general	STRING[50]	1	-	-
0x2000:013 (P190.13)	PU bootloader type	- (Read only)	general	STRING[50]	1	-	-
0x2001 (P191.00)	Device name	My Device	general	STRING[128]	1	PK	-
0x2006:000 (P155.00)	Error history buffer: Keypad display	- (Read only)	general	U8	1	-	-

* Default setting depending on the size.

Firmware version 02.01.01.00



Appendix

Parameter attribute list

Address	Name	Default setting	Category	Data type	Factor	A	M
0x2006:001	Error history buffer: Maximum number of messages	- (Read only)	general	U8	1	-	-
0x2006:002	Error history buffer: Latest message	- (Read only)	general	U8	1	-	-
0x2006:003	Error history buffer: Latest acknowledgement message	1	general	U8	1	-	-
0x2006:004	Error history buffer: New message	- (Read only)	general	U8	1	-	t
0x2006:005	Error history buffer: Buffer overflow	- (Read only)	general	U16	1	-	-
0x2006:006	Error history buffer: Message 0	- (Read only)	general	OCTET[19]	1	-	-
0x2006:007	Error history buffer: Message 1	- (Read only)	general	OCTET[19]	1	-	-
0x2006:008	Error history buffer: Message 2	- (Read only)	general	OCTET[19]	1	-	-
0x2006:009	Error history buffer: Message 3	- (Read only)	general	OCTET[19]	1	-	-
0x2006:010	Error history buffer: Message 4	- (Read only)	general	OCTET[19]	1	-	-
0x2006:011	Error history buffer: Message 5	- (Read only)	general	OCTET[19]	1	-	-
0x2006:012	Error history buffer: Message 6	- (Read only)	general	OCTET[19]	1	-	-
0x2006:013	Error history buffer: Message 7	- (Read only)	general	OCTET[19]	1	-	-
0x2006:014	Error history buffer: Message 8	- (Read only)	general	OCTET[19]	1	-	-
0x2006:015	Error history buffer: Message 9	- (Read only)	general	OCTET[19]	1	-	-
0x2006:016	Error history buffer: Message 10	- (Read only)	general	OCTET[19]	1	-	-
0x2006:017	Error history buffer: Message 11	- (Read only)	general	OCTET[19]	1	-	-
0x2006:018	Error history buffer: Message 12	- (Read only)	general	OCTET[19]	1	-	-
0x2006:019	Error history buffer: Message 13	- (Read only)	general	OCTET[19]	1	-	-
0x2006:020	Error history buffer: Message 14	- (Read only)	general	OCTET[19]	1	-	-
0x2006:021	Error history buffer: Message 15	- (Read only)	general	OCTET[19]	1	-	-
0x2006:022	Error history buffer: Message 16	- (Read only)	general	OCTET[19]	1	-	-
0x2006:023	Error history buffer: Message 17	- (Read only)	general	OCTET[19]	1	-	-
0x2006:024	Error history buffer: Message 18	- (Read only)	general	OCTET[19]	1	-	-
0x2006:025	Error history buffer: Message 19	- (Read only)	general	OCTET[19]	1	-	-
0x2006:026	Error history buffer: Message 20	- (Read only)	general	OCTET[19]	1	-	-
0x2006:027	Error history buffer: Message 21	- (Read only)	general	OCTET[19]	1	-	-
0x2006:028	Error history buffer: Message 22	- (Read only)	general	OCTET[19]	1	-	-
0x2006:029	Error history buffer: Message 23	- (Read only)	general	OCTET[19]	1	-	-
0x2006:030	Error history buffer: Message 24	- (Read only)	general	OCTET[19]	1	-	-
0x2006:031	Error history buffer: Message 25	- (Read only)	general	OCTET[19]	1	-	-
0x2006:032	Error history buffer: Message 26	- (Read only)	general	OCTET[19]	1	-	-
0x2006:033	Error history buffer: Message 27	- (Read only)	general	OCTET[19]	1	-	-
0x2006:034	Error history buffer: Message 28	- (Read only)	general	OCTET[19]	1	-	-
0x2006:035	Error history buffer: Message 29	- (Read only)	general	OCTET[19]	1	-	-
0x2006:036	Error history buffer: Message 30	- (Read only)	general	OCTET[19]	1	-	-
0x2006:037	Error history buffer: Message 31	- (Read only)	general	OCTET[19]	1	-	-
0x2021:001 (P230.01)	Optical tracking: Start detection	Stop [0]	general	U8	1	-	-
0x2021:002 (P230.02)	Optical tracking: Blinking duration	5 s	general	U16	1	-	-
0x2022:001 (P700.01)	Device commands: Load default settings	Off / ready [0]	general	U8	1	C	-
0x2022:003 (P700.03)	Device commands: Save user data	Off / ready [0]	general	U8	1	-	-
0x2022:004 (P700.04)	Device commands: Load user data	Off / ready [0]	general	U8	1	C	-
0x2022:005 (P700.05)	Device commands: Load OEM data	Off / ready [0]	general	U8	1	C	-
0x2022:006 (P700.06)	Device commands: Save OEM data	Off / ready [0]	general	U8	1	-	-
0x2022:007 (P700.07)	Device commands: Load parameter set 1	Off / ready [0]	general	U8	1	-	-

* Default setting depending on the size.

Firmware version 02.01.01.00

Appendix

Parameter attribute list



Address	Name	Default setting	Category	Data type	Factor	A	M
0x2022:008 (P700.08)	Device commands: Load parameter set 2	Off / ready [0]	general	U8	1	-	-
0x2022:009 (P700.09)	Device commands: Load parameter set 3	Off / ready [0]	general	U8	1	-	-
0x2022:010 (P700.10)	Device commands: Load parameter set 4	Off / ready [0]	general	U8	1	-	-
0x2022:011 (P700.11)	Device commands: Save parameter set 1	Off / ready [0]	general	U8	1	-	-
0x2022:012 (P700.12)	Device commands: Save parameter set 2	Off / ready [0]	general	U8	1	-	-
0x2022:013 (P700.13)	Device commands: Save parameter set 3	Off / ready [0]	general	U8	1	-	-
0x2022:014 (P700.14)	Device commands: Save parameter set 4	Off / ready [0]	general	U8	1	-	-
0x2022:015 (P700.15)	Device commands: Delete logbook	Off / ready [0]	general	U8	1	C	-
0x2022:027 (P700.27)	Device commands: Accept new inverter hardware	Off / ready [0]	general	U8	1	C	-
0x2022:032	Device commands: Deactivate PDO Communication	Off / ready [0]	general	U8	1	-	-
0x2022:033	Device commands: Activate PDO Communication	Off / ready [0]	general	U8	1	-	-
0x2030	CRC parameter set	- (Read only)	general	U32	1	-	-
0x203D (P730.00)	PIN1 access protection	0	general	I16	1	-	-
0x203E (P731.00)	PIN2 access protection	0	general	I16	1	-	-
0x203F	PIN1/PIN2 log-in	0	general	I16	1	-	-
0x2040 (P197.00)	Access protection status	- (Read only)	general	U16	1	-	-
0x2300 (P508.00)	CANopen communication	No action/no error [0]	CANopen	U8	1	C	-
0x2301:001 (P510.01)	CANopen settings: Node ID	1	CANopen	U8	1	P	-
0x2301:002 (P510.02)	CANopen settings: Baud rate	500 kbps [5]	CANopen	U8	1	P	-
0x2301:003 (P510.03)	CANopen settings: Slave/Master	Slave [0]	CANopen	U8	1	P	-
0x2301:004 (P510.04)	CANopen settings: Start remote delay	3000 ms	CANopen	U16	1	P	-
0x2301:005 (P510.05)	CANopen settings: Activate SDO2 channel	Not active [0]	CANopen	U8	1	-	-
0x2302:001 (P511.01)	Active CANopen settings: Active node ID	- (Read only)	CANopen	U8	1	-	-
0x2302:002 (P511.02)	Active CANopen settings: Active baud rate	- (Read only)	CANopen	U8	1	-	-
0x2303 (P509.00)	CANopen switch position	- (Read only)	CANopen	U16	1	-	-
0x2307 (P515.00)	CANopen time-out status	- (Read only)	CANopen	U32	1	-	-
0x2308 (P516.00)	CANopen status	- (Read only)	CANopen	U16	1	-	-
0x2309 (P517.00)	CANopen controller status	- (Read only)	CANopen	U16	1	-	-
0x230A:000	CANopen statistics: Highest subindex	- (Read only)	CANopen	U8	1	-	-
0x230A:001 (P580.01)	CANopen statistics: PDO1 received	- (Read only)	CANopen	U16	1	-	-
0x230A:002 (P580.02)	CANopen statistics: PDO2 received	- (Read only)	CANopen	U16	1	-	-

* Default setting depending on the size.

Firmware version 02.01.01.00



Appendix

Parameter attribute list

Address	Name	Default setting	Category	Data type	Factor	A	M
0x230A:003 (P580.03)	CANopen statistics: PDO3 received	- (Read only)	CANopen	U16	1	-	-
0x230A:005 (P580.05)	CANopen statistics: PDO1 transmitted	- (Read only)	CANopen	U16	1	-	-
0x230A:006 (P580.06)	CANopen statistics: PDO2 transmitted	- (Read only)	CANopen	U16	1	-	-
0x230A:007 (P580.07)	CANopen statistics: PDO3 transmitted	- (Read only)	CANopen	U16	1	-	-
0x230A:009 (P580.09)	CANopen statistics: SDO1 telegrams	- (Read only)	CANopen	U16	1	-	-
0x230A:010 (P580.10)	CANopen statistics: SDO2 telegrams	- (Read only)	CANopen	U16	1	-	-
0x230B (P518.00)	CANopen error counter	- (Read only)	CANopen	U16	1	-	-
0x231F:001 (P500.01)	Module ID: Active module ID	- (Read only)	general	U8	1	P	-
0x231F:002 (P500.02)	Module ID: Module ID connected	- (Read only)	general	U8	1	-	-
0x2320 (P508.00)	Modbus communication	0	Modbus	U8	1	-	-
0x2321:001 (P510.01)	Modbus settings: Node ID	1	Modbus	U8	1	P	-
0x2321:002 (P510.02)	Modbus settings: Baud rate	Automatic [0]	Modbus	U8	1	P	-
0x2321:003 (P510.03)	Modbus settings: Data format	Automatic [0]	Modbus	U8	1	P	-
0x2321:004 (P510.04)	Modbus settings: Minimum response time	0 ms	Modbus	U16	1	P	-
0x2322:001 (P511.01)	Active Modbus settings: Active node ID	- (Read only)	Modbus	U8	1	-	-
0x2322:002 (P511.02)	Active Modbus settings: Active baud rate	- (Read only)	Modbus	U8	1	-	-
0x2322:003 (P511.03)	Active Modbus settings: Data format	- (Read only)	Modbus	U8	1	-	-
0x2323 (P509.00)	Modbus switch position	- (Read only)	Modbus	U16	1	-	-
0x232A:001 (P580.01)	Modbus statistics: Messages received	- (Read only)	Modbus	U32	1	-	-
0x232A:002 (P580.02)	Modbus statistics: Valid messages received	- (Read only)	Modbus	U32	1	-	-
0x232A:003 (P580.03)	Modbus statistics: Messages with exceptions	- (Read only)	Modbus	U32	1	-	-
0x232A:004 (P580.04)	Modbus statistics: Messages with errors	- (Read only)	Modbus	U32	1	-	-
0x232A:005 (P580.05)	Modbus statistics: Messages sent	- (Read only)	Modbus	U32	1	-	-
0x232B:001 (P530.01)	Modbus parameter mapping: Parameter 1	0x00000000	Modbus	IDX	1	PH	-
0x232B:002 (P530.02)	Modbus parameter mapping: Parameter 2	0x00000000	Modbus	IDX	1	PH	-
0x232B:003 (P530.03)	Modbus parameter mapping: Parameter 3	0x00000000	Modbus	IDX	1	PH	-
0x232B:004 (P530.04)	Modbus parameter mapping: Parameter 4	0x00000000	Modbus	IDX	1	PH	-
0x232B:005 (P530.05)	Modbus parameter mapping: Parameter 5	0x00000000	Modbus	IDX	1	PH	-
0x232B:006 (P530.06)	Modbus parameter mapping: Parameter 6	0x00000000	Modbus	IDX	1	PH	-

* Default setting depending on the size.

Firmware version 02.01.01.00

Appendix

Parameter attribute list



Address	Name	Default setting	Category	Data type	Factor	A	M
0x232B:007 (P530.07)	Modbus parameter mapping: Parameter 7	0x00000000	Modbus	IDX	1	PH	-
0x232B:008 (P530.08)	Modbus parameter mapping: Parameter 8	0x00000000	Modbus	IDX	1	PH	-
0x232B:009 (P530.09)	Modbus parameter mapping: Parameter 9	0x00000000	Modbus	IDX	1	PH	-
0x232B:010 (P530.10)	Modbus parameter mapping: Parameter 10	0x00000000	Modbus	IDX	1	PH	-
0x232B:011 (P530.11)	Modbus parameter mapping: Parameter 11	0x00000000	Modbus	IDX	1	PH	-
0x232B:012 (P530.12)	Modbus parameter mapping: Parameter 12	0x00000000	Modbus	IDX	1	PH	-
0x232B:013 (P530.13)	Modbus parameter mapping: Parameter 13	0x00000000	Modbus	IDX	1	PH	-
0x232B:014 (P530.14)	Modbus parameter mapping: Parameter 14	0x00000000	Modbus	IDX	1	PH	-
0x232B:015 (P530.15)	Modbus parameter mapping: Parameter 15	0x00000000	Modbus	IDX	1	PH	-
0x232B:016 (P530.16)	Modbus parameter mapping: Parameter 16	0x00000000	Modbus	IDX	1	PH	-
0x232B:017 (P530.17)	Modbus parameter mapping: Parameter 17	0x00000000	Modbus	IDX	1	PH	-
0x232B:018 (P530.18)	Modbus parameter mapping: Parameter 18	0x00000000	Modbus	IDX	1	PH	-
0x232B:019 (P530.19)	Modbus parameter mapping: Parameter 19	0x00000000	Modbus	IDX	1	PH	-
0x232B:020 (P530.20)	Modbus parameter mapping: Parameter 20	0x00000000	Modbus	IDX	1	PH	-
0x232B:021 (P530.21)	Modbus parameter mapping: Parameter 21	0x00000000	Modbus	IDX	1	PH	-
0x232B:022 (P530.22)	Modbus parameter mapping: Parameter 22	0x00000000	Modbus	IDX	1	PH	-
0x232B:023 (P530.23)	Modbus parameter mapping: Parameter 23	0x00000000	Modbus	IDX	1	PH	-
0x232B:024 (P530.24)	Modbus parameter mapping: Parameter 24	0x00000000	Modbus	IDX	1	PH	-
0x232C:001 (P531.01)	Modbus register assignment: Register 1	- (Read only)	Modbus	U16	1	-	-
0x232C:002 (P531.02)	Modbus register assignment: Register 2	- (Read only)	Modbus	U16	1	-	-
0x232C:003 (P531.03)	Modbus register assignment: Register 3	- (Read only)	Modbus	U16	1	-	-
0x232C:004 (P531.04)	Modbus register assignment: Register 4	- (Read only)	Modbus	U16	1	-	-
0x232C:005 (P531.05)	Modbus register assignment: Register 5	- (Read only)	Modbus	U16	1	-	-
0x232C:006 (P531.06)	Modbus register assignment: Register 6	- (Read only)	Modbus	U16	1	-	-
0x232C:007 (P531.07)	Modbus register assignment: Register 7	- (Read only)	Modbus	U16	1	-	-
0x232C:008 (P531.08)	Modbus register assignment: Register 8	- (Read only)	Modbus	U16	1	-	-
0x232C:009 (P531.09)	Modbus register assignment: Register 9	- (Read only)	Modbus	U16	1	-	-
0x232C:010 (P531.10)	Modbus register assignment: Register 10	- (Read only)	Modbus	U16	1	-	-
0x232C:011 (P531.11)	Modbus register assignment: Register 11	- (Read only)	Modbus	U16	1	-	-

* Default setting depending on the size.

Firmware version 02.01.01.00



Appendix

Parameter attribute list

Address	Name	Default setting	Category	Data type	Factor	A	M
0x232C:012 (P531.12)	Modbus register assignment: Register 12	- (Read only)	Modbus	U16	1	-	-
0x232C:013 (P531.13)	Modbus register assignment: Register 13	- (Read only)	Modbus	U16	1	-	-
0x232C:014 (P531.14)	Modbus register assignment: Register 14	- (Read only)	Modbus	U16	1	-	-
0x232C:015 (P531.15)	Modbus register assignment: Register 15	- (Read only)	Modbus	U16	1	-	-
0x232C:016 (P531.16)	Modbus register assignment: Register 16	- (Read only)	Modbus	U16	1	-	-
0x232C:017 (P531.17)	Modbus register assignment: Register 17	- (Read only)	Modbus	U16	1	-	-
0x232C:018 (P531.18)	Modbus register assignment: Register 18	- (Read only)	Modbus	U16	1	-	-
0x232C:019 (P531.19)	Modbus register assignment: Register 19	- (Read only)	Modbus	U16	1	-	-
0x232C:020 (P531.20)	Modbus register assignment: Register 20	- (Read only)	Modbus	U16	1	-	-
0x232C:021 (P531.21)	Modbus register assignment: Register 21	- (Read only)	Modbus	U16	1	-	-
0x232C:022 (P531.22)	Modbus register assignment: Register 22	- (Read only)	Modbus	U16	1	-	-
0x232C:023 (P531.23)	Modbus register assignment: Register 23	- (Read only)	Modbus	U16	1	-	-
0x232C:024 (P531.24)	Modbus register assignment: Register 24	- (Read only)	Modbus	U16	1	-	-
0x232D (P532.00)	Modbus verification code	- (Read only)	Modbus	U16	1	-	-
0x232E:001 (P583.01)	Modbus diagnostics of last Rx data: Offset	0	Modbus	U8	1	-	-
0x232E:002 (P583.02)	Modbus diagnostics of last Rx data: Data byte 0	- (Read only)	Modbus	U8	1	-	-
0x232E:003 (P583.03)	Modbus diagnostics of last Rx data: Data byte 1	- (Read only)	Modbus	U8	1	-	-
0x232E:004 (P583.04)	Modbus diagnostics of last Rx data: Data byte 2	- (Read only)	Modbus	U8	1	-	-
0x232E:005 (P583.05)	Modbus diagnostics of last Rx data: Data byte 3	- (Read only)	Modbus	U8	1	-	-
0x232E:006 (P583.06)	Modbus diagnostics of last Rx data: Data byte 4	- (Read only)	Modbus	U8	1	-	-
0x232E:007 (P583.07)	Modbus diagnostics of last Rx data: Data byte 5	- (Read only)	Modbus	U8	1	-	-
0x232E:008 (P583.08)	Modbus diagnostics of last Rx data: Data byte 6	- (Read only)	Modbus	U8	1	-	-
0x232E:009 (P583.09)	Modbus diagnostics of last Rx data: Data byte 7	- (Read only)	Modbus	U8	1	-	-
0x232E:010 (P583.10)	Modbus diagnostics of last Rx data: Data byte 8	- (Read only)	Modbus	U8	1	-	-
0x232E:011 (P583.11)	Modbus diagnostics of last Rx data: Data byte 9	- (Read only)	Modbus	U8	1	-	-
0x232E:012 (P583.12)	Modbus diagnostics of last Rx data: Data byte 10	- (Read only)	Modbus	U8	1	-	-
0x232E:013 (P583.13)	Modbus diagnostics of last Rx data: Data byte 11	- (Read only)	Modbus	U8	1	-	-
0x232E:014 (P583.14)	Modbus diagnostics of last Rx data: Data byte 12	- (Read only)	Modbus	U8	1	-	-
0x232E:015 (P583.15)	Modbus diagnostics of last Rx data: Data byte 13	- (Read only)	Modbus	U8	1	-	-

* Default setting depending on the size.

Firmware version 02.01.01.00

Appendix

Parameter attribute list



Address	Name	Default setting	Category	Data type	Factor	A	M
0x232E:016 (P583.16)	Modbus diagnostics of last Rx data: Data byte 14	- (Read only)	Modbus	U8	1	-	-
0x232E:017 (P583.17)	Modbus diagnostics of last Rx data: Data byte 15	- (Read only)	Modbus	U8	1	-	-
0x232F:001 (P585.01)	Modbus diagnostics of last Tx data: Offset	0	Modbus	U8	1	-	-
0x232F:002 (P585.02)	Modbus diagnostics of last Tx data: Data byte 0	- (Read only)	Modbus	U8	1	-	-
0x232F:003 (P585.03)	Modbus diagnostics of last Tx data: Data byte 1	- (Read only)	Modbus	U8	1	-	-
0x232F:004 (P585.04)	Modbus diagnostics of last Tx data: Data byte 2	- (Read only)	Modbus	U8	1	-	-
0x232F:005 (P585.05)	Modbus diagnostics of last Tx data: Data byte 3	- (Read only)	Modbus	U8	1	-	-
0x232F:006 (P585.06)	Modbus diagnostics of last Tx data: Data byte 4	- (Read only)	Modbus	U8	1	-	-
0x232F:007 (P585.07)	Modbus diagnostics of last Tx data: Data byte 5	- (Read only)	Modbus	U8	1	-	-
0x232F:008 (P585.08)	Modbus diagnostics of last Tx data: Data byte 6	- (Read only)	Modbus	U8	1	-	-
0x232F:009 (P585.09)	Modbus diagnostics of last Tx data: Data byte 7	- (Read only)	Modbus	U8	1	-	-
0x232F:010 (P585.10)	Modbus diagnostics of last Tx data: Data byte 8	- (Read only)	Modbus	U8	1	-	-
0x232F:011 (P585.11)	Modbus diagnostics of last Tx data: Data byte 9	- (Read only)	Modbus	U8	1	-	-
0x232F:012 (P585.12)	Modbus diagnostics of last Tx data: Data byte 10	- (Read only)	Modbus	U8	1	-	-
0x232F:013 (P585.13)	Modbus diagnostics of last Tx data: Data byte 11	- (Read only)	Modbus	U8	1	-	-
0x232F:014 (P585.14)	Modbus diagnostics of last Tx data: Data byte 12	- (Read only)	Modbus	U8	1	-	-
0x232F:015 (P585.15)	Modbus diagnostics of last Tx data: Data byte 13	- (Read only)	Modbus	U8	1	-	-
0x232F:016 (P585.16)	Modbus diagnostics of last Tx data: Data byte 14	- (Read only)	Modbus	U8	1	-	-
0x232F:017 (P585.17)	Modbus diagnostics of last Tx data: Data byte 15	- (Read only)	Modbus	U8	1	-	-
0x2440	Initiate WLAN	No action/no error [0]	WLAN	U8	1	-	-
0x2441:001	IP address	28485824	WLAN	U32	1	PE	-
0x2441:002	Netmask	16777215	WLAN	U32	1	PE	-
0x2441:003	Gateway	28485824	WLAN	U32	1	PE	-
0x2441:004	DHCP	Enabled [1]	WLAN	U8	1	P	-
0x2441:005	DHCP start address	0	WLAN	U32	1	PE	-
0x2441:006	WLAN operation mode	Access point mode [0]	WLAN	U8	1	P	-
0x2441:007	WLAN SSID	i5	WLAN	STRING[32]	1	P	-
0x2441:008	WLAN password	password	WLAN	STRING[64]	1	P	-
0x2441:009	WLAN security	WPA2 [1]	WLAN	U8	1	P	-
0x2441:010	WLAN access	Enabled (WLAN on) [1]	WLAN	U8	1	P	-
0x2441:011	WLAN channel	Channel 1 [1]	WLAN	U8	1	P	-
0x2441:012	WLAN SSID broadcast	Activated [0]	WLAN	U8	1	P	-
0x2442:001	Active IP address	- (Read only)	WLAN	U32	1	E	-
0x2442:002	Active netmask	- (Read only)	WLAN	U32	1	E	-
0x2442:003	Active gateway	- (Read only)	WLAN	U32	1	E	-
0x2442:004	Active module mode	- (Read only)	WLAN	U8	1	-	-
0x2442:005	MAC address	- (Read only)	WLAN	OCTET[6]	1	-	-
0x2448:001	WLAN status: Connection time	- (Read only)	WLAN	U32	1	-	-

* Default setting depending on the size.

Firmware version 02.01.01.00



Appendix

Parameter attribute list

Address	Name	Default setting	Category	Data type	Factor	A	M
0x2448:002	WLAN status: Number of connections	- (Read only)	WLAN	U16	1	-	-
0x2448:003	WLAN status: Rx frame counter	- (Read only)	WLAN	U16	1	-	-
0x2448:004	WLAN status: Error statistics	- (Read only)	WLAN	U16	1	-	-
0x2449	WLAN error	- (Read only)	WLAN	U16	1	-	-
0x2540:001 (P208.01)	Mains settings: Rated mains voltage	230 Veff [0]	general	U8	1	PC	-
0x2540:002 (P208.02)	Mains settings: Undervoltage warning threshold	0 V *	general	U16	1	P	-
0x2540:003 (P208.03)	Mains settings: Undervoltage error threshold	x V (Read only)	general	U16	1	-	-
0x2540:004 (P208.04)	Mains settings: Undervoltage reset threshold	x V (Read only)	general	U16	1	-	-
0x2540:005 (P208.05)	Mains settings: Overvoltage warning threshold	0 V *	general	U16	1	P	-
0x2540:006 (P208.06)	Mains settings: Overvoltage error threshold	x V (Read only)	general	U16	1	-	-
0x2540:007 (P208.07)	Mains settings: Overvoltage reset threshold	x V (Read only)	general	U16	1	-	-
0x2541:001 (P706.01)	Brake energy management: Operating mode	Ramp function generator stop (RFGS) [1]	general	U8	1	P	-
0x2541:002 (P706.02)	Brake energy management: Active threshold	x V (Read only)	general	U16	1	P	-
0x2541:003 (P706.03)	Brake energy management: Reduced threshold	0 V	general	U16	1	P	-
0x2541:004 (P706.04)	Brake energy management: Additional frequency	0.0 Hz	general	U16	10	P	-
0x2541:005 (P706.05)	Brake energy management: Deceleration over-ride time	2.0 s	general	U16	10	P	-
0x2601:001 (P202.01)	Keypad setpoints: Frequency setpoint	20.0 Hz	general	U16	10	P	r
0x2601:002 (P202.02)	Keypad setpoints: Process controller setpoint	0.00 PID unit	general	I16	100	P	r
0x261C:001 (P740.01)	Favorites settings: Parameter 1	0x2DDD0000	general	IDX	1	PH	-
0x261C:002 (P740.02)	Favorites settings: Parameter 2	0x60780000	general	IDX	1	PH	-
0x261C:003 (P740.03)	Favorites settings: Parameter 3	0x2D890000	general	IDX	1	PH	-
0x261C:004 (P740.04)	Favorites settings: Parameter 4	0x603F0000	general	IDX	1	PH	-
0x261C:005 (P740.05)	Favorites settings: Parameter 5	0x28240000	general	IDX	1	PH	-
0x261C:006 (P740.06)	Favorites settings: Parameter 6	0x28600100	general	IDX	1	PH	-
0x261C:007 (P740.07)	Favorites settings: Parameter 7	0x28380100	general	IDX	1	PH	-
0x261C:008 (P740.08)	Favorites settings: Parameter 8	0x28380300	general	IDX	1	PH	-
0x261C:009 (P740.09)	Favorites settings: Parameter 9	0x25400100	general	IDX	1	PH	-
0x261C:010 (P740.10)	Favorites settings: Parameter 10	0x29150000	general	IDX	1	PH	-
0x261C:011 (P740.11)	Favorites settings: Parameter 11	0x29160000	general	IDX	1	PH	-
0x261C:012 (P740.12)	Favorites settings: Parameter 12	0x29170000	general	IDX	1	PH	-
0x261C:013 (P740.13)	Favorites settings: Parameter 13	0x29180000	general	IDX	1	PH	-

* Default setting depending on the size.

Firmware version 02.01.01.00

Appendix

Parameter attribute list



Address	Name	Default setting	Category	Data type	Factor	A	M
0x261C:014 (P740.14)	Favorites settings: Parameter 14	0x2C000000	general	IDX	1	PH	-
0x261C:015 (P740.15)	Favorites settings: Parameter 15	0x2B000000	general	IDX	1	PH	-
0x261C:016 (P740.16)	Favorites settings: Parameter 16	0x2B010100	general	IDX	1	PH	-
0x261C:017 (P740.17)	Favorites settings: Parameter 17	0x2B010200	general	IDX	1	PH	-
0x261C:018 (P740.18)	Favorites settings: Parameter 18	0x283A0000	general	IDX	1	PH	-
0x261C:019 (P740.19)	Favorites settings: Parameter 19	0x29390000	general	IDX	1	PH	-
0x261C:020 (P740.20)	Favorites settings: Parameter 20	0x2D4B0100	general	IDX	1	PH	-
0x261C:021 (P740.21)	Favorites settings: Parameter 21	0x2B120100	general	IDX	1	PH	-
0x261C:022 (P740.22)	Favorites settings: Parameter 22	0x60730000	general	IDX	1	PH	-
0x261C:023 (P740.23)	Favorites settings: Parameter 23	0x26310100	general	IDX	1	PH	-
0x261C:024 (P740.24)	Favorites settings: Parameter 24	0x26310200	general	IDX	1	PH	-
0x261C:025 (P740.25)	Favorites settings: Parameter 25	0x26310300	general	IDX	1	PH	-
0x261C:026 (P740.26)	Favorites settings: Parameter 26	0x26310400	general	IDX	1	PH	-
0x261C:027 (P740.27)	Favorites settings: Parameter 27	0x26310500	general	IDX	1	PH	-
0x261C:028 (P740.28)	Favorites settings: Parameter 28	0x26310600	general	IDX	1	PH	-
0x261C:029 (P740.29)	Favorites settings: Parameter 29	0x26310700	general	IDX	1	PH	-
0x261C:030 (P740.30)	Favorites settings: Parameter 30	0x26310800	general	IDX	1	PH	-
0x261C:031 (P740.31)	Favorites settings: Parameter 31	0x26310900	general	IDX	1	PH	-
0x261C:032 (P740.32)	Favorites settings: Parameter 32	0x26310D00	general	IDX	1	PH	-
0x261C:033 (P740.33)	Favorites settings: Parameter 33	0x26311200	general	IDX	1	PH	-
0x261C:034 (P740.34)	Favorites settings: Parameter 34	0x26311300	general	IDX	1	PH	-
0x261C:035 (P740.35)	Favorites settings: Parameter 35	0x26311400	general	IDX	1	PH	-
0x261C:036 (P740.36)	Favorites settings: Parameter 36	0x26340100	general	IDX	1	PH	-
0x261C:037 (P740.37)	Favorites settings: Parameter 37	0x26340200	general	IDX	1	PH	-
0x261C:038 (P740.38)	Favorites settings: Parameter 38	0x26360100	general	IDX	1	PH	-
0x261C:039 (P740.39)	Favorites settings: Parameter 39	0x26360200	general	IDX	1	PH	-
0x261C:040 (P740.40)	Favorites settings: Parameter 40	0x26360300	general	IDX	1	PH	-
0x261C:041 (P740.41)	Favorites settings: Parameter 41	0x26390100	general	IDX	1	PH	-
0x261C:042 (P740.42)	Favorites settings: Parameter 42	0x26390200	general	IDX	1	PH	-

* Default setting depending on the size.

Firmware version 02.01.01.00



Appendix

Parameter attribute list

Address	Name	Default setting	Category	Data type	Factor	A	M
0x261C:043 (P740.43)	Favorites settings: Parameter 43	0x26390300	general	IDX	1	PH	-
0x261C:044 (P740.44)	Favorites settings: Parameter 44	0x26390400	general	IDX	1	PH	-
0x261C:045 (P740.45)	Favorites settings: Parameter 45	0x29110100	general	IDX	1	PH	-
0x261C:046 (P740.46)	Favorites settings: Parameter 46	0x29110200	general	IDX	1	PH	-
0x261C:047 (P740.47)	Favorites settings: Parameter 47	0x29110300	general	IDX	1	PH	-
0x261C:048 (P740.48)	Favorites settings: Parameter 48	0x29110400	general	IDX	1	PH	-
0x261C:049 (P740.49)	Favorites settings: Parameter 49	0x00000000	general	IDX	1	PH	-
0x261C:050 (P740.50)	Favorites settings: Parameter 50	0x00000000	general	IDX	1	PH	-
0x2630:002 (P410.02)	Settings for digital inputs: Input function	Digital input [0]	general	U8	1	P	-
0x2631:001 (P400.01)	Function list: Enable inverter	Constant TRUE [1]	general	U8	1	CP	-
0x2631:002 (P400.02)	Function list: Run	Digital input 1 [11]	general	U8	1	CP	-
0x2631:003 (P400.03)	Function list: Activate quick stop	Not connected [0]	general	U8	1	CP	-
0x2631:004 (P400.04)	Function list: Reset fault	Digital input 2 [12]	general	U8	1	P	-
0x2631:005 (P400.05)	Function list: Activate DC braking	Not connected [0]	general	U8	1	P	-
0x2631:006 (P400.06)	Function list: Start forward (CW)	Not connected [0]	general	U8	1	CP	-
0x2631:007 (P400.07)	Function list: Start reverse (CCW)	Not connected [0]	general	U8	1	CP	-
0x2631:008 (P400.08)	Function list: Run forward (CW)	Not connected [0]	general	U8	1	CP	-
0x2631:009 (P400.09)	Function list: Run reverse (CCW)	Not connected [0]	general	U8	1	CP	-
0x2631:010 (P400.10)	Function list: Jog forward (CW)	Not connected [0]	general	U8	1	CP	-
0x2631:011 (P400.11)	Function list: Jog reverse (CCW)	Not connected [0]	general	U8	1	CP	-
0x2631:012 (P400.12)	Function list: Activate keypad control	Not connected [0]	general	U8	1	P	-
0x2631:013 (P400.13)	Function list: Invert rotation	Digital input 3 [13]	general	U8	1	CP	-
0x2631:014 (P400.14)	Function list: Activate AI1 setpoint	Not connected [0]	general	U8	1	P	-
0x2631:015 (P400.15)	Function list: Activate AI2 setpoint	Not connected [0]	general	U8	1	P	-
0x2631:016 (P400.16)	Function list: Activate keypad setpoint	Not connected [0]	general	U8	1	P	-
0x2631:018 (P400.18)	Function list: Activate preset (bit 0)	Digital input 4 [14]	general	U8	1	P	-
0x2631:019 (P400.19)	Function list: Activate preset (bit 1)	Digital input 5 [15]	general	U8	1	P	-
0x2631:020 (P400.20)	Function list: Activate preset (bit 2)	Not connected [0]	general	U8	1	P	-
0x2631:021 (P400.21)	Function list: Activate preset (bit 3)	Not connected [0]	general	U8	1	P	-

* Default setting depending on the size.

Firmware version 02.01.01.00

Appendix

Parameter attribute list



Address	Name	Default setting	Category	Data type	Factor	A	M
0x2631:023 (P400.23)	Function list: MOP setpoint up	Not connected [0]	general	U8	1	P	-
0x2631:024 (P400.24)	Function list: MOP setpoint down	Not connected [0]	general	U8	1	P	-
0x2631:025 (P400.25)	Function list: Activate MOP setpoint	Not connected [0]	general	U8	1	P	-
0x2631:037 (P400.37)	Function list: Activate network control	Not connected [0]	general	U8	1	P	-
0x2631:039 (P400.39)	Function list: Activate ramp 2	Not connected [0]	general	U8	1	P	-
0x2631:040 (P400.40)	Function list: Load parameter set	Not connected [0]	general	U8	1	CP	-
0x2631:041 (P400.41)	Function list: Select parameter set (bit 0)	Not connected [0]	general	U8	1	CP	-
0x2631:042 (P400.42)	Function list: Select parameter set (bit 1)	Not connected [0]	general	U8	1	CP	-
0x2631:043 (P400.43)	Function list: Activate fault 1	Not connected [0]	general	U8	1	P	-
0x2631:044 (P400.44)	Function list: Activate fault 2	Not connected [0]	general	U8	1	P	-
0x2631:045 (P400.45)	Function list: Deactivate PID controller	Not connected [0]	general	U8	1	P	-
0x2631:046 (P400.46)	Function list: Set process controller output to 0	Not connected [0]	general	U8	1	P	-
0x2631:047 (P400.47)	Function list: Inhibit process controller I-component	Not connected [0]	general	U8	1	P	-
0x2631:048 (P400.48)	Function list: Activate process controller influence ramp	Constant TRUE [1]	general	U8	1	P	-
0x2631:049 (P400.49)	Function list: Release holding brake	Not connected [0]	general	U8	1	CP	-
0x2632:001 (P411.01)	Inversion of digital inputs: Digital input 1	Not inverted [0]	general	U8	1	P	-
0x2632:002 (P411.02)	Inversion of digital inputs: Digital input 2	Not inverted [0]	general	U8	1	P	-
0x2632:003 (P411.03)	Inversion of digital inputs: Digital input 3	Not inverted [0]	general	U8	1	P	-
0x2632:004 (P411.04)	Inversion of digital inputs: Digital input 4	Not inverted [0]	general	U8	1	P	-
0x2632:005 (P411.05)	Inversion of digital inputs: Digital input 5	Not inverted [0]	general	U8	1	P	-
0x2633:001	Digital input debounce time: Digital input 1	1 ms	general	U8	1	P	-
0x2633:002	Digital input debounce time: Digital input 2	1 ms	general	U8	1	P	-
0x2633:003	Digital input debounce time: Digital input 3	1 ms	general	U8	1	P	-
0x2633:004	Digital input debounce time: Digital input 4	1 ms	general	U8	1	P	-
0x2633:005	Digital input debounce time: Digital input 5	1 ms	general	U8	1	P	-
0x2634:001 (P420.01)	Digital outputs function: Relay	Ready for operation [51]	general	U8	1	P	-
0x2634:002 (P420.02)	Digital outputs function: Digital output 1	Release holding brake [115]	general	U8	1	P	-
0x2634:010 (P420.10)	Digital outputs function: NetWordOUT1 - bit 0	Ready for operation [51]	general	U8	1	P	-
0x2634:011 (P420.11)	Digital outputs function: NetWordOUT1 - bit 1	Not connected [0]	general	U8	1	P	-
0x2634:012 (P420.12)	Digital outputs function: NetWordOUT1 - bit 2	Operation enabled [52]	general	U8	1	P	-
0x2634:013 (P420.13)	Digital outputs function: NetWordOUT1 - bit 3	Error active [56]	general	U8	1	P	-
0x2634:014 (P420.14)	Digital outputs function: NetWordOUT1 - bit 4	Not connected [0]	general	U8	1	P	-

* Default setting depending on the size.

Firmware version 02.01.01.00



Appendix

Parameter attribute list

Address	Name	Default setting	Category	Data type	Factor	A	M
0x2634:015 (P420.15)	Digital outputs function: NetWordOUT1 - bit 5	Quick stop active [54]	general	U8	1	P	-
0x2634:016 (P420.16)	Digital outputs function: NetWordOUT1 - bit 6	Running [50]	general	U8	1	P	-
0x2634:017 (P420.17)	Digital outputs function: NetWordOUT1 - bit 7	Device warning active [58]	general	U8	1	P	-
0x2634:018 (P420.18)	Digital outputs function: NetWordOUT1 - bit 8	Not connected [0]	general	U8	1	P	-
0x2634:019 (P420.19)	Digital outputs function: NetWordOUT1 - bit 9	Not connected [0]	general	U8	1	P	-
0x2634:020 (P420.20)	Digital outputs function: NetWordOUT1 - bit 10	Setpoint speed reached [72]	general	U8	1	P	-
0x2634:021 (P420.21)	Digital outputs function: NetWordOUT1 - bit 11	Current limit reached [78]	general	U8	1	P	-
0x2634:022 (P420.22)	Digital outputs function: NetWordOUT1 - bit 12	Actual speed = 0 [71]	general	U8	1	P	-
0x2634:023 (P420.23)	Digital outputs function: NetWordOUT1 - bit 13	Rotational direction reversed [69]	general	U8	1	P	-
0x2634:024 (P420.24)	Digital outputs function: NetWordOUT1 - bit 14	Release holding brake [115]	general	U8	1	P	-
0x2634:025 (P420.25)	Digital outputs function: NetWordOUT1 - bit 15	Safe torque off (STO) active [55]	general	U8	1	P	-
0x2635:001 (P421.01)	Inversion of digital outputs: Relay	Not inverted [0]	general	U8	1	P	-
0x2635:002 (P421.02)	Inversion of digital outputs: Digital output 1	Not inverted [0]	general	U8	1	P	-
0x2635:010	Inversion of digital outputs: NetWordOUT1.00	Not inverted [0]	general	U8	1	P	-
0x2635:011	Inversion of digital outputs: NetWordOUT1.01	Not inverted [0]	general	U8	1	P	-
0x2635:012	Inversion of digital outputs: NetWordOUT1.02	Not inverted [0]	general	U8	1	P	-
0x2635:013	Inversion of digital outputs: NetWordOUT1.03	Not inverted [0]	general	U8	1	P	-
0x2635:014	Inversion of digital outputs: NetWordOUT1.04	Not inverted [0]	general	U8	1	P	-
0x2635:015	Inversion of digital outputs: NetWordOUT1.05	Not inverted [0]	general	U8	1	P	-
0x2635:016	Inversion of digital outputs: NetWordOUT1.06	Not inverted [0]	general	U8	1	P	-
0x2635:017	Inversion of digital outputs: NetWordOUT1.07	Not inverted [0]	general	U8	1	P	-
0x2635:018	Inversion of digital outputs: NetWordOUT1.08	Not inverted [0]	general	U8	1	P	-
0x2635:019	Inversion of digital outputs: NetWordOUT1.09	Not inverted [0]	general	U8	1	P	-
0x2635:020	Inversion of digital outputs: NetWordOUT1.10	Not inverted [0]	general	U8	1	P	-
0x2635:021	Inversion of digital outputs: NetWordOUT1.11	Not inverted [0]	general	U8	1	P	-
0x2635:022	Inversion of digital outputs: NetWordOUT1.12	Not inverted [0]	general	U8	1	P	-
0x2635:023	Inversion of digital outputs: NetWordOUT1.13	Not inverted [0]	general	U8	1	P	-
0x2635:024	Inversion of digital outputs: NetWordOUT1.14	Not inverted [0]	general	U8	1	P	-
0x2635:025	Inversion of digital outputs: NetWordOUT1.15	Not inverted [0]	general	U8	1	P	-
0x2636:001 (P430.01)	Analog input 1: Input range	0 ... 10 VDC [0]	general	U8	1	P	-
0x2636:002 (P430.02)	Analog input 1: Min frequency value	0.0 Hz	general	I16	10	P	-
0x2636:003 (P430.03)	Analog input 1: Max frequency value	50.0 Hz	general	I16	10	P	-
0x2636:004 (P430.04)	Analog input 1: Min PID value	0.00 PID unit/%	general	I16	100	P	-
0x2636:005 (P430.05)	Analog input 1: Max PID value	100.00 PID unit/%	general	I16	100	P	-
0x2636:006 (P430.06)	Analog input 1: Filter time	10 ms	general	U16	1	P	-
0x2636:007 (P430.07)	Analog input 1: Dead band	0.0 %	general	U16	10	P	-
0x2636:008 (P430.08)	Analog input 1: Monitoring threshold	0.0 %	general	I16	10	P	-

* Default setting depending on the size.

Firmware version 02.01.01.00

Appendix

Parameter attribute list



Address	Name	Default setting	Category	Data type	Factor	A	M
0x2636:009 (P430.09)	Analog input 1: Monitoring condition	Input value < trigger threshold [0]	general	U8	1	P	-
0x2636:010 (P430.10)	Analog input 1: Error response	Fault [3]	general	U8	1	P	-
0x2637:001 (P431.01)	Analog input 2: Input range	0 ... 10 VDC [0]	general	U8	1	P	-
0x2637:002 (P431.02)	Analog input 2: Min frequency value	0.0 Hz	general	I16	10	P	-
0x2637:003 (P431.03)	Analog input 2: Max frequency value	50.0 Hz	general	I16	10	P	-
0x2637:004 (P431.04)	Analog input 2: Min PID value	0.00 PID unit/%	general	I16	100	P	-
0x2637:005 (P431.05)	Analog input 2: Max PID value	100.00 PID unit/%	general	I16	100	P	-
0x2637:006 (P431.06)	Analog input 2: Filter time	10 ms	general	U16	1	P	-
0x2637:007 (P431.07)	Analog input 2: Dead band	0.0 %	general	U16	10	P	-
0x2637:008 (P431.08)	Analog input 2: Monitoring threshold	0.0 %	general	I16	10	P	-
0x2637:009 (P431.09)	Analog input 2: Monitoring condition	Input value < trigger threshold [0]	general	U8	1	P	-
0x2637:010 (P431.10)	Analog input 2: Error response	Fault [3]	general	U8	1	P	-
0x2639:001 (P440.01)	Analog output 1: Output range	0 ... 10 VDC [1]	general	U8	1	P	-
0x2639:002 (P440.02)	Analog output 1: Function	Output frequency [1]	general	U8	1	P	-
0x2639:003 (P440.03)	Analog output 1: Min. signal	0	general	I32	1	P	-
0x2639:004 (P440.04)	Analog output 1: Max. signal	1000	general	I32	1	P	-
0x2820:001 (P712.01)	Holding brake control: Brake mode	Off [2]	general	U8	1	P	r
0x2820:002 (P712.02)	Holding brake control: Brake closing time	100 ms	general	U16	1	P	-
0x2820:003 (P712.03)	Holding brake control: Brake opening time	100 ms	general	U16	1	P	-
0x2820:007 (P712.07)	Holding brake control: Brake closing threshold	0.2 Hz	general	U16	10	P	-
0x2820:008 (P712.08)	Holding brake control: Brake holding load	0.0 %	general	I16	10	P	-
0x2820:015 (P712.15)	Holding brake control: Brake status	- (Read only)	general	U8	1	-	-
0x2822:001	Axis commands: Enable inverter	Inverter inhibited [0]	general	U8	1	-	-
0x2822:002	Axis commands: Activate quick stop	0	general	U8	1	-	-
0x2822:003	Axis commands: Reset error	0	general	U8	1	-	-
0x2822:004 (P327.04)	Axis commands: Identify motor data (energized)	0	general	U8	1	-	-
0x2822:005 (P327.05)	Axis commands: Calibrate motor data (non-energized)	0	general	U8	1	-	-
0x2822:019	Axis commands: Calculate I _{max} controller parameter	0	general	U8	1	-	-
0x2822:028	Axis commands: Initialize device controller	0	general	U8	1	-	-
0x2823:001	Last subindex	- (Read only)	general	U8	1	-	-
0x2823:002	Status of last axis command	- (Read only)	general	U8	1	-	-
0x2824 (P200.00)	Control selection	Flexible I/O configuration [0]	general	U8	1	P	-
0x2826	Time-out for error response	6.0 s	general	U16	10	P	-

* Default setting depending on the size.

Firmware version 02.01.01.00



Appendix

Parameter attribute list

Address	Name	Default setting	Category	Data type	Factor	A	M
0x2827 (P198.00)	Currently loaded parameter settings	- (Read only)	general	U8	1	-	-
0x2829 (P732.00)	Automatic storage in the memory module	Inhibit [0]	general	U8	1	P	-
0x282A:001 (P126.01)	Status words: Cause of disable	- (Read only)	general	U32	1	O	-
0x282A:002 (P126.02)	Status words: Cause of quick stop	- (Read only)	general	U16	1	O	-
0x282A:003 (P126.03)	Status words: Cause of stop	- (Read only)	general	U16	1	O	-
0x282A:004	Status words: Extended status word	- (Read only)	general	U16	1	O	t
0x282A:005 (P126.05)	Status words: Device status	- (Read only)	general	U8	1	O	t
0x282B:001 (P125.01)	Inverter diagnostics: Active control source	- (Read only)	general	U8	1	O	t
0x282B:002 (P125.02)	Inverter diagnostics: Active setpoint source	- (Read only)	general	U8	1	O	t
0x282B:003 (P125.03)	Inverter diagnostics: Keypad LCD status	- (Read only)	general	U8	1	O	-
0x282B:004 (P125.04)	Inverter diagnostics: Active drive mode	- (Read only)	general	U8	1	O	t
0x282B:005 (P125.05)	Inverter diagnostics: Most recently used control register	- (Read only)	general	U32	1	OH	-
0x282B:006 (P125.06)	Inverter diagnostics: Most recently used setpoint register	- (Read only)	general	U32	1	OH	-
0x2831	Inverter status word	- (Read only)	general	U16	1	O	t
0x2832	Motor identification status	- (Read only)	general	U16	1	O	-
0x2833	Inverter status word 2	- (Read only)	general	U16	1	O	t
0x2838:001 (P203.01)	Start/stop configuration: Start method	Normal [0]	general	U8	1	CP	-
0x2838:002 (P203.02)	Start/stop configuration: Start at power-up	Off [0]	general	U8	1	P	-
0x2838:003 (P203.03)	Start/stop configuration: Stop method	Standard ramp [1]	general	U8	1	P	-
0x2839:002 (P760.02)	Fault configuration: Restart delay	3.0 s	general	U16	10	P	-
0x2839:003 (P760.03)	Fault configuration: Number of restart attempts	5	general	U8	1	P	-
0x2839:004 (P760.04)	Fault configuration: Trouble counter reset time	5.0 s	general	U16	10	P	-
0x2839:005 (P760.05)	Fault configuration: Trouble counter	- (Read only)	general	U8	1	-	-
0x283A (P304.00)	Limitation of rotation	Both rotation directions [1]	general	U8	1	P	-
0x2857:001	CANopen monitoring: RPDO1-Timeout	Fault [3]	CANopen	U8	1	P	-
0x2857:002	CANopen monitoring: RPDO2-Timeout	Fault [3]	CANopen	U8	1	P	-
0x2857:003	CANopen monitoring: RPDO3-Timeout	Fault [3]	CANopen	U8	1	P	-
0x2857:005	CANopen monitoring: Heartbeat-Timeout Consumer 1	Fault [3]	CANopen	U8	1	P	-
0x2857:006	CANopen monitoring: Heartbeat-Timeout Consumer 2	Fault [3]	CANopen	U8	1	P	-
0x2857:007	CANopen monitoring: Heartbeat-Timeout Consumer 3	Fault [3]	CANopen	U8	1	P	-
0x2857:008	CANopen monitoring: Heartbeat-Timeout Consumer 4	Fault [3]	CANopen	U8	1	P	-
0x2857:010	CANopen monitoring: "Bus-off" state change	Trouble [2]	CANopen	U8	1	P	-
0x2857:011	CANopen monitoring: Warning	Warning [1]	CANopen	U8	1	P	-

* Default setting depending on the size.

Firmware version 02.01.01.00

Appendix

Parameter attribute list



Address	Name	Default setting	Category	Data type	Factor	A	M
0x2858:001 (P515.01)	Modbus monitoring: Response to time-out	Fault [3]	Modbus	U8	1	P	-
0x2858:002 (P515.02)	Modbus monitoring: Time-out time	2.0 s	Modbus	U16	10	P	-
0x2860:001 (P201.01)	Frequency control: Default setpoint source	Analog input 1 [2]	general	U8	1	P	-
0x2860:002 (P201.02)	PID control: Default setpoint source	Keypad [1]	general	U8	1	P	-
0x2862 (P701.00)	Keypad setpoint increment	1	general	U16	1	P	-
0x2863 (P705.00)	Keypad language selection	English [1]	general	U8	1	P	-
0x2864 (P703.00)	Keypad status display	0x00000000	general	IDX	1	PH	-
0x2900:001 (P332.01)	Speed controller settings: Gain	0.00193 Nm/rpm *	MCTRL	U32	100000	P	-
0x2900:002 (P332.02)	Speed controller settings: Reset time	80.0 ms *	MCTRL	U16	10	P	-
0x2904	Actual speed filter time	2.0 ms	MCTRL	U16	10	P	-
0x2910:001 (P335.01)	Motor moment of inertia	3.70 kg cm² *	MCTRL	U32	100	P	-
0x2910:002 (P335.02)	Load moment of inertia	3.70 kg cm² *	MCTRL	U32	100	P	-
0x2910:003	Coupling	With backlash [2]	MCTRL	U8	1	P	-
0x2911:001 (P450.01)	Frequency setpoint presets: Preset 1	20.0 Hz	general	U16	10	P	-
0x2911:002 (P450.02)	Frequency setpoint presets: Preset 2	40.0 Hz	general	U16	10	P	-
0x2911:003 (P450.03)	Frequency setpoint presets: Preset 3	50.0 Hz	general	U16	10	P	-
0x2911:004 (P450.04)	Frequency setpoint presets: Preset 4	0.0 Hz	general	U16	10	P	-
0x2911:005 (P450.05)	Frequency setpoint presets: Preset 5	0.0 Hz	general	U16	10	P	-
0x2911:006 (P450.06)	Frequency setpoint presets: Preset 6	0.0 Hz	general	U16	10	P	-
0x2911:007 (P450.07)	Frequency setpoint presets: Preset 7	0.0 Hz	general	U16	10	P	-
0x2911:008 (P450.08)	Frequency setpoint presets: Preset 8	0.0 Hz	general	U16	10	P	-
0x2911:009 (P450.09)	Frequency setpoint presets: Preset 9	0.0 Hz	general	U16	10	P	-
0x2911:010 (P450.10)	Frequency setpoint presets: Preset 10	0.0 Hz	general	U16	10	P	-
0x2911:011 (P450.11)	Frequency setpoint presets: Preset 11	0.0 Hz	general	U16	10	P	-
0x2911:012 (P450.12)	Frequency setpoint presets: Preset 12	0.0 Hz	general	U16	10	P	-
0x2911:013 (P450.13)	Frequency setpoint presets: Preset 13	0.0 Hz	general	U16	10	P	-
0x2911:014 (P450.14)	Frequency setpoint presets: Preset 14	0.0 Hz	general	U16	10	P	-
0x2911:015 (P450.15)	Frequency setpoint presets: Preset 15	0.0 Hz	general	U16	10	P	-
0x2915 (P210.00)	Minimum frequency	0.0 Hz	general	U16	10	P	-
0x2916 (P211.00)	Maximum frequency	50.0 Hz	general	U16	10	P	-

* Default setting depending on the size.

Firmware version 02.01.01.00



Appendix

Parameter attribute list

Address	Name	Default setting	Category	Data type	Factor	A	M
0x2917 (P220.00)	Acceleration time 1	5.0 s	general	U16	10	P	r
0x2918 (P221.00)	Deceleration time 1	5.0 s	general	U16	10	P	r
0x2919 (P222.00)	Acceleration time 2	5.0 s	general	U16	10	P	-
0x291A (P223.00)	Deceleration time 2	5.0 s	general	U16	10	P	-
0x291B (P224.00)	Auto-changeover threshold of ramp 2	0.0 Hz	general	U16	10	P	-
0x291C (P225.00)	Quick stop deceleration time	1.0 s	general	U16	10	P	-
0x291E:001 (P226.01)	S-Ramp characteristic: Smoothing factor	0.0 %	general	U16	10	P	-
0x291F:001 (P317.01)	Skip frequencies: Skip frequency 1	0.0 Hz	general	U16	10	P	-
0x291F:002 (P317.02)	Skip frequencies: Skip bandwidth 1	0.0 Hz	general	U8	10	P	-
0x291F:003 (P317.03)	Skip frequencies: Skip frequency 2	0.0 Hz	general	U16	10	P	-
0x291F:004 (P317.04)	Skip frequencies: Skip bandwidth 2	0.0 Hz	general	U8	10	P	-
0x291F:005 (P317.05)	Skip frequencies: Skip frequency 3	0.0 Hz	general	U16	10	P	-
0x291F:006 (P317.06)	Skip frequencies: Skip bandwidth 3	0.0 Hz	general	U8	10	P	-
0x291F:016	Skip frequencies: Status	- (Read only)	general	U16	1	-	-
0x291F:032	Skip frequencies: Input frequency	x.xx Hz (Read only)	general	I32	100	-	-
0x291F:033	Skip frequencies: Output frequency	x.xx Hz (Read only)	general	I32	100	-	-
0x2939 (P305.00)	Switching frequency	8 kHz variable / drive-optimised / 4 kHz min. [21]	general	U8	1	P	-
0x2942:001 (P334.01)	Current controller parameters: Gain	42.55 V/A *	MCTRL	U32	100	P	-
0x2942:002 (P334.02)	Current controller parameters: Reset time	4.50 ms *	MCTRL	U32	100	P	-
0x2947:001	Inverter characteristic: Value y1	0.00 V *	MCTRL	U16	100	P	-
0x2947:002	Inverter characteristic: Value y2	0.00 V *	MCTRL	U16	100	P	-
0x2947:003	Inverter characteristic: Value y3	0.00 V *	MCTRL	U16	100	P	-
0x2947:004	Inverter characteristic: Value y4	0.00 V *	MCTRL	U16	100	P	-
0x2947:005	Inverter characteristic: Value y5	0.00 V *	MCTRL	U16	100	P	-
0x2947:006	Inverter characteristic: Value y6	0.00 V *	MCTRL	U16	100	P	-
0x2947:007	Inverter characteristic: Value y7	0.00 V *	MCTRL	U16	100	P	-
0x2947:008	Inverter characteristic: Value y8	0.00 V *	MCTRL	U16	100	P	-
0x2947:009	Inverter characteristic: Value y9	0.00 V *	MCTRL	U16	100	P	-
0x2947:010	Inverter characteristic: Value y10	0.00 V *	MCTRL	U16	100	P	-
0x2947:011	Inverter characteristic: Value y11	0.00 V *	MCTRL	U16	100	P	-
0x2947:012	Inverter characteristic: Value y12	0.00 V *	MCTRL	U16	100	P	-
0x2947:013	Inverter characteristic: Value y13	0.00 V *	MCTRL	U16	100	P	-
0x2947:014	Inverter characteristic: Value y14	0.00 V *	MCTRL	U16	100	P	-
0x2947:015	Inverter characteristic: Value y15	0.00 V *	MCTRL	U16	100	P	-
0x2947:016	Inverter characteristic: Value y16	0.00 V *	MCTRL	U16	100	P	-
0x2947:017	Inverter characteristic: Value y17	0.00 V *	MCTRL	U16	100	P	-
0x29C0:001	Field controller settings: Gain	59.68 A/Vs *	MCTRL	U32	100	P	-
0x29C0:002	Field controller settings: Reset time	45.5 ms *	MCTRL	U16	10	P	-
0x29E0:001	Field weakening controller settings: Gain	0.000 Vs/V *	MCTRL	U32	1000	P	-
0x29E0:002	Field weakening controller settings: Reset time	1478.3 ms *	MCTRL	U32	10	P	-

* Default setting depending on the size.

Firmware version 02.01.01.00

Appendix

Parameter attribute list



Address	Name	Default setting	Category	Data type	Factor	A	M
0x2B00 (P302.00)	V/f characteristic shape	Linear [0]	general	U8	1	CP	-
0x2B01:001 (P303.01)	V/f shape data: Base voltage	230 V *	MCTRL	U16	1	P	-
0x2B01:002 (P303.02)	V/f shape data: Base frequency	50 Hz *	MCTRL	U16	1	P	-
0x2B08:001 (P333.01)	V/f lmax controller: Gain	0.284 Hz/A *	MCTRL	U32	1000	P	-
0x2B08:002 (P333.02)	V/f lmax controller: Reset time	2.3 ms *	MCTRL	U32	10	P	-
0x2B09:001 (P315.01)	Slip compensation: Gain	100.00 %	general	I16	100	P	-
0x2B09:002 (P315.02)	Slip compensation: Filter time	5 ms	general	U16	1	P	-
0x2B0A:001 (P318.01)	Gain	20 %	MCTRL	I16	1	P	-
0x2B0A:002 (P318.02)	Filter time	5 ms	MCTRL	U16	1	P	-
0x2B0C (P319.00)	Override field weakening	0.0 Hz	general	I16	10	P	-
0x2B0D:001 (P330.01)	Minimum voltage	20 %	MCTRL	I16	1	P	-
0x2B0E (P102.00)	Frequency setpoint	x.x Hz (Read only)	general	I16	10	O	t
0x2B0F	VFC output frequency	x.x Hz (Read only)	MCTRL	I16	10	O	t
0x2B12:001 (P316.01)	V/f voltage boost: Fixed boost	2.5 % *	general	U8	10	P	-
0x2B12:002 (P316.02)	V/f voltage boost: Boost at acceleration	0.0 %	general	U8	10	P	-
0x2B13:001	Additive voltage impression: Enable Function	Disable [0]	general	U8	1	P	-
0x2B13:002	Additive voltage impression: Setpoint source	Analog input 1 [1]	general	U8	1	P	-
0x2B13:003	Additive voltage impression: Actual voltage	x V (Read only)	general	I16	1	-	-
0x2B40:001	SLVC: Gain	0.2686 Hz/A *	MCTRL	U32	10000	P	-
0x2B40:002	SLVC: Reset time	2.3 ms *	MCTRL	U32	10	P	-
0x2B84:001 (P704.01)	DC braking: Current	0.0 %	general	U16	10	P	-
0x2B84:002 (P704.02)	DC braking: Automatic hold time	0.0 s	general	U16	10	P	-
0x2B84:003 (P704.03)	DC braking: Automatic operating threshold	0.0 Hz	general	U16	10	P	-
0x2BA1:001 (P718.01)	Flying restart circuit: Current	30 %	MCTRL	U16	1	P	-
0x2BA1:002 (P718.02)	Flying restart circuit: Start frequency	20.0 Hz	MCTRL	I16	10	P	-
0x2BA1:003 (P718.03)	Flying restart circuit: Restart time	5911 ms *	MCTRL	U16	1	P	-
0x2BA1:008 (P718.08)	Flying restart circuit: Flying restart frequency	x.x Hz (Read only)	MCTRL	I16	10	O	t
0x2C00 (P300.00)	Motor control mode	V/f characteristic control (VFC open loop) [6]	general	U8	1	CP	-
0x2C01:001	Motor parameters: Number of pole pairs	- (Read only)	MCTRL	U8	1	-	-
0x2C01:002	Motor parameters: Stator resistance	10.1565 Ω *	MCTRL	U32	10000	P	-
0x2C01:003	Motor parameters: Stator leakage inductance	23.566 mH *	MCTRL	U32	1000	P	-
0x2C01:004 (P320.04)	Motor parameters: Rated speed	1450 rpm	MCTRL	U16	1	P	-
0x2C01:005 (P320.05)	Motor parameters: Rated frequency	50.0 Hz	MCTRL	U16	10	P	-

* Default setting depending on the size.

Firmware version 02.01.01.00



Appendix

Parameter attribute list

Address	Name	Default setting	Category	Data type	Factor	A	M
0x2C01:006 (P320.06)	Motor parameters: Rated power	0.25 kW *	MCTRL	U16	100	P	-
0x2C01:007 (P320.07)	Motor parameters: Rated voltage	230 V *	MCTRL	U16	1	P	-
0x2C01:008 (P320.08)	Motor parameters: Cosine phi	0.80	MCTRL	U16	100	P	-
0x2C01:010	Motor parameters: Motor name		MCTRL	STRING[25]	1	P	-
0x2C02:001 (P351.01)	Motor parameter (ASM): Rotor resistance	8.8944 Ω *	MCTRL	U32	10000	P	-
0x2C02:002 (P351.02)	Motor parameter (ASM): Mutual inductance	381.9 mH *	MCTRL	U32	10	P	-
0x2C02:003 (P351.03)	Motor parameter (ASM): Magnetising current	0.96 A *	MCTRL	U16	100	P	-
0x2C02:004 (P351.04)	Slip frequency	x.x Hz (Read only)	general	U16	10	-	-
0x2C03:001 (P352.01)	EMK constant	41.8 V/1000rpm	MCTRL	U32	10	P	-
0x2C11:001	Lower limit	30 %	general	U16	1	P	-
0x2C11:002	Tracking controller gain	250 %	general	U16	1	P	-
0x2C11:003	Tracking controller reset time	3.30 ms	general	U16	100	P	-
0x2C11:004	Tracking controller decouple time	0.50 ms	general	U16	100	P	-
0x2C12:001	Acceleration current	100 %	MCTRL	U16	1	P	-
0x2C12:002	Standstill current	40 %	MCTRL	U16	1	P	-
0x2D40:002	Device utilisation (i*t): Warning threshold	95 %	general	U16	1	P	-
0x2D40:004 (P135.04)	Device utilisation (i*t)	x % (Read only)	general	U16	1	O	t
0x2D40:005 (P135.05)	Device utilisation (i*t): Error response	Fault [3]	general	U8	1	P	-
0x2D44:001 (P350.01)	Overspeed monitoring: Threshold	8000 rpm	general	U16	1	P	-
0x2D44:002 (P350.02)	Overspeed monitoring: Response	Fault [3]	general	U8	1	P	-
0x2D45:001 (P310.01)	Motor phase failure detection: Response	No response [0]	general	U8	1	P	-
0x2D45:002 (P310.02)	Motor phase failure detection: Current threshold	5.0 %	general	U8	10	P	-
0x2D45:003 (P310.03)	Motor phase failure detection: Voltage threshold	10.0 V	general	U16	10	P	-
0x2D46:001 (P353.01)	Overcurrent monitoring: Threshold	6.8 A *	general	U16	10	P	-
0x2D46:002 (P353.02)	Overcurrent monitoring: Response	Fault [3]	general	U8	1	P	-
0x2D48:001 (P308.01)	Motor overload monitoring (i ² *t): Maximum utilisation [60 s]	150 %	general	U16	1	P	-
0x2D48:002 (P308.02)	Motor overload monitoring (i ² *t): Speed compensation	On [0]	general	U8	1	P	-
0x2D48:003 (P308.03)	Motor overload monitoring (i ² *t): Response	Fault [3]	general	U8	1	P	-
0x2D48:005	Motor overload monitoring (i ² *t): Thermal load	- (Read only)	general	U16	1	-	-
0x2D4F (P123.00)	Motor utilisation (i ² *t)	x % (Read only)	general	U16	1	O	t
0x2D66:001 (P721.01)	Mains failure control: Enable function	Disabled [0]	general	U8	1	P	-
0x2D66:002 (P721.02)	Mains failure control: DC-bus activation level	0 % *	general	U8	1	P	-
0x2D66:003 (P721.03)	Mains failure control: Gain V-controller	0.01000 Hz/V	general	U16	100000	P	-

* Default setting depending on the size.

Firmware version 02.01.01.00

Appendix

Parameter attribute list



Address	Name	Default setting	Category	Data type	Factor	A	M
0x2D66:004 (P721.04)	Mains failure control: Reset time V-controller	20 ms	general	U16	1	P	-
0x2D66:005 (P721.05)	Mains failure control: DC voltage setpoint	100 %	general	U8	1	P	-
0x2D66:006 (P721.06)	Mains failure control: Setpoint ramp	20 ms	general	U16	1	P	-
0x2D66:007 (P721.07)	Mains failure control: Clear time	20 ms	general	U16	1	P	-
0x2D66:008 (P721.08)	Mains failure control: Restart threshold	0.0 Hz	general	U16	10	P	-
0x2D66:009 (P721.09)	Mains failure control: Status mains failure control	- (Read only)	general	U8	1	O	t
0x2D67:001 (P329.01)	Maximum torque monitoring: Response	No reaction [0]	MCTRL	U8	1	P	-
0x2D67:002 (P329.02)	Maximum torque monitoring: Triggering delay	0.000 s	MCTRL	U16	1000	P	-
0x2D81:001 (P151.01)	Life-diagnosis: Operating time	x s (Read only)	general	U32	1	T	-
0x2D81:002 (P151.02)	Life-diagnosis: Operating time	x s (Read only)	general	U32	1	T	-
0x2D81:003 (P151.03)	Life-diagnosis: Control unit operating time	x ns (Read only)	general	U64	1	T	-
0x2D81:004 (P151.04)	Life-diagnosis: Main switching cycles	- (Read only)	general	U32	1	-	-
0x2D81:005 (P151.05)	Life-diagnosis: Relay switching cycles	- (Read only)	general	U32	1	-	-
0x2D81:006 (P151.06)	Life-diagnosis: Short-circuit counter	- (Read only)	general	U16	1	-	-
0x2D81:007 (P151.07)	Life-diagnosis: Earth fault counter	- (Read only)	general	U16	1	-	-
0x2D81:008 (P151.08)	Life-diagnosis: Clamp active	- (Read only)	general	U16	1	-	-
0x2D81:009 (P151.09)	Life-diagnosis: Fan operating time	x s (Read only)	general	U32	1	T	-
0x2D84:001 (P117.01)	Heatsink temperature	x.x °C (Read only)	general	I16	10	O	-
0x2D84:002	Heatsink temperature: Warning threshold	80.0 °C *	general	I16	10	P	-
0x2D87 (P105.00)	DC-bus voltage	x V (Read only)	general	U16	1	O	t
0x2D88 (P104.00)	Motor current	x.x A (Read only)	general	I16	10	O	t
0x2D89 (P106.00)	Motor voltage	x VAC (Read only)	general	U16	1	O	t
0x2DA2:001 (P108.01)	Output power: Effective power	x.xxx kW (Read only)	general	I32	1000	O	t
0x2DA2:002 (P108.02)	Output power: Apparent power	x.xxx kVA (Read only)	general	I32	1000	O	t
0x2DA3:001 (P109.01)	Output energy: Motor	x.xx kWh (Read only)	general	I32	100	O	t
0x2DA3:002 (P109.02)	Output energy: Generator	x.xx kWh (Read only)	general	I32	100	O	t
0x2DA4:001 (P110.01)	Diagnostics of analog input 1: Value in percent	x.x % (Read only)	general	I16	10	O	t
0x2DA4:002 (P110.02)	Diagnostics of analog input 1: Frequency value	x.x Hz (Read only)	general	I16	10	O	t
0x2DA4:003 (P110.03)	Diagnostics of analog input 1: Process controller value	x.xx PID unit (Read only)	general	I16	100	O	t
0x2DA4:004 (P110.04)	Diagnostics of analog input 1: Torque value	x.xx % (Read only)	general	I16	100	O	t

* Default setting depending on the size.

Firmware version 02.01.01.00



Appendix

Parameter attribute list

Address	Name	Default setting	Category	Data type	Factor	A	M
0x2DA4:016 (P110.16)	Diagnostics of analog input 1: Status	- (Read only)	general	U16	1	O	-
0x2DA5:001 (P111.01)	Diagnostics of analog input 2: Value in percent	x.x % (Read only)	general	I16	10	O	t
0x2DA5:002 (P111.02)	Diagnostics of analog input 2: Frequency value	x.x Hz (Read only)	general	I16	10	O	t
0x2DA5:003 (P111.03)	Diagnostics of analog input 2: Process controller value	x.xx PID unit (Read only)	general	I16	100	O	t
0x2DA5:004 (P111.04)	Diagnostics of analog input 2: Torque value	x.xx % (Read only)	general	I16	100	O	t
0x2DA5:016 (P111.16)	Diagnostics of analog input 2: Status	- (Read only)	general	U16	1	O	-
0x2DAA:001 (P112.01)	Diagnostics of analog output 1: Voltage	x.xx V (Read only)	general	U16	100	O	t
0x2DAA:002 (P112.02)	Diagnostics of analog output 1: Current	x.xx mA (Read only)	general	U16	100	O	t
0x2DAC (P119.00)	Keypad status	- (Read only)	general	U16	1	O	t
0x2DAD (P120.00)	Internal hardware states	- (Read only)	general	U16	1	O	-
0x2DDD (P100.00)	Output frequency	x.x Hz (Read only)	general	I16	10	O	t
0x2DDF:001	Axis information: Rated current	x.xx A (Read only)	general	U16	100	O	t
0x2DDF:002	Axis information: Maximum current	x.xx A (Read only)	general	U16	100	O	t
0x2EFF:001	Bootloader activation key 1	0	general	U32	1	C	-
0x2EFF:002	Bootloader activation key 2	0	general	U32	1	C	-
0x2EFF:003	Bootloader activation key 3	0	general	U32	1	C	-
0x4002 (P702.00)	Speed display scaling	0.00	general	U16	100	P	-
0x4003 (P413.00)	MOP starting mode	Last value [0]	general	U8	1	P	-
0x4004:001 (P414.01)	MOP starting values: Frequency	0.0 Hz	general	U16	10	P	-
0x4004:002 (P414.02)	MOP starting values: PID value	0.00 PID unit	general	I16	100	P	-
0x4004:003 (P414.03)	MOP starting values: Torque	0.0 %	general	U16	10	P	-
0x4005 (P412.00)	Frequency threshold	0.0 Hz	general	U16	10	P	-
0x4006:001 (P710.01)	Load loss detection: Threshold	0.0 %	general	U16	10	P	-
0x4006:002 (P710.02)	Load loss detection: Deceleration	0.0 s	general	U16	10	P	-
0x4008:001 (P590.01)	Process input words: NetWordIN1	0x0000	general	U16	1	KH	r
0x4008:002 (P590.02)	Process input words: NetWordIN2	0x0000	general	U16	1	KH	r
0x4008:003 (P590.03)	Process input words: NetWordIN3	0.0 %	general	U16	10	K	r
0x4008:004 (P590.04)	Process input words: NetWordIN4	0.0 %	general	U16	10	K	r
0x4009:001	MOP values saved: Frequency	x.x Hz (Read only)	general	U16	10	CP	t
0x4009:002	MOP values saved: PID value	x.xx PID unit (Read only)	general	U16	100	CP	t
0x4009:003	MOP values saved: Torque	x.x % (Read only)	general	U16	10	CP	t
0x400A:001 (P591.01)	Process output words: NetWordOUT1	- (Read only)	general	U16	1	H	t
0x400A:002 (P591.02)	Process output words: NetWordOUT2	- (Read only)	general	U16	1	-	t

* Default setting depending on the size.

Firmware version 02.01.01.00

Appendix

Parameter attribute list



Address	Name	Default setting	Category	Data type	Factor	A	M
0x400B:001 (P592.01)	Process input data: AC Drive control word	0x0000	general	U16	1	OK H	r
0x400B:002 (P592.02)	Process input data: LECOM control word	0x0000	general	U16	1	OK H	r
0x400B:003 (P592.03)	Process input data: Network setpoint frequency	0.0 Hz	general	U16	10	OK	r
0x400B:004 (P592.04)	Process input data: Network setpoint speed	0 rpm	general	U16	1	OK	r
0x400B:005 (P592.05)	Process input data: Network setpoint frequency	0.00 Hz	general	U16	100	OK	r
0x400B:006 (P592.06)	Process input data: Velocity mode setpoint	0.0 Hz	general	I16	10	OK	r
0x400B:007 (P592.07)	Process input data: PID setpoint	0.00 PID unit	general	I16	100	OK	r
0x400B:008 (P592.08)	Process input data: Torque mode setpoint	0 Nm	general	I16	1	OK	r
0x400B:009 (P592.09)	Process input data: Torque scaling	0	general	I8	1	OK	-
0x400C:001 (P593.01)	Process output data: AC Drive status word	- (Read only)	general	U16	1	-	t
0x400C:002 (P593.02)	Process output data: LECOM status word	- (Read only)	general	U16	1	-	t
0x400C:003 (P593.03)	Process output data: Frequency [0.1 Hz]	x.x Hz (Read only)	general	U16	10	-	t
0x400C:004 (P593.04)	Process output data: Motor speed	x rpm (Read only)	general	U16	1	-	t
0x400C:005 (P593.05)	Process output data: Drive status	- (Read only)	general	U16	1	-	t
0x400C:006 (P593.06)	Process output data: Frequency [0.01 Hz]	x.xx Hz (Read only)	general	U16	100	-	t
0x400C:007 (P593.07)	Process output data: Torque scaled	- (Read only)	general	I16	1	-	t
0x400D (P101.00)	Scaled actual value	x Units (Read only)	general	I16	1	O	t
0x400E:001 (P505.01)	NetWordIN1 function: Bit 0	Not active [0]	general	U8	1	CP	-
0x400E:002 (P505.02)	NetWordIN1 function: Bit 1	Not active [0]	general	U8	1	CP	-
0x400E:003 (P505.03)	NetWordIN1 function: Bit 2	Activate quick stop [3]	general	U8	1	CP	-
0x400E:004 (P505.04)	NetWordIN1 function: Bit 3	Not active [0]	general	U8	1	CP	-
0x400E:005 (P505.05)	NetWordIN1 function: Bit 4	Run forward (CW) [8]	general	U8	1	CP	-
0x400E:006 (P505.06)	NetWordIN1 function: Bit 5	Activate preset (bit 0) [18]	general	U8	1	CP	-
0x400E:007 (P505.07)	NetWordIN1 function: Bit 6	Activate preset (bit 1) [19]	general	U8	1	CP	-
0x400E:008 (P505.08)	NetWordIN1 function: Bit 7	Reset error [4]	general	U8	1	CP	-
0x400E:009 (P505.09)	NetWordIN1 function: Bit 8	Not active [0]	general	U8	1	CP	-
0x400E:010 (P505.10)	NetWordIN1 function: Bit 9	Activate DC braking [5]	general	U8	1	CP	-
0x400E:011 (P505.11)	NetWordIN1 function: Bit 10	Not active [0]	general	U8	1	CP	-
0x400E:012 (P505.12)	NetWordIN1 function: Bit 11	Not active [0]	general	U8	1	CP	-

* Default setting depending on the size.

Firmware version 02.01.01.00



Appendix

Parameter attribute list

Address	Name	Default setting	Category	Data type	Factor	A	M
0x400E:013 (P505.13)	NetWordIN1 function: Bit 12	Invert rotation [13]	general	U8	1	CP	-
0x400E:014 (P505.14)	NetWordIN1 function: Bit 13	Not active [0]	general	U8	1	CP	-
0x400E:015 (P505.15)	NetWordIN1 function: Bit 14	Not active [0]	general	U8	1	CP	-
0x400E:016 (P505.16)	NetWordIN1 function: Bit 15	Not active [0]	general	U8	1	CP	-
0x4016:003	Digital output 1: Cutout delay	0.020 s	general	U16	1000	P	-
0x4016:004	Digital output 1: Switch-on delay	0.020 s	general	U16	1000	P	-
0x4016:005	Digital output 1: Terminal state	- (Read only)	general	U8	1	-	-
0x4016:006	Digital output 1: Trigger signal state	- (Read only)	general	U8	1	-	-
0x4018:003	Relay: Switch-off delay	0.020 s	general	U16	1000	P	-
0x4018:004	Relay: Switch-on delay	0.020 s	general	U16	1000	P	-
0x4018:005	Relay: Relay state	- (Read only)	general	U8	1	-	-
0x4018:006	Relay: Trigger signal state	- (Read only)	general	U8	1	-	-
0x4018:007	Relay: Switching cycles	- (Read only)	general	U32	1	-	-
0x401F:001 (P121.01)	Process controller diagnostics: Current setpoint	x.xx PID unit (Read only)	general	I16	100	O	t
0x401F:002 (P121.02)	Process controller diagnostics: Current process variable	x.xx PID unit (Read only)	general	I16	100	O	t
0x401F:003 (P121.03)	Process controller diagnostics: Status	- (Read only)	general	U8	1	O	t
0x4020:001 (P600.01)	Process controller: Operating mode	Inhibited [0]	general	U8	1	P	-
0x4020:002 (P600.02)	Process controller: PID process variable	Analog input 1 [1]	general	U8	1	P	-
0x4020:003 (P600.03)	Process controller: Closed-loop controlled speed range	100 %	general	U16	1	P	-
0x4020:004 (P600.04)	Process controller: Speed feedforward control source	Without speed addition [0]	general	U8	1	P	-
0x4021:001 (P606.01)	PID speed operation: Acceleration time	1.0 s	general	U16	10	P	-
0x4021:002 (P606.02)	PID speed operation: Deceleration time	1.0 s	general	U16	10	P	-
0x4022:001 (P451.01)	PID setpoint presets: Preset 1	0.00 PID unit	general	I16	100	P	-
0x4022:002 (P451.02)	PID setpoint presets: Preset 2	0.00 PID unit	general	I16	100	P	-
0x4022:003 (P451.03)	PID setpoint presets: Preset 3	0.00 PID unit	general	I16	100	P	-
0x4022:004 (P451.04)	PID setpoint presets: Preset 4	0.00 PID unit	general	I16	100	P	-
0x4022:005 (P451.05)	PID setpoint presets: Preset 5	0.00 PID unit	general	I16	100	P	-
0x4022:006 (P451.06)	PID setpoint presets: Preset 6	0.00 PID unit	general	I16	100	P	-
0x4022:007 (P451.07)	PID setpoint presets: Preset 7	0.00 PID unit	general	I16	100	P	-
0x4022:008 (P451.08)	PID setpoint presets: Preset 8	0.00 PID unit	general	I16	100	P	-
0x4023:001 (P610.01)	PID sleep mode: Activation	Disabled [0]	general	U8	1	P	-
0x4023:002 (P610.02)	PID sleep mode: Stop method	Coasting [0]	general	U8	1	P	-
0x4023:003 (P610.03)	PID sleep mode: Frequency threshold	0.0 Hz	general	U16	10	P	-

* Default setting depending on the size.

Firmware version 02.01.01.00

Appendix

Parameter attribute list



Address	Name	Default setting	Category	Data type	Factor	A	M
0x4023:004 (P610.04)	PID sleep mode: Feedback threshold	0.00 PID unit	general	I16	100	P	-
0x4023:005 (P610.05)	PID sleep mode: Delay time	0.0 s	general	U16	10	P	-
0x4023:006 (P610.06)	PID sleep mode: Recovery	Setpoint > threshold OR system deviation > band- width [0]	general	U8	1	P	-
0x4023:007 (P610.07)	PID sleep mode: Bandwidth	0.00 PID unit	general	U16	100	P	-
0x4023:008 (P610.08)	PID sleep mode: Recovery threshold	0.00 PID unit	general	I16	100	P	-
0x4024:001 (P615.01)	Automatic rinsing: Rinsing in idle state	Inhibited [0]	general	U8	1	P	-
0x4024:002 (P615.02)	Automatic rinsing: Rinse interval	30.0 min	general	U16	10	P	-
0x4024:003 (P615.03)	Automatic rinsing: Rinse speed	0.0 Hz	general	I16	10	P	-
0x4024:004 (P615.04)	Automatic rinsing: Rinse period	0.0 s	general	U16	10	P	-
0x4041:001 (P750.01)	Parameter change-over: Parameter 1	0x00000000	general	IDX	1	PH	-
0x4041:002 (P750.02)	Parameter change-over: Parameter 2	0x00000000	general	IDX	1	PH	-
0x4041:003 (P750.03)	Parameter change-over: Parameter 3	0x00000000	general	IDX	1	PH	-
0x4041:004 (P750.04)	Parameter change-over: Parameter 4	0x00000000	general	IDX	1	PH	-
0x4041:005 (P750.05)	Parameter change-over: Parameter 5	0x00000000	general	IDX	1	PH	-
0x4041:006 (P750.06)	Parameter change-over: Parameter 6	0x00000000	general	IDX	1	PH	-
0x4041:007 (P750.07)	Parameter change-over: Parameter 7	0x00000000	general	IDX	1	PH	-
0x4041:008 (P750.08)	Parameter change-over: Parameter 8	0x00000000	general	IDX	1	PH	-
0x4041:009 (P750.09)	Parameter change-over: Parameter 9	0x00000000	general	IDX	1	PH	-
0x4041:010 (P750.10)	Parameter change-over: Parameter 10	0x00000000	general	IDX	1	PH	-
0x4041:011 (P750.11)	Parameter change-over: Parameter 11	0x00000000	general	IDX	1	PH	-
0x4041:012 (P750.12)	Parameter change-over: Parameter 12	0x00000000	general	IDX	1	PH	-
0x4041:013 (P750.13)	Parameter change-over: Parameter 13	0x00000000	general	IDX	1	PH	-
0x4041:014 (P750.14)	Parameter change-over: Parameter 14	0x00000000	general	IDX	1	PH	-
0x4041:015 (P750.15)	Parameter change-over: Parameter 15	0x00000000	general	IDX	1	PH	-
0x4041:016 (P750.16)	Parameter change-over: Parameter 16	0x00000000	general	IDX	1	PH	-
0x4041:017 (P750.17)	Parameter change-over: Parameter 17	0x00000000	general	IDX	1	PH	-
0x4041:018 (P750.18)	Parameter change-over: Parameter 18	0x00000000	general	IDX	1	PH	-
0x4041:019 (P750.19)	Parameter change-over: Parameter 19	0x00000000	general	IDX	1	PH	-
0x4041:020 (P750.20)	Parameter change-over: Parameter 20	0x00000000	general	IDX	1	PH	-
* Default setting depending on the size.					Firmware version 02.01.01.00		



Appendix

Parameter attribute list

Address	Name	Default setting	Category	Data type	Factor	A	M
0x4041:021 (P750.21)	Parameter change-over: Parameter 21	0x00000000	general	IDX	1	PH	-
0x4041:022 (P750.22)	Parameter change-over: Parameter 22	0x00000000	general	IDX	1	PH	-
0x4041:023 (P750.23)	Parameter change-over: Parameter 23	0x00000000	general	IDX	1	PH	-
0x4041:024 (P750.24)	Parameter change-over: Parameter 24	0x00000000	general	IDX	1	PH	-
0x4041:025 (P750.25)	Parameter change-over: Parameter 25	0x00000000	general	IDX	1	PH	-
0x4041:026 (P750.26)	Parameter change-over: Parameter 26	0x00000000	general	IDX	1	PH	-
0x4041:027 (P750.27)	Parameter change-over: Parameter 27	0x00000000	general	IDX	1	PH	-
0x4041:028 (P750.28)	Parameter change-over: Parameter 28	0x00000000	general	IDX	1	PH	-
0x4041:029 (P750.29)	Parameter change-over: Parameter 29	0x00000000	general	IDX	1	PH	-
0x4041:030 (P750.30)	Parameter change-over: Parameter 30	0x00000000	general	IDX	1	PH	-
0x4041:031 (P750.31)	Parameter change-over: Parameter 31	0x00000000	general	IDX	1	PH	-
0x4041:032 (P750.32)	Parameter change-over: Parameter 32	0x00000000	general	IDX	1	PH	-
0x4042:001 (P751.01)	Parameter value set 1: Value of parameter 1	0	general	I32	1	P	-
0x4042:002 (P751.02)	Parameter value set 1: Value of parameter 2	0	general	I32	1	P	-
0x4042:003 (P751.03)	Parameter value set 1: Value of parameter 3	0	general	I32	1	P	-
0x4042:004 (P751.04)	Parameter value set 1: Value of parameter 4	0	general	I32	1	P	-
0x4042:005 (P751.05)	Parameter value set 1: Value of parameter 5	0	general	I32	1	P	-
0x4042:006 (P751.06)	Parameter value set 1: Value of parameter 6	0	general	I32	1	P	-
0x4042:007 (P751.07)	Parameter value set 1: Value of parameter 7	0	general	I32	1	P	-
0x4042:008 (P751.08)	Parameter value set 1: Value of parameter 8	0	general	I32	1	P	-
0x4042:009 (P751.09)	Parameter value set 1: Value of parameter 9	0	general	I32	1	P	-
0x4042:010 (P751.10)	Parameter value set 1: Value of parameter 10	0	general	I32	1	P	-
0x4042:011 (P751.11)	Parameter value set 1: Value of parameter 11	0	general	I32	1	P	-
0x4042:012 (P751.12)	Parameter value set 1: Value of parameter 12	0	general	I32	1	P	-
0x4042:013 (P751.13)	Parameter value set 1: Value of parameter 13	0	general	I32	1	P	-
0x4042:014 (P751.14)	Parameter value set 1: Value of parameter 14	0	general	I32	1	P	-
0x4042:015 (P751.15)	Parameter value set 1: Value of parameter 15	0	general	I32	1	P	-
0x4042:016 (P751.16)	Parameter value set 1: Value of parameter 16	0	general	I32	1	P	-
0x4042:017 (P751.17)	Parameter value set 1: Value of parameter 17	0	general	I32	1	P	-
* Default setting depending on the size.					Firmware version 02.01.01.00		

Appendix

Parameter attribute list



Address	Name	Default setting	Category	Data type	Factor	A	M
0x4042:018 (P751.18)	Parameter value set 1: Value of parameter 18	0	general	l32	1	P	-
0x4042:019 (P751.19)	Parameter value set 1: Value of parameter 19	0	general	l32	1	P	-
0x4042:020 (P751.20)	Parameter value set 1: Value of parameter 20	0	general	l32	1	P	-
0x4042:021 (P751.21)	Parameter value set 1: Value of parameter 21	0	general	l32	1	P	-
0x4042:022 (P751.22)	Parameter value set 1: Value of parameter 22	0	general	l32	1	P	-
0x4042:023 (P751.23)	Parameter value set 1: Value of parameter 23	0	general	l32	1	P	-
0x4042:024 (P751.24)	Parameter value set 1: Value of parameter 24	0	general	l32	1	P	-
0x4042:025 (P751.25)	Parameter value set 1: Value of parameter 25	0	general	l32	1	P	-
0x4042:026 (P751.26)	Parameter value set 1: Value of parameter 26	0	general	l32	1	P	-
0x4042:027 (P751.27)	Parameter value set 1: Value of parameter 27	0	general	l32	1	P	-
0x4042:028 (P751.28)	Parameter value set 1: Value of parameter 28	0	general	l32	1	P	-
0x4042:029 (P751.29)	Parameter value set 1: Value of parameter 29	0	general	l32	1	P	-
0x4042:030 (P751.30)	Parameter value set 1: Value of parameter 30	0	general	l32	1	P	-
0x4042:031 (P751.31)	Parameter value set 1: Value of parameter 31	0	general	l32	1	P	-
0x4042:032 (P751.32)	Parameter value set 1: Value of parameter 32	0	general	l32	1	P	-
0x4043:001 (P752.01)	Parameter value set 2: Value of parameter 1	0	general	l32	1	P	-
0x4043:002 (P752.02)	Parameter value set 2: Value of parameter 2	0	general	l32	1	P	-
0x4043:003 (P752.03)	Parameter value set 2: Value of parameter 3	0	general	l32	1	P	-
0x4043:004 (P752.04)	Parameter value set 2: Value of parameter 4	0	general	l32	1	P	-
0x4043:005 (P752.05)	Parameter value set 2: Value of parameter 5	0	general	l32	1	P	-
0x4043:006 (P752.06)	Parameter value set 2: Value of parameter 6	0	general	l32	1	P	-
0x4043:007 (P752.07)	Parameter value set 2: Value of parameter 7	0	general	l32	1	P	-
0x4043:008 (P752.08)	Parameter value set 2: Value of parameter 8	0	general	l32	1	P	-
0x4043:009 (P752.09)	Parameter value set 2: Value of parameter 9	0	general	l32	1	P	-
0x4043:010 (P752.10)	Parameter value set 2: Value of parameter 10	0	general	l32	1	P	-
0x4043:011 (P752.11)	Parameter value set 2: Value of parameter 11	0	general	l32	1	P	-
0x4043:012 (P752.12)	Parameter value set 2: Value of parameter 12	0	general	l32	1	P	-
0x4043:013 (P752.13)	Parameter value set 2: Value of parameter 13	0	general	l32	1	P	-
0x4043:014 (P752.14)	Parameter value set 2: Value of parameter 14	0	general	l32	1	P	-
* Default setting depending on the size.					Firmware version 02.01.01.00		



Appendix

Parameter attribute list

Address	Name	Default setting	Category	Data type	Factor	A	M
0x4043:015 (P752.15)	Parameter value set 2: Value of parameter 15	0	general	l32	1	P	-
0x4043:016 (P752.16)	Parameter value set 2: Value of parameter 16	0	general	l32	1	P	-
0x4043:017 (P752.17)	Parameter value set 2: Value of parameter 17	0	general	l32	1	P	-
0x4043:018 (P752.18)	Parameter value set 2: Value of parameter 18	0	general	l32	1	P	-
0x4043:019 (P752.19)	Parameter value set 2: Value of parameter 19	0	general	l32	1	P	-
0x4043:020 (P752.20)	Parameter value set 2: Value of parameter 20	0	general	l32	1	P	-
0x4043:021 (P752.21)	Parameter value set 2: Value of parameter 21	0	general	l32	1	P	-
0x4043:022 (P752.22)	Parameter value set 2: Value of parameter 22	0	general	l32	1	P	-
0x4043:023 (P752.23)	Parameter value set 2: Value of parameter 23	0	general	l32	1	P	-
0x4043:024 (P752.24)	Parameter value set 2: Value of parameter 24	0	general	l32	1	P	-
0x4043:025 (P752.25)	Parameter value set 2: Value of parameter 25	0	general	l32	1	P	-
0x4043:026 (P752.26)	Parameter value set 2: Value of parameter 26	0	general	l32	1	P	-
0x4043:027 (P752.27)	Parameter value set 2: Value of parameter 27	0	general	l32	1	P	-
0x4043:028 (P752.28)	Parameter value set 2: Value of parameter 28	0	general	l32	1	P	-
0x4043:029 (P752.29)	Parameter value set 2: Value of parameter 29	0	general	l32	1	P	-
0x4043:030 (P752.30)	Parameter value set 2: Value of parameter 30	0	general	l32	1	P	-
0x4043:031 (P752.31)	Parameter value set 2: Value of parameter 31	0	general	l32	1	P	-
0x4043:032 (P752.32)	Parameter value set 2: Value of parameter 32	0	general	l32	1	P	-
0x4044:001 (P753.01)	Parameter value set 3: Value of parameter 1	0	general	l32	1	P	-
0x4044:002 (P753.02)	Parameter value set 3: Value of parameter 2	0	general	l32	1	P	-
0x4044:003 (P753.03)	Parameter value set 3: Value of parameter 3	0	general	l32	1	P	-
0x4044:004 (P753.04)	Parameter value set 3: Value of parameter 4	0	general	l32	1	P	-
0x4044:005 (P753.05)	Parameter value set 3: Value of parameter 5	0	general	l32	1	P	-
0x4044:006 (P753.06)	Parameter value set 3: Value of parameter 6	0	general	l32	1	P	-
0x4044:007 (P753.07)	Parameter value set 3: Value of parameter 7	0	general	l32	1	P	-
0x4044:008 (P753.08)	Parameter value set 3: Value of parameter 8	0	general	l32	1	P	-
0x4044:009 (P753.09)	Parameter value set 3: Value of parameter 9	0	general	l32	1	P	-
0x4044:010 (P753.10)	Parameter value set 3: Value of parameter 10	0	general	l32	1	P	-
0x4044:011 (P753.11)	Parameter value set 3: Value of parameter 11	0	general	l32	1	P	-

* Default setting depending on the size.

Firmware version 02.01.01.00

Appendix

Parameter attribute list



Address	Name	Default setting	Category	Data type	Factor	A	M
0x4044:012 (P753.12)	Parameter value set 3: Value of parameter 12	0	general	l32	1	P	-
0x4044:013 (P753.13)	Parameter value set 3: Value of parameter 13	0	general	l32	1	P	-
0x4044:014 (P753.14)	Parameter value set 3: Value of parameter 14	0	general	l32	1	P	-
0x4044:015 (P753.15)	Parameter value set 3: Value of parameter 15	0	general	l32	1	P	-
0x4044:016 (P753.16)	Parameter value set 3: Value of parameter 16	0	general	l32	1	P	-
0x4044:017 (P753.17)	Parameter value set 3: Value of parameter 17	0	general	l32	1	P	-
0x4044:018 (P753.18)	Parameter value set 3: Value of parameter 18	0	general	l32	1	P	-
0x4044:019 (P753.19)	Parameter value set 3: Value of parameter 19	0	general	l32	1	P	-
0x4044:020 (P753.20)	Parameter value set 3: Value of parameter 20	0	general	l32	1	P	-
0x4044:021 (P753.21)	Parameter value set 3: Value of parameter 21	0	general	l32	1	P	-
0x4044:022 (P753.22)	Parameter value set 3: Value of parameter 22	0	general	l32	1	P	-
0x4044:023 (P753.23)	Parameter value set 3: Value of parameter 23	0	general	l32	1	P	-
0x4044:024 (P753.24)	Parameter value set 3: Value of parameter 24	0	general	l32	1	P	-
0x4044:025 (P753.25)	Parameter value set 3: Value of parameter 25	0	general	l32	1	P	-
0x4044:026 (P753.26)	Parameter value set 3: Value of parameter 26	0	general	l32	1	P	-
0x4044:027 (P753.27)	Parameter value set 3: Value of parameter 27	0	general	l32	1	P	-
0x4044:028 (P753.28)	Parameter value set 3: Value of parameter 28	0	general	l32	1	P	-
0x4044:029 (P753.29)	Parameter value set 3: Value of parameter 29	0	general	l32	1	P	-
0x4044:030 (P753.30)	Parameter value set 3: Value of parameter 30	0	general	l32	1	P	-
0x4044:031 (P753.31)	Parameter value set 3: Value of parameter 31	0	general	l32	1	P	-
0x4044:032 (P753.32)	Parameter value set 3: Value of parameter 32	0	general	l32	1	P	-
0x4045:001 (P754.01)	Parameter value set 4: Value of parameter 1	0	general	l32	1	P	-
0x4045:002 (P754.02)	Parameter value set 4: Value of parameter 2	0	general	l32	1	P	-
0x4045:003 (P754.03)	Parameter value set 4: Value of parameter 3	0	general	l32	1	P	-
0x4045:004 (P754.04)	Parameter value set 4: Value of parameter 4	0	general	l32	1	P	-
0x4045:005 (P754.05)	Parameter value set 4: Value of parameter 5	0	general	l32	1	P	-
0x4045:006 (P754.06)	Parameter value set 4: Value of parameter 6	0	general	l32	1	P	-
0x4045:007 (P754.07)	Parameter value set 4: Value of parameter 7	0	general	l32	1	P	-
0x4045:008 (P754.08)	Parameter value set 4: Value of parameter 8	0	general	l32	1	P	-
* Default setting depending on the size.					Firmware version 02.01.01.00		



Appendix

Parameter attribute list

Address	Name	Default setting	Category	Data type	Factor	A	M
0x4045:009 (P754.09)	Parameter value set 4: Value of parameter 9	0	general	I32	1	P	-
0x4045:010 (P754.10)	Parameter value set 4: Value of parameter 10	0	general	I32	1	P	-
0x4045:011 (P754.11)	Parameter value set 4: Value of parameter 11	0	general	I32	1	P	-
0x4045:012 (P754.12)	Parameter value set 4: Value of parameter 12	0	general	I32	1	P	-
0x4045:013 (P754.13)	Parameter value set 4: Value of parameter 13	0	general	I32	1	P	-
0x4045:014 (P754.14)	Parameter value set 4: Value of parameter 14	0	general	I32	1	P	-
0x4045:015 (P754.15)	Parameter value set 4: Value of parameter 15	0	general	I32	1	P	-
0x4045:016 (P754.16)	Parameter value set 4: Value of parameter 16	0	general	I32	1	P	-
0x4045:017 (P754.17)	Parameter value set 4: Value of parameter 17	0	general	I32	1	P	-
0x4045:018 (P754.18)	Parameter value set 4: Value of parameter 18	0	general	I32	1	P	-
0x4045:019 (P754.19)	Parameter value set 4: Value of parameter 19	0	general	I32	1	P	-
0x4045:020 (P754.20)	Parameter value set 4: Value of parameter 20	0	general	I32	1	P	-
0x4045:021 (P754.21)	Parameter value set 4: Value of parameter 21	0	general	I32	1	P	-
0x4045:022 (P754.22)	Parameter value set 4: Value of parameter 22	0	general	I32	1	P	-
0x4045:023 (P754.23)	Parameter value set 4: Value of parameter 23	0	general	I32	1	P	-
0x4045:024 (P754.24)	Parameter value set 4: Value of parameter 24	0	general	I32	1	P	-
0x4045:025 (P754.25)	Parameter value set 4: Value of parameter 25	0	general	I32	1	P	-
0x4045:026 (P754.26)	Parameter value set 4: Value of parameter 26	0	general	I32	1	P	-
0x4045:027 (P754.27)	Parameter value set 4: Value of parameter 27	0	general	I32	1	P	-
0x4045:028 (P754.28)	Parameter value set 4: Value of parameter 28	0	general	I32	1	P	-
0x4045:029 (P754.29)	Parameter value set 4: Value of parameter 29	0	general	I32	1	P	-
0x4045:030 (P754.30)	Parameter value set 4: Value of parameter 30	0	general	I32	1	P	-
0x4045:031 (P754.31)	Parameter value set 4: Value of parameter 31	0	general	I32	1	P	-
0x4045:032 (P754.32)	Parameter value set 4: Value of parameter 32	0	general	I32	1	P	-
0x4046 (P755.00)	Activation of parameter set	Via command (disable required) [0]	general	U8	1	P	-
0x4047:001 (P756.01)	Parameter change-over error message: Status	- (Read only)	general	U16	1	-	-
0x4047:002 (P756.02)	Parameter change-over error message: List entry	- (Read only)	general	U8	1	-	-
0x4048 (P601.00)	PID P-component	5.0 %	general	U16	10	P	-
0x4049 (P602.00)	PID I- component	400 ms	general	U16	1	P	-

* Default setting depending on the size.

Firmware version 02.01.01.00

Appendix

Parameter attribute list



Address	Name	Default setting	Category	Data type	Factor	A	M
0x404A (P603.00)	PID D-component	0.0 s	general	U8	10	P	-
0x404B (P604.00)	PID setpoint ramp	20.0 s	general	U16	10	P	-
0x404C:001 (P607.01)	PID influence: Acceleration time for showing	5.0 s	general	U16	10	P	-
0x404C:002 (P607.02)	PID influence: Deceleration time for masking out	5.0 s	general	U16	10	P	-
0x404D:001 (P608.01)	PID alarms: MIN alarm threshold	0.00 PID unit	general	I16	100	P	-
0x404D:002 (P608.02)	PID alarms: MAX alarm threshold	100.00 PID unit	general	I16	100	P	-
0x404E:001 (P605.01)	PID setpoint limits: Minimum setpoint	-300.00 PID unit	general	I16	100	P	-
0x404E:002 (P605.02)	PID setpoint limits: Maximum setpoint	300.00 PID unit	general	I16	100	P	-
0x603F (P150.00)	Error code	- (Read only)	general	U16	1	O	t
0x6040	CiA: Controlword	0	general	U16	1	O	r
0x6041 (P780.00)	CiA: Statusword	- (Read only)	general	U16	1	O	t
0x6042 (P781.00)	Target velocity	0 rpm	general	I16	1	OK	r
0x6043 (P782.00)	Velocity demand	x rpm (Read only)	general	I16	1	O	t
0x6044 (P783.00)	Velocity actual value	x rpm (Read only)	general	I16	1	O	t
0x6046:001 (P784.01)	Velocity min max amount: Velocity min amount	0 rpm	general	U32	1	P	r
0x6046:002 (P784.02)	Velocity min max amount: Velocity max amount	2147483647 rpm	general	U32	1	P	r
0x6048:001 (P785.01)	Velocity acceleration: Delta speed	3000 rpm	general	U32	1	PO	r
0x6048:002 (P785.02)	Velocity acceleration: Delta time	10 s	general	U16	1	PO	r
0x6049:001 (P786.01)	Velocity deceleration: Delta speed	3000 rpm	general	U32	1	PO	r
0x6049:002 (P786.02)	Velocity deceleration: Delta time	10 s	general	U16	1	PO	r
0x605A	Quick stop option code	Quick stop ramp -> switch-on inhibited [2]	general	I16	1	P	-
0x6060 (P301.00)	Modes of operation	MS: Velocity mode [-2]	general	I8	1	CP O	r
0x6061 (P788.00)	Modes of operation display	- (Read only)	general	I8	1	O	t
0x6071	Target torque	0.0 %	general	I16	10	OK	r
0x6072 (P326.00)	Max torque	250.0 %	general	U16	10	PO	r
0x6073 (P324.00)	Max current	200.0 %	general	U16	10	P	-
0x6074	Torque demand value	x.x % (Read only)	MCTRL	I16	10	O	-
0x6075 (P323.00)	Motor rated current	1.700 A *	MCTRL	U32	1000	CP	-
0x6076 (P325.00)	Motor rated torque	1.650 Nm *	MCTRL	U32	1000	CP	-
0x6077 (P107.00)	Torque actual value	x.x % (Read only)	general	I16	10	O	t
0x6078 (P103.00)	Current actual value	x.x % (Read only)	general	I16	10	O	t

* Default setting depending on the size.

Firmware version 02.01.01.00



Appendix

Parameter attribute list

Address	Name	Default setting	Category	Data type	Factor	A	M
0x6079	DC link circuit voltage	x.xxx V (Read only)	general	U32	1000	O	t
0x6080 (P322.00)	Max motor speed	6075 rpm	general	U32	1	PO	r
0x6085 (P790.00)	Quick stop deceleration	546000 pos. unit/s²	general	U32	1	P	-
0x60E0	Positive torque limit	250.0 %	general	U16	10	P	r
0x60E1	Negative torque limit	250.0 %	general	U16	10	P	r
0x60FD (P118.00)	Digital inputs	- (Read only)	general	U32	1	O	t
0x6402	Motor type	Squirrel cage induction [7]	MCTRL	U16	1	P	-
0x6502 (P789.00)	Supported drive modes	- (Read only)	general	U32	1	-	-
* Default setting depending on the size.					Firmware version 02.01.01.00		

🏢 Lenze Drives GmbH
Postfach 10 13 52, D-31763 Hameln
Breslauer Straße 3, D-32699 Extertal
Germany
HR Lemgo B 6478
☎ +49 5154 82-0
📠 +49 5154 82-2800
@ lenze@lenze.com
🌐 www.lenze.com

✂ Lenze Service GmbH
Breslauer Straße 3, D-32699 Extertal
Germany
☎ 0080002446877 (24 h helpline)
📠 +49 5154 82-1112
@ service.de@lenze.com

S20160609P20160112

