



i500

Inverter i550-Cabinet

Use in UL approved systems

4 ... 30 hp

Mounting and switch-on instructions

This page intentionally left blank!

Contents

1	General information	4
1.1	Read first, then start	4
1.2	Notations and conventions	4
1.2.1	Product code	4
2	Safety instructions	5
2.1	Basic safety measures	5
2.2	Residual hazards	6
2.3	Application as directed	6
3	Product description	7
4	Mounting	8
4.1	Important notes	8
4.2	Mechanical installation	9
4.3	Electrical installation	12
4.3.1	Important notes	12
4.3.2	3-phase mains connection 480 V	13
4.3.2.1	Fusing and terminal data	15
4.3.3	CANopen	17
4.3.4	Modbus	18
4.3.5	PROFIBUS	19
4.3.6	EtherCAT	20
4.3.7	EtherNet/IP	21
4.3.8	PROFINET	22
4.3.9	Connection of the safety module	23
4.3.9.1	Important notes	23
4.3.9.2	Connection plan	24
4.3.9.3	Terminal data	24
5	Commissioning	25
5.1	Important notes	25
5.2	Before initial switch-on	25
5.3	Initial switch-on / functional test with terminal control	26
6	Technical data	28
6.1	Standards and operating conditions	28
6.2	3-phase mains connection 480 V	30
6.2.1	Rated data	30

1 General information

Read first, then start

1 General information

1.1 Read first, then start

WARNING!

Read this documentation thoroughly before carrying out the installation and commissioning.

- ▶ Please observe the safety instructions!



Information and tools with regard to the Lenze products can be found on the Internet:

<http://www.lenze.com> → Download

1.2 Notations and conventions

1.2.1 Product code

In tables, the first 9 digits of the corresponding product code are used to identify the products:

Example: Inverter i550 Cabinet, 11 kW, 3-phase, 400 V STO safety function, IP20, integrated RFI filter		Invertercode												
		I	5	5	A	E	311	F	1	A	0	1	0001S	
Meaning														
Product type	Inverter	I												
Product family	i500		5											
Product	i510			1										
	i550			5										
Product generation	Generation 1				A									
Mounting type	Control cabinet mounting					E								
Rated power [W] (Examples)	0.25 kW						125							
	0.55 kW						155							
	2.2 kW						222							
	3.0 kW						230							
	15 kW						315							
	30 kW						330							
Mains voltage and connection type	1/N/PE AC 230/240 V								B					
	1/N/PE AC 230/240 V								D					
	3/PE AC 230/240 V													
	3/PE AC 400 V								F					
	3/PE AC 480 V													
Motor connections	Single axis									1				
Integrated functional safety	Without										0			
	Safety function STO										A			
Type of protection	IP20											0		
	IP20, coated											V		
Interference suppression	Without												0	
	Integrated RFI filter												1	
Design types	Internal encryption													0001S

2 Safety instructions

2.1 Basic safety measures

Disregarding the following basic safety measures may lead to severe personal injury and damage to material assets!

The product

- must only be used as directed.
- must never be commissioned if they display signs of damage.
- must never be technically modified.
- must never be commissioned if they are not fully mounted.
- must never be operated without required covers.

Connect/disconnect all pluggable terminals only in deenergised condition.

Only remove the product from the installation in the deenergised state.

Insulation resistance tests between 24V control potential and PE: According to EN 61800–5–1, the maximum test voltage must not exceed 110 V DC.

Observe all specifications of the corresponding documentation supplied. This is the precondition for safe and trouble-free operation and for obtaining the product features specified.

The procedural notes and circuit details described in this document are only proposals. It is up to the user to check whether they can be adapted to the particular applications. Lenze does not take any responsibility for the suitability of the procedures and circuit proposals described.

The product must only be used by qualified personnel. IEC 60364 or CENELEC HD 384 define the skills of these persons:

- They are familiar with installing, mounting, commissioning, and operating the product.
- They have the corresponding qualifications for their work.
- They know and can apply all regulations for the prevention of accidents, directives, and laws applicable at the place of use.

Observe the specific notes in the other chapters!





2.2 Residual hazards

The user must take the residual hazards mentioned into consideration in the risk assessment for his/her machine/system.

If the above is disregarded, this can lead to severe injuries to persons and damage to material assets!

Product

Observe the warning labels on the product!

Icon	Description
	Electrostatic sensitive devices: Before working on the inverter, the staff must ensure to be free of electrostatic charge!
	Dangerous electrical voltage Before working on the inverter, check whether all power connections are dead! After mains OFF, power connections X100 and X105 carry a dangerous electrical voltage for the time specified on the inverter!
	High leakage current: Carry out fixed installation and PE connection in compliance with EN 61800-5-1 or EN 60204-1 !
	Hot surface: Use personal protective equipment or wait until devices have cooled down!

Motor

If there is a short circuit of two power transistors, a residual movement of up to 180°/number of pole pairs can occur at the motor! (For 4-pole motor: residual movement max. $180^\circ/2 = 90^\circ$).

This residual movement must be taken into consideration by the user for his/her risk assessment.

2.3 Application as directed

- The product must only be operated under the operating conditions prescribed in this documentation.
- The product meets the protection requirements of 2014/35/EU: Low-Voltage Directive.
- The product is not a machine in terms of 2006/42/EC: Machinery Directive.
- Commissioning or starting the operation as directed of a machine with the product is not permitted until it has been ensured that the machine meets the regulations of the EC Directive 2006/42/EC: Machinery Directive; observe EN 60204-1.
- Commissioning or starting the operation as directed is only allowed when there is compliance with the EMC Directive 2014/30/EU.
- The harmonised standard EN 61800-5-1 is used for the inverters.
- The product is not a household appliance, but is only designed as component for commercial or professional use in terms of EN 61000-3-2.
- In accordance with EN 61800-3, the product can be used in drive systems that have to comply with the categories given in the technical data.

In residential areas, the product may cause EMC interferences. The operator is responsible for taking interference suppression measures.

3 Product description

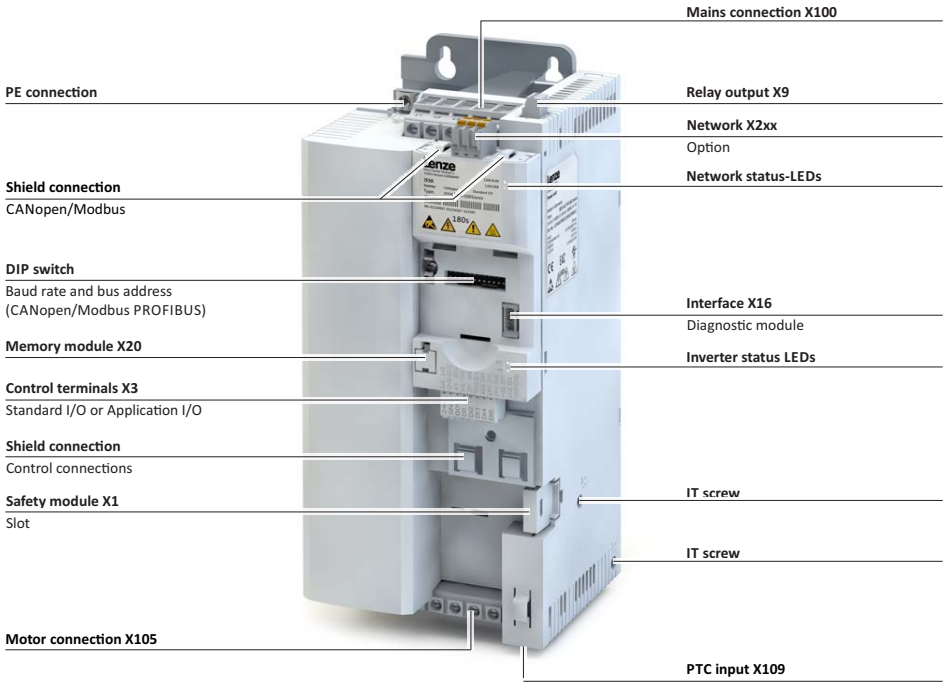

4 Mounting

Important notes

4 Mounting

4.1 Important notes

DANGER!

Dangerous electrical voltage

Possible consequence: death or severe injuries

- ▶ All works on the inverter must only be carried out in the deenergised state.
 - ▶ After switching off the mains voltage, wait for at least 3 minutes before you start working.
-

NOTICE!

- ▶ Modular construction - A complete drive consists of a power unit series no. I5D in combination with a control unit series no. I5C only.
 - ▶ -----
 - ▶ Conception modulaire – Le système d'entraînement complet comprend un module d'alimentation de série I5D, impérativement associé à une unité de commande de série I5C.
-

4.2 Mechanical installation
Dimensions i55AE 4 hp ... 7.5 hp

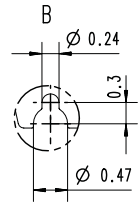
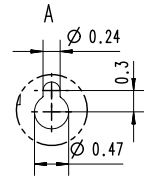
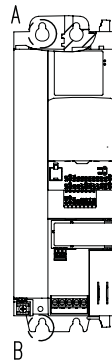
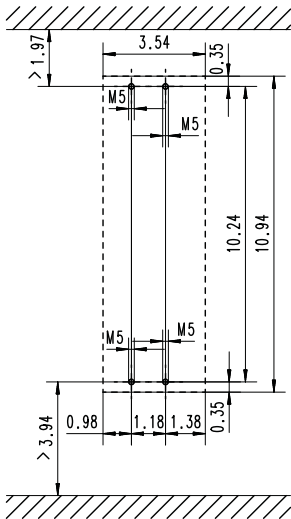
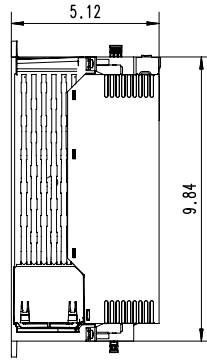
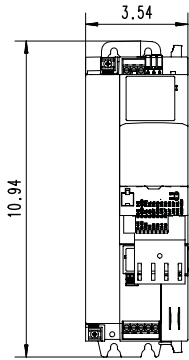

8800302

All Dimensions in inch

4 **Mounting**
Mechanical installation

Dimensions i55AE 10 hp ... 15 hp

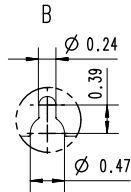
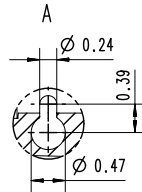
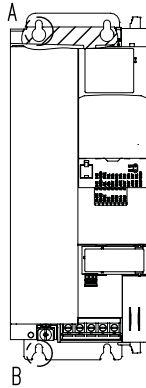
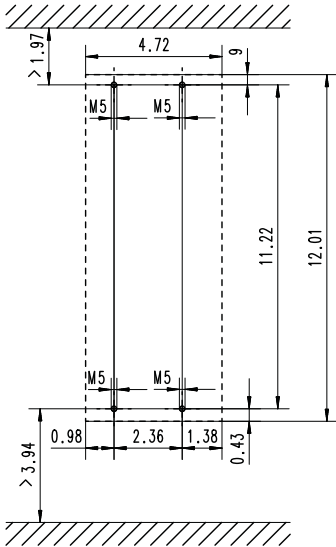
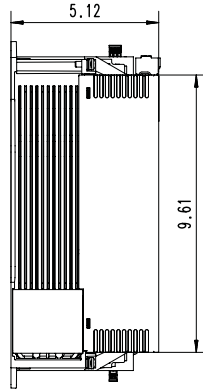
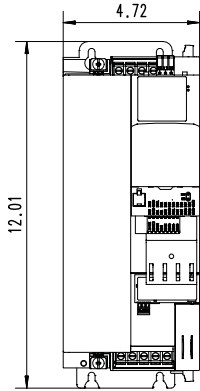

8800303

All Dimensions in inch

Dimensions i55AE 20 hp ... 30 hp

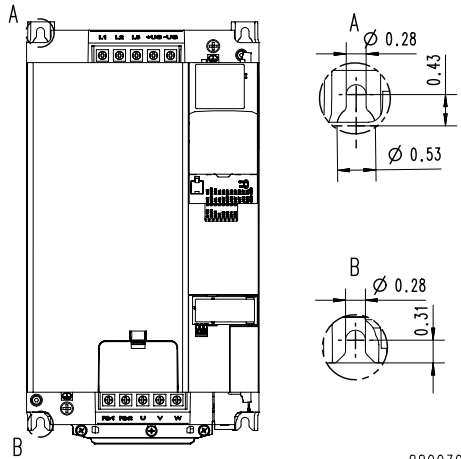
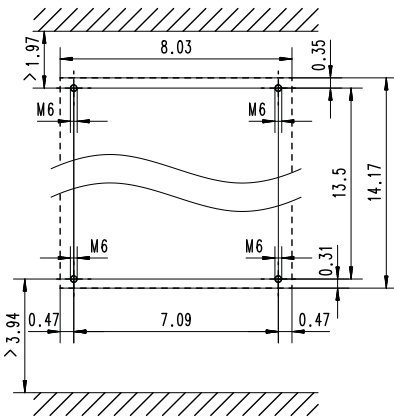
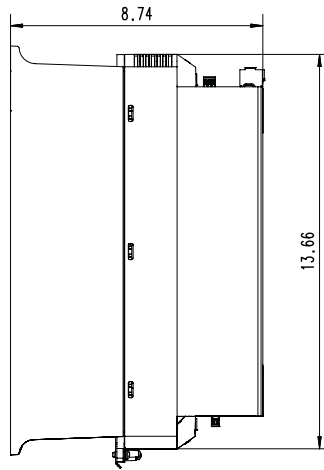
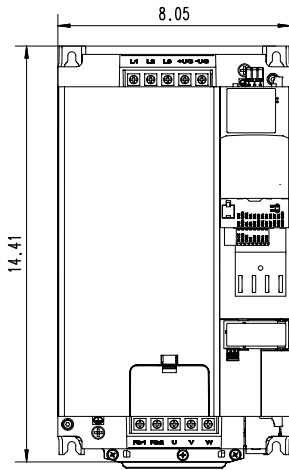

All Dimensions in inch

8800304

4 **Mounting**
Electrical installation
Important notes

4.3 **Electrical installation**

4.3.1 **Important notes**

 **WARNING!**

- ▶ The integral solid state short circuit protection included in the inverter does not provide branch circuit protection. Branch circuit protection must be provided in accordance with the National Electrical Code and any additional local codes.
 - ▶ -----
 - ▶ La protection statique intégrée contre les courts-circuits n'offre pas la même protection que le dispositif de protection du circuit de dérivation. Un tel dispositif doit être fourni, conformément au National Electrical Code et aux autres dispositions applicables au niveau local.
-

 **WARNING!**

- ▶ The inverter (PE) terminals connections must be connected to system earth / ground.
 - ▶ Earth / ground impedance must conform to the requirements of national and local industrial safety regulations and all applicable electrical codes.
 - ▶ The integrity of all earth / ground connections should be periodically checked.
 - ▶ -----
 - ▶ Les raccordements (PE) des bornes du variateur doivent être reliés à la terre.
 - ▶ L'impédance de terre doit être conforme aux exigences des réglementations nationales et locales en vigueur en matière de sécurité industrielle, ainsi qu'aux dispositions applicables en matière d'électricité.
 - ▶ Il convient de vérifier l'intégrité de toutes les liaisons à la masse à intervalles réguliers.
-

 **WARNING!**

- ▶ Use 75°C copper wire only, except for control circuits.
 - ▶ -----
 - ▶ Utiliser exclusivement des conducteurs en cuivre 75 °C, sauf pour la partie commande.
-

 **NOTICE!**

- ▶ Internal overload protection rated for 125 % of the rated FLA.
 - ▶ -----
 - ▶ Protection contre les surcharges conçue pour se déclencher à 125 % de l'intensité assignée à pleine charge.
-

4.3.2 3-phase mains connection 480 V

 **WARNING!**

- ▶ Suitable for use on a circuit capable of delivering not more than 5,000 rms symmetrical amperes, 480/277 V maximum.
 - ▶ When protected by fuses rated as given in tables below.
 - ▶ -----
 - ▶ Convenient aux circuits non susceptibles de délivrer plus de 5.000 ampères symétriques eff., maximum 480/277 V.
 - ▶ Avec une protection par des fusibles du calibre indiqué dans les tableaux ci-dessous.
-

4 Mounting

Electrical installation

3-phase mains connection 480 V

The wiring diagram is valid for 15xAExxxF inverters.

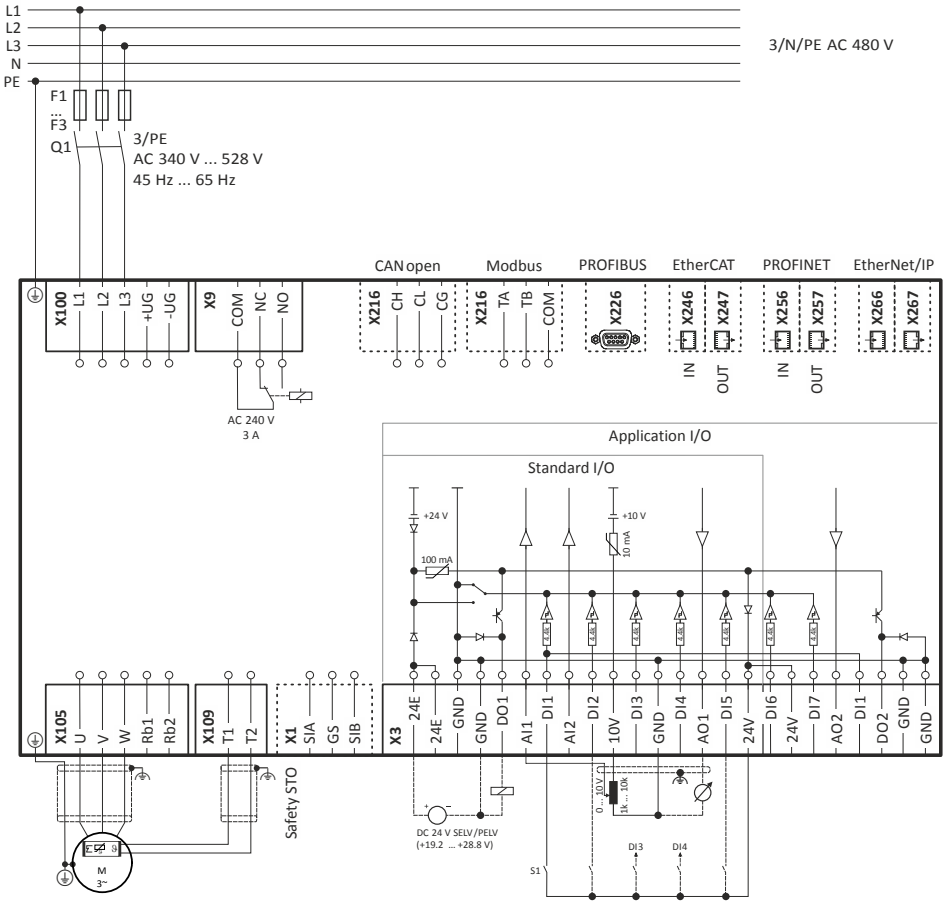

Fig. 1: Wiring example

- S1 Run/Stop
- Fx Fuses
- Q1 Mains contactor
- Dashed line = options

4.3.2.1 Fusing and terminal data

Inverter		I55AE230F	I55AE240F	I55AE255F	I55AE275F	I55AE311F	I55AE315F	I55AE318F
Cable installation in compliance with		UL						
Operation		without mains choke						
Fuse								
Characteristic		all acc. to UL 248/CC			all acc. to UL 248/J, T, R			
Max. rated current	A	25	25	25	35	35	70	70
Circuit breaker								
Characteristic								
Max. rated current	A	25			35			
Operation		with mains choke						
Fuse								
Characteristic		all acc. to UL 248/CC			all acc. to UL 248/J, T, R			
Max. rated current	A	25	25	25	35	35	70	70
Circuit breaker								
Characteristic								
Max. rated current	A	25			35			
Earth-leakage circuit breaker		≥ 300 mA, type B						
Mains connection								
Connection		X100						
Connection type		Screw terminal						
Min. cable cross-section	AWG	16						
Max. cable cross-section	AWG	10			6		2	
Stripping length	inch	0.35			0.43		0.7	
Tightening torque	lb-in	4.4			11		34	
Required tool		0.6 x 3.5			0.8 x 4.0		0.8 x 5.5	
Motor connection								
Connection		X105						
Connection type		Screw terminal						
Min. cable cross-section	AWG	16						
Max. cable cross-section	AWG	10			6		2	
Stripping length	inch	0.35			0.43		0.7	
Tightening torque	lb-in	4.4			11		34	
Required tool		0.6 x 3.5			0.8 x 4.0		0.8 x 5.5	
PE connection								
Connection		PE						
Connection type		PE screw						
Min. cable cross-section	AWG	16						
Max. cable cross-section	AWG	10			6		2	
Stripping length	inch	0.39			0.43		0.63	
Tightening torque	lb-in	11			30		35	
Required tool		0.8 x 5.5			PZ2			

4 Mounting
 Electrical installation
 3-phase mains connection 480 V

Inverter		I55AE322F
Cable installation in compliance with		UL
Operation		without mains choke
Fuse		
Characteristic		all acc. to UL 248/J, T, R
Max. rated current	A	70
Circuit breaker		-
Characteristic		-
Max. rated current	A	-
Operation		with mains choke
Fuse		
Characteristic		all acc. to UL 248/J, T, R
Max. rated current	A	70
Circuit breaker		-
Characteristic		-
Max. rated current	A	-
Earth-leakage circuit breaker		≥ 300 mA, type B
Mains connection		
Connection		X100
Connection type		Screw terminal
Min. cable cross-section	AWG	16
Max. cable cross-section	AWG	2
Stripping length	inch	0.7
Tightening torque	lb-in	34
Required tool		0.8 x 5.5
Motor connection		
Connection		X105
Connection type		Screw terminal
Min. cable cross-section	AWG	16
Max. cable cross-section	AWG	2
Stripping length	inch	0.7
Tightening torque	lb-in	34
Required tool		0.8 x 5.5
PE connection		
Connection		PE
Connection type		PE screw
Min. cable cross-section	AWG	16
Max. cable cross-section	AWG	2
Stripping length	inch	0.63
Tightening torque	lb-in	35
Required tool		P22

4.3.3 CANopen Typical topologies

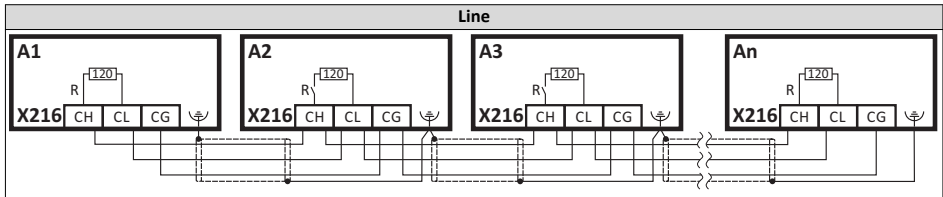

Terminal description		CANopen
Connection		X216
Connection type		Spring terminal
Min. cable cross-section	AWG	22
Max. cable cross-section	AWG	12
Stripping length	inch	0.39
Tightening torque	lb-in	-
Required tool		0.4 x 2.5

Basic network settings

Use the DIP switch to set the node address and baud rate and to activate the integrated bus terminating resistor.

Bus termination		Baud rate				CAN node address						
R	d	c	b	a		64	32	16	8	4	2	1
OFF	OFF	ON	OFF	ON	20 kbps	OFF	OFF	OFF	OFF	OFF	OFF	OFF
Inactive	OFF	OFF	ON	ON	50 kbps	Value from parameter						
ON	OFF	OFF	ON	OFF	125 kbps	Node address - example:						
Active	OFF	OFF	OFF	ON	250 kbps	OFF	OFF	ON	OFF	ON	ON	ON
	OFF	OFF	OFF	OFF	Value from parameter (500 kbps)	Node address = 16 + 4 + 2 + 1 = 23						
	OFF	ON	OFF	OFF	1 Mbps							
	All other combinations				Value from parameter (500 kbps)							

Printed in bold = Lenze setting



The network must be terminated with a 120 Ω resistor at the physically first and last node.
Set the "R" switch to ON at these nodes.

4 Mounting

Electrical installation
Modbus

4.3.4 Modbus

Typical topologies

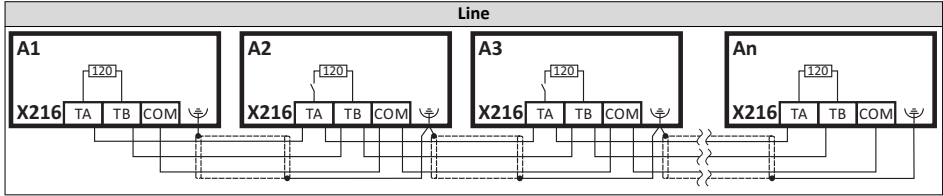

Terminal description		Modbus
Connection		X216
Connection type		Spring terminal
Min. cable cross-section	AWG	22
Max. cable cross-section	AWG	12
Stripping length	inch	0.39
Tightening torque	lb-in	-
Required tool		0.4 x 2.5

Basic network settings

Use the DIP switch to set the node address and baud rate and to activate the integrated bus terminating resistor.

Bus termination	Baud rate	Parity	Modbus node address							
R	c	a	128	64	32	16	8	4	2	1
OFF	n.c.	OFF	OFF	OFF	OFF	OFF	OFF	OFF	OFF	OFF
Inactive	Automatic detection	Automatic detection	Value from parameter							
ON		ON	Node address - example:							
Active	Value from parameter	Value from parameter	OFF	OFF	OFF	ON	OFF	ON	ON	ON
				Node address = 16 + 4 + 2 + 1 = 23 Node address > 247: value from parameter						

Printed in bold = Lenze setting



The network must be terminated with a 120 Ω resistor at the physically first and last node.
Set the "R" switch to ON at these nodes.

4.3.5 PROFIBUS

Typical topologies

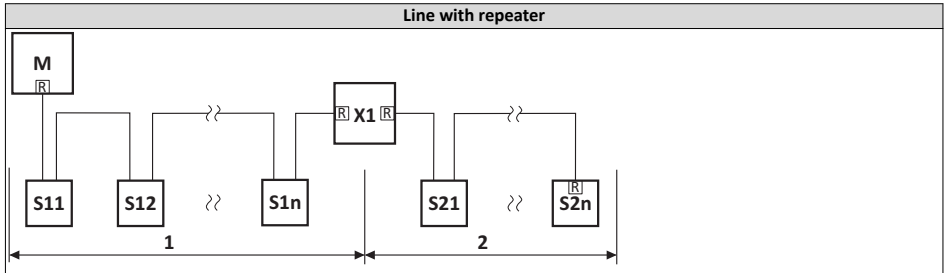

M Master
Sxx Slaves
X1 Repeater
R Activated bus terminating resistor

Sub D socket 9-pin - X226

View	Pin	Assignment	Description
	1	Shield	Additional shield connection
	2	n.c.	
	3	RxD/TxD-P	Data line-B (received data/transmitted data +)
	4	RTS	Request To Send (received data/transmitted data, no differential signal)
	5	M5V2	Reference potential (bus terminating resistor -)
	6	P5V2	5 V DC / 30 mA (bus terminating resistor +, OLM, OLP)
	7	n.c.	
	8	RxD/TxD-N	Data line-A (received data/transmitted data -)
	9	n.c.	

Basic network settings

Use the DIP switch to set the station address.

The baud rate is detected automatically.

PROFIBUS Address

PROFIBUS station address						
64	32	16	8	4	2	1
OFF	OFF	OFF	OFF	OFF	OFF	OFF
Value from parameter						
Station address - example:						
OFF	OFF	ON	OFF	ON	ON	ON
Station address = 16 + 4 + 2 + 1 = 23						
Do not set station address = 126 and station address = 127. These station addresses are invalid.						

Printed in bold = Lenze setting



The network must be terminated with a resistor at the physically first and last node.
Activate the bus terminating resistor at these nodes in the bus connection plug.

4.3.6 EtherCAT

Typical topologies

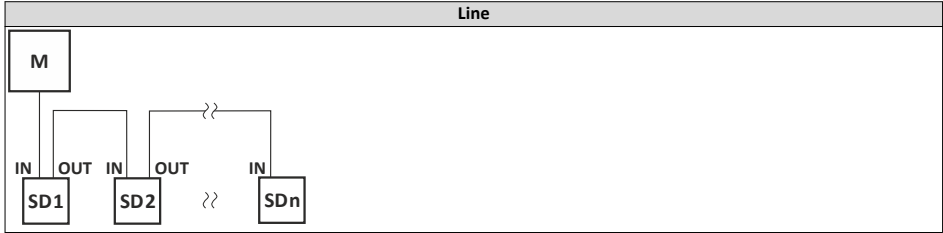

M Master
SD Slave Device

Bus-related information	
Name	EtherCAT
Communication medium	Ethernet 100 Mbps, full duplex
Use	Connection of the inverter to an EtherCAT network
Connection system	RJ45
Status display	2 LEDs
Connection designation	In: X246 Out: X247

Basic network settings

The rotary encoder switch allows you to set an EtherCAT identifier.

Setting	Identifier
0x00	Value from parameter
0x01 ... 0xFF	Switch position

4.3.7 EtherNet/IP
Typical topologies

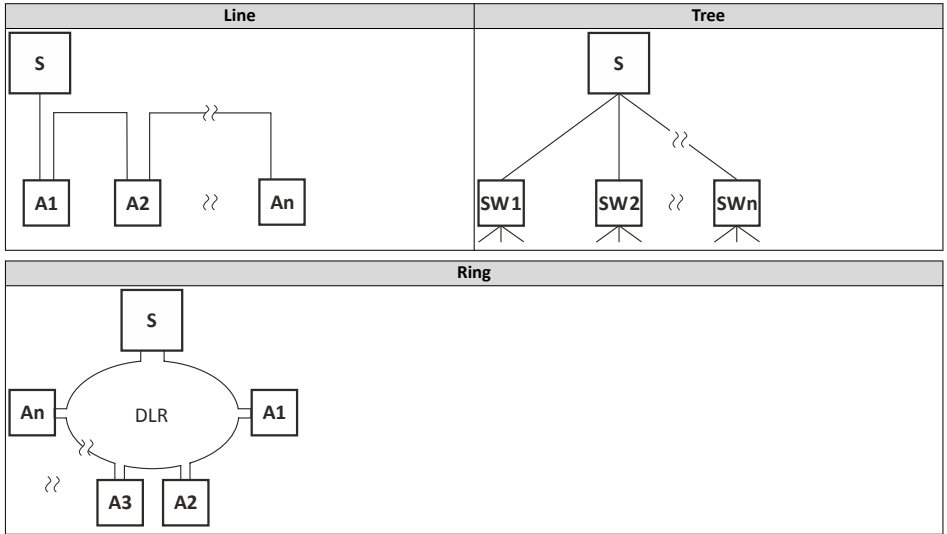

S Scanner
A Adapter

Bus-related information			
Name		EtherNet/IP	
Communication medium		Ethernet 10 Mbps, 100 Mbps, half duplex, full duplex	
Use		Connection of the inverter to an EtherNet/IP network	
Connection system		RJ45	
Status display		2 LEDs	
Connection designation		X266, X267	

Basic network settings

The rotary encoder switch allows you to set the last byte of the IP address.

Setting	Value of last byte
0x00	Value from parameter
0x01 ... 0xFE	Switch position
0xFF	Default setting

4.3.8 PROFINET
Typical topologies

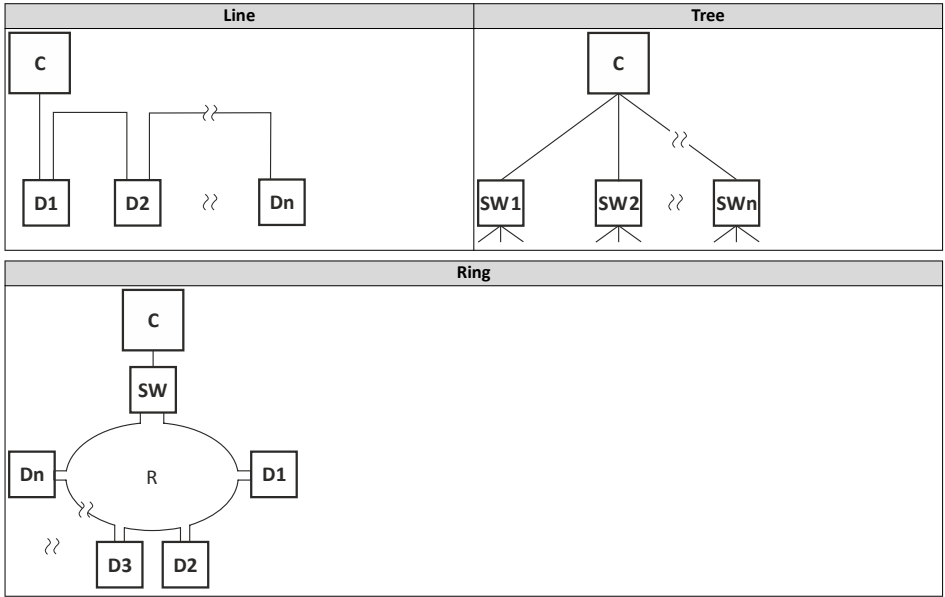

C	I/O controller	SW	Switch SCALANCE (MRP capable)
D	I/O device	R	Redundant domain

Bus-related information			
Name		PROFINET RT	
Communication medium		Ethernet 100 Mbps, full duplex	
Use		Connection of the inverter to a PROFINET network	
Connection system		RJ45	
Status display		2 LEDs	
Connection designation		X256, X257	



The rotary encoder switch has no function.

4.3.9 Connection of the safety module

4.3.9.1 Important notes

DANGER!

Improper installation of the safety engineering system can cause an uncontrolled starting action of the drives.

Possible consequences: Death or severe injuries

- ▶ Safety engineering systems may only be installed and commissioned by qualified and skilled personnel.
- ▶ All control components (switches, relays, PLC, ...) and the control cabinet must comply with the requirements of the EN ISO 13849-1 and the EN ISO 13849-2.
- ▶ Switches, relays with at least IP54 enclosure.
- ▶ Control cabinet with at least IP54 enclosure.
- ▶ It is essential to use insulated wire end ferrules for wiring.
- ▶ All safety relevant cables outside the control cabinet must be protected, e.g. by means of a cable duct
- ▶ Ensure that no short circuits can occur according to the specifications of the EN ISO 13849-2.
- ▶ All further requirements and measures can be obtained from the EN ISO 13849-1 and the EN ISO 13849-2.
- ▶ If an external force acts upon the drive axes, additional brakes are required. Please observe that hanging loads are subject to the force of gravity!
- ▶ The user has to ensure that the inverter will only be used in its intended application within the specified environmental conditions. This is the only way to comply with the declared safety-related characteristics.

DANGER!

With the "Safe torque off" (STO) function, no "emergency stop" in terms -EN 60204-1 can be executed without additional measures. There is no isolation between the motor and inverter, no service switch or maintenance switch!

Possible consequence: death or severe injuries

- ▶ "Emergency stop" requires electrical isolation, e.g. by a central mains contactor.

DANGER!

Automatic restart if the request of the safety function is deactivated.

Possible consequences: Death or severe injuries

- ▶ You must provide external measures according to EN ISO 13849-1 which ensure that the drive only restarts after a confirmation.

NOTICE!

Overvoltage

Destruction of the safety component

- ▶ The maximum voltage (maximum rated) at the safety inputs is 32 V DC. The user must make provisions to avoid that this voltage is exceeded.

4 Mounting

Electrical installation

Connection of the safety module

4.3.9.2 Connection plan

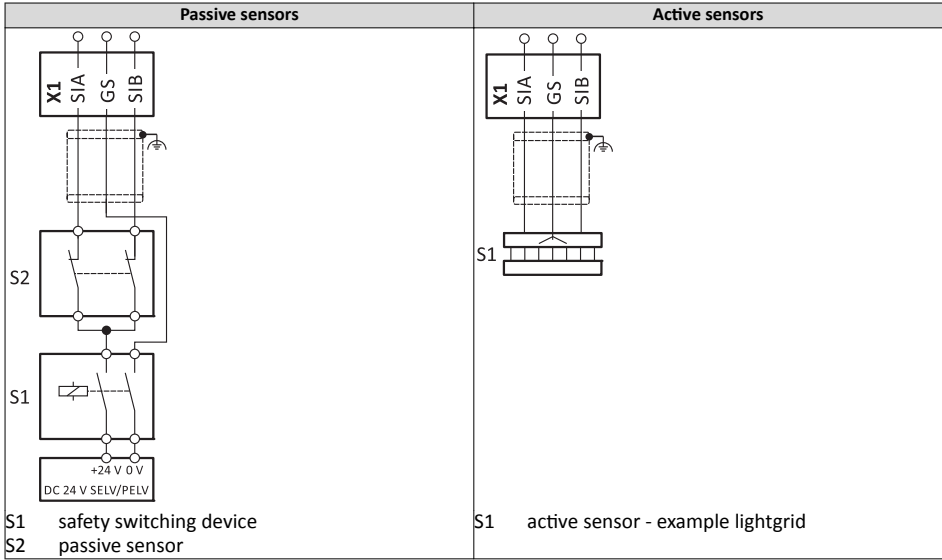

4.3.9.3 Terminal data

Terminal description		Safety STO
Connection		X1
Connection type		Screw terminal
Min. cable cross-section	AWG	22
Max. cable cross-section	AWG	16
Stripping length	inch	0.24
Tightening torque	lb-in	1.8
Required tool		0.4 x 2.5

X1	Specification	Unit	min.	typ.	max.
SIA, SIB	LOW signal	V	-3	0	+5
	HIGH signal	V	+15	+24	+30
	Running time	ms		3	
	Input current SIA	mA		10	14
	Input current SIB	mA		7	12
	Input peak current	mA		100	
	Tolerated test pulse	ms			1
	Switch-off time	ms		50	
	Permissible distance of the test pulses	ms	10		
GS	Reference potential for SIA and SIB				

5 Commissioning

5.1 Important notes

WARNING!

Incorrect settings during commissioning may cause unexpected and dangerous motor and system movements.

Possible consequence: death, severe injuries or damage to property

- ▶ Clear hazardous area.
 - ▶ Observe safety instructions and safety clearances.
-

5.2 Before initial switch-on

Prevent injury to persons and damage to property. Check the following before switching on the mains voltage:

- Is the wiring complete and correct?
- Are there no short circuits and earth faults?
- Is the motor circuit configuration (star/delta) adapted to the output voltage of the inverter?
- Is the motor connected in-phase (direction of rotation)?
- Does the "emergency stop" function of the entire plant operate correctly?

5 Commissioning

Initial switch-on / functional test with terminal control

5.3 Initial switch-on / functional test with terminal control

Target: achieve rotation of the motor connected to the inverter as quickly as possible.

Requirements:

- The connected motor matches the inverter in terms of power.
- The parameter settings comply with the delivery status (Lenze setting).

1. Preparation:

1. Wiring of power terminals. (Chapter 4.3 *Electrical installation*)
2. Wire digital inputs X3/DI1 (start/stop), X3/DI3 (reversal of rotation direction), and X3/DI4 (preset frequency setpoint 20 Hz).
3. Do not connect terminal X3/AI1 (analog setpoint selection) or connect it to GND.

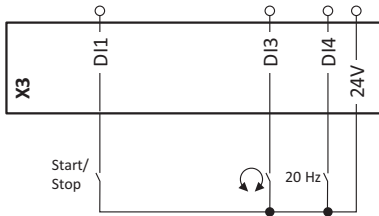

2. Switch on mains and check readiness for operation:

1. Switch on mains voltage.
2. Observe LED status displays "RDY" and "ERR" on the front of the inverter:
 - a) If the blue "RDY" LED is blinking and the red "ERR" LED is off, the inverter is ready for operation. The controller is inhibited.
You can now start the drive.
 - b) If the red "ERR" LED is lit permanently, a fault is pending.
Eliminate the fault before you carry on with the functional test.

LED status displays

"RDY" LED (blue)	"ERR" LED (red)	Status/meaning
off	off	No supply voltage.
blinking (1 Hz)	off	Safe torque off (STO) active.
	blinking fast (4 Hz)	Safe torque off (STO) active. Warning active.
blinking (2 Hz)	off	Inverter inhibited.
	lit every 1.5 s for a short time	Inverter inhibited, no DC-bus voltage.
	blinking fast (4 Hz)	Inverter inhibited, warning active.
	on	Inverter inhibited, fault active.
on	off	Inverter enabled.
	blinking fast (4 Hz)	Inverter enabled, warning active.
	blinking (1 Hz)	Inverter enabled, quick stop as response to a fault active.

Carrying out the functional test

1. Start drive:

1. Start inverter: X3/DI1 = HIGH.

a) If the inverter is equipped with an integrated safety system: X1/SIA = HIGH and X1/SIB = HIGH.

2. Activate preset frequency setpoint 1 (20 Hz) as speed setpoint: X3/DI4 = HIGH.

The drive rotates with 20 Hz.

3. Optional: activate the function for the reversal of rotation direction.

a) X3/DI3 = HIGH.

The drive rotates with 20 Hz in the opposite direction.

b) Deactivate the function for the reversal of rotation direction again: X3/DI3 = LOW.

Speed characteristic (example)

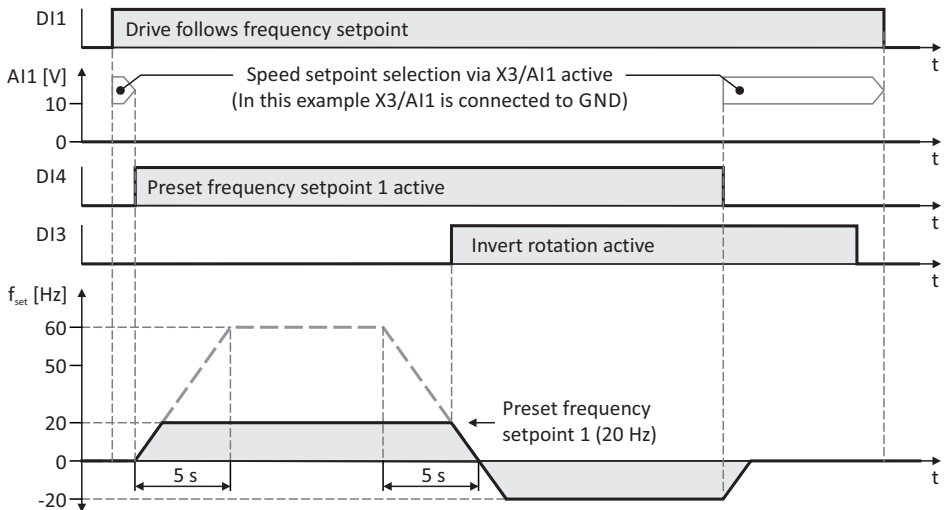

2. Stop drive:

1. Deactivate preset frequency setpoint 1 again: X3/DI4 = LOW.

2. Stop inverter again: X3/DI1 = LOW.

The functional test is completed.



The commissioning process of the drive solution is described in a separate commissioning instruction which can be found on the Internet in our download area:
<http://www.lenze.com> → Download

6 Technical data
Standards and operating conditions

6 Technical data

6.1 Standards and operating conditions

Conformities		
CE	2014/35/EU	Low-Voltage Directive
	2014/30/EU	EMC Directive (reference: CE-typical drive system)
EAC	TR TC 004/2011	Eurasian conformity: safety of low voltage equipment
	TP TC 020/2011	Eurasian conformity: electromagnetic compatibility of technical means
RoHS 2	2011/65/EU	Restrictions for the use of specific hazardous materials in electric and electronic devices
Approvals		
UL	UL 61800-5-1	for USA and Canada (requirements of the CSA 22.2 No. 274) 0.25 kW ... 22 kW (30 kW ... 45 kW in preparation)
Energy efficiency		
Class IE2	EN 50598-2	Reference: Lenze setting (switching frequency 8 kHz variable)
Degree of protection		
IP20	EN 60529	
Type 1	NEMA 250	Protection against contact
Open type		only in UL-approved systems
Insulation resistance		
Overvoltage category III	EN 61800-5-1	0 ... 2000 m a.m.s.l.
Overvoltage category II		above 2000 m a.m.s.l.
Control circuit isolation		
Safe mains isolation by double/reinforced insulation	EN 61800-5-1	
Protective measures against		
Short circuit		
Earth fault		Earth fault strength depends on the operating status
Overvoltage		
Motor stalling		
Motor overtemperature		PTC or thermal contact, I ² t monitoring
Leakage current		
> 3.5 mA AC, > 10 mA DC	EN 61800-5-1	Observe regulations and safety instructions!
Mains switching		
3-time mains switching in 1 min		Cyclic, without any restrictions
Starting current		
≤ 3 x rated mains current		
Mains systems		
TT		Voltage to earth/ground: max. 300 V
TN		
IT		Apply the measures described for IT systems!
		IT systems are not relevant for UL-approved systems
Operation on public supply systems		
Implement measures to limit the radio interference to be expected:		The machine or plant manufacturer is responsible for compliance with the requirements for the machine/plant!
< 1 kW: with mains choke	EN 61000-3-2	
> 1 kW at mains current ≤ 16 A: without additional measures		

Mains current > 16 A: with mains choke or mains filter, with dimensioning for rated power. Rscse ≥ 120 is to be met.	EN 61000-3-12	RSCE: short-circuit power ratio at the connection point of the machine/plant to the public network.
Requirements to the shielded motor cable		
Capacitance per unit length		
C-core-core/C-core-shield < 75/150 pF/m		≤ 2.5 mm ² / AWG 14
C-core-core/C-core-shield < 150/300 pF/m		≥ 4 mm ² / AWG 12
Electric strength		
U _o /U = 0.6/1.0 kV		U _o = r.m.s. value external conductor to PE
U ≥ 600 V	UL	U = r.m.s. value external conductor/external conductor
Climate		
1K3 (-25 ... +60 °C)	EN 60721-3-1	Storage
2K3 (-25 ... +70 °C)	EN 60721-3-2	Transport
3K3 (-10 ... +55 °C)	EN 60721-3-3	Operation
		Operation at a switching frequency of 2 or 4 kHz: above +45°C, reduce rated output current by 2.5 %/°C
		Operation at a switching frequency of 8 or 16 kHz: above +40°C, reduce rated output current by 2.5 %/°C
Site altitude		
0 ... 1000 m a.m.s.l.		
1000 ... 4000 m a.m.s.l.		Reduce rated output current by 5 %/1000 m
Pollution		
Degree of pollution 2	EN 61800-5-1	
Vibration resistance		
Transport		
2M2 (sine, shock)	EN 60721-3-2	
Operation		
Amplitude 1 mm	Germanischer Lloyd	5 ... 13.2 Hz
Acceleration resistant up to 0.7 g		13.2 ... 100 Hz
Amplitude 0.075 mm	EN 61800-5-1	10 ... 57 Hz
Acceleration resistant up to 1 g		57 ... 150 Hz
Noise emission		
Category C1	EN 61800-3	Type-dependent, for motor cable lengths see rated data
Category C2		
Noise immunity		
Meets requirement in compliance with	EN 61800-3	

6 **Technical data**

3-phase mains connection 480 V

6.2 **3-phase mains connection 480 V**

The output currents apply to these operating conditions:

- At a switching frequency of 2 kHz or 4 kHz: Max. ambient temperature 113 °F.
- At a switching frequency of 8 kHz or 16 kHz: Max. ambient temperature 104 °F.

6.2.1 Rated data

Inverter		I55AE230F	I55AE240F	I55AE255F	I55AE275F	I55AE311F	I55AE315F	I55AE318F
Rated power	hp	4	5.5	7.5	10	15	20	25
Mains voltage range		3/PE AC 340 V ... 528 V, 45 Hz ... 65 Hz						
Rated mains current								
without mains choke	A	8	10.5	14.3	16.6	23.7	32.3	40.3
with mains choke	A	5.8	7.5	10.3	13.1	18.6	24	30
Output current								
2 kHz	A	6.3	8.2	11	14	21	27	34
4 kHz	A	6.3	8.2	11	14	21	27	34
8 kHz	A	6.3	8.2	11	14	21	27	34
16 kHz	A	4.2	5.5	7.3	9.3	14	18	22.6
Power loss	W	109	140	189	238	337	457	569
Overcurrent cycle 180 s								
Max. output current	A	9.45	12.3	16.5	21	31.5	40.5	51
Overload time	s	60	60	60	60	60	60	60
Recovery time	s	120	120	120	120	120	120	120
Max. output current during the recovery time	A	4.73	6.15	8.25	10.5	15.8	20.3	25.5
Overcurrent cycle 15 s								
Max. output current	A	12.6	16.4	22	28	42	54	68
Overload time	s	3	3	3	3	3	3	3
Recovery time	s	12	12	12	12	12	12	12
Max. output current during the recovery time	A	4.73	6.15	8.25	10.5	15.8	20.3	25.5
Brake chopper								
Max. output current	A	9.51	16.6	16.6	28.89	28.89	43.33	52
Min. brake resistance	Ω	82	47	47	27	27	18	15
Motor cable length								
shielded, without EMC	ft	164			328			
C2 residential area / industrial premises	ft	65						
Weight	lb	5			8		23	

Technical data

3-phase mains connection 480 V

Rated data

Inverter		I55AE322F
Rated power	hp	30
Mains voltage range		3/PE AC 340 V ... 528 V, 45 Hz ... 65 Hz
Rated mains current		
without mains choke	A	47.4
with mains choke	A	35.3
Output current		
2 kHz	A	40.4
4 kHz	A	40.4
8 kHz	A	40.4
16 kHz	A	26.9
Power loss	W	668
Overcurrent cycle 180 s		
Max. output current	A	60.6
Overload time	s	60
Recovery time	s	120
Max. output current during the recovery time	A	30.3
Overcurrent cycle 15 s		
Max. output current	A	80.8
Overload time	s	3
Recovery time	s	12
Max. output current during the recovery time	A	30.3
Brake chopper		
Max. output current	A	52
Min. brake resistance	Ω	15
Motor cable length		
shielded, without EMC	ft	328
C2 residential area / industrial premises	ft	65
Weight	lb	23

 Lenze Drives GmbH
Postfach 10 13 52, D-31763 Hameln
Breslauer Straße 3, D-32699 Extertal
Germany
HR Lemgo B 6478
 +49 5154 82-0
 +49 5154 82-2800
 lenze@lenze.com
 www.lenze.com

 Lenze Service GmbH
Breslauer Straße 3, D-32699 Extertal
Germany
 0080002446877 (24 h helpline)
 +49 5154 82-1112
 service.de@lenze.com
TD 20151204

