

Project planning EN



Inverter i550 0.25 ... 132 kW

Contents

About this document	9
Document description	9
Further documents.....	9
Notations and conventions	10
Product information	11
Product description	11
Identification of the products.....	12
Features.....	15
The modular system	22
The concept	22
Topologies / network.....	23
Ways of commissioning.....	24
Functions.....	25
Overview.....	25
Motor control types	26
Features.....	26
Motor setting range.....	26
Information on project planning	28
Project planning process.....	28
Dimensioning	28
Operation in motor and generator mode.....	31
Overcurrent operation.....	32
Safety instructions	34
Basic safety instructions	34
Application as directed.....	35
Foreseeable misuse.....	35
Handling.....	36
Residual hazards.....	38
Control cabinet structure.....	40
Arrangement of components.....	40
Cables	41
Earthing concept.....	41
Information on mechanical installation	42
Important notes.....	42
Preparation.....	43

Contents

Information on electrical installation	44
Important notes.....	44
Preparation.....	46
EMC-compliant installation.....	47
Connection according to UL.....	50
Important notes.....	50
Fusing data.....	52
Mains connection	55
1-phase mains connection 120 V.....	56
1-phase mains connection 230/240 V.....	57
3-phase mains connection 230/240 V.....	59
3-phase mains connection 230/240 V "Light Duty".....	60
3-phase mains connection 400 V.....	61
3-phase mains connection 400 V "Light Duty".....	61
3-phase mains connection 480 V.....	62
3-phase mains connection 480 V "Light Duty".....	62
Motor connection.....	63
Connection to the IT system.....	64
Connection of motor temperature monitoring.....	66
Brake resistor connection.....	67
DC-bus connection.....	68
Control connections.....	68
Networks.....	69
CANopen.....	69
EtherCAT.....	70
EtherNet/IP.....	70
Modbus RTU.....	71
Modbus TCP.....	71
POWERLINK.....	72
PROFIBUS.....	72
PROFINET.....	73
IO-Link.....	74
Functional safety.....	75
Basic Safety - STO.....	76
Connection diagram.....	77
Terminal data.....	78

Technical data	79
Standards and operating conditions.....	79
Conformities and approvals.....	79
Protection of persons and device protection.....	79
EMC data.....	79
Motor connection.....	80
Environmental conditions.....	80
Electrical supply conditions.....	81
Certification of the integrated safety.....	81
1-phase mains connection 120 V.....	82
Rated data.....	83
Fusing data.....	84
Terminal data.....	84
Brake resistors.....	84
Mains chokes.....	84
1-phase mains connection 230/240 V.....	85
Rated data.....	86
Fusing data.....	90
Terminal data.....	90
Brake resistors.....	91
Mains chokes.....	91
RFI filters / Mains filters.....	92
3-phase mains connection 230/240 V.....	94
Rated data.....	95
Fusing data.....	98
Terminal data.....	98
Brake resistors.....	99
Mains chokes.....	99
3-phase mains connection 230/240 V "Light Duty".....	100
Rated data.....	100
Fusing data.....	102
Terminal data.....	102
Brake resistors.....	102
Mains chokes.....	102
3-phase mains connection 400 V.....	103
Rated data.....	103
Fusing data.....	109
Terminal data.....	110
Brake resistors.....	111
Mains chokes.....	112
RFI filters / Mains filters.....	113
Sine filter.....	115

Contents

3-phase mains connection 400 V "Light Duty".....	116
Rated data.....	116
Fusing data.....	120
Terminal data.....	121
Brake resistors.....	122
Mains chokes.....	123
RFI filters / Mains filters.....	124
Sine filter.....	125
3-phase mains connection 480 V	126
Rated data.....	126
Fusing data.....	132
Terminal data.....	133
Brake resistors.....	134
Mains chokes.....	135
RFI filters / Mains filters.....	136
3-phase mains connection 480 V "Light Duty".....	139
Rated data.....	139
Fusing data.....	143
Terminal data.....	144
Brake resistors.....	145
Mains chokes.....	146
RFI filters / Mains filters.....	147
Dimensions.....	149

Product extensions	160
Overview	160
I/O extensions.....	161
Standard I/O.....	161
Application I/O.....	162
Data of control connections.....	163
Further control connections.....	166
Relay output.....	166
PTC input.....	166
Networks.....	167
CANopen.....	167
EtherCAT.....	169
EtherNet/IP.....	170
Modbus RTU.....	171
Modbus TCP.....	172
POWERLINK.....	173
PROFIBUS.....	174
PROFINET.....	175
IO-Link.....	176
Functional safety.....	177
General information and basics.....	177
Restart.....	178
Safety sensors.....	179
Safety functions.....	180
Safe torque off (STO).....	181
Acceptance.....	183
Periodic inspections.....	183
Technical data.....	184
Rated data.....	184

Contents

Accessories	185
Overview	185
Operation and diagnostics	186
Keypad	186
External keypad.....	186
USB module.....	187
WLAN module	188
Blanking cover.....	190
Setpoint potentiometer.....	190
Memory modules	190
Memory module copier	191
Brake resistors	191
Mains chokes.....	192
RFI filters / Mains filters.....	193
Sine filter	194
Power supply units.....	194
Brake switches.....	195
Mounting.....	196
Shield mounting kit	196
Terminal strips.....	198
DIN rail	199
Purchase order	200
Notes on ordering.....	200
Order code.....	201
Appendix	206
Declarations of Conformity	206
Good to know	210
Approvals and directives.....	210
Operating modes of the motor.....	211
Motor control types	212
Switching frequencies.....	214
Enclosures.....	215
Glossary.....	215



About this document

Document description

This document is aimed at all persons who want to project inverters with the described products.

This document assists you with the configuration and selection of your product. It also contains information on preparations for mechanical and electrical installation, on product expansions, and on accessories.

Further documents

For certain tasks, information is available in other media.

Form	Contents/topics
Engineering Tools	For commissioning
AKB articles	Additional technical information for users in the Application Knowledge Base
CAD data	Download in different formats from the EASY Product Finder
EPLAN macros	Project planning, documentation and management of projects for EPLAN P8.

These media can be found here: Lenze.com

More information

For certain tasks, more information is available in additional documents.

Document	Contents/topics
Commissioning document	Setting and parameterising the inverters
Mounting Instructions	Basic information for the mechanical and electrical installation <ul style="list-style-type: none">• Is supplied with each component.
"Functional safety" configuration document	Information on this (optional) function



Information and tools with regard to the Lenze products can be found on the Internet: www.Lenze.com → Downloads





About this document

Notations and conventions



Notations and conventions

Conventions are used in this document to distinguish between different types of information.

Numeric notation		
Decimal separator	Point	Generally shown as a decimal point. Example: 1 234.56
Warnings		
UL Warnings	UL	Are used in English and French.
UR warnings	UR	
Text		
Engineering Tools	" "	Software Example: "Engineer", "EASY Starter"
Icons		
Page reference		Reference to another page with additional information. Example:  16 = see page 16
Documentation reference		Reference to other documentation with additional information. Example:  EDKxxx = see documentation EDKxxx

Layout of the safety instructions

DANGER!

Indicates an extremely hazardous situation. Failure to comply with this instruction will result in severe irreparable injury and even death.

WARNING!

Indicates an extremely hazardous situation. Failure to comply with this instruction may result in severe irreparable injury and even death.

CAUTION!

Indicates a hazardous situation. Failure to comply with this instruction may result in slight to medium injury.

NOTICE

Indicates a material hazard. Failure to comply with this instruction may result in material damage.



Product information

Product description

i500 is the new inverter series - a streamlined design, scalable functionality and exceptional user-friendliness.

I500 is a high-quality inverter that already conforms to future standard in accordance with the EN 50598-2 efficiency classes (IE). Overall, this provides a reliable and future-proof drive for a wide range of machine applications.

The i550

This chapter provides the complete scope of the inverter i550. This inverter is suitable for a very broad range of uses in inverter-operated drives. Basically, the device has the following features:

- All typical motor control types of modern inverters.
- Cyclic and continuous operation of the motor according to common operating modes.
- Industry-standard networking opportunities.
- High internal functional range.

Highlights

- Compact size
 - Up to 2.2 kW only 60 mm wide
 - Up to 11 kW only 130 mm deep
- Can be directly connected without external cooling
- Innovative interaction options enable better set-up times than ever.
- The wide-ranging modular system enables various product configurations depending on machine requirements.



Application ranges

- Pumps and fans
- Conveying and travelling drives
- Forming, tool and hoist drives

Product information

Identification of the products



Identification of the products

When the technical data of the different versions was listed, the product name was entered because it is easier to read than the individual product code of the product. The product name is also used for categorising the accessories. The assignment of product name and order code can be found in the Order chapter.

The product name contains the power in kW, the mains voltage class 120 V, 230 V or 400 V and the number of phases.

In the product name, the power information always refers to the "Heavy Duty" load characteristic.

The 1/3-phase inverters are marked at the end with "-2".

"C" marks the "Cabinet" version = inverter for the installation into the control cabinet.

Inverter series	Type	Rated power		Rated mains voltage	No. of phases	Inverter
		kW	V			
Inverter i550	C	0.25	120	1	i550-C0.25/120-1	
		0.37			i550-C0.37/120-1	
		0.75			i550-C0.75/120-1	
		1.1			i550-C1.1/120-1	

Inverter series	Type	Rated power		Rated mains voltage	No. of phases	Inverter
		kW	V			
Inverter i550	C	0.25	230	1	i550-C0.25/230-1	
				1/3	i550-C0.25/230-2	
		0.37		1	i550-C0.37/230-1	
				1/3	i550-C0.37/230-2	
		0.55		1	i550-C0.55/230-1	
				1/3	i550-C0.55/230-2	
		0.75		1	i550-C0.75/230-1	
				1/3	i550-C0.75/230-2	
		1.1		1	i550-C1.1/230-1	
				1/3	i550-C1.1/230-2	
		1.5		1	i550-C1.5/230-1	
				1/3	i550-C1.5/230-2	
		2.2		1	i550-C2.2/230-1	
				1/3	i550-C2.2/230-2	

Inverter series	Type	Rated power		Rated mains voltage	No. of phases	Inverter
		Light Duty	Heavy Duty			
		kW	kW			
Inverter i550	C	-	0.25	240	1/3	i550-C0.25/230-2
			0.37			i550-C0.37/230-2
			0.55			i550-C0.55/230-2
			0.75			i550-C0.75/230-2
			1.1			i550-C1.1/230-2
			1.5			i550-C1.5/230-2
			2.2			i550-C2.2/230-2
			7.5			5.5



Product information

Identification of the products

Inverter series	Type	Rated power		Rated mains voltage	No. of phases	Inverter
		Light Duty	Heavy Duty			
		kW	kW			
Inverter i550	C	-	0.37	400	3	i550-C0.37/400-3
			0.55			i550-C0.55/400-3
			0.75			i550-C0.75/400-3
			1.1			i550-C1.1/400-3
			1.5			i550-C1.5/400-3
			2.2			i550-C2.2/400-3
		4	3	i550-C3.0/400-3		
		5.5	4	i550-C4.0/400-3		
		7.5	5.5	i550-C5.5/400-3		
		11	7.5	i550-C7.5/400-3		
		15	11	i550-C11/400-3		
		18.5	15	i550-C15/400-3		
		22	18.5	i550-C18/400-3		
		30	22	i550-C22/400-3		
		37	30	i550-C30/400-3		
		45	37	i550-C37/400-3		
		55	45	i550-C45/400-3		
		75	55	i550-C55/400-3		
		90	75	i550-C75/400-3		
		110	90	i550-C90/400-3		
132	110	i550-C110/400-3				

Inverter series	Type	Rated power		Rated mains voltage	No. of phases	Inverter
		Light Duty	Heavy Duty			
		kW	kW			
Inverter i550	C	-	0.37	480	3	i550-C0.37/400-3
			0.55			i550-C0.55/400-3
			0.75			i550-C0.75/400-3
			1.1			i550-C1.1/400-3
			1.5			i550-C1.5/400-3
			2.2			i550-C2.2/400-3
		4	3	i550-C3.0/400-3		
		5.5	4	i550-C4.0/400-3		
		7.5	5.5	i550-C5.5/400-3		
		11	7.5	i550-C7.5/400-3		
		15	11	i550-C11/400-3		
		18.5	15	i550-C15/400-3		
		22	18.5	i550-C18/400-3		
		30	22	i550-C22/400-3		
		37	30	i550-C30/400-3		
		45	37	i550-C37/400-3		
		55	45	i550-C45/400-3		
		75	55	i550-C55/400-3		
		90	75	i550-C75/400-3		
		110	90	i550-C90/400-3		
132	110	i550-C110/400-3				

Product information

Identification of the products



Product code

		I	5	5	A	E	□□□	□	1	□	□	□	□□□□
Product type	Inverter	I											
Product family	i500		5										
Product	i550			5									
Product generation	Generation 1				A								
	Generation 2				B								
Mounting type	Control cabinet mounting					E							
Rated power (Examples)	0.25 kW						125						
	0.55 kW						155						
	2.2 kW						222						
	3.0 kW						230						
	15 kW						315						
	30 kW						330						
Mains voltage and connection type	1/N/PE AC 120 V									A			
	1/N/PE AC 230/240 V									B			
	3/PE AC 230/240 V									C			
	1/N/PE AC 230/240 V 3/PE AC 230/240 V									D			
	3/PE AC 400 V									F			
	3/PE AC 480 V												
Motor connections	Single axis									1			
Integrated functional safety	Without safety function									0			
	Basic Safety STO									A			
Degree of protection	IP20, coated										V		
Interference suppression	Without											0	
	Integrated RFI filter											1	
Application	Default parameter setting: Region EU (50-Hz networks)												0
	Default parameter setting: Region US (60-Hz networks)												1
Design types	Standard I/O without network												000S
	Application I/O without network												001S
	Standard I/O with CANopen												002S
	Standard I/O with Modbus RTU												003S
	Standard I/O with PROFIBUS												004S
	Standard I/O with POWERLINK												012S
	Standard I/O with EtherCAT												00KS
	Standard I/O with PROFINET												00LS
	Standard I/O with EtherNet/IP												00MS
	Standard I/O with Modbus TCP												00WS
	Standard I/O with IO-Link												016S

Example:

Product code	Meaning
I55AE311F1AV1000KS	Inverter i550 Cabinet, 11 kW, 3-phase, 400 V/480 V STO safety function, IP20, varnished, integrated RFI filter; 50 Hz variant Standard I/O with EtherCAT network



Features

The following figures give an overview of the elements and connections on the devices. Position, size and appearance of elements and connections may vary depending on the capacity and size of the equipment.

Some equipment may be optional.

Example of 0.25 kW ... 0.37 kW

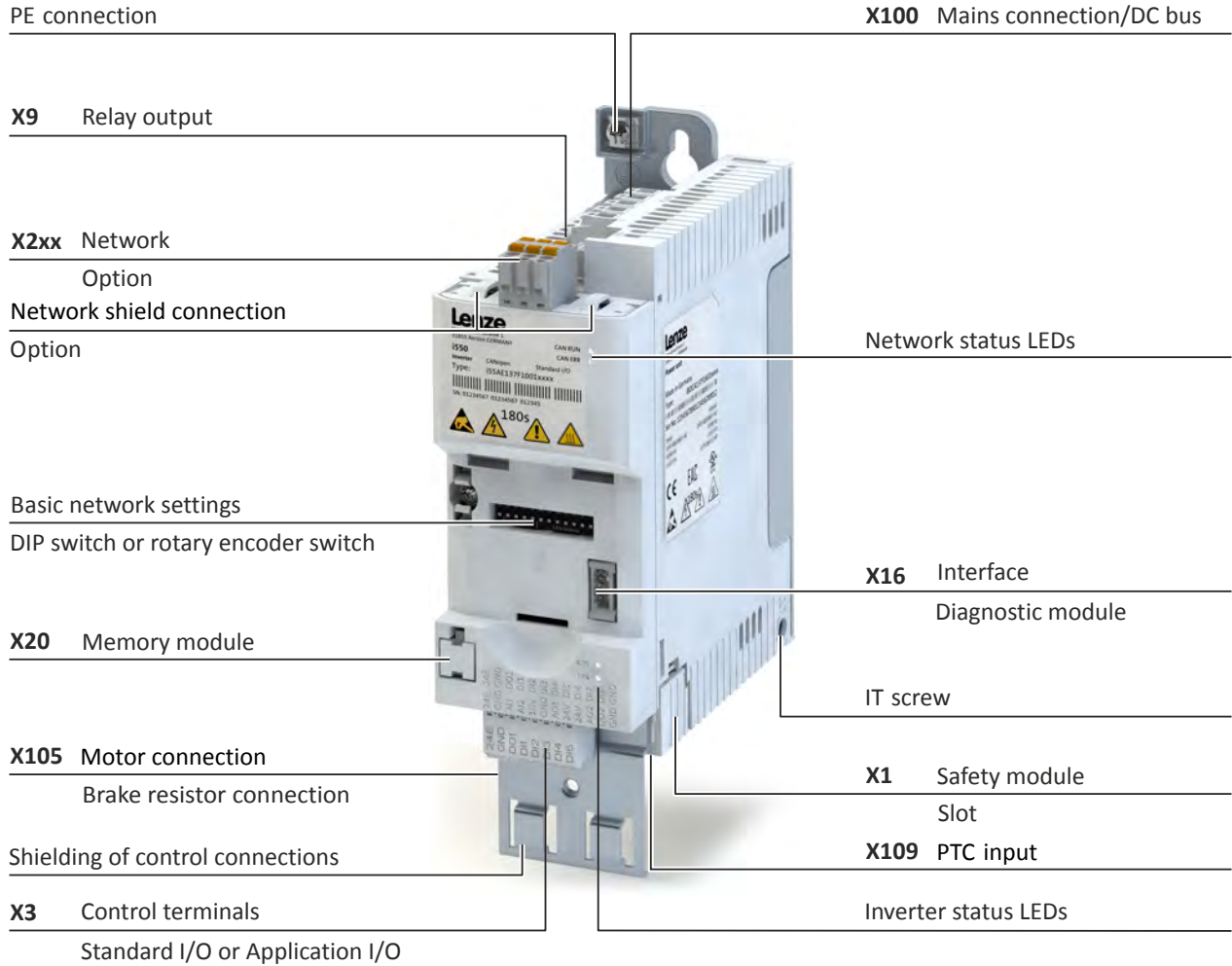

Product information

Features



Example of 0.55 kW ... 4 kW

PE connection

X100 Mains connection/DC bus

X9 Relay output

IT screw from 0.55 kW

X2xx Network

Option

Network shield connection

Network status LEDs

Option

Basic network settings

DIP switch or rotary encoder switch

X16 Interface

Diagnostic module

X20 Memory module

IT screw

X105 Motor connection

Brake resistor connection

X1 Safety module

Slot

Shielding of control connections

X109 PTC input

X3 Control terminals

Standard I/O or Application I/O

Inverter status LEDs





Example of 5.5 kW ... 11 kW

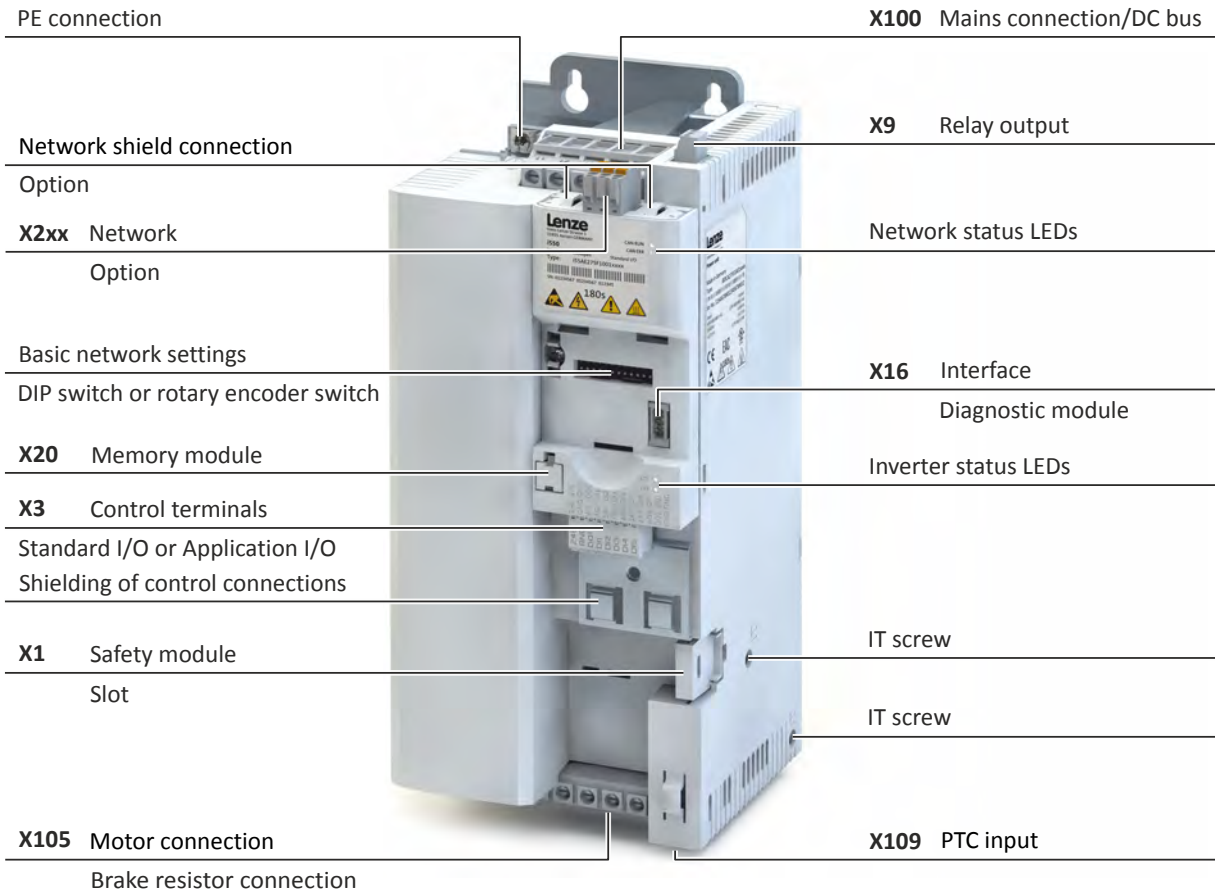

Product information

Features



Example of 15 kW ... 22 kW

X100 Mains connection/DC bus

X2xx Network

Option
PE connection

Network shield connection

Option

IT screw

X9 Relay output

Network status LEDs

Basic network settings

DIP switch or rotary encoder switch

X16 Interface

Diagnostic module

X20 Memory module

X3 Control terminals

Standard I/O or Application I/O

Shield connection slot

X1 Safety module

Slot

IT screw

X109 PTC input

X105 Motor connection

Brake resistor connection

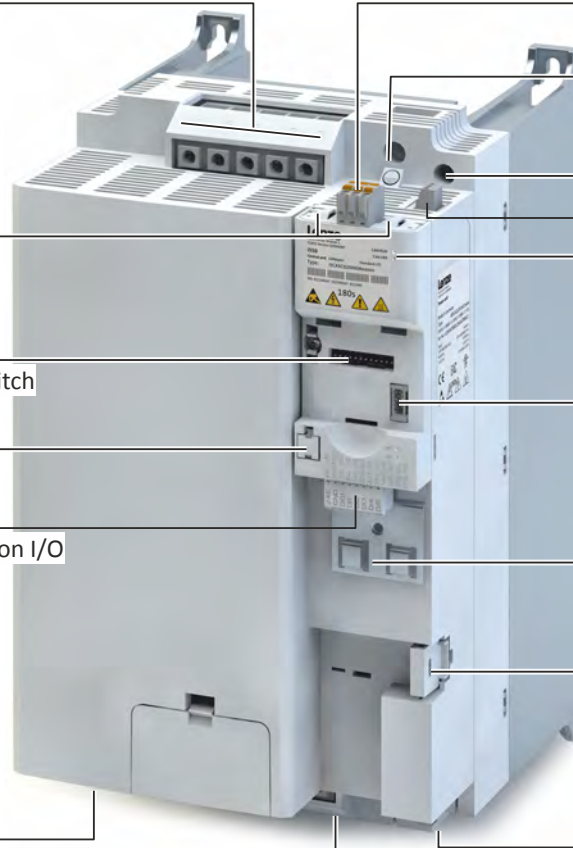



Example of 30 kW ... 45 kW

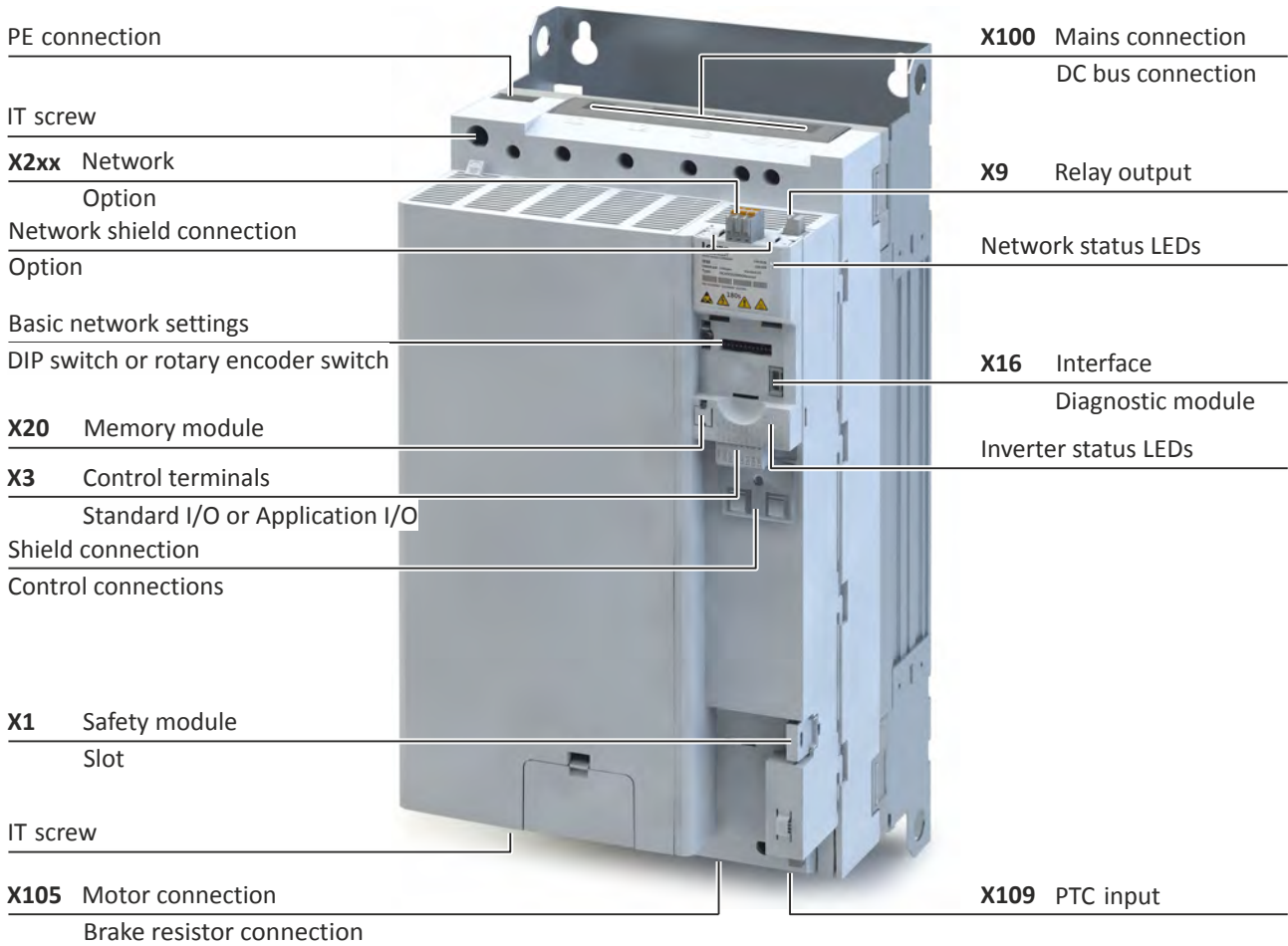

Product information

Features



Example of 55 kW ... 75 kW

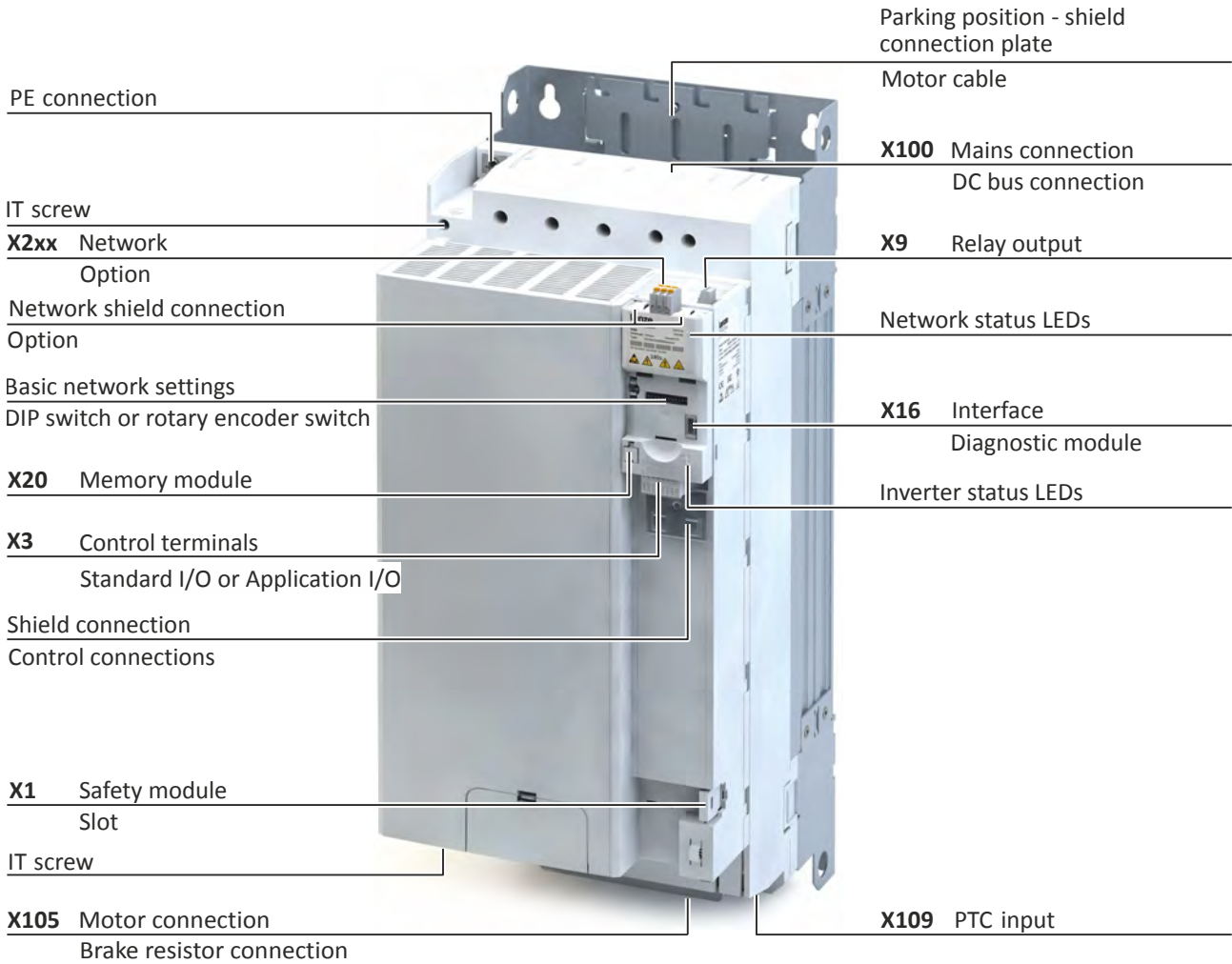



Example of 90 kW ... 110 kW

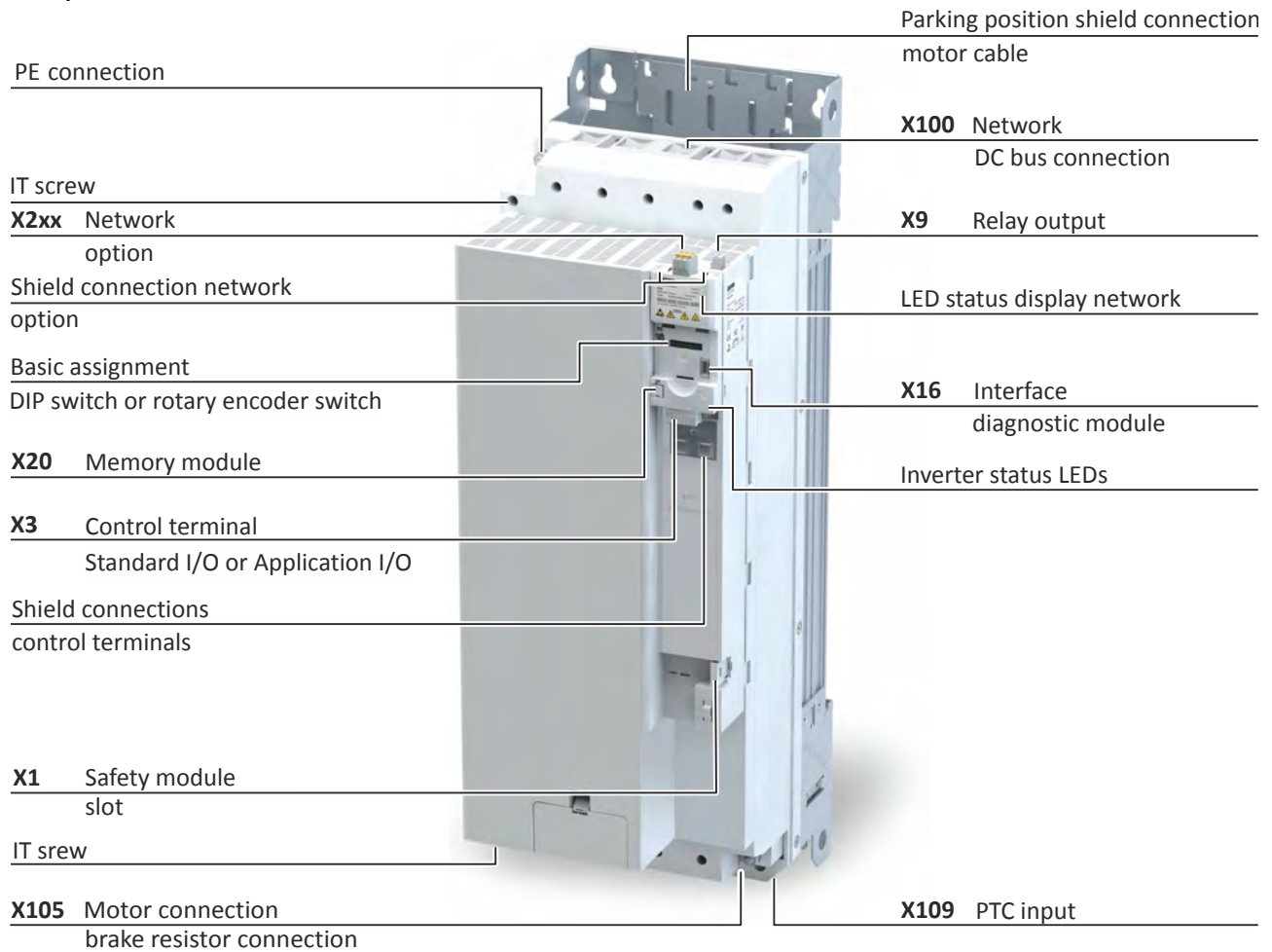

Position and meaning of the nameplates

Complete inverter		Inverter consisting of components	
①	Technical data of the inverter	①	Technical data of the component
④	Technical data of the control unit Type and serial number of the inverter	②	Type and serial number of the component
		③	Technical data, type and serial number of the safety module

Product information

The modular system
The concept



The modular system

The concept

Thanks to its flexible concept and modular structure consisting of power unit, control unit and safety module, the inverter can be optimally adapted to the application.

This provides the user with a flexible logistics concept - ordered as a complete inverter or single components.

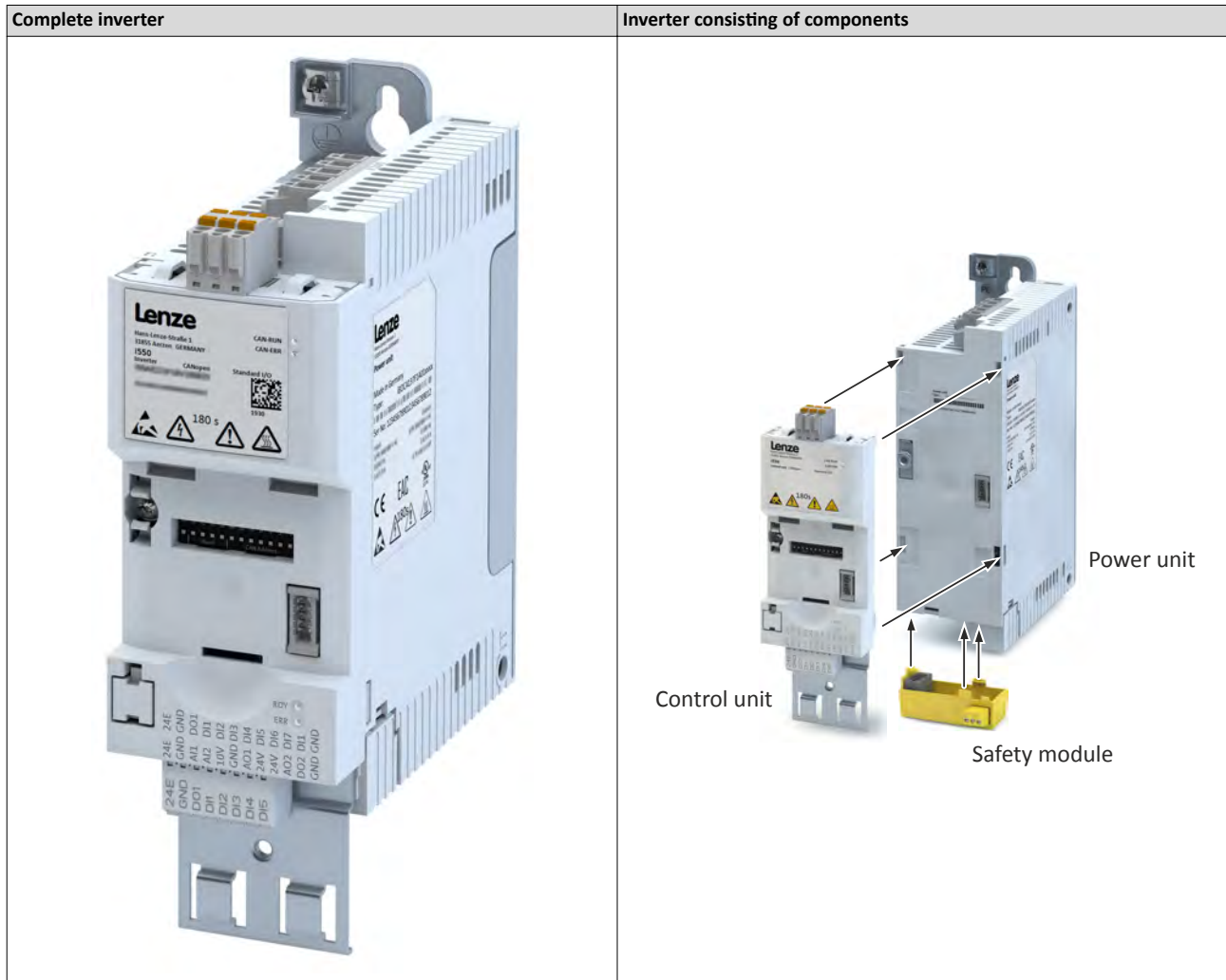

Power unit

The power unit is the power section of the inverter.

It is available in the power range from 0.25 kW to 110 kW.

Control unit

The control unit is the open and closed-loop control unit.

It contains I/O connections, an optional network, the interface for diagnostic modules, LED status displays and the memory module.

Safety module

The optional safety module is available with the functional safety STO (Safe torque off).



Product information



The modular system
Topologies / network

Topologies / network

The inverters can be equipped with different fieldbus networks.

The topologies and protocols typical for the prevailing networks are supported.

Currently available networks:

	<p>CANopen® is a communication protocol based on CAN. CANopen® is a registered community trademark of the CAN user organisation CiA® (CAN in Automation e. V.). Device descriptions for the download: EDS files for Lenze devices</p>
	<p>The Modbus protocol is an open communication protocol based on a client/server architecture and developed for the communication with programmable logic controllers. Further development is carried out by the international user organisation Modbus Organization, USA.</p>
	<p>PROFIBUS® (Process Field Bus) is a widely-used fieldbus system for the automation of machines and production plants. PROFIBUS® is a registered trademark and patented technology licensed by the PROFIBUS & PROFINET International (PI) user organisation. Device descriptions for the download: GSD files for Lenze devices</p>
	<p>Safety over EtherCAT® is a registered trademark and patented technology, licensed by Beckhoff Automation GmbH, Germany.</p>
	<p>EtherCAT® (Ethernet for Controller and Automation Technology) is an Ethernet-based fieldbus system which fulfils the application profile for industrial realtime systems EtherCAT® is a registered trademark and patented technology, licensed by Beckhoff Automation GmbH, Germany. Device descriptions for the download: XML/ESI files for Lenze devices</p>
	<p>EtherNet/IP™ (EtherNet Industrial Protocol) is a fieldbus system based on Ethernet which uses the Common Industrial Protocol™ (CIP™) for data exchange. EtherNet/IP™ and Common Industrial Protocol™ (CIP™) are trademarks and patented technologies, licensed by the user organisation ODVA (Open DeviceNet Vendor Association), USA. Device descriptions for the download: EDS files for Lenze devices</p>
	<p>PROFINET® (Process Field Network) is a real-time capable fieldbus system based on Ethernet. PROFINET® is a registered trademark and patented technology licensed by the PROFIBUS & PROFINET International (PI) user organisation. Device descriptions for the download: GSDML files for Lenze devices</p>
	<p>Ethernet POWERLINK is and Ethernet-based fieldbus system which fulfils the application profile for industrial real-time systems. POWERLINK is an open technology. Detailed information on POWERLINK can be found on the web page of the Ethernet POWERLINK Standardization Group (EPSG): http://www.ethernet-powerlink.org</p>
	<p>IO-Link is the standardized IO technology (IEC 61131-9) for communication with sensors and actuators. Point-to-point communication is based on the 3-wire sensor and actuator connection without additional requirements concerning the cable material. IO-Link is a registered trademark. It may only be used by members of the IO-Link community and non-members that have purchased the corresponding license. Detailed information on the usage can be found in the IO-Link Community Rules at www.io-link.com.</p>

More information on the supported networks can be found at:

<http://www.lenze.com>

Product information

The modular system
Ways of commissioning



Ways of commissioning

There are three methods to commission the inverter quickly and easily.

Thanks to Lenze's engineering philosophy, the high functionality is still easy to grasp. Parameterisation and set-up are impressive thanks to clear structure and simple dialogues, leading to the desired outcome quickly and reliably.

Keypad

If it's only a matter of setting a few key parameters such as acceleration and deceleration time, this can be done quickly on the keypad.



»EASY Starter«

If functions such as the holding brake control or sequencer need to be set, it's best to use the »EASY Starter« engineering tool.



SMART Keypad App

The SMART Keypad App for Android or iOS allows you to diagnose and parameterize an Inverter i500. A WLAN module on the i500 inverter is required for communication.

- Ideal for the parameterization of simple applications such as a conveyor belt.
- Ideal for the diagnostics of the inverter.

The Lenze SMART Keypad App can be found in the Google Play Store or in the Apple App Store.

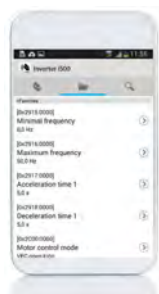

Android



iOS



Functions

Overview

With regard to their functionality, the inverters i550 are adapted to extensive applications. This is also reflected in the overall scope of the products.

Functions	
Motor control	Monitoring
V/f characteristic control linear/square-law (VFC plus)	Short circuit
V/f characteristic control (VFC closed loop)	Earth fault
Energy saving function (VFC-Eco)	Device overload (i^*t)
Sensorless vector control (SLVC)	Motor overload (i^2*t)
Sensorless control for synchronous motors (SL-PSM) (up to 22 kW, from 30 kW ... 75 kW: in preparation)	Mains phase failure
Servo control for asynchronous motors (SC-ASM)	Stall protection
Motor functions	Motor current limit
Flying restart circuit	Maximum torque
Slip compensation	Ultimate motor current
DC braking	Motor speed
Oscillation damping	Load loss detection
Skip frequencies	Motor temperature
Automatic identification of the motor data	Diagnostics
Braking energy management	Error history buffer
Holding brake control	Logbook
Voltage add – function	LED status displays
Rational Energy Ride Through (RERT)	Keypad language selection German, English
Speed feedback (HTL encoder)	Network
Brake resistor control (brake chopper integrated)	CANopen
Frequency setpoint	Modbus RTU
DC-bus connection (400V devices)	Modbus TCP
Application functions	PROFIBUS
Process controller	EtherCAT
Access protection	EtherNet/IP
Process controller sleep mode and rinse function	PROFINET
Freely assignable favorite menu	POWERLINK
Parameter change-over	IO-Link
S-shaped ramps for smooth acceleration	Safety functions
Motor potentiometer	STO (Safe Torque Off)
Flexible I/O configuration	
Automatic restart	
OEM parameter set	
Complete control with 8-key keypad	
UPS operation	
Frequency output via digital output DO1	
"Light Duty" load characteristic can be adjusted for selected inverters	

Product information

Features
Motor control types



Motor control types

The following table contains the possible control types with Lenze motors.

Motors	V/f characteristic control VFCplus	Sensorless vector control SLVC	ASM servo control SC ASM
Three-phase AC motors			
MD	•	•	•
MF	•	•	•
mH	•	•	•
m500	•	•	•

Lenze synchronous servo motors are not suitable for the use with inverters, e. g. the MCS, MCM or m850 types.

Features

Motor setting range

Rated point 120 Hz



Only possible with Lenze MF motors.

The rated motor torque is available up to 120 Hz.

Compared to the 50-Hz operation, the setting range increases by 2.5 times.

Thus, a smaller motor can be selected at the same rated power.

V/f at 120 Hz

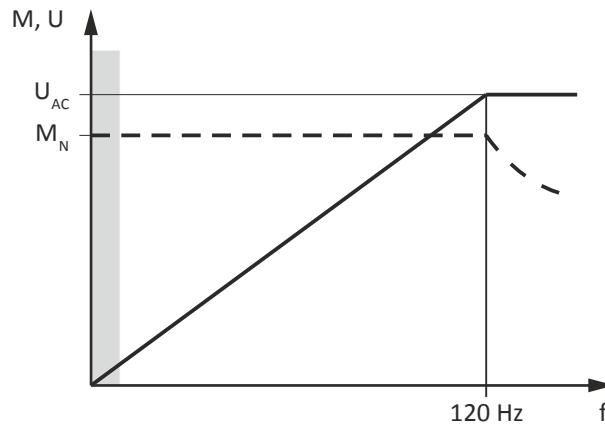

V Voltage
M Torque
f Frequency

U_{AC} Mains voltage
 M_N Rated torque



Rated point 87 Hz

The rated motor torque is available up to 87 Hz.

Compared to the 50-Hz operation, the setting range increases by 1.74 times.

For this purpose, a motor with 230/400 V in star connection is driven by a 400-V inverter.

The inverter must be dimensioned for a rated motor current of 230 V.

V/f at 87 Hz

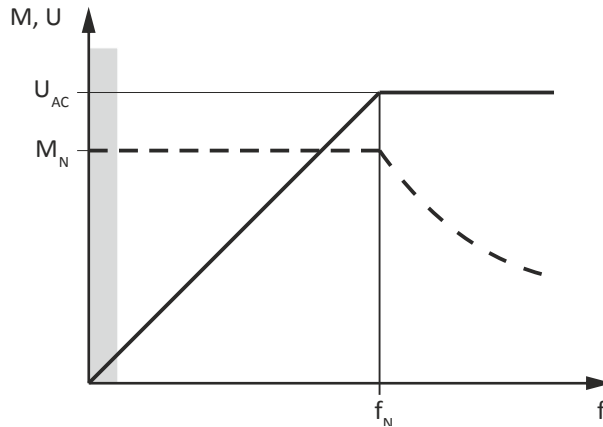

V	Voltage	U_{AC}	Mains voltage
M	Torque	M_{rated}	Rated torque
f	Frequency	f_{rated}	Rated frequency

Rated point 50 Hz

The rated motor torque is available up to 50 Hz.

V/f at 50 Hz

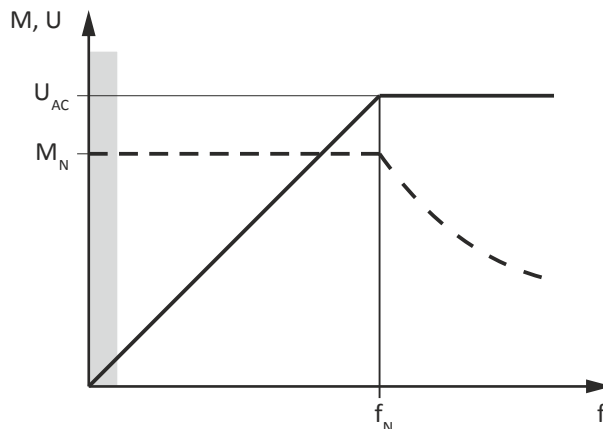

V	Voltage	U_{AC}	Mains voltage
M	Torque	M_{rated}	Rated torque
f	Frequency	f_{rated}	Rated frequency

Information on project planning

Project planning process
Dimensioning



Information on project planning

Project planning process

Dimensioning

3 methods for dimensioning

Fast: Selection of the inverter based on the motor data of a 4-pole asynchronous motor.

Detailed: In order to optimise the selection of the inverter and all drive components, it is worth to execute the detailed system dimensioning based on the physical requirements of the application. For this purpose, Lenze provides the «Drive Solution Designer» (DSD) design program.

Manual: The following chapter guides you step by step to the selection of a drive system.

Workflow of a configuration process

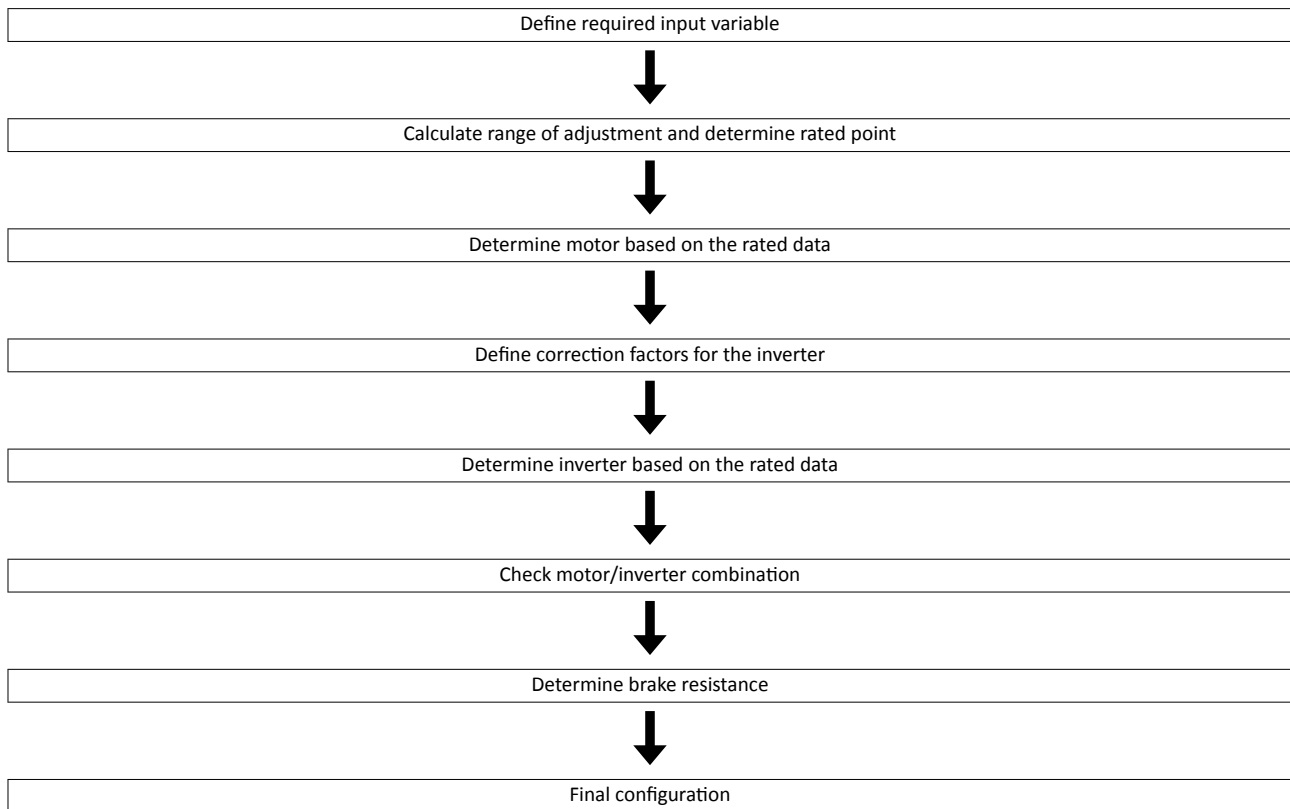

Define required input variables

Operating mode			S1 or S6
Max. load torque	$M_{L,max}$	Nm	
Max. load speed	$n_{L,max}$	rpm	
Min. load speed	$n_{L,min}$	rpm	
Site altitude	H	m	
Temperature in the control cabinet	T_U	°C	



Calculate range of adjustment and determine rated point

	Calculation
Setting range	$V = \frac{n_{L,max}}{n_{L,min}}$

	Setting range	Rated point
Motor with integral fan	≤ 2.50 (20 - 50 Hz)	50 Hz
	≤ 4.35 (20 - 87Hz)	87 Hz
	≤ 6 (20 - 120Hz)	120 Hz
Motor with blower	≤ 10.0 (5 - 50 Hz)	50 Hz
Motor with integral fan (reduced torque)	≤ 17.4 (5 - 87Hz)	87 Hz
	≤ 24 (5 - 120Hz)	120 Hz

Determine motor based on the rated data

			Check
Rated torque			
Operating mode S1	M_{rated}	Nm	$M_N \geq \frac{M_{L,max}}{T_{H,Mot} \times T_{U,Mot}}$
Operating mode S6	M_{rated}	Nm	$M_N \geq \frac{M_{L,max}}{2 \times T_{H,Mot} \times T_{U,Mot}}$
Rated speed	n_{rated}	rpm	$n_{rated} \geq n_{L,max}$ $\frac{n_n}{V} \leq n_{L,min}$

			Note
Rated torque	M_{rated}	Nm	→ Rated motor data
Rated speed	n_{rated}	rpm	
Rated point at		Hz	→ setting range
Power factor	cos φ		→ Rated motor data
Rated current	$I_{N,MOT}$	A	
Rated power	P_{rated}	kW	
Correction factor - site altitude	$T_{H,MOT}$		→ Technical motor data
Correction factor - ambient temperature	$T_{U,MOT}$		
Select motor			

Correction factors for the inverter

Site altitude Amsl	H			
[m]	≤ 1000	≤ 2000	≤ 3000	≤ 4000
$k_{H,INV}$	1.00	0.95	0.90	0.85

Temperature in the control cabinet	T_U			
[°C]	≤ 40	≤ 45	≤ 50	≤ 55

Switching frequency		T_U			
2 or 4 kHz	$k_{TU,INV}$	≤ 40	≤ 45	≤ 50	≤ 55
8 or 16 kHz		1.00	0.875	0.750	0.625

Switching frequency with the "Light Duty" load characteristic		T_U			
2 or 4 kHz	$k_{TU,INV}$	≤ 40	≤ 45	≤ 50	≤ 55
8 or 16 kHz		-	-	-	-

Determine inverter based on the rated data

			Check
Output current			
Continuous operation	I_{out}	A	$I_{out} \geq I_{N,Mot} / (k_{H,INV} \times k_{TU,INV})$
Overcurrent operation cycle 15 s	I_{out}	A	$I_{out} \geq I_{N,Mot} \times 2 / (k_{H,INV} \times k_{TU,INV})$
Overcurrent operation cycle 180 s	I_{out}	A	$I_{out} \geq I_{N,Mot} \times 1.5 / (k_{H,INV} \times k_{TU,INV})$

Information on project planning

Project planning process
Dimensioning



Determine the inverter based on the rated data for the "Light Duty" load characteristic

			Check
Output current			
Continuous operation	I_{out}	A	$I_{out} \geq I_{N,Mot} / (k_{H,INV} \times k_{TU,INV})$
Overcurrent operation cycle 15 s	I_{out}	A	$I_{out} \geq I_{N,Mot} \times 1.65 / (k_{H,INV} \times k_{TU,INV})$
Overcurrent operation cycle 180 s	I_{out}	A	$I_{out} \geq I_{N,Mot} \times 1.25 / (k_{H,INV} \times k_{TU,INV})$

Check motor/inverter combination

			Calculation
Motor torque	M	Nm	$M = \sqrt{\left(\frac{I_{out,INV}}{I_{N,MOT}}\right)^2 - (1 - \cos\varphi^2)} \times \frac{M_N}{\cos\varphi}$

			Check
Overload capacity of the inverter			$\frac{M_{L,max}}{M} \leq 1.5$

Braking operation without additional measures

To decelerate small masses, the "DC injection brake DCB" function can be parameterised. DC-injection braking enables a quick deceleration of the drive to standstill without the need for an external brake resistor.

- A code can be used to select the braking current.
- The maximum braking torque to be realised by the DC braking current amounts to approx. 20 ... 30 % of the rated motor torque. It is lower compared to braking action in generator mode with external brake resistor.
- Automatic DC-injection braking (Auto-DCB) improves the starting performance of the motor when the operation mode without speed feedback is used.

Braking operation with external brake resistor

To decelerate greater moments of inertia or with a longer operation in generator mode an external brake resistor is required. It converts braking energy into heat.

The brake resistor is connected if the DC-bus voltage exceeds the switching threshold. This prevents the controller from setting pulse inhibit through the "Overvoltage" fault and the drive from coasting down. The external brake resistor serves to control the braking process at any time.

The brake chopper integrated in the controller connects the external brake resistor.

Determine brake resistance



			Application	
			With active load	With passive load
Rated power	P_{rated}	kW	$P_N \geq P_{max} \times \eta_e \times \eta_m \times \frac{t_1}{t_2}$	$P_N \geq \frac{P_{max} \times \eta_e \times \eta_m \times t_1}{2} \times \frac{t_1}{t_2}$
Thermal capacity	C_{th}	kWs	$C_{th} \geq P_{max} \times \eta_e \times \eta_m \times t_1$	$C_{th} \geq \frac{P_{max} \times \eta_e \times \eta_m \times t_1}{2}$
Rated resistance	R_{rated}	Ω	$R_N \geq \frac{U_{DC}^2}{P_{max} \times \eta_e \times \eta_m}$	

- Active load Can start to move independent of the drive (e.g. unwinder)
- Passive load Can stop independent of the drive (e.g. horizontal travelling drives, centrifuges, fans)
- U_{DC} [V] Switching threshold - brake chopper
- P_{max} [W] Maximum occurring braking power
- η_e Electrical efficiency
- η_m Mechanical efficiency
- t_1 [s] Braking time
- t_2 [s] Cycle time = time between two successive braking processes (t_1 + dead time)



Final configuration

Product extensions and accessories can be found here:

- [Product extensions](#)  160
- [Accessories](#)  185

Operation in motor and generator mode

The energy analysis differs between operation in motor mode and generator mode.

During operation in motor mode, the energy flows from the supplying mains via the inverter to the motor which converts electrical energy into mechanical energy (e. g. for lifting a load).

During operation in generator mode, the energy flows back from the motor to the inverter. The motor converts the mechanical energy into electrical energy - it acts as a generator (e. g. when lowering a load).

The drive brakes the load in a controlled manner.

The energy recovery causes a rise in the DC-bus voltage. If this voltage exceeds an upper limit, the output stage of the inverter will be blocked to prevent the device from being destroyed.

The drive coasts until the DC-bus voltage reaches the permissible value range again.

In order that the excessive energy can be dissipated, a brake resistor or a regenerative module is required.

Information on project planning

Project planning process
Overcurrent operation



Overcurrent operation

The inverters can be driven at higher amperages beyond the rated current if the duration of this overcurrent operation is time limited.

Two utilisation cycles of 15 s and 180 s are defined. Within these utilisation cycles, an overcurrent is possible for a certain time if afterwards an accordingly long recovery phase takes place.

Cycle 15 s

During this operation, the inverter may be loaded for 3 s with up to 200 % of the rated current if afterwards a recovery time of 12 s with max. 75 % of the rated current is observed. A cycle corresponds to 15 s.

Cycle 180 s

During this operation, the inverter may be loaded for 60 s with up to 150 % of the rated current if afterwards a recovery time of 120 s with max. 75 % of the rated current is observed. A cycle corresponds to 180 s.

Monitoring of the device utilization ($I \times t$) activates the set error response if the utilization value exceeds the threshold of 100 %.



The maximum output currents correspond to the switching frequencies and the overload behaviour of the inverters are given in the rated data.

In case of rotating frequencies < 10 Hz, the time-related overload behaviour may be reduced.

The graphics shows a cycle. The basic conditions given in the table (graphics field highlighted in grey) have to be complied with in order that the inverter will not be overloaded. Both cycles can be combined with each other.

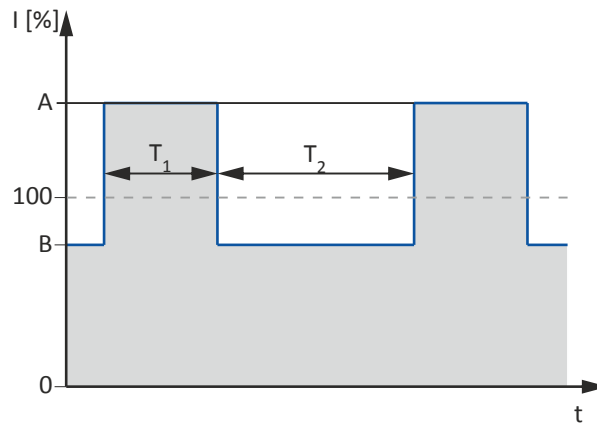

	Max. output current	Max. overload time	Max. output current during the recovery time	Min. recovery time
	A	T_1	B	T_2
	%	s	%	s
Cycle 15 s	200	3	75	12
Cycle 180 s	150	60	75	120



Inverter load characteristics

The inverter has two different load characteristics: "Light Duty" and "Heavy Duty". The "Light Duty" load characteristic allows for a higher output current with restrictions regarding overload capacity, ambient temperature and switching frequency. This allows the motor required for the application to be driven by a less powerful inverter. Select the load characteristic according to the application.

Heavy Duty compared to Light Duty

This table compares the two load characteristics:

	Heavy Duty	Light duty
Characteristics	High dynamic requirements	Low dynamic requirements
Typical applications	Main tool drives, travelling drives, hoist drives, winders, forming drives and conveyors	Pumps, fans, general horizontal materials handling technology and line drives
Overload capacity	3 s/200 %, 60 s/150 % See technical data	Restricted Ssee technical data



Devices with Light Duty load characteristic: See [100](#), [116](#), [139](#)

Comply with all data for this load characteristic and the corresponding mains voltage range. This comprises the information on the type of installation as well as the required fuses, cable cross-sections, mains chokes and filters.

Information on project planning

Safety instructions
Basic safety instructions



Safety instructions

Disregarding the following basic safety measures and safety information may lead to severe personal injury and damage to property!

Observe all specifications of the corresponding documentation supplied. This is the precondition for safe and trouble-free operation and for obtaining the product features specified.

Please observe the specific safety information in the other sections!

Basic safety instructions

DANGER!

Dangerous electrical voltage

Possible consequences: Death or severe injuries from electric shock

- ▶ Any work on the device must only be carried out in a deenergized state.
- ▶ After switching off the mains voltage, observe the signs on the product.

Product

- The product must only be used as directed.
- Never commission the product in the event of visible damage.
- The product must never be technically modified.
- Never commission the product before assembly has been completed.
- The product must never be operated without required covers.
- Connect/disconnect all pluggable terminals only in de-energized condition.
- Only remove the product from the installation in the deenergized state.

Personnel

Only qualified and skilled personnel are allowed to work with the product. IEC 60364 and/or CENELEC HD 384 define the qualifications of these persons as follows:

- They are familiar with the installation, mounting, commissioning, and operation of the product.
- They possess the appropriate qualifications for their tasks.
- They are familiar with all regulations for the prevention of accidents, directives, and laws applicable at the location and are able to apply them.

Process engineering

The procedural notes and circuit details described are only proposals. It is up to the user to check whether they can be adapted to the particular applications. Lenze does not take any responsibility for the suitability of the procedures and circuit proposals described.

Device protection

- The maximum test voltage for insulation tests between a control potential of 24 V and PE must not exceed 110 V DC (EN 61800–5–1).



Application as directed

- The product serves to control three-phase AC motors and servo motors.
- The product must only be actuated with motors that are suitable for the operation with inverters.
- The product is not a household appliance, but is only designed as a component for commercial or professional use in terms of EN 61000-3-2.
- The product is solely suited to be installed in control cabinets or similar closed electrical operating areas.
- The product must only be actuated under the operating conditions and power limits specified in this documentation.
- The product meets the protection requirements of 2014/35/EU: Low-Voltage Directive.
- The product is not a machine in terms of 2006/42/EU: Machinery Directive, with the exception of all functions of the functional safety.
- Commissioning or starting the operation as directed of a machine with the product is not permitted until it has been ensured that the machine meets the regulations of the EC Directive 2006/42/EU: Machinery Directive observe; EN 60204-1 .
- Commissioning or starting operation as directed is only permissible if the EMC Directive 2014/30/EU is complied with.
- In residential areas, the product may cause EMC interferences. The operator is responsible for taking interference suppression measures.

Additional information for the intended use in North America:

The cables must be installed in accordance with US National Electrical Code NFPA 70 or Canadian Electrical Code C22.1.

The user is not allowed to change inverters that come with integrated safety technology.



The user must not carry out any repairs on the safety module.

The safety module is not a spare part.

The safety module must not be removed.

If the safety module is defective, the inverter has to be replaced.

Use of explosion-proof motors

Explosion-proof motors that are not designed for use with an inverter invalidate their approval when used for variable speed applications. Due to the many areas of liability that may arise when handling these applications, the following declaration of principle applies:



The inverters from Lenze are sold without warranty of suitability for a particular purpose or warranty of suitability for use in explosion-proof motors. Lenze assumes no responsibility for any direct, incidental, or consequential damages, costs, or losses that may result from the use of AC inverters in these applications. The purchaser explicitly agrees to assume any risk of loss, cost or damage that may result from such use.

Foreseeable misuse

Inverters are not to be operated with DC motors.

Information on project planning

Safety instructions
Handling



Handling

Transport, storage

Observe the notes regarding transport, storage and correct handling. Ensure proper handling and avoid mechanical stress. Do not bend any components and do not change any insulation distances during transport or handling. Do not touch any electronic components and contacts. Inverters contain electrostatically sensitive components which can easily be damaged by inappropriate handling. Do not damage or destroy any electrical components since thereby your health could be endangered!

Installation

The technical data and supply conditions can be obtained from the nameplate and the documentation. They must be strictly observed.

The inverters have to be installed and cooled according to the regulations given in the corresponding documentation. Observe the climatic conditions according to the technical data. The ambient air must not exceed the degree of pollution 2 according to EN 61800-5-1.

Electrical connection

When working on energized inverters, comply with the applicable national accident prevention regulations.

The electrical installation must be carried out according to the appropriate regulations (e. g. cable cross-sections, fuses, PE connection). Additional information can be obtained from the documentation.

The documentation contains information about installation according to EMC regulations (shielding, grounding, filters and cable routing). Please also observe this information for CE-marked inverters. The manufacturer of the system or machine is responsible for adherence to the limit values required in connection with EMC legislation. The inverters must be installed in housings (e. g. control cabinets) to meet the limit values for radio interferences valid at the site of installation. The housings must enable an EMC-compliant installation. Observe in particular that e. the control cabinet doors should have a circumferential metal connection to the housing. Reduce housing openings and cutouts to a minimum.

Protection in the event of short circuit or earth fault

To ensure protection in accordance with IEC 61800-5-1 in the event of an electrical short circuit or ground fault (protection against electric shock, thermal hazards and fire), the following must be taken into account in the installation:

- Use fuses according to the technical data.
- The installation must comply with the requirements of the IEC/HD 60364 (DIN VDE 0100; VDE 0100).
- The continuity of all associated protective conductors and equipotential bonding conductors including all connection points must be ensured.
- If the maximum permissible switch-off time according to IEC 60364-4-41 is exceeded with a high system impedance (especially with TT mains) or a high loop impedance with the prescribed fuses, a residual current device (RCD) can be used. Alternatively, other protective measures can be used, e. g. isolation from the environment by means of double or reinforced insulation, or isolation from the supply system by using a transformer.
- If a residual current device (RCD) is connected upstream of the inverter for protection in the event of an earth fault, only type B/B+ is permitted.

Operation

If necessary, systems including inverters must be equipped with additional monitoring and protection devices. Also comply with the safety regulations and provisions valid at the installation site.

After the inverter has been disconnected from the supply voltage, all live components and power terminals must not be touched immediately because capacitors can still be charged. Please observe the corresponding stickers on the inverter.

All protection covers and doors must be shut during operation.



You may adapt the inverters to your application by parameter setting within the limits available. For this, observe the notes in the documentation.

Safety functions

Certain inverter versions support safety functions (e. g. "safe torque off", formerly "safe standstill") according to the requirements of the EC Machinery Directive 2006/42/EU. The notes on the integrated safety provided in this documentation must be observed.

Maintenance and servicing

The inverters do not require any maintenance if the prescribed operating conditions are observed.

Disposal

In accordance with the current provisions, Lenze products and accessories have to be disposed of by means of professional recycling. Lenze products contain recyclable raw material such as metal, plastics and electronic components.

Information on project planning

Safety instructions
Residual hazards



Residual hazards

Even if notes given are taken into consideration and protective measures are implemented, the occurrence of residual risks cannot be fully prevented.

The user must take the residual hazards mentioned into consideration in the risk assessment for his/her machine/system.

If the above is disregarded, this can lead to severe injuries to persons and damage to property!

Product

Observe the warning labels on the product!



Dangerous electrical voltage:

Before working on the product, make sure there is no voltage applied to the power terminals!

After mains disconnection, the power terminals will still carry the hazardous electrical voltage for the time given next to the symbol!



Electrostatic sensitive devices:

Before working on the product, the staff must ensure to be free of electrostatic charge!



High leakage current:

Carry out fixed installation and PE connection in compliance with:
EN 61800-5-1 / EN 60204-1



Hot surface:

Use personal protective equipment or wait until the device has cooled down!

Protection of persons

Before working on the inverter, check if no voltage is applied to the power terminals.

- Depending on the device, the power terminals X105 remain live for up to 3 ... 20 minutes.
- The power terminals X100 and X105 remain live even when the motor is stopped.

Degree of protection - protection of persons and device protection

- Information applies to the mounted and ready-for-use state.
- Information does not apply to the wire range of the terminals.
 - Terminals that are not wired have low protection against physical contact.
 - Terminals for large cable cross-sections have lower classes of protection, e. g. from 15 kW IP10 only.

Motor protection

With some settings of the inverter, the connected motor can overheat.

- E. g. by longer operation of self-ventilated motors at low speed.
- E. g. by longer operation of the DC-injection brake.

Protection of the machine/system

Drives can reach dangerous overspeeds.

- E. g. by setting high output frequencies in connection with motors and machines not suitable for this purpose.
- The inverters do not provide protection against such operating conditions. For this purpose, use additional components.

Switch contactors in the motor cable only if the controller is inhibited.

- Switching while the inverter is enabled is only permissible if no monitoring functions are activated.

Motor

If there is a short circuit of two power transistors, a residual movement of up to 180°/number of pole pairs can occur at the motor! (e. g. 4-pole motor: residual movement max. $180^\circ/2 = 90^\circ$).



Parameter set transfer

During the parameter set transfer, control terminals of the inverters can adopt undefined states.

- Thus, the control terminal of the digital input signals have to be removed before the transfer.
- This ensures that the inverter is inhibited. The control terminals are in a defined state.

Information on project planning

Control cabinet structure
Arrangement of components



Control cabinet structure

Control cabinet requirements

- Protection against electromagnetic interferences
- Compliance with the ambient conditions of the installed components

Mounting plate requirements

- The mounting plate must be electrically conductive.
 - Use zinc-coated mounting plates or mounting plates made of V2A.
 - Varnished mounting plates are unsuitable, even if the varnish is removed from the contact surfaces.
- When using several mounting plates, make a conductive connection over a large surface (e. g. using grounding strips).

Arrangement of components

- Division into power and control areas

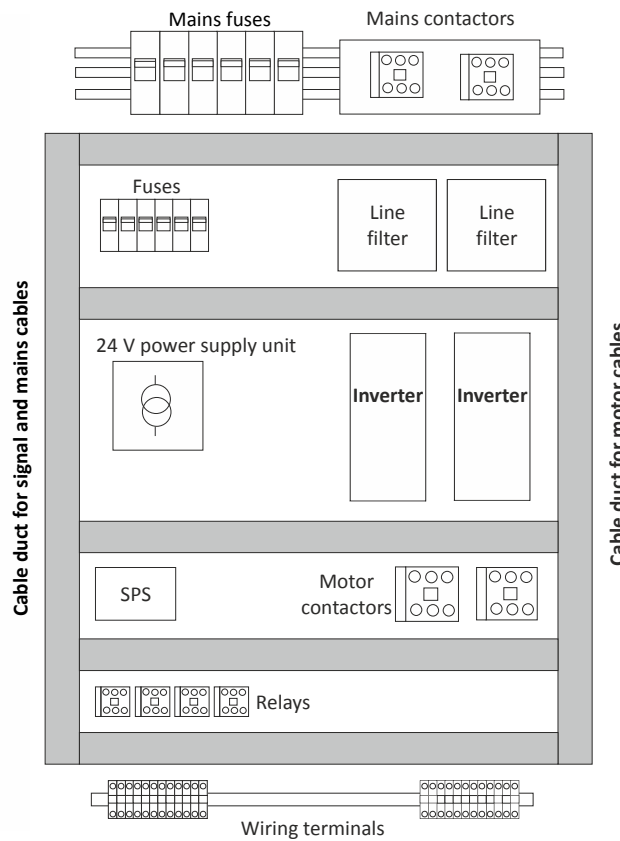

Fig. 1: Example for the ideal arrangement of components in the control cabinet



Cables

Requirements

- The cables used must correspond to the requirements at the location (e. g. EN 60204–1, UL).
- The cable cross-section must be dimensioned for the assigned fusing. Observe national and regional regulations.
- You must observe the regulations for minimum cross-sections of PE conductors. The cross-section of the PE conductor must be at least as large as the cross-section of the power connections.

Installation inside the control cabinet

- Always install cables close to the mounting plate (reference potential), as freely suspended cables act like aerials.
- Use separated cable channels for motor cables and control cables. Do not mix up different cable types in one cable channel.
- Lead the cables to the terminals in a straight line (avoid tangles of cables).
- Minimise coupling capacities and coupling inductances by avoiding unnecessary cable lengths and reserve loops.
- Short-circuit unused cores to the reference potential.
- Install the cables of a 24 V DC supply (positive and negative cable) close to each other or twisted over the entire length to avoid loops.

Installation outside the control cabinet

- In the case of greater cable lengths, a greater cable distance between the cables is required.
- In the case of parallel routing (cable trays) of cables with different types of signals, the degree of interference can be minimised by using a metallic cable separator or isolated cable ducts.

Earthing concept

- Set up the earthing system with a star topology.
- Connect all components (inverters, filters, chokes) to a central earthing point (PE rail).
- Comply with the corresponding minimum cross-sections of the cables.
- When using several mounting plates, make a conductive connection over a large surface (e. g. using grounding strips).

Information on mechanical installation

Important notes



Information on mechanical installation

Important notes

Measures for cooling during operation

- Ensure unimpeded ventilation of cooling air and outlet of exhaust air.
- If the cooling air is polluted (fluff, (conductive) dust, soot, grease, aggressive gases), take adequate countermeasures.
 - Install filters.
 - Arrange for regular cleaning of the filters.
- If required, implement a separate air guide.



Preparation

Further data and information for mechanical mounting:

▶ [Control cabinet structure](#) 40

▶ [Dimensions](#) 149



The scope of supply of the inverter comprises mounting instructions. They describe technical data and information on mechanical and electrical installation.

Mounting position

- Vertical alignment - all mains connections are at the top and the motor connections at the bottom.

Free spaces

- Maintain the specified free spaces above and below to the other installations.

Mechanical installation

- The mounting location and material must ensure a durable mechanical connection.
- Do not mount onto DIN rails!
- In case of continuous vibrations or shocks use vibration dampers.

How to mount the inverters onto the mounting plate.

Preconditions:

- Mounting plate with conductive surface

Required:

- Tool for drilling and thread cutting
- Screwdriver
- Screw and washer assemblies or hexagon socket screws with washers.

1. Prepare mounting plate with corresponding threaded holes.
2. Fit screws and washers (if applicable).
3. Do not yet tighten the screws.
4. Mount the inverter on the prepared mounting plate via keyhole suspension.
5. Only tighten the screws hand-tight.
6. Pre-assemble further units if necessary.
7. Align the units with each other.
8. Screw the units onto the mounting plate.

The inverters are mounted on the mounting plate. You can begin with the wiring.

Screw and washer assemblies or hexagon socket screws with washers are recommended..

M5 x \geq 10 mm for devices up to and including 2.2 kW

M5 x \geq 12 mm for devices up to and including 11 kW

M6 x \geq 16 mm for devices up to and including 22 kW

M8 x \geq 16 mm for devices up to and including 110 kW



Information on electrical installation

Important notes

DANGER!

Electrical voltage

Possible consequences: Death or severe injuries

- ▶ Any work on the inverter must only be carried out in the deenergised state.
 - ▶ Inverter up to 45 kW: After switching off the mains voltage, wait for at least 3 min before you start working.
 - ▶ Inverter from 55 kW onwards: After switching off the mains voltage, wait for at least 10 min before you start working.
-

DANGER!

Dangerous electrical voltage

The leakage current against earth (PE) is $> 3.5 \text{ mA AC}$ or $> 10 \text{ mA DC}$.

Possible consequences: Death or severe injuries when touching the device in the event of an error.

- ▶ Implement the measures requested in EN 61800-5-1 or EN 60204-1. Especially:
 - ▶ Fixed installation
 - ▶ The PE connection must comply with the standards (PE conductor diameter $\geq 10 \text{ mm}^2$ or use a double PE conductor)
-

DANGER!

Use of the inverter on a phase earthed mains with a rated mains voltage $\geq 400 \text{ V}$

The protection against accidental contact is not ensured without external measures.

- ▶ If protection against accidental contact according to EN 61800-5-1 is required for the control terminals of the inverters and the connections of the plugged device modules, ...
 - ▶ an additional basic insulation has to be provided.
 - ▶ the components to be connected have to come with a second basic insulation.
-

WARNING!

Dangerous electrical voltage

Device error causes an overvoltage in the system.

- ▶ For a voltage supply with DC 24 V ($\pm 20 \%$), use only a safely separated power supply unit according to the valid SELV/PELV requirements.
-



NOTICE

No protection against excessively high mains voltage

The mains input is not fused internally.

Possible consequences: Destruction of the product in the event of excessively high mains voltage.

- ▶ Take note of the maximum permissible mains voltage.
- ▶ On the mains supply side, use fuses to adequately protect the product against mains fluctuations and voltage peaks.

NOTICE

Overvoltage at devices with 230-V mains connection

An impermissible overvoltage may occur if the central supply of the N conductor is interrupted if the devices are connected to a TN three-phase system.

Possible consequences: Destruction of the device

- ▶ Provide for the use of isolating transformers.

NOTICE

The product contains electrostatic sensitive devices.

Possible consequences: Destruction of the device

- ▶ Before working in the connection area, the personnel must be free of electrostatic charge.

NOTICE

Pluggable terminal strips or plug connections

Plugging or removing the terminal strips or plug connections during operation may cause high voltages and arcing.

Possible consequences: Damage of the devices

- ▶ Switch off device.
- ▶ Only plug or remove the terminal strips or plug connections in deenergised status.

NOTICE

Use of mains filters and RFI filters in IT systems

Mains filters and RFI filters from Lenze contain components that are interconnected against PE.

Possible consequences: The filters may be destroyed when an earth fault occurs.

Possible consequences: Monitoring of the IT system may be triggered.

- ▶ Do not use mains filters and RFI filters from Lenze in IT systems.
- ▶ Before using the inverter in the IT system, remove the IT screws.



NOTICE

Overvoltage at components

In case of an earth fault in IT systems, intolerable overvoltages may occur in the plant.

Possible consequences: Destruction of the device.

- ▶ Before using the inverter in the IT system, the contact screws must be removed.
- ▶ Positions and number of the contact screws depend on the device.



Ensure a trouble-free operation:

Carry out the total wiring so that the separation of the separate potential areas is preserved.



When implementing machines and systems for the use in the UL/CSA scope, you have to observe the relevant special notes.

These notes are marked with "UL marking".



You have to install the devices into housings (e. g. control cabinets) to comply with valid regulations.

Stickers with warning notes must be displayed prominently and close to the device.

Preparation

Further data and information for electrical installation:

- ▶ [EMC-compliant installation](#) 47
- ▶ [Standards and operating conditions](#) 79



The scope of supply of the inverter comprises mounting instructions. They describe technical data and information on mechanical and electrical installation.



EMC-compliant installation

Structure of a CE-typical drive system

The drive system (inverter and drive) corresponds to 2014/30/EU: EMC Directive if it is installed according to the specifications of the CE-typical drive system.

The structure in the control cabinet must support the EMC-compliant installation with shielded motor cables.

- Please use sufficiently conductive shield connections.
- Connect the housing with shielding effect to the grounded mounting plate with a surface as large as possible, e. g. of inverters and RFI filters.
- Use central grounding points.

Matching accessories makes effective shielding easier.

- Motor shield plates as alternative shield connections for the motor cable
- Shield clips/shield clamps
- Metallic cable ties

The example below shows the effective wiring:

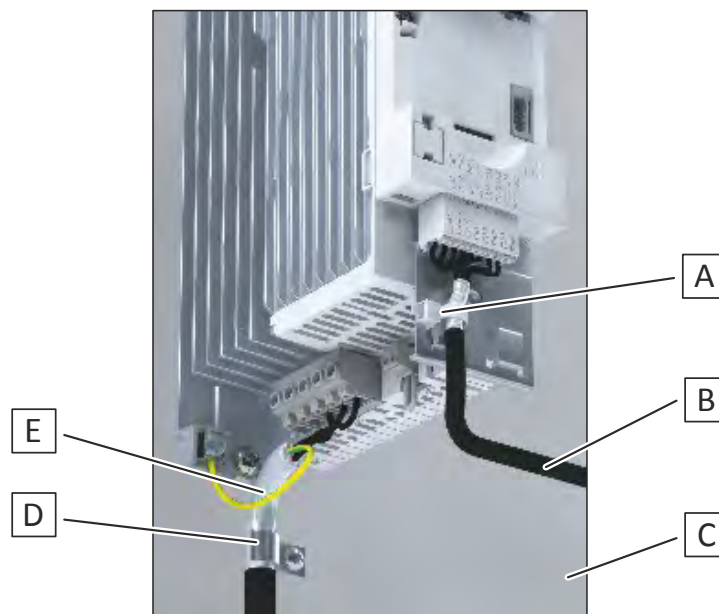

- | | | | |
|---|---|---|-------------------------------|
| A | Shield connection for control connections | C | EMC cable gland |
| B | Control cable | D | Motor cable with low capacity |
| E | Mains cable | | |

EMC-compliant installation in the control cabinet must be implemented with shielded motor cables of low capacity.

Capacitance per unit length:

- C-core-core/C-core-shielding: $< 75/150 \text{ pF/m} \leq 2.5 \text{ mm}^2 (\geq \text{AWG } 14)$;
- C-core-core/C-core-shielding: $< 150/300 \text{ pF/m} \geq 4 \text{ mm}^2 (\leq \text{AWG } 12)$

Mains connection, DC supply

- Inverters, mains chokes, or mains filters may only be connected to the mains via unshielded single cores or unshielded cables.
- When a line filter is used, shield the cable between mains filter or RFI filter and inverter if its length exceeds 300 mm. Unshielded cores must be twisted.
- In DC-bus operation or DC supply, use shielded cables.

Information on electrical installation

EMC-compliant installation



Motor cable

- Only use low-capacitance and shielded motor cables with braid made of tinned or nickel-plated copper.
 - The overlap rate of the braid must be at least 70 % with an overlap angle of 90 °.
 - Shields made of steel braids are not suitable.
- Shield the cable for motor temperature monitoring (PTC or thermal contact) and install it separately from the motor cable.
 - In Lenze system cables, the cable for the brake control is integrated into the motor cable. If this cable is not required for brake control, it can also be used to connect the motor temperature monitoring up to a length of 50 m.
 - Only certain inverters are provided with this connection facility.
- Connect the shield with a large surface and fix it with metal cable binders or conductive clamp. The following is suitable for the connection of the shield:
 - The mounting plate
 - A central grounding rail
 - A shield plate, if necessary, optional
- This is optimal:
 - The motor cable is separated from the mains cables and control cables.
 - The motor cable only crosses mains cables and control cables at right angles.
 - The motor cable is not interrupted.
- If the motor cable must be opened all the same (e. g. by chokes, contactors, or terminals):
 - The unshielded cable ends must not be longer than 100 mm (depending on the cable cross-section).
 - Install chokes, contactors, terminals etc. spatially separated from other components (with a minimum distance of 100 mm).
 - Install the shield of the motor cable directly before and behind the point of separation to the mounting plate with a large surface.
- Connect the shield with a large surface to PE in the terminal box of the motor at the motor housing.
 - Metal EMC cable glands at the motor terminal box ensure a large surface connection of the shield with the motor housing.

Control cables

- Install the cables so that no induction-sensitive loops arise.
- Distance of shield connections of control cables to shield connections of motor cables and DC cables:
 - At least 50 mm
- Control cables for analog signals:
 - Must always be shielded
 - Connect the shield on one side of the inverter
- Control cables for digital signals:

	Cable length		
	< ca. 5 m	ca. 5 m ... ca. 30 m	> ca. 30 m
Type	unshielded option	unshielded twisted option	always shielded connected on both sides

Network cables

- Cables and wiring must comply with the specifications and requirements of the used network.
 - Ensures the reliable operation of the network in typical systems.



Detecting and eliminating EMC interferences

Trouble	Cause	Remedy
Interferences of analog setpoints of your own or other devices and measuring systems	Unshielded motor cable has been used	Use shielded motor cable
	Shield contact is not extensive enough	Carry out optimal shielding as specified
	Shield of the motor cable is interrupted, e. g. by terminal strips, switches etc.	<ul style="list-style-type: none"> Separate components from other component parts with a minimum distance of 100 mm Use motor chokes or motor filters
	Additional unshielded cables inside the motor cable have been installed, e. g. for motor temperature monitoring	Install and shield additional cables separately
Conducted interference level is exceeded on the supply side	Too long and unshielded cable ends of the motor cable	Shorten unshielded cable ends to maximally 40 mm
	Terminal strips for the motor cable are directly located next to the mains terminals	Spatially separate the terminal strips for the motor cable from mains terminals and other control terminals with a minimum distance of 100 mm
	Mounting plate varnished	Optimise PE connection: <ul style="list-style-type: none"> Remove varnish Use zinc-coated mounting plate
	HF short circuit	Check cable routing

Information on electrical installation

Connection according to UL
Important notes



Connection according to UL

Important notes

⚠ WARNING!

- ▶ **UL marking**
 - ▶ The integral solid state short circuit protection included in the inverter does not provide branch circuit protection. Branch circuit protection must be provided in accordance with the National Electrical Code / Canadian Electrical Code and any additional local codes.
 - ▶ **Marquage UL**
 - ▶ La protection statique intégrée contre les courts-circuits n'offre pas la même protection que le dispositif de protection du circuit de dérivation. Un tel dispositif doit être fourni, conformément au National Electrical Code / Canadian Electrical Code et aux autres dispositions applicables au niveau local.
-

⚠ WARNING!

- ▶ **UL marking**
 - ▶ Use 75°C copper wire only, except for control circuits.
 - ▶ **Marquage UL**
 - ▶ Utiliser exclusivement des conducteurs en cuivre 75 °C, sauf pour la partie commande.
-

⚠ WARNING!

- ▶ **UL marking**
 - ▶ Suitable for motor group installation or use on a circuit capable of delivering not more than the rms symmetrical amperes (SCCR) of the drive at its rated voltage.
 - ▶ Approved fusing is specified in SCCR tables below.
 - ▶ **Marquage UL**
 - ▶ Convient pour l'utilisation sur une installation avec un groupe de moteurs ou sur un circuit capable de fournir au maximum une valeur de courant efficace symétrique en ampères à la tension assignée de l'appareil.
 - ▶ Les dispositifs de protection adaptés sont spécifiés dans les SCCR tableaux suivants.
-

NOTICE

- ▶ **UL marking**
 - ▶ The opening of the Branch Circuit Protective Device may be an indication that a fault has been interrupted. To reduce the risk of fire or electric shock, current-carrying parts and other components of the controller should be examined and replaced if damaged. If burnout of the current element of an overload relay occurs, the complete overload relay must be replaced.
 - ▶ **Marquage UL**
 - ▶ Le déclenchement du dispositif de protection du circuit de dérivation peut être dû à une coupure qui résulte d'un courant de défaut. Pour limiter le risque d'incendie ou de choc électrique, examiner les pièces porteuses de courant et les autres éléments du contrôleur et les remplacer s'ils sont endommagés. En cas de grillage de l'élément traversé par le courant dans un relais de surcharge, le relais tout entier doit être remplacé.
-



Information on electrical installation

Connection according to UL
Important notes

NOTICE

- ▶ **UL marking**
 - ▶ Internal overload protection rated for 125 % of the rated FLA.
 - ▶ **Marquage UL**
 - ▶ Protection contre les surcharges conçue pour se déclencher à 125 % de l'intensité assignée à pleine charge.
-

Information on electrical installation

Connection according to UL
Fusing data



Fusing data

Branch Circuit Protection (BCP) with Short Circuit Current Ratings (SCCR) with Standard Fuses and Circuit Breaker (Tested per UL61800-5-1, reference UL file E132659)

These devices are suitable for motor group installation when used with Standard Fuses and Circuit Breaker. For single motor installation, if the fuse value indicated is higher than 400 % of the motor current (FLA), the fuse value has to be calculated. If the value of the fuse is below two standard ratings, the nearest standard ratings less than the calculated value shall apply.

Inverter			Standard Fuses (UL248)			Circuit Breaker (UL489)			
Mains	Rated power	Rated power	SCCR	Max. rated current	Class	SCCR	Max. rated current	Min. cabinet dimensions	Min. cabinet dimensions
	kW	hp	kA	A		kA	A	m ³	ft ³
120 V, 1-ph	0.25	0.33	5	15	CC	5	15	-	-
120 V, 1-ph	0.37	0.5	5	15	CC	5	15	-	-
120 V, 1-ph	0.75	1	5	30	CC, J, T	5	30	-	-
120 V, 1-ph	1.1	1.5	5	30	CC, J, T	5	30	-	-
230 V, 1-ph	0.25	0.33	65	15	CC	65	15	0.042	1.48
230 V, 1-ph	0.37	0.5	65	15	CC	65	15	0.042	1.48
230 V, 1-ph	0.55	0.75	65	15	CC	65	15	0.042	1.48
230 V, 1-ph	0.75	1	65	15	CC	65	15	0.042	1.48
230 V, 1-ph	1.1	1.5	65	30	CC, J, T	65	30	0.042	1.48
230 V, 1-ph	1.5	2	65	30	CC, J, T	65	30	0.042	1.48
230 V, 1-ph	2.2	3	65	30	CC, J, T	65	30	0.042	1.48
230 V, 1/3-ph	0.25	0.33	65	15	CC	65	15	0.042	1.48
230 V, 1/3-ph	0.37	0.5	65	15	CC	65	15	0.042	1.48
230 V, 1/3-ph	0.55	0.75	65	15	CC	65	15	0.042	1.48
230 V, 1/3-ph	0.75	1	65	15	CC	65	15	0.042	1.48
230 V, 1/3-ph	1.1	1.5	65	30	CC, J, T	65	30	0.042	1.48
230 V, 1/3-ph	1.5	2	65	30	CC, J, T	65	30	0.042	1.48
230 V, 1/3-ph	2.2	3	65	30	CC, J, T	65	30	0.042	1.48
230 V, 3-ph	4	5	65	40	J, T	65	40	0.042	1.48
230 V, 3-ph	5.5	7.5	65	40	J, T	65	40	0.042	1.48
480 V, 3-ph	0.37	0.5	65	15	CC	65	15	0.042	1.48
480 V, 3-ph	0.55	0.75	65	15	CC	65	15	0.042	1.48
480 V, 3-ph	0.75	1	65	15	CC	65	15	0.042	1.48
480 V, 3-ph	1.1	1.5	65	15	CC	65	15	0.042	1.48
480 V, 3-ph	1.5	2	65	15	CC	65	15	0.042	1.48
480 V, 3-ph	2.2	3	65	15	CC	65	15	0.042	1.48
480 V, 3-ph	3	4	65	25	CC, J, T	65	25	0.042	1.48
480 V, 3-ph	4	5	65	25	CC, J, T	65	25	0.042	1.48
480 V, 3-ph	5.5	7.5	65	25	CC, J, T	65	25	0.042	1.48
480 V, 3-ph	7.5	10	65	40	J, T	65	40	0.042	1.48
480 V, 3-ph	11	15	65	40	J, T	65	40	0.042	1.48
480 V, 3-ph	15	20	65	70	J, T	65	60	0.17	6
480 V, 3-ph	18.5	25	65	70	J, T	65	60	0.17	6
480 V, 3-ph	22	30	65	70	J, T	65	60	0.17	6
480 V, 3-ph	30	40	22	125	J, T	35	125	0.57	20
480 V, 3-ph	37	50	22	125	J, T	35	125	0.57	20
480 V, 3-ph	45	60	22	125	J, T	35	125	0.57	20
480 V, 3-ph	55	75	22	200	J, T	35	200	0.57	20
480 V, 3-ph	75	100	22	200	J, T	35	200	0.57	20
480 V, 3-ph	90	125	22	300	J, T	10	300	0.57	20
480 V, 3-ph	110	150	22	300	J, T	10	300	0.57	20



Information on electrical installation

Connection according to UL
Fusing data

Branch Circuit Protection (BCP) with Short Circuit Current Rating (SCCR) for Semiconductor Fuses

(Tested per UL61800-5-1, reference UL file E132659)

These devices are suitable for standard installation when used with Semiconductor Fuses. For single motor installation, if the fuse value indicated is higher than 400 % of the motor current (FLA), the fuse value has to be calculated. If the value of the fuse is below two standard ratings, the nearest standard ratings less than the calculated value shall apply.

Inverter			Alternate Fuse (Semiconductor Fuse)	
Mains	Rated power	Rated power	SCCR	Max. rated current
	kW	hp	kA	A
120 V, 1-ph	0.25	0.33	-	-
120 V, 1-ph	0.37	0.5	-	-
120 V, 1-ph	0.75	1	-	-
120 V, 1-ph	1.1	1.5	-	-
230 V, 1-ph	0.25	0.33	100	15
230 V, 1-ph	0.37	0.5	100	15
230 V, 1-ph	0.55	0.75	100	40
230 V, 1-ph	0.75	1	100	40
230 V, 1-ph	1.1	1.5	100	40
230 V, 1-ph	1.5	2	100	40
230 V, 1-ph	2.2	3	100	40
230 V, 1/3-ph	0.25	0.33	100	15
230 V, 1/3-ph	0.37	0.5	100	15
230 V, 1/3-ph	0.55	0.75	100	40
230 V, 1/3-ph	0.75	1	100	40
230 V, 1/3-ph	1.1	1.5	100	40
230 V, 1/3-ph	1.5	2	100	40
230 V, 1/3-ph	2.2	3	100	40
230 V, 3-ph	4	5	100	50
230 V, 3-ph	5.5	7.5	100	50
480 V, 3-ph	0.37	0.5	100	6
480 V, 3-ph	0.55	0.75	100	15
480 V, 3-ph	0.75	1	100	15
480 V, 3-ph	1.1	1.5	100	15
480 V, 3-ph	1.5	2	100	15
480 V, 3-ph	2.2	3	100	15
480 V, 3-ph	3	4	100	40
480 V, 3-ph	4	5	100	40
480 V, 3-ph	5.5	7.5	100	40
480 V, 3-ph	7.5	10	100	50
480 V, 3-ph	11	15	100	50
480 V, 3-ph	15	20	100	80
480 V, 3-ph	18.5	25	100	80
480 V, 3-ph	22	30	100	80
480 V, 3-ph	30	40	100	80
480 V, 3-ph	37	50	100	100
480 V, 3-ph	45	60	100	125
480 V, 3-ph	55	75	100	200
480 V, 3-ph	75	100	100	200
480 V, 3-ph	90	125	100	350
480 V, 3-ph	110	150	100	350

Information on electrical installation

Connection according to UL
1-phase mains connection 120 V



Manufacturer	Max. rated current	Designation
	A	
Eaton/Bussmann	350	FWP-350A
Mersen	6	A70QS6-14F
	15	A60Q15-2
	40	A70QS40-14F
	50	A70QS50-22F
	80	A70QS80-22F, A70QS80-4
	100	A70QS100-4
	125	A70QS125-4
	200	A70QS200-4
	350	A70QS350-4



Mains connection

The following should be considered for the mains connection of inverters:

Single inverters are either directly connected to the **AC system** or via upstream filters. RFI filters are already integrated in many inverters. Depending on the requirements, mains chokes or mains filters can be used.

Inverter groups are connected to the **DC system** with the DC bus. For this purpose, the inverters have to be provided with a connection for the DC link, e. g. terminals +UG/-UG.

This enables the energy exchange in phases with operation in generator and motor mode of several drives in the network.

The DC system can be provided by power supply modules (AC/DC converters) or inverters with a power reserve.

The technical data informs about the possible applications in the given groups. In the dimensioning, data and further notes have to be observed.

Information on electrical installation

Mains connection
1-phase mains connection 120 V



1-phase mains connection 120 V

The connection plan is valid for the inverters i550-Cxxx/120-1.



The inverters i550-Cxxx/120-1 do not have an integrated RFI filter in the AC mains supply.

In order to meet the EMC requirements according to EN 61800-3, an external EMC filter according to IEC EN 60939 must be used.

The user must verify that the conformity with EN 61800-3 is fulfilled.

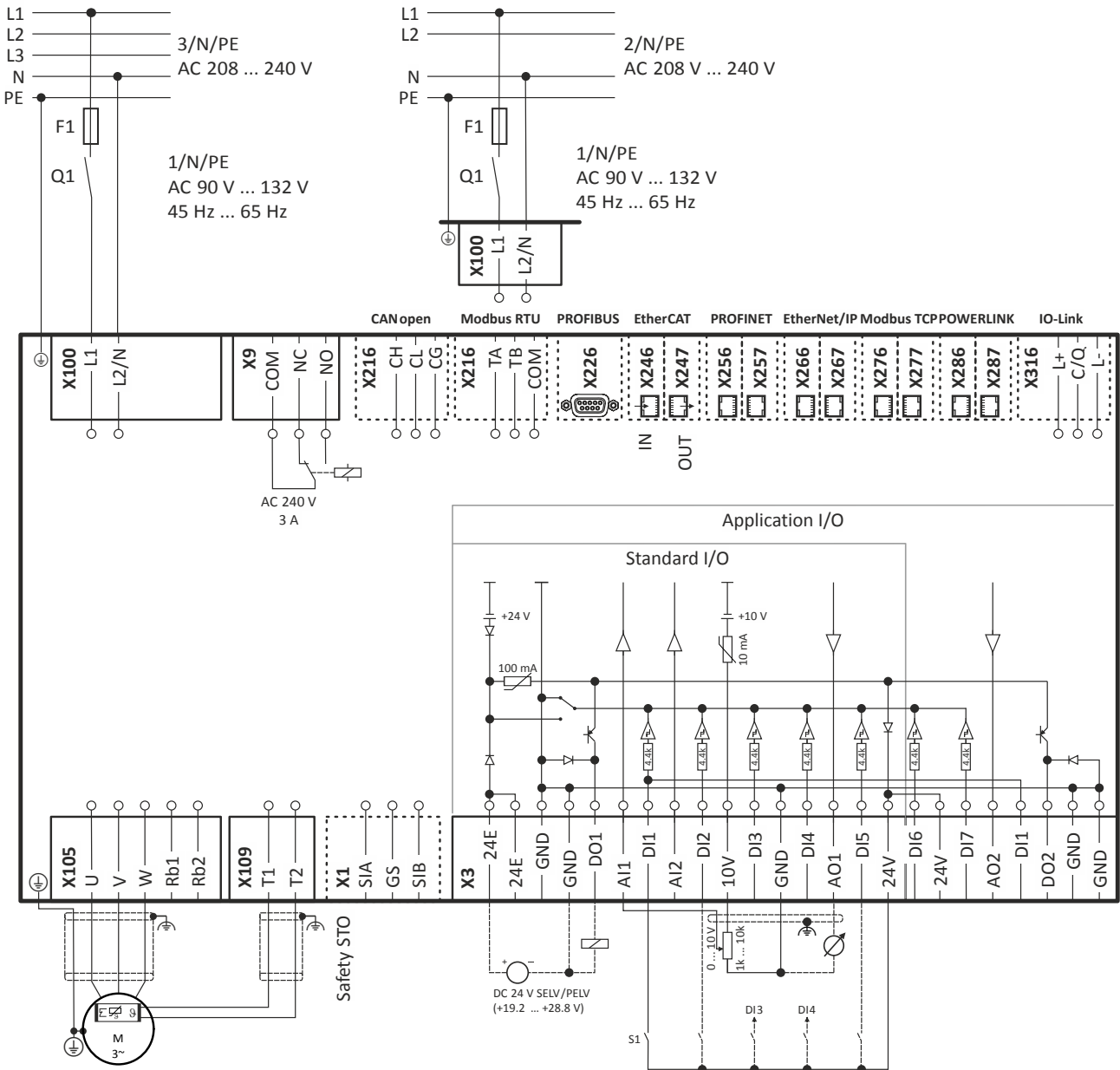

Fig. 2: Wiring example

S1 Start/Stop
Fx Fuses

Q1 Mains contactor
--- Dashed line = options



Information on electrical installation

Mains connection
1-phase mains connection 230/240 V

1-phase mains connection 230/240 V

The connection plan is valid for the inverters i550-Cxxx/230-1.

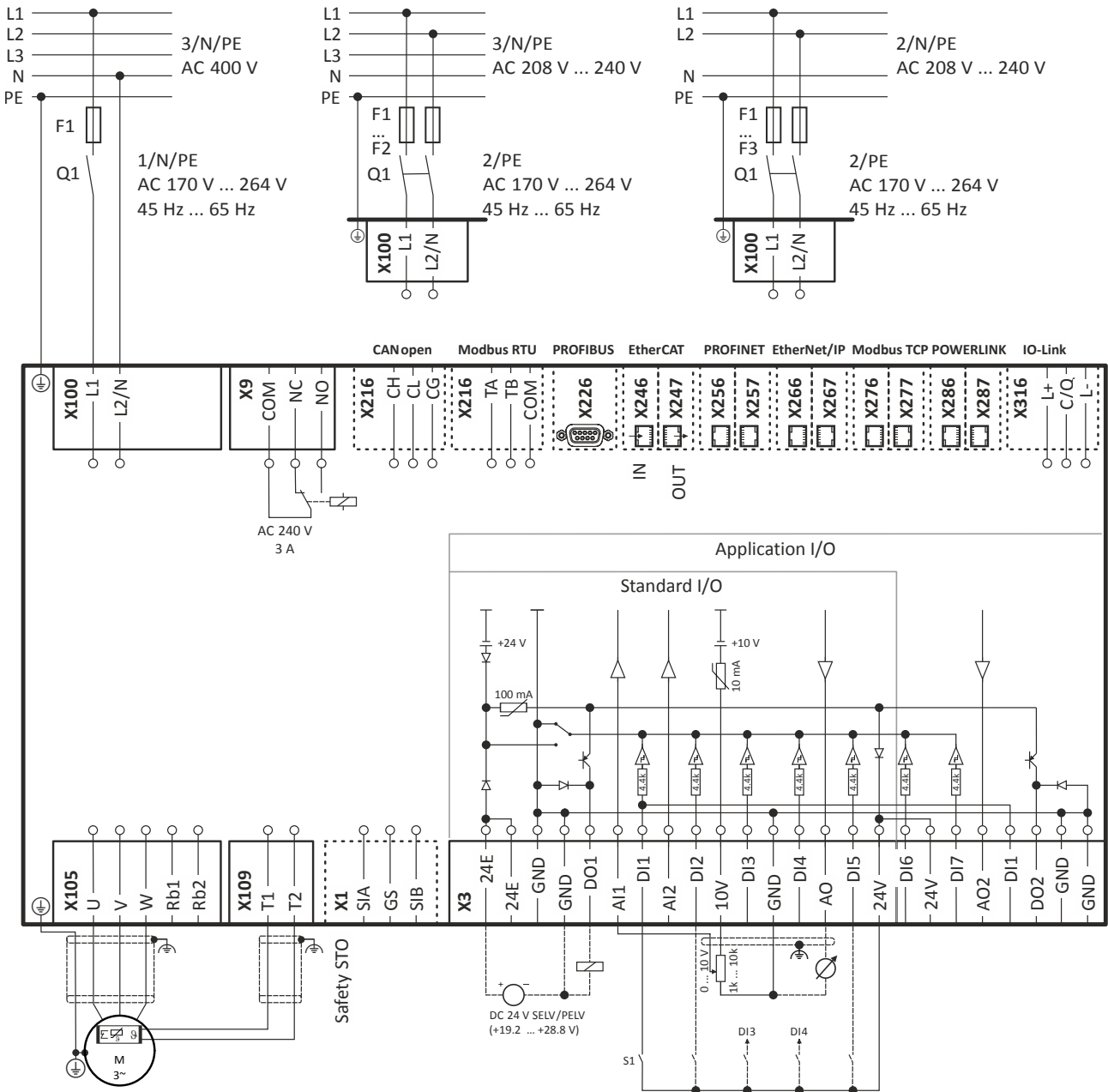

Fig. 3: Wiring example

S1 Start/Stop
Fx Fuses

Q1 Mains contactor
--- Dashed line = options

Information on electrical installation

Mains connection

1-phase mains connection 230/240 V



The connection plan is valid for the inverters i550-Cxxx/230-2.



The inverters i550-Cxxx/230-2 do not have an integrated RFI filter in the AC mains supply.

In order to meet the EMC requirements according to EN 61800-3, an external EMC filter according to IEC EN 60939 must be used.

The user must verify that the conformity with EN 61800-3 is fulfilled.

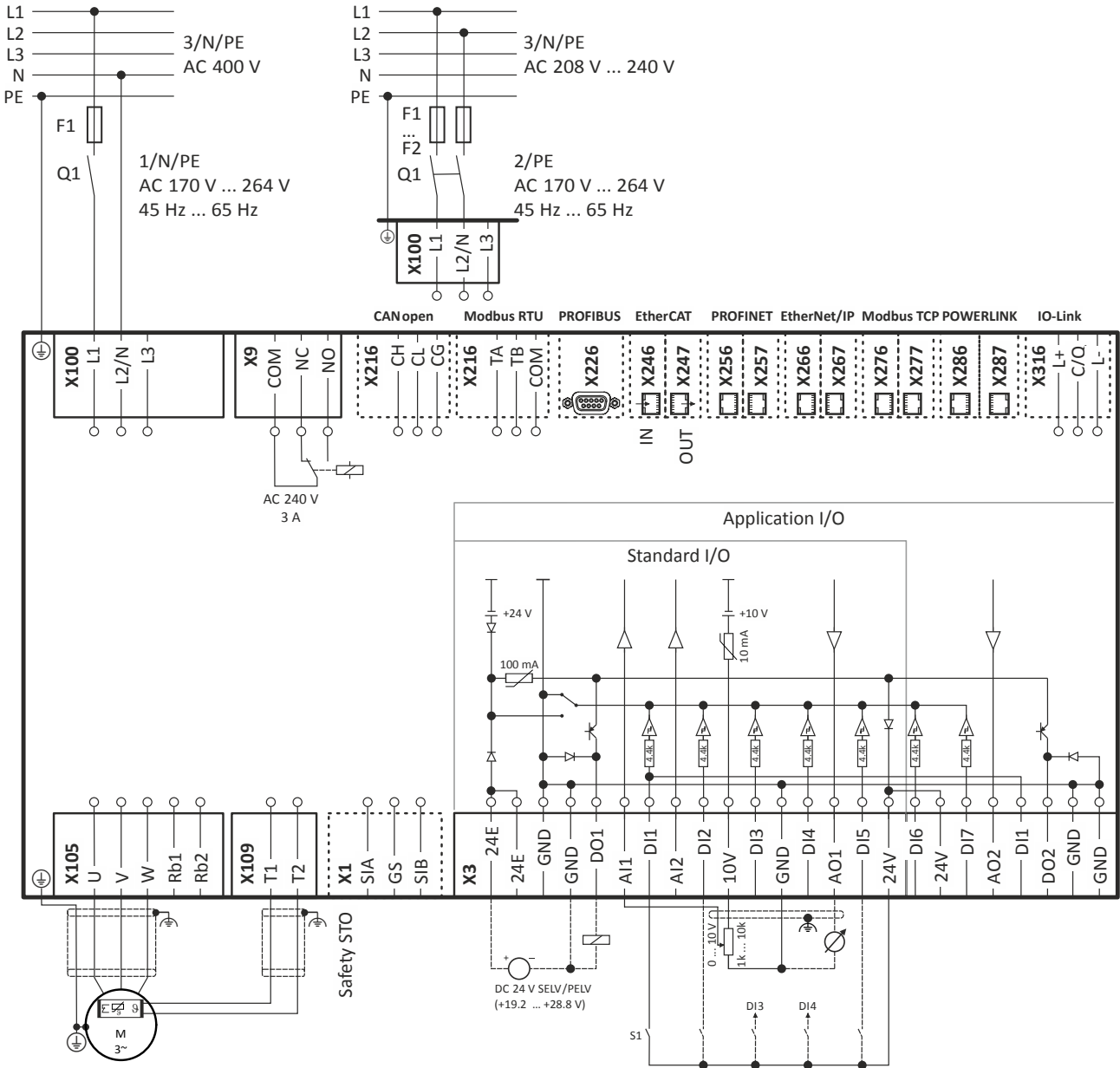

Fig. 4: Wiring example

S1 Start/Stop
Fx Fuses

Q1 Mains contactor
--- Dashed line = options



Information on electrical installation

Mains connection
3-phase mains connection 230/240 V

3-phase mains connection 230/240 V

The connection plan is valid for the inverters i550-Cxxx/230-3.



The inverters i550-Cxxx/230-3 do not have an integrated RFI filter in the AC mains supply.

In order to meet the EMC requirements according to EN 61800-3, an external EMC filter according to IEC EN 60939 must be used.

The user must verify that the conformity with EN 61800-3 is fulfilled.

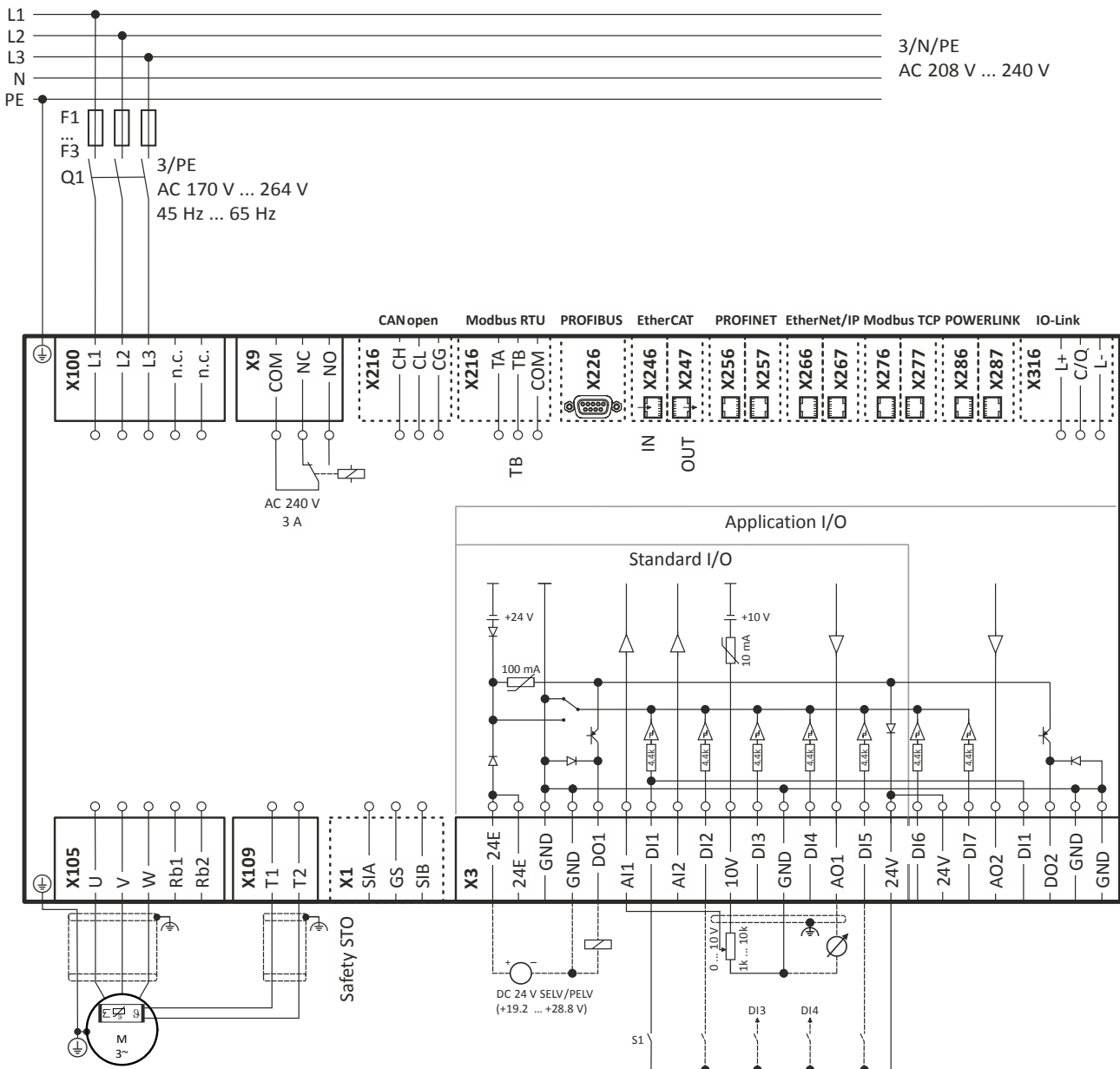

Fig. 5: Wiring example

S1 Start/Stop
Fx Fuses

Q1 Mains contactor
--- Dashed line = options

Information on electrical installation

Mains connection
3-phase mains connection 230/240 V "Light Duty"



The connection plan is valid for the inverters i550-Cxxx/230-2.



The inverters i550-Cxxx/230-2 do not have an integrated RFI filter in the AC mains supply.

In order to meet the EMC requirements according to EN 61800-3, an external EMC filter according to IEC EN 60939 must be used.

The user must verify that the conformity with EN 61800-3 is fulfilled.

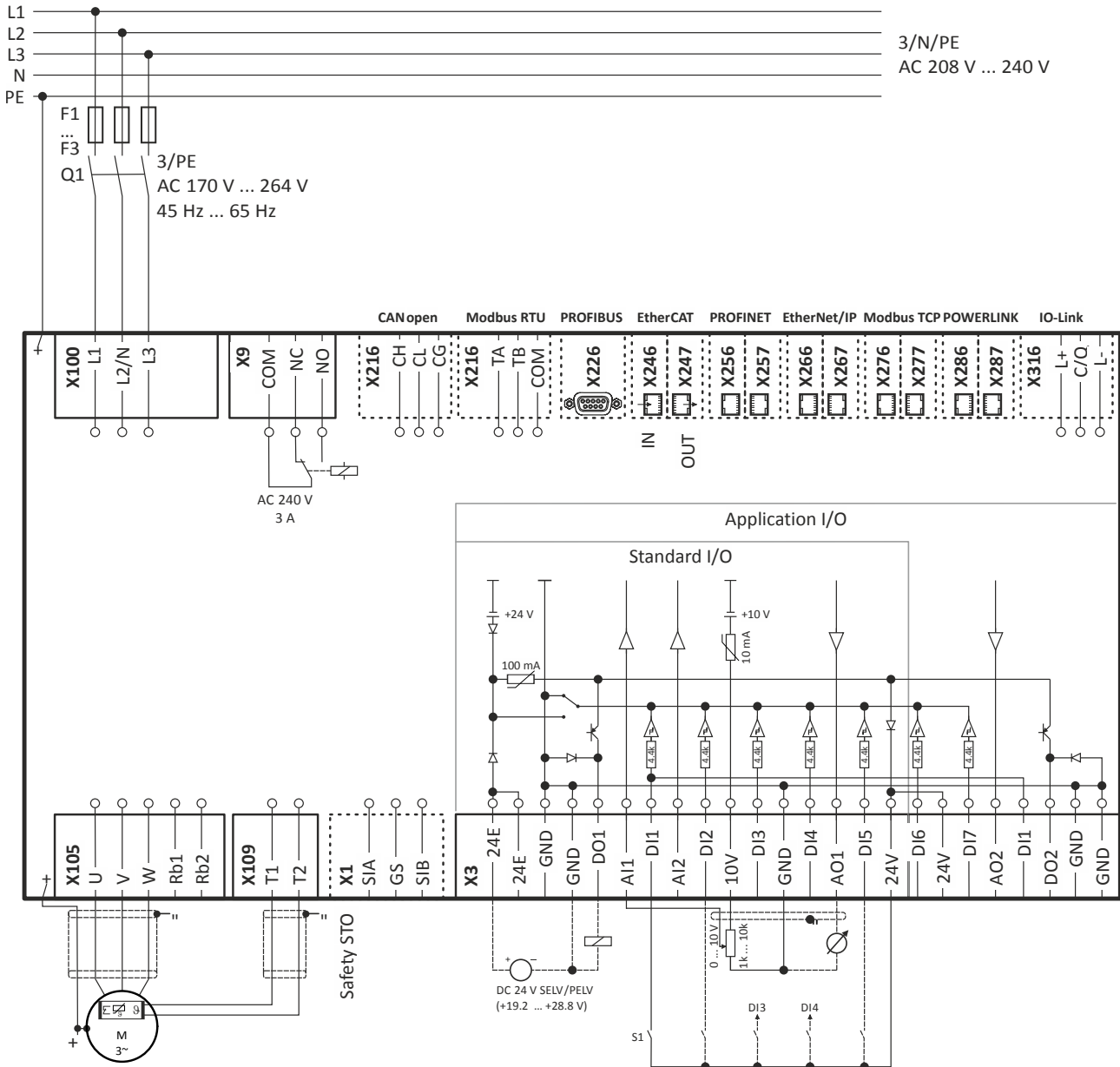

Fig. 6: Wiring example

S1 Start/Stop
Fx Fuses

Q1 Mains contactor
--- Dashed line = options

3-phase mains connection 230/240 V "Light Duty"

See "3-phase mains connection 230/240 V". [59](#)



Information on electrical installation

Mains connection
3-phase mains connection 400 V

3-phase mains connection 400 V

The connection plan is valid for the inverters i550-Cxxx/400-3.

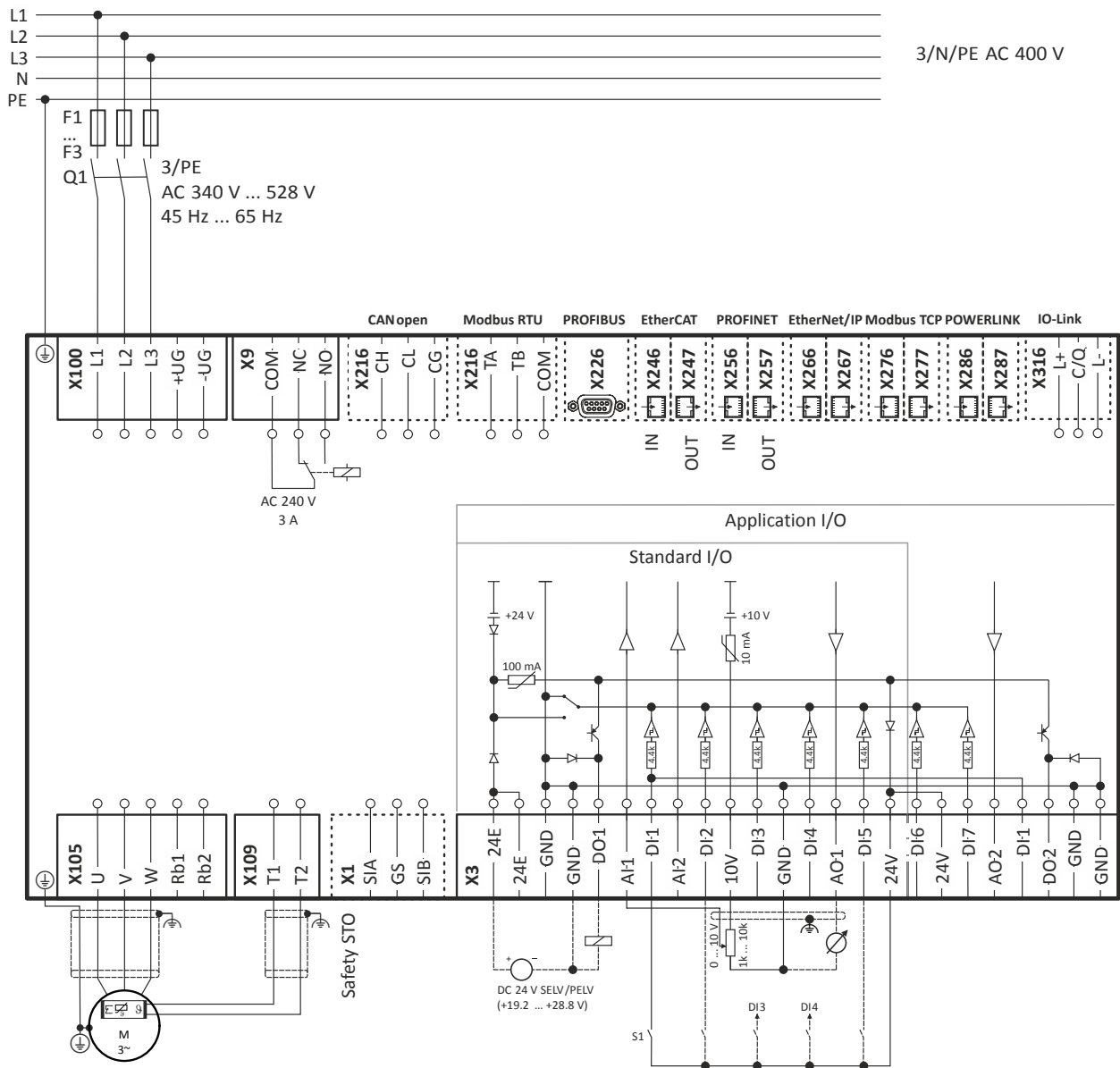

Fig. 7: Wiring example

S1 Start/Stop
Fx Fuses

Q1 Mains contactor
--- Dashed line = options

3-phase mains connection 400 V "Light Duty"

See "3-phase mains connection 400 V". [61](#)

Information on electrical installation

Mains connection
3-phase mains connection 480 V



3-phase mains connection 480 V

The connection plan is valid for the inverters i550-Cxxx/400-3.

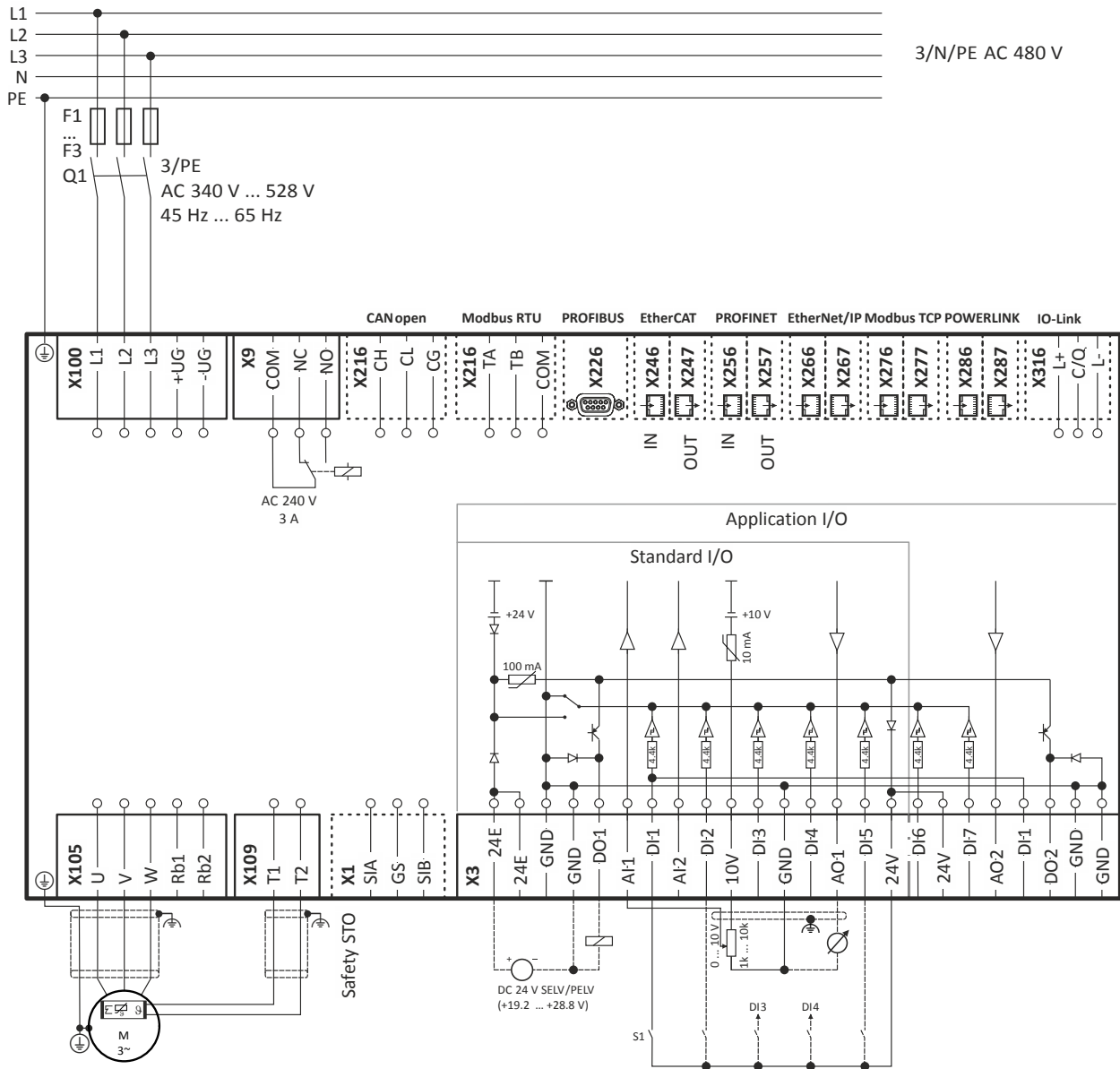

Fig. 8: Wiring example

S1 Start/Stop
Fx Fuses

Q1 Mains contactor
-- Dashed line = options

3-phase mains connection 480 V "Light Duty"

See "3-phase mains connection 480 V". [62](#)



Motor connection

Switching in the motor cable



Switching on the motor side of the inverter is permissible:

For safety shutdown (emergency stop).

In case several motors are driven by one inverter (only in V/f operating mode).

Please note the following:

The switching elements on the motor side must be dimensioned for with the maximum occurring load.

Motor cable lengths

- The rated data for the motor cable length must be observed.
- Keep the motor cable as short as possible as this has a positive effect on the drive behaviour and the EMC.
- Several motors connected to an inverter form a group drive. In case of group drives, the resulting motor cable length l_{res} is relevant:

$$l_{res} [m] = (l_1 + l_2 + l_3 \dots l_i) \cdot \nu_i$$

l_{res} Resulting length of the motor cables

l_x Length of the single motor cable

i Number of the single motor cables

Information on electrical installation

Connection to the IT system



Connection to the IT system

NOTICE

Internal components have earth/ground potential

Possible consequence: The monitoring devices of the IT system will be triggered.

- ▶ Upstream an isolation transformer.
- ▶ Before connection to an IT system be absolutely sure to remove the screws labeled with "IT" on the product.

I55AE125x, I55AE137x

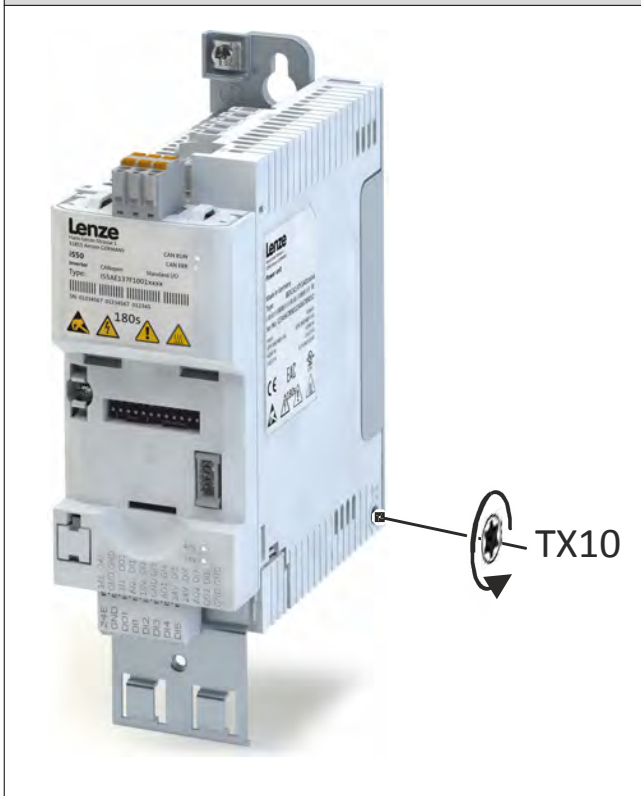

I55AE155x, I55AE175x, I55AE222x, I55BE230x, I55BE240x

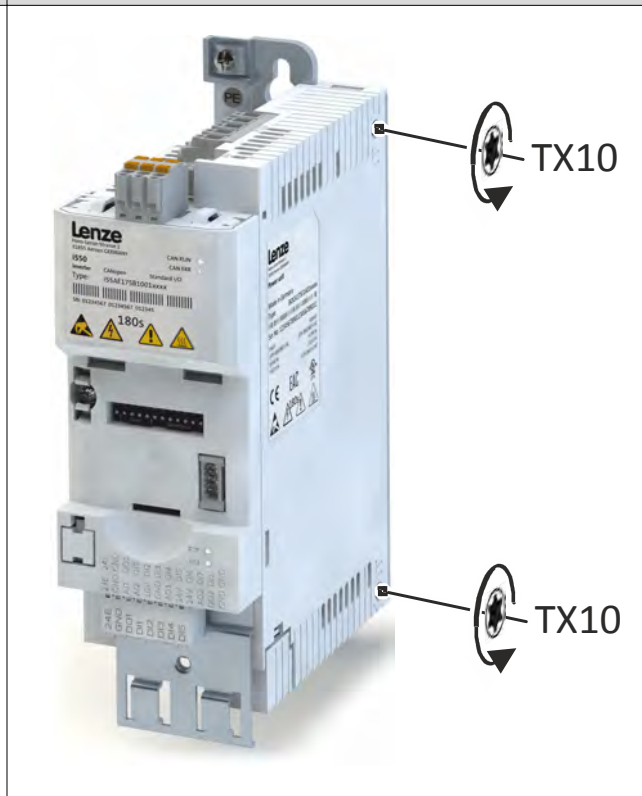

I55AE240D, I55AE255D, I55AE255F, I55AE275F, I55AE311F

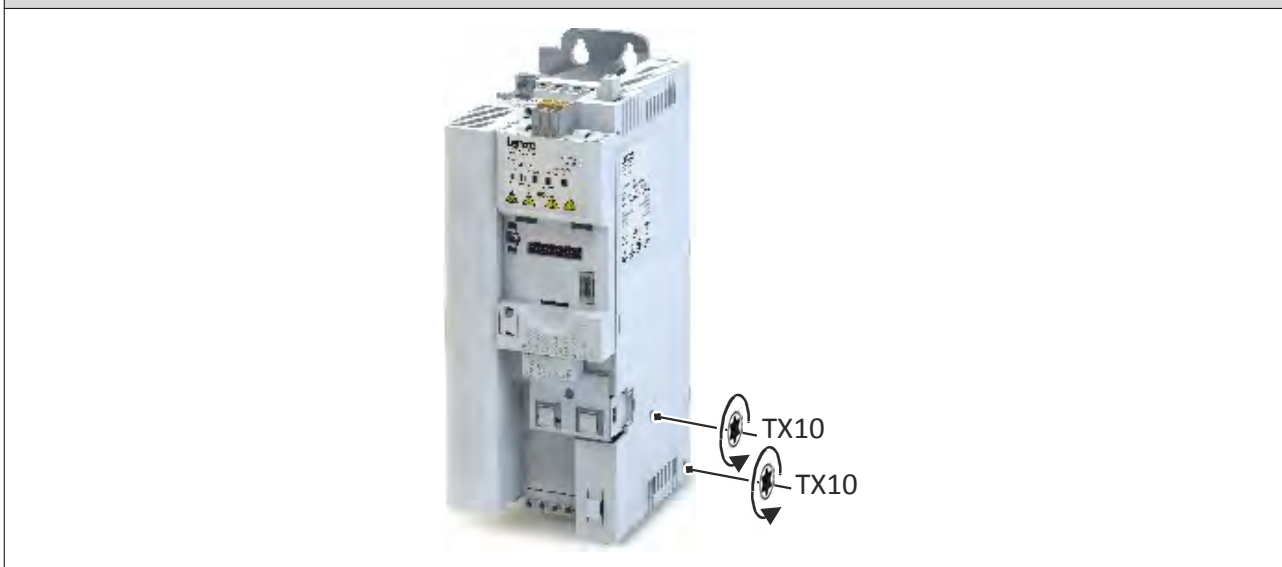



Information on electrical installation

Connection to the IT system

I55AE315F, I55AE318F, I55AE322F

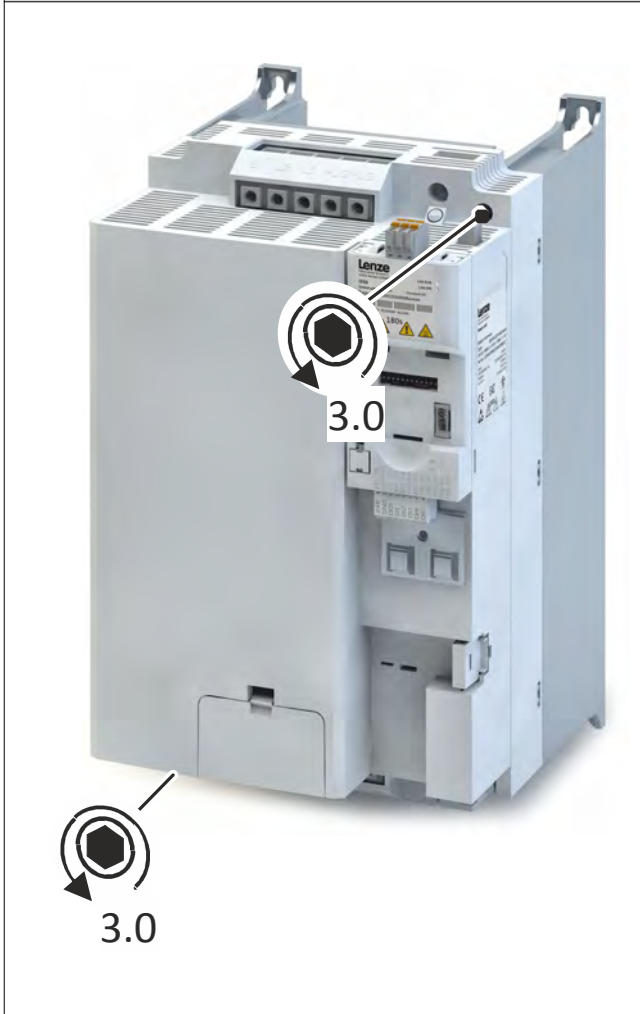

I55AE330F, I55AE337F, I55AE345F



Information on electrical installation

Connection of motor temperature monitoring



I55AE355F, I55AE375F, I55AE390F, I55AE411F

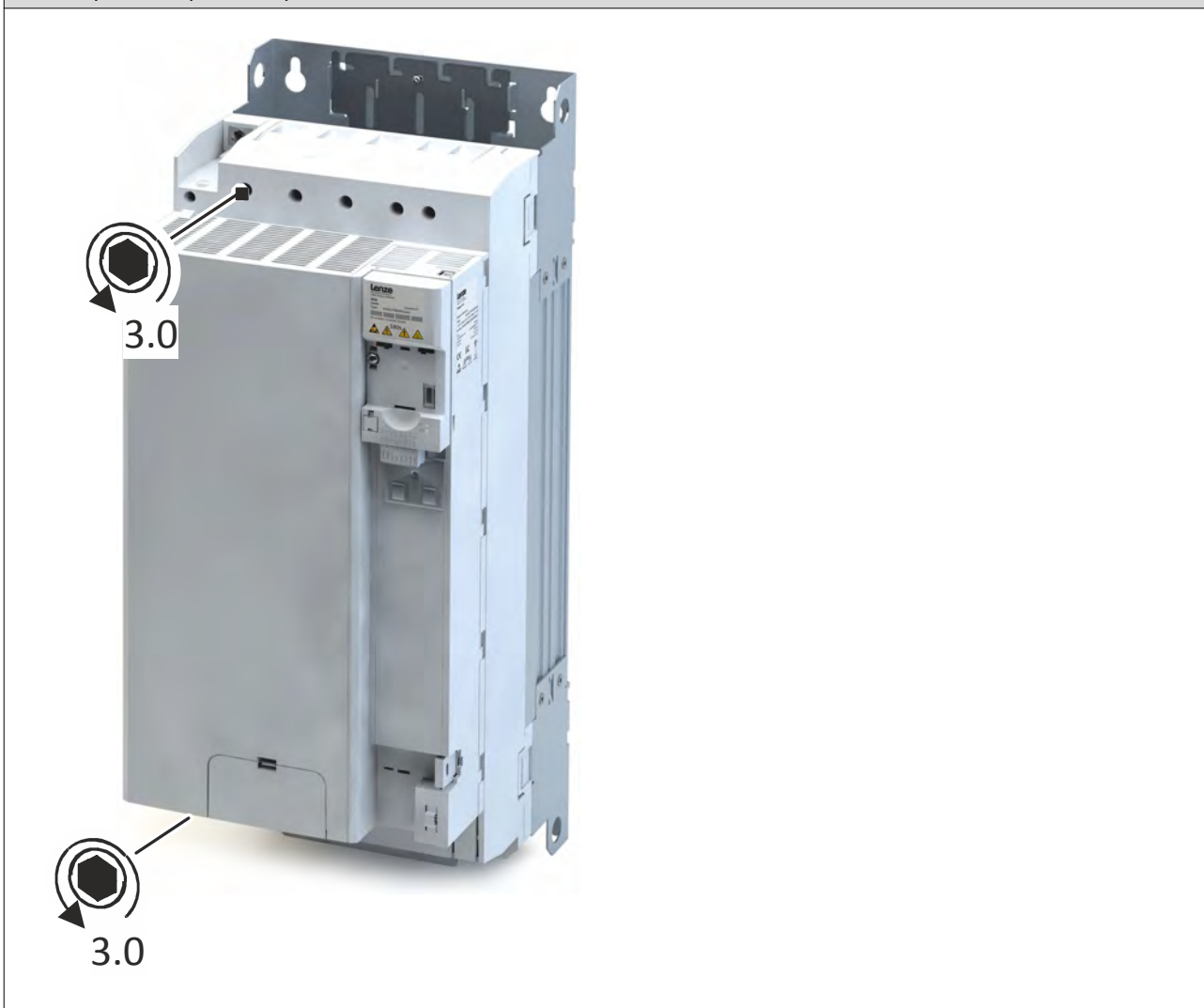

Connection of motor temperature monitoring



If the terminal X109 is used, e. g. for connecting an external PTC thermistor or a thermal contact, ensure at least one basic insulation to the potentials of motor, mains and control terminals to not restrict the safe isolation of the control terminals.



Brake resistor connection

NOTICE

Overload

Overload can destroy the brake resistor.

- ▶ Protect the brake resistor of the inverter against overload with suitable parameterization.
- ▶ The thermostat of the brake resistor can be used to establish a safety shutdown to disconnect the controller from the mains.

Short connecting cables up to 0.5 m

Up to a cable length of 0.5 m, the cable for the brake resistor and that of the temperature monitoring can be twisted. Doing so reduces problems due to EMC interference.

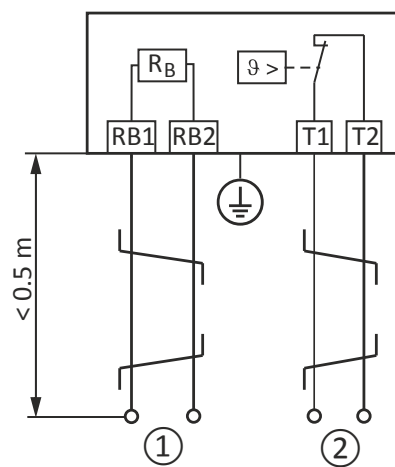

Fig. 9: Connection plan - brake resistor with a cable length of up to 0.5 m

- ① Wiring to the "brake resistor" connection on the inverter or another component with brake chopper.
- ② Optional: Wiring to a control contact, e. g. a digital input that is set to monitor the thermal contact. If the thermal contact responds, the voltage supply of the inverter must be disconnected (e. g. switch off the control of the mains contactor).

Information on electrical installation

DC-bus connection



Long connecting cables up to max. 5 m

The brake resistor cable must be shielded. The maximum length is 5 m.

For the temperature monitoring cable, twisting is sufficient.

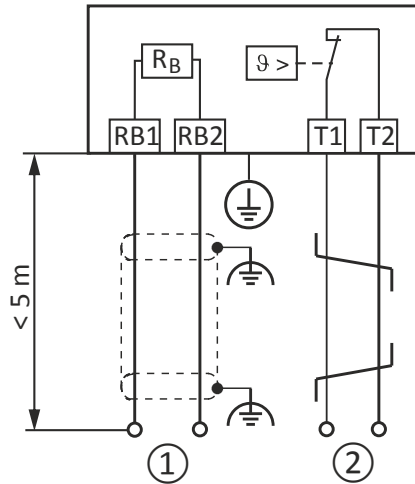

Fig. 10: Connection plan - brake resistor with a cable length of up to 5 m

- ① Wiring to the "brake resistor" connection on the inverter or another component with brake chopper.
- ② Optional: Wiring to a control contact, e. g. a digital input that is set to monitor the thermal contact. If the thermal contact responds, the voltage supply of the inverter must be disconnected (e. g. switch off the control of the mains contactor).

DC-bus connection

Rated mains voltage	DC voltage range
V	
400	DC 450 V - 0 % ... 750 V + 0 %
480	

Control connections

Connection description		Control terminals
Connection		X3
Connection type		Plug-in spring terminal
Max. Cable cross-section	mm ²	1.5
Max. Cable cross-section	AWG	16
Stripping length	mm	9
Stripping length	inch	0.35
Tightening torque	Nm	-
Tightening torque	lb-in	-
Required tool		0.4 x 2.5



Networks



When planning networks, please observe the following recommendations for trouble-free operation, especially in the event of Ethernet-based networks.

- Lay communication cables separately from power cables. Maintain as large a distance as possible to the motor cables which are subject to interference.
- To avoid compensating currents via the shielding of the communication cable, install an independent, low-impedance equipotential bonding over the shortest possible distance parallel to the communication cable. This applies in particular to long cables.
- CAT5 cables according to specification establish the shield connection via the RJ45 plug connection. Additional shield connections are not required.
- Cables must comply with CAT5 and be suitable for ≥ 10 Mbps.
- Only certified, tested and fully assembled patch cables from well-known manufacturers are recommended.
- Observe bending radii according to manufacturer information. Minimum bending radii of 10 x cable diameter or 20 x diameter for frequent manipulation of the cables are standard.
- RJ45 Plug connections only function properly if they are not subjected to mechanical stress or lateral forces.
- Patch cables of 25 cm length are suitable for the network connection of inverters ≤ 4 kW installed side by side. When wiring from right to left, a sufficient bending radius can be maintained.
- Fix longer cables 30 cm after the connection point.

CANopen



The network must be terminated with a 120 Ω resistor at the first and last physical node.

Set the "R" DIP switch to ON at these network nodes.

Typical topologies

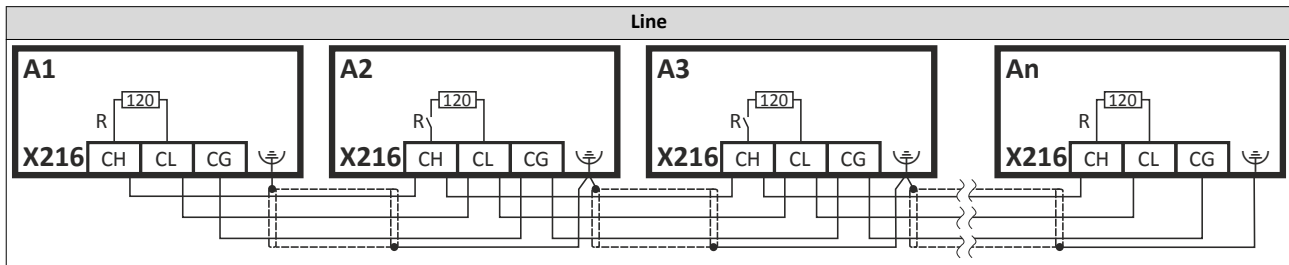

Connection description		CANopen	
Connection		X216	
Connection type		Pluggable double spring terminal	
Max. Cable cross-section	mm ²	2.5	
Max. Cable cross-section	AWG	12	
Stripping length	mm	10	
Stripping length	inch	0.39	
Tightening torque	Nm	-	
Tightening torque	lb-in	-	
Required tool		0.4 x 2.5	

Information on electrical installation

Networks
EtherCAT



EtherCAT

Typical topologies

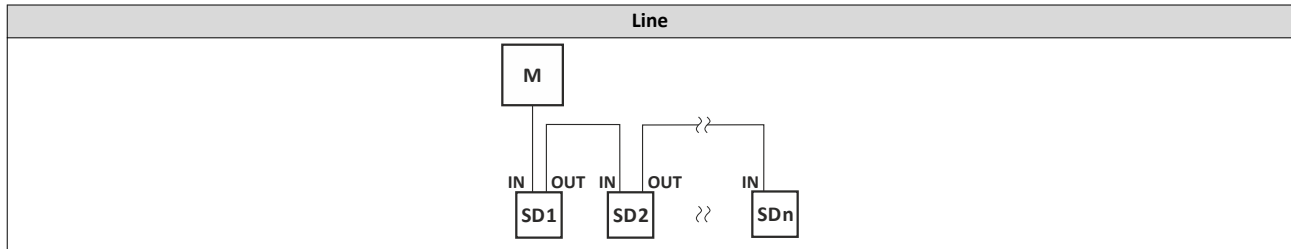

M Master
SD Slave Device

Bus-related information	
Name	EtherCAT
Communication medium	Ethernet 100 Mbps, full duplex
Use	Connection as EtherCAT slave
Status display	2 LEDs (RUN, ERR)
Connection designation	IN: X246 OUT: X247

EtherNet/IP

Typical topologies

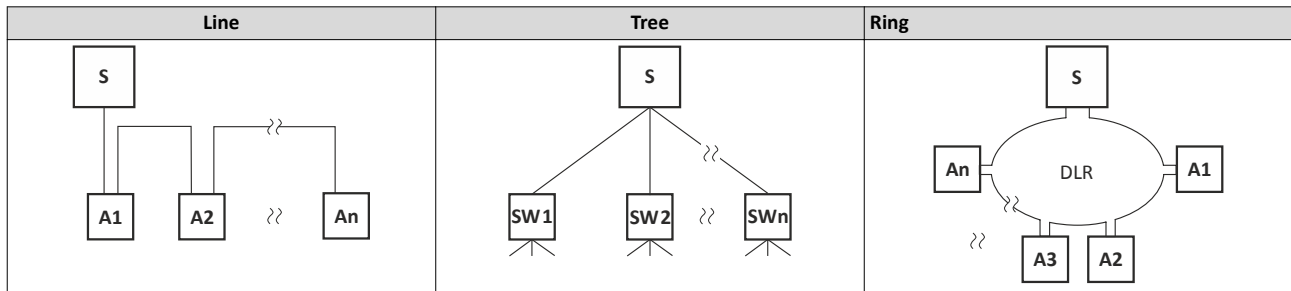

S Scanner
A Adapter
SW Switch

Bus-related information	
Name	EtherNet/IP
Communication medium	Ethernet 10 Mbps, 100 Mbps, half duplex, full duplex
Use	Connection of the inverter to an EtherNet/IP network
Connection system	RJ45
Status display	2 LEDs
Connection designation	X266 X267



Information on electrical installation

Networks
Modbus RTU

Modbus RTU

Typical topologies

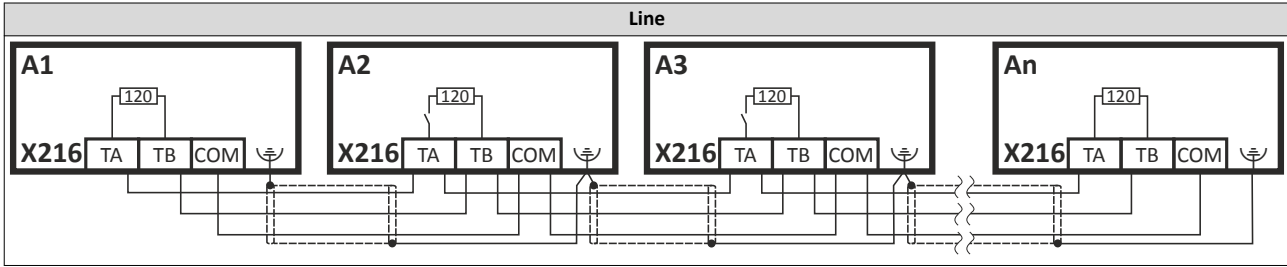

Connection description		Modbus RTU	
Connection		X216	
Connection type		Pluggable double spring terminal	
Max. Cable cross-section	mm ²	2.5	
Max. Cable cross-section	AWG	12	
Stripping length	mm	10	
Stripping length	inch	0.39	
Tightening torque	Nm	-	
Tightening torque	lb-in	-	
Required tool		0.4 x 2.5	

Modbus TCP

Typical topologies

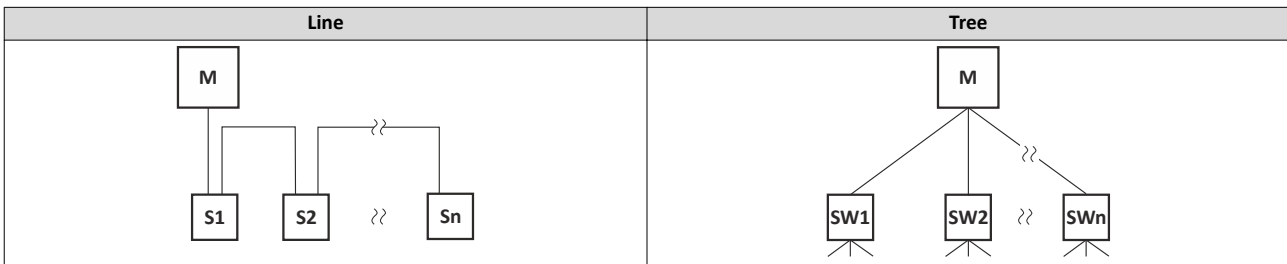

M Master
S Slave

SW Switch

Bus-related information	
Name	Modbus TCP
Communication medium	Ethernet 10 Mbps, 100 Mbps, half duplex, full duplex
Use	Connection of the inverter to a Modbus TCP network
Connection system	RJ45
Status display	2 LEDs
Connection designation	Port 1: X276 Port 2: X277

Information on electrical installation

Networks
POWERLINK



POWERLINK

Typical topologies

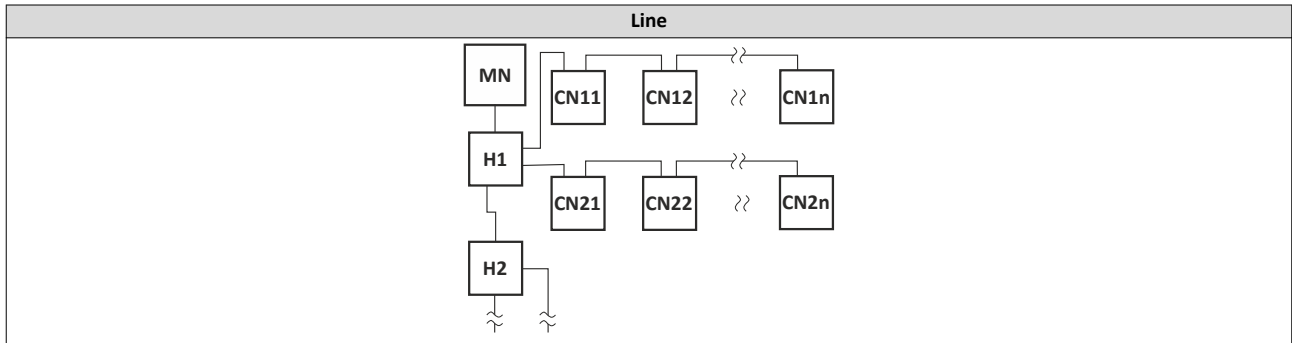

MN Managing Node
CN Controlled Node
H Hub

Bus-related information			
Name		Ethernet POWERLINK	
Communication medium		Ethernet 100 Mbps, half duplex	
Use		Connection of the inverter to a POWERLINK network	
Connection system		RJ45	
Status display		2 LEDs	
Connection designation		IN: X286 OUT: X287	

PROFIBUS

Typical topologies

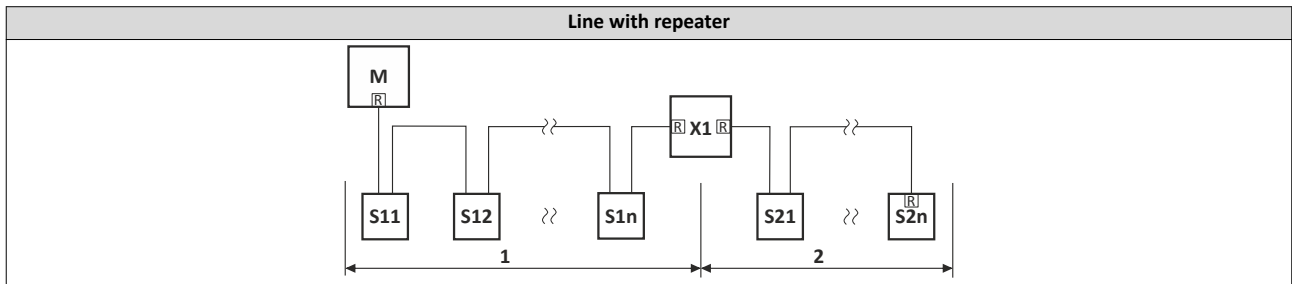

M Master
S Slave
X Repeater
R Activated bus terminating resistor

Sub D socket 9-pin - X226

View	Pin	Assignment	Description
	1	Shield	Additional shield connection
	2	n.c.	
	3	RxD/TxD-P	Data line-B (received data/transmitted data +)
	4	RTS	Request To Send (received data/transmitted data, no differential signal)
	5	M5V2	Reference potential (bus terminating resistor -)
	6	P5V2	5 V DC / 30 mA (bus terminating resistor +, OLM, OLP)
	7	n.c.	
	8	RxD/TxD-N	Data line-A (received data/transmitted data -)
	9	n.c.	



PROFINET

Typical topologies

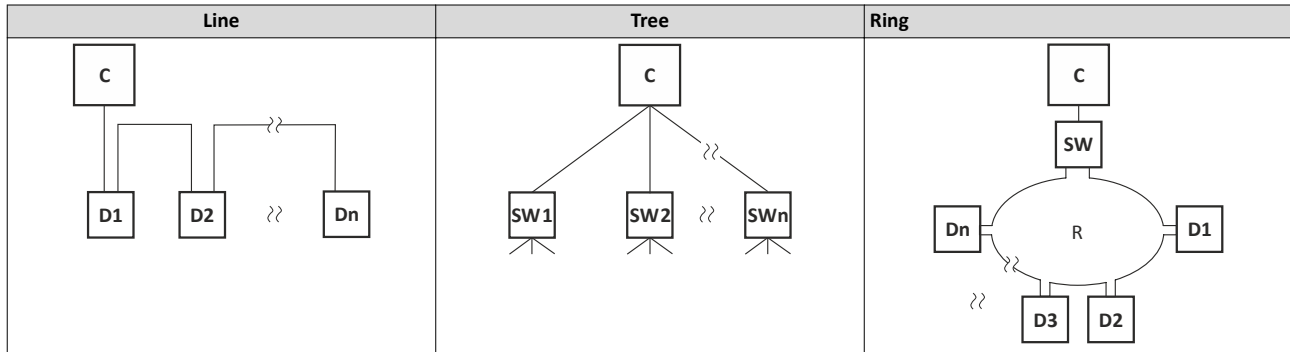

C IO controller

D IO device

SW Switch SCALANCE (MRP capable)

R Redundant domain

Bus-related information

Name	PROFINET RT	
Communication medium	Ethernet 100 Mbps, full duplex	
Use	Connection as PROFINET IO Device	
Connection system	RJ45	
Status display	2 LEDs	
Connection designation	X256 X257	

Information on electrical installation

Networks
IO-Link

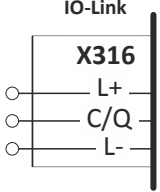

IO-Link

Information		
Name	IO-Link	
Specification	1.1	
Baud rate	230.4 kbaud (COM 3)	
Cycle time	2 ms	
Port Class A (type A)	I max. 200 mA	
Connection designation IO-Link 	L+	24 V
	C/Q	Switching and communication line
	L-	0 V
Cable	Plug M12 class A, 5-pole	Standard cable max. 20 m

Typical topologies

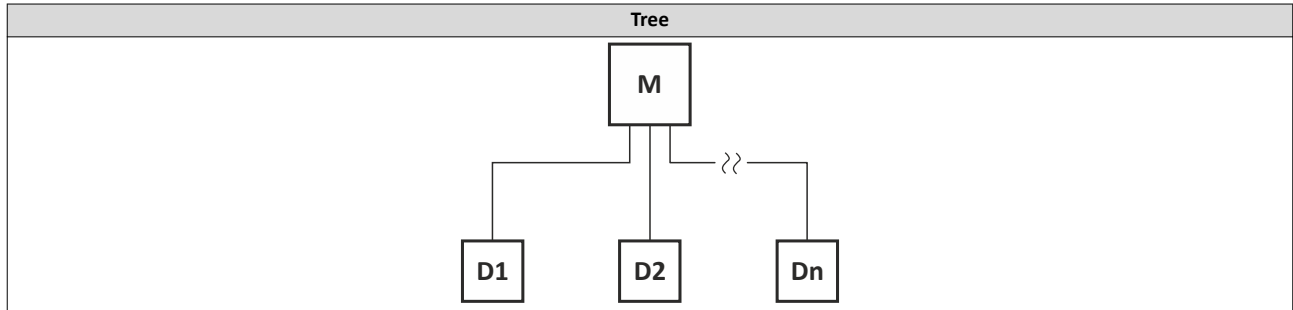

M Master

D Device

Connection description		IO-Link
Connection		X316
Connection type		Pluggable double spring terminal
Max. Cable cross-section	mm ²	2.5
Max. Cable cross-section	AWG	12
Stripping length	mm	10
Stripping length	inch	0.39
Tightening torque	Nm	-
Tightening torque	lb-in	-
Required tool		0.4 x 2.5



Functional safety

DANGER!

Improper installation of the safety engineering system can cause an uncontrolled starting action of the drives.

Possible consequence: Death or severe injuries

- ▶ Safety engineering systems may only be installed and commissioned by qualified personnel.
- ▶ All control components (switch, relay, PLC, ...) must comply with the requirements of EN ISO 13849-1 and the EN ISO 13849-2.
- ▶ Switches, relays with at least IP54 degree of protection.
- ▶ Always mount devices with a degree of protection lower than IP54 in control cabinets with a minimum degree of protection of IP54.
- ▶ The wiring must be shielded.
- ▶ It is essential to use insulated wire end ferrules for wiring.
- ▶ All safety-relevant cables outside the control cabinet must be protected, e.g. by means of a cable duct.
- ▶ Ensure that no short circuits can occur according to the specifications of the EN ISO 13849-2.
- ▶ All further requirements and measures can be obtained from the EN ISO 13849-1 and the EN ISO 13849-2.
- ▶ If an external force acts upon the drive axes, additional brakes are required. Please observe that hanging loads are subject to the force of gravity!
- ▶ For safety-related braking functions, use safety-rated brakes only.
- ▶ The user has to ensure that the inverter will only be used in its intended application within the specified environmental conditions. This is the only way to comply with the declared safety-related characteristics.

DANGER!

Automatic restart if the request of the safety function is deactivated.

Possible consequences: Death or severe injuries

- ▶ You must provide external measures according to EN ISO 13849-1 which ensure that the drive only restarts after a confirmation.

NOTICE

Overvoltage

Destruction of the safety component

- ▶ Make sure that the maximum voltage (maximum rated) at the safe inputs does not exceed 30 V DC.

NOTICE

Excessively high humidity or condensation

Malfunction or destruction of the safety component

- ▶ Only commission the safety component when it has acclimatised.

Information on electrical installation

Functional safety
Basic Safety - STO



Basic Safety - STO

DANGER!

With the "Safe torque off" (STO) function, no "emergency-stop" can be executed according to EN 60204-1 without additional measures. There is no electrical isolation between the motor and inverter and no service switch or maintenance switch!

Possible consequences: Death or severe injuries

► "Emergency stop" requires electrical isolation, e. g. via a central mains contactor.



Connection diagram



The connection diagrams shown are only example circuits. The user is responsible for the correct safety-related design and selection of the components!

Active sensors

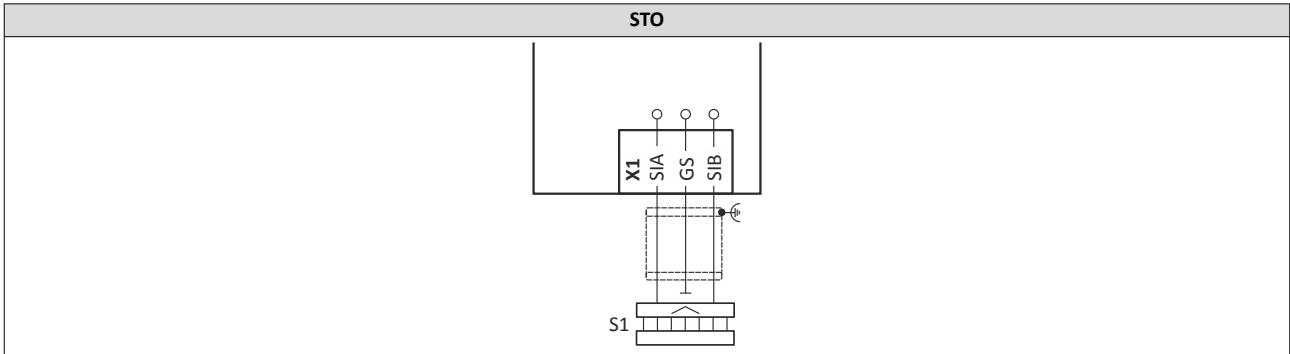

S1 Active sensor - example of lightgrid

Passive sensors

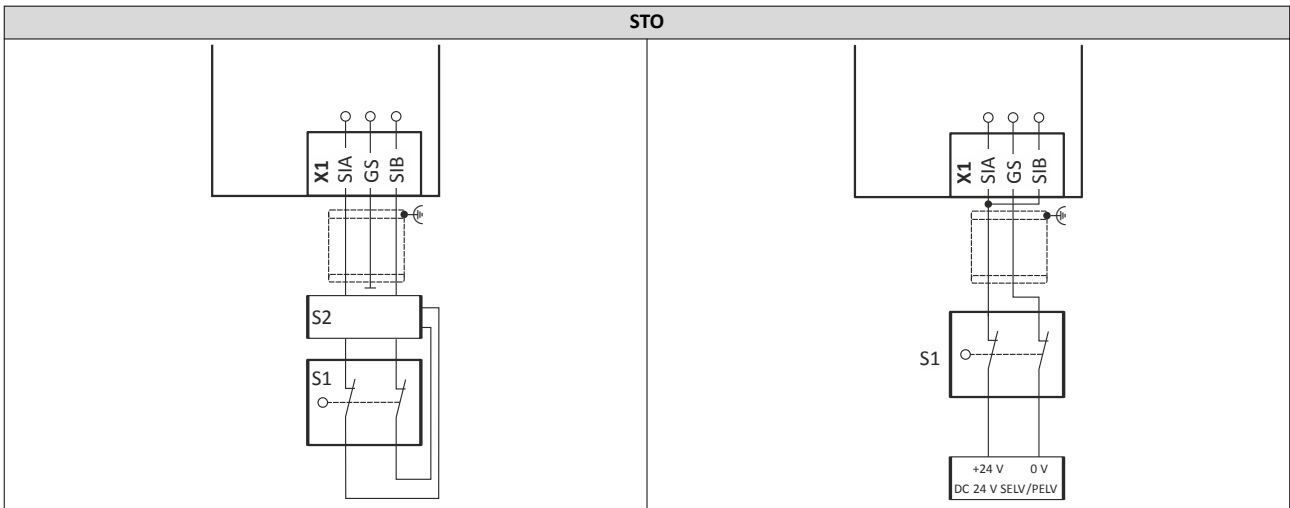

S1 Passive sensor
S2 Safety switching device

S1 Passive sensor

Information on electrical installation

Functional safety
Basic Safety - STO



Passive sensors - further examples

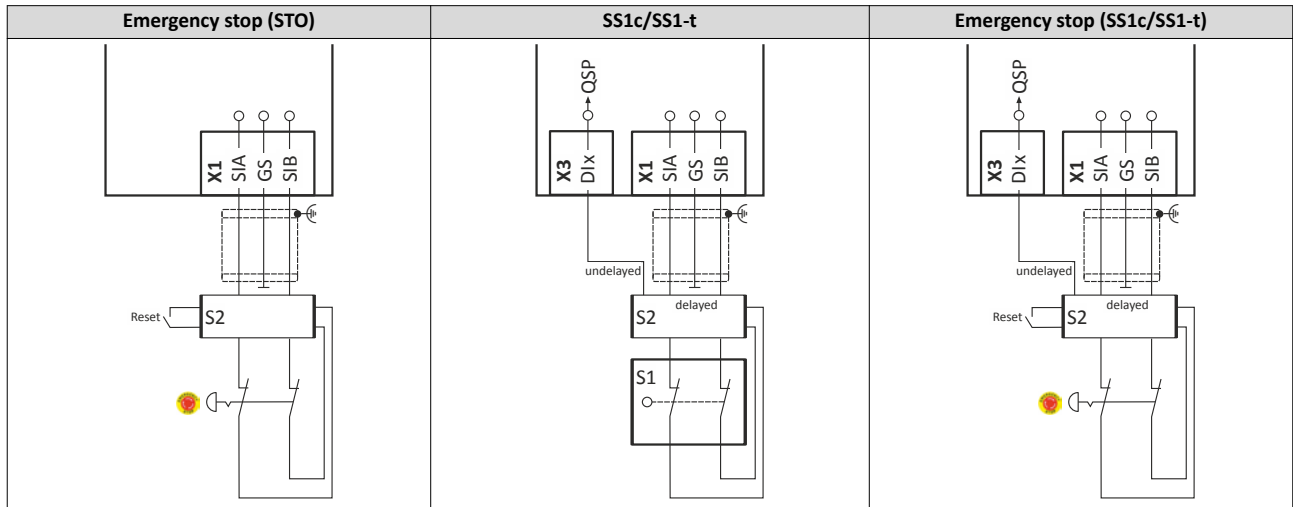

S2 Safety switching device

S1 Passive sensor
S2 Safety switching device with delayed contacts

S2 Safety switching device with delayed contacts

Terminal data

X1	Specification	Unit	min.	typ.	max.	
SIA, SIB	LOW signal	V	-3	0	+5	
	HIGH signal	V	+15	+24	+30	
	Switch-on time	ms		3		
	Clear time	ms		50	60	
	Input current SIA	mA		10	14	
	Input current SIB	mA		7	12	
	Input peak current	mA		100		
	Test pulse duration	ms				1
	Test pulse interval	ms		10		
GS	Reference potential for SIA and SIB					

Connection description		Basic Safety - STO	
Connection		X1	
Connection type		Pluggable double spring terminal	
Max. Cable cross-section	mm ²	1.5	
Max. Cable cross-section	AWG	16	
Stripping length	mm	9	
Stripping length	inch	0.35	
Tightening torque	Nm	-	
Tightening torque	lb-in	-	
Required tool		0.4 x 2.5	



Technical data

Standards and operating conditions

Conformities and approvals

Conformity		
CE	2014/35/EU	Low-Voltage Directive
	2014/30/EU	EMC Directive (reference: CE-typical drive system)
EAC	TR CU 004/2011	Eurasian conformity: Safety of low voltage equipment
	TR CU 020/2011	Eurasian conformity: Electromagnetic compatibility of technical means
RoHS	2011/65/EU	Restrictions on the use of certain hazardous substances in electrical and electronic devices
Approval		
UL	UL 61800-5-1	for USA and Canada (requirements of the CSA 22.2 No. 274) File No. E132659

Protection of persons and device protection

Degree of protection		
IP20	EN 60529	Data applies to operationally ready mounted state and not in wire range of terminals
Type 1	UL 50	protection against accidental contact only
Open type	UL 61800-5-1	Only in UL-approved systems
Insulation resistance		
Overvoltage category III	EN 61800-5-1	0 ... 2000 m amsl
Overvoltage category II	EN 61800-5-1	above 2000 m a.m.s.l.
Isolation of control circuits		
Safe mains isolation via double/reinforced insulation	EN 61800-5-1	
Leakage current		
> 3.5 mA AC, > 10 mA DC	EN 61800-5-1	Please observe regulations and safety instructions!
Starting current		
≤ 3 x rated mains current		
Protective measures against		
Short circuit		
Earth fault		Earth-fault protected depending on operating status
Overtemperature of motor		PTC or thermal contact, I ² xt monitoring
Overvoltage		
Motor stalling		

EMC data

Noise emission		
Category C1	EN 61800-3	See rated data
Category C2	EN 61800-3	See rated data
Category C3	EN 61800-3	See rated data
Noise immunity		
Fulfils requirements according to	EN 61800-3	
Operation on public supply systems		
Take measures to limit the expected radio interference:		The machine or system manufacturer is responsible for compliance with the requirements for the machine/system!
< 1 kW: with mains choke	EN 61000-3-2	
> 1 kW for mains current ≤ 16 A: without additional measures		
Mains current > 16 A: With mains choke or mains filter, with dimensioning for rated power.	EN 61000-3-12	

Technical data

Standards and operating conditions
Motor connection



Motor connection

Requirements for the shielded motor cable		
Capacitance per unit length		
C-core-core/C-core-shielding < 75/150 pF/m		≤ 2.5 mm ² / AWG 14
C-core-core/C-core-shielding < 150/300 pF/m		≥ 4 mm ² / AWG 12
Electric strength		
U ₀ /U = 0.6/1.0 kV		U ₀ = r.m.s. value external conductor to PE
U ≥ 600 V	UL	U = r.m.s. value from external conductor to external conductor

Environmental conditions

Energy efficiency		
Class IE2	EN 50598-2	
Climate		
1K3 (-25 ... +60°C)	EN 60721-3-1	Storage
2K3 (-25 ... +70°C)	EN 60721-3-2	Transport
3K3 (-10 ... +55°C)	EN 60721-3-3	Operation
		Operation at a switching frequency of 2 or 4 kHz Above +45°C: reduce rated output current by 2.5 %/°C
		Operation at a switching frequency of 8 or 16 kHz: Above +40°C: reduce rated output current by 2.5 %/°C
Site altitude		
0 ... 1000 m amsl		
1000 ... 4000 m amsl		Reduce rated output current by 5 %/1000 m
Pollution		
Degree of pollution 2	EN 61800-5-1 UL 61800-5-1	
Vibration resistance		
Transport		
2M2 (sine, shock)	EN 60721-3-2	In original packaging up to 45 kW
Operation		
Amplitude 1 mm		5 ... 13.2 Hz
Acceleration resistant up to 0.7 g	German Lloyd	13.2 ... 100 Hz
		up to 11 kW
Amplitude 0.075 mm		10 ... 57 Hz
Acceleration resistant up to 1 g	EN 61800-5-1	57 ... 150 Hz



Electrical supply conditions

Permissible power systems		
TT		Voltage to earth: max. 300 V
TN		Voltage to earth: max. 300 V
IT		Apply the measures described for IT systems!
		IT systems not relevant for UL-approved systems

The connection to different supply forms enables a worldwide application of the inverters.

The following is supported:

- [1-phase mains connection 120 V](#) 82
- [1-phase mains connection 230/240 V](#) 85
- [3-phase mains connection 230/240 V "Light Duty"](#) 100
- [3-phase mains connection 230/240 V](#) 94
- [3-phase mains connection 400 V](#) 103
- [3-phase mains connection 400 V "Light Duty"](#) 116
- [3-phase mains connection 480 V](#) 126
- [3-phase mains connection 480 V "Light Duty"](#) 139

Certification of the integrated safety

The certification of the integrated safety is based on these test fundamentals:

- EN ISO 13849-1: Safety of machinery – safety-related parts of control systems – Part 1
- EN ISO 13849-2: Safety of machinery – safety-related parts of control systems – Part 2
- EN 60204-1: Safety of machinery – electrical equipment of machines – Part 1
- EN 61508, Part 1-7: Safety of machinery Functional safety of electrical/electronic/programmable electronic safety-related systems
- EN 61800-3: Electric variable-speed drives – Part 3: EMC requirements including specific test procedures
- EN 61800-5-1: Adjustable speed electrical power drive systems – Part 5-1: Safety requirements – electrical, thermal and energy requirements
- EN 61800-5-2: Adjustable speed electrical power drive systems – Part 5-2: Safety requirements – functional safety
- EN 62061: Safety of machinery – functional safety of safety-related electrical/electronic/programmable electronic systems



Declarations of Conformity and certificates can be found on the internet at <http://www.Lenze.com>

Technical data

1-phase mains connection 120 V



1-phase mains connection 120 V



EMC filters are **not integrated** in inverters for this mains connection.



Rated data

The output currents apply to these operating conditions:

- At a switching frequency of 2 kHz or 4 kHz: Max. ambient temperature 45°C.
- At a switching frequency of 8 kHz or 16 kHz: Max. ambient temperature 40 °C.

Inverter		i550-C0.25/120-1	i550-C0.37/120-1	i550-C0.75/120-1	i550-C1.1/120-1
Rated power	kW	0.25	0.37	0.75	1.1
Rated power	hp	0.33	0.5	1	1.5
Mains voltage range		1/PE AC 90 V ... 132 V, 45 Hz ... 65 Hz			
Output voltage		3 AC 0-230/240 V			
Rated mains current					
without mains choke	A	6.8	9.6	16.8	22.9
with mains choke	A	6	8.5	14.7	17.1
Apparent output power	kVA	0.6	0.9	1.6	2.2
Rated output current					
2 kHz	A	1.7	2.4	4.2	6
4 kHz	A	1.7	2.4	4.2	6
8 kHz	A	1.7	2.4	4.2	6
16 kHz	A	1.1	1.6	2.8	4
Power loss					
2 kHz	W	15	19	29	39
4 kHz	W	16	21	29	40
8 kHz	W	18	23	35	47
16 kHz	W	20	24	36	45
when the controller is inhibited	W	6	6	6	6
Overcurrent cycle 180 s					
Max. output current	A	2.6	3.6	6.3	9
Overload time	s	60	60	60	60
Recovery time	s	120	120	120	120
Max. output current during the recovery time	A	1.3	1.8	3.2	4.5
Overcurrent cycle 15 s					
Max. output current	A	3.4	4.8	8.4	12
Overload time	s	3	3	3	3
Recovery time	s	12	12	12	12
Max. output current during the recovery time	A	1.3	1.8	3.2	4.5
Cyclic mains switching		3 times per minute			
Brake chopper					
Max. output current	A	2.2	2.2	8.3	8.3
Min. brake resistance	Ω	180	180	47	47
Max. shielded motor cable length					
without EMC category	m	50	50	50	50
Category C1 (2 kHz, 4 kHz, 8 kHz)	m	-	-	-	-
Category C2 (2 kHz, 4 kHz, 8 kHz)	m	-	-	-	-
Category C3 (2 kHz, 4 kHz, 8 kHz)	m	-	-	-	-
Weight	kg	1	1	1.35	1.35
Weight	lb	2.2	2.2	3	3

Technical data

1-phase mains connection 120 V

Fusing data



Fusing data



A residual current device (RCD) is optional.

EN 60204-1

Inverter	Fuse		Circuit breaker		RCD
	Characteristic	Max. rated current	Characteristic	Max. rated current	
i550-C0.25/120-1	gG/gL or gRL	16	B	16	≥ 30 mA, type B
i550-C0.37/120-1	gG/gL or gRL	16	B	16	≥ 30 mA, type B
i550-C0.75/120-1	gG/gL or gRL	25	B	25	≥ 30 mA, type B
i550-C1.1/120-1	gG/gL or gRL	25	B	25	≥ 30 mA, type B

The connection data according to UL can be found under: [▶ Connection according to UL](#) [□ 50](#)

Terminal data

Inverter	kW	i550-Cxxxx/120-1			
		0.25 ... 0.37	0.75 ... 1.1	0.25 ... 1.1	0.25 ... 1.1
Connection		Mains connection X100		PE connection	Motor connection X105
Connection type		Pluggable screw terminal		PE screw	Pluggable screw terminal
Max. Cable cross-section	mm ²	2.5	6	6	2.5
Stripping length	mm	8	8	10	8
Tightening torque	Nm	0.5	0.7	2	0.5
Required tool		0.5 x 3.0	0.6 x 3.5	Torx 20	0.5 x 3.0

The terminal data for the terminal X1 can be found under: [▶ Terminal data](#) [□ 78](#)

Brake resistors

Inverter	Order code	Brake resistor				
		Rated resistance	Rated power	Thermal capacity	Dimensions (H x W x D)	Weight
		Ω	W	kWs	mm	kg
i550-C0.25/120-1	ERBM180R050W	180	50	7.5	175 x 20.6 x 40	0.28
i550-C0.25/120-1	ERBP180R200W	180	200	30	240 x 42 x 122	1.0
i550-C0.37/120-1	ERBM180R050W	180	50	7.5	175 x 20.6 x 40	0.28
i550-C0.37/120-1	ERBP180R200W	180	200	30	240 x 42 x 122	1.0
i550-C0.75/120-1	ERBM047R135W	47	135	6.3	216 x 80 x 28	0.67
i550-C0.75/120-1	ERBP047R200W	47	200	30	240 x 42 x 122	1.0
i550-C1.1/120-1	ERBM047R135W	47	135	6.3	216 x 80 x 28	0.67
i550-C1.1/120-1	ERBS047R400W	47	400	60	400 x 114 x 105	2.3

Mains chokes

Inverter	Order code	No. of phases	Mains choke			
			Rated current	Inductance	Dimensions (h x w x d)	Weight
			A	mH	mm	kg
i550-C0.25/120-1	ELN1-0500H009	1	9	5	75 x 66 x 82	1.1
i550-C0.37/120-1						
i550-C0.75/120-1	ELN1-0250H018		18	2.5	96 x 96 x 90	2.1
i550-C1.1/120-1						



1-phase mains connection 230/240 V



When selecting the inverters, please note: **EMC filters** are integrated in the i550-Cxxx/230-1 inverters. **EMC filters** are not integrated in the inverters i550-Cxxx/230-2.

Technical data

1-phase mains connection 230/240 V

Rated data



Rated data

The output currents apply to these operating conditions:

- At a switching frequency of 2 kHz or 4 kHz: Max. ambient temperature 45°C.
- At a switching frequency of 8 kHz or 16 kHz: Max. ambient temperature 40 °C.

Inverter		i550-C0.25/230-1	i550-C0.25/230-2	i550-C0.37/230-1	i550-C0.37/230-2
Rated power	kW	0.25	0.25	0.37	0.37
Rated power	hp	0.33	0.33	0.5	0.5
Mains voltage range		1/PE AC 170 V ... 264 V, 45 Hz ... 65 Hz			
Output voltage		3 AC 0-230/240 V			
Rated mains current					
without mains choke	A	4	4	5.7	5.7
with mains choke	A	3.6	3.6	4.8	4.8
Apparent output power	kVA	0.6	0.6	0.9	0.9
Rated output current					
2 kHz	A	-	-	-	-
4 kHz	A	1.7	1.7	2.4	2.4
8 kHz	A	1.7	1.7	2.4	2.4
16 kHz	A	1.1	1.1	1.6	1.6
Power loss					
2 kHz	W	-	-	-	-
4 kHz	W	15	15	18	18
8 kHz	W	15	15	20	20
16 kHz	W	19	19	24	24
when the controller is inhibited	W	6	6	6	6
Overcurrent cycle 180 s					
Max. output current	A	2.6	2.6	3.6	3.6
Overload time	s	60	60	60	60
Recovery time	s	120	120	120	120
Max. output current during the recovery time	A	1.3	1.3	1.8	1.8
Overcurrent cycle 15 s					
Max. output current	A	3.4	3.4	4.8	4.8
Overload time	s	3	3	3	3
Recovery time	s	12	12	12	12
Max. output current during the recovery time	A	1.3	1.3	1.8	1.8
Cyclic mains switching		3 times per minute			
Brake chopper					
Max. output current	A	2.2	2.2	2.2	2.2
Min. brake resistance	Ω	180	180	180	180
Max. shielded motor cable length					
without EMC category	m	50	50	50	50
Category C1 (2 kHz, 4 kHz, 8 kHz)	m	3	-	3	-
Category C2 (2 kHz, 4 kHz, 8 kHz)	m	15	-	15	-
Category C3 (2 kHz, 4 kHz, 8 kHz)	m	15	-	15	-
Weight	kg	0.8	0.8	0.8	0.8
Weight	lb	1.8	1.8	1.8	1.8



Technical data

1-phase mains connection 230/240 V
Rated data

Inverter		i550-C0.55/230-1	i550-C0.55/230-2	i550-C0.75/230-1	i550-C0.75/230-2
Rated power	kW	0.55	0.55	0.75	0.75
Rated power	hp	0.75	0.75	1	1
Mains voltage range		1/PE AC 170 V ... 264 V, 45 Hz ... 65 Hz			
Output voltage		3 AC 0-230/240 V			
Rated mains current					
without mains choke	A	7.6	7.6	10	10
with mains choke	A	7.1	7.1	8.8	8.8
Apparent output power	kVA	1.2	1.2	1.6	1.6
Rated output current					
2 kHz	A	3.2	3.2	4.2	4.2
4 kHz	A	3.2	3.2	4.2	4.2
8 kHz	A	3.2	3.2	4.2	4.2
16 kHz	A	2.1	2.1	2.8	2.8
Power loss					
2 kHz	W	22	22	27	27
4 kHz	W	23	23	29	29
8 kHz	W	25	25	33	33
16 kHz	W	30	30	38	38
when the controller is inhibited	W	6	6	6	6
Overcurrent cycle 180 s					
Max. output current	A	4.8	4.8	6.3	6.3
Overload time	s	60	60	60	60
Recovery time	s	120	120	120	120
Max. output current during the recovery time	A	2.4	2.4	3.2	3.2
Overcurrent cycle 15 s					
Max. output current	A	6.4	6.4	8.4	8.4
Overload time	s	3	3	3	3
Recovery time	s	12	12	12	12
Max. output current during the recovery time	A	2.4	2.4	3.2	3.2
Cyclic mains switching		3 times per minute			
Brake chopper					
Max. output current	A	3.9	3.9	3.9	3.9
Min. brake resistance	Ω	100	100	100	100
Max. shielded motor cable length					
without EMC category	m	50	50	50	50
Category C1 (2 kHz, 4 kHz, 8 kHz)	m	3	-	3	-
Category C2 (2 kHz, 4 kHz, 8 kHz)	m	20	-	20	-
Category C3 (2 kHz, 4 kHz, 8 kHz)	m	50	-	50	-
Weight	kg	1	1	1	1
Weight	lb	2.2	2.2	2.2	2.2

Technical data

1-phase mains connection 230/240 V

Rated data



Inverter		i550-C1.1/230-1	i550-C1.1/230-2	i550-C1.5/230-1	i550-C1.5/230-2
Rated power	kW	1.1	1.1	1.5	1.5
Rated power	hp	1.5	1.5	2	2
Mains voltage range		1/PE AC 170 V ... 264 V, 45 Hz ... 65 Hz			
Output voltage		3 AC 0-230/240 V			
Rated mains current					
without mains choke	A	14.3	14.3	16.7	16.7
with mains choke	A	11.9	11.9	13.9	13.9
Apparent output power	kVA	2.2	2.2	2.6	2.6
Rated output current					
2 kHz	A	6	6	7	7
4 kHz	A	6	6	7	7
8 kHz	A	6	6	7	7
16 kHz	A	4	4	4.7	4.7
Power loss					
2 kHz	W	36	36	41	41
4 kHz	W	37	37	43	43
8 kHz	W	42	42	50	50
16 kHz	W	51	51	59	59
when the controller is inhibited	W	6	6	6	6
Overcurrent cycle 180 s					
Max. output current	A	9	9	10.5	10.5
Overload time	s	60	60	60	60
Recovery time	s	120	120	120	120
Max. output current during the recovery time	A	4.5	4.5	5.3	5.3
Overcurrent cycle 15 s					
Max. output current	A	12	12	14	14
Overload time	s	3	3	3	3
Recovery time	s	12	12	12	12
Max. output current during the recovery time	A	4.5	4.5	5.3	5.3
Cyclic mains switching		3 times per minute			
Brake chopper					
Max. output current	A	12	12	12	12
Min. brake resistance	Ω	33	33	33	33
Max. shielded motor cable length					
without EMC category	m	50	50	50	50
Category C1 (2 kHz, 4 kHz, 8 kHz)	m	3	-	3	-
Category C2 (2 kHz, 4 kHz, 8 kHz)	m	20	-	20	-
Category C3 (2 kHz, 4 kHz, 8 kHz)	m	35	-	35	-
Weight	kg	1.35	1.35	1.35	1.35
Weight	lb	3	3	3	3



Technical data

1-phase mains connection 230/240 V
Rated data

Inverter		i550-C2.2/230-1	i550-C2.2/230-2
Rated power	kW	2.2	2.2
Rated power	hp	3	3
Mains voltage range		1/PE AC 170 V ... 264 V, 45 Hz ... 65 Hz	
Output voltage		3 AC 0-230/240 V	
Rated mains current			
without mains choke	A	22.5	22.5
with mains choke	A	16.9	16.9
Apparent output power	kVA	3.6	3.6
Rated output current			
2 kHz	A	9.6	9.6
4 kHz	A	9.6	9.6
8 kHz	A	9.6	9.6
16 kHz	A	6.4	6.4
Power loss			
2 kHz	W	54	54
4 kHz	W	60	60
8 kHz	W	70	70
16 kHz	W	78	78
when the controller is inhibited	W	6	6
Overcurrent cycle 180 s			
Max. output current	A	14.4	14.4
Overload time	s	60	60
Recovery time	s	120	120
Max. output current during the recovery time	A	7.2	7.2
Overcurrent cycle 15 s			
Max. output current	A	19.2	19.2
Overload time	s	3	3
Recovery time	s	12	12
Max. output current during the recovery time	A	7.2	7.2
Cyclic mains switching		3 times per minute	
Brake chopper			
Max. output current	A	12	12
Min. brake resistance	Ω	33	33
Max. shielded motor cable length			
without EMC category	m	50	50
Category C1 (2 kHz, 4 kHz, 8 kHz)	m	3	-
Category C2 (2 kHz, 4 kHz, 8 kHz)	m	20	-
Category C3 (2 kHz, 4 kHz, 8 kHz)	m	35	-
Weight	kg	1.35	1.35
Weight	lb	3	3

Technical data

1-phase mains connection 230/240 V
Fusing data



Fusing data



A residual current device (RCD) is optional.

EN 60204-1

Inverter	Fuse		Circuit breaker		RCD
	Characteristic	Max. rated current	Characteristic	Max. rated current	
		A		A	
i550-C0.25/230-1	gG/gL or gRL	10	B	10	≥ 30 mA, type B
i550-C0.25/230-2	gG/gL or gRL	10	B	10	≥ 30 mA, type B
i550-C0.37/230-1	gG/gL or gRL	10	B	10	≥ 30 mA, type B
i550-C0.37/230-2	gG/gL or gRL	10	B	10	≥ 30 mA, type B
i550-C0.55/230-1	gG/gL or gRL	16	B	16	≥ 30 mA, type B
i550-C0.55/230-2	gG/gL or gRL	16	B	16	≥ 30 mA, type B
i550-C0.75/230-1	gG/gL or gRL	16	B	16	≥ 30 mA, type B
i550-C0.75/230-2	gG/gL or gRL	16	B	16	≥ 30 mA, type B
i550-C1.1/230-1	gG/gL or gRL	25	B	25	≥ 30 mA, type B
i550-C1.1/230-2	gG/gL or gRL	25	B	25	≥ 30 mA, type B
i550-C1.5/230-1	gG/gL or gRL	25	B	25	≥ 30 mA, type B
i550-C1.5/230-2	gG/gL or gRL	25	B	25	≥ 30 mA, type B
i550-C2.2/230-1	gG/gL or gRL	25	B	25	≥ 30 mA, type B
i550-C2.2/230-2	gG/gL or gRL	25	B	25	≥ 30 mA, type B

The connection data according to UL can be found under: [▶ Connection according to UL](#) [📄 50](#)

Terminal data

Inverter	kW	i550-Cxxxx/230-x			
		0.25 ... 0.75	1.1 ... 2.2	0.25 ... 2.2	0.25 ... 2.2
Connection		Mains connection X100		PE connection	Motor connection X105
Connection type		Pluggable screw terminal		PE screw	Pluggable screw terminal
Max. Cable cross-section	mm ²	2.5	6	6	2.5
Stripping length	mm	8	8	10	8
Tightening torque	Nm	0.5	0.7	2	0.5
Required tool		0.5 x 3.0	0.6 x 3.5	Torx 20	0.5 x 3.0

The terminal data for the terminal X1 can be found under: [▶ Terminal data](#) [📄 78](#)



Technical data

1-phase mains connection 230/240 V
Brake resistors

Brake resistors

Inverter	Brake resistor					
	Order code	Rated resistance	Rated power	Thermal capacity	Dimensions (H x W x D)	Weight
		Ω	W	kWs	mm	kg
i550-C0.25/230-1	ERBM180R050W	180	50	7.5	175 x 20.6 x 40	0.28
i550-C0.25/230-1	ERBP180R200W	180	200	30	240 x 42 x 122	1.0
i550-C0.25/230-2	ERBM180R050W	180	50	7.5	175 x 20.6 x 40	0.28
i550-C0.25/230-2	ERBP180R200W	180	200	30	240 x 42 x 122	1.0
i550-C0.37/230-1	ERBM180R050W	180	50	7.5	175 x 20.6 x 40	0.28
i550-C0.37/230-1	ERBP180R200W	180	200	30	240 x 42 x 122	1.0
i550-C0.37/230-2	ERBM180R050W	180	50	7.5	175 x 20.6 x 40	0.28
i550-C0.37/230-2	ERBP180R200W	180	200	30	240 x 42 x 122	1.0
i550-C0.55/230-1	ERBM100R086W	100	86	3.4	110 x 80 x 28	0.49
i550-C0.55/230-1	ERBM100R150W	100	150	22.5	238 x 80 x 59	0.54
i550-C0.55/230-2	ERBM100R086W	100	86	3.4	110 x 80 x 28	0.49
i550-C0.55/230-2	ERBM100R150W	100	150	22.5	238 x 80 x 59	0.54
i550-C0.75/230-1	ERBM100R086W	100	86	3.4	110 x 80 x 28	0.49
i550-C0.75/230-1	ERBM100R150W	100	150	22.5	238 x 80 x 59	0.54
i550-C0.75/230-2	ERBM100R086W	100	86	3.4	110 x 80 x 28	0.49
i550-C0.75/230-2	ERBM100R150W	100	150	22.5	238 x 80 x 59	0.54
i550-C1.1/230-1	ERBP033R200W	33	200	30	240 x 42 x 122	1.0
i550-C1.1/230-1	ERBP033R300W	33	300	45	320 x 42 x 122	1.4
i550-C1.1/230-2	ERBP033R200W	33	200	30	240 x 42 x 122	1.0
i550-C1.1/230-2	ERBP033R300W	33	300	45	320 x 42 x 122	1.4
i550-C1.5/230-1	ERBP033R200W	33	200	30	240 x 42 x 122	1.0
i550-C1.5/230-1	ERBP033R300W	33	300	45	320 x 42 x 122	1.4
i550-C1.5/230-2	ERBP033R200W	33	200	30	240 x 42 x 122	1.0
i550-C1.5/230-2	ERBP033R300W	33	300	45	320 x 42 x 122	1.4
i550-C2.2/230-1	ERBP033R200W	33	200	30	240 x 42 x 122	1.0
i550-C2.2/230-1	ERBP033R300W	33	300	45	320 x 42 x 122	1.4
i550-C2.2/230-2	ERBP033R200W	33	200	30	240 x 42 x 122	1.0
i550-C2.2/230-2	ERBP033R300W	33	300	45	320 x 42 x 122	1.4

Mains chokes

Inverter	Mains choke					
	Order code	No. of phases	Rated current	Inductance	Dimensions (h x w x d)	Weight
			A	mH	mm	kg
i550-C0.25/230-1	ELN1-0900H005	1	5	9	75 x 66 x 82	1.1
i550-C0.25/230-2						
i550-C0.37/230-1						
i550-C0.37/230-2						
i550-C0.55/230-1	ELN1-0500H009		9	5	75 x 66 x 82	1.1
i550-C0.55/230-2						
i550-C0.75/230-1						
i550-C0.75/230-2						
i550-C1.1/230-1	ELN1-0250H018	18	2.5	96 x 96 x 90	2.1	
i550-C1.1/230-2						
i550-C1.5/230-1						
i550-C1.5/230-2						
i550-C2.2/230-1						
i550-C2.2/230-2						

Technical data

1-phase mains connection 230/240 V
RFI filters / Mains filters



RFI filters / Mains filters

Basic information on RFI filters, mains filters and EMC: from [193](#)



EMC filters can be used both in the side structure and in the substructure.

Maximum motor cable lengths with residual current device (RCD)

Mains connection			1-phase, 230 V		
Inverter			i550-C0.25/230-1 i550-C0.37/230-1	i550-C0.55/230-1 i550-C0.75/230-1	i550-C1.1/230-1 i550-C1.5/230-1 i550-C2.2/230-1
Without RFI filter					
without EMC category Thermal limitation	Max. motor cable length shielded	m	50	50	50
	Max. motor cable length unshielded	m	100	100	200
With integrated RFI filter					
Category C1	Max. motor cable length shielded	m	3	3	3
Category C2		m	15	20	20
	Earth-leakage circuit breaker (optional)	mA	30	30	30
RFI filter Low Leakage					
Category C1	Max. motor cable length shielded	m	5	5	5
	Earth-leakage circuit breaker (optional)	mA	10	10	10
RFI filter Short Distance					
Category C1	Max. motor cable length shielded	m	25	25	25
Category C2		m	50	50	50
	Earth-leakage circuit breaker (optional)	mA	30	30	30
RFI filter Long Distance					
Category C1	Max. motor cable length shielded	m	50	50	50
Category C2		m	50	50	50
	Earth-leakage circuit breaker (optional)	mA	300	300	300

Low Leakage

Inverter	Filters			
	Order code	Rated current A	Dimensions (h x w x d) mm	Weight kg
i550-C0.25/230-1 i550-C0.37/230-1	I0FAE137B100L0000S	6	226 x 60 x 50	0.85
i550-C0.55/230-1 i550-C0.75/230-1	I0FAE175B100L0000S	10	276 x 60 x 50	1
i550-C1.1/230-1 i550-C1.5/230-1 i550-C2.2/230-1	I0FAE222B100L0000S	22.5	346 x 60 x 50	1.4



Technical data

1-phase mains connection 230/240 V
RFI filters / Mains filters

Short Distance

Inverter	Filters			
	Order code	Rated current	Dimensions (h x w x d)	Weight
		A	mm	kg
i550-C0.25/230-1	IOFAE175B100S0000S	10	276 x 60 x 50	0.85
i550-C0.37/230-1				
i550-C0.55/230-1				
i550-C0.75/230-1				
i550-C1.1/230-1	IOFAE222B100S0000S	22.5	346 x 60 x 50	1.2
i550-C1.5/230-1				
i550-C2.2/230-1				

Long Distance

Inverter	Filters			
	Order code	Rated current	Dimensions (h x w x d)	Weight
		A	mm	kg
i550-C0.25/230-1	IOFAE175B100D0000S	10	276 x 60 x 50	0.85
i550-C0.37/230-1				
i550-C0.55/230-1				
i550-C0.75/230-1				
i550-C1.1/230-1	IOFAE222B100D0000S	22.5	346 x 60 x 50	1.2
i550-C1.5/230-1				
i550-C2.2/230-1				

Technical data

3-phase mains connection 230/240 V



3-phase mains connection 230/240 V



EMC filters are **not integrated** in inverters for this mains connection.



Rated data

The output currents apply to these operating conditions:

- At a switching frequency of 2 kHz or 4 kHz: Max. ambient temperature 45°C.
- At a switching frequency of 8 kHz or 16 kHz: Max. ambient temperature 40 °C.

Inverter		i550-C0.25/230-2	i550-C0.37/230-2	i550-C0.55/230-2	i550-C0.75/230-2
Rated power	kW	0.25	0.37	0.55	0.75
Rated power	hp	0.33	0.5	0.75	1
Mains voltage range		3/PE AC 170 V ... 264 V, 45 Hz ... 65 Hz			
Output voltage		3 AC 0-230/240 V			
Rated mains current					
without mains choke	A	2.6	3.9	4.8	6.4
with mains choke	A	2	3	3.8	5.1
Apparent output power	kVA	0.6	0.9	1.2	1.6
Rated output current					
2 kHz	A	-	-	3.2	4.2
4 kHz	A	1.7	2.4	3.2	4.2
8 kHz	A	1.7	2.4	3.2	4.2
16 kHz	A	1.1	1.6	2.1	2.8
Power loss					
2 kHz	W	-	-	22	27
4 kHz	W	15	18	23	29
8 kHz	W	15	20	25	33
16 kHz	W	19	24	30	38
when the controller is inhibited	W	6	6	6	6
Overcurrent cycle 180 s					
Max. output current	A	2.6	3.6	4.8	6.3
Overload time	s	60	60	60	60
Recovery time	s	120	120	120	120
Max. output current during the recovery time	A	1.3	1.8	2.4	3.2
Overcurrent cycle 15 s					
Max. output current	A	3.4	4.8	6.4	8.4
Overload time	s	3	3	3	3
Recovery time	s	12	12	12	12
Max. output current during the recovery time	A	1.3	1.8	2.4	3.2
Cyclic mains switching		3 times per minute			
Brake chopper					
Max. output current	A	2.2	2.2	3.9	3.9
Min. brake resistance	Ω	180	180	100	100
Max. shielded motor cable length					
without EMC category	m	50	50	50	50
Category C1 (2 kHz, 4 kHz, 8 kHz)	m	-	-	-	-
Category C2 (2 kHz, 4 kHz, 8 kHz)	m	-	-	-	-
Category C3 (2 kHz, 4 kHz, 8 kHz)	m	-	-	-	-
Weight	kg	0.8	0.8	1	1
Weight	lb	1.8	1.8	2.2	2.2

Technical data

3-phase mains connection 230/240 V

Rated data



Inverter		i550-C1.1/230-2	i550-C1.5/230-2	i550-C2.2/230-2	i550-C4.0/230-3
Rated power	kW	1.1	1.5	2.2	4
Rated power	hp	1.5	2	3	5
Mains voltage range		3/PE AC 170 V ... 264 V, 45 Hz ... 65 Hz			
Output voltage		3 AC 0-230/240 V			
Rated mains current					
without mains choke	A	7.8	9.5	13.6	20.6
with mains choke	A	5.6	6.8	9.8	15.7
Apparent output power	kVA	2.2	2.6	3.6	6.4
Rated output current					
2 kHz	A	6	7	9.6	16.5
4 kHz	A	6	7	9.6	16.5
8 kHz	A	6	7	9.6	16.5
16 kHz	A	4	4.7	6.4	11
Power loss					
2 kHz	W	36	41	54	113
4 kHz	W	37	43	60	115
8 kHz	W	42	50	70	130
16 kHz	W	51	59	78	116
when the controller is inhibited	W	6	6	6	6
Overcurrent cycle 180 s					
Max. output current	A	9	10.5	14.4	24.8
Overload time	s	60	60	60	60
Recovery time	s	120	120	120	120
Max. output current during the recovery time	A	4.5	5.3	7.2	12.4
Overcurrent cycle 15 s					
Max. output current	A	12	14	19.2	33
Overload time	s	3	3	3	3
Recovery time	s	12	12	12	12
Max. output current during the recovery time	A	4.5	5.3	7.2	12.4
Cyclic mains switching		3 times per minute			
Brake chopper					
Max. output current	A	12	12	12	26
Min. brake resistance	Ω	33	33	33	15
Max. shielded motor cable length					
without EMC category	m	50	50	50	50
Category C1 (2 kHz, 4 kHz, 8 kHz)	m	-	-	-	-
Category C2 (2 kHz, 4 kHz, 8 kHz)	m	-	-	-	-
Category C3 (2 kHz, 4 kHz, 8 kHz)	m	-	-	-	-
Weight	kg	1.35	1.35	1.35	2.1
Weight	lb	3	3	3	4.6



Technical data

3-phase mains connection 230/240 V
Rated data

Inverter		i550-C5.5/230-3
Rated power	kW	5.5
Rated power	hp	7.5
Mains voltage range		3/PE AC 170 V ... 264 V, 45 Hz ... 65 Hz
Output voltage		3 AC 0-230/240 V
Rated mains current		
without mains choke	A	28.8
with mains choke	A	21.9
Apparent output power	kVA	8.7
Rated output current		
2 kHz	A	23
4 kHz	A	23
8 kHz	A	23
16 kHz	A	15.3
Power loss		
2 kHz	W	166
4 kHz	W	175
8 kHz	W	195
16 kHz	W	159
when the controller is inhibited	W	6
Overcurrent cycle 180 s		
Max. output current	A	34.5
Overload time	s	60
Recovery time	s	120
Max. output current during the recovery time	A	17.3
Overcurrent cycle 15 s		
Max. output current	A	46
Overload time	s	3
Recovery time	s	12
Max. output current during the recovery time	A	17.3
Cyclic mains switching		3 times per minute
Brake chopper		
Max. output current	A	26
Min. brake resistance	Ω	15
Max. shielded motor cable length		
without EMC category	m	50
Category C1 (2 kHz, 4 kHz, 8 kHz)	m	-
Category C2 (2 kHz, 4 kHz, 8 kHz)	m	-
Category C3 (2 kHz, 4 kHz, 8 kHz)	m	-
Weight	kg	2.1
Weight	lb	4.6

Technical data

3-phase mains connection 230/240 V

Fusing data



Fusing data



A residual current device (RCD) is optional.

EN 60204-1

Inverter	Fuse		Circuit breaker		RCD
	Characteristic	Max. rated current	Characteristic	Max. rated current	
i550-C0.25/230-2	gG/gL or gRL	10	B	10	≥ 30 mA, type B
i550-C0.37/230-2	gG/gL or gRL	10	B	10	≥ 30 mA, type B
i550-C0.55/230-2	gG/gL or gRL	16	B	16	≥ 30 mA, type B
i550-C0.75/230-2	gG/gL or gRL	16	B	16	≥ 30 mA, type B
i550-C1.1/230-2	gG/gL or gRL	25	B	25	≥ 30 mA, type B
i550-C1.5/230-2	gG/gL or gRL	25	B	25	≥ 30 mA, type B
i550-C2.2/230-2	gG/gL or gRL	25	B	25	≥ 30 mA, type B
i550-C4.0/230-3	gG/gL or gRL	32	B	32	≥ 300 mA, type B
i550-C5.5/230-3	gG/gL or gRL	32	B	32	≥ 300 mA, type B

The connection data according to UL can be found under: [▶ Connection according to UL 50](#)

Terminal data

		i550-Cxxxx/230-x			
Inverter	kW	0.25 ... 0.75	1.1 ... 2.2	4.0 ... 5.5	0.25 ... 5.5
Connection		Mains connection X100			PE connection
Connection type		Pluggable screw terminal		Screw terminal	PE screw
Max. Cable cross-section	mm ²	2.5	6	6	6
Stripping length	mm	8	8	9	10
Tightening torque	Nm	0.5	0.7	0.5	2
Required tool		0.5 x 3.0		0.6 x 3.5	Torx 20

		i550-Cxxxx/230-x	
Inverter	kW	0.25 ... 2.2	4.0 ... 5.5
Connection		Motor connection X105	
Connection type		Pluggable screw terminal	Screw terminal
Max. Cable cross-section	mm ²	2.5	6
Stripping length	mm	8	9
Tightening torque	Nm	0.5	0.5
Required tool		0.5 x 3.0	0.6 x 3.5

The terminal data for the terminal X1 can be found under: [▶ Terminal data 78](#)



Technical data

3-phase mains connection 230/240 V
Brake resistors

Brake resistors

Inverter	Brake resistor					
	Order code	Rated resistance	Rated power	Thermal capacity	Dimensions (H x W x D)	Weight
		Ω	W	kWs	mm	kg
i550-C0.25/230-2	ERBM180R050W	180	50	7.5	175 x 20.6 x 40	0.28
i550-C0.25/230-2	ERBP180R200W	180	200	30	240 x 42 x 122	1.0
i550-C0.37/230-2	ERBM180R050W	180	50	7.5	175 x 20.6 x 40	0.28
i550-C0.37/230-2	ERBP180R200W	180	200	30	240 x 42 x 122	1.0
i550-C0.55/230-2	ERBM100R086W	100	86	3.4	110 x 80 x 28	0.49
i550-C0.55/230-2	ERBM100R150W	100	150	22.5	238 x 80 x 59	0.54
i550-C0.75/230-2	ERBM100R086W	100	86	3.4	110 x 80 x 28	0.49
i550-C0.75/230-2	ERBM100R150W	100	150	22.5	238 x 80 x 59	0.54
i550-C1.1/230-2	ERBP033R200W	33	200	30	240 x 42 x 122	1.0
i550-C1.1/230-2	ERBP033R300W	33	300	45	320 x 42 x 122	1.4
i550-C1.5/230-2	ERBP033R200W	33	200	30	240 x 42 x 122	1.0
i550-C1.5/230-2	ERBP033R300W	33	300	45	320 x 42 x 122	1.4
i550-C2.2/230-2	ERBP033R200W	33	200	30	240 x 42 x 122	1.0
i550-C2.2/230-2	ERBP033R300W	33	300	45	320 x 42 x 122	1.4
i550-C4.0/230-3	ERBS015R800W	15	800	120	710 x 114 x 105	4.0
i550-C4.0/230-3	ERBS015R01K2	15	1200	180	1020 x 114 x 105	5.6
i550-C5.5/230-3	ERBS015R800W	15	800	120	710 x 114 x 105	4.0
i550-C5.5/230-3	ERBS015R01K2	15	1200	180	1020 x 114 x 105	5.6

Mains chokes

Inverter	Mains choke					
	Order code	No. of phases	Rated current	Inductance	Dimensions (h x w x d)	Weight
			A	mH	mm	kg
i550-C0.25/230-2	EZAELN3002B153	3	2	14.7	56 x 77 x 100	0.53
i550-C0.37/230-2	EZAELN3004B742		4	7.35	60 x 95 x 115	1.31
i550-C0.55/230-2			6	4.9	69 x 95 x 120	1.45
i550-C0.75/230-2	EZAELN3006B492		8	3.68	85 x 120 x 140	1.9
i550-C1.1/230-2			10	2.94		2
i550-C1.5/230-2	EZAELN3008B372		25	1.18	110 x 155 x 170	5.8
i550-C2.2/230-2	EZAELN3010B292					
i550-C5.5/230-3	EZAELN3025B122					

Technical data

3-phase mains connection 230/240 V "Light Duty"
Rated data



3-phase mains connection 230/240 V "Light Duty"

Rated data



EMC filters are not integrated in inverters for this mains connection.



Technical data

3-phase mains connection 230/240 V "Light Duty"
Rated data

The output currents apply to these operating conditions:

- At a switching frequency of 2 kHz or 4 kHz: Ambient temperature above 40 °C with a rated output current reduced by 2.5 %/°C.
- If the load characteristic "Light Duty" and the switching frequencies 8 kHz or 16 kHz are selected, only the values of the load characteristic "Heavy Duty" are reached.

Inverter		i550-C4.0/230-3	i550-C5.5/230-3
Rated power	kW	5.5	7.5
Rated power	hp	7.5	10
Mains voltage range		3/PE AC 170 V ... 264 V, 45 Hz ... 65 Hz	
Output voltage		3 AC 0-230/240 V	
Rated mains current			
without mains choke	A	25.8	-
with mains choke	A	18.9	24.2
Apparent output power	kVA	8	10.5
Rated output current			
2 kHz	A	20.6	27.6
4 kHz	A	20.6	27.6
8 kHz	A	-	-
16 kHz	A	-	-
Power loss			
2 kHz	W	124	190
4 kHz	W	131	200
8 kHz	W	-	-
16 kHz	W	-	-
when the controller is inhibited	W	6	6
Overcurrent cycle 180 s			
Max. output current	A	24.8	34.5
Overload time	s	60	60
Recovery time	s	120	120
Max. output current during the recovery time	A	12.4	17.3
Overcurrent cycle 15 s			
Max. output current	A	33	46
Overload time	s	3	3
Recovery time	s	12	12
Max. output current during the recovery time	A	12.4	17.3
Cyclic mains switching		3 times per minute	
Brake chopper			
Max. output current	A	26	26
Min. brake resistance	Ω	15	15
Max. shielded motor cable length			
without EMC category	m	50	50
Category C1 (2 kHz, 4 kHz, 8 kHz)	m	-	-
Category C2 (2 kHz, 4 kHz, 8 kHz)	m	-	-
Category C3 (2 kHz, 4 kHz, 8 kHz)	m	-	-
Weight	kg	2.1	2.1
Weight	lb	4.6	4.6

Technical data

3-phase mains connection 230/240 V "Light Duty"
Fusing data



Fusing data



A residual current device (RCD) is optional.

EN 60204-1

Inverter	Fuse		Circuit breaker		RCD
	Characteristic	Max. rated current	Characteristic	Max. rated current	
		A		A	
i550-C4.0/230-3	gG/gL or gRL	32	B	32	≥ 300 mA, type B
i550-C5.5/230-3	gG/gL or gRL	32	B	32	≥ 300 mA, type B

The connection data according to UL can be found under: [▶ Connection according to UL](#) [□ 50](#)

Terminal data

Inverter	kW	i550-Cxxxx/230-x		
		5.5 ... 7.5	5.5 ... 7.5	5.5 ... 7.5
Connection		Mains connection X100	PE connection	Motor connection X105
Connection type		Screw terminal	PE screw	Screw terminal
Max. Cable cross-section	mm ²	6	6	6
Stripping length	mm	9	10	9
Tightening torque	Nm	0.5	2	0.5
Required tool		0.6 x 3.5	Torx 20	0.6 x 3.5

The terminal data for the terminal X1 can be found under: [▶ Terminal data](#) [□ 78](#)

Brake resistors

Inverter	Brake resistor					Weight
	Order code	Rated resistance	Rated power	Thermal capacity	Dimensions (H x W x D)	
		Ω	W	kWs	mm	kg
i550-C4.0/230-3	ERBS015R800W	15	800	120	710 x 114 x 105	4.0
i550-C4.0/230-3	ERBS015R01K2	15	1200	180	1020 x 114 x 105	5.6
i550-C5.5/230-3	ERBS015R800W	15	800	120	710 x 114 x 105	4.0
i550-C5.5/230-3	ERBS015R01K2	15	1200	180	1020 x 114 x 105	5.6

Mains chokes

Inverter	Mains choke					Weight
	Order code	No. of phases	Rated current	Inductance	Dimensions (h x w x d)	
			A	mH	mm	kg
i550-C5.5/230-3	EZAELN3025B122	3	25	1.18	110 x 155 x 170	5.8



3-phase mains connection 400 V

Rated data

The output currents apply to these operating conditions:

- At a switching frequency of 2 kHz or 4 kHz: Max. ambient temperature 45°C.
- At a switching frequency of 8 kHz or 16 kHz: Max. ambient temperature 40 °C.

Inverter		i550-C0.37/400-3	i550-C0.55/400-3	i550-C0.75/400-3	i550-C1.1/400-3
Rated power	kW	0.37	0.55	0.75	1.1
Rated power	hp	0.5	0.75	1	1.5
Mains voltage range		3/PE AC 340 V ... 528 V, 45 Hz ... 65 Hz			
Output voltage		3 AC 0-400/480 V			
Rated mains current					
without mains choke	A	1.8	2.5	3.3	4.4
with mains choke	A	1.4	2	2.6	3
Apparent output power	kVA	0.9	1.2	1.6	2.2
Rated output current					
2 kHz	A	-	1.8	2.4	3.2
4 kHz	A	1.3	1.8	2.4	3.2
8 kHz	A	1.3	1.8	2.4	3.2
16 kHz	A	0.9	1.2	1.6	2.1
Power loss					
2 kHz	W	-	24	30	38
4 kHz	W	20	25	32	40
8 kHz	W	24	31	40	51
16 kHz	W	24	31	40	51
when the controller is inhibited	W	6	6	6	6
Overcurrent cycle 180 s					
Max. output current	A	2	2.7	3.6	4.8
Overload time	s	60	60	60	60
Recovery time	s	120	120	120	120
Max. output current during the recovery time	A	1	1.4	1.8	2.4
Overcurrent cycle 15 s					
Max. output current	A	2.6	3.6	4.8	6.4
Overload time	s	3	3	3	3
Recovery time	s	12	12	12	12
Max. output current during the recovery time	A	1	1.4	1.8	2.4
Cyclic mains switching		3 times per minute			
Brake chopper					
Max. output current	A	2	2	2	5.2
Min. brake resistance	Ω	390	390	390	150
Max. shielded motor cable length					
without EMC category	m	15	50	50	50
Category C1 (2 kHz, 4 kHz, 8 kHz)	m	3	3	3	-
Category C2 (2 kHz, 4 kHz, 8 kHz)	m	15	20	20	20
Category C3 (2 kHz, 4 kHz, 8 kHz)	m	15	20	20	35
Weight	kg	0.8	1	1	1.35
Weight	lb	1.8	2.2	2.2	3

Technical data

3-phase mains connection 400 V

Rated data



Inverter		i550-C1.5/400-3	i550-C2.2/400-3	i550-C3.0/400-3	i550-C4.0/400-3
Rated power	kW	1.5	2.2	3	4
Rated power	hp	2	3	4	5
Mains voltage range		3/PE AC 340 V ... 528 V, 45 Hz ... 65 Hz			
Output voltage		3 AC 0-400/480 V			
Rated mains current					
without mains choke	A	5.4	7.8	9.6	12.5
with mains choke	A	3.7	5.3	6.9	9
Apparent output power	kVA	2.6	3.8	4.9	6.4
Rated output current					
2 kHz	A	3.9	5.6	7.3	9.5
4 kHz	A	3.9	5.6	7.3	9.5
8 kHz	A	3.9	5.6	7.3	9.5
16 kHz	A	2.6	3.7	4.9	6.3
Power loss					
2 kHz	W	45	62	79	102
4 kHz	W	48	66	85	110
8 kHz	W	61	85	110	140
16 kHz	W	61	85	109	140
when the controller is inhibited	W	6	6	6	6
Overcurrent cycle 180 s					
Max. output current	A	5.9	8.4	11	14.3
Overload time	s	60	60	60	60
Recovery time	s	120	120	120	120
Max. output current during the recovery time	A	2.9	4.2	5.5	7.1
Overcurrent cycle 15 s					
Max. output current	A	7.8	11.2	14.6	19
Overload time	s	3	3	3	3
Recovery time	s	12	12	12	12
Max. output current during the recovery time	A	2.9	4.2	5.5	7.1
Cyclic mains switching		3 times per minute			
Brake chopper					
Max. output current	A	5.2	5.2	9.5	16.6
Min. brake resistance	Ω	150	150	82	47
Max. shielded motor cable length					
without EMC category	m	50	50	50	50
Category C1 (2 kHz, 4 kHz, 8 kHz)	m	-	-	-	-
Category C2 (2 kHz, 4 kHz, 8 kHz)	m	20	20	20	20
Category C3 (2 kHz, 4 kHz, 8 kHz)	m	35	35	35	35
Weight	kg	1.35	1.35	1.35	1.35
Weight	lb	3	3	3	3



Technical data

3-phase mains connection 400 V
Rated data

Inverter		i550-C5.5/400-3	i550-C7.5/400-3	i550-C11/400-3	i550-C15/400-3
Rated power	kW	5.5	7.5	11	15
Rated power	hp	7.5	10	15	20
Mains voltage range		3/PE AC 340 V ... 528 V, 45 Hz ... 65 Hz			
Output voltage		3 AC 0-400/480 V			
Rated mains current					
without mains choke	A	17.2	20	28.4	38.7
with mains choke	A	12.4	15.7	22.3	28.8
Apparent output power	kVA	8.7	11	16	22
Rated output current					
2 kHz	A	13	16.5	23.5	32
4 kHz	A	13	16.5	23.5	32
8 kHz	A	13	16.5	23.5	32
16 kHz	A	8.7	11	15.7	21.3
Power loss					
2 kHz	W	137	172	242	340
4 kHz	W	145	185	260	360
8 kHz	W	190	240	340	460
16 kHz	W	189	238	337	469
when the controller is inhibited	W	6	6	6	18
Overcurrent cycle 180 s					
Max. output current	A	19.5	25	35	48
Overload time	s	60	60	60	60
Recovery time	s	120	120	120	120
Max. output current during the recovery time	A	9.8	12.4	17.6	24
Overcurrent cycle 15 s					
Max. output current	A	26	33	47	64
Overload time	s	3	3	3	3
Recovery time	s	12	12	12	12
Max. output current during the recovery time	A	9.8	12.4	17.6	24
Cyclic mains switching		3 times per minute			
Brake chopper					
Max. output current	A	16.6	29	29	43
Min. brake resistance	Ω	47	27	27	18
Max. shielded motor cable length					
without EMC category	m	100	100	100	100
Category C1 (2 kHz, 4 kHz, 8 kHz)	m	-	-	-	-
Category C2 (2 kHz, 4 kHz, 8 kHz)	m	20	20	20	20
Category C3 (2 kHz, 4 kHz, 8 kHz)	m	35	50	50	35
Weight	kg	2.3	3.7	3.7	10.3
Weight	lb	5	8	8	23

Technical data

3-phase mains connection 400 V

Rated data



Inverter		i550-C18/400-3	i550-C22/400-3	i550-C30/400-3	i550-C37/400-3
Rated power	kW	18.5	22	30	37
Rated power	hp	25	30	40	50
Mains voltage range		3/PE AC 340 V ... 528 V, 45 Hz ... 65 Hz			
Output voltage		3 AC 0-400/480 V			
Rated mains current					
without mains choke	A	48.4	-	-	-
with mains choke	A	36	42	54.9	68
Apparent output power	kVA	27	32	41	51
Rated output current					
2 kHz	A	40	47	61	76
4 kHz	A	40	47	61	76
8 kHz	A	40	47	61	76
16 kHz	A	26.6	31.3	40.6	50.6
Power loss					
2 kHz	W	420	491	639	790
4 kHz	W	450	520	680	840
8 kHz	W	570	670	880	1100
16 kHz	W	581	680	884	1095
when the controller is inhibited	W	18	18	25	25
Overcurrent cycle 180 s					
Max. output current	A	60	71	92	114
Overload time	s	60	60	60	60
Recovery time	s	120	120	120	120
Max. output current during the recovery time	A	30	35	46	57
Overcurrent cycle 15 s					
Max. output current	A	80	94	122	152
Overload time	s	3	3	3	3
Recovery time	s	12	12	12	12
Max. output current during the recovery time	A	30	35	46	57
Cyclic mains switching		3 times per minute			
Brake chopper					
Max. output current	A	52	52	104	104
Min. brake resistance	Ω	15	15	7.5	7.5
Max. shielded motor cable length					
without EMC category	m	100	100	100	100
Category C1 (2 kHz, 4 kHz, 8 kHz)	m	-	-	-	-
Category C2 (2 kHz, 4 kHz, 8 kHz)	m	20	20	20	20
Category C3 (2 kHz, 4 kHz, 8 kHz)	m	35	35	35	35
Weight	kg	10.3	10.3	17.2	17.2
Weight	lb	23	23	38	38



Technical data

3-phase mains connection 400 V
Rated data

Inverter		i550-C45/400-3	i550-C55/400-3	i550-C75/400-3	i550-C90/400-3
Rated power	kW	45	55	75	90
Rated power	hp	60	75	100	125
Mains voltage range		3/PE AC 340 V ... 528 V, 45 Hz ... 65 Hz			
Output voltage		3 AC 0-400/480 V			
Rated mains current					
without mains choke	A	-	-	-	-
with mains choke	A	80	99	135	168
Apparent output power	kVA	60	75	100	121
Rated output current					
2 kHz	A	89	110	150	180
4 kHz	A	89	110	150	180
8 kHz	A	89	110	150	162
16 kHz	A	59.3	73.3	100	108
Power loss					
2 kHz	W	920	1137	1539	1841
4 kHz	W	980	1210	1640	1961
8 kHz	W	1280	1580	2140	2312
16 kHz	W	1278	1579	2143	2312
when the controller is inhibited	W	25	30	30	30
Overcurrent cycle 180 s					
Max. output current	A	134	165	225	270
Overload time	s	60	60	60	60
Recovery time	s	120	120	120	120
Max. output current during the recovery time	A	67	83	113	135
Overcurrent cycle 15 s					
Max. output current	A	178	220	300	360
Overload time	s	3	3	3	3
Recovery time	s	12	12	12	12
Max. output current during the recovery time	A	67	83	113	135
Cyclic mains switching		3 times per minute	Once per minute		
Brake chopper					
Max. output current	A	104	166	166	275
Min. brake resistance	Ω	7.5	4.7	4.7	2.4
Max. shielded motor cable length					
without EMC category	m	100	200	200	200
Category C1 (2 kHz, 4 kHz, 8 kHz)	m	-	-	-	-
Category C2 (2 kHz, 4 kHz, 8 kHz)	m	20	20	20	20
Category C3 (2 kHz, 4 kHz, 8 kHz)	m	35	100	100	100
Weight	kg	17.2	24	24	35.6
Weight	lb	38	53	53	78.5

Technical data

3-phase mains connection 400 V

Rated data



Inverter		i550-C110/400-3
Rated power	kW	110
Rated power	hp	150
Mains voltage range		3/PE AC 340 V ... 528 V, 45 Hz ... 65 Hz
Output voltage		3 AC 0-400/480 V
Rated mains current		
without mains choke	A	-
with mains choke	A	198
Apparent output power	kVA	142
Rated output current		
2 kHz	A	212
4 kHz	A	212
8 kHz	A	191
16 kHz	A	127
Power loss		
2 kHz	W	2163
4 kHz	W	2305
8 kHz	W	2717
16 kHz	W	2717
when the controller is inhibited	W	30
Overcurrent cycle 180 s		
Max. output current	A	318
Overload time	s	60
Recovery time	s	120
Max. output current during the recovery time	A	159
Overcurrent cycle 15 s		
Max. output current	A	424
Overload time	s	3
Recovery time	s	12
Max. output current during the recovery time	A	159
Cyclic mains switching		Once per minute
Brake chopper		
Max. output current	A	275
Min. brake resistance	Ω	2.4
Max. shielded motor cable length		
without EMC category	m	200
Category C1 (2 kHz, 4 kHz, 8 kHz)	m	-
Category C2 (2 kHz, 4 kHz, 8 kHz)	m	20
Category C3 (2 kHz, 4 kHz, 8 kHz)	m	100
Weight	kg	35.6
Weight	lb	78.5



Fusing data



A residual current device (RCD) is optional.

EN 60204-1

Inverter	Fuse		Circuit breaker		RCD
	Characteristic	Max. rated current	Characteristic	Max. rated current	
		A		A	
i550-C0.37/400-3	gG/gL or gRL	10	B	10	≥ 30 mA, type B
i550-C0.55/400-3	gG/gL or gRL	10	B	10	≥ 30 mA, type B
i550-C0.75/400-3	gG/gL or gRL	10	B	10	≥ 30 mA, type B
i550-C1.1/400-3	gG/gL or gRL	16	B	16	≥ 30 mA, type B
i550-C1.5/400-3	gG/gL or gRL	16	B	16	≥ 30 mA, type B
i550-C2.2/400-3	gG/gL or gRL	16	B	16	≥ 30 mA, type B
i550-C3.0/400-3	gG/gL or gRL	25	B	25	≥ 30 mA, type B
i550-C4.0/400-3	gG/gL or gRL	25	B	25	≥ 30 mA, type B
i550-C5.5/400-3	gG/gL or gRL	25	B	25	≥ 300 mA, type B
i550-C7.5/400-3	gG/gL or gRL	32	B	32	≥ 300 mA, type B
i550-C11/400-3	gG/gL or gRL	32	B	32	≥ 300 mA, type B
i550-C15/400-3	gG/gL or gRL	63	B	63	≥ 300 mA, type B
i550-C18/400-3	gG/gL or gRL	63	B	63	≥ 300 mA, type B
i550-C22/400-3	gG/gL or gRL	63	B	63	≥ 300 mA, type B
i550-C30/400-3	gG/gL or gRL	80	B	80	≥ 300 mA, type B
i550-C37/400-3	gG/gL or gRL	100	B	100	≥ 300 mA, type B
i550-C45/400-3	gG/gL or gRL	125	B	125	≥ 300 mA, type B
i550-C55/400-3	gR	160	-	-	≥ 300 mA, type B
i550-C75/400-3	gR	160	-	-	≥ 300 mA, type B
i550-C90/400-3	gR	300	-	-	≥ 300 mA, type B
i550-C110/400-3	gR	300	-	-	≥ 300 mA, type B

The connection data according to UL can be found under: [▶ Connection according to UL 50](#)



Please note that from 22 kW onwards a mains choke must always be used.

Technical data

3-phase mains connection 400 V
Terminal data



Terminal data

		i550-Cxxxx/400-3				
Inverter	kW	0.37 ... 2.2	3.0 ... 4.0	5.5	7.5 ... 11	15 ... 22
Connection		Mains connection X100				
Connection type		Pluggable screw terminal		Screw terminal		
Max. Cable cross-section	mm ²	2.5	4	6	16	35
Stripping length	mm	8	8	9	11	18
Tightening torque	Nm	0.5	0.6	0.5	1.2	3.8
Required tool		0.5 x 3.0		0.6 x 3.5	0.8 x 4.0	0.8 x 5.5

		i550-Cxxxx/400-3				
Inverter	kW	30 ... 45	55 ... 75	90 ... 110	0.37 ... 5.5	3.0 ... 4.0
Connection		Mains connection X100			PE connection	
Connection type		Screw terminal			PE screw	
Max. Cable cross-section	mm ²	50	95	150	6	6
Stripping length	mm	19	22	28	10	10
Tightening torque	Nm	4	10	18	2	2
Required tool		Hexagon socket 5	Hexagon socket 6	Hexagon socket 8	Torx 20	

		i550-Cxxxx/400-3				
Inverter	kW	7.5 ... 11	15 ... 75	90 ... 110	0.37 ... 2.2	3.0 ... 4.0
Connection		PE connection			Motor connection X105	
Connection type		PE screw		PE bolt	Pluggable screw terminal	
Max. Cable cross-section	mm ²	16	25	150	2.5	2.5
Stripping length	mm	11	16	-	8	8
Tightening torque	Nm	3.4	4	10	0.5	0.5
Required tool		PZ2		Width AF 13	0.5 x 3.0	

		i550-Cxxxx/400-3				
Inverter	kW	5.5	7.5 ... 11	15 ... 22	30 ... 45	55 ... 75
Connection		Motor connection X105				
Connection type		Screw terminal				
Max. Cable cross-section	mm ²	6	16	35	50	95
Stripping length	mm	9	11	18	19	22
Tightening torque	Nm	0.5	1.2	3.8	4	10
Required tool		0.6 x 3.5	0.8 x 4.0	0.8 x 5.5	Hexagon socket 5	Hexagon socket 6

		i550-Cxxxx/400-3				
Inverter	kW	90 ... 110				
Connection		Motor connection X105				
Connection type		Screw terminal				
Max. Cable cross-section	mm ²	150				
Stripping length	mm	28				
Tightening torque	Nm	18				
Required tool		Hexagon socket 8				

The terminal data for the terminal X1 can be found under: [Terminal data](#) 78



Technical data

3-phase mains connection 400 V
Brake resistors

Brake resistors

Inverter	Brake resistor					
	Order code	Rated resistance	Rated power	Thermal capacity	Dimensions (H x W x D)	Weight
		Ω	W	kWs	mm	kg
i550-C0.37/400-3	ERBM470R020W	470	20	3	160 x 40 x 36	0.34
i550-C0.37/400-3	ERBM390R100W	390	100	15	235 x 20.6 x 40	0.37
i550-C0.55/400-3	ERBM390R100W	390	100	15	235 x 20.6 x 40	0.37
i550-C0.75/400-3	ERBM390R100W	390	100	15	235 x 20.6 x 40	0.37
i550-C1.1/400-3	ERBP180R200W	180	200	30	240 x 42 x 122	1.0
i550-C1.1/400-3	ERBP180R300W	180	300	45	320 x 42 x 122	1.4
i550-C1.5/400-3	ERBP180R200W	180	200	30	240 x 42 x 122	1.0
i550-C1.5/400-3	ERBS180R350WNQN000	180	350	53	382 x 124 x 122	2.1
i550-C2.2/400-3	ERBP180R200W	180	200	30	240 x 42 x 122	1.0
i550-C2.2/400-3	ERBP180R300W	180	300	45	320 x 42 x 122	1.4
i550-C2.2/400-3	ERBS180R350WNQN000	180	350	53	382 x 124 x 122	2.1
i550-C3.0/400-3	ERBM082R150W	82	150	22.5	238 x 80 x 59	0.70
i550-C3.0/400-3	ERBP082R200W	82	200	30	240 x 42 x 122	1.0
i550-C3.0/400-3	ERBS082R780WNQN000	82	780	117	666 x 124 x 122	3.6
i550-C4.0/400-3	ERBM047R135W	47	135	6.3	216 x 80 x 28	0.67
i550-C4.0/400-3	ERBS047R400W	47	400	60	400 x 114 x 105	2.3
i550-C4.0/400-3	ERBS047R800W	47	800	120	710 x 114 x 105	4.0
i550-C5.5/400-3	ERBP047R200W	47	200	30	240 x 42 x 122	1.0
i550-C5.5/400-3	ERBS047R400W	47	400	60	400 x 114 x 105	2.3
i550-C5.5/400-3	ERBS047R800W	47	800	120	710 x 114 x 105	4.0
i550-C7.5/400-3	ERBP027R200W	27	200	30	240 x 42 x 122	1.0
i550-C7.5/400-3	ERBS027R600W	27	600	90	550 x 114 x 105	3.1
i550-C7.5/400-3	ERBS027R01K4	27	1400	210	1110 x 114 x 105	6.3
i550-C11/400-3	ERBS027R600W	27	600	90	550 x 114 x 105	3.1
i550-C11/400-3	ERBS027R01K2	27	1200	180	1020 x 114 x 105	5.6
i550-C11/400-3	ERBS027R01K4	27	1400	210	1110 x 114 x 105	6.3
i550-C15/400-3	ERBP018R300W	18	300	45	320 x 42 x 122	1.4
i550-C15/400-3	ERBS018R01K4	18	1400	210	1110 x 114 x 105	6.3
i550-C15/400-3	ERBG018R04K3	18	4300	645	302 x 486 x 426	13.5
i550-C18/400-3	ERBS015R800W	15	800	120	710 x 114 x 105	4.0
i550-C18/400-3	ERBS015R02K4	15	2400	360	1020 x 204 x 105	10
i550-C18/400-3	ERBG015R06K2	15	6200	930	302 x 486 x 526	17.0
i550-C22/400-3	ERBS015R800W	15	800	120	710 x 114 x 105	4.0
i550-C22/400-3	ERBS015R02K4	15	2400	360	1020 x 204 x 105	10
i550-C22/400-3	ERBG015R06K2	15	6200	930	302 x 486 x 526	17.0
i550-C30/400-3	ERBG075D01K9	7.50	1900	285	302 x 486 x 236	9.5
i550-C37/400-3	ERBG075D01K9	7.50	1900	285	302 x 486 x 236	9.5
i550-C45/400-3	ERBG075D01K9	7.50	1900	285	302 x 486 x 236	9.5
i550-C55/400-3	ERBG005R02K6	5	2600	390	302 x 486 x 326	11.0
i550-C75/400-3	ERBG005R02K6	5	2600	390	302 x 486 x 326	11.0
i550-C90/400-3	ERBG028D04K1	2.80	4100	615	302 x 486 x 426	12.8
i550-C110/400-3	ERBG028D04K1	2.80	4100	615	302 x 486 x 426	12.8

Technical data

3-phase mains connection 400 V
Mains chokes



Mains chokes

Inverter	Mains choke					
	Order code	No. of phases	Rated current	Inductance	Dimensions (h x w x d)	Weight
			A	mH	mm	kg
i550-C0.37/400-3	EZAELN3002B203	3	1.5	19.6	56 x 77 x 100	0.52
i550-C0.55/400-3	EZAELN3002B153		2	14.7		0.53
i550-C0.75/400-3	EZAELN3004B742		4	7.35	60 x 95 x 115	1.31
i550-C1.1/400-3						
i550-C1.5/400-3						
i550-C2.2/400-3	EZAELN3006B492		6	4.9	69 x 95 x 120	1.45
i550-C3.0/400-3	EZAELN3008B372		8	3.68	85 x 120 x 140	1.9
i550-C4.0/400-3	EZAELN3010B292		10	2.94		2
i550-C5.5/400-3	EZAELN3016B182		16	1.84	95 x 120 x 140	2.7
i550-C7.5/400-3						
i550-C11/400-3	EZAELN3025B122		25	1.18	110 x 155 x 170	5.8
i550-C15/400-3	EZAELN3030B981		30	0.98		5.85
i550-C18/400-3	EZAELN3040B741		40	0.74	112 x 185 x 200	6.8
i550-C22/400-3	EZAELN3045B651		45	0.65		8.25
i550-C30/400-3	EZAELN3063B471		63	0.47	122 x 185 x 210	9.65
i550-C37/400-3	EZAELN3080B371		80	0.37	125 x 210 x 240	12.5
i550-C45/400-3						
i550-C55/400-3	EZAELN3100B301		100	0.3	139 x 267 x 205	16.5
i550-C75/400-3	EZAELN3160B191		160	0.19	149 x 291 x 215	22.5
i550-C90/400-3	EZAELN3180B171		180	0.17	164 x 316 x 235	26
i550-C110/400-3	EZAELN3200B151	200	0.15	144 x 352 x 265	25	



RFI filters / Mains filters

Basic information on RFI filters, mains filters and EMC: from [193](#)



EMC filters can be used both in the side structure and in the substructure.

Maximum motor cable lengths with residual current device (RCD)

Mains connection			3-phase, 400 V/480 V			
Inverter			i550-C0.37/400-3	i550-C0.55/400-3 i550-C0.75/400-3	i550-C1.1/400-3 i550-C1.5/400-3 i550-C2.2/400-3 i550-C3.0/400-3 i550-C4.0/400-3	i550-C5.5/400-3
Without RFI filter						
Without EMC category Thermal limitation	Max. Shielded motor cable length	m	15	50	50	100
	Max. Unshielded motor cable length	m	30	100	200	200
With integrated RFI filter						
Category C1	Max. Shielded motor cable length	m	3	3	-	-
Category C2		m	15	20	20	20
	RCD (optional)	mA	30	30	30	300
RFI filter Low Leakage						
Category C1	Max. Shielded motor cable length	m	-	-	-	-
	RCD (optional)	mA	-	-	-	-
RFI filter Short Distance						
Category C1	Max. Shielded motor cable length	m	15	25	25	25
Category C2		m	15	50	50	50
	RCD (optional)	mA	30	30	30	30
RFI filter Long Distance						
Category C1	Max. Shielded motor cable length	m	15	50	50	50
Category C2		m	15	50	50	100
	RCD (optional)	mA	300	300	300	300

Technical data

3-phase mains connection 400 V
RFI filters / Mains filters



Mains connection			3-phase, 400 V/480 V			
Inverter			i550-C7.5/400-3 i550-C11/400-3	i550-C15/400-3 i550-C18/400-3 i550-C22/400-3	i550-C30/400-3 i550-C37/400-3 i550-C45/400-3	i550-C55/400-3 i550-C75/400-3 i550-C90/400-3 i550-C110/400-3
Without RFI filter						
Without EMC category Thermal limitation	Max. Shielded motor cable length	m	100	100	100	100
	Max. Unshielded motor cable length	m	200	200	200	200
With integrated RFI filter						
Category C1	Max. Shielded motor cable length	m	-	-	-	-
Category C2		m	20	20	20	20
	RCD (optional)	mA	300	300	300	300
RFI filter Low Leakage						
Category C1	Max. Shielded motor cable length	m	-	-	-	-
	RCD (optional)	mA	-	-	-	-
RFI filter Short Distance						
Category C1	Max. Shielded motor cable length	m	25	-	-	-
Category C2		m	50	-	-	-
	RCD (optional)	mA	30	-	-	-
RFI filter Long Distance						
Category C1	Max. Shielded motor cable length	m	50	50	50	50
Category C2	Max. Shielded motor cable length	m	100	100	100	100
	RCD (optional)	mA	300	300	300	300

Short Distance

Inverter	Filters			
	Order code	Rated current	Dimensions (h x w x d)	Weight
		A	mm	kg
i550-C0.37/400-3	I0FAE175F100S0000S	3.3	276 x 60 x 50	0.9
i550-C0.55/400-3				
i550-C0.75/400-3				
i550-C1.1/400-3	I0FAE222F100S0000S	7.8	346 x 60 x 50	1.1
i550-C1.5/400-3				
i550-C2.2/400-3				
i550-C3.0/400-3	I0FAE255F100S0001S	18.3	346 x 90 x 60	2.1
i550-C4.0/400-3				
i550-C5.5/400-3				
i550-C7.5/400-3	I0FAE311F100S0000S	29	371 x 120 x 60	2.4
i550-C11/400-3				



Technical data

3-phase mains connection 400 V
Sine filter

Long Distance

Inverter	Filters			
	Order code	Rated current	Dimensions (h x w x d)	Weight
		A	mm	kg
i550-C0.37/400-3	I0FAE175F100D0000S	3.3	276 x 60 x 50	0.9
i550-C0.55/400-3				
i550-C0.75/400-3				
i550-C1.1/400-3	I0FAE222F100D0000S	7.8	346 x 60 x 50	1.1
i550-C1.5/400-3				
i550-C2.2/400-3				
i550-C3.0/400-3	I0FAE240F100D0000S	12.5		1.35
i550-C4.0/400-3				
i550-C5.5/400-3	I0FAE255F100D0001S	18.3	346 x 90 x 60	1.7
i550-C7.5/400-3	I0FAE311F100D0000S	29	371 x 120 x 60	2.1
i550-C11/400-3				
i550-C15/400-3	I0FAE318F100D0000S	50.4	436 x 205 x 90	7.1
i550-C18/400-3				
i550-C22/400-3				
i550-C22/400-3	I0FAE322F100D0000S	43		18.5
i550-C30/400-3	I0FAE330F100D0000S	55		23
i550-C37/400-3	I0FAE337F100D0000S	69	590 x 250 x 105	25
i550-C45/400-3	I0FAE345F100D0001S	100		32
i550-C55/400-3	I0FAE355F100D0001S	120	700 x 250 x 105	36
i550-C75/400-3	I0FAE375F100D0001S	162		41.5
i550-C90/400-3	I0FAE411F100D0001S	240		855 x 250 x 130
i550-C110/400-3				

From i550-C22/400-3, long distance mains filters are used. Mains filters are a combination of mains choke and RFI filter.

Sine filter

Inverter	Sine filters			
	Switching frequency	Order code	Rated inductance	Max. output frequency
	kHz		mH	Hz
i550-C0.37/400-3	4 8	EZS3-004A200	11.0	150
i550-C0.55/400-3				
i550-C0.75/400-3				
i550-C1.1/400-3		EZS3-010A200	5.10	
i550-C1.5/400-3				
i550-C2.2/400-3				
i550-C3.0/400-3		EZS3-017A200	3.07	
i550-C4.0/400-3				
i550-C5.5/400-3				
i550-C7.5/400-3		EZS3-024A200	2.50	
i550-C11/400-3		EZS3-032A200	2.00	
i550-C15/400-3		EZS3-037A200	1.70	
i550-C18/400-3		EZS3-048A200	1.20	
i550-C22/400-3		EZS3-048A200	1.20	
i550-C30/400-3		EZS3-061A200	1.00	
i550-C37/400-3		EZS3-090A200	0.8	
i550-C45/400-3	EZS3-090A200	0.8		
i550-C55/400-3	2	EZS3-115A200	0.7	
i550-C75/400-3	4	EZS3-150A200	0.5	

Technical data

3-phase mains connection 400 V "Light Duty"

Rated data



3-phase mains connection 400 V "Light Duty"

Rated data

The output currents apply to these operating conditions:

- At a switching frequency of 2 kHz or 4 kHz: Ambient temperature above 40 °C with a rated output current reduced by 2.5 %/°C.
- If the load characteristic "Light Duty" and the switching frequencies 8 kHz or 16 kHz are selected, only the values of the load characteristic "Heavy Duty" are reached.

Inverter		i550-C3.0/400-3	i550-C4.0/400-3	i550-C5.5/400-3	i550-C7.5/400-3
Rated power	kW	4	5.5	7.5	11
Rated power	hp	5	7.5	10	15
Mains voltage range		3/PE AC 340 V ... 528 V, 45 Hz ... 65 Hz			
Output voltage		3 AC 0-400/480 V			
Rated mains current					
without mains choke	A	10.3	14	18.3	28
with mains choke	A	8.2	11	14.5	22
Apparent output power	kVA	5.9	8	10.5	15
Rated output current					
2 kHz	A	8.8	11.9	15.6	23
4 kHz	A	8.8	11.9	15.6	23
8 kHz	A	-	-	-	-
16 kHz	A	-	-	-	-
Power loss					
2 kHz	W	94	125	163	238
4 kHz	W	100	133	173	253
8 kHz	W	-	-	-	-
16 kHz	W	-	-	-	-
when the controller is inhibited	W	6	6	6	6
Overcurrent cycle 180 s					
Max. output current	A	11	14.3	19.5	23.6
Overload time	s	60	60	60	60
Recovery time	s	120	120	120	120
Max. output current during the recovery time	A	5.5	7.1	9.8	12.4
Overcurrent cycle 15 s					
Max. output current	A	14.6	19	26	33
Overload time	s	3	3	3	3
Recovery time	s	12	12	12	12
Max. output current during the recovery time	A	5.5	7.1	9.8	12.4
Cyclic mains switching		3 times per minute			
Brake chopper					
Max. output current	A	9.5	16.6	16.6	29
Min. brake resistance	Ω	82	47	47	27
Max. shielded motor cable length					
without EMC category	m	50	50	100	100
Category C1 (2 kHz, 4 kHz, 8 kHz)	m	-	-	-	-
Category C2 (2 kHz, 4 kHz, 8 kHz)	m	20	20	20	20
Category C3 (2 kHz, 4 kHz, 8 kHz)	m	35	35	35	50
Weight	kg	1.35	1.35	2.3	3.7
Weight	lb	3	3	5	8



Technical data

3-phase mains connection 400 V "Light Duty"
Rated data

Inverter		i550-C11/400-3	i550-C15/400-3	i550-C18/400-3	i550-C22/400-3
Rated power	kW	15	18.5	22	30
Rated power	hp	20	25	30	40
Mains voltage range		3/PE AC 340 V ... 528 V, 45 Hz ... 65 Hz			
Output voltage		3 AC 0-400/480 V			
Rated mains current					
without mains choke	A	-	48	-	-
with mains choke	A	27.1	36	43	55
Apparent output power	kVA	19	26	32	38
Rated output current					
2 kHz	A	28.2	38.4	48	56.4
4 kHz	A	28.2	38.4	48	56.4
8 kHz	A	-	-	-	-
16 kHz	A	-	-	-	-
Power loss					
2 kHz	W	290	404	501	585
4 kHz	W	309	430	533	623
8 kHz	W	-	-	-	-
16 kHz	W	-	-	-	-
when the controller is inhibited	W	6	18	18	18
Overcurrent cycle 180 s					
Max. output current	A	35	48	60	71
Overload time	s	60	60	60	60
Recovery time	s	120	120	120	120
Max. output current during the recovery time	A	17.6	24	30	35
Overcurrent cycle 15 s					
Max. output current	A	47	64	80	94
Overload time	s	3	3	3	3
Recovery time	s	12	12	12	12
Max. output current during the recovery time	A	17.6	24	30	35
Cyclic mains switching		3 times per minute			
Brake chopper					
Max. output current	A	29	43	52	52
Min. brake resistance	Ω	27	18	15	15
Max. shielded motor cable length					
without EMC category	m	100	100	100	100
Category C1 (2 kHz, 4 kHz, 8 kHz)	m	-	-	-	-
Category C2 (2 kHz, 4 kHz, 8 kHz)	m	20	20	20	20
Category C3 (2 kHz, 4 kHz, 8 kHz)	m	50	35	35	35
Weight	kg	3.7	10.3	10.3	10.3
Weight	lb	8	23	23	23

Technical data

3-phase mains connection 400 V "Light Duty"
Rated data



Inverter		i550-C30/400-3	i550-C37/400-3	i550-C45/400-3	i550-C55/400-3
Rated power	kW	37	45	55	75
Rated power	hp	50	60	75	100
Mains voltage range		3/PE AC 340 V ... 528 V, 45 Hz ... 65 Hz			
Output voltage		3 AC 0-400/480 V			
Rated mains current					
without mains choke	A	-	-	-	-
with mains choke	A	69	86	100	119
Apparent output power	kVA	49	61	72	89
Rated output current					
2 kHz	A	73.2	91.2	107	132
4 kHz	A	73.2	91.2	107	132
8 kHz	A	-	-	-	-
16 kHz	A	-	-	-	-
Power loss					
2 kHz	W	761	942	1101	1358
4 kHz	W	810	1004	1171	1446
8 kHz	W	-	-	-	-
16 kHz	W	-	-	-	-
when the controller is inhibited	W	25	25	25	30
Overcurrent cycle 180 s					
Max. output current	A	92	114	134	165
Overload time	s	60	60	60	60
Recovery time	s	120	120	120	120
Max. output current during the recovery time	A	46	57	67	83
Overcurrent cycle 15 s					
Max. output current	A	122	152	178	220
Overload time	s	3	3	3	3
Recovery time	s	12	12	12	12
Max. output current during the recovery time	A	46	57	67	83
Cyclic mains switching		3 times per minute			Once per minute
Brake chopper					
Max. output current	A	104	104	104	166
Min. brake resistance	Ω	7.5	7.5	7.5	4.7
Max. shielded motor cable length					
without EMC category	m	100	100	100	200
Category C1 (2 kHz, 4 kHz, 8 kHz)	m	-	-	-	-
Category C2 (2 kHz, 4 kHz, 8 kHz)	m	20	20	20	20
Category C3 (2 kHz, 4 kHz, 8 kHz)	m	35	35	35	100
Weight	kg	17.2	17.2	17.2	24
Weight	lb	38	38	38	53



Technical data

3-phase mains connection 400 V "Light Duty"
Rated data

Inverter		i550-C75/400-3	i550-C90/400-3	i550-C110/400-3
Rated power	kW	90	110	132
Rated power	hp	125	150	175
Mains voltage range		3/PE AC 340 V ... 528 V, 45 Hz ... 65 Hz		
Output voltage		3 AC 0-400/480 V		
Rated mains current				
without mains choke	A	-	-	-
with mains choke	A	160	200	234
Apparent output power	kVA	121	145	171
Rated output current				
2 kHz	A	180	216	254
4 kHz	A	180	216	254
8 kHz	A	-	-	-
16 kHz	A	-	-	-
Power loss				
2 kHz	W	1841	2203	2589
4 kHz	W	1961	2348	2760
8 kHz	W	-	-	-
16 kHz	W	-	-	-
when the controller is inhibited	W	30	30	30
Overcurrent cycle 180 s				
Max. output current	A	225	270	318
Overload time	s	60	60	60
Recovery time	s	120	120	120
Max. output current during the recovery time	A	113	135	159
Overcurrent cycle 15 s				
Max. output current	A	300	360	424
Overload time	s	3	3	3
Recovery time	s	12	12	12
Max. output current during the recovery time	A	113	135	159
Cyclic mains switching		Once per minute		
Brake chopper				
Max. output current	A	166	275	275
Min. brake resistance	Ω	4.7	2.4	2.4
Max. shielded motor cable length				
without EMC category	m	200	200	200
Category C1 (2 kHz, 4 kHz, 8 kHz)	m	-	-	-
Category C2 (2 kHz, 4 kHz, 8 kHz)	m	20	20	20
Category C3 (2 kHz, 4 kHz, 8 kHz)	m	100	100	100
Weight	kg	24	35.6	35.6
Weight	lb	53	78.5	78.5

Technical data

3-phase mains connection 400 V "Light Duty"
Fusing data



Fusing data



A residual current device (RCD) is optional.

EN 60204-1

Inverter	Fuse		Circuit breaker		RCD
	Characteristic	Max. rated current	Characteristic	Max. rated current	
		A		A	
i550-C3.0/400-3	gG/gL or gRL	25	B	25	≥ 30 mA, type B
i550-C4.0/400-3	gG/gL or gRL	25	B	25	≥ 30 mA, type B
i550-C5.5/400-3	gG/gL or gRL	25	B	25	≥ 300 mA, type B
i550-C7.5/400-3	gG/gL or gRL	32	B	32	≥ 300 mA, type B
i550-C11/400-3	gG/gL or gRL	32	B	32	≥ 300 mA, type B
i550-C15/400-3	gG/gL or gRL	63	B	63	≥ 300 mA, type B
i550-C18/400-3	gG/gL or gRL	63	B	63	≥ 300 mA, type B
i550-C22/400-3	gG/gL or gRL	63	B	63	≥ 300 mA, type B
i550-C30/400-3	gG/gL or gRL	80	B	80	≥ 300 mA, type B
i550-C37/400-3	gG/gL or gRL	100	B	100	≥ 300 mA, type B
i550-C45/400-3	gG/gL or gRL	125	B	125	≥ 300 mA, type B
i550-C55/400-3	gR	160	-	-	≥ 300 mA, type B
i550-C75/400-3	gR	160	-	-	≥ 300 mA, type B
i550-C90/400-3	gR	300	-	-	≥ 300 mA, type B
i550-C110/400-3	gR	300	-	-	≥ 300 mA, type B

The connection data according to UL can be found under: [▶ Connection according to UL](#)  50



Please note that from 15 kW onwards a mains choke must always be used.



Technical data

3-phase mains connection 400 V "Light Duty"

Terminal data

Terminal data

		i550-Cxxxx/400-3				
Inverter	kW	4.0 ... 5.5	7.5	11 ... 15	18.5 ... 30	37 ... 55
Connection		Mains connection X100				
Connection type		Pluggable screw terminal	Screw terminal			
Max. Cable cross-section	mm ²	4	6	16	35	50
Stripping length	mm	8	9	11	18	19
Tightening torque	Nm	0.6	0.5	1.2	3.8	4
Required tool		0.5 x 3.0	0.6 x 3.5	0.8 x 4.0	0.8 x 5.5	Hexagon socket 5

		i550-Cxxxx/400-3				
Inverter	kW	75 ... 90	110 ... 132	4.0 ... 5.5	7.5	11 ... 15
Connection		Mains connection X100		PE connection		
Connection type		Screw terminal		PE screw		
Max. Cable cross-section	mm ²	95	150	6	6	16
Stripping length	mm	22	28	10	10	11
Tightening torque	Nm	10	18	2	2	3.4
Required tool		Hexagon socket 6	Hexagon socket 8	Torx 20		P22

		i550-Cxxxx/400-3				
Inverter	kW	18.5 ... 90	110 ... 132	4.0 ... 5.5	7.5	11 ... 15
Connection		PE connection		Motor connection X105		
Connection type		PE screw	PE bolt	Pluggable screw terminal	Screw terminal	
Max. Cable cross-section	mm ²	25	150	2.5	6	16
Stripping length	mm	16	-	8	9	11
Tightening torque	Nm	4	10	0.5	0.5	1.2
Required tool		P22	Width AF 13	0.5 x 3.0	0.6 x 3.5	0.8 x 4.0

		i550-Cxxxx/400-3			
Inverter	kW	18.5 ... 30	37 ... 55	75 ... 90	110 ... 132
Connection		Motor connection X105			
Connection type		Screw terminal			
Max. Cable cross-section	mm ²	35	50	95	150
Stripping length	mm	18	19	22	28
Tightening torque	Nm	3.8	4	10	18
Required tool		0.8 x 5.5	Hexagon socket 5	Hexagon socket 6	Hexagon socket 8

The terminal data for the terminal X1 can be found under: [Terminal data](#) 78

Technical data

3-phase mains connection 400 V "Light Duty"
 Brake resistors



Brake resistors

Inverter	Brake resistor					
	Order code	Rated resistance	Rated power	Thermal capacity	Dimensions (H x W x D)	Weight
		Ω	W	kWs	mm	kg
i550-C3.0/400-3	ERBM082R150W	82	150	22.5	238 x 80 x 59	0.70
i550-C3.0/400-3	ERBP082R200W	82	200	30	240 x 42 x 122	1.0
i550-C3.0/400-3	ERBS082R780WNQN000	82	780	117	666 x 124 x 122	3.6
i550-C4.0/400-3	ERBM047R135W	47	135	6.3	216 x 80 x 28	0.67
i550-C4.0/400-3	ERBS047R400W	47	400	60	400 x 114 x 105	2.3
i550-C4.0/400-3	ERBS047R800W	47	800	120	710 x 114 x 105	4.0
i550-C5.5/400-3	ERBP047R200W	47	200	30	240 x 42 x 122	1.0
i550-C5.5/400-3	ERBS047R400W	47	400	60	400 x 114 x 105	2.3
i550-C5.5/400-3	ERBS047R800W	47	800	120	710 x 114 x 105	4.0
i550-C7.5/400-3	ERBP027R200W	27	200	30	240 x 42 x 122	1.0
i550-C7.5/400-3	ERBS027R600W	27	600	90	550 x 114 x 105	3.1
i550-C7.5/400-3	ERBS027R01K4	27	1400	210	1110 x 114 x 105	6.3
i550-C11/400-3	ERBS027R600W	27	600	90	550 x 114 x 105	3.1
i550-C11/400-3	ERBS027R01K2	27	1200	180	1020 x 114 x 105	5.6
i550-C11/400-3	ERBS027R01K4	27	1400	210	1110 x 114 x 105	6.3
i550-C15/400-3	ERBP018R300W	18	300	45	320 x 42 x 122	1.4
i550-C15/400-3	ERBS018R01K4	18	1400	210	1110 x 114 x 105	6.3
i550-C15/400-3	ERBG018R04K3	18	4300	645	302 x 486 x 426	13.5
i550-C18/400-3	ERBS015R800W	15	800	120	710 x 114 x 105	4.0
i550-C18/400-3	ERBS015R02K4	15	2400	360	1020 x 204 x 105	10
i550-C18/400-3	ERBG015R06K2	15	6200	930	302 x 486 x 526	17.0
i550-C22/400-3	ERBS015R800W	15	800	120	710 x 114 x 105	4.0
i550-C22/400-3	ERBS015R02K4	15	2400	360	1020 x 204 x 105	10
i550-C22/400-3	ERBG015R06K2	15	6200	930	302 x 486 x 526	17.0
i550-C30/400-3	ERBG075D01K9	7.50	1900	285	302 x 486 x 236	9.5
i550-C37/400-3	ERBG075D01K9	7.50	1900	285	302 x 486 x 236	9.5
i550-C45/400-3	ERBG075D01K9	7.50	1900	285	302 x 486 x 236	9.5
i550-C55/400-3	ERBG005R02K6	5	2600	390	302 x 486 x 326	11.0
i550-C75/400-3	ERBG005R02K6	5	2600	390	302 x 486 x 326	11.0
i550-C90/400-3	ERBG028D04K1	2.80	4100	615	302 x 486 x 426	12.8
i550-C110/400-3	ERBG028D04K1	2.80	4100	615	302 x 486 x 426	12.8



Technical data

3-phase mains connection 400 V "Light Duty"
Mains chokes

Mains chokes

Inverter	Mains choke					
	Order code	No. of phases	Rated current	Inductance	Dimensions (h x w x d)	Weight
			A	mH	mm	kg
i550-C3.0/400-3	EZAELN3010B292	3	10	2.94	85 x 120 x 140	2
i550-C4.0/400-3	EZAELN3016B182		16	1.84	95 x 120 x 140	2.7
i550-C5.5/400-3						
i550-C7.5/400-3	EZAELN3025B122		25	1.18	110 x 155 x 170	5.8
i550-C11/400-3	EZAELN3030B981		30	0.98		5.85
i550-C15/400-3	EZAELN3040B741		40	0.74	112 x 185 x 200	6.8
i550-C18/400-3	EZAELN3045B651		45	0.65		8.25
i550-C22/400-3	EZAELN3063B471		63	0.47	122 x 185 x 210	9.65
i550-C30/400-3	EZAELN3080B371		80	0.37	125 x 210 x 240	12.5
i550-C37/400-3	EZAELN3090B331		90	0.33	115 x 267 x 205	11.5
i550-C45/400-3	EZAELN3100B301		100	0.3	139 x 267 x 205	16.5
i550-C55/400-3	EZAELN3125B241		125	0.24	139 x 291 x 215	17.5
i550-C75/400-3	EZAELN3160B191		160	0.19	149 x 291 x 215	22.5
i550-C90/400-3	EZAELN3200B151		200	0.15	144 x 352 x 265	25
i550-C110/400-3	EZAELN3250B121		250	0.12	207 x 352 x 260	31

Technical data

3-phase mains connection 400 V "Light Duty"
RFI filters / Mains filters



RFI filters / Mains filters

Basic information on RFI filters, mains filters and EMC: from [193](#)



EMC filters can be used both in the side structure and in the substructure.

Maximum motor cable lengths with residual current device (RCD)

Mains connection			3-phase, 400 V/480 V, Light Duty				
Inverter			i550-C3.0/400-3	i550-C5.5/400-3	i550-C7.5/400-3	i550-C15/400-3	i550-C30/400-3
			i550-C4.0/400-3		i550-C11/400-3		
						i550-C22/400-3	i550-C45/400-3
							i550-C55/400-3
							i550-C75/400-3
							i550-C90/400-3
							i550-C110/400-3
Without RFI filter							
Without EMC category Thermal limitation	Max. motor cable length shielded	m	50	100	100	100	100
	Max. motor cable length unshielded	m	200	200	200	200	200
With integrated RFI filter							
Category C1	Max. motor cable length shielded	m	-	-	-	-	-
Category C2		m	20	20	20	20	20
	RCD (optional)	mA	30	300	300	300	300
RFI filter Low Leakage							
Category C1	Max. motor cable length shielded	m	-	-	-	-	-
	RCD (optional)	mA	-	-	-	-	-
RFI filter Short Distance							
Category C1	Max. motor cable length shielded	m	25	25	25	-	-
Category C2		m	50	50	50	-	-
	RCD (optional)	mA	30	30	30	-	-
RFI filter Long Distance							
Category C1	Max. motor cable length shielded	m	50	50	50	-	-
Category C2		m	100	100	100	-	-
	RCD (optional)	mA	300	300	300	-	-

Short Distance

Inverter	Filters			
	Order code	Rated current	Dimensions (h x w x d)	Weight
		A	mm	kg
i550-C3.0/400-3	IOFAE255F100S0001S	18.3	346 x 90 x 60	2.1
i550-C4.0/400-3				
i550-C5.5/400-3				
i550-C7.5/400-3	IOFAE311F100S0000S	29	371 x 120 x 60	2.4
i550-C11/400-3				



Technical data

3-phase mains connection 400 V "Light Duty"
Sine filter

Long Distance

Inverter	Filters			
	Order code	Rated current	Dimensions (h x w x d)	Weight
		A	mm	kg
i550-C3.0/400-3	I0FAE240F100D0000S	12.5	346 x 60 x 50	1.35
i550-C4.0/400-3	I0FAE255F100D0001S	18.3	346 x 90 x 60	1.7
i550-C5.5/400-3				
i550-C7.5/400-3	I0FAE311F100D0000S	29	371 x 120 x 60	2.1
i550-C11/400-3				
i550-C15/400-3	I0FAE318F100D0000S	50.4	436 x 205 x 90	7.1
i550-C18/400-3	I0FAE322F100D0000S	43		18.5
i550-C22/400-3	I0FAE322F100D0001S	55		
i550-C30/400-3	I0FAE337F100D0000S	69	590 x 250 x 105	25
i550-C37/400-3				
i550-C45/400-3	I0FAE345F100D0001S	100	700 x 250 x 105	32
i550-C55/400-3	I0FAE355F100D0001S	120		36
i550-C75/400-3	I0FAE375F100D0001S	162		41.5
i550-C90/400-3	I0FAE411F100D0001S	240	855 x 250 x 130	63
i550-C110/400-3				

From i550-C18/400-3, long distance mains filters are used. Mains filters are a combination of mains choke and RFI filter.

Sine filter

Inverter	Sine filter				
	Switching frequency	Order code	Rated inductance	Max. output frequency	
	kHz		mH	Hz	
i550-C3.0/400-3	4	EZS3-010A200	5.10	150	
i550-C4.0/400-3		EZS3-017A200	3.07		
i550-C5.5/400-3		EZS3-024A200	2.50		
i550-C7.5/400-3					
i550-C11/400-3		EZS3-032A200	2.00		
i550-C15/400-3		EZS3-048A200	1.20		
i550-C18/400-3		EZS3-048A200	1.20		
i550-C22/400-3		EZS3-061A200	1.00		
i550-C30/400-3		EZS3-090A200	0.8		
i550-C37/400-3		EZS3-090A200	0.8		
i550-C45/400-3		EZS3-115A200	0.7		
i550-C55/400-3		EZS3-150A200	0.5		
i550-C75/400-3		EZS3-180A200	0.4		90

Technical data

3-phase mains connection 480 V

Rated data



3-phase mains connection 480 V

Rated data

The output currents apply to these operating conditions:

- At a switching frequency of 2 kHz or 4 kHz: Max. ambient temperature 45°C.
- At a switching frequency of 8 kHz or 16 kHz: Max. ambient temperature 40 °C.

Inverter		i550-C0.37/400-3	i550-C0.55/400-3	i550-C0.75/400-3	i550-C1.1/400-3
Rated power	kW	0.37	0.55	0.75	1.1
Rated power	hp	0.5	0.75	1	1.5
Mains voltage range		3/PE AC 340 V ... 528 V, 45 Hz ... 65 Hz			
Output voltage		3 AC 0-400/480 V			
Rated mains current					
without mains choke	A	1.5	2.1	2.8	3.7
with mains choke	A	1.2	1.7	2.2	2.5
Apparent output power	kVA	0.9	1.2	1.6	2.2
Rated output current					
2 kHz	A	-	1.6	2.1	3
4 kHz	A	1.1	1.6	2.1	3
8 kHz	A	1.1	1.6	2.1	3
16 kHz	A	0.7	1.1	1.4	2
Power loss					
2 kHz	W	-	24	30	38
4 kHz	W	20	25	32	40
8 kHz	W	24	31	40	51
16 kHz	W	24	31	40	51
when the controller is inhibited	W	6	6	6	6
Overcurrent cycle 180 s					
Max. output current	A	1.7	2.4	3.2	4.5
Overload time	s	60	60	60	60
Recovery time	s	120	120	120	120
Max. output current during the recovery time	A	0.8	1.2	1.6	2.3
Overcurrent cycle 15 s					
Max. output current	A	2.2	3.2	4.2	6
Overload time	s	3	3	3	3
Recovery time	s	12	12	12	12
Max. output current during the recovery time	A	0.8	1.2	1.6	2.3
Cyclic mains switching		3 times per minute			
Brake chopper					
Max. output current	A	2	2	2	5.2
Min. brake resistance	Ω	390	390	390	150
Max. shielded motor cable length					
without EMC category	m	15	50	50	50
Category C1 (2 kHz, 4 kHz, 8 kHz)	m	3	3	3	-
Category C2 (2 kHz, 4 kHz, 8 kHz)	m	15	20	20	20
Category C3 (2 kHz, 4 kHz, 8 kHz)	m	15	20	20	35
Weight	kg	0.8	1	1	1.35
Weight	lb	1.8	2.2	2.2	3



Technical data

3-phase mains connection 480 V
Rated data

Inverter		i550-C1.5/400-3	i550-C2.2/400-3	i550-C3.0/400-3	i550-C4.0/400-3
Rated power	kW	1.5	2.2	3	4
Rated power	hp	2	3	4	5
Mains voltage range		3/PE AC 340 V ... 528 V, 45 Hz ... 65 Hz			
Output voltage		3 AC 0-400/480 V			
Rated mains current					
without mains choke	A	4.5	6.5	8	10.5
with mains choke	A	3.1	4.4	5.8	7.5
Apparent output power	kVA	2.6	3.8	4.9	6.4
Rated output current					
2 kHz	A	3.5	4.8	6.3	8.2
4 kHz	A	3.5	4.8	6.3	8.2
8 kHz	A	3.5	4.8	6.3	8.2
16 kHz	A	2.3	3.2	4.2	5.5
Power loss					
2 kHz	W	45	62	79	102
4 kHz	W	48	66	85	110
8 kHz	W	61	85	110	140
16 kHz	W	61	85	109	140
when the controller is inhibited	W	6	6	6	6
Overcurrent cycle 180 s					
Max. output current	A	5.3	7.2	9.5	12.3
Overload time	s	60	60	60	60
Recovery time	s	120	120	120	120
Max. output current during the recovery time	A	2.6	3.6	4.7	6.2
Overcurrent cycle 15 s					
Max. output current	A	7	9.6	12.6	16.4
Overload time	s	3	3	3	3
Recovery time	s	12	12	12	12
Max. output current during the recovery time	A	2.6	3.6	4.7	6.2
Cyclic mains switching		3 times per minute			
Brake chopper					
Max. output current	A	5.2	5.2	9.5	16.6
Min. brake resistance	Ω	150	150	82	47
Max. shielded motor cable length					
without EMC category	m	50	50	50	50
Category C1 (2 kHz, 4 kHz, 8 kHz)	m	-	-	-	-
Category C2 (2 kHz, 4 kHz, 8 kHz)	m	20	20	20	20
Category C3 (2 kHz, 4 kHz, 8 kHz)	m	35	35	35	35
Weight	kg	1.35	1.35	1.35	1.35
Weight	lb	3	3	3	3

Technical data

3-phase mains connection 480 V

Rated data



Inverter		i550-C5.5/400-3	i550-C7.5/400-3	i550-C11/400-3	i550-C15/400-3
Rated power	kW	5.5	7.5	11	15
Rated power	hp	7.5	10	15	20
Mains voltage range		3/PE AC 340 V ... 528 V, 45 Hz ... 65 Hz			
Output voltage		3 AC 0-400/480 V			
Rated mains current					
without mains choke	A	14.3	16.6	23.7	32.3
with mains choke	A	10.3	13.1	18.6	24
Apparent output power	kVA	8.7	11	16	22
Rated output current					
2 kHz	A	11	14	21	27
4 kHz	A	11	14	21	27
8 kHz	A	11	14	21	27
16 kHz	A	7.3	9.3	14	18
Power loss					
2 kHz	W	137	172	242	340
4 kHz	W	145	185	260	360
8 kHz	W	190	240	340	460
16 kHz	W	189	238	337	469
when the controller is inhibited	W	6	6	6	18
Overcurrent cycle 180 s					
Max. output current	A	16.5	21	31.5	40.5
Overload time	s	60	60	60	60
Recovery time	s	120	120	120	120
Max. output current during the recovery time	A	8.3	10.5	15.8	20.3
Overcurrent cycle 15 s					
Max. output current	A	22	28	42	54
Overload time	s	3	3	3	3
Recovery time	s	12	12	12	12
Max. output current during the recovery time	A	8.3	10.5	15.8	20.3
Cyclic mains switching		3 times per minute			
Brake chopper					
Max. output current	A	16.6	29	29	43
Min. brake resistance	Ω	47	27	27	18
Max. shielded motor cable length					
without EMC category	m	100	100	100	100
Category C1 (2 kHz, 4 kHz, 8 kHz)	m	-	-	-	-
Category C2 (2 kHz, 4 kHz, 8 kHz)	m	20	20	20	20
Category C3 (2 kHz, 4 kHz, 8 kHz)	m	35	50	50	35
Weight	kg	2.3	3.7	3.7	10.3
Weight	lb	5	8	8	23



Technical data

3-phase mains connection 480 V
Rated data

Inverter		i550-C18/400-3	i550-C22/400-3	i550-C30/400-3	i550-C37/400-3
Rated power	kW	18.5	22	30	37
Rated power	hp	25	30	40	50
Mains voltage range		3/PE AC 340 V ... 528 V, 45 Hz ... 65 Hz			
Output voltage		3 AC 0-400/480 V			
Rated mains current					
without mains choke	A	40.3	47.4	-	-
with mains choke	A	30	35.3	45.7	57
Apparent output power	kVA	27	32	41	51
Rated output current					
2 kHz	A	34	40.4	52	65
4 kHz	A	34	40.4	52	65
8 kHz	A	34	40.4	52	65
16 kHz	A	22.6	26.9	34.6	43.3
Power loss					
2 kHz	W	420	491	639	790
4 kHz	W	450	520	680	840
8 kHz	W	570	670	880	1100
16 kHz	W	581	680	884	1095
when the controller is inhibited	W	18	18	25	25
Overcurrent cycle 180 s					
Max. output current	A	51	61	78	98
Overload time	s	60	60	60	60
Recovery time	s	120	120	120	120
Max. output current during the recovery time	A	25.5	30	39	49
Overcurrent cycle 15 s					
Max. output current	A	68	81	104	130
Overload time	s	3	3	3	3
Recovery time	s	12	12	12	12
Max. output current during the recovery time	A	25.5	30	39	49
Cyclic mains switching		3 times per minute			
Brake chopper					
Max. output current	A	52	52	104	104
Min. brake resistance	Ω	15	15	7.5	7.5
Max. shielded motor cable length					
without EMC category	m	100	100	100	100
Category C1 (2 kHz, 4 kHz, 8 kHz)	m	-	-	-	-
Category C2 (2 kHz, 4 kHz, 8 kHz)	m	20	20	20	20
Category C3 (2 kHz, 4 kHz, 8 kHz)	m	35	35	35	35
Weight	kg	10.3	10.3	17.2	17.2
Weight	lb	23	23	38	38

Technical data

3-phase mains connection 480 V

Rated data



Inverter		i550-C45/400-3	i550-C55/400-3	i550-C75/400-3	i550-C90/400-3
Rated power	kW	45	55	75	90
Rated power	hp	60	75	100	125
Mains voltage range		3/PE AC 340 V ... 528 V, 45 Hz ... 65 Hz			
Output voltage		3 AC 0-400/480 V			
Rated mains current					
without mains choke	A	-	-	-	-
with mains choke	A	66.7	83	113	146
Apparent output power	kVA	60	75	100	121
Rated output current					
2 kHz	A	77	96	124	156
4 kHz	A	77	96	124	156
8 kHz	A	77	96	124	140
16 kHz	A	51.3	63.9	83.1	93.6
Power loss					
2 kHz	W	920	1137	1539	1841
4 kHz	W	980	1210	1640	1961
8 kHz	W	1280	1580	2140	2312
16 kHz	W	1278	1579	2143	2312
when the controller is inhibited	W	25	30	30	30
Overcurrent cycle 180 s					
Max. output current	A	116	144	186	234
Overload time	s	60	60	60	60
Recovery time	s	120	120	120	120
Max. output current during the recovery time	A	58	72	93	117
Overcurrent cycle 15 s					
Max. output current	A	154	192	248	312
Overload time	s	3	3	3	3
Recovery time	s	12	12	12	12
Max. output current during the recovery time	A	58	72	93	117
Cyclic mains switching		3 times per minute	Once per minute		
Brake chopper					
Max. output current	A	104	166	166	275
Min. brake resistance	Ω	7.5	4.7	4.7	2.4
Max. shielded motor cable length					
without EMC category	m	100	200	200	200
Category C1 (2 kHz, 4 kHz, 8 kHz)	m	-	-	-	-
Category C2 (2 kHz, 4 kHz, 8 kHz)	m	20	20	20	20
Category C3 (2 kHz, 4 kHz, 8 kHz)	m	35	100	100	100
Weight	kg	17.2	24	24	35.6
Weight	lb	38	53	53	78.5



Technical data

3-phase mains connection 480 V
Rated data

Inverter		i550-C110/400-3
Rated power	kW	110
Rated power	hp	150
Mains voltage range		3/PE AC 340 V ... 528 V, 45 Hz ... 65 Hz
Output voltage		3 AC 0-400/480 V
Rated mains current		
without mains choke	A	-
with mains choke	A	168
Apparent output power	kVA	142
Rated output current		
2 kHz	A	180
4 kHz	A	180
8 kHz	A	162
16 kHz	A	108
Power loss		
2 kHz	W	2163
4 kHz	W	2305
8 kHz	W	2717
16 kHz	W	2717
when the controller is inhibited	W	30
Overcurrent cycle 180 s		
Max. output current	A	270
Overload time	s	60
Recovery time	s	120
Max. output current during the recovery time	A	135
Overcurrent cycle 15 s		
Max. output current	A	360
Overload time	s	3
Recovery time	s	12
Max. output current during the recovery time	A	135
Cyclic mains switching		Once per minute
Brake chopper		
Max. output current	A	275
Min. brake resistance	Ω	2.4
Max. shielded motor cable length		
without EMC category	m	200
Category C1 (2 kHz, 4 kHz, 8 kHz)	m	-
Category C2 (2 kHz, 4 kHz, 8 kHz)	m	20
Category C3 (2 kHz, 4 kHz, 8 kHz)	m	100
Weight	kg	35.6
Weight	lb	78.5

Technical data

3-phase mains connection 480 V
Fusing data



Fusing data



A residual current device (RCD) is optional.

EN 60204-1

Inverter	Fuse		Circuit breaker		RCD
	Characteristic	Max. rated current	Characteristic	Max. rated current	
		A		A	
i550-C0.37/400-3	gG/gL or gRL	10	B	10	≥ 30 mA, type B
i550-C0.55/400-3	gG/gL or gRL	10	B	10	≥ 30 mA, type B
i550-C0.75/400-3	gG/gL or gRL	10	B	10	≥ 30 mA, type B
i550-C1.1/400-3	gG/gL or gRL	16	B	16	≥ 30 mA, type B
i550-C1.5/400-3	gG/gL or gRL	16	B	16	≥ 30 mA, type B
i550-C2.2/400-3	gG/gL or gRL	16	B	16	≥ 30 mA, type B
i550-C3.0/400-3	gG/gL or gRL	25	B	25	≥ 30 mA, type B
i550-C4.0/400-3	gG/gL or gRL	25	B	25	≥ 30 mA, type B
i550-C5.5/400-3	gG/gL or gRL	25	B	25	≥ 300 mA, type B
i550-C7.5/400-3	gG/gL or gRL	32	B	32	≥ 300 mA, type B
i550-C11/400-3	gG/gL or gRL	32	B	32	≥ 300 mA, type B
i550-C15/400-3	gG/gL or gRL	63	B	63	≥ 300 mA, type B
i550-C18/400-3	gG/gL or gRL	63	B	63	≥ 300 mA, type B
i550-C22/400-3	gG/gL or gRL	63	B	63	≥ 300 mA, type B
i550-C30/400-3	gG/gL or gRL	80	B	80	≥ 300 mA, type B
i550-C37/400-3	gG/gL or gRL	100	B	100	≥ 300 mA, type B
i550-C45/400-3	gG/gL or gRL	125	B	125	≥ 300 mA, type B
i550-C55/400-3	gR	160	-	-	≥ 300 mA, type B
i550-C75/400-3	gR	160	-	-	≥ 300 mA, type B
i550-C90/400-3	gR	300	-	-	≥ 300 mA, type B
i550-C110/400-3	gR	300	-	-	≥ 300 mA, type B

The connection data according to UL can be found under: [▶ Connection according to UL 50](#)



Please note that from 30 kW onwards a mains choke must always be used.



Technical data

3-phase mains connection 480 V

Terminal data

Terminal data

		i550-Cxxxx/400-3				
Inverter	kW	0.37 ... 2.2	3.0 ... 4.0	5.5	7.5 ... 11	15 ... 22
Connection		Mains connection X100				
Connection type		Pluggable screw terminal		Screw terminal		
Max. Cable cross-section	mm ²	2.5	4	6	16	35
Stripping length	mm	8	8	9	11	18
Tightening torque	Nm	0.5	0.6	0.5	1.2	3.8
Required tool		0.5 x 3.0		0.6 x 3.5	0.8 x 4.0	0.8 x 5.5

		i550-Cxxxx/400-3				
Inverter	kW	30 ... 45	55 ... 75	90 ... 110	0.37 ... 5.5	3.0 ... 4.0
Connection		Mains connection X100			PE connection	
Connection type		Screw terminal			PE screw	
Max. Cable cross-section	mm ²	50	95	150	6	6
Stripping length	mm	19	22	28	10	10
Tightening torque	Nm	4	10	18	2	2
Required tool		Hexagon socket 5	Hexagon socket 6	Hexagon socket 8	Torx 20	

		i550-Cxxxx/400-3				
Inverter	kW	7.5 ... 11	15 ... 75	90 ... 110	0.37 ... 2.2	3.0 ... 4.0
Connection		PE connection			Motor connection X105	
Connection type		PE screw		PE bolt	Pluggable screw terminal	
Max. Cable cross-section	mm ²	16	25	150	2.5	2.5
Stripping length	mm	11	16	-	8	8
Tightening torque	Nm	3.4	4	10	0.5	0.5
Required tool		PZ2		Width AF 13	0.5 x 3.0	

		i550-Cxxxx/400-3				
Inverter	kW	5.5	7.5 ... 11	15 ... 22	30 ... 45	55 ... 75
Connection		Motor connection X105				
Connection type		Screw terminal				
Max. Cable cross-section	mm ²	6	16	35	50	95
Stripping length	mm	9	11	18	19	22
Tightening torque	Nm	0.5	1.2	3.8	4	10
Required tool		0.6 x 3.5	0.8 x 4.0	0.8 x 5.5	Hexagon socket 5	Hexagon socket 6

		i550-Cxxxx/400-3				
Inverter	kW	90 ... 110				
Connection		Motor connection X105				
Connection type		Screw terminal				
Max. Cable cross-section	mm ²	150				
Stripping length	mm	28				
Tightening torque	Nm	18				
Required tool		Hexagon socket 8				

The terminal data for the terminal X1 can be found under: [Terminal data](#) 78

Technical data

3-phase mains connection 480 V
Brake resistors



Brake resistors

Inverter	Brake resistor					
	Order code	Rated resistance	Rated power	Thermal capacity	Dimensions (H x W x D)	Weight
		Ω	W	kWs	mm	kg
i550-C0.37/400-3	ERBM470R020W	470	20	3	160 x 40 x 36	0.34
i550-C0.37/400-3	ERBM390R100W	390	100	15	235 x 20.6 x 40	0.37
i550-C0.55/400-3	ERBM390R100W	390	100	15	235 x 20.6 x 40	0.37
i550-C0.75/400-3	ERBM390R100W	390	100	15	235 x 20.6 x 40	0.37
i550-C1.1/400-3	ERBP180R200W	180	200	30	240 x 42 x 122	1.0
i550-C1.1/400-3	ERBP180R300W	180	300	45	320 x 42 x 122	1.4
i550-C1.5/400-3	ERBP180R200W	180	200	30	240 x 42 x 122	1.0
i550-C1.5/400-3	ERBS180R350WNQN000	180	350	53	382 x 124 x 122	2.1
i550-C2.2/400-3	ERBP180R200W	180	200	30	240 x 42 x 122	1.0
i550-C2.2/400-3	ERBP180R300W	180	300	45	320 x 42 x 122	1.4
i550-C2.2/400-3	ERBS180R350WNQN000	180	350	53	382 x 124 x 122	2.1
i550-C3.0/400-3	ERBM082R150W	82	150	22.5	238 x 80 x 59	0.70
i550-C3.0/400-3	ERBP082R200W	82	200	30	240 x 42 x 122	1.0
i550-C3.0/400-3	ERBS082R780WNQN000	82	780	117	666 x 124 x 122	3.6
i550-C4.0/400-3	ERBM047R135W	47	135	6.3	216 x 80 x 28	0.67
i550-C4.0/400-3	ERBS047R400W	47	400	60	400 x 114 x 105	2.3
i550-C4.0/400-3	ERBS047R800W	47	800	120	710 x 114 x 105	4.0
i550-C5.5/400-3	ERBP047R200W	47	200	30	240 x 42 x 122	1.0
i550-C5.5/400-3	ERBS047R400W	47	400	60	400 x 114 x 105	2.3
i550-C5.5/400-3	ERBS047R800W	47	800	120	710 x 114 x 105	4.0
i550-C7.5/400-3	ERBP027R200W	27	200	30	240 x 42 x 122	1.0
i550-C7.5/400-3	ERBS027R600W	27	600	90	550 x 114 x 105	3.1
i550-C7.5/400-3	ERBS027R01K4	27	1400	210	1110 x 114 x 105	6.3
i550-C11/400-3	ERBS027R600W	27	600	90	550 x 114 x 105	3.1
i550-C11/400-3	ERBS027R01K2	27	1200	180	1020 x 114 x 105	5.6
i550-C11/400-3	ERBS027R01K4	27	1400	210	1110 x 114 x 105	6.3
i550-C15/400-3	ERBP018R300W	18	300	45	320 x 42 x 122	1.4
i550-C15/400-3	ERBS018R01K4	18	1400	210	1110 x 114 x 105	6.3
i550-C15/400-3	ERBG018R04K3	18	4300	645	302 x 486 x 426	13.5
i550-C18/400-3	ERBS015R800W	15	800	120	710 x 114 x 105	4.0
i550-C18/400-3	ERBS015R02K4	15	2400	360	1020 x 204 x 105	10
i550-C18/400-3	ERBG015R06K2	15	6200	930	302 x 486 x 526	17.0
i550-C22/400-3	ERBS015R800W	15	800	120	710 x 114 x 105	4.0
i550-C22/400-3	ERBS015R02K4	15	2400	360	1020 x 204 x 105	10
i550-C22/400-3	ERBG015R06K2	15	6200	930	302 x 486 x 526	17.0
i550-C30/400-3	ERBG075D01K9	7.50	1900	285	302 x 486 x 236	9.5
i550-C37/400-3	ERBG075D01K9	7.50	1900	285	302 x 486 x 236	9.5
i550-C45/400-3	ERBG075D01K9	7.50	1900	285	302 x 486 x 236	9.5
i550-C55/400-3	ERBG005R02K6	5	2600	390	302 x 486 x 326	11.0
i550-C75/400-3	ERBG005R02K6	5	2600	390	302 x 486 x 326	11.0
i550-C90/400-3	ERBG028D04K1	2.80	4100	615	302 x 486 x 426	12.8
i550-C110/400-3	ERBG028D04K1	2.80	4100	615	302 x 486 x 426	12.8



Technical data

3-phase mains connection 480 V
Mains chokes

Mains chokes

Inverter	Mains choke					
	Order code	No. of phases	Rated current	Inductance	Dimensions (h x w x d)	Weight
			A	mH	mm	kg
i550-C0.37/400-3	EZAELN3002B203	3	1.5	19.6	56 x 77 x 100	0.52
i550-C0.55/400-3	EZAELN3002B153		2	14.7		0.53
i550-C0.75/400-3	EZAELN3004B742		4	7.35	60 x 95 x 115	1.31
i550-C1.1/400-3						
i550-C1.5/400-3						
i550-C2.2/400-3	EZAELN3006B492		6	4.9	69 x 95 x 120	1.45
i550-C3.0/400-3						
i550-C4.0/400-3	EZAELN3008B372		8	3.68	85 x 120 x 140	1.9
i550-C5.5/400-3	EZAELN3016B182		16	1.84	95 x 120 x 140	2.7
i550-C7.5/400-3						
i550-C11/400-3	EZAELN3020B152		20	1.47	95 x 155 x 165	3.8
i550-C15/400-3	EZAELN3025B122		25	1.18	110 x 155 x 170	5.8
i550-C18/400-3	EZAELN3030B981		30	0.98		5.85
i550-C22/400-3	EZAELN3040B741		40	0.74	112 x 185 x 200	6.8
i550-C30/400-3	EZAELN3050B591		50	0.59	112 x 185 x 210	8.35
i550-C37/400-3	EZAELN3063B471		63	0.47	122 x 185 x 210	9.65
i550-C45/400-3	EZAELN3080B371		80	0.37	125 x 210 x 240	12.5
i550-C55/400-3	EZAELN3090B331		90	0.33	115 x 267 x 205	11.5
i550-C75/400-3	EZAELN3125B241		125	0.24	139 x 291 x 215	17.5
i550-C90/400-3	EZAELN3160B191		160	0.19	149 x 291 x 215	22.5
i550-C110/400-3	EZAELN3180B171	180	0.17	164 x 316 x 235	26	

Technical data

3-phase mains connection 480 V
RFI filters / Mains filters



RFI filters / Mains filters

Basic information on RFI filters, mains filters and EMC: from [193](#)



EMC filters can be used both in the side structure and in the substructure.

Maximum motor cable lengths with residual current device (RCD)

Mains connection			3-phase, 400 V/480 V			
Inverter			i550-C0.37/400-3	i550-C0.55/400-3 i550-C0.75/400-3	i550-C1.1/400-3 i550-C1.5/400-3 i550-C2.2/400-3 i550-C3.0/400-3 i550-C4.0/400-3	i550-C5.5/400-3
Without RFI filter						
Without EMC category Thermal limitation	Max. Shielded motor cable length	m	15	50	50	100
	Max. Unshielded motor cable length	m	30	100	200	200
With integrated RFI filter						
Category C1	Max. Shielded motor cable length	m	3	3	-	-
Category C2		m	15	20	20	20
	RCD (optional)	mA	30	30	30	300
RFI filter Low Leakage						
Category C1	Max. Shielded motor cable length	m	-	-	-	-
	RCD (optional)	mA	-	-	-	-
RFI filter Short Distance						
Category C1	Max. Shielded motor cable length	m	15	25	25	25
Category C2		m	15	50	50	50
	RCD (optional)	mA	30	30	30	30
RFI filter Long Distance						
Category C1	Max. Shielded motor cable length	m	15	50	50	50
Category C2		m	15	50	50	100
	RCD (optional)	mA	300	300	300	300



Technical data

3-phase mains connection 480 V
RFI filters / Mains filters

Mains connection			3-phase, 400 V/480 V			
Inverter			i550-C7.5/400-3 i550-C11/400-3	i550-C15/400-3 i550-C18/400-3 i550-C22/400-3	i550-C30/400-3 i550-C37/400-3 i550-C45/400-3	i550-C55/400-3 i550-C75/400-3 i550-C90/400-3 i550-C110/400-3
Without RFI filter						
Without EMC category Thermal limitation	Max. Shielded motor cable length	m	100	100	100	100
	Max. Unshielded motor cable length	m	200	200	200	200
With integrated RFI filter						
Category C1	Max. Shielded motor cable length	m	-	-	-	-
Category C2		m	20	20	20	20
	RCD (optional)	mA	300	300	300	300
RFI filter Low Leakage						
Category C1	Max. Shielded motor cable length	m	-	-	-	-
	RCD (optional)	mA	-	-	-	-
RFI filter Short Distance						
Category C1	Max. Shielded motor cable length	m	25	-	-	-
Category C2		m	50	-	-	-
	RCD (optional)	mA	30	-	-	-
RFI filter Long Distance						
Category C1	Max. Shielded motor cable length	m	50	50	50	50
Category C2	Max. Shielded motor cable length	m	100	100	100	100
	RCD (optional)	mA	300	300	300	300

Short Distance

Inverter	Filters			
	Order code	Rated current	Dimensions (h x w x d)	Weight
		A	mm	kg
i550-C0.37/400-3	I0FAE175F100S0000S	3.3	276 x 60 x 50	0.9
i550-C0.55/400-3				
i550-C0.75/400-3				
i550-C1.1/400-3	I0FAE222F100S0000S	7.8	346 x 60 x 50	1.1
i550-C1.5/400-3				
i550-C2.2/400-3				
i550-C3.0/400-3	I0FAE255F100S0001S	18.3	346 x 90 x 60	2.1
i550-C4.0/400-3				
i550-C5.5/400-3				
i550-C7.5/400-3	I0FAE311F100S0000S	29	371 x 120 x 60	2.4
i550-C11/400-3				

Technical data

3-phase mains connection 480 V
RFI filters / Mains filters



Long Distance

Inverter	Filters			
	Order code	Rated current	Dimensions (h x w x d)	Weight
		A	mm	kg
i550-C0.37/400-3	I0FAE175F100D0000S	3.3	276 x 60 x 50	0.9
i550-C0.55/400-3				
i550-C0.75/400-3				
i550-C1.1/400-3	I0FAE222F100D0000S	7.8	346 x 60 x 50	1.1
i550-C1.5/400-3				
i550-C2.2/400-3				
i550-C3.0/400-3	I0FAE240F100D0000S	12.5		1.35
i550-C4.0/400-3				
i550-C5.5/400-3	I0FAE255F100D0001S	18.3	346 x 90 x 60	1.7
i550-C7.5/400-3	I0FAE311F100D0000S	29	371 x 120 x 60	2.1
i550-C11/400-3				
i550-C15/400-3	I0FAE318F100D0000S	50.4	436 x 205 x 90	7.1
i550-C18/400-3				
i550-C22/400-3	I0FAE322F100D0000S	43		18.5
i550-C30/400-3	I0FAE330F100D0000S	55	590 x 250 x 105	23
i550-C37/400-3	I0FAE337F100D0000S	69		25
i550-C45/400-3	I0FAE345F100D0001S	100		32
i550-C55/400-3	I0FAE355F100D0001S	120	700 x 250 x 105	36
i550-C75/400-3	I0FAE375F100D0001S	162		41.5
i550-C90/400-3	I0FAE411F100D0001S	240	855 x 250 x 130	63
i550-C110/400-3				

From i550-C22/400-3, long distance mains filters are used. Mains filters are a combination of mains choke and RFI filter.



3-phase mains connection 480 V "Light Duty"

Rated data

The output currents apply to these operating conditions:

- At a switching frequency of 2 kHz or 4 kHz: Ambient temperature above 40 °C with a rated output current reduced by 2.5 %/°C.
- If the load characteristic "Light Duty" and the switching frequencies 8 kHz or 16 kHz are selected, only the values of the load characteristic "Heavy Duty" are reached.

Inverter		i550-C3.0/400-3	i550-C4.0/400-3	i550-C5.5/400-3	i550-C7.5/400-3
Rated power	kW	4	5.5	7.5	11
Rated power	hp	5	7.5	10	15
Mains voltage range		3/PE AC 340 V ... 528 V, 45 Hz ... 65 Hz			
Output voltage		3 AC 0-400/480 V			
Rated mains current					
without mains choke	A	8.6	11.2	15.3	22
with mains choke	A	6.8	8.8	12.1	17.2
Apparent output power	kVA	5.9	8	10.5	15
Rated output current					
2 kHz	A	7.6	9.8	13.2	18.3
4 kHz	A	7.6	9.8	13.2	18.3
8 kHz	A	-	-	-	-
16 kHz	A	-	-	-	-
Power loss					
2 kHz	W	94	125	163	238
4 kHz	W	100	133	173	253
8 kHz	W	-	-	-	-
16 kHz	W	-	-	-	-
when the controller is inhibited	W	6	6	6	6
Overcurrent cycle 180 s					
Max. output current	A	9.5	12.3	16.5	21
Overload time	s	60	60	60	60
Recovery time	s	120	120	120	120
Max. output current during the recovery time	A	4.7	6.2	8.3	10.5
Overcurrent cycle 15 s					
Max. output current	A	12.6	16.4	22	28
Overload time	s	3	3	3	3
Recovery time	s	12	12	12	12
Max. output current during the recovery time	A	4.7	6.2	8.3	10.5
Cyclic mains switching		3 times per minute			
Brake chopper					
Max. output current	A	9.5	16.6	16.6	29
Min. brake resistance	Ω	82	47	47	27
Max. shielded motor cable length					
without EMC category	m	50	50	100	100
Category C1 (2 kHz, 4 kHz, 8 kHz)	m	-	-	-	-
Category C2 (2 kHz, 4 kHz, 8 kHz)	m	20	20	20	20
Category C3 (2 kHz, 4 kHz, 8 kHz)	m	35	35	35	50
Weight	kg	1.35	1.35	2.3	3.7
Weight	lb	3	3	5	8

Technical data

3-phase mains connection 480 V "Light Duty"

Rated data



Inverter		i550-C11/400-3	i550-C15/400-3	i550-C18/400-3	i550-C22/400-3
Rated power	kW	15	18.5	22	30
Rated power	hp	20	25	30	40
Mains voltage range		3/PE AC 340 V ... 528 V, 45 Hz ... 65 Hz			
Output voltage		3 AC 0-400/480 V			
Rated mains current					
without mains choke	A	-	40	-	-
with mains choke	A	22.6	30	38	46
Apparent output power	kVA	19	26	32	38
Rated output current					
2 kHz	A	25.2	32.4	40.8	48.5
4 kHz	A	25.2	32.4	40.8	48.5
8 kHz	A	-	-	-	-
16 kHz	A	-	-	-	-
Power loss					
2 kHz	W	290	404	501	585
4 kHz	W	309	430	533	623
8 kHz	W	-	-	-	-
16 kHz	W	-	-	-	-
when the controller is inhibited	W	6	18	18	18
Overcurrent cycle 180 s					
Max. output current	A	31.5	40.5	51	61
Overload time	s	60	60	60	60
Recovery time	s	120	120	120	120
Max. output current during the recovery time	A	15.8	20.3	25.5	30
Overcurrent cycle 15 s					
Max. output current	A	42	54	68	81
Overload time	s	3	3	3	3
Recovery time	s	12	12	12	12
Max. output current during the recovery time	A	15.8	20.3	25.5	30
Cyclic mains switching		3 times per minute			
Brake chopper					
Max. output current	A	29	43	52	52
Min. brake resistance	Ω	27	18	15	15
Max. shielded motor cable length					
without EMC category	m	100	100	100	100
Category C1 (2 kHz, 4 kHz, 8 kHz)	m	-	-	-	-
Category C2 (2 kHz, 4 kHz, 8 kHz)	m	20	20	20	20
Category C3 (2 kHz, 4 kHz, 8 kHz)	m	50	35	35	35
Weight	kg	3.7	10.3	10.3	10.3
Weight	lb	8	23	23	23



Technical data

3-phase mains connection 480 V "Light Duty"
Rated data

Inverter		i550-C30/400-3	i550-C37/400-3	i550-C45/400-3	i550-C55/400-3
Rated power	kW	37	45	55	75
Rated power	hp	50	60	75	100
Mains voltage range		3/PE AC 340 V ... 528 V, 45 Hz ... 65 Hz			
Output voltage		3 AC 0-400/480 V			
Rated mains current					
without mains choke	A	-	-	-	-
with mains choke	A	59	73	86	105
Apparent output power	kVA	49	61	72	89
Rated output current					
2 kHz	A	62.4	78	92.4	115
4 kHz	A	62.4	78	92.4	115
8 kHz	A	-	-	-	-
16 kHz	A	-	-	-	-
Power loss					
2 kHz	W	761	942	1101	1358
4 kHz	W	810	1004	1171	1446
8 kHz	W	-	-	-	-
16 kHz	W	-	-	-	-
when the controller is inhibited	W	25	25	25	30
Overcurrent cycle 180 s					
Max. output current	A	78	98	116	144
Overload time	s	60	60	60	60
Recovery time	s	120	120	120	120
Max. output current during the recovery time	A	39	49	58	72
Overcurrent cycle 15 s					
Max. output current	A	104	130	154	192
Overload time	s	3	3	3	3
Recovery time	s	12	12	12	12
Max. output current during the recovery time	A	39	49	58	72
Cyclic mains switching		3 times per minute			Once per minute
Brake chopper					
Max. output current	A	104	104	104	166
Min. brake resistance	Ω	7.5	7.5	7.5	4.7
Max. shielded motor cable length					
without EMC category	m	100	100	100	200
Category C1 (2 kHz, 4 kHz, 8 kHz)	m	-	-	-	-
Category C2 (2 kHz, 4 kHz, 8 kHz)	m	20	20	20	20
Category C3 (2 kHz, 4 kHz, 8 kHz)	m	35	35	35	100
Weight	kg	17.2	17.2	17.2	24
Weight	lb	38	38	38	53

Technical data

3-phase mains connection 480 V "Light Duty"

Rated data



Inverter		i550-C75/400-3	i550-C90/400-3	i550-C110/400-3
Rated power	kW	90	110	132
Rated power	hp	125	150	175
Mains voltage range		3/PE AC 340 V ... 528 V, 45 Hz ... 65 Hz		
Output voltage		3 AC 0-400/480 V		
Rated mains current				
without mains choke	A	-	-	-
with mains choke	A	135	175	200
Apparent output power	kVA	121	145	171
Rated output current				
2 kHz	A	149	187	216
4 kHz	A	149	187	216
8 kHz	A	-	-	-
16 kHz	A	-	-	-
Power loss				
2 kHz	W	1841	2203	2589
4 kHz	W	1961	2348	2760
8 kHz	W	-	-	-
16 kHz	W	-	-	-
when the controller is inhibited	W	30	30	30
Overcurrent cycle 180 s				
Max. output current	A	186	234	270
Overload time	s	60	60	60
Recovery time	s	120	120	120
Max. output current during the recovery time	A	93	117	135
Overcurrent cycle 15 s				
Max. output current	A	248	312	360
Overload time	s	3	3	3
Recovery time	s	12	12	12
Max. output current during the recovery time	A	93	117	135
Cyclic mains switching		Once per minute		
Brake chopper				
Max. output current	A	166	275	275
Min. brake resistance	Ω	4.7	2.4	2.4
Max. shielded motor cable length				
without EMC category	m	200	200	200
Category C1 (2 kHz, 4 kHz, 8 kHz)	m	-	-	-
Category C2 (2 kHz, 4 kHz, 8 kHz)	m	20	20	20
Category C3 (2 kHz, 4 kHz, 8 kHz)	m	100	100	100
Weight	kg	24	35.6	35.6
Weight	lb	53	78.5	78.5



Fusing data



A residual current device (RCD) is optional.

EN 60204-1

Inverter	Fuse		Circuit breaker		RCD
	Characteristic	Max. rated current	Characteristic	Max. rated current	
		A		A	
i550-C3.0/400-3	gG/gL or gRL	25	B	25	≥ 30 mA, type B
i550-C4.0/400-3	gG/gL or gRL	25	B	25	≥ 30 mA, type B
i550-C5.5/400-3	gG/gL or gRL	25	B	25	≥ 300 mA, type B
i550-C7.5/400-3	gG/gL or gRL	32	B	32	≥ 300 mA, type B
i550-C11/400-3	gG/gL or gRL	32	B	32	≥ 300 mA, type B
i550-C15/400-3	gG/gL or gRL	63	B	63	≥ 300 mA, type B
i550-C18/400-3	gG/gL or gRL	63	B	63	≥ 300 mA, type B
i550-C22/400-3	gG/gL or gRL	63	B	63	≥ 300 mA, type B
i550-C30/400-3	gG/gL or gRL	80	B	80	≥ 300 mA, type B
i550-C37/400-3	gG/gL or gRL	100	B	100	≥ 300 mA, type B
i550-C45/400-3	gG/gL or gRL	125	B	125	≥ 300 mA, type B
i550-C55/400-3	gR	160	-	-	≥ 300 mA, type B
i550-C75/400-3	gR	160	-	-	≥ 300 mA, type B
i550-C90/400-3	gR	300	-	-	≥ 300 mA, type B
i550-C110/400-3	gR	300	-	-	≥ 300 mA, type B

The connection data according to UL can be found under: [▶ Connection according to UL](#)  50



Please note that from 15 kW onwards a mains choke must always be used.

Technical data

3-phase mains connection 480 V "Light Duty"
Terminal data



Terminal data

		i550-Cxxxx/400-3				
Inverter	kW	4.0 ... 5.5	7.5	11 ... 15	18.5 ... 30	37 ... 55
Connection		Mains connection X100				
Connection type		Pluggable screw terminal	Screw terminal			
Max. Cable cross-section	mm ²	4	6	16	35	50
Stripping length	mm	8	9	11	18	19
Tightening torque	Nm	0.6	0.5	1.2	3.8	4
Required tool		0.5 x 3.0	0.6 x 3.5	0.8 x 4.0	0.8 x 5.5	Hexagon socket 5

		i550-Cxxxx/400-3				
Inverter	kW	75 ... 90	110 ... 132	4.0 ... 5.5	7.5	11 ... 15
Connection		Mains connection X100		PE connection		
Connection type		Screw terminal		PE screw		
Max. Cable cross-section	mm ²	95	150	6	6	16
Stripping length	mm	22	28	10	10	11
Tightening torque	Nm	10	18	2	2	3.4
Required tool		Hexagon socket 6	Hexagon socket 8	Torx 20		P22

		i550-Cxxxx/400-3				
Inverter	kW	18.5 ... 90	110 ... 132	4.0 ... 5.5	7.5	11 ... 15
Connection		PE connection		Motor connection X105		
Connection type		PE screw	PE bolt	Pluggable screw terminal	Screw terminal	
Max. Cable cross-section	mm ²	25	150	2.5	6	16
Stripping length	mm	16	-	8	9	11
Tightening torque	Nm	4	10	0.5	0.5	1.2
Required tool		P22	Width AF 13	0.5 x 3.0	0.6 x 3.5	0.8 x 4.0

		i550-Cxxxx/400-3			
Inverter	kW	18.5 ... 30	37 ... 55	75 ... 90	110 ... 132
Connection		Motor connection X105			
Connection type		Screw terminal			
Max. Cable cross-section	mm ²	35	50	95	150
Stripping length	mm	18	19	22	28
Tightening torque	Nm	3.8	4	10	18
Required tool		0.8 x 5.5	Hexagon socket 5	Hexagon socket 6	Hexagon socket 8

The terminal data for the terminal X1 can be found under: [Terminal data](#) 78



Technical data

3-phase mains connection 480 V "Light Duty"
Brake resistors

Brake resistors

Inverter	Brake resistor					
	Order code	Rated resistance	Rated power	Thermal capacity	Dimensions (H x W x D)	Weight
		Ω	W	kWs	mm	kg
i550-C3.0/400-3	ERBM082R150W	82	150	22.5	238 x 80 x 59	0.70
i550-C3.0/400-3	ERBP082R200W	82	200	30	240 x 42 x 122	1.0
i550-C3.0/400-3	ERBS082R780WNQN000	82	780	117	666 x 124 x 122	3.6
i550-C4.0/400-3	ERBM047R135W	47	135	6.3	216 x 80 x 28	0.67
i550-C4.0/400-3	ERBS047R400W	47	400	60	400 x 114 x 105	2.3
i550-C4.0/400-3	ERBS047R800W	47	800	120	710 x 114 x 105	4.0
i550-C5.5/400-3	ERBP047R200W	47	200	30	240 x 42 x 122	1.0
i550-C5.5/400-3	ERBS047R400W	47	400	60	400 x 114 x 105	2.3
i550-C5.5/400-3	ERBS047R800W	47	800	120	710 x 114 x 105	4.0
i550-C7.5/400-3	ERBP027R200W	27	200	30	240 x 42 x 122	1.0
i550-C7.5/400-3	ERBS027R600W	27	600	90	550 x 114 x 105	3.1
i550-C7.5/400-3	ERBS027R01K4	27	1400	210	1110 x 114 x 105	6.3
i550-C11/400-3	ERBS027R600W	27	600	90	550 x 114 x 105	3.1
i550-C11/400-3	ERBS027R01K2	27	1200	180	1020 x 114 x 105	5.6
i550-C11/400-3	ERBS027R01K4	27	1400	210	1110 x 114 x 105	6.3
i550-C15/400-3	ERBP018R300W	18	300	45	320 x 42 x 122	1.4
i550-C15/400-3	ERBS018R01K4	18	1400	210	1110 x 114 x 105	6.3
i550-C15/400-3	ERBG018R04K3	18	4300	645	302 x 486 x 426	13.5
i550-C18/400-3	ERBS015R800W	15	800	120	710 x 114 x 105	4.0
i550-C18/400-3	ERBS015R02K4	15	2400	360	1020 x 204 x 105	10
i550-C18/400-3	ERBG015R06K2	15	6200	930	302 x 486 x 526	17.0
i550-C22/400-3	ERBS015R800W	15	800	120	710 x 114 x 105	4.0
i550-C22/400-3	ERBS015R02K4	15	2400	360	1020 x 204 x 105	10
i550-C22/400-3	ERBG015R06K2	15	6200	930	302 x 486 x 526	17.0
i550-C30/400-3	ERBG075D01K9	7.50	1900	285	302 x 486 x 236	9.5
i550-C37/400-3	ERBG075D01K9	7.50	1900	285	302 x 486 x 236	9.5
i550-C45/400-3	ERBG075D01K9	7.50	1900	285	302 x 486 x 236	9.5
i550-C55/400-3	ERBG005R02K6	5	2600	390	302 x 486 x 326	11.0
i550-C75/400-3	ERBG005R02K6	5	2600	390	302 x 486 x 326	11.0
i550-C90/400-3	ERBG028D04K1	2.80	4100	615	302 x 486 x 426	12.8
i550-C110/400-3	ERBG028D04K1	2.80	4100	615	302 x 486 x 426	12.8

Technical data

3-phase mains connection 480 V "Light Duty"
Mains chokes



Mains chokes

Inverter	Mains choke					
	Order code	No. of phases	Rated current	Inductance	Dimensions (h x w x d)	Weight
			A	mH	mm	kg
i550-C3.0/400-3	EZAELN3008B372	3	8	3.68	85 x 120 x 140	1.9
i550-C4.0/400-3	EZAELN3010B292		10	2.94		2
i550-C5.5/400-3	EZAELN3016B182		16	1.84	95 x 120 x 140	2.7
i550-C7.5/400-3	EZAELN3020B152		20	1.47	95 x 155 x 165	3.8
i550-C11/400-3	EZAELN3025B122		25	1.18	110 x 155 x 170	5.8
i550-C15/400-3	EZAELN3030B981		30	0.98		5.85
i550-C18/400-3	EZAELN3040B741		40	0.74	112 x 185 x 200	6.8
i550-C22/400-3	EZAELN3050B591		50	0.59	112 x 185 x 210	8.35
i550-C30/400-3	EZAELN3063B471		63	0.47	122 x 185 x 210	9.65
i550-C37/400-3	EZAELN3080B371		80	0.37	125 x 210 x 240	12.5
i550-C45/400-3	EZAELN3090B331		90	0.33	115 x 267 x 205	11.5
i550-C55/400-3	EZAELN3125B241		125	0.24	139 x 291 x 215	17.5
i550-C75/400-3	EZAELN3160B191		160	0.19	149 x 291 x 215	22.5
i550-C90/400-3	EZAELN3180B171		180	0.17	164 x 316 x 235	26
i550-C110/400-3	EZAELN3200B151		200	0.15	144 x 352 x 265	25



RFI filters / Mains filters

Basic information on RFI filters, mains filters and EMC: from [193](#)



EMC filters can be used both in the side structure and in the substructure.

Maximum motor cable lengths with residual current device (RCD)

Mains connection			3-phase, 400 V/480 V, Light Duty				
Inverter			i550-C3.0/400-3	i550-C5.5/400-3	i550-C7.5/400-3	i550-C15/400-3	i550-C30/400-3
			i550-C4.0/400-3		i550-C11/400-3		
						i550-C22/400-3	i550-C45/400-3
							i550-C55/400-3
							i550-C75/400-3
							i550-C90/400-3
							i550-C110/400-3
Without RFI filter							
Without EMC category Thermal limitation	Max. motor cable length shielded	m	50	100	100	100	100
	Max. motor cable length unshielded	m	200	200	200	200	200
With integrated RFI filter							
Category C1	Max. motor cable length shielded	m	-	-	-	-	-
Category C2		m	20	20	20	20	20
	RCD (optional)	mA	30	300	300	300	300
RFI filter Low Leakage							
Category C1	Max. motor cable length shielded	m	-	-	-	-	-
	RCD (optional)	mA	-	-	-	-	-
RFI filter Short Distance							
Category C1	Max. motor cable length shielded	m	25	25	25	-	-
Category C2		m	50	50	50	-	-
	RCD (optional)	mA	30	30	30	-	-
RFI filter Long Distance							
Category C1	Max. motor cable length shielded	m	50	50	50	-	-
Category C2		m	100	100	100	-	-
	RCD (optional)	mA	300	300	300	-	-

Short Distance

Inverter	Filters			
	Order code	Rated current	Dimensions (h x w x d)	Weight
		A	mm	kg
i550-C3.0/400-3	IOFAE255F100S0001S	18.3	346 x 90 x 60	2.1
i550-C4.0/400-3				
i550-C5.5/400-3				
i550-C7.5/400-3	IOFAE311F100S0000S	29	371 x 120 x 60	2.4
i550-C11/400-3				

Technical data

3-phase mains connection 480 V "Light Duty"
RFI filters / Mains filters



Long Distance

Inverter	Filters			
	Order code	Rated current	Dimensions (h x w x d)	Weight
		A	mm	kg
i550-C3.0/400-3	I0FAE240F100D0000S	12.5	346 x 60 x 50	1.35
i550-C4.0/400-3	I0FAE255F100D0001S	18.3	346 x 90 x 60	1.7
i550-C5.5/400-3				
i550-C7.5/400-3	I0FAE311F100D0000S	29	371 x 120 x 60	2.1
i550-C11/400-3				
i550-C15/400-3	I0FAE318F100D0000S	50.4	436 x 205 x 90	7.1
i550-C18/400-3	I0FAE322F100D0000S	43		18.5
i550-C22/400-3	I0FAE322F100D0001S	55		
i550-C30/400-3	I0FAE337F100D0000S	69	590 x 250 x 105	25
i550-C37/400-3	I0FAE345F100D0001S	100		32
i550-C45/400-3				
i550-C55/400-3	I0FAE355F100D0001S	120	700 x 250 x 105	36
i550-C75/400-3	I0FAE375F100D0001S	162		41.5
i550-C90/400-3	I0FAE411F100D0001S	240		855 x 250 x 130
i550-C110/400-3				

From i550-C18/400-3, long distance mains filters are used. Mains filters are a combination of mains choke and RFI filter.



Dimensions

0.25 kW ... 0.37 kW

The dimensions in mm apply to:

0.25 kW	i550-CO.25/230-1	i550-CO.25/230-2	
0.37 kW	i550-CO.37/230-1	i550-CO.37/230-2	i550-CO.37/400-3

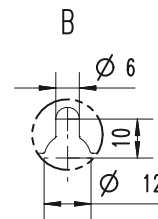
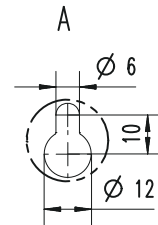
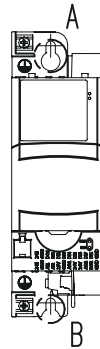
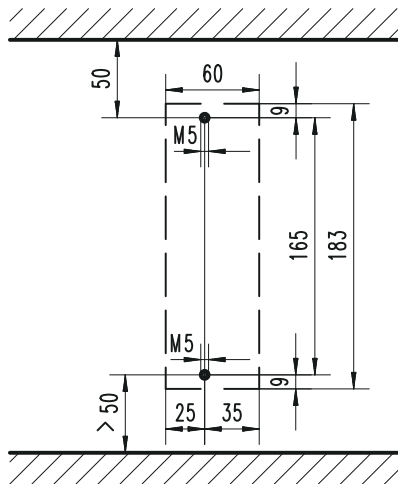
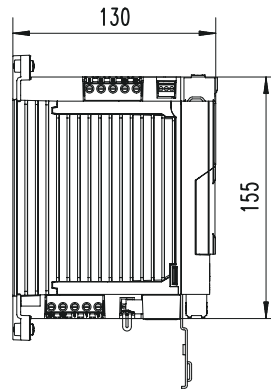
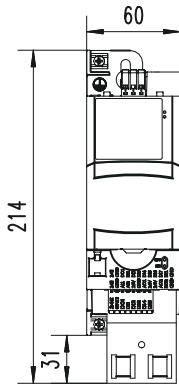

8800263

Technical data

Dimensions



0.25 kW ... 0.37 kW

(120 V)

The dimensions in mm apply to:

0.25 kW	i550-C0.25/120-1
0.37 kW	i550-C0.37/120-1

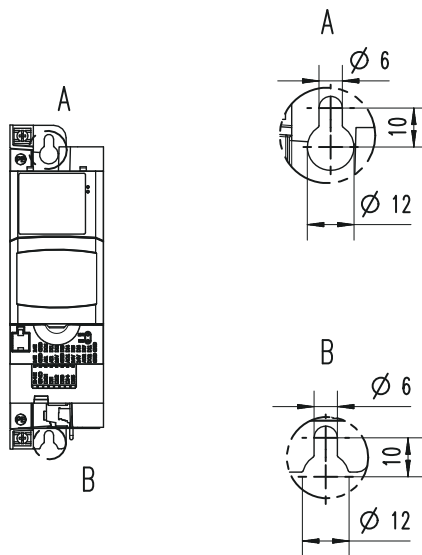
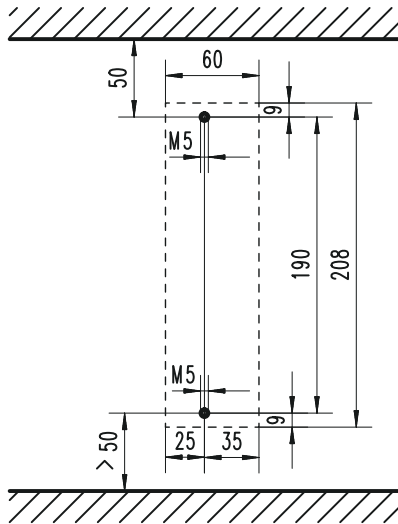
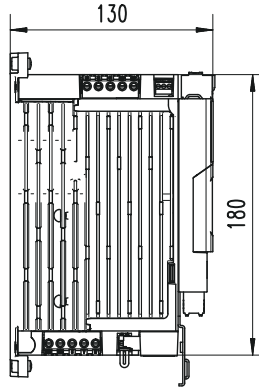
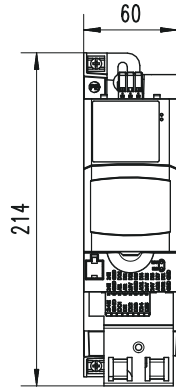

8800264



0.55 kW ... 0.75 kW

The dimensions in mm apply to:

0.55 kW	i550-C0.55/230-1	i550-C0.55/230-2	i550-C0.55/400-3
0.75 kW	i550-C0.75/230-1	i550-C0.75/230-2	i550-C0.75/400-3

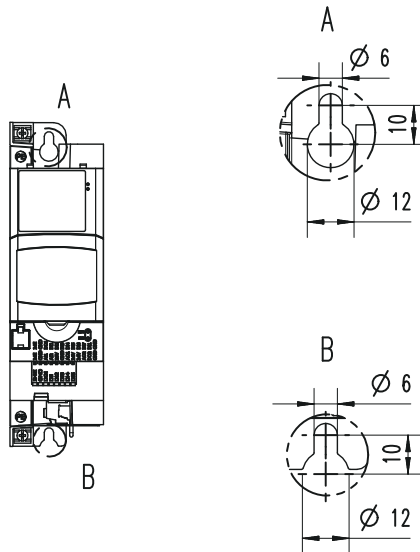
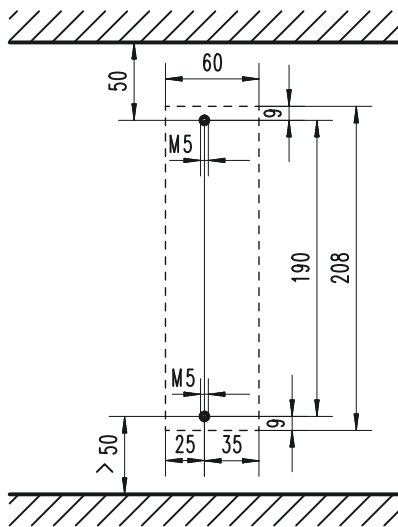
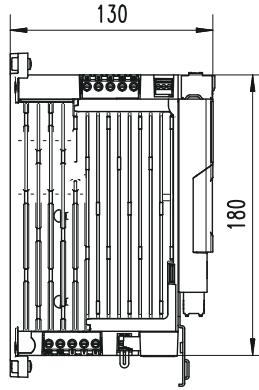
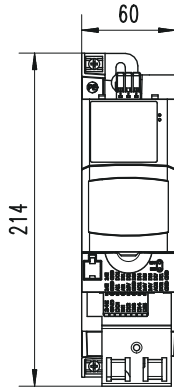

8800264

Technical data

Dimensions



0.75 kW ... 1.1 kW

(120 V)

The dimensions in mm apply to:

0.75 kW	i550-C0.75/120-1
1.1 kW	i550-C1.1/120-1

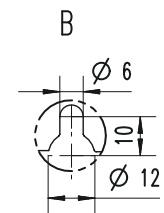
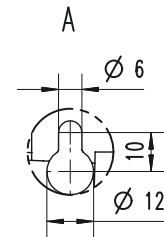
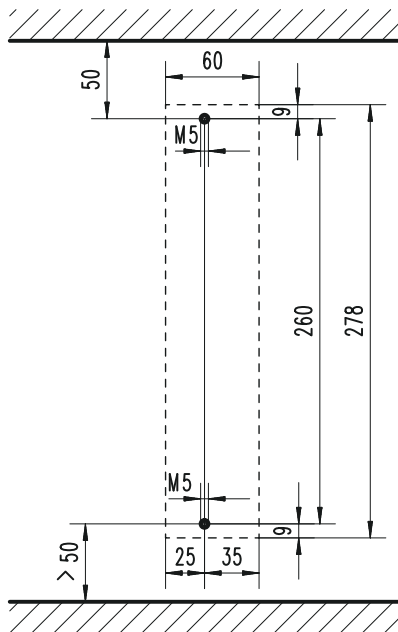
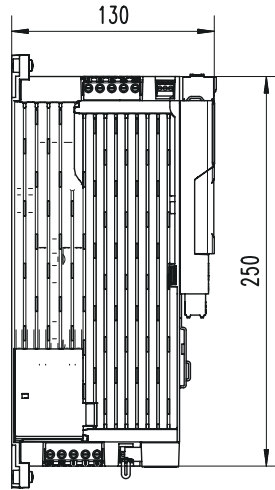
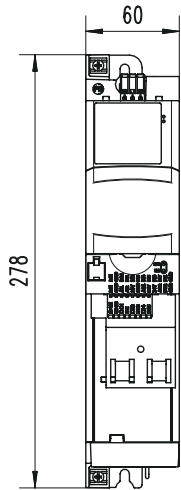

8800265



1.1 kW ... 4 kW

The dimensions in mm apply to:

1.1 kW	i550-C1.1/230-1	i550-C1.1/230-2	i550-C1.1/400-3
1.5 kW	i550-C1.5/230-1	i550-C1.5/230-2	i550-C1.5/400-3
2.2 kW	i550-C2.2/230-1	i550-C2.2/230-2	i550-C2.2/400-3
3 kW			i550-C3.0/400-3
4 kW			i550-C4.0/400-3

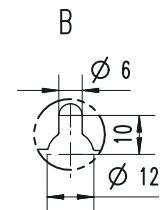
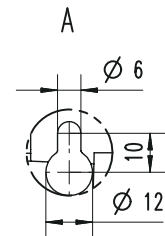
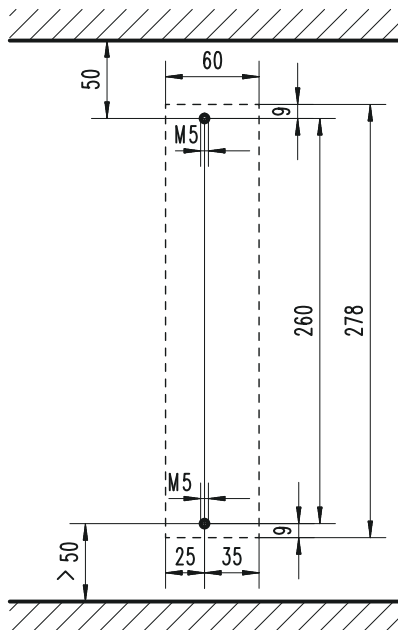
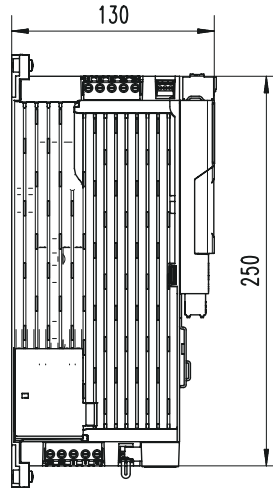
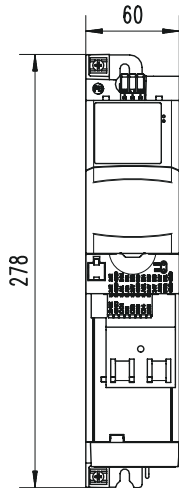

8800265

Technical data

Dimensions



5.5 kW

The dimensions in mm apply to:

5.5 kW	i550-C5.5/230-3	i550-C5.5/400-3
--------	-----------------	-----------------

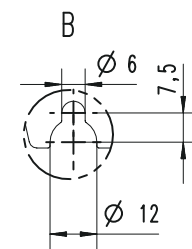
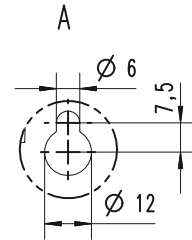
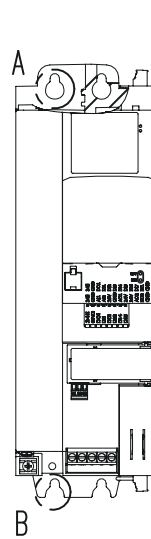
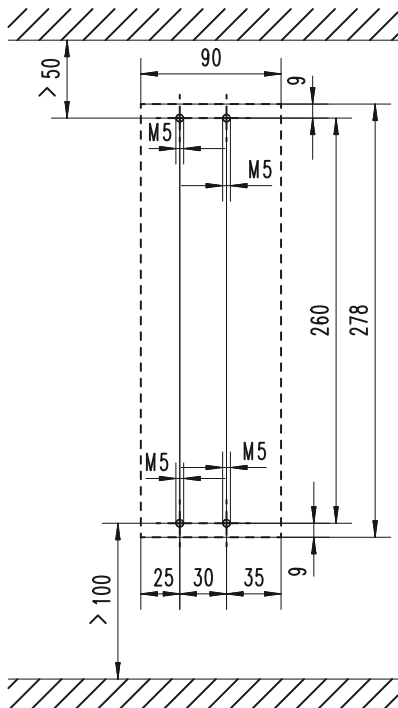
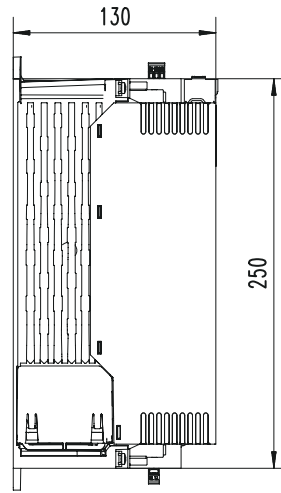
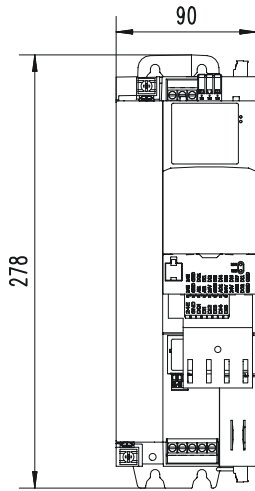

8800288



Technical data

Dimensions

7.5 kW ... 11 kW

The dimensions in mm apply to:

7.5 kW	i550-C7.5/400-3
11 kW	i550-C11/400-3

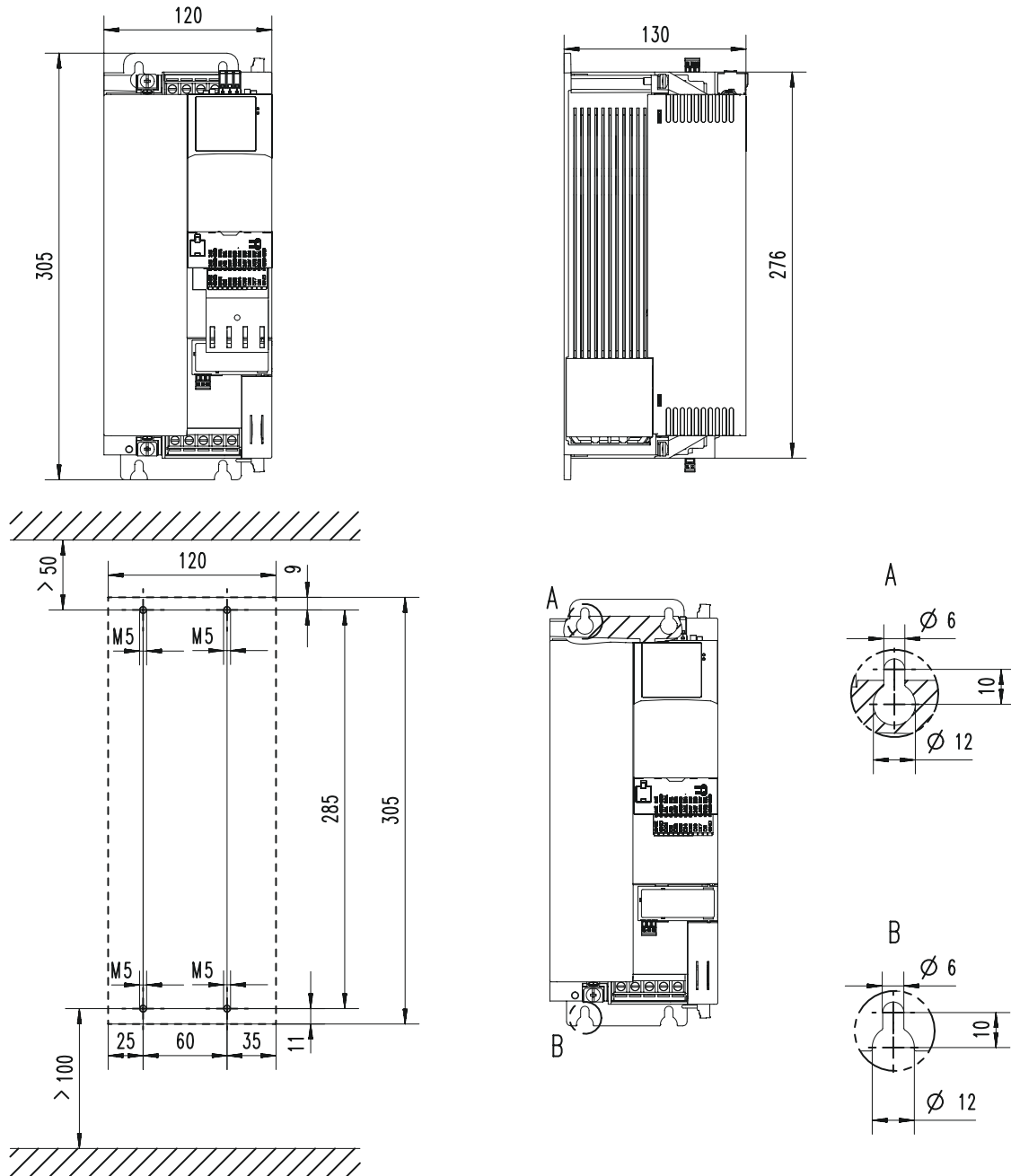

8800296

Technical data

Dimensions



15 kW ... 22 kW

The dimensions in mm apply to:

15 kW	i550-C15/400-3
18.5 kW	i550-C18/400-3
22 kW	i550-C22/400-3

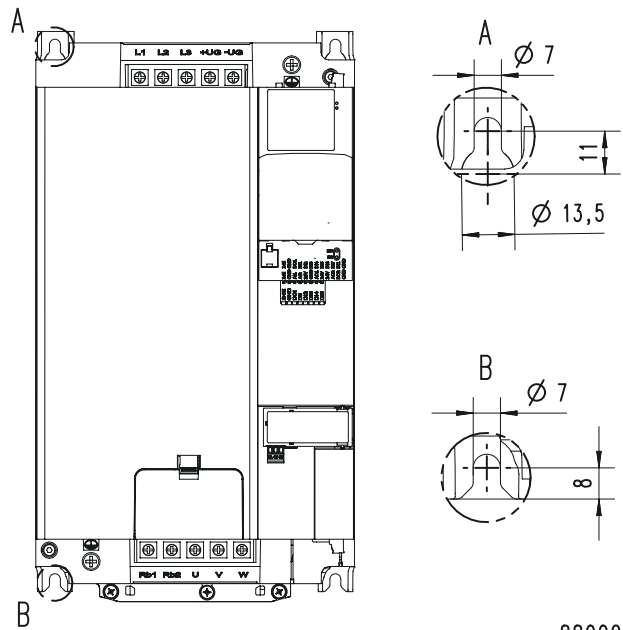
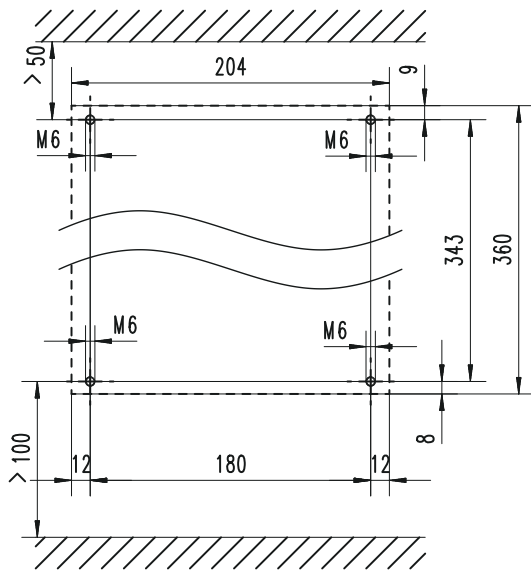
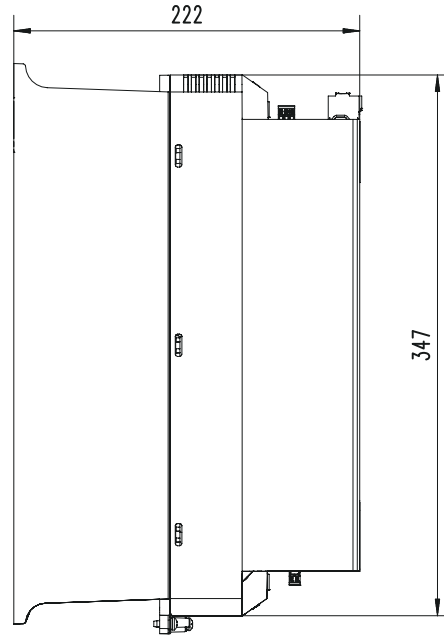
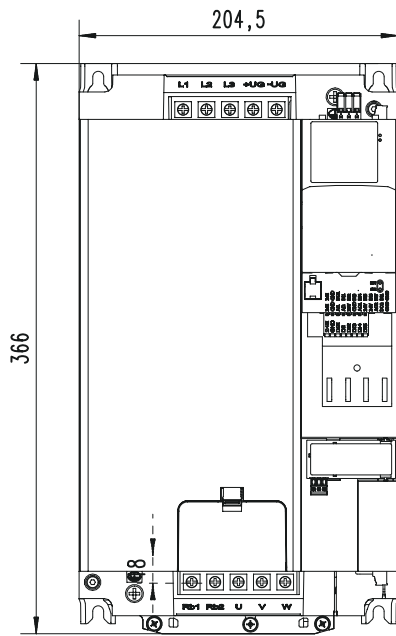

8800297



Technical data

Dimensions

30 kW ... 45 kW

The dimensions in mm apply to:

30 kW	i550-C30/400-3
37 kW	i550-C37/400-3
45 kW	i550-C45/400-3

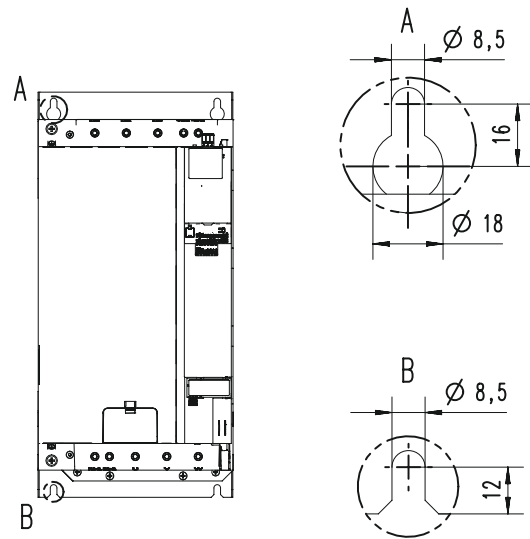
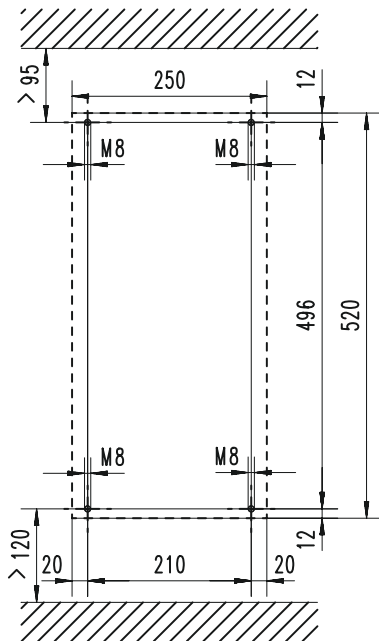
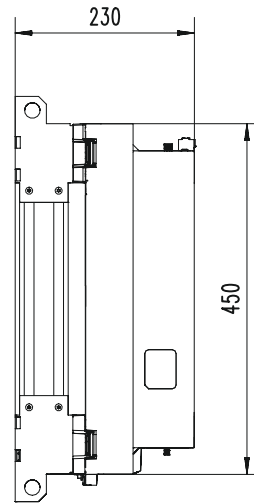
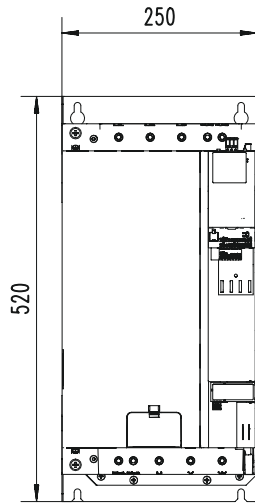

8800313

Technical data

Dimensions



55 kW ... 75 kW

The dimensions in mm apply to:

55 kW	i550-C55/400-3
75 kW	i550-C75/400-3

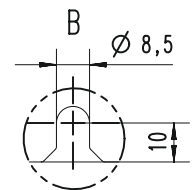
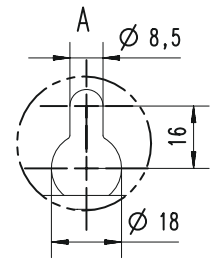
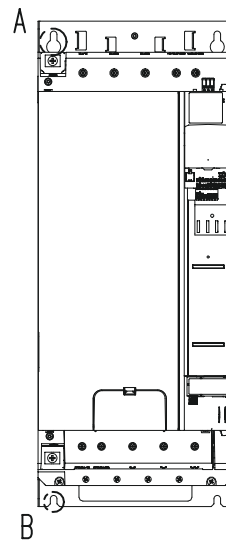
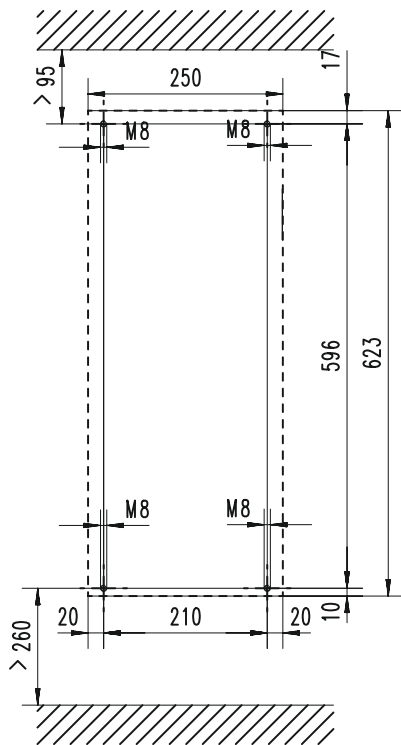
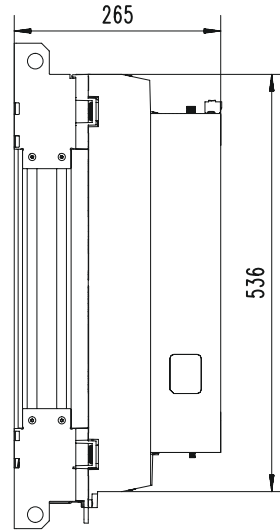
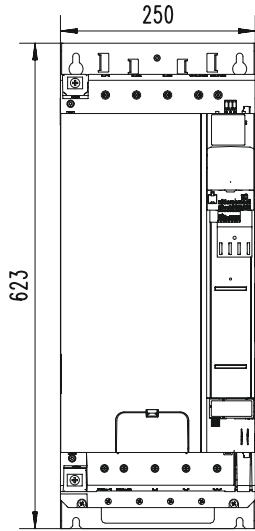

8800315



Technical data

Dimensions

90 kW ... 110 kW

The dimensions in mm apply to:

90 kW	i550-C90/400-3
110 kW	i550-C110/400-3

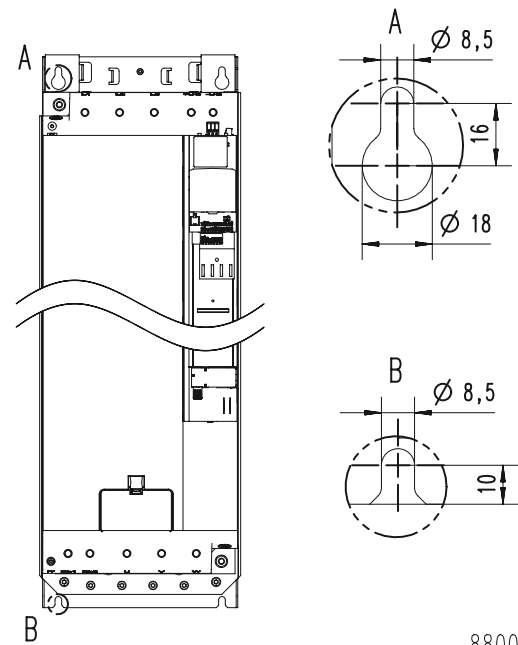
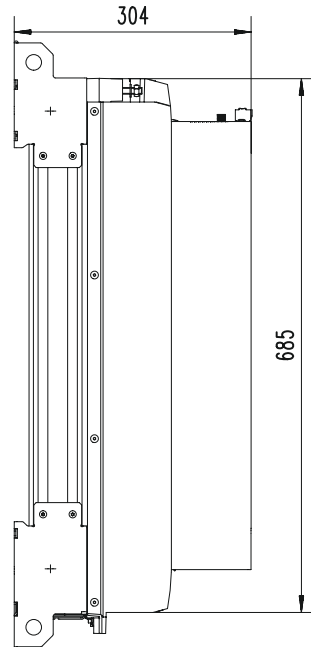
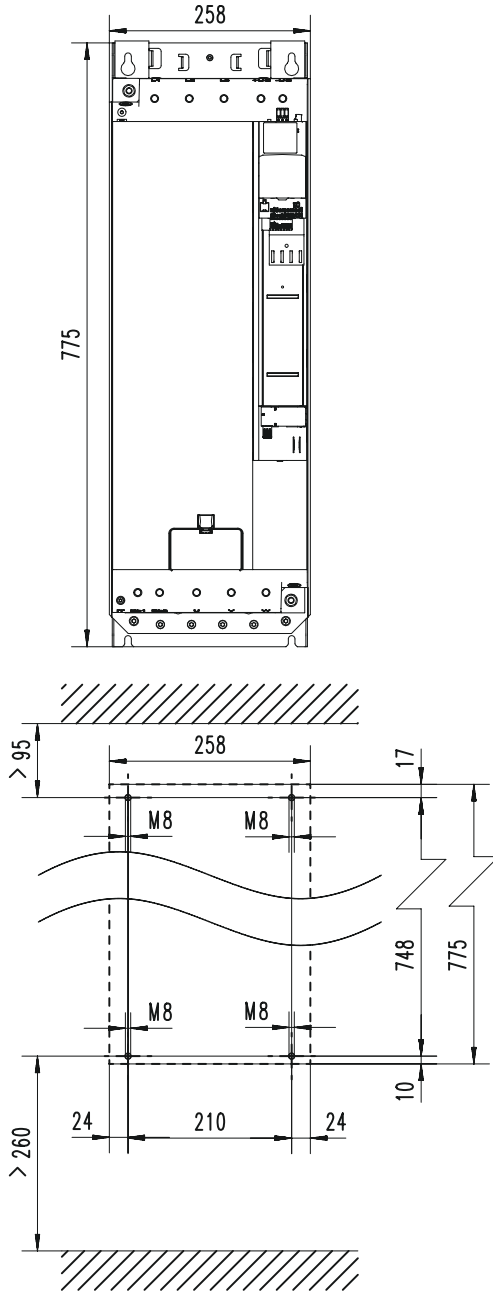

8800536

Product extensions

Overview



Product extensions

Overview

The inverters can easily be integrated into the machine. The scalable product extensions serve to flexibly match the required functions to your application.

The control unit with standard I/O can be extended with different networks.

The control unit with application I/O provides additional inputs and outputs (I/Os). A network component is not available.

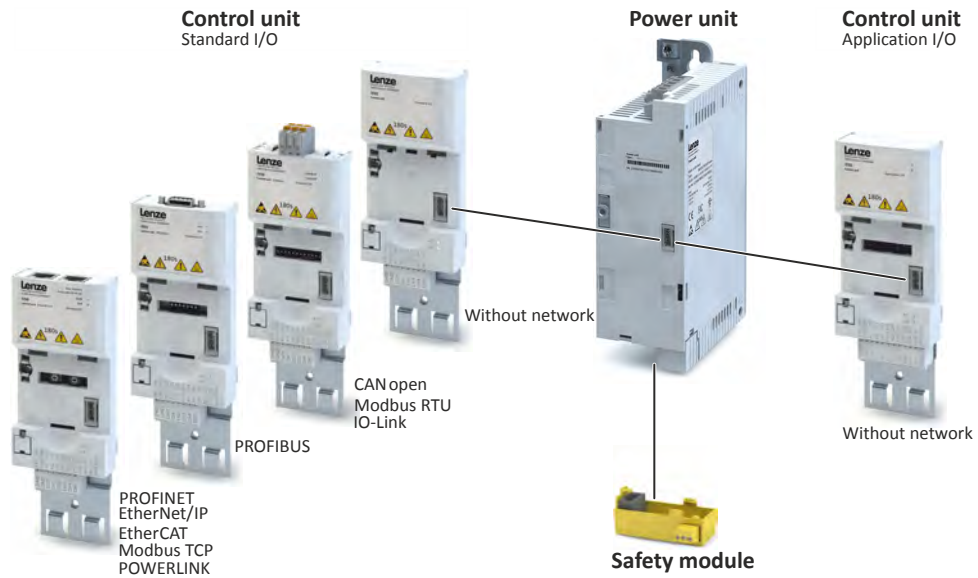



Product extensions

I/O extensions
Standard I/O

I/O extensions

Standard I/O

The standard I/O provides the inverter with analog and digital inputs and outputs and is designed for standard applications. The standard I/O is available with different networks.

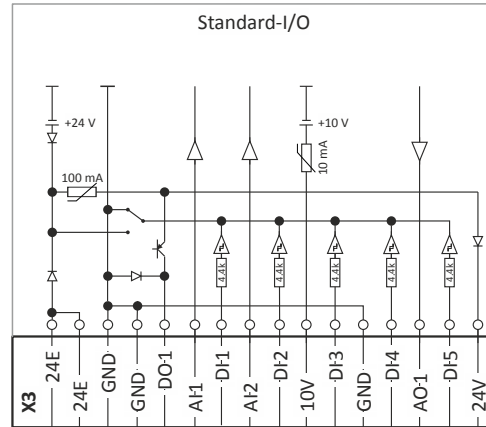

Digital inputs	Terminal X3: DI1, DI2, DI3, DI4, DI5	DI3/DI4 can be optionally used as frequency or encoder input. HIGH active/LOW active switchable
Digital outputs	Terminal X3: DO1	
Analog inputs	Terminal X3: AI1, AI2	Can be optionally used as voltage or current input.
Analog outputs	Terminal X3: AO1	Can be optionally used as voltage or current output.
24-V input	Terminal X3: 24E	Mains-independent DC supply of the control electronics (incl. communication)
10-V output	Terminal X3: 10V	Reference voltage for setpoint potentiometer
24-V output	Terminal X3: 24V	
Reference potential	Terminal X3: GND	
Connection system	Pluggable spring terminal	

Product extensions

I/O extensions
Application I/O



Application I/O

In addition to the standard I/O, the application I/O provides the inverter with more digital and analog inputs and is intended for individual applications. The combination with network components is not available.

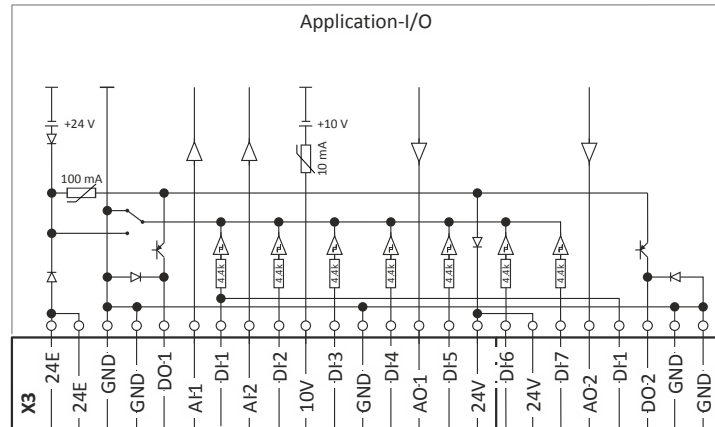

Digital inputs	Terminal X3: DI1, DI2, DI3, DI4, DI5, DI6, DI7	DI3/DI4 can be optionally used as frequency or encoder input. HIGH active/LOW active switchable
Digital outputs	Terminal X3: DO1, DO2	
Analog inputs	Terminal X3: AI1, AI2	can be optionally used as voltage or current input.
Analog outputs	Terminal X3: AO1, AO2	Can be optionally used as voltage or current output.
24-V input	Terminal X3: 24E	Mains-independent DC supply of the control electronics (incl. communication)
10-V output	Terminal X3: 10V	Reference voltage for setpoint potentiometer
24-V output	Terminal X3: 24V	
Reference potential	Terminal X3: GND	
Connection system	Pluggable spring terminal	



Product extensions

I/O extensions
Data of control connections

Data of control connections

Digital inputs

Switching type		PNP, NPN	Parameterisable
PNP switching level			
LOW	V	< +5	IEC 61131-2, type 1
HIGH	V	> +15	
NPN switching level			
LOW	V	> +15	
HIGH	V	< +5	
Input resistance	kΩ	4.6	
Cycle time	ms	1	
Electric strength of external voltage	V	± 30	

Frequency input			
Connection		X3/DI3, X3/DI4	
Frequency range	kHz	0 ... 100	

Encoder input			
Type		Incremental HTL encoder	
Two-track connection		X3/DI3 X3/DI4	Track A Track B
Frequency range	kHz	0 ... 100	

Digital outputs

Switching level			
LOW	V	< +5	IEC 61131-2, type 1
HIGH	V	> +15	
max. output current	mA	100	Total current for DO1 and 24V
Cycle time	ms	1	
Short-circuit strength		Unlimited period	
Electric strength of external voltage	V	± 30	
Polarity reversal protection		Integrated freewheeling diode for switching the inductive load	
Overload behaviour		Reduced voltage or periodic switch-off/on	
Reset or switch-on behaviour		Output is switched off	LOW

Product extensions

I/O extensions
Data of control connections



Analog inputs

Cycle time	ms	1	
Resolution of A/D converter	Bit	12	
Operation as voltage input			
Connection designation		X3/AI1, X3/AI2	
Input voltage DC	V	-10 ... 10	
Input resistance	kΩ	70	
Accuracy	mV	± 50	Typical
Input voltage in case of open circuit	V	- 0.2 ... 0.2	Display "0"
Electric strength of external voltage	V	± 24	
Operation as current input			
Connection designation		X3/AI1, X3/AI2	
Input current	mA	0 ... 20 4 ... 20	open-circuit monitored
Accuracy	mA	± 0.1	Typical
Input current in case of open circuit	mA	< 0.1	Display "0"
Input resistance	Ω	< 250	
Electric strength of external voltage	V	± 24	

Analog outputs

Short-circuit strength		Unlimited period	
Electric strength of external voltage	V	+ 24V	
Operation as voltage output			
Resolution of D/A converter	Bit	12	
Output voltage DC	V	0 ... 10	
max. output current	mA	5	
min. load resistance	kΩ	≥ 2.2	
max. capacitive load	μF	1	
Accuracy	mV	± 100	Typical
Operation as current output			
Output current	mA	0 ... 20 4 ... 20	open-circuit monitored
Accuracy	mA	± 0.3	Typical

10-V output

Use		Primarily for the supply of a potentiometer (1 ... 10 kΩ)	
Output voltage DC			
Typical	V	10	
Accuracy	mV	± 100	
Max. output current	mA	10	
Max. capacitive load	μF	1	
Short-circuit strength		Unlimited period	
Electric strength of external voltage	V	+ 24	



Product extensions

I/O extensions
Data of control connections

24-V input

Use		Input for mains-independent DC supply of the control electronics (incl. communication)	
Input voltage DC			
Typical	V	24	IEC 61131-2
Area	V	19.2 ... 28.8	
Input power			
Typical	W	3.6	
Max.	W	6	Depending on the use and state of inputs and outputs.
Input current			
Typical	A	0.150	
Max.	A	1.0	When switching on for 50 ms
Capacity to be charged	µF	440	
Polarity reversal protection		When polarity is reversed: No function and no destruction	
Suppression of voltage pulses		Suppressor diode 30 V, bidirectional	
Power supply unit		SELV/PELV	Externally to create a mains-independent DC supply
Max. current	A	8.0	While looping-through

24-V output

Use		Primarily for the supply of digital inputs	
Output voltage DC			
Typical	V	24	
Area	V	16 ... 28	
max. output current	mA	100	Total current for DO... and 24V
Short-circuit strength		Unlimited period	
Electric strength of external voltage	V	+ 30	
Excess current release		Automatically resettable	

Product extensions

Further control connections
Relay output



Further control connections

Connection description		Relay output
Connection		X9
Connection type		Pluggable screw terminal
Max. Cable cross-section	mm ²	1.5
Max. Cable cross-section	AWG	14
Stripping length	mm	6
Stripping length	inch	0.24
Tightening torque	Nm	0.2
Tightening torque	lb-in	1.8
Required tool		0.4 x 2.5

Relay output



Use a corresponding suppressor circuit in case of an inductive or capacitive load!

Connection		Terminal X9: COM	Common contact (Common)
		Terminal X9: NC	Normally closed contact
		Terminal X9: NO	Normally open contact
Minimum DC contact load			
	Voltage	V	10
	Current	mA	10
A correct switching of the relay contacts needs both values to be exceeded simultaneously.			
Switching voltage/switching current			
Maximum	AC 240 V	A	3
	24 V DC	A	2
	240 V DC	A	0.16
		According to UL: General Purpose	
		According to UL: Resistive	

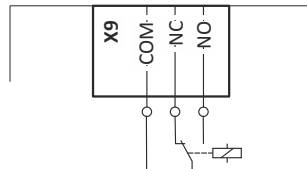

PTC input



In the Lenze setting, motor temperature monitoring is activated! In the delivery status, there is a wire jumper between the terminals T1 and T2. Before connecting a thermal sensor, remove the wire jumper.

Use	Connection of PTC or thermal contact
Connection	Terminal X109: T1 Terminal X109: T2
Sensor types	PTC single sensor (DIN 44081) PTC triple sensor (DIN 44082) Thermal contact

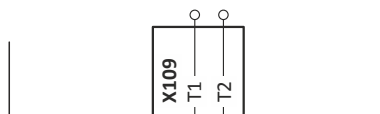



Networks

CANopen

CANopen is an internationally approved communication protocol which is designed for commercial and industrial automation applications. High data transfer rates in connection with efficient data formatting provide for the coordination of motion control devices in multi-axis applications.

General information			
Design		Optional Integrated in standard I/O	
DC supply of the control electronics and optional fieldbus		Internally via the inverter	Mains-dependent
		Optionally: External supply	Mains-independent 24 V DC at X3/24E...GND

Bus-related information			
Name		CANopen CiA 301 V4.2.0	
Communication medium		CAN cable in accordance with ISO 11898-2	
Use		Connection of the inverter to a CANopen network	
Connection system		Pluggable double spring terminal	
Status display		2 LEDs	
Connection designation		X216: CH, CL, CG	

Technical data			
Bus terminating resistor	Ω	120	Terminated on both sides
integrated bus terminating resistor		Yes	Activation via DIP switch
Network topology			
without repeater		Line	
with repeater		Line or tree	
Station			
Type		Slave	
Max. number without repeater		127	per bus segment, incl. host system
Address		1 ... 127	Adjustable via code or DIP switch
Baud rate	kbps	20, 50, 125, 250, 500, 800 or 1000	Adjustable via code or DIP switch
Max. bus length	m	2500, 1000, 500, 250, 100, 50 or 25	Total cable length depends on the baud rate
Max. cable length between two nodes		not limited, the max. bus length is decisive	
Process data			
Transmit PDOs		3 TPDOs with 1 ... 8 bytes (adjustable)	
Receive PDOs		3 RPDOs with 1 ... 8 bytes (adjustable)	
Transmission mode for TPDOs			
With change of data		Yes	
Time-controlled, multiple of	ms	10	
After reception		1 ... 240 sync telegrams	
Parameter data			
SDO channels		Max. 2 servers	

Communication time			
Communication time depends on		Processing time in the inverter	Time between the start of a request and arrival of the response
		Telegram runtime (baud rate, telegram length)	
		Nesting depth of the network	
		Bus load	

Product extensions

Networks
CANopen



Processing time of process data			
Update cycle	ms	10	In the inverter
Processing time	ms	0 ... 1	
Application task runtime of the technology application used (tolerance)	ms	1 ... x	
Other data			
Note		There are no interdependencies between parameter data and process data.	



EtherCAT

EtherCAT® (Ethernet for Controller and Automation Technology) is an Ethernet-based fieldbus system which fulfils the application profile for industrial plant systems.

General information			
Design		Optional Integrated in standard I/O	
DC supply of the control electronics and optional fieldbus		Internally via the inverter	Mains-dependent
		Optionally: External supply	Mains-independent 24 V DC at X3/24E...GND

Connection description		EtherCAT	
Connection		X246	X247
Connection type		RJ45	

Bus-related information			
Name		EtherCAT	
Communication medium		Ethernet 100 Mbps, full duplex	
Use		Connection as EtherCAT slave	
Status display		2 LEDs (RUN, ERR)	
Connection designation		IN: X246 OUT: X247	

Technical data			
Communication profile		EtherCAT	
		CANopen over EtherCAT (CoE)	
Bus terminating resistor		Not required	
Integrated bus terminating resistor		No	
Network topology			
Without repeater		Line, tree, star	
With repeater		-	
Node			
Type		EtherCAT slave	
Max. Number		65535	In the entire network
Address		Automatically allocated by the master	
Max. cable length	m	Not limited	The length between the nodes is decisive.
Max. cable length between two nodes	m	100	
Process data			
Transmit PDOs		0-16 double words	Max. 64 bytes
Receive PDOs		0-16 double words	
Cycle time	ms	Integer multiple of 1 ms	

Communication time			
Communication time depends on		Processing time in the inverter	Time between the start of a request and arrival of the response
		Telegram runtime (baud rate, telegram length)	
		Nesting depth of the network	
		Bus load	

Processing time of process data			
Update cycle	ms	1	In the inverter
Processing time	ms	0 ... 1	
Application task runtime of the technology application used (tolerance)	ms	1 ... x	

Other data			
Note		There are no interdependencies between parameter data and process data.	

Product extensions

Networks
EtherNet/IP



EtherNet/IP

EtherNET/IP is a common fieldbus for the connection of inverters to different control systems in plants.

General information			
Design		Optional Integrated in standard I/O	
DC supply of the control electronics and optional fieldbus		Internally via the inverter	Mains-dependent
		Optionally: External supply	Mains-independent 24 V DC at X3/24E...GND

Connection description		EtherNet/IP	EtherNet/IP
Connection		X266	X267
Connection type		RJ45	

Technical data			
Communication profile		EtherNet/IP	
		AC Drive	
Bus terminating resistor		Not required	
integrated bus terminating resistor		No	
Network topology			
Without repeater		Tree, star and line	
With repeater		-	
Station			
Type		Adapter (slave)	
Max.number		254	Per subnetwork
Address		Station name	
Max. cable length	m	-	Not limited The length between the nodes is decisive.
Max. cable length between two nodes	m	100	
Process data			
Transmit PDOs		16 words	Max. 32 bits (4 bytes) as a coherent PDO object
Receive PDOs		16 words	
Cycle time	ms	> 4	
Switching method		Store-and-Forward Cut-Through	
Switch latency	µs	~ 125	At maximum telegram length
Other data		Additional TCP/IP channel	

Communication time			
Communication time depends on		Processing time in the inverter	Time between the start of a request and arrival of the response
		Telegram runtime (baud rate, telegram length)	
		Nesting depth of the network	
		Bus load	

Processing time of process data			
Update cycle	ms	1	In the inverter
Processing time	ms	0 ... 1	
Application task runtime of the technology application used (tolerance)	ms	1 ... x	

Other data			
Note		There are no interdependencies between parameter data and process data.	



Modbus RTU

Modbus is an internationally approved, asynchronous, serial communication protocol, designed for commercial and industrial automation applications.

General information			
Design		Optional Integrated in standard I/O	
DC supply of the control electronics and optional fieldbus		Internally via the inverter	Mains-dependent
		Optionally: External supply	Mains-independent 24 V DC at X3/24E...GND

Bus-related information			
Name		Modbus RTU	
Communication medium		RS485 (EIA)	
Use		Connection of the inverter to a Modbus network	
Connection system		pluggable double spring terminal	
Status display		2 LEDs	
Connection designation		X216: TA, TB, COM	

Technical data			
Communication profile		Modbus RTU	
Bus terminating resistor	Ω	120	Terminated on both sides
Integrated bus terminating resistor		Yes	Activation via DIP switch
Network topology			
Without repeater		Line	
Station			
Type		Slave	
Max. number without repeater		32	Per bus segment, incl. host system
Max. number with repeater		90	
Address		1 ... 247	Adjustable via code or DIP switch
Transfer rate	kbps	4.8 ... 115	Adjustable via code or DIP switch, alternatively automatic detection via DIP switch can be activated
Max. cable length	m	12 ... 600	Per bus segment, depending on the transfer rate and the cable type used
Max. cable length between two nodes		not limited, the max. bus length is decisive	
Data channel			
SDO channels		Max. 2 servers, with 1 ... 8 bytes	Supported functions: Read Holding Registers Preset Single Register Preset Multiple Registers Read/Write 4 x registers

Communication time			
Communication time depends on		Processing time in the inverter	Time between the start of a request and arrival of the response
		Telegram runtime (baud rate, telegram length)	
		Nesting depth of the network	
		Bus load	

Processing time of process data			
Update cycle	ms	1	In the inverter
Processing time	ms	0 ... 1	
Application task runtime of the technology application used (tolerance)	ms	1 ... x	

Product extensions

Networks
Modbus TCP



Other data			
Note		There are no interdependencies between parameter data and process data.	

Modbus TCP

Modbus is an internationally approved Ethernet-based communication protocol, designed for commercial and industrial automation applications.

General information			
Design		Optional Integrated in standard I/O	
DC supply of the control electronics and optional fieldbus		Internally via the inverter	Mains-dependent
		Optionally: External supply	Mains-independent 24 V DC at X3/24E...GND

Connection description		Modbus TCP	
Connection		X276	X277
Connection type		RJ45	

Technical data			
Communication profile		Modbus/TCP	
Bus terminating resistor		Not required	
integrated bus terminating resistor		No	
Network topology			
Without repeater		Tree, star and line	
With repeater		-	
Station			
Type		Adapter (slave)	
Max. Number		254	Per subnetwork
Address		Station name	
Max. Cable length	m	-	Not limited The length between the nodes is decisive.
Max. Cable length between two nodes	m	100	
Process data			
Transmit PDOs		256 bytes	
Receive PDOs		256 bytes	
Cycle time	ms	> 4	
Switching method		-	
Switch latency	µs	~ 125	At maximum telegram length
Other data		Additional TCP/IP channel	

Communication time			
Communication time depends on		Processing time in the inverter	Time between the start of a request and arrival of the response
		Telegram runtime (baud rate, telegram length)	
		Nesting depth of the network	
		Bus load	

Processing time of process data			
Update cycle	ms	1	In the inverter
Processing time	ms	0 ... 1	
Application task runtime of the technology application used (tolerance)	ms	1 ... x	

Other data			
Note		There are no interdependencies between parameter data and process data.	



Product extensions

Networks
POWERLINK

POWERLINK

Ethernet POWERLINK is a common fieldbus for the connection of inverters to different control systems in plants.

General information			
Design		Optional Integrated in standard I/O	
DC supply of the control electronics and optional fieldbus		Internally via the inverter	Mains-dependent
		Optionally: External supply	Mains-independent 24 V DC at X3/24E...GND

Connection description		POWERLINK	POWERLINK
Connection		X286	X287
Connection type		RJ45	

Technical data			
Communication profile		POWERLINK	
		AC Drive	
Bus terminating resistor		Not required	
integrated bus terminating resistor		No	
Network topology			
Without repeater		Tree, star and line	
With repeater		-	
Station			
Type		Adapter (controlled node, CN)	
Max. Number		240	
Address		Station name	
Max. Cable length	m	-	Not limited The length between the nodes is decisive.
Max. Cable length between two nodes	m	100	
Process data			
Transmit PDOs		4 words	Max. 16 bits (2 bytes) as a coherent PDO object
Receive PDOs		2 words	
Cycle time	ms	Multiple of 0.4 ms and 0.5 ms	
Other data		Additional TCP/IP channel	

Communication time			
Communication time depends on		Processing time in the inverter	Time between the start of a request and arrival of the response
		Telegram runtime (baud rate, telegram length)	
		Nesting depth of the network	
		Bus load	

Processing time of process data			
Update cycle	ms	1	In the inverter
Processing time	ms	0 ... 1	
Application task runtime of the technology application used (tolerance)	ms	1 ... x	

Other data			
Note		There are no interdependencies between parameter data and process data.	

Product extensions

Networks
PROFIBUS



PROFIBUS

PROFIBUS is a common fieldbus for the connection of inverters to different control systems in plants.

General information			
Design		Optional Integrated in standard I/O	
DC supply of the control electronics and optional fieldbus		Internally via the inverter	Mains-dependent
		Optionally: External supply	Mains-independent 24 V DC at X3/24E...GND

Bus-related information			
Name		PROFIBUS-DP	
Communication medium		RS485	
Use		Connection of the inverter to a PROFIBUS-DP network	
Connection system		9-pole Sub-D socket	
Status display		2 LEDs	
Connection designation		X226: Pin 1 ... 9	

Technical data			
Communication profile		PROFIBUS-DP-V0	DRIVECOM parameter data channel
		PROFIBUS-DP-V1	PROFIdrive parameter data channel
Bus terminating resistor	Ω	120	Terminated on both sides
integrated bus terminating resistor		No	
Network topology			
Without repeater		Line	
With repeater		-	
Station			
Type		Slave	
Max. Number without repeater		32	per bus segment, incl. host system
Max. Number with repeater		125	
Address		1 ... 127	Adjustable via code or DIP switch
Transfer rate	kbps	9.6 ... 12000	Automatic detection for cable type A (EN 50170)
Max. Bus length	m	1200	Per bus segment, depending on the transfer rate and the cable type used
Max. Cable length between two nodes		not limited, the max. bus length is decisive	
Process data			
PZD		1 ... 16 words (16 bits/word) per direction	Max. 32 bits (4 bytes) as a coherent PDO object
Transmission mode			
Data length, cyclic		1 ... 16 words, process data channel + 4 words of disconnectable parameter data channel	
Identification number		0x0E550	
User data			
Cyclic (DP-V0)		4 bytes	
Acyclic (DP-V1)		Max. 240 bytes	

Communication time			
Communication time depends on		Processing time in the inverter	Time between the start of a request and arrival of the response
		Telegram runtime (baud rate, telegram length)	
		Nesting depth of the network	
		Bus load	



Product extensions

Networks
PROFINET

Processing time of process data			
Update cycle	ms	1	In the inverter
Processing time	ms	0 ... 1	
Application task runtime of the technology application used (tolerance)	ms	1 ... x	

Other data			
Note		There are no interdependencies between parameter data and process data.	

PROFINET

PROFINET is a common fieldbus for the connection of inverters to different control systems in plants.

General information			
Design		Optional Integrated in standard I/O	
DC supply of the control electronics and optional fieldbus		Internally via the inverter	Mains-dependent
		Optionally: External supply	Mains-independent 24 V DC at X3/24E...GND

Connection description	PROFINET		
Connection		X257	X256
Connection type		RJ45	

Technical data			
Communication profile		PROFINET RT	
Bus terminating resistor		Not required	
Integrated bus terminating resistor		Yes	
Network topology			
Without repeater		Tree, star and line	
With repeater		-	
Device			
Type		IO device with real time (RT) communication properties Conformance Class B	
Max. number		255	Per subnetwork
Address		Station name	
Max. cable length	m	Not limited	The length between the devices is decisive.
Max. cable length between two devices	m	100	
Process data	Byte	4, 8, 12, 16, 20, 24, 28, 32, ... 64	
Cycle time	ms	1, 2, 4, 8, 16	
Switching method		Cut-through	
Other data		Additional TCP/IP channel	

Other data			
Note		There are no interdependencies between parameter data and process data.	

Product extensions

Networks
IO-Link



IO-Link

IO-Link is the standardized IO technology (IEC 61131-9) for communication with sensors and actuators. Point-to-point communication is based on the 3-wire sensor and actuator connection without additional requirements concerning the cable material.

General information			
Design		Optional Integrated in standard I/O	
DC supply of the control electronics and optional fieldbus		Internally via the inverter	Mains-dependent
		Optionally: External supply	Mains-independent 24 V DC at X3/24E...GND

Information			
Name		IO-Link V 1.1	
Communication medium		Unshielded 3-wire standard cables	
Use		Connection of inverter to an I/O master	
Connection system		Pluggable double spring terminal	
Status display		1 LED	
Connection designation		X316: L+, C/Q, L-	

Technical data			
Topology			
Master - slave		Tree (point to point)	
Station			
Type		Slave	
Master - slave		1:1	
Baud rate	kBaud/s	230.4	COM3
Max. Length	m	20	
Max. Cable length between IO-Link master and IO-Link slave (i550)		20	
Process data			
Input		12 bytes (fix)	
Output		12 bytes (fix)	

Processing time of process data			
Cycle time	ms	2	



Functional safety

General information and basics

The functional safety describes the necessary measures that need to be taken by means of electrical or electronic equipment to prevent or eliminate dangers due to functional errors.

Protective devices prevent any human access to dangerous areas during normal operation. However, persons may have to be in the danger areas in certain operating modes. The machine operator is protected by internal drive and control measures in these operating modes.

Integrated safety

Integrated safety provides the conditions in the controls and drives to implement protective functions. Planning and installation expenditure is reduced. Using integrated safety increases machine functionality and availability. Integrated safety can be used for the protection of persons working on machines in accordance with the Machinery Directive.

Integrated safety provides safe inputs. If the STO safety function is requested, the safety system immediately brings about the torque-free state according to EN 61800-5-2.

Standards

Safety regulations are confirmed by laws and other governmental guidelines and measures and the prevailing opinion among experts, e.g. by technical regulations.

The regulations and rules to be applied must be observed in accordance with the application.

Risk assessment

This documentation can only accentuate the need for a risk assessment. The user of the integrated safety system must read up on standards and the legal situation.

Before a machine can be put into circulation, the manufacturer of the machine has to conduct a risk assessment according to the 2006/42/EU: Machinery Directive to determine the hazards associated with the use of the machine.

The Machinery Directive refers to three basic principles for the highest possible level of safety:

- Hazard elimination / minimisation by the construction itself.
- Taking the protective measures required against hazards that cannot be removed.
- Existing residual hazards must be documented and the user must be informed of them.

Detailed information on the risk assessment is provided in the DIN EN ISO 12100:2013-08: Safety of machinery – general principles for design – risk assessment and risk reduction . The result of the risk assessment determines the category for safety-related control systems according to EN ISO 13849-1. Safety-oriented parts of the machine control must be compliant.

Mission time

The mission time of the used components must be complied with.

In case of a defect or when the mission time of a component has expired, the complete component must be replaced. Continued operation is not permitted!



The mission time for the safety functions cannot be reset by a special proof test.

The specified mission time starts at the date of manufacture.

Mission time ► [Rated data](#) 184

Product extensions



Functional safety
General information and basics



i550-Cabinet

- If you have mounted the safety module yourself, you must observe the manufacturing date of the safety module and the manufacturing date of the device.
- If you have a completely mounted device, you only have to observe the manufacturing date of the device.

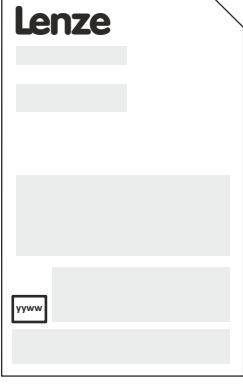
The manufacturing date can be found on the nameplate of the respective component:

Manufacturing date of the device	Manufacturing date of the safety module
	
yyww = year of manufacture and week of manufacture (1841 = CW 41 2018)	

Identification of the components

Safety components and the respective terminals are yellow.

Restart

⚠ DANGER!

The drive can automatically restart if the request of the safety function is deactivated.

Possible consequence: Death or severe injuries

- ▶ You must provide external measures according to EN ISO 13849-1 which ensure that the drive only restarts after a confirmation.



Safety sensors

The components used must comply with the risk reduction required for the application.

Active sensors

Active sensors are units with 2-channel semiconductor outputs (OSSD outputs).

Test pulses for monitoring the outputs and lines are permissible.

P/M-switching sensors switch the positive and negative cable or the signal and ground cable of a sensor signal.

Please note the following:

- The maximum permissible connection capacity of the outputs.
- Active sensors are connected directly to the terminal strip, see section "Active sensor connection".
- Monitoring for short circuits must be carried out by the active sensor.

The outputs have to switch simultaneously (equivalently). Safety functions will be activated if only one channel is switched. Active triggering of only one channel points to faulty sensors or impermissible wiring.

Examples of active sensors:

- Lightgrid
- Laser scanner
- Control systems

Passive sensors

Passive sensors are 2-channel switching elements with contacts.

Please note the following:

- The switches must be wired according to the closed-circuit principle.
- Passive sensors are connected to the terminal strip via a safety switching device, see section "Passive sensor connection".
- An external safety component must monitor the connecting cables and the function of the sensors if complete exclusion of faults cannot be guaranteed.

The contacts must switch at the same time (equivalent). Safety functions will be activated if only one channel is switched. Switching of only one channel points to faulty sensors or impermissible wiring.

Examples of passive sensors:

- Door contact switch
- Emergency stop control units

Product extensions

Functional safety
Safety functions



Safety functions

Supported safety functions for "Basic Safety-STO"

▶ [Safe torque off \(STO\)](#)  181



Safe torque off (STO)

The motor cannot generate torque and movements of the drive.

⚠ DANGER!

With the "Safe torque off" (STO) function, no "emergency-off" in terms with EN 60204-1

Possible consequence: Death or severe injuries

► "Emergency-off" requires electrical isolation, e. g. by a central mains contactor.

⚠ DANGER!

Automatic restart if the request of the safety function is deactivated.

Possible consequences: Death or severe injuries

► You must provide external measures according to EN ISO 13849-1 which ensure that the drive only restarts after a confirmation.

⚠ DANGER!

The power supply is not safely disconnected.

Death or serious injury due to electrical voltage.

► Turn off the power supply.

Functional description

How to safely disconnect the drive:

1. A safety sensor requests the safety function.
2. The transmission of the pulse width modulation is safely switched off by the safety unit.
The power drivers do not generate a rotating field anymore.
3. The inverter switches to the STO active device status (status word 0x6041, Bit15 = 0).
The motor is safely switched to torqueless operation (STO).

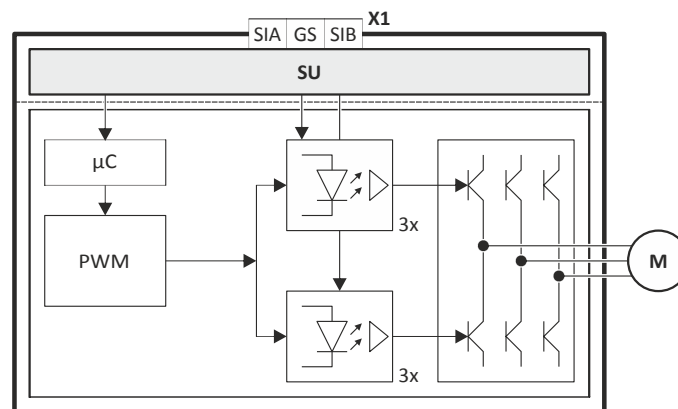

Fig. 11: Functional principle: Basic Safety - STO

X1	Control terminals of the safety unit	PWM	Pulse width modulation
SU	Hardware interface	M	Motor
µC	Microcontroller		

Product extensions

Functional safety
Safety functions



Functional diagram

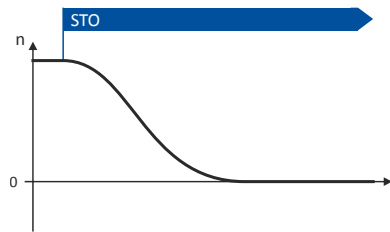

Fig. 12: Safety function STO



Functional sequence and error response have no adjustable parameters.

Truth table

Safe input / channel		Inverter	Inverter status word 0x282A:004		CiA status word
SIA	SIB	Device state	Bit 10	Bit 11	Object 0x6041, bit 15
LOW	LOW	STO active	1	1	0
LOW	HIGH	Impermissible state, drive disabled	1	0	0
HIGH	LOW		1	0	0
HIGH	HIGH	Drive enabled	0	0	1



If the GS connection is interrupted, or in case of a short circuit/cross-circuit of GS to SIA/SIB, STO is active.



If SIA = LOW and SIB = LOW, the internal "Safe torque off (STO) active [55]" status signal in the inverter is set to TRUE. You can use this status signal to control a "non-safe output" (e.g. the relay).



Acceptance

The machine manufacturer must check and prove the operability of the safety functions used.

- The machine manufacturer must authorise a person with expertise and knowledge of the safety functions to carry out the test.
- The test result of every safety function must be documented and signed by the inspector.

A complete test comprises the following:

- Documenting the plant including the safety functions:
 - Creating an overview screen of the plant.
 - Describing the plant.
 - Describing the safety equipment.
 - Documenting the safety functions used.
 - Checking the function of the safety functions used.
- Preparing the test report:
 - Documenting the functional test.
 - Checking the parameters.
 - Signing the test report.
- Preparing the appendix with test records:
 - Protocols for the plant
 - External recording



The tester must repeat the test after each change and record the results in the test report.

Periodic inspections

After installation and after every modification, the user must check and validate the safety function.

The user must document these tests.

The correct sequence of the safety-oriented functions must be checked in periodic inspections. The risk analysis or applicable regulations determine the time distances between the tests.

The inspection interval should not exceed one year.

Product extensions

Functional safety
Technical data



Technical data

Rated data



The data applies to products delivered **after** 1st September 2016.

Safety-related characteristics according to EN 61508, Part 1–7 and EN 62061

Specification	Value	Comment
Safety Integrity Level	SIL 3	
PFH [1/h]	1.71 E-09	1.71 % of SIL 3
PFD _{avg} (T)	1.49 E-04	14.9 % of SIL 3 after T = 20 years
Proof test interval	20 years	Mission time

Safety-related characteristics according to EN ISO 13849-1

Specification	Value	Comment
Performance Level	e	
Category	4	
MTTF _d	High	3200 years
Mean diagnostic coverage DC _{av}	High	99 %

Basics of the safety-related characteristics

Basics	Value	Comment
Source of failure rates	SN 29500	When no values from the component manufacturers were available.
Average max. ambient temperature	40 °C	

X1	Specification	Unit	min.	typ.	max.
SIA, SIB	LOW signal	V	-3	0	+5
	HIGH signal	V	+15	+24	+30
	Switch-on time	ms		3	
	Clear time	ms		50	60
	Input current SIA	mA		10	14
	Input current SIB	mA		7	12
	Input peak current	mA		100	
	Test pulse duration	ms			
	Test pulse interval	ms	10		
GS	Reference potential for SIA and SIB				

Connection description		Basic Safety - STO
Connection		X1
Connection type		Pluggable double spring terminal
Max. Cable cross-section	mm ²	1.5
Max. Cable cross-section	AWG	16
Stripping length	mm	9
Stripping length	inch	0.35
Tightening torque	Nm	-
Tightening torque	lb-in	-
Required tool		0.4 x 2.5



Accessories

Overview

A package of accessories optimally matched to the inverter is available for your applications.

Moreover, the pluggable modules make commissioning and diagnostics easier.

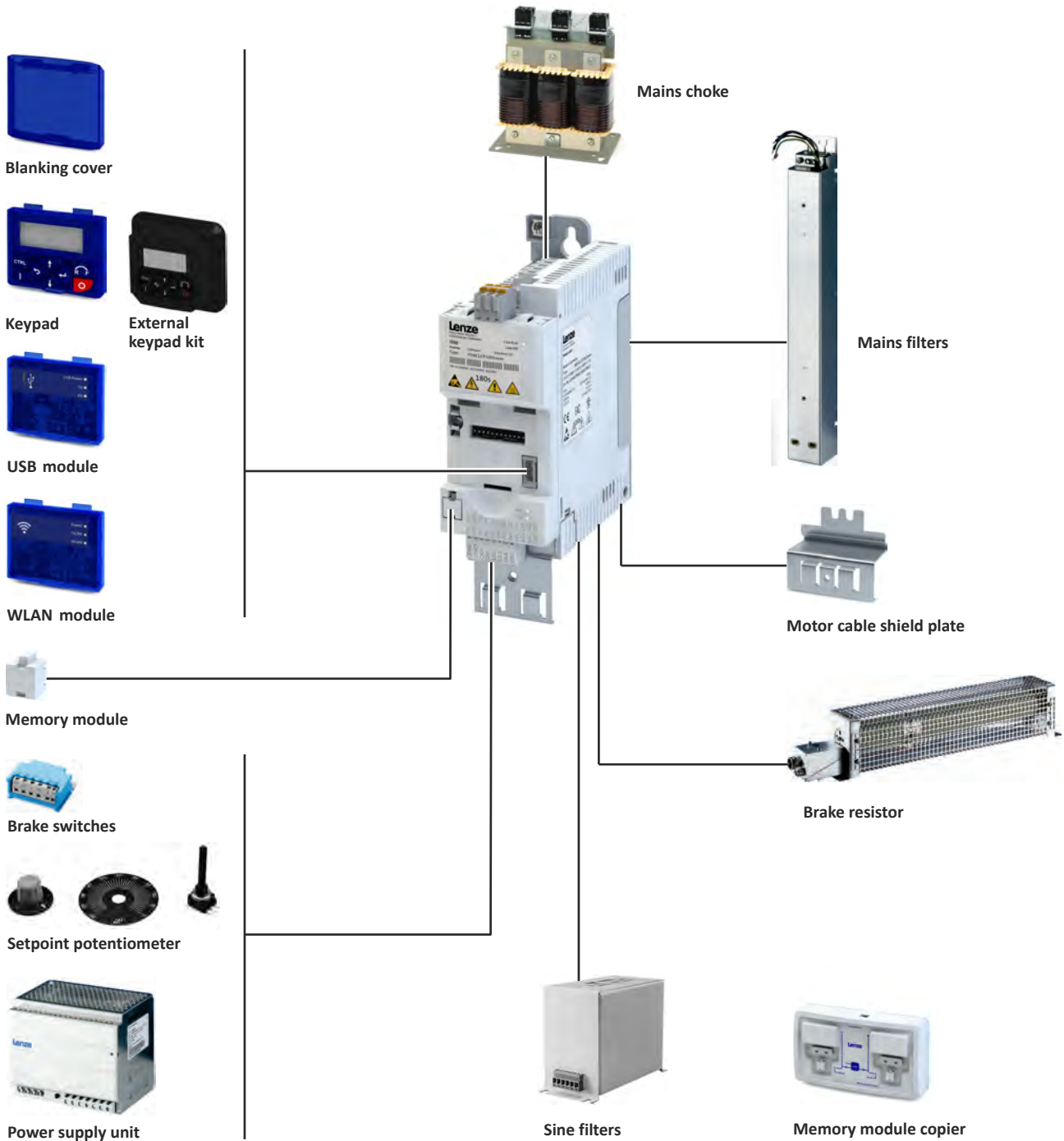

Further accessories: DIN rail, terminal strips and latching terminals for the shield sheet of the control unit.

Accessories

Operation and diagnostics
Keypad



Operation and diagnostics

Keypad

Parameter setting and diagnostics

Thanks to the intuitive operating structure, the navigation keys allow a quick and easy access to the most important parameters, either to configure functions or to query current values. Parameters and actual values are indicated on the easy-to-read display.



Keypad	
Order code	Type
I5MADK0000000S	LCD display Display in German/English

External keypad

Installation in user interface

The external keypad kit facilitates installation of a I5MADK0000000S keypad in an IP65 housing for mounting to the control cabinet wall.



External keypad kit	
Order code	Type
I5MADR0000000S	without connecting cable
I5MADR0000001S	with connecting cable 3 m
I5MADR0000002S	with connecting cable 5 m
The I5MADK0000000S keypad is not part of the delivery.	



USB module

Interface to the PC

Connect the inverter via a USB 2.0 connection cable to a PC on which the Lenze "EASY Starter" engineering tool is installed. Configure the inverter with the "EASY Starter" using graphical user interfaces. You can create diagnostics with trend functions or observe parameter values.

Parameterising without supplying the inverter with voltage: in many cases, the USB interface of the PC is sufficient for the voltage supply if you connect the inverter directly to the PC without a hub.



USB module	
Order code	Type
I5MADU0000000S	Parameter setting without voltage supply of the inverter is possible. USB 2.0 connecting cable required

Connecting cable		
Order code	Length	Type
EWL0085/S	3 m	USB 2.0-connecting cable (A-plug to micro B-plug)
EWL0086/S	5 m	



Inverters with network option EtherCAT, PROFINET or EtherNET/IP must be supplied with an additional voltage for setting parameters if a connection cable longer than 3 m is used.

Please observe the following for USB modules labelled as "PRE-SERIES":
Inverters with network option EtherCAT, PROFINET or EtherNET/IP must always be supplied with an additional voltage for setting parameters.

Accessories

Operation and diagnostics
WLAN module



WLAN module

Communicate with the inverter wirelessly,

- via a PC with the "EASY Starter" Lenze Engineering Tool or
- via the Lenze Smart Keypad app for Android and iOS smartphones.

The app is recommended for adapting easy applications. The clearly arranged user interface of the app guides you intuitively and safely through all the menus. The operation corresponds to the operation with the keypad.



WARNING!

- ▶ This product contains FCC ID: QQQWF121/IC: 5123A-BGTWF121
- ▶ To comply with FCC and Industry Canada RF radiation exposure limits for general population, the transmitter with its antenna must be installed such that a minimum separation distance of 20 cm is maintained between the radiator (antenna) and all persons at all times.
- ▶ This product must not be collocated or operated in conjunction with any other antenna or transmitter.
- ▶ -----
- ▶ Le produit contient un module transmetteur certifié FCC ID: QQQWF121/IC: 5123A-BGTWF121
- ▶ Afin de se conformer aux réglementations de la FCC et d'Industry Canada relatives aux limites d'exposition aux rayonnements RF pour le grand public, le transmetteur et son antenne doivent être installés de sorte qu'une distance minimale de 20 cm soit constamment maintenue entre le radiateur (antenne) et toute personne.
- ▶ Le produit ne doit pas être utilisé en combinaison avec d'autres antennes ou transmetteurs.



The use of this module may be restricted or prohibited due to country-specific provisions or additionally required certifications.

The module has been certified according to:

- CE
- FCC
- IC
- CMIIT

The module can be used if the certification is recognised in one country according to one of these standards.



LED status displays			
LED 1	LED 2	LED 3	Meaning
Power (green)	TX/RX (yellow)	WLAN (green)	
Supply voltage status	Communication status	WLAN status	
OFF	OFF	OFF	No voltage
ON	ON	ON	Self-test (approx. 1 s)
ON	OFF	OFF	Ready for operation No active WLAN connection
ON	Flashing	ON	Communication active
ON	OFF	Blinking	Client Mode Waiting for connection
Blinking	OFF	OFF	Trouble

SMART Keypad App

The SMART Keypad App for Android or iOS allows you to diagnose and parameterize an Inverter i500. A WLAN module on the i500 inverter is required for communication.

- Ideal for the parameterization of simple applications such as a conveyor belt.
- Ideal for the diagnostics of the inverter.

The Lenze SMART Keypad App can be found in the Google Play Store or in the Apple App Store.

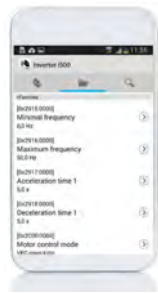

Android



iOS

Additional conformities and approvals		
CE	RED	EN 301489-1 V2.1.1:2016
		EN 301489-17 V3.1.1:2016
		EN 300328 V2.1.1:2016
FCC	Part 15.107/15.109 ICES-003	

Connection data (default setting)	
IP address	192.168.178.1
SSID	<Product type>_<10-digit identifier>
Password	password

WLAN module	
Order code	Type
15MADW00000005	Range in open space: 100 m, conditions on site may restrict the range.

Accessories

Memory modules
Blanking cover



Blanking cover

Protection and optics

The blanking cover protects the terminals and provides for uniform optics if no other module is plugged on.



Blanking cover		
Order code	Type	VPE
		Piece
I5ZAA0000M	Protection against dust Uniform optics	4

Setpoint potentiometer

For the external selection of an analog setpoint.

The setpoint selection (e.g. motor speed) can be manually set via the external potentiometer.

The setpoint potentiometer is connected to the analog input terminals of the inverter.

The position is displayed on the scale via the rotary knob.

The components have to be ordered separately.



Setpoint potentiometer		
Order code	Name	Type
ERPD0010K0001W	Potentiometer	10 kΩ/1 W
ERZ0001	Rotary knob	Diameter 36 mm
ERZ0002	Scale	Scale 0 ... 100 %, Diameter 62 mm

Memory modules

For serial commissioning, Lenze offers its customers multipacked, unwritten memory modules (EPM). Together with the EPM copier, the EPMs can be duplicated at any place.

A memory module is included in the scope of supply of the inverter.



Memory module		
Order code	Type	VPE
		Piece
I0MAPA0000000M	Easily pluggable Duplicate data set with memory module copier	12



Memory module copier

For duplicating data on memory modules for a faster standard set-up.

The memory module copier is a copying system for all memory modules from Lenz. With the help of simple optical user guidance, the data of a module is copied quickly and reliably to another memory module.



Memory module copier	
Order code	Type
EZAEDE1001	Data set copier for memory modules

Brake resistors

- To decelerate greater moments of inertia or with a longer operation in generator mode an external brake resistor is required.
- The brake resistor absorbs the produced brake energy and converts it into heat.



The matching assignment of these accessories is specified in the technical data of the devices.

Accessories

Mains chokes



Mains chokes

- Mains chokes reduce the feedback effects of the inverter on the supplying mains by their high inductive resistance reducing high-frequency interference.
- The effective mains current is reduced which saves energy.
- Mains chokes can be used without restrictions in conjunction with RFI filters.
- Please note that the use of a mains choke reduces the mains voltage at the input of the inverter by 4 % (typical voltage drop across the mains choke in the rated point).



For operation with the "Heavy Duty" load characteristic, inverters starting from 22 kW must always be used together with mains chokes. For operation with the "Light Duty" load characteristic, please observe the information in the technical data.



The matching assignment of these accessories is specified in the technical data of the devices.



RFI filters / Mains filters

RFI and mains filters are used to ensure compliance with the EMC requirements of European Standard EN 61800-3. This standard defines the EMC requirements for electrical drive systems in various categories.

- RFI filters are capacitive accessory components. RFI filters reduce conducted noise emissions. RFI filters are also called EMC filters.
- Mains filters are a combination of mains choke and RFI filter. Mains filters reduce the conducted noise emission.

Definition of the environments

(EN 61800-3)

First environment

The first environment comprises residential buildings or locations that are directly connected to a low-voltage system for supplying residential areas.

Second environment

The second environment comprises facilities or locations that are not directly connected to a low-voltage system for supplying residential areas.

Category C1

Category C1 defines the requirements for drive systems that are intended for the use in the first environment at a rated voltage lower than 1000 V.

The limit values of the EN 61800-3 comply with EN 55011 class B.

Category C2

Category C2 defines the requirements for permanently installed fixed drive systems that are intended for the use in the first environment at a rated voltage lower than 1000 V. Installation and commissioning may only be carried out by specialist personnel with EMC knowledge.

The limit values of the EN 61800-3 comply with EN 55011 class A group 1.

Category C3

Category C3 defines the requirements for drive systems that are exclusively intended for the use in the second environment at a rated voltage lower than 1000 V.

The limit values of the EN 61800-3 comply with EN 55011 class A group 2.



When working with stricter line-bound noise emission requirements which cannot be met using the radio interference suppression measures integrated in the inverter, external filters can be used. The filters can be installed below or next to the inverter.

If necessary, the internal filters have to be deactivated when external filters are used. For this purpose, remove the IT screws of the inverters.

Accessories

Sine filter



Comparison of integrated and external RFI filters

RFI filters	Filter types			
	Integrated in the inverter	External		
		Low Leakage	Short Distance	Long Distance
Use	In standard applications	In mobile systems	With short cable length	At switching frequencies 4 kHz and 8 kHz.
Optimisation	Easy use	For low leakage current	For low leakage current	For long motor cable
Reduces noise emissions	Cable-guided and radiated	Cable-guided	Cable-guided	Cable-guided



The matching assignment of these accessories is specified in the technical data of the devices.

Sine filter

A sinusoidal filter in the motor cable limits the rate of voltage rise and the capacitive charge/discharge currents between the conductors that occur during inverter operation.



Only use a sinusoidal filter with standard asynchronous motors 0 to 550 V.
 Operation only with V/f or square-law V/f characteristic control.
 Set the switching frequency permanently to the specified value.
 Limit the output frequency of the inverter to the given value.



The matching assignment of these accessories is specified in the technical data of the devices.

Power supply units

For the external supply of the control electronics of the inverter.

The parameterisation and diagnostics can be executed when the mains input at the inverter is deenergised.



Order code		EZV1200-000	EZV2400-000	EZV4800-000	EZV1200-001	EZV2400-001	EZV4800-001
Rated voltage	V	230			400		
Rated mains current	A	0.8	1.2	2.3	0.3	0.6	1.0
Input voltage	V	AC 85 - 264 DC 90 ...350			AC 320 ... 575 DC 450 ...800		
Output voltage	V	DC 22.5 - 28.5					
Rated output current	A	5.0	10.0	20.0	5.0	10.0	20.0



Brake switches

For switching an electromechanical brake.

The brake switch consists of a rectifier and an electronic circuit breaker.

It is mounted on the control cabinet plate. Control is performed using a digital output on the inverter.



Brake switches		Half-wave rectifiers	Bridge rectifiers
Order code		E82ZWBRE	E82WBRB
Input voltage	V	AC 320 - 550	AC 180 - 317
Output voltage	V	DC 180 (with AC 400) DC 225 (with AC 500)	DC 205 (with AC 230)
Max. brake current	A	0.61	0.54

Accessories

Mounting
Shield mounting kit



Mounting

Shield mounting kit

Motor cable

If the shielding of the motor cable is centrally connected to an earthing busbar in the control cabinet, no shielding is required.

For a direct connection of the shielding of the motor cable to the inverter, the optionally available accessories can be used consisting of shield sheet and fixing clips or wire clamps.



From 15 kW, the shield sheet is integrated.





Accessories

Mounting
Shield mounting kit

Inverter	Shield mounting kit			
	Order code	Packaging unit	Order code	Packaging unit
		Unit		Unit
i550-C0.25/120-1	EZAMBHXM018/M	5x motor shield plate	EZAMBHXM018/S	1x motor shield plate
i550-C0.37/120-1		5x fixing clip		1x fixing clip
i550-C0.75/120-1		5x wire clamp (cable diameter 0.157 ... 0.591 in (4 ... 15 mm))		1x wire clamp (cable diameter 0.157 ... 0.591 in (4 ... 15 mm))
i550-C1.1/120-1				
i550-C0.25/230-1	EZAMBHXM018/M	5x motor shield plate 5x fixing clip 5x wire clamp (cable diameter 0.157 ... 0.591 in (4 ... 15 mm))	EZAMBHXM018/S	1x motor shield plate 1x fixing clip 1x wire clamp (cable diameter 0.157 ... 0.591 in (4 ... 15 mm))
i550-C0.25/230-2				
i550-C0.37/230-1				
i550-C0.37/230-2				
i550-C0.55/230-1				
i550-C0.55/230-2				
i550-C0.75/230-1				
i550-C0.75/230-2				
i550-C1.1/230-1				
i550-C1.1/230-2				
i550-C1.5/230-1				
i550-C1.5/230-2				
i550-C2.2/230-1				
i550-C2.2/230-2				
i550-C4.0/230-3	EZAMBHXM015/M	5x motor shield plate 5x fixing clip 5x wire clamp (cable diameter 0.157 ... 0.591 in (4 ... 15 mm)) 5x M4x12 screw	EZAMBHXM015/S	1x motor shield plate 1x fixing clip 1x wire clamp (cable diameter 0.157 ... 0.591 in (4 ... 15 mm)) 1x M4x12 screw
i550-C5.5/230-3				
i550-C0.37/400-3	EZAMBHXM018/M	5x motor shield plate 5x fixing clip 5x wire clamp (cable diameter 0.157 ... 0.591 in (4 ... 15 mm))	EZAMBHXM018/S	1x motor shield plate 1x fixing clip 1x wire clamp (cable diameter 0.157 ... 0.591 in (4 ... 15 mm))
i550-C0.55/400-3				
i550-C0.75/400-3				
i550-C1.1/400-3				
i550-C1.5/400-3				
i550-C2.2/400-3				
i550-C3.0/400-3				
i550-C4.0/400-3				
i550-C5.5/400-3	EZAMBHXM015/M	5x motor shield plate 5x fixing clip 5x wire clamp (cable diameter 0.157 ... 0.591 in (4 ... 15 mm)) 5x M4x12 screw	EZAMBHXM015/S	1x motor shield plate 1x fixing clip 1x wire clamp (cable diameter 0.157 ... 0.591 in (4 ... 15 mm)) 1x M4x12 screw
i550-C7.5/400-3	EZAMBHXM016/M	5x motor shield plate 5x fixing clip 5x wire clamp (cable diameter 0.394 ... 0.787 in (10 ... 20 mm)) 5x M4x12 screw	EZAMBHXM016/S	1x motor shield plate 1x fixing clip 1x wire clamp (cable diameter 0.394 ... 0.787 in (10 ... 20 mm)) 1x M4x12 screw
i550-C11/400-3				
i550-C15/400-3	EZAMBHXM003/M	10x wire clamp (cable diameter 0.394 ... 0.787 in (10 ... 20 mm))	EZAMBHXM004/M	10x wire clamp (cable diameter 0.591 ... 1.102 in (15 ... 28 mm))
i550-C18.5/400-3				
i550-C22/400-3				
i550-C30/400-3	EZAMBHXM004/M	10x wire clamp (cable diameter 0.591 ... 1.102 in (15 ... 28 mm))	EZAMBHXM005/M	10x wire clamp (cable diameter 0.787 ... 1.457 in (20 ... 37 mm))
i550-C37/400-3				
i550-C45/400-3				
i550-C55/400-3	EZAMBHXM004/M	10x wire clamp (cable diameter 0.591 ... 1.102 in (15 ... 28 mm))	EZAMBHXM005/M	10x wire clamp (cable diameter 0.787 ... 1.457 in (20 ... 37 mm))
i550-C75/400-3				
i550-C90/400-3	-	-	-	-
i550-C110/400-3	-	-	-	-

Accessories

Mounting
Terminal strips



Shield mounting of the control cables

In case of the control unit, the shield sheet for control cables is integrated.

Usually, the shields can be fixed with standard plastic cable ties.

Optionally, fixing clips are suitable for the shield connections of the control cables of inverters 0.25 kW ... 0.75 kW.

Shield mounting kit	
Order code	VPE
	Piece
EZAMBHXM007/M	20x fixing clip

Terminal strips

For connecting the inverter, the connections are equipped with pluggable terminal strips. Pluggable terminal strips are available separately for service purposes or if cable harnesses need to be physically separated.

Inverter	Terminal strips Mains connection X100		Terminal strips Motor connection X105	
	Order code	VPE	Order code	VPE
		Piece		Piece
i550-C0.25/230-1	EZA EVE032/M	10	EZA EVE039/M	5
i550-C0.37/230-1				
i550-C0.55/230-1				
i550-C0.75/230-1				
i550-C1.1/230-1				
i550-C1.5/230-1	EZA EVE033/M			
i550-C2.2/230-1				
i550-C0.25/230-2		EZA EVE034/M		
i550-C0.37/230-2				
i550-C0.55/230-2				
i550-C0.75/230-2				
i550-C1.1/230-2				
i550-C1.5/230-2	EZA EVE035/M			
i550-C2.2/230-2				
i550-C0.37/400-3		EZA EVE037/M		
i550-C0.55/400-3				
i550-C0.75/400-3				
i550-C1.1/400-3				
i550-C1.5/400-3				
i550-C2.2/400-3				

Terminal strips	Order code	VPE	Terminal strips	Order code	VPE
		Piece			Piece
Safety (STO) X1	EZA EVE029/M	10	Standard I/O X3	EZA EVE040/M	5
Relay X9	EZA EVE030/M	10	Application-I/O X3	EZA EVE041/M	5
Motor PTC X109	EZA EVE031/M	10	CANopen / Modbus X216	EZA EVE042/M	10



Accessories

Mounting
DIN rail

DIN rail

In accordance with EN 60175, the inverter can be mounted onto a DIN rail 35 mm x 7.5 mm.
For this purpose, a mounting set is available.



Mounting set	Can be used for inverters
Order code	Order code
I5ZAB0DR1S	I5xAE125x, I5xAE137x, I5xAE155x, I5xAE175x
I5ZAB0DR2S	I55AE175Ax, I5xAE211x, I5xAE215x, I5xAE222x, I5xxE230x, I5xxE240x, I5xxE255x

Purchase order

Notes on ordering



Purchase order

Notes on ordering

There are two ways to order an inverter.

As a complete inverter or as single components consisting of power unit, control unit and safety module.

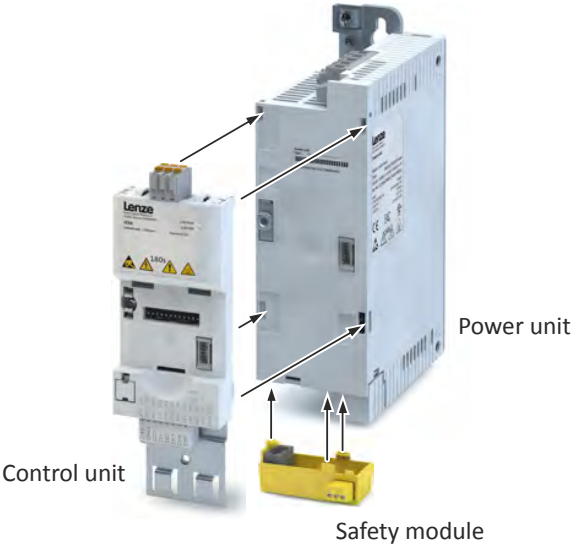
Complete inverter	Inverter consisting of components
	 <p>Control unit</p> <p>Power unit</p> <p>Safety module</p>



Order code

Delivery as complete inverter

If always the same inverter is used in the machine the inverter can be ordered "out of the box".

Order data: Order code of the complete device.

Order example

Description of the component	Order code
Complete inverter	i55AE222F1AV10002S
3-phase mains connection 400 V	
Power 2.2 kW (i550-C2.2/400-3)	
Safety engineering: STO safety function	
Default setting of parameters: EU region (50-Hz systems)	
Standard I/O with CANopen	

Purchase order

Order code



i550 inverters

Complete inverter			
Power		Inverter	Order code
kW	HP		
1-phase mains connection 120 V, EMC filter not integrated			
0.25	0.33	i550-C0.25/120-1	i55AE125A1
0.37	0.5	i550-C0.37/120-1	i55AE137A1
0.75	1	i550-C0.75/120-1	i55AE175A1
1.1	1.5	i550-C1.1/120-1	i55AE211A1
1-phase mains connection 230 V, EMC filter integrated			
0.25	0.33	i550-C0.25/230-1	i55AE125B1
0.37	0.5	i550-C0.37/230-1	i55AE137B1
0.55	0.75	i550-C0.55/230-1	i55AE155B1
0.75	1	i550-C0.75/230-1	i55AE175B1
1.1	1.5	i550-C1.1/230-1	i55AE211B1
1.5	2	i550-C1.5/230-1	i55AE215B1
2.2	3	i550-C2.2/230-1	i55AE222B1
1/3-phase mains connection 230/240 V, EMC filter not integrated			
0.25	0.33	i550-C0.25/230-2	i55AE125D1
0.37	0.5	i550-C0.37/230-2	i55AE137D1
0.55	0.75	i550-C0.55/230-2	i55AE155D1
0.75	1	i550-C0.75/230-2	i55AE175D1
1.1	1.5	i550-C1.1/230-2	i55AE211D1
1.5	2	i550-C1.5/230-2	i55AE215D1
2.2	3	i550-C2.2/230-2	i55AE222D1
3-phase mains connection 230/240 V, EMC filter not integrated			
4.0	5	i550-C4.0/230-3	i55AE240C1
5.5	7.5	i550-C5.5/230-3	i55AE255C1
3-phase mains connection 400/480 V, EMC filter integrated			
0.37	0.5	i550-C0.37/400-3	i55AE137F1
0.55	0.75	i550-C0.55/400-3	i55AE155F1
0.75	1	i550-C0.75/400-3	i55AE175F1
1.1	1.5	i550-C1.1/400-3	i55AE211F1
1.5	2	i550-C1.5/400-3	i55AE215F1
2.2	3	i550-C2.2/400-3	i55AE222F1
3	4	i550-C3.0/400-3	i55AE230F1
4	5	i550-C4.0/400-3	i55AE240F1
5.5	7.5	i550-C5.5/400-3	i55AE255F1
7.5	10	i550-C7.5/400-3	i55AE275F1
11	15	i550-C11/400-3	i55AE311F1
15	20	i550-C15/400-3	i55AE315F1
18.5	25	i550-C18/400-3	i55AE318F1
22	30	i550-C22/400-3	i55AE322F1
30	40	i550-C30/400-3	i55AE330F1
37	50	i550-C37/400-3	i55AE337F1
45	60	i550-C45/400-3	i55AE345F1
55	74	i550-C55/400-3	i55AE355F1
75	100	i550-C75/400-3	i55AE375F1
90	120	i550-C90/400-3	i55AE390F1
110	150	i550-C110/400-3	i55AE411F1
Continuation ...			



Power		Inverter	Order code
kW	HP		
<i>Continuation ...</i>			
Safety engineering			
Without safety engineering		0	
Safety function STO		A	
Not relevant			V
EMC filter			
not integrated	i550-Cxxx/ 120-1 i550-Cxxx/ 230-2 i550-Cxxx/ 230-3		0
Integrated	i550-Cxxx/ 230-1 i550-Cxxx/ 400-3		1
Delivery status			
Default parameter setting: Region EU (50-Hz networks)			0
Default parameter setting: Region US (60-Hz networks)			1
Control unit			
Standard I/O without network			000S
Application I/O without network			001S
Standard I/O with CANopen			002S
Standard I/O with Modbus RTU			003S
Standard I/O with Modbus TCP			00WS
Standard I/O with PROFIBUS			004S
Standard I/O with EtherCAT			00KS
Standard I/O with PROFINET			00LS
Standard I/O with EtherNet/IP			00MS
Standard I/O with POWERLINK			012S
Standard I/O with IO-Link			016S

Delivery of individual components

If different product versions are required in the machine, the various components can be ordered individually. Depending on the application, the components can be plugged together easily without any further tools.

Order data: Order codes of the individual components.

Order example

Description of components	Order code
Power unit	
3-phase mains connection 400/480 V	I5DAE222F10V10000S
Power 2.2 kW (i550-C2.2/400-3)	
Safety module	
Safety function STO	I5MASAV000000S
Control unit	
Standard I/O with CANopen	I5CA5C02000VA0000S
Default setting of parameters: EU region (50-Hz systems)	

Purchase order

Order code



Power unit			
Power		Inverter	Order code
kW	HP		
1-phase mains connection 120 V, EMC filter not integrated			
0.25	0.33	i550-C0.25/120-1	I5DAE125A10V00000S
0.37	0.5	i550-C0.37/120-1	I5DAE137A10V00000S
0.75	1	i550-C0.75/120-1	I5DAE175A10V00000S
1.1	1.5	i550-C1.1/120-1	I5DAE211A10V00000S
1-phase mains connection 230 V, EMC filter integrated			
0.25	0.33	i550-C0.25/230-1	I5DAE125B10V10000S
0.37	0.5	i550-C0.37/230-1	I5DAE137B10V10000S
0.55	0.75	i550-C0.55/230-1	I5DAE155B10V10000S
0.75	1	i550-C0.75/230-1	I5DAE175B10V10000S
1.1	1.5	i550-C1.1/230-1	I5DAE211B10V10000S
1.5	2	i550-C1.5/230-1	I5DAE215B10V10000S
2.2	3	i550-C2.2/230-1	I5DAE222B10V10000S
1/3-phase mains connection 230/240 V, EMC filter not integrated			
0.25	0.33	i550-C0.25/230-2	I5DAE125D10V00000S
0.37	0.5	i550-C0.37/230-2	I5DAE137D10V00000S
0.55	0.75	i550-C0.55/230-2	I5DAE155D10V00000S
0.75	1	i550-C0.75/230-2	I5DAE175D10V00000S
1.1	1.5	i550-C1.1/230-2	I5DAE211D10V00000S
1.5	2	i550-C1.5/230-2	I5DAE215D10V00000S
2.2	3	i550-C2.2/230-2	I5DAE222D10V00000S
3-phase mains connection 230/240 V, EMC filter not integrated			
4.0	5	i550-C4.0/230-3	I5DAE240C10V00000S
5.5	7.5	i550-C5.5/230-3	I5DAE255C10V00000S
3-phase mains connection 400/480 V, EMC filter integrated			
0.37	0.5	i550-C0.37/400-3	I5DAE137F10V10000S
0.55	0.75	i550-C0.55/400-3	I5DAE155F10V10000S
0.75	1	i550-C0.75/400-3	I5DAE175F10V10000S
1.1	1.5	i550-C1.1/400-3	I5DAE211F10V10000S
1.5	2	i550-C1.5/400-3	I5DAE215F10V10000S
2.2	3	i550-C2.2/400-3	I5DAE222F10V10000S
3	4	i550-C3.0/400-3	I5DAE230F10V10000S
4	5	i550-C4.0/400-3	I5DAE240F10V10000S
5.5	7.5	i550-C5.5/400-3	I5DAE255F10V10000S
7.5	10	i550-C7.5/400-3	I5DAE275F10V10000S
11	15	i550-C11/400-3	I5DAE311F10V10000S
15	20	i550-C15/400-3	I5DAE315F10V10000S
18.5	25	i550-C18/400-3	I5DAE318F10V10000S
22	30	i550-C22/400-3	I5DAE322F10V10000S
30	40	i550-C30/400-3	I5DAE330F10V10000S
37	50	i550-C37/400-3	I5DAE337F10V10000S
45	60	i550-C45/400-3	I5DAE345F10V10000S
55	74	i550-C55/400-3	I5DAE355F10V10000S
75	100	i550-C75/400-3	I5DAE375F10V10000S
90	120	i550-C90/400-3	I5DAE390F10V10000S
110	150	i550-C110/400-3	I5DAE411F10V10000S
Safety module			Order code
Safety function STO			I5MASAV000000S



Purchase order

Order code

Control unit	Order code	
	Delivery status Default parameter setting: Region EU (50-Hz networks)	Delivery status Default parameter setting: Region US (60-Hz networks)
Standard I/O without network	I5CA5002000VA0000S	I5CA5002000VA1000S
Application I/O without network	I5CA5003000VA0000S	I5CA5003000VA1000S
Standard I/O with CANopen	I5CA5C02000VA0000S	I5CA5C02000VA1000S
Standard I/O with Modbus RTU	I5CA5W02000VA0000S	I5CA5W02000VA1000S
Standard I/O with Modbus TCP	I5CA5V02000VA0000S	I5CA5V02000VA1000S
Standard I/O with PROFIBUS	I5CA5P02000VA0000S	I5CA5P02000VA1000S
Standard I/O with EtherCAT	I5CA5T02000VA0000S	I5CA5T02000VA1000S
Standard I/O with PROFINET	I5CA5R02000VA0000S	I5CA5R02000VA1000S
Standard I/O with EtherNet/IP	i5CA5G02000VA0000S	I5CA5G02000VA1000S
Standard I/O with POWERLINK	I5CA5N02000VA0000S	I5CA5N02000VA1000S
Standard I/O with IO-Link	I5CA5K02000VA0000S	I5CA5K02000VA1000S

Appendix

Declarations of Conformity



Appendix

Declarations of Conformity



Lenze

2353891.06

EU-Konformitätserklärung

EU Declaration of Conformity

LENZE Drives GmbH, Breslauer Strasse 3, 32699 Extertal GERMANY

erklärt in alleiniger Verantwortung die Übereinstimmung der Produkte

declares under sole responsibility compliance of the products:

Antriebsregler der Baureihen:

Controllers of the series:

I5DxExxxx1xaxbxxxxxx & I5MASAxbxxxxxx (Safety Module)

mit der

with the

Maschinenrichtlinie

Machinery Directive

2006/42/EG Anhang IX und VIII

2006/42/EC Annex IX und VIII

Angewandte harmonisierte Normen:

Applied harmonized standards:

Sicherer Halt	Stopp Kategorie 0	EN 60204-1 + A1 + AC	:2006, 2018 :2009 :2010	Stop category 0	Safe torque off
	Kategorie 4			Category 4	
	Performance Level (PL): PL e	EN ISO 13849-1	:2015	Performance Level (PL): PL e	
Sicherheitsfunktionen siehe Betriebsanleitung.	SIL 3	EN 61508 1-7 EN 62061 + AC + A1 + A2 EN 61800-5-2 EN 61800-5-1 + A1	:2010 :2005 :2010 :2013 :2015 :2017 :2007 :2017	SIL 3	For safety functions see manual.



Konformitätsbewertung

Conformity assessment



Benannte Stelle

notified body

TÜV Rheinland Industrie Service GmbH
Am Grauen Stein
51105 Köln / Germany

Zertifikate

certificates

01/205/5455.01/19

Gültigkeit

Date of expiry

2024-05-27

EMV- Richtlinie

EMC Directive

2014/30/EU

2014/30/EU

Angewandte harmonisierte Normen:

Applied harmonized standards:

EN 61800-3:2004, 2018 + A1:2012

RoHS- Richtlinie

RoHS Directive

2011/65/EU

2011/65/EU

Angewandte harmonisierte Normen:

Applied harmonized standards:

EN 50581:2012

Die Sicherheitshinweise der Betriebsanleitung sind zu beachten.

The safety instructions of the manual are to be considered.

Die Produkte sind bestimmt zum Einbau in Maschinen. Die Inbetriebnahme ist solange untersagt bis festgestellt wurde, dass die Maschine, in welche diese Produkte eingebaut werden sollen, den Bestimmungen der o.g. EG-Richtlinie entsprechen.

These products are intended for installation in machines. Operation is prohibited until it has been determined that the machines in which these products are to be installed, conforms to the above mentioned EC Directive.

Ort / Datum

Place / date

Extertal 02.12.2019

Geschäftsführer
General Manager

Dipl.-Ing. Frank Maier

Dokumentationsverantwortlicher

Responsible for documentation

i.V. T. Wedemeyer



Lenze

2353891.06

Déclaration UE de conformité

Dichiarazione di conformità UE

LENZE Drives GmbH, Breslauer Strasse 3, 32699 Extertal GERMANY

Déclare, sous sa seule responsabilité, que les produits

dichiara sotto la propria esclusiva responsabilità la conformità dei seguenti prodotti

Variateurs de vitesse des séries :

Unità di controllo delle serie:

**I5Dxxxx1xaxbxxxxxx &
I5MASAxbxxxxxx (Safety Module)**

respectent la

alla

Directive Machines

Direttiva macchine

2006/42/CE Annexes IX et VIII

2006/42/CE Allegato IX e VIII

Normes harmonisées appliquées :

Standard armonizzati applicati:

Arrêt sécurisé	Catégorie d'arrêt 0	EN 60204-1 + A1 + AC	:2006, 2018 :2009 :2010	Categoria di stop 0	Arresto sicuro
	Catégorie 4			Categoria 4	
	Niveau de performance(PL): PL e	EN ISO 13849-1	:2015	Niveau di prestazioni (PL): PL e	
Fonctions de sécurité : voir manuel d'utilisation.	SIL 3	EN 61508 1-7 EN 62061 + AC + A1 + A2 EN 61800-5-2 EN 61800-5-1 + A1	:2010 :2005 :2010 :2013 :2015 :2017 :2007 :2017	SIL 3	Per le funzioni di sicurezza vedere le istruzioni operative.



Evaluation de conformité

Valutazione della conformità



Organisme notifié

Ente notificato

TÜV Rheinland Industrie Service GmbH
Am Grauen Stein
51105 Köln / Germany

Certificats

Certificati

01/205/5455.01/19

Date d'expiration

Validità

2024-05-27

Directive CEM

Direttiva EMC

2014/30/EU

2014/30/EU

Normes harmonisées appliquées :

Standard armonizzati applicati:

EN 61800-3:2004, 2018 + A1:2012

Directive RoHS

Direttiva RoHS

2011/65/EU

2011/65/EU

Normes harmonisées appliquées :

Standard armonizzati applicati:

EN 50581:2012

Respecter impérativement les consignes de sécurité contenues dans le manuel d'utilisation.

Osservare assolutamente le informazioni sulla sicurezza riportate nelle istruzioni operative.

Ces produits sont destinés à être installés au sein de machines. Leur mise en service est interdite tant qu'il n'a pas été attesté que la machine destinée à les accueillir respecte les dispositions de la directive CE susmentionnée.

I prodotti elencati sono destinati all'installazione su macchine e non possono essere messi in funzione fintanto che non sia stata verificata la conformità delle macchine su cui dovranno essere installati alla suddetta direttiva CE.

Lieu / date

Luogo / data

Extertal 02.12.2019

Gérant

Amministratore delegato

Dipl.-Ing. Frank Maier

Responsable de documentation

Responsabile della documentazione

i.V. T. Wedemeyer



Lenze

2353891.06

Declaración UE de conformidad

Declaração UE de Conformidade

LENZE Drives GmbH, Breslauer Strasse 3, 32699 Extertal GERMANY

declara bajo su propia responsabilidad, que los productos

declara, sob sua exclusiva responsabilidade, a conformidade dos produtos

Controladores de las series:

Regulador de accionamento das séries de modelos:

**I5Dxxxx1xaxbxxxxxx &
I5MASxxxxxx (Safety Module)**

cumplen con la

com a

Directiva de Máquinas

Directiva de Máquinas

2006/42/CE Anexo IX y VIII

2006/42/CE Anexo IX e VIII

Normas armonizadas aplicables:

Normas harmonizadas aplicadas:

Paro seguro	Categoría de paro 0	EN 60204-1 + A1 + AC	:2006, 2018 :2009 :2010	Paragem categoria 0	Paragem segura
	Categoría 4			Categoría 4	
	Nivel de rendimiento (PL): PL e	EN ISO 13849-1	:2015	Nivel de performance (PL): PL e	
Las funciones de seguridad se encuentran en el manual de instrucciones.	SIL 3	EN 61508 1-7 EN 62061 + AC + A1 + A2 EN 61800-5-2 EN 61800-5-1 + A1	:2010 :2005 :2010 :2013 :2015 :2017 :2007 :2017	SIL 3	Consulte as funções de segurança no manual de operação.



Evaluación de conformidad

Avaliação da conformidade



Entidad notificada

Organismo notificado

TÜV Rheinland Industrie Service GmbH
Am Grauen Stein
51105 Köln / Germany

Certificados

Certificados

01/205/5455.01/19

Validez

Validade

2024-05-27

Directiva CEM

Directiva CEM

2014/30/EU

2014/30/EU

Normas armonizadas aplicables:

Normas harmonizadas aplicadas:

EN 61800-3:2004, 2018 + A1:2012

Directiva RoHS

Directiva RoHS

2011/65/EU

2011/65/EU

Normas armonizadas aplicables:

Normas harmonizadas aplicadas:

EN 50581:2012

Deben tenerse en cuenta las instrucciones de seguridad del manual.

Devem ser observadas as instruções de segurança do manual de operação.

Los productos están diseñados para su instalación en máquinas. Está prohibida la puesta en marcha hasta que se pueda determinar que la máquina en la que se instale este producto cumpla con las directivas anteriormente indicadas.

Os produtos são destinados à incorporação em máquinas. A colocação em serviço permanece proibida até que seja constatado que a máquina, na qual estes produtos devem ser incorporados, corresponde às disposições da Directiva de Máquinas CE acima citada.

Lugar / Fecha

Gerencia

Responsable de la documentación

Local / Data

Gerente

Responsável pela documentação

Extertal 02.12.2019

Dipl.-Ing. Frank Maier

i. V. T. Wedemeyer



Good to know

Approvals and directives

CCC	China Compulsory Certification documents the compliance with the legal product safety requirements of the PR of China - in accordance with Guobiao standards.
c _{CSA} _{US}	CSA certificate, tested according to US and Canada standards
UE	Union Européenne documents the declaration of the manufacturer that EU Directives are complied with.
CEL	China Energy Label documents the compliance with the legal energy efficiency requirements for motors, tested according to the PR of China and Guobiao standards
CSA	CSA Group (Canadian Standards Association) CSA certificate, tested according to Canada standards
UL ^{Energy} _{US CA}	Energy Verified Certificate Determining the energy efficiency according to CSA C390 for products within the scope of energy efficiency requirements in the USA and Canada
c _{UL} _{US}	UL certificate for products, tested according to US and Canada standards
c _{UR} _{US}	UL certificate for components, tested according to US and Canada standards
EAC	Customs union Russia / Belarus / Kazakhstan certificate documents the declaration of the manufacturer that the specifications for the Eurasian conformity (EAC) required for placing electronic and electromechanical products on the market of the entire territory of the Customs Union (Russia, Belarus, Kazakhstan, Armenia and Kyrgyzstan) are complied with.
UL	Underwriters Laboratory Listed Product
UL _{LISTED}	UL Listing approval mark as proof that the product has been tested and the applicable safety requirements have been confirmed by UL (Underwriters Laboratory).
UR	UL Recognized Component approval mark as proof that the UL approved component can be used in a product or system bearing the UL Listing approval mark.



Operating modes of the motor

Operating modes S1 ... S10 as specified by EN 60034-1 describe the basic stress of an electrical machine.

In continuous operation a motor reaches its permissible temperature limit if it outputs the rated power dimensioned for continuous operation. However, if the motor is only subjected to load for a short time, the power output by the motor may be greater without the motor reaching its permissible temperature limit. This behaviour is referred to as overload capacity.

Depending on the duration of the load and the resulting temperature rise, the required motor can be selected reduced by the overload capacity.

The most important operating modes

Continuous operation S1	Short-time operation S2
<p>Operation with a constant load until the motor reaches the thermal steady state. The motor may be actuated continuously with its rated power.</p>	<p>Operation with constant load; however, the motor does not reach the thermal steady state. During the following standstill, the motor winding cools down to the ambient temperature again. The increase in power depends on the load duration.</p>
Intermittent operation S3	Non-intermittent periodic operation S6
<p>Sequence of identical duty cycles comprising operation with a constant load and subsequent standstill. Start-up and braking processes do not have an impact on the winding temperature. The steady-state is not reached. The guide values apply to a cycle duration of 10 minutes. The power increase depends on the cycle duration and on the load period/downtime ratio.</p>	<p>Sequence of identical duty cycles comprising operation with a constant load and subsequent no-load operation. The motor cools down during the no-load phase. Start-up and braking processes do not have an impact on the winding temperature. The steady-state is not reached. The guide values apply to a cycle duration of 10 minutes. The power increase depends on the cycle duration and on the load period/idle time ratio.</p>

P Power
t Time
 t_L Idle time
 ϑ Temperature

P_V Power loss
 t_B Load period
 t_S Cycle duration



Motor control types

The inverter provides various motor control types.

Linear V/f characteristic control

The output voltage is increased proportionately to the output frequency.

In case of low output frequencies, the motor voltage can be increased to ensure a minimum current for the breakaway torque. In the field weakening range, the output voltage of the inverter is constant (mains voltage) and the frequency can be further increased depending on the load. The maximum torque of the motor is reduced proportionately to the square of the frequency increase, the maximum output power of the motor being constant.

Application areas are for instance: Single drives with constant load.

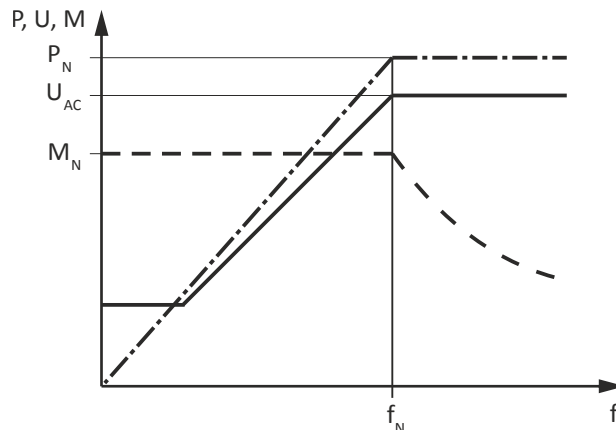

P	Power	M_{rated}	Rated torque
V	Voltage	f_{rated}	Rated frequency
M	Torque	M_{rated}	Rated torque
f	Frequency	f_{rated}	Rated frequency

Square-law V/f characteristic control

The output voltage is increased squarely to the output frequency.

In case of low output frequencies, the motor voltage can be increased to ensure a minimum current for the breakaway torque. In the field weakening range, the output voltage of the inverter is constant (mains voltage) and the frequency can be further increased depending on the load. The maximum torque of the motor is reduced squarely to the frequency increase, the maximum output power of the motor being constant.

Application areas are for instance:

- Pumps
- Fans
- Ventilators

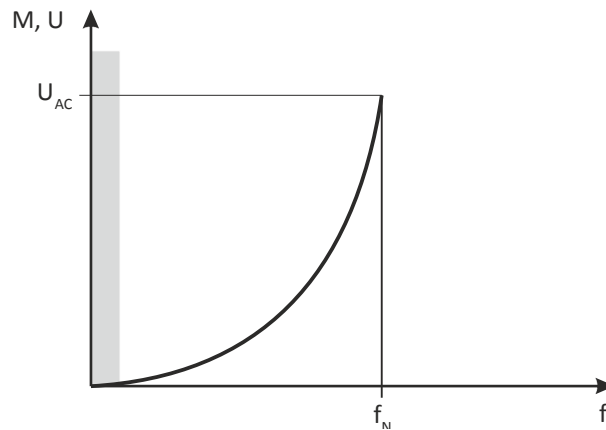

V	Voltage	U_{AC}	Mains voltage
f	Frequency	f_{rated}	Rated frequency
M	Torque		

VFCeco

The VFCeco mode has a special effect in the partial load operational range. Usually, three-phase AC motors are supplied there with a higher magnetising current than required by the operating conditions. The VFCeco mode reduces the losses in the partial load operational range so that savings up to 30 % are possible.

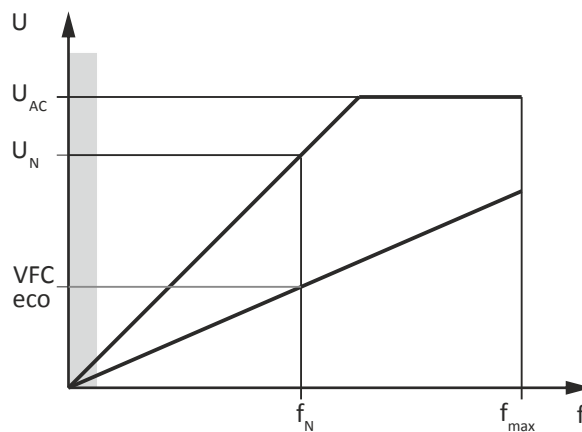

V	Voltage	f	Frequency
U_{AC}	Mains voltage	f_{rated}	Rated frequency
U_{rated}	Rated voltage	f_{max}	Max. frequency

Sensorless vector control (SLVC)

In vector control, an inverted voltage model is used for calculation. The parameters are detected via a parameter identification. The inverter determines the angle between current and voltage. This imposes a current on the motor".

Compared to the V/f characteristic control, the vector control serves to achieve improved drive characteristics thanks to:

- higher torque throughout the entire speed range
- higher speed accuracy and higher concentricity factor
- higher efficiency

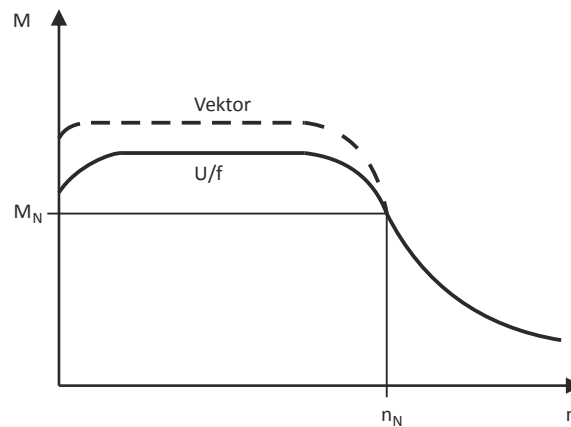

M Torque M_{rated} Rated torque
 n Speed n_{rated} Rated speed

Application areas are for instance:

- Single drives with changing loads
- Single drives with high starting duty
- Sensorless speed control of three-phase AC motors

Switching frequencies

On an inverter, the term "switching frequency" is understood to mean the frequency with which the input and outputs of the output module (inverter) are switched. On an inverter, the switching frequency can generally be set to values between 2 and 16 kHz, whereby the selection is based on the respective power output

As switching the modules cause heat losses, the inverter can provide higher output currents at low switching frequencies than at high frequencies. Additionally, it is distinguished between the operation at a permanently set switching frequency and a variably set switching frequency. Here, the switching frequency is automatically reduced as a function of the device utilisation.

At a higher switching frequency, the noise generation is less.

Features	Versions
Switching frequencies	<ul style="list-style-type: none"> • 2 kHz • 4 kHz • 8 kHz • 16 kHz • variable (automatic adjustment)



Enclosures

The degree of protection indicates the suitability of a motor for specific ambient conditions with regard to humidity as well as the protection against contact and the ingress of foreign particles. The degrees of protection are classified by EN 60529.

The first code number after the code letters IP indicates the protection against the ingress of foreign particles and dust. The second code number refers to the protection against the ingress of humidity.

Code number 1	Degree of protection	Code number 2	Degree of protection
0	No protection	0	No protection
1	Protection against the ingress of foreign particles $d > 50$ mm. No protection in case of deliberate access.	1	Protection against vertically dripping water (dripping water).
2	Protection against medium-sized foreign particles, $d > 12$ mm, keeping away fingers or the like.	2	Protection against diagonally falling water (dripping water), 15° compared to normal service position.
3	Protection against small foreign particles $d > 2.5$ mm. Keeping away tools, wires or the like.	3	Protection against spraying water, up to 60° from vertical.
4	Protection against granular foreign particles, $d > 1$ mm, keeping away tools, wire or the like.	4	Protection against spraying water from all directions.
5	Protection against dust deposits (dust-protected), complete protection against contact.	5	Protection against water jets from all directions.
6	Protection against the ingress of dust (dust-proof), complete protection against contact.	6	Protection against choppy seas or heavy water jets (flood protection).

Glossary

Abbreviation	Meaning
AIE	Acknowledge In Error, error acknowledgement
AIS	Acknowledge In Stop, restart acknowledgement
OFF state	Triggered signal status of the sensors
CCF	Common Cause Error (also β -value)
EC_FS	Error Class Fail Safe
EC_SS1	Error-Class Safe Stop 1
EC_SS2	Error-Class Safe Stop 2
EC_STO	Error-Class Safe Torque Off Stop 0
ON state	Signal status of the safety sensor in normal operation
FIT	Failure In Time, $1 \text{ FIT} = 10^{-9} \text{ Error/h}$
FMEA	Failure Mode and Effect Analysis
FSoE	FailSafe over EtherCAT
GSDML	Device description file with PROFINET-specific data to integrate the configuring software of a PROFINET controller.
HFT	Hardware Failure Tolerance
Cat.	Category in accordance with EN ISO 13849-1
OSSD	Output Signal Switching Device, tested signal output
PELV	Protective Extra Low Voltage, extra-low voltage with safe isolation
PL	Performance Level according to EN ISO 13849-1
PM	Plus-Minus – switched signal paths
PP	Plus-Plus – switched signal paths
PS	PROFIsafe
PWM	Pulse width modulation
SCS	Safe crawling speed
SD-In	Safe Digital Input
SD-Out	Safe Digital Output
SELV	Safety Extra Low Voltage
SFF	Safe Failure Fraction
SIL	Safety Integrity Level in accordance with IEC 61508

Lenze Drives GmbH
Postfach 101352, 31763 Hameln
Breslauer Straße 3, 32699 Extertal
GERMANY
HR Lemgo B 6478
Phone +49 5154 82-0
Fax +49 5154 82-2800
sales.de@lenze.com
www.Lenze.com