

## Operating instructions



---

# i510 protec frequency inverter

0.37 ... 7.5 kW

## General information

Overview

Information

Identification

Conventions



### Hardware overview of the inverter

Operating module (Keypad)  
or WLAN module or USB module

Network status LEDs

Inverter status LEDs



Memory module

**X3** Control terminals  
Standard I/O

**X2xx** Network, Option  
CANopen or Modbus RTU

**X100** Mains connection

**X9** Relay output  
Shield connection control cable

PE connection

**X105** Motor connection

Cable glands  
with shield connection for motor cable

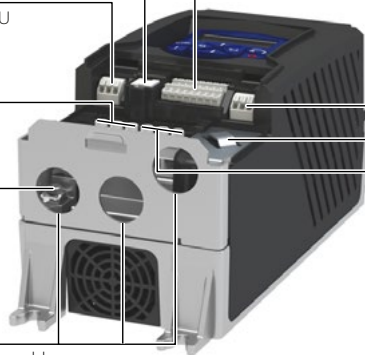

## General information

Overview

**Information**

Identification

Conventions



Please read this documentation carefully before installing the inverter and observe the safety instructions!

This document only includes the most frequently asked questions and presents them in a simplified form for a better overview. Detailed technical and functional explanations can be found in the comprehensive product documentation. The complete documentation, further information and tools regarding Lenze products can be found on the Internet:

[www.Lenze.com](http://www.Lenze.com)

### Application as directed

- The product is a piece of professional equipment intended for use by trades, specific professions or industry, and not for sale to the general public. IEC 60050 [IEV161-05-05]
- To prevent personal injury and damage to property, higher-level safety and protection systems must be used!
- All transport locks must be removed.
- The product may only be operated under the specified operating conditions and in the specified mounting positions.
- The product is only suitable for installation in control cabinets and, depending on the protection class, for wall mounting.
- The product must only be actuated with motors that are suitable for the operation with inverters.
- The product must not be operated in private areas, in potentially explosive atmospheres and in areas with harmful gases, oils, acids and radiation.

### Device-specific standards and directives

- The product meets the protection requirements of the Low-Voltage Directive 2014/35/EU.
- The harmonized standard EN IEC 61800-5-1 is used for the inverters. (Europe).
- UL 61800-5-1 and CAN/CSA C22.2 No.274 are the North American electrical safety standards.

### Relevant standards and directives for the operator

- If the product is used in accordance with the technical data, the drive systems comply with the EN IEC 61800-3 categories (Category C2 is similar to FCC Class A).
- The test voltage for insulation resistance tests between a control potential of 24 V and PE must be measured in accordance with EN IEC 61800-5-1.
- The cables must be installed in accordance with EN IEC 60204-1 or US National Electrical Code NFPA 70/Canadian Electrical Code C22.1.

### Commissioning

- Commissioning or starting the operation as directed of a machine with the product is prohibited until it has been ensured that the machine meets the regulations of the Machinery Directive 2006/42/EG and the standard EN IEC 60204-1.
- Commissioning or starting the operation as directed is only permissible if the EMC Directive 2014/30/EU is complied with.
- In residential areas, the product may cause EMC interference. The operator is responsible for executing the interference suppression measures.

## General information

Overview

Information

Identification

Conventions



### Identification of the products

I 5 1 A P 137<sup>1</sup> A<sup>2</sup> 0 0 0 0 0<sup>3</sup> K<sup>4</sup> 00S<sup>5</sup>

1

Rated power	
	[kW]
137	0.37
175	0.75
211	1.1
215	1.5
222	2.2
230	3
240	4
255	5.5

2

Mains voltage and connection type	
A	1/N/PE AC 120 V
C	3/PE AC 230/240 V
D	1/N/PE AC 230/240 V 3/PE AC 230/240 V
F	3/PE AC 400 V 3/PE AC 480 V

3

Application area	
0	Default parameter setting: Region EU (50-Hz networks)
1	Default parameter setting: Region US (60-Hz networks)

4

Product extension	
0	Standard I/O
K	Keypad with Standard I/O
U	USB module with Standard I/O
W	WLAN module with Standard I/O

5

Network	
00S	Without
02S	CANopen
03S	Modbus RTU

## General information

Overview

Information

Identification

Conventions



### Numeric notation

As a rule, a period is used as a decimal separator in this documentation.

Example: 1234.56



### Design of safety instructions

Safety instructions protect against injury to persons or damage to property. The measures described for the prevention of hazards must be complied with.



#### **DANGER!**

Indicates an extremely hazardous situation. If this instruction is ignored, serious, irreversible injury or deadly injuries may result.



#### **WARNING!**

Indicates an extremely hazardous situation. If this instruction is ignored, serious, irreversible injury or deadly injuries may result.



#### **CAUTION!**

Indicates an extremely hazardous situation. If this instruction is ignored, serious, irreversible injury or deadly injuries may result.



#### **NOTE**

Indicates a material hazard. If this instruction is ignored, damage to property may result.

## Safety instructions

Basic safety instructions

Residual hazards



### Basic safety instructions



Disregarding the following basic safety instructions and safety information may lead to severe personal injury and damage to property!

- Only use the product as directed.
- Never commission the product in the event of visible damage.
- Never modify the product technically.
- Never commission the product before assembly has been completed.
- Never operate the product without the required covers.
- Connect/disconnect all pluggable connections only in deenergized condition!
- Only remove the product from the installation in the deenergized state.
- The product can - depending on their degree of protection - have live, movable or rotating parts during or after operation. Surfaces can be hot. Surfaces can be hot.
- Observe all specifications of the corresponding documentation supplied. This is the condition for safe and trouble-free operation and the achievement of the specified product features.
- The procedural notes and circuit details given in the associated documentation are suggestions and their transferability to the respective application must be checked. The manufacturer of the product does not take responsibility for the suitability of the process and circuit proposals.
- All work with and on the product may only be carried out by qualified personnel. IEC 60364 and CENELEC HD 384 define the qualifications of these persons:
  - They are familiar with installing, mounting, commissioning, and operating the product.
  - They have the corresponding qualifications for their work.
  - They know and can apply all regulations for the prevention of accidents, directives, and laws applicable at the place of use.

### NOTE

#### Device protection

Carry out insulation resistance tests between 24-V control potential terminals and PE. The maximum test voltage must not exceed 110 V DC.

### NOTE

#### Foreseeable misuse

Inverters are not to be operated with DC motors.

## Safety instructions

Basic safety instructions

Residual hazards



### Residual hazards

The user must take the residual hazards mentioned into consideration in the risk assessment for his/her machine/system. If the above is disregarded, this may result in injuries to persons and material damage!



### Dangerous electrical voltage

During operation and up to 20 minutes after power-off, hazardous electrical voltages may be present at the connections of the product.

The leakage current against earth (PE) is > 3.5 mA AC or > 10 mA DC.

Possible consequences

- Death or serious injury from electric shock

Protective measures

- Any work on the product must only be carried out in a deenergized state.
- Check that no voltage is present!
- After switching off the mains voltage, observe the signs on the product.
- After switching off, wait until the drive is at a standstill.
- Implement the measures required by EN IEC 61800-5-1 or EN IEC 60204-1, i.e. fixed installation and standards-compliant PE connection.

### Degree of protection - Protection of persons and device protection

Information applies to the mounted and ready-for-use state.

### Motor protection

With some settings of the inverter, the connected motor can be overheated.

- E.g. via the operation of self-ventilated motors at low speeds over a long period.
- E.g. by operating DC-injection braking over a long period.

### Product

Observe the warning signs on the product!



#### Dangerous electrical voltage

Before working on the product, check whether all power connections are deenergized!

After mains disconnection, the power terminals carry the hazardous electrical voltage for the time specified next to the symbol!



#### Electrostatic sensitive devices

Before working on the product, the staff must ensure to be free of electrostatic charge.



#### High leakage current

Carry out fixed installation and PE connection in compliance with the following standard:

EN IEC 61800-5-1/EN IEC 60204-1



#### Hot surface

Use personal protective equipment or wait until the device has cooled down!

### Protection of the machine/system

- Drives can reach dangerous overspeeds, e.g. from setting high output frequencies for motors and machines which are not suitable. The inverters do not provide any protection against such operating conditions. Use additional external components for this purpose.
- Only switch the contactor in the motor cable when the inverter is inhibited. Switching them when the inverter is enabled is only permissible when no monitoring components respond.

### Motor

In the event of a short circuit of two power transistors, a residual movement of up to 180°/number of pole pairs on the motor may occur (e.g. 4-pole motor): Residual movement max.  $180^\circ/2 = 90^\circ$ .

## Technical data

<b>Standards and operating conditions</b>				
<b>Approvals for the market</b>		CE (European Union)		Further information and certificates of approval: <a href="https://www.lenze.com/en-us/products/inverters/frequency-inverters/i510-protect-frequency-inverter/">https://www.lenze.com/en-us/products/inverters/frequency-inverters/i510-protect-frequency-inverter/</a>
		UKCA (Great Britain)		
		UL (USA)		
		CSA (Canada)		
		CCC (China)		
		EAC (Belarus, Russia, Kyrgyzstan, Kazakhstan and Armenia)		
		UkSepro (Ukraine)		
<b>Environment</b>		RoHS		
<b>Energy efficiency</b>	<b>High Efficiency</b>	EN IEC 61800-9-2	Class IE2	
<b>Degree of protection</b>	<b>EN</b>	EN IEC 60529	IP20	Data applies to operationally ready mounted state and not in wire range of terminals
	<b>NEMA</b>	NEMA 250	Type 1	
	<b>UL</b>	UL 50	Type 1	
<b>Climate</b>	<b>Operation</b>	EN 60721-3-3:1995 + A2:1997	3K3 (-30 ... +55°C)	Operation at a switching frequency of 2 or 4 kHz: Above +45°C: reduce rated output current by 2.5 %/°C
				Operation at a switching frequency of 8, 12 or 16 kHz: Above +40°C: reduce rated output current by 2.5 %/°C
			3C2	For chemically active substances
			3S2	For mechanically active substances
<b>Power systems</b>			TT, TN	Voltage to earth: max. 300 V
<b>Mains switching</b>			3 x within one minute possible	
<b>Max. motor cable length</b>			Device-specific; see technical data in project planning document	
<b>Max. output frequency</b>			0 Hz ... 599 Hz	
<b>Overload capacity</b>			Heavy Duty: 200 % for 3s, 150 % for 60s Light Duty 167 % for 3 s, 125 % for 60 s	

Further standards and operating conditions can be found in the project planning documents.



## Mechanical installation



### Dimensions and assembly

#### NOTE

The specified installation clearances are minimum dimensions to ensure a sufficient air circulation for cooling purposes. They do not take into account the bending radii of the connecting cables.

Inverter	Rated power	Weight	H	W	D	H1	D1	Screws	E1	E2
	[kW]								[kg]	[mm]
<b>1-phase mains connection 120 V devices</b>										
I51APxxxA	0.37 ... 0.75	1.4	200	100	104	220	72	4x M5	>50	>50
<b>1-/3-phase mains connection 230/240 V devices</b>										
I51APxxxD	0.37 ... 0.75	1.4	200	100	104	220	72	4x M5	>50	>50
I51APxxxD	1.1 ... 1.5	1.5	200	100	104	220	72	4x M5	>50	>50
I51APxxxD	2.2	1.5	230	100	104	220	72	4x M5	>50	>50
I51APxxxC	3 ... 4	1.6	230	100	104	220	72	4x M5	>50	>50
<b>3-phase mains connection 400/480 V devices</b>										
I51APxxxF	0.75	1.4	200	100	104	220	72	4x M5	>50	>50
I51APxxxF	1.1 ... 2.2	1.5	200	100	104	220	72	4x M5	>50	>50
I51APxxxF	3 ... 5.5	1.6	230	100	104	220	72	4x M5	>50	>50



## Electrical installation

Preparation

Connection diagram

1-phase | 120 V

1-phase | 230/240 V

3-phase | 230/240 V

3-phase | 400 V

3-phase | 480 V

Control terminals

Relay output

Networks



### Preparation

For wiring, the housing cover must be removed:

1. Press a screwdriver into the housing slot on the bottom of the device.
2. Remove housing cover

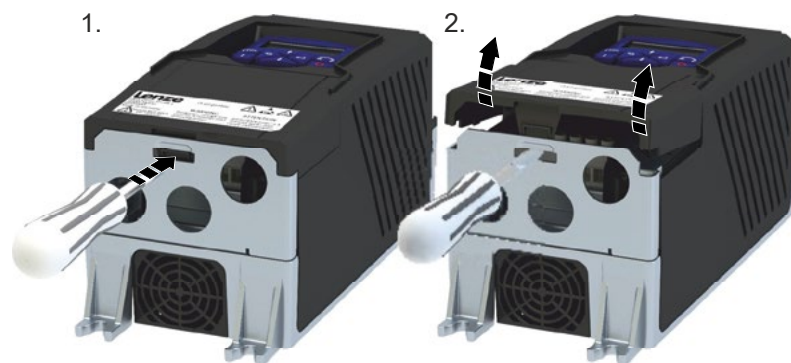

After completing the electrical installation, carefully press the housing cover back on until it clicks into place to ensure that the protection class is maintained.

### NOTE

#### Assembly does not satisfy protection class requirements

Possible consequences: Damage to property due to ingress of humidity and foreign bodies.

- All cable glands and mounting parts must at least correspond to the protection class of the inverter.
- All openings in the housing must be closed according to the protection class.

### Cable gland with shield connection

Thanks to its protection class, the inverter can be installed directly on the wall. For connection, the device has cable glands on the bottom.

Mains cable	M20 / ½" conduit hub
Motor cable	M20 / ½" conduit hub
Control cables, network cables	M20 / ½" conduit hub

≤ 2.2 kW



≥ 3 kW



When using electrically conductive conduits:

- Individual unshielded conductors or multi-core unshielded cables which have been laid in a metallic conduit are considered equivalent for the purposes of EMC conformity of a shielded motor cable.
- Both a rigid and a flexible metallic conduit are permissible.
- The conduit must be connected properly at both ends using metallic screwed connections on the inverter and on the motor so as to connect all devices.
- Non-metallic junctions or screwed connections which interrupt the electrical conductivity of the metallic conduit are not permissible.

## Electrical installation

Preparation

**Connection diagram**

1-phase | 120 V

1-phase | 230/240 V

3-phase | 230/240 V

3-phase | 400 V

3-phase | 480 V

Control terminals

Relay output

Networks



### Connection diagram

The connection diagram is considered exemplary for all voltage and power classes.

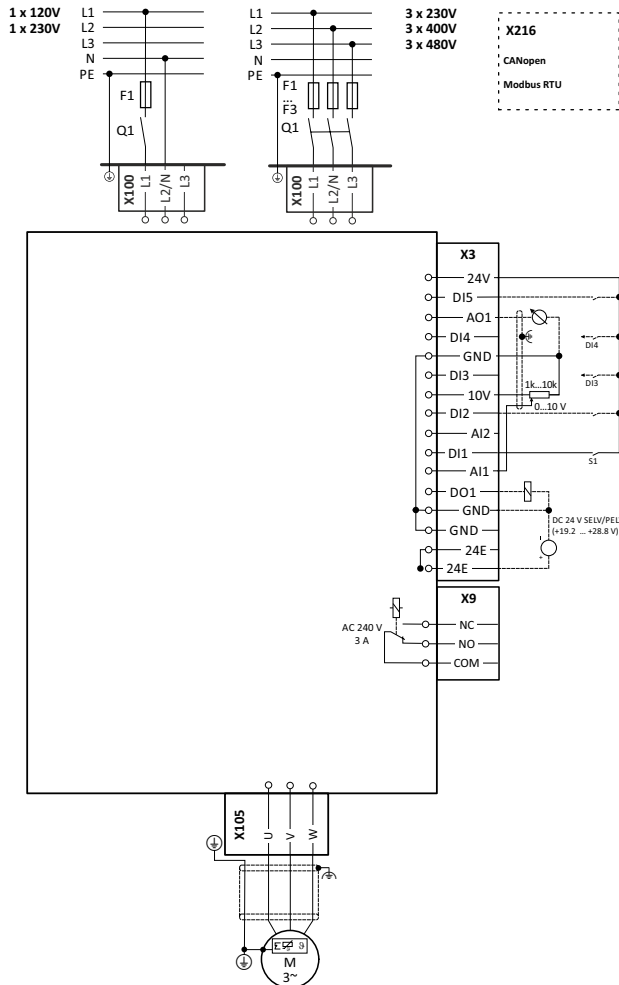

### EMC-compliant installation

- Please use sufficiently conductive shield connections.
- Connect the housing with shielding effect to the grounded mounting plate with a surface as large as possible, e.g. of inverters and RFI filters.
- Use central earthing points.

The following example shows the effective wiring.

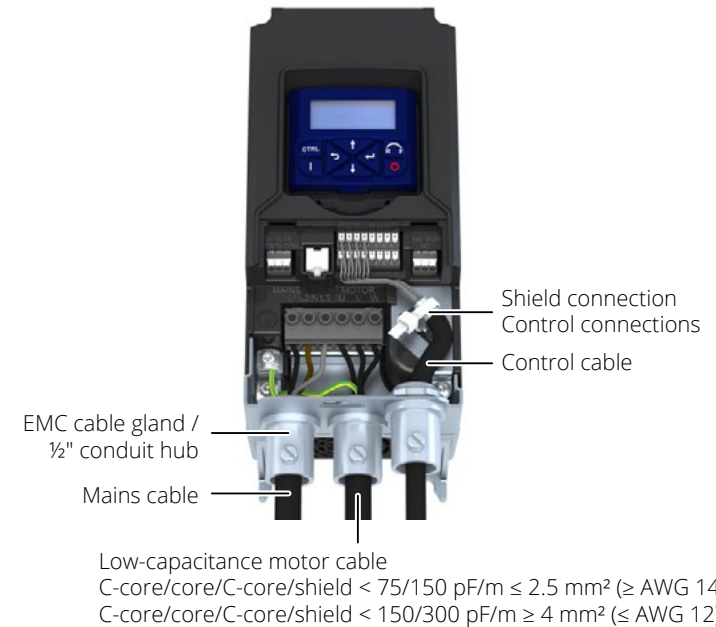

## Electrical installation

Preparation

Connection diagram

**1-phase | 120 V**

1-phase | 230/240 V

3-phase | 230/240 V

3-phase | 400 V

3-phase | 480 V

Control terminals

Relay output

Networks



### 1-phase mains connection 120 V (90 V ... 132 V, 45 Hz ... 65 Hz)

#### Terminal data

Inverter		I51APxxxA		
Rated power	kW	0.37 ... 0.75		
Connection		Mains connection X100	PE connection	Motor connection X105
Connection type		Screw terminal	Screw	Screw terminal
Max. cable cross-section	mm <sup>2</sup>	4	6	4
Stripping length	mm	8	10	8
Tightening torque	Nm	0.6	2	0.6
Required tool		⊖ 0.5 x 3.0	⊕ TX20	⊖ 0.5 x 3.0

#### Rated data and fusing data

Inverter		I51AP	
		137A	175A
Rated power	kW	0.37	0.75
Rated output current (8 kHz)	A	2.4	4.2
Max. output current *	A	4.8	8.4
Operation without mains choke			
Rated mains current	A	9.6	16.8
Fuse			
Characteristic		gG/gL or gRL	
Max. rated current	A	32	32
Max. short circuit current (SCCR)	kA	5	5
Circuit breaker			
Characteristic		B	
Max. rated current	A	32	32
Max. short circuit current (SCCR)	kA	5	5
Residual current device (RCD)		≥ 30 mA, type B	

\* Overload time = 3 s, recovery time = 12 s

## Electrical installation

Preparation

Connection diagram

1-phase | 120 V

**1-phase | 230/240 V**

3-phase | 230/240 V

3-phase | 400 V

3-phase | 480 V

Control terminals

Relay output

Networks



### 1-phase mains connection 230/240 V (170 V ... 264 V, 45 Hz ... 65 Hz)

#### Terminal data

Inverter		I51APxxxD								
Rated power	kW	0.37 ... 1.5		2.2		0.37 ... 1.5		2.2		
Connection		Mains connection X100			PE connection		Motor connection X105			
Connection type		Screw terminal			Screw		Screw terminal			
Max. cable cross-section	mm <sup>2</sup>	4		6		6		6		
Stripping length	mm	8		8		10		8		
Tightening torque	Nm	0.6		0.7		2		0.6		0.7
Required tool		⊖ 0.5 x 3.0		⊖ 0.6 x 3.5		⊕ TX20		⊖ 0.5 x 3.0		⊖ 0.6 x 3.5

#### Rated data (Heavy Duty) und fusing data

Inverter		I51AP				
		137D	175D	211D	215D	222D
Rated power	kW	0.37	0.75	1.1	1.5	2.2
Rated output current (8 kHz)	A	2.4	4.2	6	7	9.6
Max. output current *	A	4.8	8.4	12	14	19.2
Operation without mains choke						
Rated mains current	A	5.7	10	14.3	16.7	22.5
Fuse						
Characteristic		gG/gL or gRL				
Max. rated current	A	40	40	40	40	40
Max. short circuit current (SCCR)	kA	5	5	5	5	5
Circuit breaker						
Characteristic		B				
Max. rated current	A	32	32	32	32	32
Max. short circuit current (SCCR)	kA	5	5	5	5	5
Residual current device (RCD)		≥ 30 mA, type B				

#### Rated data (light duty)

Inverter		I51AP				
		137D	175D	211D	215D	222D
Rated power	kW	0.55	1.1	1.5	2.2	3
Rated output current (4 kHz)	A	2.9	5	7.2	8.4	11.5
Max. output current *	A	4.8	8.4	12	14	19.2

\* Overload time = 3 s, recovery time = 12 s

## Electrical installation

Preparation

Connection diagram

1-phase | 120 V

1-phase | 230/240 V

**3-phase | 230/240 V**

3-phase | 400 V

3-phase | 480 V

Control terminals

Relay output

Networks



### 3-phase mains connection 230/240 V (195 V ... 264 V, 45 Hz ... 65 Hz)

#### Terminal data

Inverter		I51APxxxD (1/3-phase), I51APxxxC (3-phase)					
Rated power	kW	0.37 ... 1.5	2.2 ... 4	0.37 ... 4	0.37 ... 1.5	2.2 ... 4	
Connection		Mains connection X100		PE connection	Motor connection X105		
Connection type		Screw terminal		Screw	Screw terminal		
Max. cable cross-section	mm <sup>2</sup>	4	6	6	4	6	
Stripping length	mm	8	8	10	8	8	
Tightening torque	Nm	0.6	0.7	2	0.6	0.7	
Required tool		⊖ 0.5 x 3.0	⊖ 0.6 x 3.5	⊕ TX20	⊖ 0.5 x 3.0	⊖ 0.6 x 3.5	

#### Rated data (Heavy Duty) und fusing data

Inverter		I51AP						
		137D	175D	211D	215D	222D	230C	240C
Rated power	kW	0.37	0.75	1.1	1.5	2.2	3	4
Rated output current (8 kHz)	A	2.4	4.2	6	7	9.6	12	16.5
Max. output current *	A	4.8	8.4	12	14	19.2	24	33
Operation without mains choke								
Rated mains current	A	3.9	6.4	7.8	9.5	13.6	15	20.6
Fuse								
Characteristic		gG/gL or gRL						
Max. rated current	A	40	40	40	40	40	80	80
Max. short circuit current (SCCR)	kA	5	5	5	5	5	5	5
Circuit breaker								
Characteristic		B						
Max. rated current	A	32	32	32	32	32	80	80
Max. short circuit current (SCCR)	kA	5	5	5	5	5	5	5
Residual current device (RCD)		≥ 30 mA, type B						

#### Rated data (light duty)

Inverter		I51AP						
		137D	175D	211D	215D	222D	230C	240C
Rated power	kW	0.55	1.1	1.5	2.2	3	4	5.5
Rated output current (4 kHz)	A	2.9	5	7.2	8.4	11.5	14.4	19.8
Max. output current *	A	4.8	8.4	12	14	19.2	24	33

\* Overload time = 3 s, recovery time = 12 s



## Electrical installation

Preparation

Connection diagram

1-phase | 120 V

1-phase | 230/240 V

3-phase | 230/240 V

**3-phase | 400 V**

3-phase | 480 V

Control terminals

Relay output

Networks



### 3-phase mains connection 400 V (340 V ... 528 V, 45 Hz ... 65 Hz)

#### Terminal data

Inverter		I51APxxxF					
Rated power	kW	0.75 ... 2.2	3 ... 5.5	0.75 ... 5.5	0.75 ... 2.2	3 ... 5.5	
Connection		Mains connection X100		PE connection	Motor connection X105		
Connection type		Screw terminal		Screw	Screw terminal		
Max. cable cross-section	mm <sup>2</sup>	4	6	6	4	6	
Stripping length	mm	8	8	10	8	8	
Tightening torque	Nm	0.6	0.7	2	0.6	0.7	
Required tool		⊖ 0.5 x 3.0	⊖ 0.6 x 3.5	⊕ TX20	⊖ 0.5 x 3.0	⊖ 0.6 x 3.5	

#### Rated data (Heavy Duty) und fusing data

Inverter		I51AP						
		175F	211F	215F	222F	230F	240F	255F
Rated power	kW	0.75	1.1	1.5	2.2	3	4	5.5
Rated output current (8 kHz)	A	2.4	3.2	3.9	5.6	7.3	9.5	13
Max. output current *	A	4.8	6.4	7.8	11.2	14.6	19	26
Operation without mains choke								
Rated mains current	A	3.3	4.4	5.4	7.8	9.6	12.5	17.2
Fuse								
Characteristic		gG/gL or gRL						
Max. rated current	A	32	32	32	32	40	40	40
Max. short circuit current (SCCR)	kA	5	5	5	5	5	5	5
Circuit breaker								
Characteristic		B						
Max. rated current	A	32	32	32	32	32	32	32
Max. short circuit current (SCCR)	kA	5	5	5	5	5	5	5
Residual current device (RCD)		≥ 30 mA, type B						

#### Rated data (light duty)

Inverter		I51AP						
		175F	211F	215F	222F	230F	240F	255F
Rated power	kW	1.1	1.5	2.2	3	4	5.5	7.5
Rated output current (4 kHz)	A	2.9	3.8	4.7	6.7	8.8	11.9	15.6
Max. output current *	A	4.8	6.4	7.8	11.2	14.6	19	26

\* Overload time = 3 s, recovery time = 12 s

## Electrical installation

Preparation

Connection diagram

1-phase | 120 V

1-phase | 230/240 V

3-phase | 230/240 V

3-phase | 400 V

**3-phase | 480 V**

Control terminals

Relay output

Networks



### 3-phase mains connection 480 V (340 V ... 528 V, 45 Hz ... 65 Hz)

#### Terminal data

Inverter		I51APxxxF					
Rated power	kW	0.75 ... 2.2	3 ... 5.5	0.75 ... 5.5	0.75 ... 2.2	3 ... 5.5	
Connection		Mains connection X100		PE connection	Motor connection X105		
Connection type		Screw terminal		Screw	Screw terminal		
Max. cable cross-section	mm <sup>2</sup>	4	6	6	4	6	
Stripping length	mm	8	8	10	8	8	
Tightening torque	Nm	0.6	0.7	2	0.6	0.7	
Required tool		⊖ 0.5 x 3.0	⊖ 0.6 x 3.5	⊕ TX20	⊖ 0.5 x 3.0	⊖ 0.6 x 3.5	

#### Rated data (Heavy Duty) und fusing data

Inverter		I51AP						
		175F	211F	215F	222F	230F	240F	255F
Rated power	kW	0.75	1.1	1.5	2.2	3	4	5.5
Rated output current (8 kHz)	A	2.1	3	3.5	4.8	6.3	8.2	11
Max. output current *	A	4.2	6	7	9.6	12.6	16.4	22
Operation without mains choke								
Rated mains current	A	2.8	3.7	4.5	6.5	8	10.5	14.3
Fuse								
Characteristic		gG/gL or gRL						
Max. rated current	A	32	32	32	32	40	40	40
Max. short circuit current (SCCR)	kA	5	5	5	5	5	5	5
Circuit breaker								
Characteristic		B						
Max. rated current	A	32	32	32	32	32	32	32
Max. short circuit current (SCCR)	kA	5	5	5	5	5	5	5
Residual current device (RCD)		≥ 30 mA, type B						

#### Rated data (light duty)

Inverter		I51AP						
		175F	211F	215F	222F	230F	240F	255F
Rated power	kW	1.1	1.5	2.2	3	4	5.5	7.5
Rated output current (4 kHz)	A	2.5	3.6	4.2	5.8	7.6	9.8	13.2
Max. output current *	A	4.2	6	7	9.6	12.6	16.4	22

\* Overload time = 3 s, recovery time = 12 s



## Electrical installation

- Preparation
- Connection diagram
- 1-phase | 120 V
- 1-phase | 230/240 V
- 3-phase | 230/240 V
- 3-phase | 400 V
- 3-phase | 480 V
- Control terminals
- Relay output
- Networks

- 
- 
- 
- 
- 
- 
- 
- 
- 

### Control terminals X3

<b>Connection type</b>		Spring terminal, not pluggable
<b>Max. cable cross-section</b>	mm <sup>2</sup>	1.5
<b>Stripping length</b>	mm	9
<b>Required tool</b>		⊖ 0.4 x 2.5
<b>Application</b>	D11 D12 D13 D14 D15	Digital inputs HIGH active/LOW active switchable LOW = 0 ... +3 V HIGH = +12 V ... +30 V
	DO1	Digital output Max. 100 mA for DO1 and 24-V output
	AI1 AI2	Analog inputs Can optionally be used as voltage input or current input.
	AO1	Analog output Can be optionally used as voltage output or current output.
	24E	24-V input For mains-independent power DC supply of control electronics (including communication). Max. 1 A
	10 V	10-V output Primarily for the supply of a potentiometer (1 ... 10 kΩ). Max. 10 mA
	24V	24-V output Primarily for the supply of digital inputs. Max. 100 mA for DO1 and 24-V output

#### NOTE

For voltage supply with DC 24 V (± 20 %), use only a safely separated power supply unit in accordance with prevailing SELV/PELV requirements.

The terminal designations can be found on the inside of the cover.

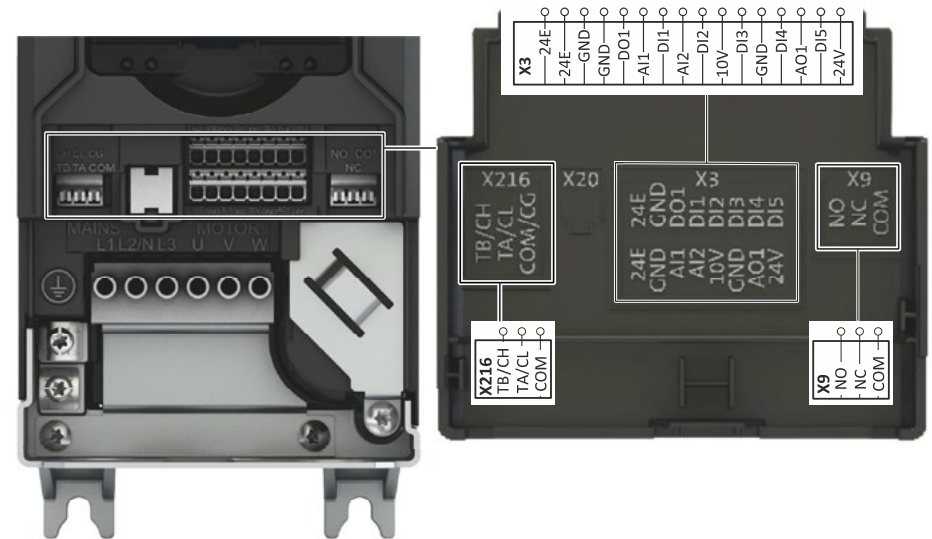

## Electrical installation

Preparation

Connection diagram

1-phase | 120 V

1-phase | 230/240 V

3-phase | 230/240 V

3-phase | 400 V

3-phase | 480 V

Control terminals

Relay output

Networks



### Relay output X9

The relay is not suitable for direct switching of an electromechanical holding brake. Use a corresponding suppressor circuit in case of an inductive or capacitive load.

<b>Connection type</b>		Spring terminal, not pluggable
<b>Max. cable cross-section</b>	mm <sup>2</sup>	1.5
<b>Stripping length</b>	mm	9
<b>Required tool</b>		⊖ 0.4 x 2.5
<b>Application</b>	COM	Common contact
	NC	Normally-closed contact
	NO	Normally-open contact
<b>Max. switching voltage/switching current</b>		AC 240 V/3 A
		DC 24 V/2 A
		DC 240 V/0.16 A

The terminal designations can be found on the inside of the cover.

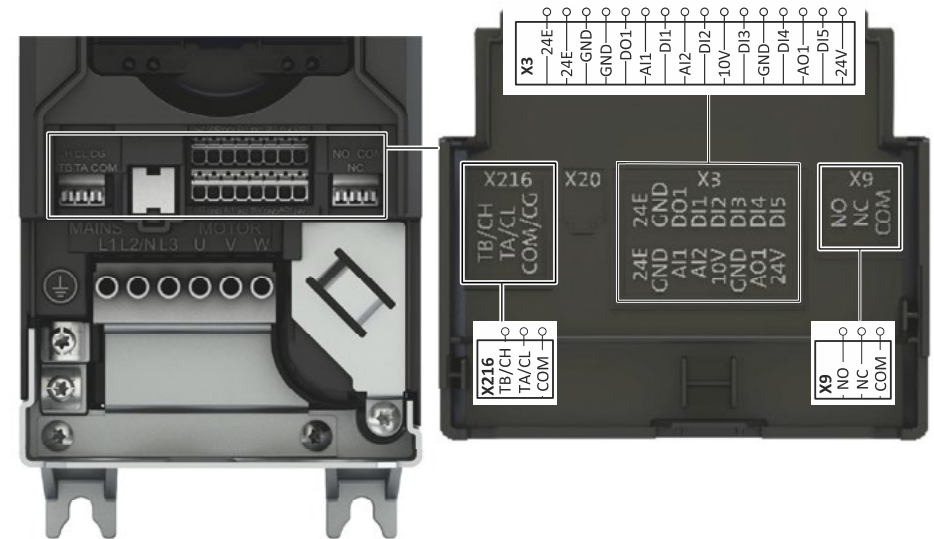

## Electrical installation

Preparation

Connection diagram

1-phase | 120 V

1-phase | 230/240 V

3-phase | 230/240 V

3-phase | 400 V

3-phase | 480 V

Control terminals

Relay output

**Networks**



### Networks

Network	CANopen	Modbus RTU
Connection	X216	
Connection type	Spring terminal, not pluggable	
Max. cable cross-section	mm <sup>2</sup>	1.5
Stripping length	mm	9
Required tool	⊖ 0.4 x 2.5	

The network must be terminated with a 120 Ω resistor at the physically first and last node.  
Connect the resistor to terminals TB/CH and TA/CL.





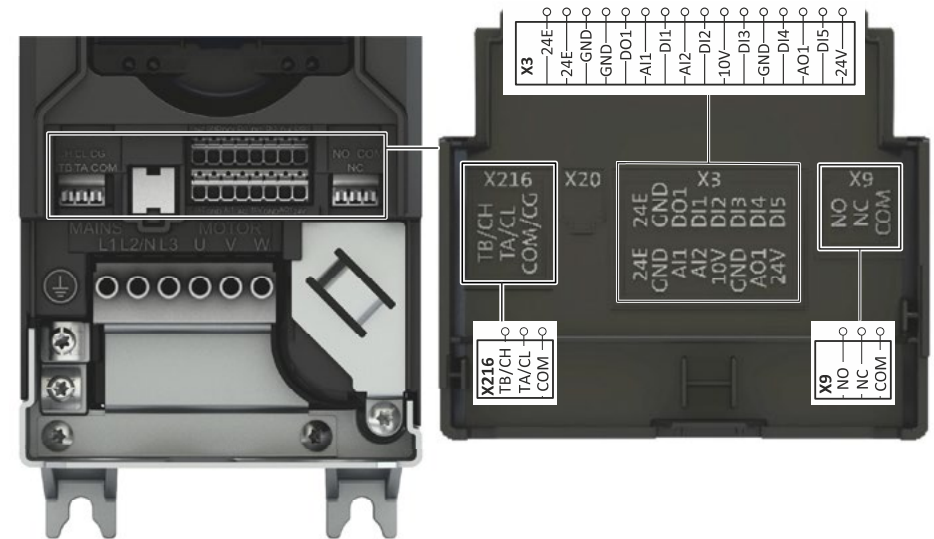











- Node address = setting in P510.01
- Baud rate = setting in P510.02
- For Modbus RTU, the baud rate and parity are detected automatically.

The terminal designations can be found on the inside of the cover.



## Commissioning

- Initial switch-on
  - Important notes
  - Keypad-module
  - Keypad control
  - Terminal control
  - Extended terminal control
  - Parameter overview
  - Favorites
  - Basic setting
  - Motor control
- Additional functions

- 
- 
- 
- 
- 
- 
- 
- 
- 
- 
- 
- 
- 
- 
- 
- 
- 

### Initial switch-on

 **DANGER!**

#### Unexpected states during commissioning

Incorrect wiring can cause unexpected states during the commissioning phase.  
Possible consequences: Death, severe injuries, or damage to property

- Wiring must be complete and correct.
- Wiring must be free of short circuits and earth faults.
- The motor circuit configuration (star/delta) must be adapted to the inverter.
- The motor must be connected in-phase (rotating direction).
- Check the "emergency off" function of the overall system.
- Clear hazardous area.
- Observe safety instructions and safety clearances.

---









Preconditions:

- The power connections must be wired.
- The digital inputs X3/DI1 (start/stop), X3/DI3 (reversal) and X3/DI4 (frequency preset 20 Hz) must be wired.
- The analog input X3/AI1 must not be wired or connected to GND.

- Switch on mains voltage.
- Check readiness for operation.
- Observe LED status displays "RDY" and "ERR" on the inverter front panel.

## Commissioning

- Initial switch-on
  - Important notes**
  - Keypad-module
  - Keypad control
  - Terminal control
  - Extended terminal control
  - Parameter overview
  - Favorites
  - Basic setting
  - Motor control
- Additional functions

- 
- 
- 
- 
- 
- 
- 
- 
- 

### Important notes

 **DANGER!**

#### Unexpected and dangerous motor movements and system movements

Incorrect settings during commissioning may cause unexpected and dangerous motor and system movements.

Possible consequences: Death, severe injuries, or damage to property

- Clear hazardous area.
- Observe safety instructions and safety clearances.

---

Instead of the keypad module, the inverter is also available with the following accessories from the factory:

- WLAN module
- USB module
- without module

#### Keypad-module

Commissioning with the keypad module is described on the following pages.

#### WLAN module

A connection to the WLAN module is established upon entering the connection data.

Default setting:

- IP address: 192.168.178.1
- SSID: "Product type"\_"10-digit identification"
- WLAN password: password

#### Engineering Tool »EASY Starter«

Commissioning and diagnostics can be carried out with the »EASY Starter« engineering tool. For communication, a USB module on the inverter and a standard USB cable (A plug to micro B plug) is required.

#### SMART Keypad App

The Lenze SMART Keypad App for Android or iOS allows you to diagnose and parameterize an inverter. A WLAN module on the inverter is required for communication.

- Ideal for the parameterization of simple applications such as a conveyor belt.
- Ideal for the diagnostics of the inverter.

The app can be found in the Google Play Store or in the Apple App Store.



Android



iOS

## Commissioning

- Initial switch-on
  - Important notes
  - Keypad-module
  - Keypad control
  - Terminal control
  - Extended terminal control
  - Parameter overview
  - Favorites
  - Basic setting
  - Motor control
- Additional functions



### Keypad module – Functions of the keys

Key	Actuation	Action
Up arrow key Down arrow key	press briefly	<ul style="list-style-type: none"> <li>· Navigation in the menu</li> <li>· Parameter alteration</li> </ul>
Enter key	press briefly	<ul style="list-style-type: none"> <li>Go to Menu/Parameter</li> <li>· Confirm parameter</li> </ul>
	press and hold for 3s	Save parameter ("P.SAVED" appears on screen when parameter is saved.)
Back key	press briefly	Quit Menu/Parameters
CTRL key	press briefly	Activate keypad control
Start key	press briefly	Start motor
R/F key	press briefly	Change rotating direction
Stop key	press briefly	Stop motor

- The motor must be at standstill before parameters can be changed or confirmed.
- The settings are saved temporarily until the motor is switched off again. Press and hold the enter key for 3 s to save the settings permanently.

### Example of the keypad handling

Function assignment for digital output DO1 with parameter P420.02:

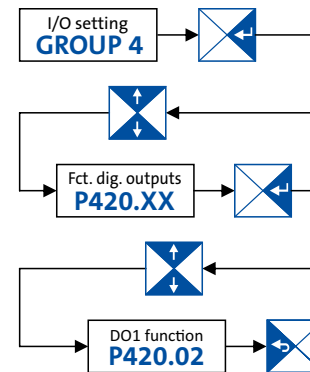

## Commissioning

- Initial switch-on
  - Important notes
  - Keypad-module
  - Keypad control
  - Terminal control
  - Extended terminal control
  - Parameter overview
  - Favorites
  - Basic setting
  - Motor control
- Additional functions



**Keypad control**

Activate temporary keypad control:

1. Press the CTRL key to activate the keypad control.
2. Press the enter key to confirm the change.



Deactivate temporary keypad control:

1. Press the CTRL key to deactivate the keypad control.
2. Press the enter key to confirm the change.



Activate permanent keypad control:

If the keypad does not have a CTRL key, the motor control is activated via the following parameters:

- Set P200.00 to 1.
- Set P201.01 to 1.
- Set P400.01 to 1.
- Set P400.02 to 1.



Start/control/stop motor with keypad:

1. Press the start key to start the motor.
  - The keypad shows the motor speed.
2. Change the frequency setpoint using the up arrow key or the down arrow key.
3. Press the stop key to stop the motor.



Reverse rotating direction:

1. Press the R/F key.
2. Press the enter key to confirm the reversal of rotating direction.



Additional functions



Additional functions



Additional functions



Additional functions



Additional functions



Additional functions



Additional functions



Additional functions



Additional functions



Additional functions



Additional functions

## Commissioning

- Initial switch-on
  - Important notes
  - Keypad-module
  - Keypad control
  - Terminal control
  - Extended terminal control
  - Parameter overview
  - Favorites
  - Basic setting
  - Motor control
- Additional functions



### Quick commissioning – terminal control

The following quick overview with graphical parameter representation is sufficient for commissioning many applications with terminal control. Further setting options are described in this document or in the commissioning document.

1. Load default setting: Set P700.01 to 1.
2. Set the following parameters for V/f characteristic control:
  - P208.01: Mains voltage
  - P303.01: V/f characteristic data: Base voltage
  - P303.02: V/f characteristic data: Base frequency
  - P210.00: Minimum frequency
  - P211.00: Maximum frequency
  - P220.00: Acceleration time 1
  - P221.00: Deceleration time 1
  - P430.02: Analog input 1: Min frequency value
  - P430.03: Analog input 1: Max frequency value

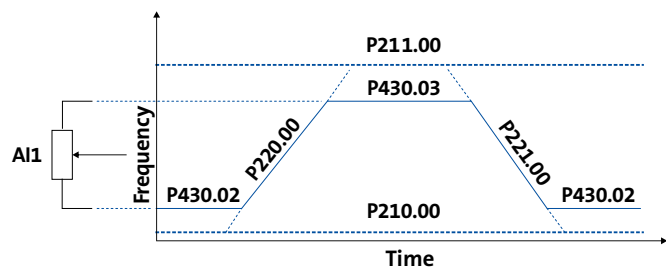

3. Save settings: Press and hold the enter key for 3 s.
4. With the wiring shown on the right, the inverter can be operated using the control terminals.

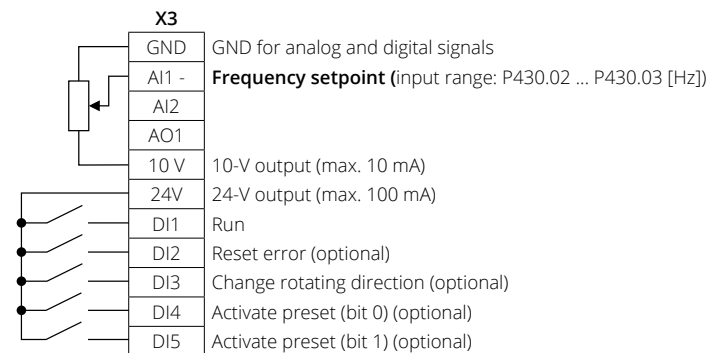

Preset 1 is activated if DI4 is connected.  
 Preset 2 is activated if DI5 is connected.  
 Preset 3 is activated if DI4 and DI5 are connected at the same time.



## Commissioning

- Initial switch-on
- Important notes
- Keypad-module
- Keypad control
- Terminal control
- Extended terminal control
- Parameter overview
- Favorites
- Basic setting
- Motor control

Additional functions

### Extended terminal control

The following illustration shows a more extensive wiring of the control terminals linked with the respective parameters.

**Default setting**

P201.01  
(configured AI1 as standard setpoint)

---

P400.02 Run

P400.04 Reset error

P400.13 Change rotating direction

P400.18 Activate preset (bit 0)

P400.19 Activate preset (bit 1)

P420.02 DO1 triggered at "releasing the brake"

---

P420.01 Relay triggered at "ready for operation"

**X3**

24E	Optional external 24 V supply
GND	GND for analog and digital signals
AI1 -	Analog input 1
AI2	Analog input 2
AO1	Analog output 1
10 V	10-V output (max. 10 mA)
24V	24-V output (max. 100 mA)
DI1	Digital input 1
DI2	Digital input 2
DI3	Digital input 3
DI4	Digital input 4
DI5	Digital input 5
DO1	Digital output 1
GND	GND for analog and digital signals

**X9**

NO	Relay NO contact
COM	Relay centre contact
NC	Relay NC contact

Setpoint selection and configuration:

DI5	DI4	Setpoint	Configuration	Default setting	
0	0	Analog input 1	P430.01	AI1 input area	0 ... 10 VDC
			P430.02	AI1 freq @ min	0.0 Hz
			P430.03	AI1 freq @ max	50.0 Hz / 60.0 Hz*
0	1	Preset value 1	P450.01	Freq. preset 1	20.0 Hz
1	0	Preset value 2	P450.02	Freq. preset 2	40.0 Hz
1	1	Preset value 3	P450.03	Freq. preset 3	50.0 Hz / 60.0 Hz*

\* Depending on whether device is for 50-Hz mains or 60-Hz mains

## Commissioning

- Initial switch-on
  - Important notes
  - Keypad-module
  - Keypad control
  - Terminal control
  - Extended terminal control
  - Parameter overview
  - Favorites
  - Basic setting
  - Motor control
- Additional functions



**The most important parameters at a glance**

This chapter contains the most important parameters and selections.



You can find a detailed description in the commissioning document:  
[www.lenze.com/product-information](http://www.lenze.com/product-information)



The parameters are divided into the following function groups:

- Pxxx.xx group 0: Favorites
- P1xx.xx group 1: Diagnostics
- P2xx.xx group 2: Basic setting
- P3xx.xx group 3: Motor control
- P4xx.xx group 4: I/O setting
- P5xx.xx group 5: Network setting
- P6xx.xx group 6: Process controller
- P7xx.xx group 7: Additional functions
- P8xx.xx group 8: Sequencer





**Favorites (group 0)**

Group 0 contains the configurable favorites that are also contained in the groups 1 to 4. In the default setting these are the most common parameters for the solution of typical applications.

















































## Commissioning

- Initial switch-on
  - Important notes
  - Keypad-module
  - Keypad control
  - Terminal control
  - Extended terminal control
  - Parameter overview
  - Favorites
  - Basic setting
  - Motor control
- Additional functions

	Favorites (group 0)				
	Display code	Name	Possible settings/ value ranges	Keypad code	Information
	<b>P100.00</b>	Output frequency	x.x Hz (read only)		Display of the actual output frequency.
	<b>P103.00</b>	Actual current	x.x % (read only)		Display of the actual motor current.
	<b>P106.00</b>	Motor voltage	x VAC (read only)		Display of the actual motor voltage.
	<b>P150.00</b>	Error code	- (Read only)		Error message.
	<b>P200.00</b>	Control selection	Flexible I/O	[0]	This selection enables a flexible assignment of the start, stop, and rotating direction commands with digital signal sources.
			Keypad	[1]	This selection enables the motor to start exclusively via the start key of the keypad. Other signal sources for starting the motor are ignored.
	<b>P201.01</b>	F-setp.source	Keypad	[1]	The setpoint is specified locally by the keypad.
			Analog input 1	[2]	The setpoint is defined as analog signal via the analog input 1.
			Analog input 2	[3]	The setpoint is defined as analog signal via the analog input 2.
			Network	[5]	The setpoint is defined as process data object via the network.
	<b>P203.01</b>	Start method	Frequency preset 1 ... 15	[11] ... [25]	For the setpoint selection, "preset" values can be parameterized and selected. All frequency presets are described in detail in the commissioning manual.
			Normal	[0]	After start command, the standard ramps are active.
			DC braking	[1]	After start command, the "DC braking" function is active for the time set in P704.02.
			Flying restart circuit	[2]	After the start command, the flying restart circuit is active.
	<b>P203.03</b>	Stop method	Premagnetization	[3]	After start command, the standard ramps are active and the premagnetization of the motor is activated. This reduces the motor current and smoothes the acceleration curve during the starting process (only relevant in the V/f motor control mode).
			Coasting	[0]	The motor has no torque (coasts down to standstill).
			Standard ramp	[1]	The motor is brought to a standstill with the deceleration time 1 P221.00 (or deceleration time 2 P223.00 if activated).
			Quick stop ramp	[2]	The motor is brought to a standstill with the deceleration time (P225.00) set for the "quick stop" function.
	<b>P208.01</b>	Mains voltage	Switch-off positioning	[3]	Is similar to the stop method "standard ramp [1]". Depending on the actual output frequency, however, the inverter delays the beginning of the down-ramping so that the number of motor revolutions until a standstill is reached and thus the stop position is always relatively constant.
			230 Veff	[0]	Selection of the mains voltage for actuating the inverter.
			400 Veff	[1]	
			480 Veff	[2]	
	120 Veff	[3]			
	<b>P210.00</b>	Min. frequency	0.0 ... 599.0 Hz		Lower limit value for all frequency setpoints.
	<b>P211.00</b>	Max. frequency	Device for 50-Hz mains: 50 Hz * Device for 60-Hz mains: 60 Hz *		Upper limit value for all frequency setpoints.
	<b>P220.00</b>	Acceleration 1	0.0 ... 5.0 ... 3600.0 s		Acceleration time 1.

\* Default setting dependent on the model



## Commissioning

- Initial switch-on
  - Important notes
  - Keypad-module
  - Keypad control
  - Terminal control
  - Extended terminal control
  - Parameter overview
  - Favorites
  - Basic setting
  - Motor control
- Additional functions

Favorites (group 0)				
Display code	Name	Possible settings/ value ranges	Keypad code	Information
P221.00	Deceleration 1	0.0 ... 5.0 ... 3600.0 s		Deceleration time 1
		Sensorless control (SL PSM)	[3]	This control type is used for the sensorless control of a synchronous motor.
		Sensorless vector control (SLVC)	[4]	This control type is used for sensorless vector control of an asynchronous motor.
		V/f characteristic control VFC open loop	[6]	This control mode is used for the speed control of an asynchronous motor via a V/f characteristic and is the simplest control mode.
		Sensorless control (SLSM-PSM)	[8]	This control type is used for the sensorless control of a synchronous motor. This control mode is not available in the version with network IO-Link!
P302.00	V/f characteristic shape	Linear	[0]	Linear characteristic for drives with constant load torque over the speed.
		Square-law	[1]	Square-law characteristic for drives with a square-law load torque over the speed.
		Eco	[3]	Linear characteristic with energy optimization in the partial load operational range.
P303.01	Base voltage	0 ... 230 ... 5000 V *		Base voltage and base frequency define the V/f ratio and thus the gradient of the V/f characteristic.
P303.02	Base frequency	Device for 50-Hz mains: 50 Hz * Device for 60-Hz mains: 60 Hz *		<ul style="list-style-type: none"> <li>• The V/f base voltage is usually set to the rated motor voltage.</li> <li>• The V/f base frequency is usually set to the rated motor frequency.</li> </ul>
P304.00	Limitation of rotation	Only clockwise (CW)	[0]	The motor can only be rotated clockwise (CW). The transfer of negative frequency and PID setpoints to the motor control is prevented.
		Both rotating directions	[1]	Both directions of motor rotation are enabled.
P305.00	Switching frequency	8 kHz var/opt/4 *		Selection of the inverter switching frequency.
P306.01	Overload selection	Heavy duty	[0]	Load characteristic for high dynamic requirements.
		Light Duty	[1]	Load characteristic for low dynamic requirements.
P308.01	Max.load for 60s	30 ... 150 ... 200 %		Maximum permissible thermal motor utilization (max. permissible motor current for 60 seconds). With regard to rated motor current (P323.00).
P316.01	Fixed V/f boost	0.0 ... 2.5 ... 20.0 % *		Constant voltage boost for the V/f characteristic control without feedback.
P323.00	Rated. mot curr.	0.001 ... 1.700 ... 500.000 A *		Setting of the rated motor current according to motor nameplate.
P324.00	Max. current	0.0 ... 200.0 ... 3000.0 %		Maximum overload current of the inverter. With regard to rated motor current (P323.00).
P400.01	Inverter enable	TRUE	[1]	Assignment of a trigger to the "inverter enable" function. Trigger = TRUE: The inverter is enabled (unless there is another cause for inverter disable). Trigger = FALSE: The inverter is disabled. The motor has no torque and coasts.

\* Default setting dependent on the model



## Commissioning

- Initial switch-on
  - Important notes
  - Keypad-module
  - Keypad control
  - Terminal control
  - Extended terminal control
  - Parameter overview
  - Favorites
  - Basic setting
  - Motor control
- Additional functions

Display code	Name	Possible settings/ value ranges	Keypad code	Information
<b>Favorites (group 0)</b>				
P400.02	Run	Digital input 1	[11]	<p>Assignment of a trigger to the "Run" function.</p> <p>Function 1: Start / stop motor (default setting) Function 1 is active if no further start commands (start forward/start reverse) have been connected to triggers, no keypad control is active and no network control is active. Trigger = TRUE: Let motor rotate forward (CW). Trigger = FALSE: Stop motor according to stop function (P203.03).</p> <p>Function 2: Start enable/stop motor Function 2 is active if further start commands have been connected to triggers, the keypad control is active or the network control is active. Trigger = TRUE: Start commands of the active control source are enabled. Trigger = FALSE: Stop motor.</p>
P400.03	Quick stop	Not connected	[0]	<p>Assignment of a trigger to the "Activate quick stop" function. Trigger = TRUE: Activate quick stop. Quick stop ramp adjustable in P225.00. Trigger = FALSE: Deactivate quick stop</p>
P400.04	Error reset	Digital input 2	[12]	<p>Assignment of a trigger to the "Reset error" function. Trigger = FALSE &gt; TRUE (edge): Active error is reset (acknowledged) if the error condition is not active anymore and the error is resettable. Trigger = FALSE: No action.</p>
P400.05	DC braking	Not connected	[0]	<p>Assignment of a trigger to the "Activate DC braking" function. Trigger = TRUE: Activate DC braking. Trigger = FALSE: Deactivate DC braking.</p>
P400.06	Start forward	Not connected	[0]	<p>Assignment of a trigger to the "Start forward (CW)" function. Trigger = FALSE &gt; TRUE (edge): Let motor rotate forward. Trigger = TRUE &gt; FALSE (edge): No action. Stop via P400.01 (default setting of digital input 1).</p>
P400.07	Start reverse	Not connected	[0]	<p>Assignment of a trigger to the "Start reverse (CCW)" function. Trigger = FALSE &gt; TRUE (edge): Let motor rotate backward. Trigger = TRUE &gt; FALSE (edge): No action. Stop via P400.01 (default setting of digital input 1).</p>
P400.08	Run forward	Not connected	[0]	<p>Assignment of a trigger to the "Run forward (CW)" function. Trigger = TRUE: Let motor rotate forward. Trigger = FALSE: Stop motor. Stop via P400.01 (default setting of digital input 1).</p>
P400.09	Run reverse	Not connected	[0]	<p>Assignment of a trigger to the "Run reverse (CCW)" function. Trigger = TRUE: Let motor rotate backward. Trigger = FALSE: Stop motor. Stop via P400.01 (default setting of digital input 1).</p>
P400.13	Reverse rot. dir.	Digital input 3	[13]	<p>Assignment of a trigger to the "Reverse rotating direction" function. Trigger = TRUE: The setpoint specified is inverted (i.e. the sign is inverted). Trigger = FALSE: No action/deactivate function again.</p>

\* Default setting dependent on the model



## Commissioning

- Initial switch-on
  - Important notes
  - Keypad-module
  - Keypad control
  - Terminal control
  - Extended terminal control
  - Parameter overview
  - Favorites
  - Basic setting
  - Motor control
- Additional functions









Display code	Name	Possible settings/ value ranges	Keypad code	Information
<b>P400.18</b>	Setp: Preset B0	Digital input 4	[14]	Assignment of a trigger to the "Activate preset (bit 0)" function. Bit with the valency 2 <sup>0</sup> for the bit-coded selection and activation of a parameterized setpoint (preset value). Trigger = FALSE: Bit = "0". Trigger = TRUE: Bit = "1".
<b>P400.19</b>	Setp: Preset B1	Digital input 5	[15]	Assignment of a trigger to the "Activate preset (bit 1)" function. Bit with the valency 2 <sup>1</sup> for the bit-coded selection and activation of a parameterized setpoint (preset value). Trigger = FALSE: Bit = "0". Trigger = TRUE: Bit = "1".
<b>P400.20</b>	Setp: Preset B2	Not connected	[0]	Assignment of a trigger to the "Activate preset (bit 2)" function. Bit with the valency 2 <sup>2</sup> for the bit-coded selection and activation of a parameterized setpoint (preset value). Trigger = FALSE: Bit = "0". Trigger = TRUE: Bit = "1".
<b>P420.01</b>	Relay function	Running	[50]	TRUE if inverter and start are enabled and output frequency > 0.2 Hz. Otherwise FALSE.
		Ready for operation	[51]	TRUE if inverter is ready for operation (no error active and DC-bus voltage ok). Otherwise FALSE.
		Operation enabled	[52]	TRUE if inverter and start are enabled. Otherwise FALSE.
		Stop active	[53]	TRUE if inverter is enabled and motor is not started and output frequency = 0.
		Error active	[56]	TRUE if error is active. Otherwise FALSE.
		Device warning active	[58]	TRUE if warning is active. Otherwise FALSE.
<b>P420.02</b>	DO1 function	Release brake	[115]	Assignment of a trigger to digital output 1. Trigger = FALSE: X3/DO1 set to LOW level. Trigger = TRUE: X3/DO1 set to HIGH level.
<b>P430.01</b>	AI1 input area	0 ... 10 VDC	[0]	Definition of the input range for analog input AI1.
		0 ... 5 VDC	[1]	
		2 ... 10 VDC	[2]	
		-10 ... +10 VDC	[3]	
		4 ... 20 mA	[4]	
		0 ... 20 mA	[5]	
<b>P430.02</b>	AI1 freq @ min	-1000.0 ... 0.0 ... 1000.0 Hz		Scaling of the input signal AI1 to the frequency value.
<b>P430.03</b>	AI1 freq @ max	-1000.0 ... 50.0   60.0 ... 1000.0 Hz *		<ul style="list-style-type: none"> <li>• Direction of rotation according to sign.</li> <li>• The standard setpoint source for operating mode "MS: Velocity mode" is selected in P201.01.</li> </ul>
<b>P440.01</b>	AO1 output area	Disabled	[0]	Definition of the output range for analog output AO1.
		0 ... 10 VDC	[1]	
		0 ... 5 VDC	[2]	
		2 ... 10 VDC	[3]	
		4 ... 20 mA	[4]	
		0 ... 20 mA	[5]	

\* Default setting dependent on the model



## Commissioning

- Initial switch-on
  - Important notes
  - Keypad-module
  - Keypad control
  - Terminal control
  - Extended terminal control
  - Parameter overview
  - Favorites
  - Basic setting
  - Motor control
- Additional functions

### Favorites (group 0)









Display code	Name	Possible settings/ value ranges	Keypad code	Information
<b>P440.02</b>	AO1 function	Output frequency	[1]	Current frequency (resolution: 0.1 Hz).
		Frequency setpoint	[2]	Current frequency setpoint (resolution: 0.1 Hz).
		Analog input 1	[3]	Input signal of analog input 1 (resolution: 0.1 %).
<b>P440.03</b>	AO1 min. signal	-2147483648 ... 0 ... 2147483647		Definition of the signal value that corresponds to the minimum value at analog output 1.
<b>P440.04</b>	AO1 max. signal	-2147483648 ... 1000 ... 2147483647		Definition of the signal value that corresponds to the maximum value at analog output 1.
<b>P450.01</b>	Freq. preset 1	0.0 ... 20.0 ... 599.0 Hz		Parameterizable frequency setpoints (preset 1).
<b>P450.02</b>	Freq. preset 2	0.0 ... 40.0 ... 599.0 Hz		Parameterizable frequency setpoints (preset 2).
<b>P450.03</b>	Freq. preset 3	0.0 ... 50.0   60.0 ... 599.0 Hz *		Parameterizable frequency setpoints (preset 3).
<b>P450.04</b>	Freq. preset 4	0.0 ... 0.0 ... 599.0 Hz		Parameterizable frequency setpoints (preset 4).

\* Default setting dependent on the model



## Commissioning

- Initial switch-on
  - Important notes
  - Keypad-module
  - Keypad control
  - Terminal control
  - Extended terminal control
  - Parameter overview
  - Favorites
  - Basic setting
  - Motor control
- Additional functions









### Basic setting (group 2)

Display code	Name	Possible settings	Keypad code	Information
P225.00	QSP del.time	1.0 s		Quick stop deceleration time for "MS: Velocity mode" <ul style="list-style-type: none"> <li>If the "Quick stop" function is activated, the motor is brought to a standstill within the deceleration time set here.</li> <li>The braking deceleration time set refers to the deceleration from the maximum frequency set (P211.00) to standstill. In the case of a lower actual frequency, the actual deceleration time is reduced accordingly.</li> <li>Setting is not effective in the operating mode P301.00 = "CiA: Velocity mode [2]".</li> </ul>



## Commissioning

- Initial switch-on
  - Important notes
  - Keypad-module
  - Keypad control
  - Terminal control
  - Extended terminal control
  - Parameter overview
  - Favorites
  - Basic setting
  - Motor control**
- Additional functions



















### Motor control (group 3)

Display code	Name	Possible settings	Keypad code	Information	
P320.04	Rated torque	50 ... 50000 rpm		General motor data. Carry out settings as specified by motor nameplate data. Note! When you enter the motor nameplate data, take into account the phase connection implemented for the motor (star or delta connection). Only enter the data applying to the connection type selected.	
P320.05	Rated frequency	1.0 ... 10000.0 Hz			
P320.06	Rated power	0.00 ... 655.35 kW 0.00 ... 878.84 hp			
P320.07	Rated voltage	0 ... 65535 V			
P320.08	Cos phi	0.00 ... 1.00			
P327.04	Mot. identif.	0 ... 1			1 = start automatic identification of the motor data. • Inverter characteristics, motor equivalent circuit diagram data and controller settings are identified and set automatically. • During the procedure, the motor is energized!
P327.05	Mot. calibrate	0 ... 1			1 = start automatic calibration of the motor data. • A default inverter characteristic is loaded. • The motor equivalent circuit diagram data and controller settings are calculated on the basis of the currently set rated motor data. • The motor is not energized.

## Commissioning

- Initial switch-on
  - Important notes
  - Keypad-module
  - Keypad control
  - Terminal control
  - Extended terminal control
  - Parameter overview
  - Favorites
  - Basic setting
  - Motor control
- Additional functions

### Additional functions (group 7)

Display code	Name	Possible settings	Keypad code	Information
P700.01	Load default settings	On / start	[1]	1 = reset all parameters in the RAM memory of the inverter to the default setting stored in the inverter firmware. <ul style="list-style-type: none"> <li>All parameter changes made by the user are lost during this process!</li> <li>This process may take some seconds. When the device command has been executed successfully, the value 0 is shown.</li> <li>Loading parameters has a direct effect on cyclic communication: The data exchange for control is interrupted and a communication error is generated.</li> </ul>
		Off/ready	[0]	Only status feedback
P700.03	Save user data	On / start	[1]	1 = save current parameter settings in the user memory of the memory module with mains failure protection. <ul style="list-style-type: none"> <li>This process may take some seconds. When the device command has been executed successfully, the value 0 is shown.</li> <li>Do not switch off the supply voltage during the saving process and do not unplug the memory module from the inverter!</li> <li>When the inverter is switched on, all parameters are automatically loaded from the user memory of the memory module to the RAM memory of the inverter.</li> </ul>
		Off/ready	[0]	Only status feedback

## Troubleshooting

Error message

Error codes

LED status

Support



### Error message

If an error is pending, the keypad shows the following information.

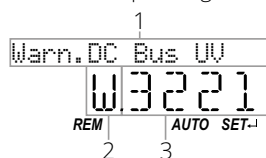

1 = Error text

2 = Error type (F = fault, T = trouble, W = warning)

3 = Error code (hexadecimal)

- Faults (F) and trouble (T) are displayed continuously. The inverter is disabled.
- Warnings (W) are displayed every 2 seconds for a short time. The inverter is probably disabled.

### Reset error via keypad

Errors can be reset via the stop key.

- Prerequisite: Cause of error has been eliminated and no blocking time is active.
- Press the stop key to reset the error. The motor is stopped.
- Press the start key to cancel the stop.

### Reset error via terminal control

When terminal control is used, errors can be reset in two ways:

1. Via start signal P400.02 (default setting of digital input 1).
  - Prerequisite: Cause of error has been eliminated and no blocking time is active.
  - The signal at the digital input 1 must drop and then be applied again.
2. Via error reset signal (P400.04, default setting of digital input 2).
  - Prerequisite: Cause of error has been eliminated and no blocking time is active.
  - The error is reset if a signal is applied to digital input 2.

## Troubleshooting

Error message

**Error codes**

LED status

Support



### Error codes

Error code	Description	Classification	Remedy	Blocking time [s]
2250	CiA: Continuous overcurrent (inside the device)	Trouble	<ul style="list-style-type: none"> <li>Check motor and wiring for short circuits.</li> <li>Check brake resistor and wiring.</li> <li>Check motor circuit (delta connection, star connection).</li> <li>Check setting of the motor data.</li> </ul>	5
2320	Short circuit or earth leakage on the motor side	Trouble	<ul style="list-style-type: none"> <li>Check motor cable.</li> <li>Check the length of the motor cable.</li> <li>Use shorter or lower-capacitance motor cable.</li> </ul>	5
2340	CiA: Short circuit (inside the device)	Trouble	<ul style="list-style-type: none"> <li>Check motor cable for short circuit.</li> </ul>	5
2350	CiA: i <sup>2</sup> *t overload (thermal state)	Trouble	<ul style="list-style-type: none"> <li>Check drive sizing.</li> <li>Check machine/driven mechanics for excessive load.</li> <li>Check setting of the motor data.</li> <li>Reduce values for slip compensation (P315.01, P315.02) and oscillation damping (P318.01, P318.02).</li> </ul>	5
2382	Error: Device utilization (Ixt) too high	Trouble	<ul style="list-style-type: none"> <li>Check drive sizing.</li> <li>Reduce maximum overload current of the inverter (P324.00).</li> <li>In case of high mass inertias, reduce maximum overload current of the inverter (P324.00) to 150 %.</li> </ul>	3
2383	Warning: Device utilization (Ixt) too high	Warning	<ul style="list-style-type: none"> <li>Check drive sizing.</li> </ul>	0
3120	Mains phase fault	Trouble	<ul style="list-style-type: none"> <li>Check mains connection wiring.</li> <li>Check fuses.</li> </ul>	0
3210	DC bus overvoltage	Trouble	<ul style="list-style-type: none"> <li>Reduce dynamic performance of the load profile.</li> <li>Check mains voltage.</li> <li>Check settings for the brake energy management.</li> </ul>	0
3211	Warning: DC bus overvoltage	Warning		0
3220	DC bus undervoltage	Trouble	<ul style="list-style-type: none"> <li>Check mains voltage.</li> <li>Check fuses.</li> <li>Check DC bus voltage (P105.00).</li> <li>Check mains settings.</li> </ul>	0
3221	Warning: DC bus undervoltage	Warning		0
3222	DC-bus voltage too low for switch-on	Warning	<ul style="list-style-type: none"> <li>Check mains voltage.</li> <li>Check fuses.</li> <li>Check mains settings.</li> </ul>	0
4210	PU: Overtemperature fault	Trouble	<ul style="list-style-type: none"> <li>Check mains voltage.</li> <li>Provide for a sufficient cooling of the device (display of the heatsink temperature in P117.01).</li> <li>Clean fan and ventilation slots. If required, replace fan.</li> <li>Reduce switching frequency (P305.00).</li> </ul>	0
4281	Heatsink fan warning	Warning	<ul style="list-style-type: none"> <li>Clean fan and ventilation slots. If required, replace fan. The fans can be unlocked via locking hooks and can then be removed.</li> </ul>	0
5112	24 V supply critical	Warning	<ul style="list-style-type: none"> <li>Check optional external 24 V voltage supply (terminal X3/24E), if connected.</li> <li>Check mains voltage.</li> </ul>	0
5180	24-V supply overload	Warning	<ul style="list-style-type: none"> <li>Check 24 V output and digital outputs for earth fault or overload.</li> </ul>	0



## Troubleshooting

Error message

**Error codes**

LED status

Support



### Error codes

Error code	Description	Classification	Remedy	Blocking time [s]
6280	Trigger/functions connected incorrectly	Trouble	<ul style="list-style-type: none"> <li>Check and correct the assignment of the triggers to the functions.</li> <li>With keypad or network control, the two functions "Inverter enable" (P400.01) and "Run" (P400.02) can also be set to "Constant TRUE [1]" to start the motor.</li> </ul>	0
7180	Motor overcurrent	Trouble	<ul style="list-style-type: none"> <li>Check motor load.</li> <li>Check drive sizing.</li> <li>Adapt the set error threshold (P353.01).</li> </ul>	1
9080	Keypad removed	Trouble	<ul style="list-style-type: none"> <li>Connect the keypad again or activate another control source.</li> </ul>	0
FF06	Motor overspeed	Trouble	<ul style="list-style-type: none"> <li>Adapt the maximum motor speed (P322.00) and the error threshold (P350.01).</li> </ul>	1
FF37	Automatic start disabled	Trouble	<ul style="list-style-type: none"> <li>Deactivate start command and reset error.</li> </ul>	0
FF85	Keypad full control active	Warning	<ul style="list-style-type: none"> <li>Press the CTRL key to exit control mode.</li> </ul>	0



## Troubleshooting

Error message

Error codes

LED status

Support



### LED status

Meaning of the status LEDs for the inverter:

LED "RDY" (blue)	LED "ERR" (red)	State/meaning
off	off	No supply voltage
		Mains voltage is switched on, inverter initialized
	off	Inverter disabled, ready for operation
blinking		Safe torque off (STO) active, warning active
	off	Inverter disabled
		Inverter disabled, warning active.
blinking		Inverter disabled, error active.
		Inverter disabled, no DC bus voltage.
	off	Inverter enabled
	off	The motor rotates according to the specified setpoint or quick stop active.
		Inverter enabled, warning active. The motor rotates according to the specified setpoint or quick stop active.
		Inverter enabled, quick stop active as response to a fault.

Meaning of the status LEDs for the different networks:

Network	Left LED (green)	Right LED (red)
CANopen	CAN RUN	CAN-ERR
Modbus RTU	COMM	ERR

Network status LEDs

Inverter status LEDs



## Troubleshooting

Error message

Error codes

LED status

Support



### Support

Further information can be found on the online page

[www.lenze.com/product-information](http://www.lenze.com/product-information)



The material number of the product can be found on the nameplate.



## Disposal

	<p>If pollutants are disposed off improperly, they may cause a lasting damage to human health and the environment. Thus, electrical and electronic equipment must be collected separately from unsorted municipal waste so that it may be recycled or disposed of properly. If available, put the components to the company internal disposal from where it is passed on to specialized waste management companies. It is also possible to return the components to the manufacturer. For this purpose, please contact the customer service of the manufacturer. More detailed information on disposal can be obtained from the corresponding specialist firms and the competent authorities. The packaging of the component must be disposed of separately. Paper, cardboard and plastics must be recycled.</p>
