



Inverter

Inverter i510-Cabinet

0.37 kW ... 15 kW

0.5 hp ... 20 hp

Inverter

Inverter i510 Cabinet

0.37 kW ... 15 kW

0.5 hp ... 20 hp

Inhalt

Über dieses Dokument	6
Dokumentbeschreibung	6
Weiterführende Dokumente	6
Schreibweisen und Konventionen	7
Sicherheitshinweise	8
Grundlegende Sicherheitshinweise	8
Bestimmungsgemäße Verwendung	9
Handhabung	9
Restgefahren	10
Produktinformation	11
Identifizierung der Produkte	11
Ausstattung	12
Mechanische Installation	16
Wichtige Hinweise	16
Vorbereitung	17
Abmessungen	19

Elektrische Installation	31
Wichtige Hinweise.....	31
Anschluss nach UL.....	32
Netzanschluss	36
1-phasiger Netzanschluss 230/240 V.....	36
Anschlusspläne.....	36
Klemmendaten.....	38
Absicherungsdaten.....	38
3-phasiger Netzanschluss 230/240 V.....	39
Anschlusspläne.....	39
Klemmendaten.....	41
Absicherungsdaten.....	41
3-phasiger Netzanschluss 230/240 V "Light Duty".....	41
Anschlusspläne.....	41
Klemmendaten.....	41
Absicherungsdaten.....	41
3-phasiger Netzanschluss 400 V.....	42
Anschlusspläne.....	42
Klemmendaten.....	43
Absicherungsdaten.....	43
3-phasiger Netzanschluss 400 V "Light Duty".....	44
Anschlusspläne.....	44
Klemmendaten.....	44
Absicherungsdaten.....	44
3-phasiger Netzanschluss 480 V.....	45
Anschlusspläne.....	45
Klemmendaten.....	45
Absicherungsdaten.....	46
3-phasiger Netzanschluss 480 V "Light Duty".....	46
Anschlusspläne.....	46
Klemmendaten.....	46
Absicherungsdaten.....	46
Anschluss an das IT-Netz.....	47
Steueranschlüsse	48
Netzwerke.....	49
CANopen/Modbus.....	49
Inbetriebnahme	50
Wichtige Hinweise.....	50
Erstes Einschalten und Funktionstest.....	51

Technische Daten	53
Normen und Einsatzbedingungen.....	53
Konformitäten/Approbationen.....	53
Personenschutz und Geräteschutz.....	53
Angaben zur EMV.....	53
Motoranschluss.....	54
Umweltbedingungen.....	54
Netzbedingungen.....	54
1-phasiger Netzanschluss 230/240 V.....	55
Bemessungsdaten.....	55
3-phasiger Netzanschluss 230/240 V.....	57
Bemessungsdaten.....	57
3-phasiger Netzanschluss 230/240 V "Light Duty".....	59
Bemessungsdaten.....	59
3-phasiger Netzanschluss 400 V.....	60
Bemessungsdaten.....	60
3-phasiger Netzanschluss 400 V "Light Duty".....	62
Bemessungsdaten.....	62
3-phasiger Netzanschluss 480 V.....	63
Bemessungsdaten.....	63
3-phasiger Netzanschluss 480 V "Light Duty".....	65
Bemessungsdaten.....	65

Über dieses Dokument

WARNUNG!

Lesen Sie diese Dokumentation sorgfältig, bevor Sie mit den Arbeiten beginnen.

► Beachten Sie die Sicherheitshinweise!

Dokumentbeschreibung

Weiterführende Dokumente

Für bestimmte Aufgaben stehen Informationen in anderen Formen zur Verfügung.





Form	Inhalt/Themen
Engineering Tools	Zur Inbetriebnahme
AKB-Artikel	Application Knowledge Base mit technischen Zusatzinformationen für Anwender
CAD-Daten	Exporte in verschiedenen Formaten
EPLAN Makros	Projektierung, Dokumentation und Verwaltung von Projekten für P8. <ul style="list-style-type: none">• Datenbezug über Lenze oder EPLAN Data Portal



Informationen und Hilfsmittel rund um die Lenze-Produkte finden Sie im Internet:
<http://www.lenze.com> → Downloads

Schreibweisen und Konventionen

Zur Unterscheidung verschiedener Arten von Informationen werden in diesem Dokument Konventionen verwendet.

Zahlenschreibweise		
Dezimaltrennzeichen	Punkt	Es wird generell der Dezimalpunkt verwendet. Beispiel: 1 234.56
Warnhinweise		
UL-Warnhinweise	UL	Werden in englischer und französischer Sprache verwendet.
UR-Warnhinweise	UR	
Textauszeichnung		
Engineering Tools	» «	Software Beispiel: »Engineer«, »EASY Starter«
Symbole		
Seitenverweis		Verweis auf eine andere Seite mit zusätzlichen Informationen Beispiel:  16 = siehe Seite 16
Dokumentationsverweis		Verweis auf eine andere Dokumentation mit zusätzlichen Informationen Beispiel:  EDKxxx = siehe Dokumentation EDKxxx

Gestaltung der Sicherheitshinweise

GEFAHR!

Kennzeichnet eine außergewöhnlich große Gefahrensituation. Wird dieser Hinweis nicht beachtet, kommt es zu schweren irreversiblen Verletzungen oder zum Tod.

WARNUNG!

Kennzeichnet eine außergewöhnlich große Gefahrensituation. Wird dieser Hinweis nicht beachtet, kann es zu schweren irreversiblen oder tödlichen Verletzungen kommen.

VORSICHT!

Kennzeichnet eine Gefahrensituation. Wird dieser Hinweis nicht beachtet, kann es zu leichten oder mittleren Verletzungen kommen.

HINWEIS

Kennzeichnet Sachgefahren. Wird dieser Hinweis nicht beachtet, kann es zu Sachschäden kommen.

Sicherheitshinweise

Wenn Sie die folgenden grundlegenden Sicherheitsmaßnahmen und Sicherheitshinweise missachten, kann dies zu schweren Personenschäden und Sachschäden führen!

Beachten Sie die Vorgaben der beiliegenden und zugehörigen Dokumentation. Dies ist Voraussetzung für einen sicheren und störungsfreien Betrieb, sowie für das Erreichen der angegebenen Produkteigenschaften. Beachten Sie die spezifischen Sicherheitshinweise in den anderen Abschnitten!

GEFAHR!

Elektrische Spannung

Mögliche Folge: Tod oder schwere Verletzungen

- ▶ Alle Arbeiten am Inverter nur im spannungslosen Zustand durchführen.
- ▶ Inverter bis 45 kW: Nach dem Abschalten der Netzspannung mindestens 3 min warten, bevor Sie mit den Arbeiten beginnen.
- ▶ Inverter ab 55 kW: Nach dem Abschalten der Netzspannung mindestens 10 min warten, bevor Sie mit den Arbeiten beginnen.

Grundlegende Sicherheitshinweise

GEFAHR!

Gefährliche elektrische Spannung

Tod oder schwere Verletzungen durch Stromschlag.

- ▶ Alle Arbeiten am Gerät nur im spannungslosen Zustand durchführen.
- ▶ Nach dem Abschalten der Netzspannung die Hinweisschilder auf dem Produkt beachten.

Personal

Nur qualifiziertes Fachpersonal darf Arbeiten mit dem Produkt ausführen. IEC 60364 bzw. CENELEC HD 384 definieren die Qualifikation dieser Personen:

- Sie sind mit Aufstellung, Montage, Inbetriebsetzung und Betrieb des Produkts vertraut.
- Sie verfügen über die entsprechenden Qualifikationen für ihre Tätigkeit.
- Sie kennen alle am Einsatzort geltenden Unfallverhütungsvorschriften, Richtlinien und Gesetze und können diese anwenden.

Verfahrenstechnik

Die dargestellten verfahrenstechnischen Hinweise und Schaltungsausschnitte sind Vorschläge, deren Übertragbarkeit auf die jeweilige Anwendung überprüft werden muss. Für die Eignung der angegebenen Verfahren und Schaltungsvorschläge übernimmt der Hersteller keine Gewähr.

Geräteschutz

- Die maximale Prüfspannung bei Isolationsprüfungen zwischen 24-V-Steuerpotential und PE darf 110 V DC nicht überschreiten (EN 61800-5-1).

Bestimmungsgemäße Verwendung

- Das Produkt darf nur unter den in dieser Dokumentation vorgeschriebenen Einsatzbedingungen betrieben werden.
- Das Produkt erfüllt die Schutzanforderungen der 2014/35/EU: Niederspannungsrichtlinie.
- Das Produkt ist keine Maschine im Sinne der 2006/42/EU: Maschinenrichtlinie.
- Die Inbetriebnahme oder die Aufnahme des bestimmungsgemäßen Betriebs einer Maschine mit dem Produkt ist solange untersagt, bis festgestellt wurde, dass die Maschine den Bestimmungen der EU-Richtlinie 2006/42/EU: Maschinenrichtlinie entspricht; EN 60204-1 beachten.
- Die Inbetriebnahme oder die Aufnahme des bestimmungsgemäßen Betriebs ist nur bei Einhaltung der EMV-Richtlinie 2014/30/EU erlaubt.
- Die harmonisierte Norm EN 61800-5-1 wird angewendet.
- Das Produkt ist kein Haushaltsgerät, sondern als Komponente ausschließlich bestimmt für die Weiterverwendung zur gewerblichen Nutzung bzw. professionellen Nutzung im Sinne der EN 61000-3-2.
- Das Produkt kann entsprechend der technischen Daten eingesetzt werden, wenn Antriebssysteme Kategorien gemäß EN 61800-3 einhalten müssen.
Im Wohnbereich kann das Produkt EMV-Störungen verursachen. Der Betreiber ist für die Durchführung von Entstörmaßnahmen verantwortlich.
- Das Produkt darf nur mit Motoren betrieben werden, die für den Betrieb mit Invertern geeignet sind.
 - L-force-Motoren von Lenze erfüllen diese Anforderung.
 - Ausnahme: Motoren m240 sind ausschließlich für den Netzbetrieb bestimmt.

Handhabung

- Das Produkt niemals trotz erkennbarer Schäden in Betrieb nehmen.
- Das Produkt niemals technisch verändern.
- Das Produkt niemals unvollständig montiert in Betrieb nehmen.
- Das Produkt niemals ohne erforderliche Abdeckungen betreiben.
- Alle elektrischen Verbindungen nur im spannungslosen Zustand herstellen, trennen und verändern!

Restgefahren





Auch wenn gegebene Hinweise beachtet und Schutzmaßnahmen angewendet werden, können Restrisiken verbleiben.

Die genannten Restgefahren muss der Anwender in der Risikobeurteilung für seine Maschine/Anlage berücksichtigen.

Nichtbeachtung kann zu schweren Personenschäden und Sachschäden führen!

Produkt

Beachten Sie die Warnschilder auf dem Produkt!

Symbol	Beschreibung
	Elektrostatisch gefährdete Bauelemente: Vor Arbeiten am Produkt muss sich das Personal von elektrostatischer Aufladung befreien!
	Gefährliche elektrische Spannung: Vor Arbeiten am Produkt überprüfen, ob alle Leistungsanschlüsse spannungslos sind! Die Leistungsanschlüsse führen nach Netzausschalten für die bei dem Symbol angegebene Zeit gefährliche elektrische Spannung!
	Hoher Ableitstrom: Festinstallation und PE-Anschluss nach EN 61800-5-1 oder EN 60204-1 ausführen!
	Heiße Oberfläche: Persönliche Schutzausrüstung verwenden oder Abkühlung abwarten!

Motorschutz

Bei bestimmten Einstellungen der Inverter kann der angeschlossene Motor überhitzt werden.

- Z. B. durch längeren Betrieb eigenbelüfteter Motoren bei kleinen Drehzahlen.
- Z. B. durch längeren Betrieb der Gleichstrombremse.

Schutz der Maschine/Anlage

Antriebe können gefährliche Überdrehzahlen erreichen.

- Z. B. durch Einstellung hoher Ausgangsfrequenzen bei dafür ungeeigneten Motoren und Maschinen.
- Die Inverter bieten keinen Schutz gegen solche Betriebsbedingungen. Setzen Sie dafür zusätzliche externe Komponenten ein.

Schütze in der Motorleitung nur bei gesperrtem Inverter schalten.

- Das Schalten bei freigegebenem Inverter ist nur zulässig, wenn keine Überwachungen ansprechen.

Motor

Bei Kurzschluss zweier Leistungstransistoren kann am Motor eine Restbewegung von bis zu 180°/Polpaarzahl auftreten! (Z. B. 4-poliger Motor: Restbewegung max. $180^\circ/2 = 90^\circ$).

Schutzart - Personenschutz und Geräteschutz

- Angaben gelten für den betriebsfertig montierten Zustand.
- Angaben gelten nicht im Anschlussbereich der Klemmen.
 - Bei nicht belegten Klemmen besteht nur geringer Berührungsschutz.
 - Klemmen für große Leitungsquerschnitte haben geringere Schutzklassen, z. B. ab 15 kW nur IP10.

Produktinformation

Identifizierung der Produkte

In Tabellen werden die ersten 9 Stellen des jeweiligen Produktcodes verwendet, um die Produkte zu identifizieren:

Produktcode

		I	5	1	A	E	□□□	□	1	0	□	□	□	□□□□
Produktart	Inverter	I												
Produktfamilie	i500		5											
Produkt	i510			1										
Produktgeneration	Generation 1				A									
	Generation 2				B									
Montageart	Schaltschrankmontage					E								
Bemessungsleistung [W] (Beispiele)	0.25 kW						125							
	0.55 kW						155							
	2.2 kW						222							
Netzspannung und Anschlussart	1/N/PE AC 230/240 V									B				
	1/N/PE AC 230/240 V										D			
	2/N/PE AC 230/240 V													
	3/PE AC 230/240 V											C		
	3/PE AC 400 V 3/PE AC 480 V												F	
Motoranschlüsse	Einzelachse								1					
Integrierte funktionale Sicherheit	Ohne									0				
Schutzart	IP20										0			
	IP20, verlackt										V			
Funkentstörung	Ohne											0		
	Funkentstörfilter integriert												1	
Ausführungsvarianten	Globale Ausführung 50 Hz												0	
	Lokale Ausführung 60 Hz													1
	Basic-I/O ohne Netzwerk													000S
	Basic-I/O mit CANopen/Modbus													001S

Beispiel:

Produktcode	Bedeutung
I51AE215F10010001S	Inverter i510 Cabinet, 1.5 kW, 3-phasig, 400 V/480 V IP20, Funkentstörfilter integriert, 50-Hz-Variante Basic-I/O mit CANopen/Modbus-Netzwerk

Ausstattung

Beispiel für 0.25 kW ... 4 kW

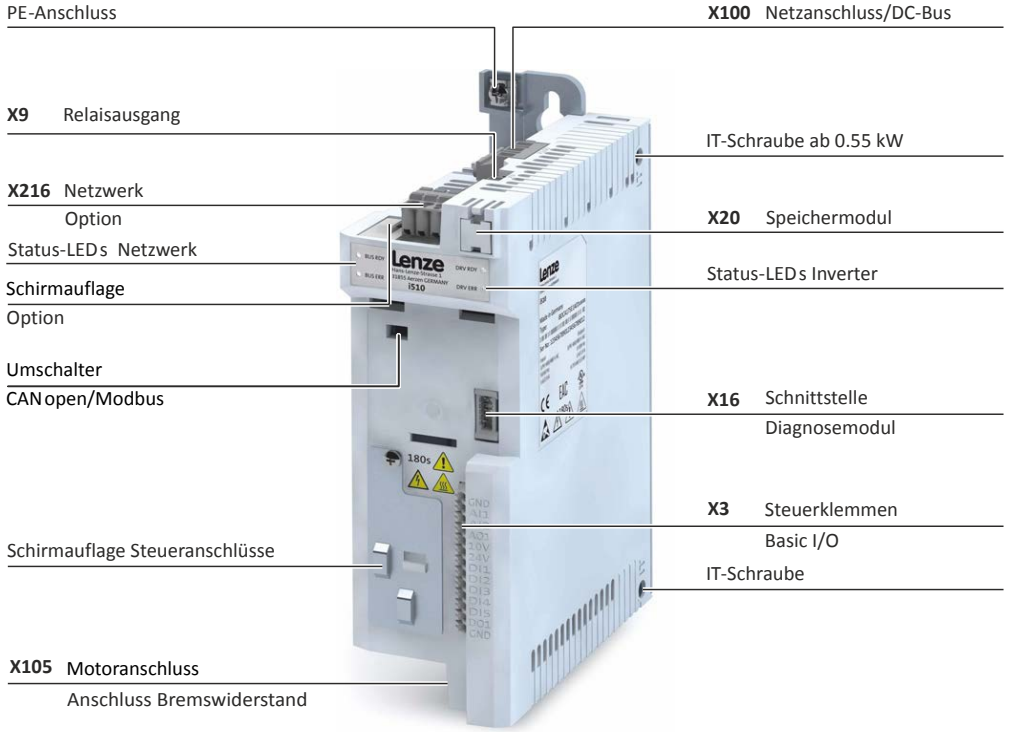

Beispiel für 0.25 kW ... 2.2 kW

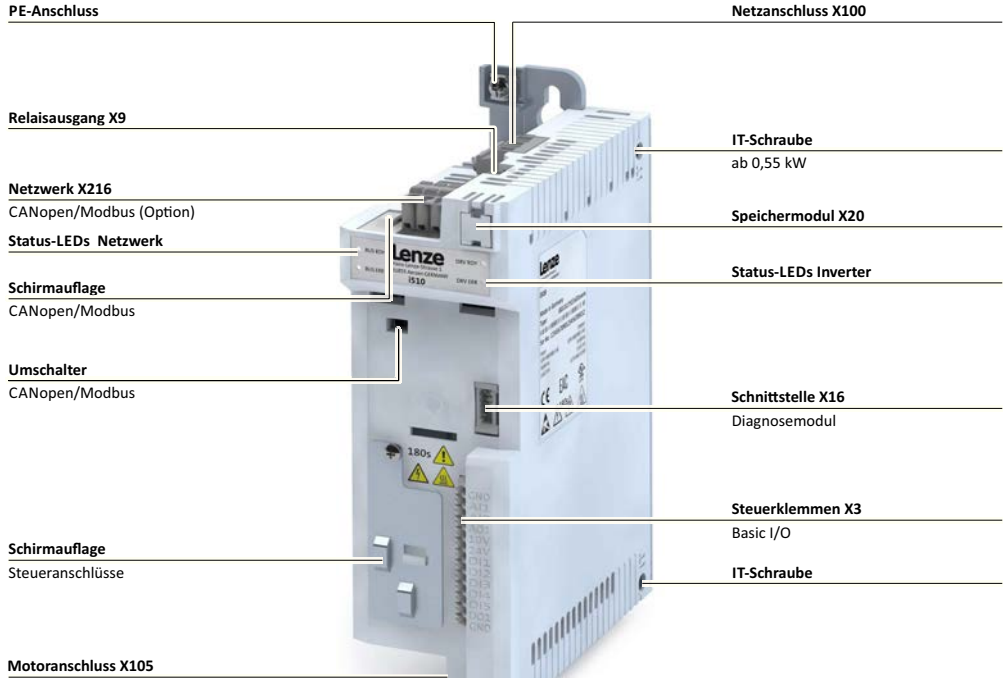

Beispiel für 5.5 kW

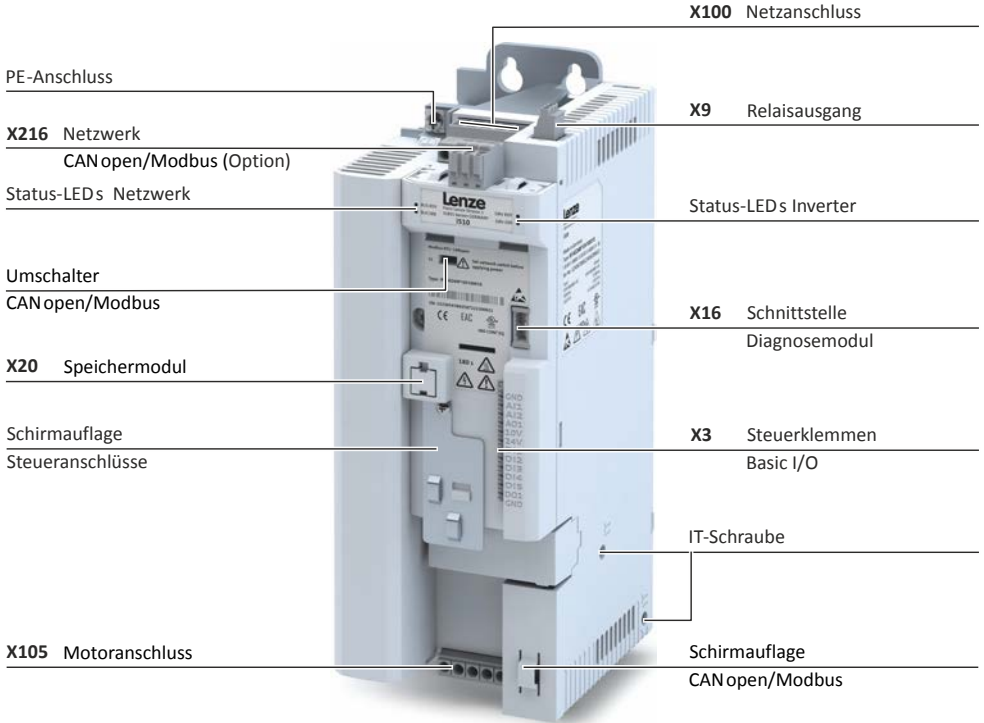

Beispiel für 7.5 kW ... 11 kW

PE-Anschluss

X100 Netzanschluss

Status-LEDs Netzwerk

X9 Relaisausgang

Umschalter

X216 Netzwerk

CAN open/Modbus

CAN open/Modbus (Option)

X20 Speichermodul

Status-LEDs Inverter

Schirmauflage

Steueranschlüsse

X16 Schnittstelle

Diagnosemodul

X3 Steuerklemmen

Basic I/O

IT-Schraube

X105 Motoranschluss

Schirmauflage

CAN open/Modbus

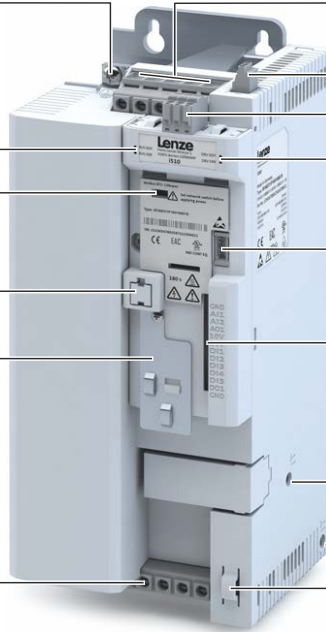

Mechanische Installation

Wichtige Hinweise

HINWEIS

- ▶ **UL marking**
 - ▶ Modular construction - A complete drive consists of a power unit series no. I5D in combination with a control unit series no. I5C only.
 - ▶ **Marquage UL**
 - ▶ Conception modulaire – Le système d'entraînement complet comprend un module d'alimentation de série I5D, impérativement associé à une unité de commande de série I5C.
-

Vorbereitung

Montage Schirmauflageblech für Motorleitung 0.25 kW bis 4 kW (optionales Zubehör)

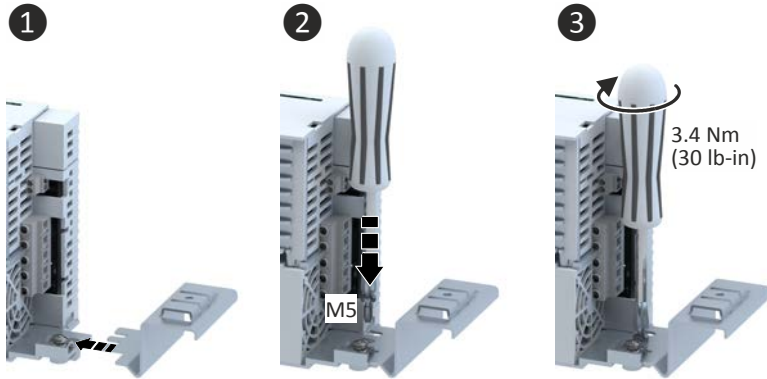

Das Schirmauflageblech wird zusammen mit dem Inverter auf der Montageplatte verschraubt.

Montage Schirmauflageblech für Motorleitung 5.5 kW (optionales Zubehör)

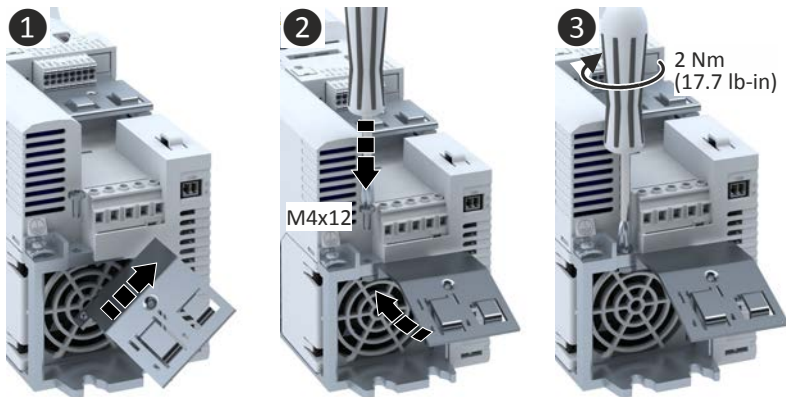

Montage Schirmauflageblech für Motorleitung 7.5 kW bis 11 kW (optionales Zubehör)

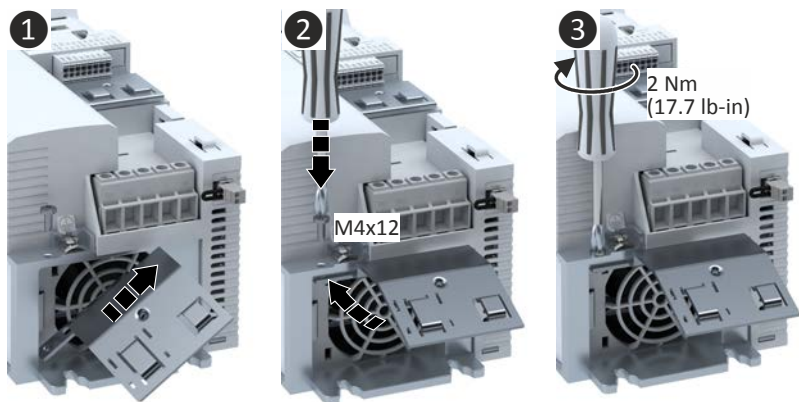

Abmessungen

0.25 kW ... 0.37 kW

Die Abmessungen in mm gelten für:

0.25 kW	I51AE125B	I51AE125D	
0.37 kW	I51AE137B	I51AE137D	I51AE137F

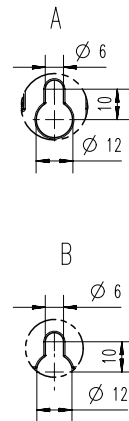
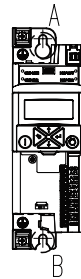
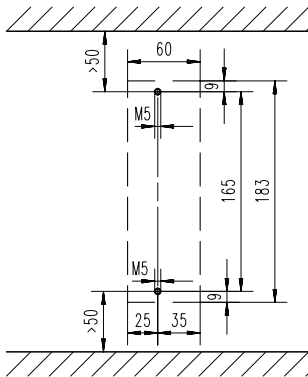
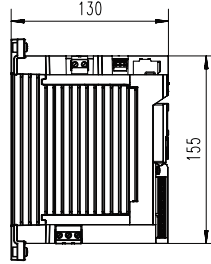
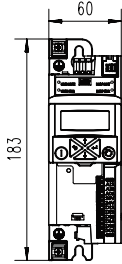

8800270

Mechanische Installation

Abmessungen

0.33 hp ... 0.5 hp

Die Abmessungen in inch gelten für:

0.33 hp	I51AE125B	I51AE125D	
0.5 hp	I51AE137B	I51AE137D	I51AE137F

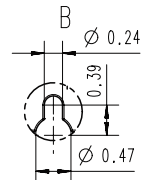
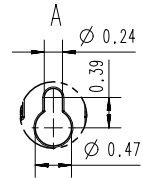
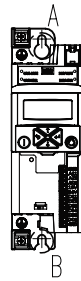
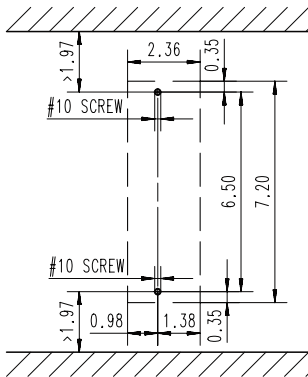
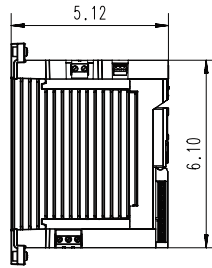
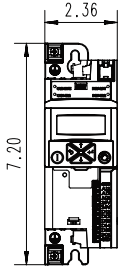

8800305

0.55 kW ... 0.75 kW

Die Abmessungen in mm gelten für:

0.55 kW	I51AE155B	I51AE155D	I51AE155F
0.75 kW	I51AE175B	I51AE175D	I51AE175F

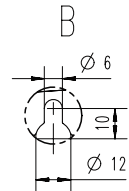
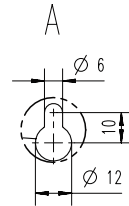
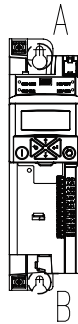
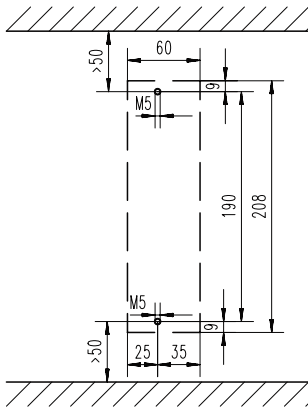
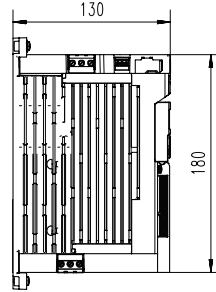
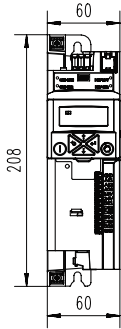

8800271

Mechanische Installation

Abmessungen

0.75 hp ... 1 hp

Die Abmessungen in inch gelten für:

0.75 hp	I51AE155B	I51AE155D	I51AE155F
1 hp	I51AE175B	I51AE175D	I51AE175F

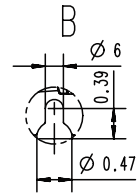
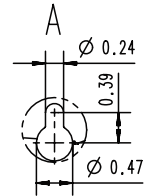
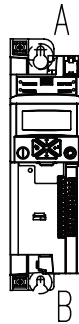
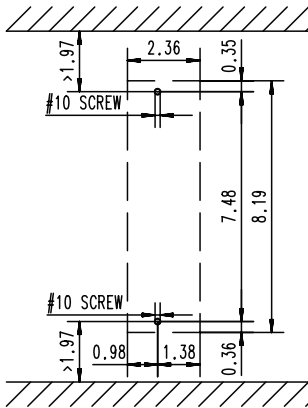
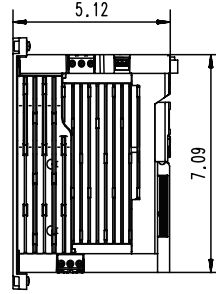
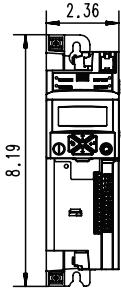

8800306

1.1 kW ... 4 kW

Die Abmessungen in mm gelten für:

1.1 kW	I51AE211B	I51AE211D	I51AE211F
1.5 kW	I51AE215B	I51AE215D	I51AE215F
2.2 kW	I51AE222B	I51AE222D	I51AE222F
3 kW			I51BE230F
4 kW			I51BE240F

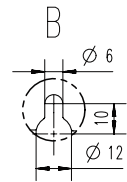
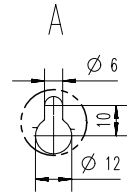
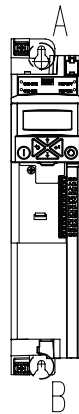
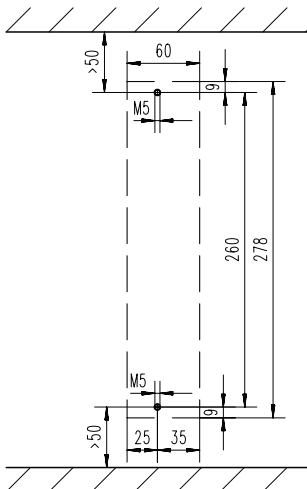
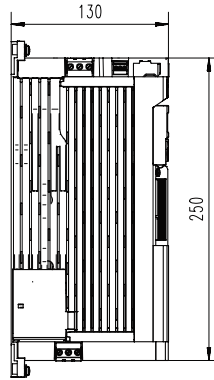
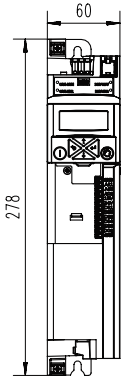

8800272

1.5 hp ... 5.5 hp

Die Abmessungen in inch gelten für:

1.5 hp	I51AE211B	I51AE211D	I51AE211F
2 hp	I51AE215B	I51AE215D	I51AE215F
3 hp	I51AE222B	I51AE222D	I51AE222F
4 hp			I51BE230F
5.5 hp			I51BE240F

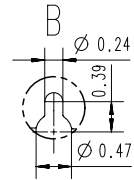
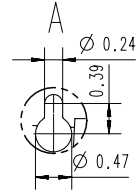
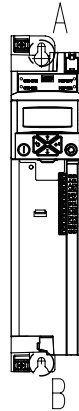
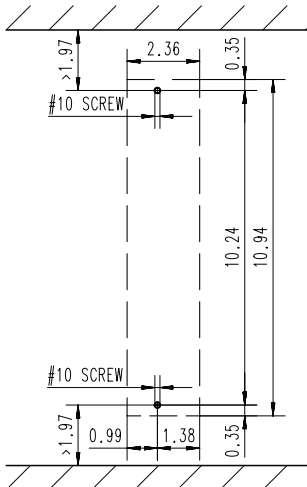
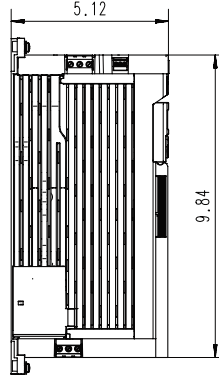
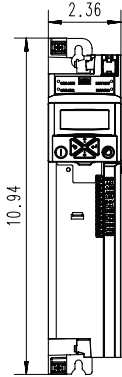

1.1 kW ... 2.2 kW

Die Abmessungen in mm gelten für:

1.1 kW	I51AE211B	I51AE211D	I51AE211F
1.5 kW	I51AE215B	I51AE215D	I51AE215F
2.2 kW	I51AE222B	I51AE222D	I51AE222F

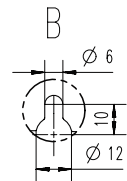
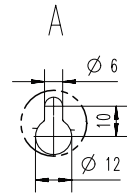
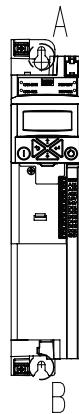
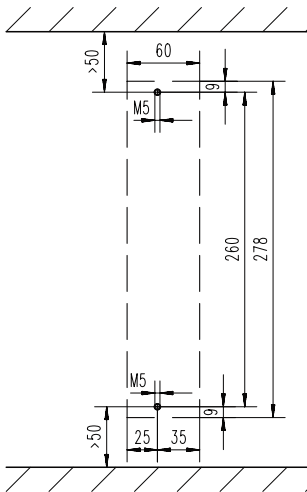
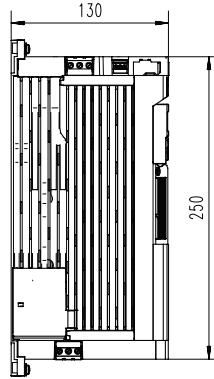
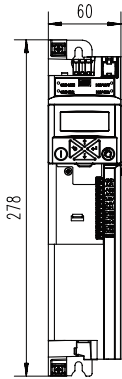

8800272

Mechanische Installation Abmessungen

1.5 hp ... 3 hp

Die Abmessungen in inch gelten für:

1.5 hp	I51AE211B	I51AE211D	I51AE211F
2 hp	I51AE215B	I51AE215D	I51AE215F
3 hp	I51AE222B	I51AE222D	I51AE222F

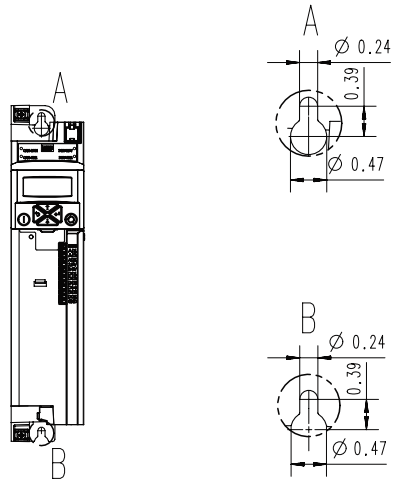
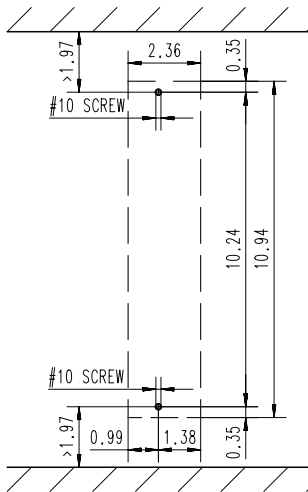
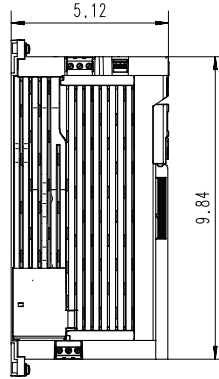
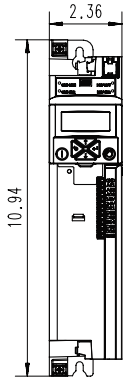

8800307

5.5 kW

Die Abmessungen in mm gelten für:

5.5 kW	I51AE255C	I51AE255F
--------	-----------	-----------

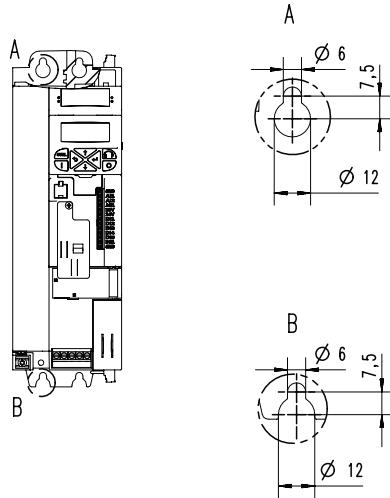
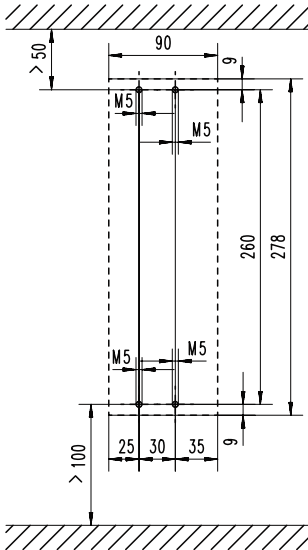
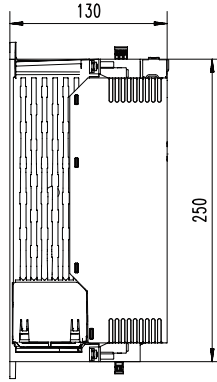
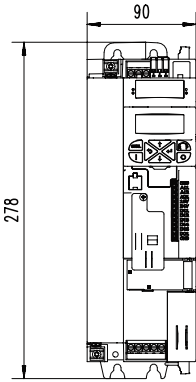

8800599

Mechanische Installation

Abmessungen

7.5 hp

Die Abmessungen in inch gelten für:

7.5 hp	I51AE255C	I51AE255F
--------	-----------	-----------

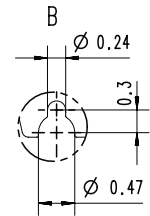
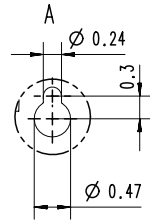
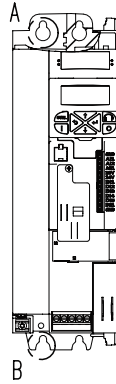
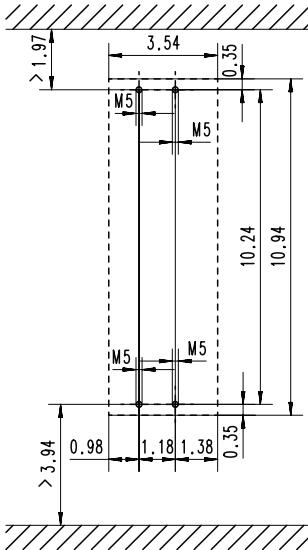
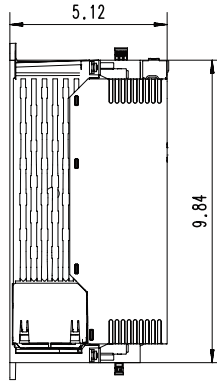
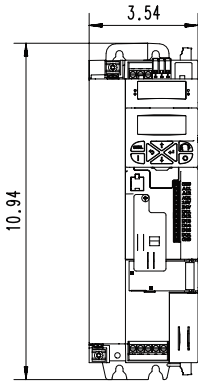

8800601

7.5 kW ... 11 kW

Die Abmessungen in mm gelten für:

7.5 kW	I51AE275F
11 kW	I51AE311F

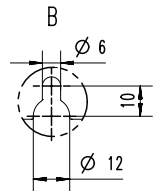
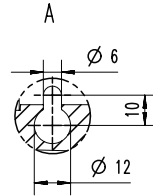
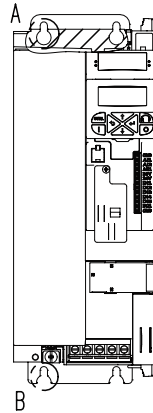
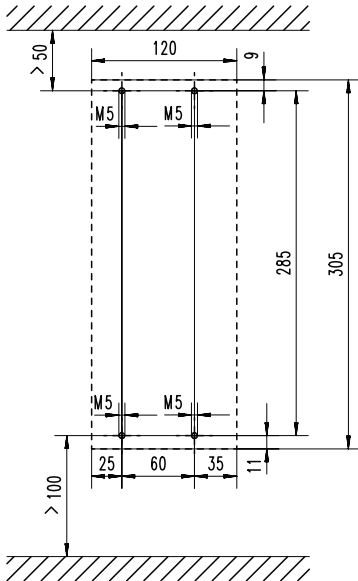
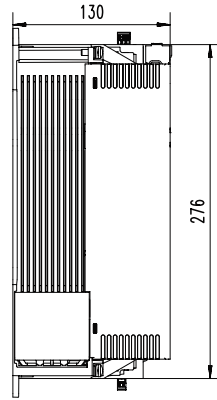
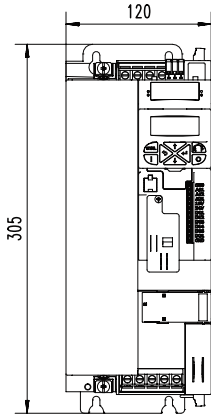

8800600

Mechanische Installation

Abmessungen

10 hp ... 15 hp

Die Abmessungen in inch gelten für:

10 hp	I51AE275F
15 hp	I51AE311F

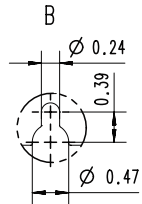
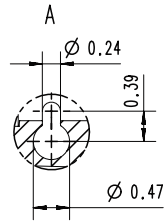
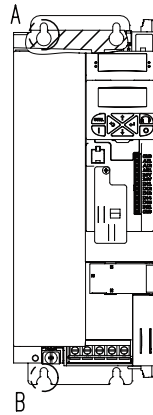
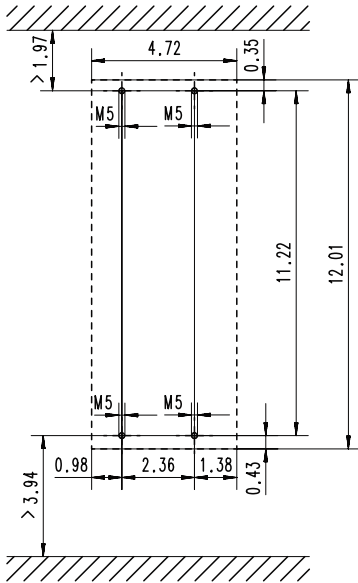
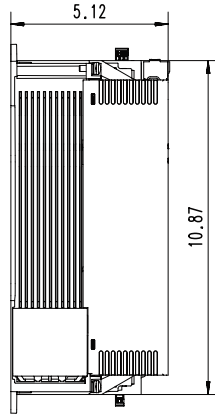
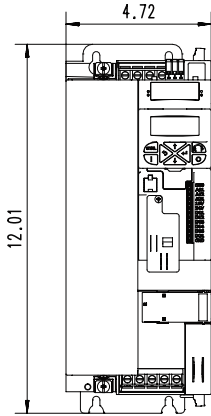

8800602

Elektrische Installation

Wichtige Hinweise

GEFAHR!

Elektrische Spannung

Mögliche Folge: Tod oder schwere Verletzungen

- ▶ Alle Arbeiten am Inverter nur im spannungslosen Zustand durchführen.
 - ▶ Inverter bis 45 kW: Nach dem Abschalten der Netzspannung mindestens 3 min warten, bevor Sie mit den Arbeiten beginnen.
 - ▶ Inverter ab 55 kW: Nach dem Abschalten der Netzspannung mindestens 10 min warten, bevor Sie mit den Arbeiten beginnen.
-

GEFAHR!

Gefährliche elektrische Spannung

Der Ableitstrom gegen Erde (PE) ist $> 3.5 \text{ mA AC}$ bzw. $> 10 \text{ mA DC}$.

Mögliche Folgen: Tod oder schwere Verletzungen beim Berühren des Gerätes im Fehlerfall.

- ▶ Die in der EN 61800-5-1 oder EN 60204-1 geforderten Maßnahmen umsetzen. Insbesondere:
 - ▶ Festinstallation
 - ▶ PE-Anschluss normgerecht ausführen (PE-Leiterdurchmesser $\geq 10 \text{ mm}^2$ oder PE-Leiter doppelt ausführen)
-

Anschluss nach UL

WARNUNG!

- ▶ **UL marking**
 - ▶ The integral solid state short circuit protection included in the inverter does not provide branch circuit protection. Branch circuit protection must be provided in accordance with the National Electrical Code / Canadian Electrical Code and any additional local codes.
 - ▶ **Marquage UL**
 - ▶ La protection statique intégrée contre les courts-circuits n'offre pas la même protection que le dispositif de protection du circuit de dérivation. Un tel dispositif doit être fourni, conformément au National Electrical Code / Canadian Electrical Code et aux autres dispositions applicables au niveau local.
-

HINWEIS

- ▶ **UL marking**
 - ▶ The opening of the Branch Circuit Protective Device may be an indication that a fault has been interrupted. To reduce the risk of fire or electric shock, current-carrying parts and other components of the controller should be examined and replaced if damaged. If burnout of the current element of an overload relay occurs, the complete overload relay must be replaced.
 - ▶ **Marquage UL**
 - ▶ Le déclenchement du dispositif de protection du circuit de dérivation peut être dû à une coupure qui résulte d'un courant de défaut. Pour limiter le risque d'incendie ou de choc électrique, examiner les pièces porteuses de courant et les autres éléments du contrôleur et les remplacer s'ils sont endommagés. En cas de grillage de l'élément traversé par le courant dans un relais de surcharge, le relais tout entier doit être remplacé.
-

HINWEIS

- ▶ **UL marking**
 - ▶ Internal overload protection rated for 125 % of the rated FLA.
 - ▶ **Marquage UL**
 - ▶ Protection contre les surcharges conçue pour se déclencher à 125 % de l'intensité assignée à pleine charge.
-

WARNUNG!

- ▶ **UL marking**
 - ▶ Use 75°C copper wire only, except for control circuits.
 - ▶ **Marquage UL**
 - ▶ Utiliser exclusivement des conducteurs en cuivre 75 °C, sauf pour la partie commande.
-

 **WARNUNG!**

▶ **UL marking**

- ▶ Suitable for motor group installation or use on a circuit capable of delivering not more than the rms symmetrical amperes (SCCR) of the drive at its rated voltage.
- ▶ Approved fusing is specified in SCCR tables below.

▶ **Marquage UL**

- ▶ Convient pour l'utilisation sur une installation avec un groupe de moteurs ou sur un circuit capable de fournir au maximum une valeur de courant efficace symétrique en ampères à la tension assignée de l'appareil.
 - ▶ Les dispositifs de protection adaptés sont spécifiés dans les SCCR tableaux suivants.
-

Branch Circuit Protection (BCP) with Short Circuit Current Ratings (SCCR) with Standard Fuses. (Tested per UL61800-5-1, reference UL file E132659)

These devices are suitable for motor group installation when used with Standard Fuses. For single motor installation, if the fuse value indicated is higher than 400% of the motor current (FLA), the fuse value has to be calculated. If the value of the fuse is below two standard ratings, the nearest standard ratings less than the calculated value shall apply.

Inverter			Standard Fuses (UL248)		
Mains	kW	hp	SCCR	Max. rated current	Class
120 V, 1-ph	0.25	0.33	5 kA	15 A	CC
120 V, 1-ph	0.37	0.50	5 kA	15 A	CC
120 V, 1-ph	0.75	1.00	5 kA	30 A	CC, J, T
120 V, 1-ph	1.10	1.50	5 kA	30 A	CC, J, T
230 V, 1-ph	0.25	0.33	65 kA	15 A	CC
230 V, 1-ph	0.37	0.50	65 kA	15 A	CC
230 V, 1-ph	0.55	0.75	65 kA	15 A	CC
230 V, 1-ph	0.75	1.00	65 kA	15 A	CC
230 V, 1-ph	1.10	1.50	65 kA	30 A	CC, J, T
230 V, 1-ph	1.50	2.00	65 kA	30 A	CC, J, T
230 V, 1-ph	2.20	3.00	65 kA	30 A	CC, J, T
230 V, 1/3-ph	0.25	0.33	65 kA	15 A	CC
230 V, 1/3-ph	0.37	0.50	65 kA	15 A	CC
230 V, 1/3-ph	0.55	0.75	65 kA	15 A	CC
230 V, 1/3-ph	0.75	1.00	65 kA	15 A	CC
230 V, 1/3-ph	1.10	1.50	65 kA	30 A	CC, J, T
230 V, 1/3-ph	1.50	2.00	65 kA	30 A	CC, J, T
230 V, 1/3-ph	2.20	3.00	65 kA	30 A	CC, J, T
230 V, 3-ph	4.00	5.00	100 kA	40 A	J, T
230 V, 3-ph	5.50	7.50	100 kA	40 A	J, T
480 V, 3-ph	0.37	0.50	65 kA	15 A	CC
480 V, 3-ph	0.55	0.75	65 kA	15 A	CC
480 V, 3-ph	0.75	1.00	65 kA	15 A	CC
480 V, 3-ph	1.1	1.5	65 kA	15 A	CC
480 V, 3-ph	1.5	2.0	65 kA	15 A	CC
480 V, 3-ph	2.2	3.0	65 kA	15 A	CC
480 V, 3-ph	3.0	4.0	65 kA	25 A	CC, J, T
480 V, 3-ph	4.0	5.0	65 kA	25 A	CC, J, T
480 V, 3-ph	5.5	7.5	65 kA	25 A	CC, J, T
480 V, 3-ph	7.5	10.0	65 kA	40 A	J, T
480 V, 3-ph	11.0	15.0	65 kA	40 A	J, T
480 V, 3-ph	15.0	20.0	100 kA	70 A	J, T
480 V, 3-ph	18.5	25.0	100 kA	70 A	J, T
480 V, 3-ph	22	30	100 kA	70 A	J, T
480 V, 3-ph *	30	40	22 kA	125 A	J, T
480 V, 3-ph *	37	50	22 kA	125 A	J, T
480 V, 3-ph *	45	60	22 kA	125 A	J, T
480 V, 3-ph *	55	75	22 kA	200 A	J, T
480 V, 3-ph *	75	100	22 kA	200 A	J, T
480 V, 3-ph *	90	125	22 kA	300 A	J, T
480 V, 3-ph *	110	150	22 kA	300 A	J, T

* Mains choke required

Branch Circuit Protection (BCP) with Short Circuit Current Rating (SCCR) for Semiconductor Fuses and Circuit Breaker. (Tested per UL61800-5-1, reference UL file E132659)

These devices are suitable for motor group installation when used with Circuit Breakers. For single motor installation, if the fuse value indicated is higher than 400% of the motor current (FLA), the fuse value has to be calculated. If the value of the fuse is below two standard ratings, the nearest standard ratings less than the calculated value shall apply.

Inverter			Alternate Fuse (Semiconductor Fuse)		Circuit Breaker (UL489)		
Mains	kW	hp	SCCR	Fuse type	SCCR	Max. rated current	Min. cabinet dimensions
120 V, 1-ph	0.25	0.33		n/a	5 kA	15 A	n/a
120 V, 1-ph	0.37	0.50			5 kA	15 A	
120 V, 1-ph	0.75	1.00			5 kA	30 A	
120 V, 1-ph	1.10	1.50			5 kA	30 A	
230 V, 1-ph	0.25	0.33	100 kA	Mersen A60Q15-2	65 kA	15 A	0.042 m ³ 1.48 ft ³
230 V, 1-ph	0.37	0.50	100 kA	Mersen A60Q15-2	65 kA	15 A	
230 V, 1-ph	0.55	0.75	100 kA	Mersen A70QS40-14F	65 kA	15 A	
230 V, 1-ph	0.75	1.00	100 kA	Mersen A70QS40-14F	65 kA	15 A	
230 V, 1-ph	1.10	1.50	100 kA	Mersen A70QS40-14F	65 kA	30 A	
230 V, 1-ph	1.50	2.00	100 kA	Mersen A70QS40-14F	65 kA	30 A	
230 V, 1-ph	2.20	3.00	100 kA	Mersen A70QS40-14F	65 kA	30 A	
230 V, 1/3-ph	0.25	0.33	100 kA	Mersen A60Q15-2	65 kA	15 A	0.042 m ³ 1.48 ft ³
230 V, 1/3-ph	0.37	0.50	100 kA	Mersen A60Q15-2	65 kA	15 A	
230 V, 1/3-ph	0.55	0.75	100 kA	Mersen A70QS40-14F	65 kA	15 A	
230 V, 1/3-ph	0.75	1.00	100 kA	Mersen A70QS40-14F	65 kA	15 A	
230 V, 1/3-ph	1.10	1.50	100 kA	Mersen A70QS40-14F	65 kA	30 A	
230 V, 1/3-ph	1.50	2.00	100 kA	Mersen A70QS40-14F	65 kA	30 A	
230 V, 1/3-ph	2.20	3.00	100 kA	Mersen A70QS40-14F	65 kA	30 A	
230 V, 3-ph	4.00	5.00	100 kA	Mersen A70QS50-22F	65 kA	40 A	0.042 m ³
230 V, 3-ph	5.50	7.50	100 kA	Mersen A70QS50-22F	65 kA	40 A	1.48 ft ³
480 V, 3-ph	0.37	0.50	100 kA	Mersen A70QS6-14F	65 kA	15 A	0.042 m ³ 1.48 ft ³
480 V, 3-ph	0.55	0.75	100 kA	Mersen A60Q15-2	65 kA	15 A	
480 V, 3-ph	0.75	1.00	100 kA	Mersen A60Q15-2	65 kA	15 A	
480 V, 3-ph	1.1	1.5	100 kA	Mersen A60Q15-2	65 kA	15 A	
480 V, 3-ph	1.5	2.0	100 kA	Mersen A60Q15-2	65 kA	15 A	
480 V, 3-ph	2.2	3.0	100 kA	Mersen A60Q15-2	65 kA	15 A	
480 V, 3-ph	3.0	4.0	100 kA	Mersen A70QS40-14F Mersen A70QS40-22F Mersen A70QS40-4	65 kA	25 A	
480 V, 3-ph	4.0	5.0		Eaton/Bussmann FWP-50A14Fa Eaton/Bussmann FWP-50A22F Eaton/Bussmann FWP-50B Littlefuse L70QS050			
480 V, 3-ph	5.5	7.5	100 kA	Mersen A70QS40-14F	65 kA	25 A	0.042 m ³ 1.48 ft ³
480 V, 3-ph	7.5	10.0	100 kA	Mersen A70QS50-22F	65 kA	40 A	
480 V, 3-ph	11.0	15.0	100 kA	Mersen A70QS50-22F	65 kA	40 A	
480 V, 3-ph	15.0	20.0	100 kA	Mersen A70QS80-22F	65 kA	60 A	0.17 m ³ 6 ft ³
480 V, 3-ph	18.5	25.0	100 kA	Mersen A70QS80-22F	65 kA	60 A	
480 V, 3-ph	22	30	100 kA	Mersen A70QS80-22F	65 kA	60 A	
480 V, 3-ph *	30	40	100 kA	Mersen A70QS80-4	35 kA	125 A	0.57 m ³ 20 ft ³
480 V, 3-ph *	37	50	100 kA	Mersen A70QS100-4	35 kA	125 A	
480 V, 3-ph *	45	60	100 kA	Mersen A70QS125-4	35 kA	125 A	
480 V, 3-ph *	55	75	100 kA	Mersen A70QS200-4	35 kA	200 A	
480 V, 3-ph *	75	100	100 kA	Mersen A70QS200-4	35 kA	200 A	
480 V, 3-ph *	90	125	100 kA	Eaton FWP-350A Mersen A70QS350-4	10 kA	300 A	
480 V, 3-ph *	110	150	100 kA	Eaton FWP-350A Mersen A70QS350-4	10 kA	300 A	

* Mains choke required

Elektrische Installation

Netzanschluss

1-phasiger Netzanschluss 230/240 V

Netzanschluss

1-phasiger Netzanschluss 230/240 V

Anschlusspläne

Der Anschlussplan ist gültig für die Inverter I51AExxB.



Abb. 1: Anschlussbeispiel

S1 Start/Stopp
Fx Sicherungen

Q1 Netzschütz
-- Gestrichelt dargestellt = Optionen

Der Anschlussplan ist gültig für die Inverter I51AExxD.

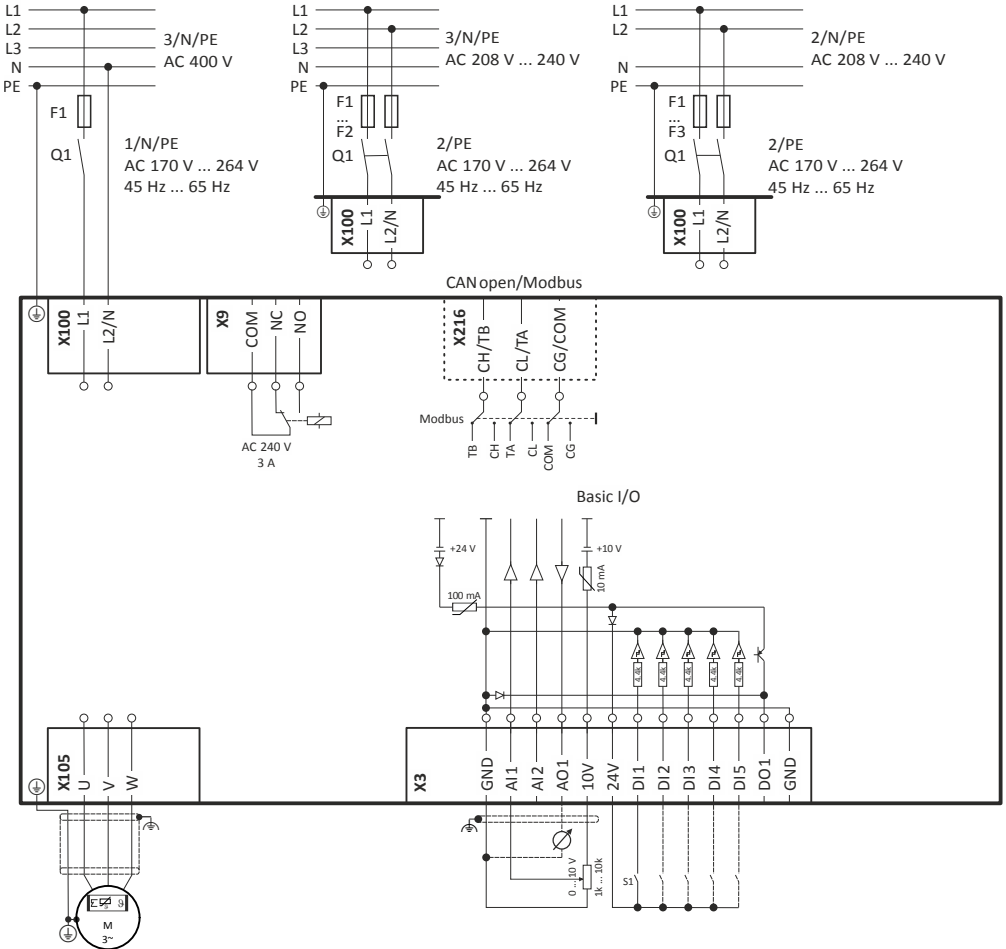

Inverter I51AExxD haben kein integriertes Funkentstörfilter in der AC-Netzeinspeisung.
Um die EMV-Anforderungen nach EN 61800-3 zu erfüllen, muss ein externes EMV-Filter nach IEC EN 60939 eingesetzt werden.

Der Anwender muss nachweisen, dass die Konformität zur EN 61800-3 erfüllt wird.



Abb. 2: Anschlussbeispiel

S1 Start/Stop
Fx Sicherungen

Q1 Netzschütz
--- Gestrichelt dargestellt = Optionen

Elektrische Installation

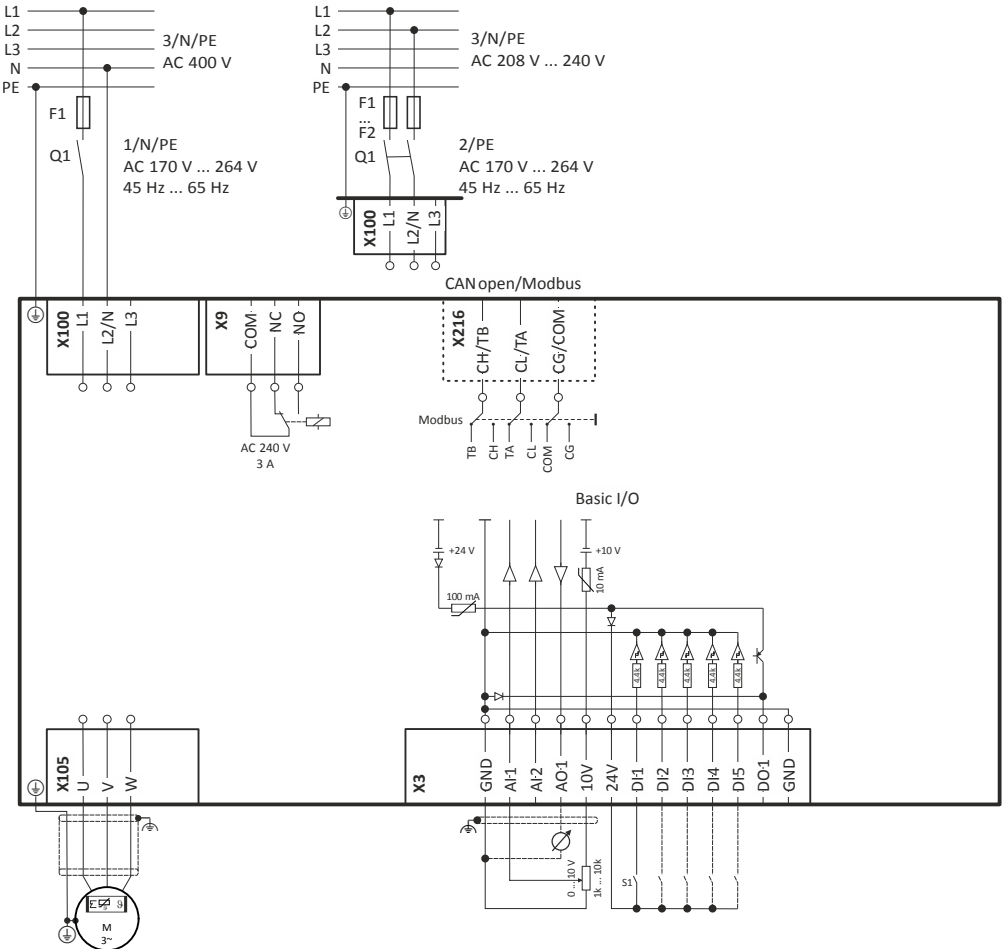
Netzanschluss

1-phasiger Netzanschluss 230/240 V

Klemmendaten

Inverter	kW	I51AExxxx			
		0.25 ... 0.75	1.1 ... 2.2	0.25 ... 2.2	0.25 ... 2.2
Anschluss		Netzanschluss X100		PE-Anschluss	Motoranschluss X105
Anschlussstyp		Steckbare Schraubklemme		PE-Schraube	Steckbare Schraubklemme
Max. Leitungsquerschnitt	mm ²	2.5	6	6	2.5
Abisolierlänge	mm	8	8	10	8
Anziehdrehmoment	Nm	0.5	0.7	2	0.5
Benötigtes Werkzeug		0.5 x 3.0	0.6 x 3.5	Torx 20	0.5 x 3.0

Absicherungsdaten

EN 60204-1

Inverter	Schmelzsicherung		Sicherungsautomat		Fehlerstrom-Schutzschalter
	Charakteristik	Max. Bemessungsstrom	Charakteristik	Max. Bemessungsstrom	
		A		A	
I51AE125B	gG/gL oder gRL	10	B	10	≥ 30 mA, Typ A oder B
I51AE125D	gG/gL oder gRL	10	B	10	≥ 30 mA, Typ A oder B
I51AE137B	gG/gL oder gRL	10	B	10	≥ 30 mA, Typ A oder B
I51AE137D	gG/gL oder gRL	10	B	10	≥ 30 mA, Typ A oder B
I51AE155B	gG/gL oder gRL	16	B	16	≥ 30 mA, Typ A oder B
I51AE155D	gG/gL oder gRL	16	B	16	≥ 30 mA, Typ A oder B
I51AE175B	gG/gL oder gRL	16	B	16	≥ 30 mA, Typ A oder B
I51AE175D	gG/gL oder gRL	16	B	16	≥ 30 mA, Typ A oder B
I51AE211B	gG/gL oder gRL	25	B	25	≥ 30 mA, Typ A oder B
I51AE211D	gG/gL oder gRL	25	B	25	≥ 30 mA, Typ A oder B
I51AE215B	gG/gL oder gRL	25	B	25	≥ 30 mA, Typ A oder B
I51AE215D	gG/gL oder gRL	25	B	25	≥ 30 mA, Typ A oder B
I51AE222B	gG/gL oder gRL	25	B	25	≥ 30 mA, Typ A oder B
I51AE222D	gG/gL oder gRL	25	B	25	≥ 30 mA, Typ A oder B

3-phasiger Netzanschluss 230/240 V

Anschlusspläne

Der Anschlussplan ist gültig für den Inverter I51AExxxC.



Inverter I51AExxxC hat kein integriertes Funkentstörfilter in der AC-Netzspeisung.

Um die EMV-Anforderungen nach EN 61800-3 zu erfüllen, muss ein externes EMV-Filter nach IEC EN 60939 eingesetzt werden.

Der Anwender muss nachweisen, dass die Konformität zur EN 61800-3 erfüllt wird.



Abb. 3: Anschlussbeispiel

- S1 Start/Stopp
- Fx Sicherungen

- Q1 Netzschütz
- Gestrichelt dargestellt = Optionen

Der Anschlussplan ist gültig für den Inverter I51AExxxD.

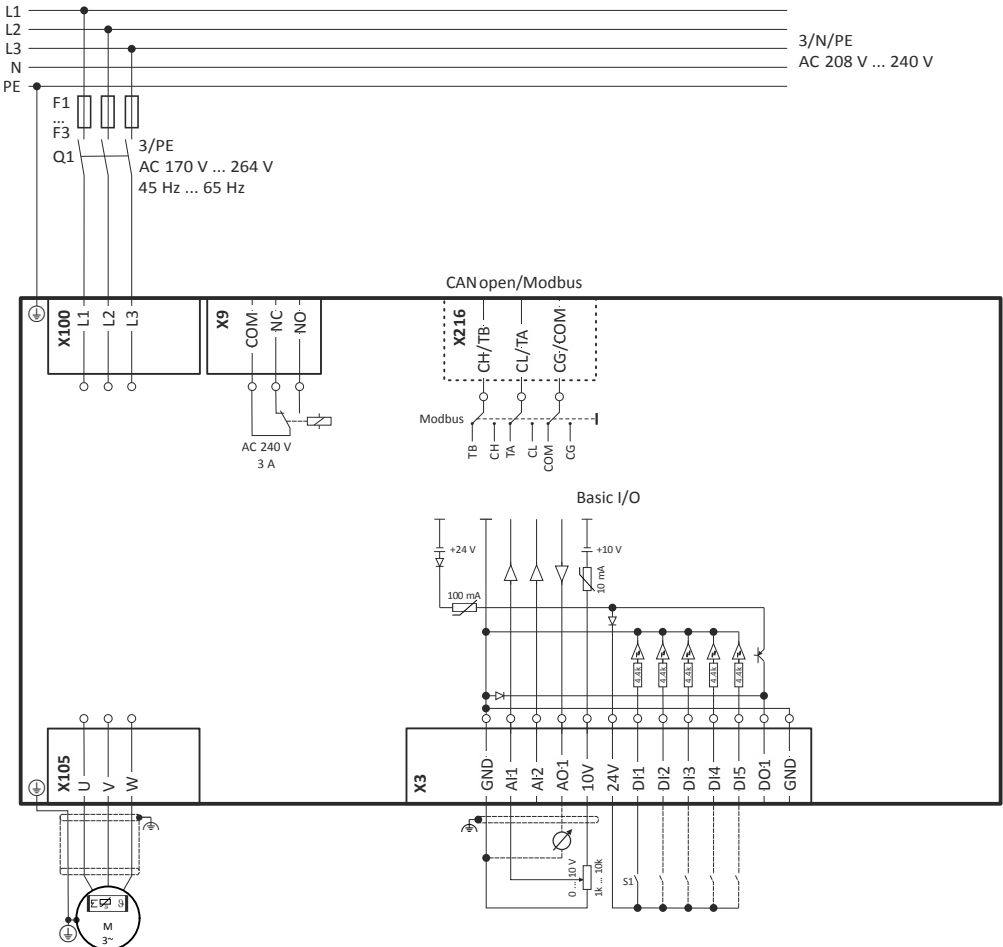

Inverter I51AExxxD hat kein integriertes Funkentstörfilter in der AC-Netzeinspeisung.
 Um die EMV-Anforderungen nach EN 61800-3 zu erfüllen, muss ein externes EMV-Filter nach IEC EN 60939 eingesetzt werden.
 Der Anwender muss nachweisen, dass die Konformität zur EN 61800-3 erfüllt wird.



Abb. 4: Anschlussbeispiel

S1 Start/Stop
 Fx Sicherungen

Q1 Netzschütz
 --- Gestrichelt dargestellt = Optionen

Klemmendaten

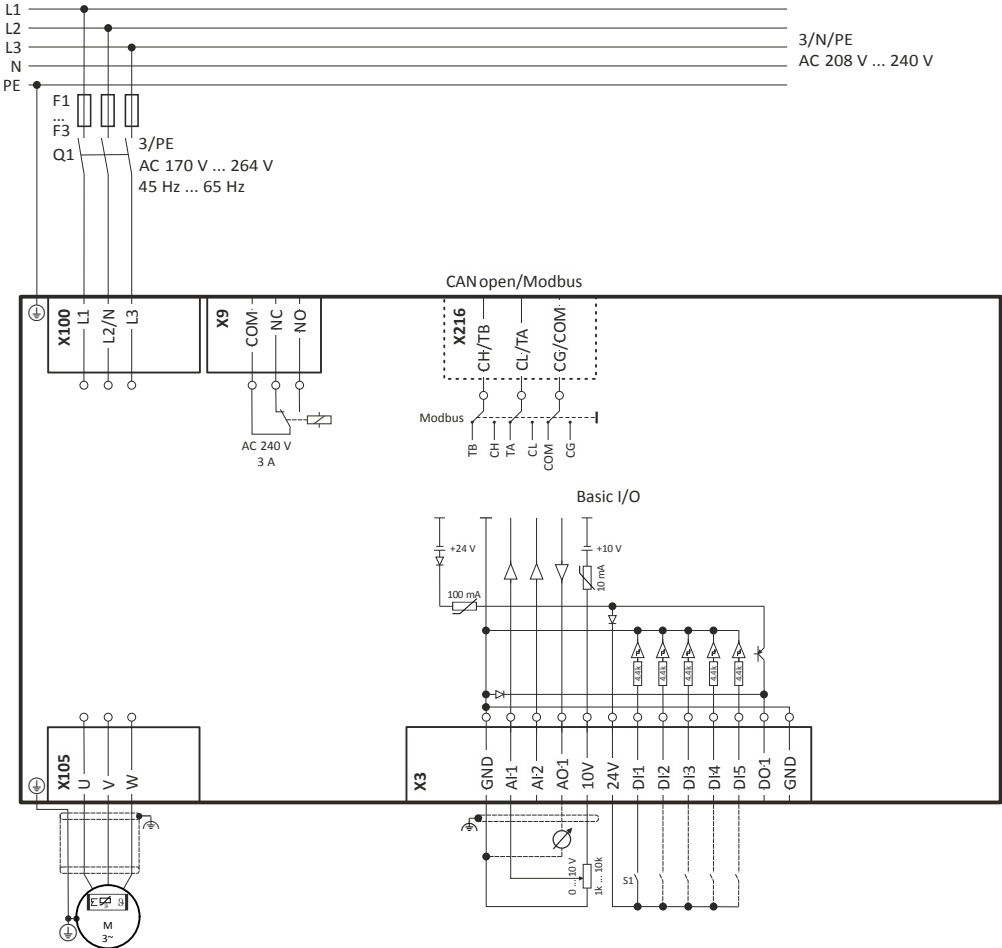
Inverter	I51AExxxx						
Inverter	kW	0.25 ... 0.75	1.1 ... 2.2	4.0 ... 5.5	0.25 ... 5.5	0.25 ... 2.2	4.0 ... 5.5
Anschluss		Netzanschluss X100			PE-Anschluss	Motoranschluss X105	
Anschlussstyp		Steckbare Schraubklemme		Schraubklemme	PE-Schraube	Steckbare Schraubklemme	Schraubklemme
Max. Leitungsquerschnitt	mm ²	2.5	6	6	6	2.5	6
Abisolierlänge	mm	8	8	9	10	8	9
Anziehdrehmoment	Nm	0.5	0.7	0.5	2	0.5	0.5
Benötigtes Werkzeug		0.5 x 3.0		0.6 x 3.5		Torx 20	0.5 x 3.0

Absicherungsdaten**EN 60204-1**

Inverter	Schmelzsicherung		Sicherungsautomat		Fehlerstrom-Schutzschalter
	Charakteristik	Max. Bemessungsstrom	Charakteristik	Max. Bemessungsstrom	
		A		A	
I51AE125D	gG/gL oder gRL	10	B	10	≥ 30 mA, Typ B
I51AE137D	gG/gL oder gRL	10	B	10	≥ 30 mA, Typ B
I51AE155D	gG/gL oder gRL	16	B	16	≥ 30 mA, Typ B
I51AE175D	gG/gL oder gRL	16	B	16	≥ 30 mA, Typ B
I51AE211D	gG/gL oder gRL	25	B	25	≥ 30 mA, Typ B
I51AE215D	gG/gL oder gRL	25	B	25	≥ 30 mA, Typ B
I51AE222D	gG/gL oder gRL	25	B	25	≥ 30 mA, Typ B
I51AE240C	gG/gL oder gRL	32	B	32	≥ 300 mA, Typ B
I51AE255C	gG/gL oder gRL	32	B	32	≥ 300 mA, Typ B

3-phasiger Netzanschluss 230/240 V "Light Duty"**Anschlusspläne**

Siehe "3-phasiger Netzanschluss 230/240 V". [☰ 39](#)

Klemmendaten

Inverter	I51AExxxx			
Inverter	kW	5.5 ... 7.5	5.5 ... 7.5	5.5 ... 7.5
Anschluss		Netzanschluss X100		Motoranschluss X105
Anschlussstyp		Schraubklemme		Schraubklemme
Max. Leitungsquerschnitt	mm ²	6		6
Abisolierlänge	mm	9		10
Anziehdrehmoment	Nm	0.5		2
Benötigtes Werkzeug		0.6 x 3.5		Torx 20

Absicherungsdaten**EN 60204-1**

Inverter	Schmelzsicherung		Sicherungsautomat		Fehlerstrom-Schutzschalter
	Charakteristik	Max. Bemessungsstrom	Charakteristik	Max. Bemessungsstrom	
		A		A	
I51AE240C	gG/gL oder gRL	32	B	32	≥ 300 mA, Typ B
I51AE255C	gG/gL oder gRL	32	B	32	≥ 300 mA, Typ B

Elektrische Installation

Netzanschluss

3-phasiger Netzanschluss 400 V

3-phasiger Netzanschluss 400 V

Anschlusspläne

Der Anschlussplan ist gültig für die Inverter I51AExxxF und I51BExxxF.



Abb. 5: Anschlussbeispiel

S1 Start/Stopp
Fx Sicherungen

Q1 Netzschütz
-- Gestrichelt dargestellt = Optionen

Klemmendaten

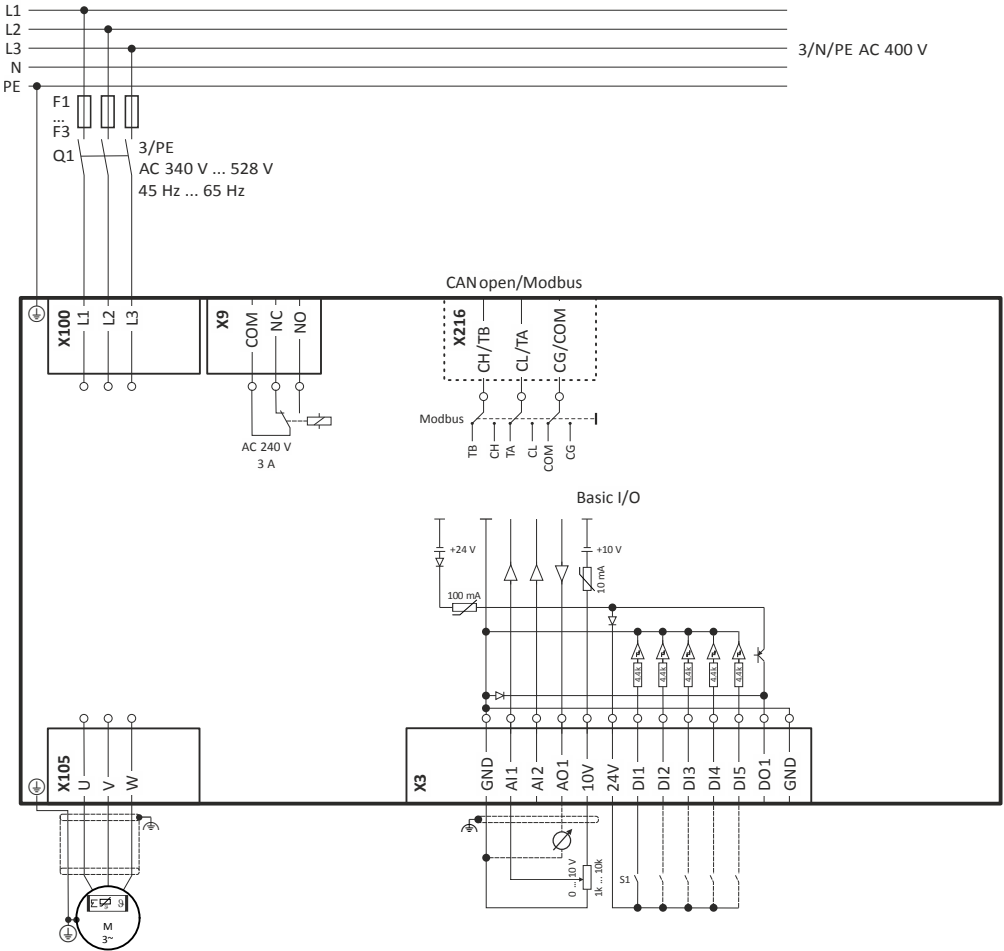
Inverter		I51AExxxF					
Inverter	kW	0.37 ... 2.2	3.0 ... 4.0	5.5	7.5 ... 11	0.37 ... 5.5	3.0 ... 4.0
Anschluss		Netzanschluss X100				PE-Anschluss	
Anschlusstyp		Steckbare Schraubklemme	Schraubklemme			PE-Schraube	
Max. Leitungsquerschnitt	mm ²	2.5	6	6	16	6	6
Abisolierlänge	mm	8	9	9	11	10	10
Anziehdrehmoment	Nm	0.5	0.5	0.5	1.2	2	2
Benötigtes Werkzeug		0.5 x 3.0	0.6 x 3.5		0.8 x 4.0	Torx 20	

Inverter		I51AExxxF					
Inverter	kW	7.5 ... 11	0.37 ... 2.2	3.0 ... 4.0	5.5	7.5 ... 11	
Anschluss		PE-Anschluss	Motoranschluss X105				
Anschlusstyp		PE-Schraube	Steckbare Schraubklemme	Schraubklemme			
Max. Leitungsquerschnitt	mm ²	16	2.5	6	6	16	
Abisolierlänge	mm	11	8	9	9	11	
Anziehdrehmoment	Nm	3.4	0.5	0.5	0.5	1.2	
Benötigtes Werkzeug		PZ2	0.5 x 3.0	0.6 x 3.5		0.8 x 4.0	

Inverter		I51BExxxF			
Inverter	kW	3.0 ... 4.0	3.0 ... 4.0	3.0 ... 4.0	3.0 ... 4.0
Anschluss		Netzanschluss X100	PE-Anschluss	Motoranschluss X105	
Anschlusstyp		Steckbare Schraubklemme	PE-Schraube	Steckbare Schraubklemme	
Max. Leitungsquerschnitt	mm ²	4	6	2.5	
Abisolierlänge	mm	8	10	8	
Anziehdrehmoment	Nm	0.6	2	0.5	
Benötigtes Werkzeug		0.5 x 3.0	Torx 20	0.5 x 3.0	

Absicherungsdaten

EN 60204-1

Inverter	Schmelzsicherung		Sicherungsautomat		Fehlerstrom-Schutzschalter
	Charakteristik	Max. Bemessungsstrom	Charakteristik	Max. Bemessungsstrom	
		A		A	
I51AE137F	gG/gL oder gRL	10	B	10	≥ 30 mA, Typ B
I51AE155F	gG/gL oder gRL	10	B	10	≥ 30 mA, Typ B
I51AE175F	gG/gL oder gRL	10	B	10	≥ 30 mA, Typ B
I51AE211F	gG/gL oder gRL	16	B	16	≥ 30 mA, Typ B
I51AE215F	gG/gL oder gRL	16	B	16	≥ 30 mA, Typ B
I51AE222F	gG/gL oder gRL	16	B	16	≥ 30 mA, Typ B
I51AE230F	gG/gL oder gRL	25	B	25	≥ 300 mA, Typ B
I51BE230F	gG/gL oder gRL	25	B	25	≥ 30 mA, Typ B
I51AE240F	gG/gL oder gRL	25	B	25	≥ 300 mA, Typ B
I51BE240F	gG/gL oder gRL	25	B	25	≥ 30 mA, Typ B
I51AE255F	gG/gL oder gRL	25	B	25	≥ 300 mA, Typ B
I51AE275F	gG/gL oder gRL	32	B	32	≥ 300 mA, Typ B
I51AE311F	gG/gL oder gRL	32	B	32	≥ 300 mA, Typ B

Elektrische Installation

Netzanschluss

3-phasiger Netzanschluss 400 V "Light Duty"

3-phasiger Netzanschluss 400 V "Light Duty"

Anschlusspläne

Siehe "3-phasiger Netzanschluss 400 V". [📄 42](#)

Klemmendaten

Siehe "Klemmendaten". [📄 43](#)

Absicherungsdaten

EN 60204-1

Inverter	Schmelzsicherung		Sicherungsautomat		Fehlerstrom-Schutzschalter
	Charakteristik	Max. Bemessungsstrom	Charakteristik	Max. Bemessungsstrom	
		A		A	
I51AE230F	gG/gL oder gRL	25	B	25	≥ 300 mA, Typ B
I51BE230F	gG/gL oder gRL	25	B	25	≥ 30 mA, Typ B
I51AE240F	gG/gL oder gRL	25	B	25	≥ 300 mA, Typ B
I51BE240F	gG/gL oder gRL	25	B	25	≥ 30 mA, Typ B
I51AE255F	gG/gL oder gRL	25	B	25	≥ 300 mA, Typ B
I51AE275F	gG/gL oder gRL	32	B	32	≥ 300 mA, Typ B
I51AE311F	gG/gL oder gRL	32	B	32	≥ 300 mA, Typ B

3-phasiger Netzanschluss 480 V

Anschlusspläne

Der Anschlussplan ist gültig für die Inverter I51AExxF.



Abb. 6: Anschlussbeispiel

S1 Start/Stop
 Fx Sicherungen

Q1 Netzschütz
 --- Gestrichelt dargestellt = Optionen

Klemmendaten

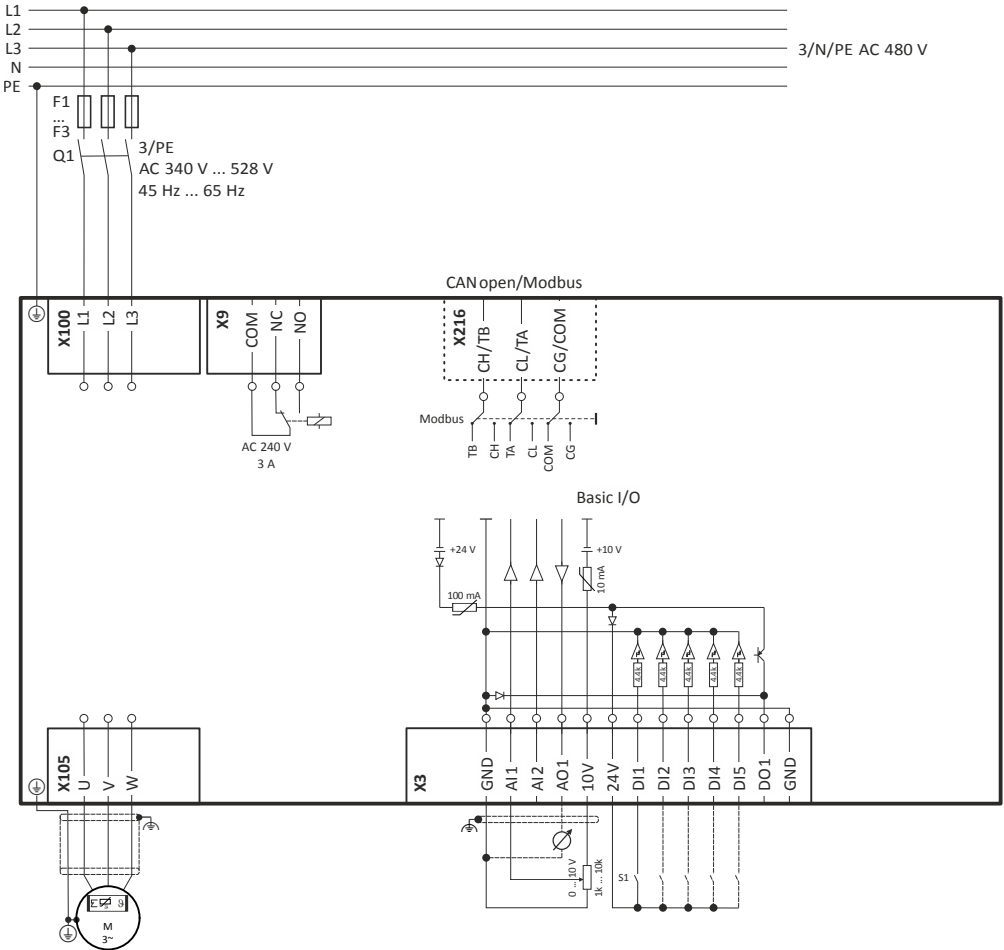
Siehe "Klemmendaten". [📄 43](#)

Elektrische Installation

Netzanschluss

3-phasiger Netzanschluss 480 V "Light Duty"

Absicherungsdaten

EN 60204-1

Inverter	Schmelzsicherung		Sicherungsautomat		Fehlerstrom-Schutzschalter
	Charakteristik	Max. Bemessungsstrom	Charakteristik	Max. Bemessungsstrom	
		A		A	
I51AE137F	gG/gL oder gRL	10	B	10	≥ 30 mA, Typ B
I51AE155F	gG/gL oder gRL	10	B	10	≥ 30 mA, Typ B
I51AE175F	gG/gL oder gRL	10	B	10	≥ 30 mA, Typ B
I51AE211F	gG/gL oder gRL	16	B	16	≥ 30 mA, Typ B
I51AE215F	gG/gL oder gRL	16	B	16	≥ 30 mA, Typ B
I51AE222F	gG/gL oder gRL	16	B	16	≥ 30 mA, Typ B
I51AE230F	gG/gL oder gRL	25	B	25	≥ 300 mA, Typ B
I51BE230F	gG/gL oder gRL	25	B	25	≥ 30 mA, Typ B
I51AE240F	gG/gL oder gRL	25	B	25	≥ 300 mA, Typ B
I51BE240F	gG/gL oder gRL	25	B	25	≥ 30 mA, Typ B
I51AE255F	gG/gL oder gRL	25	B	25	≥ 300 mA, Typ B
I51AE275F	gG/gL oder gRL	32	B	32	≥ 300 mA, Typ B
I51AE311F	gG/gL oder gRL	32	B	32	≥ 300 mA, Typ B

3-phasiger Netzanschluss 480 V "Light Duty"

Anschlusspläne

Siehe "3-phasiger Netzanschluss 480 V". [45](#)

Klemmendaten

Siehe "Klemmendaten". [43](#)

Absicherungsdaten

EN 60204-1

Inverter	Schmelzsicherung		Sicherungsautomat		Fehlerstrom-Schutzschalter
	Charakteristik	Max. Bemessungsstrom	Charakteristik	Max. Bemessungsstrom	
		A		A	
I51AE230F	gG/gL oder gRL	25	B	25	≥ 300 mA, Typ B
I51BE230F	gG/gL oder gRL	25	B	25	≥ 30 mA, Typ B
I51AE240F	gG/gL oder gRL	25	B	25	≥ 300 mA, Typ B
I51BE240F	gG/gL oder gRL	25	B	25	≥ 30 mA, Typ B
I51AE255F	gG/gL oder gRL	25	B	25	≥ 300 mA, Typ B
I51AE275F	gG/gL oder gRL	32	B	32	≥ 300 mA, Typ B
I51AE311F	gG/gL oder gRL	32	B	32	≥ 300 mA, Typ B

Anschluss an das IT-Netz

Für den störungsfreien Betrieb am IT-Netz unbedingt diese Maßnahmen beachten:

- Einen Trenntransformator vorschalten.
- Die IT-Schrauben entfernen. Sonst sprechen die Überwachungseinrichtungen im IT-Netz an, da geräteinterne Komponenten mit der Schutzerde (PE) verbunden sind.

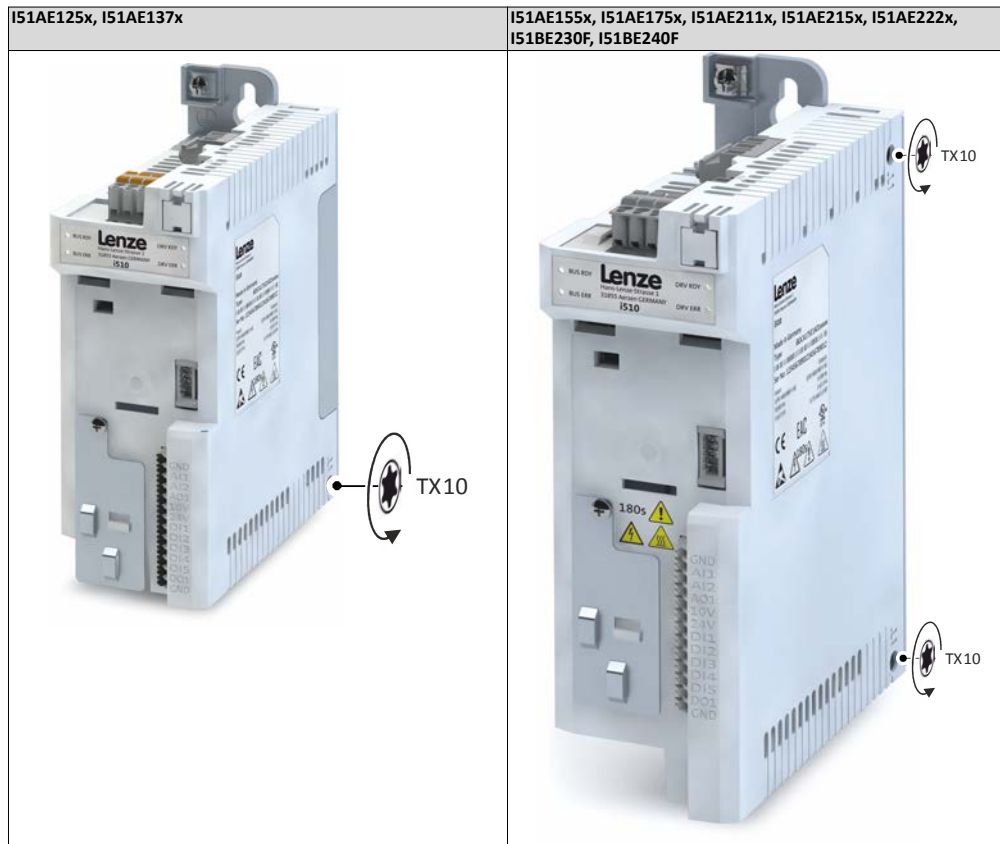

I51AE230x, I51AE240x, I51AE255x, I51AE275x, I51AE311x

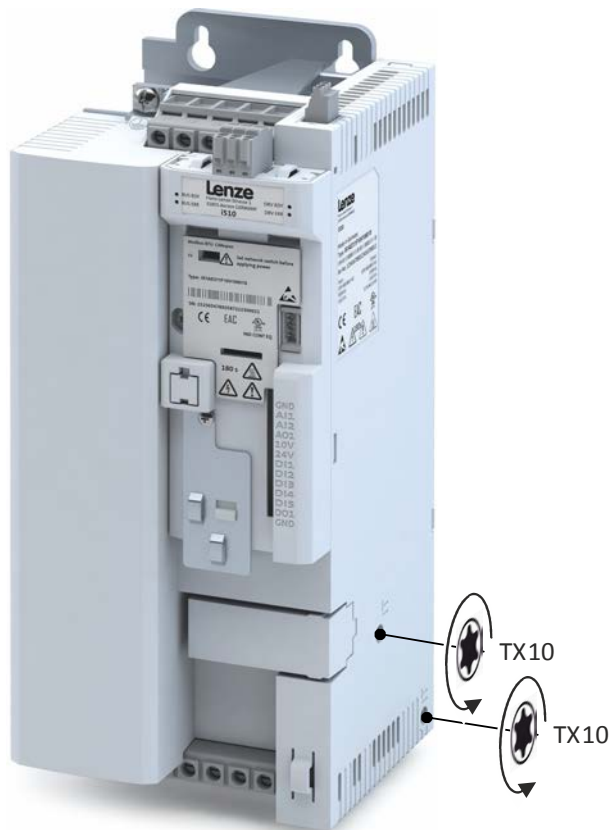

Steueranschlüsse

Beschreibung des Anschlusses		Steuerklemmen
Anschluss		X3
Anschlussart		Federkraftklemme
Max. Leitungsquerschnitt	mm ²	1.5
Max. Leitungsquerschnitt	AWG	16
Abisolierlänge	mm	9
Abisolierlänge	inch	0.35
Anziehdrehmoment	Nm	-
Anziehdrehmoment	lb-in	-
Benötigtes Werkzeug		0.4 x 2.5

Netzwerke

CANopen/Modbus



Das Netzwerk muss am physikalisch ersten und letzten Busteilnehmer mit einem 120 Ω-Widerstand abgeschlossen sein.

Den Widerstand an die Klemmen CH/TB und CL/TA anschließen.

Typische Topologien

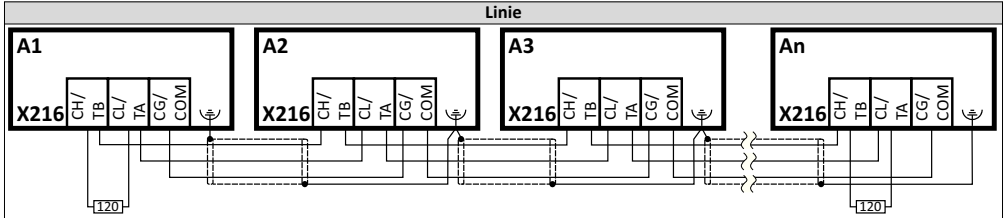

Beschreibung des Anschlusses		CANopen/Modbus	
Anschluss		X216	
Anschlussstyp		Steckbare Federkraft-Doppelklemme	
Max. Leitungsquerschnitt	mm ²	2.5	
Max. Leitungsquerschnitt	AWG	12	
Abisolierlänge	mm	10	
Abisolierlänge	inch	0.39	
Anziehdrehmoment	Nm	-	
Anziehdrehmoment	lb-in	-	
Benötigtes Werkzeug		0.4 x 2.5	

Netzwerk-Grundeinstellungen

1. Netzwerk CANopen oder Modbus mit dem Schalter auf der Frontseite des Inverters auswählen.

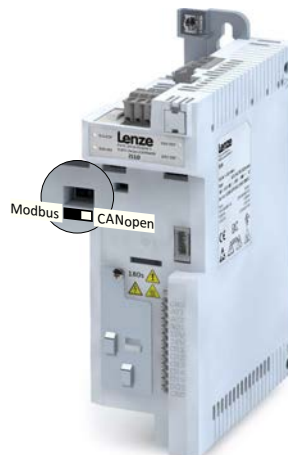

2. Knotenadresse und Baudrate über die entsprechenden Parameter einstellen.

Inbetriebnahme

Die Inbetriebnahme hat zum Ziel, den Inverter als Bestandteil einer Maschine mit drehzahlverstellbarem Antriebssystem an seine Antriebsaufgabe anzupassen.

Wichtige Hinweise



GEFAHR!

Fehlerhafte Verdrahtung kann zu unerwarteten Zuständen während der Inbetriebnahme führen.

Mögliche Folgen: Tod, schwere Verletzungen oder Sachschäden

Prüfen Sie vor dem Einschalten der Netzspannung:

- ▶ Die Verdrahtung auf vollständige und richtige Ausführung.
 - ▶ Die Verdrahtung auf Kurzschlüsse und Erdschlüsse.
 - ▶ Ob die Schaltungsart des Motors (Stern/Dreieck) an die Ausgangsspannung des Inverters angepasst ist.
 - ▶ Ob der Motor phasenrichtig angeschlossen ist (Drehrichtung).
 - ▶ Ob die Funktion "Not-Aus" der Gesamtanlage korrekt arbeitet.
-

Erstes Einschalten und Funktionstest

Zielsetzung: Den am Inverter angeschlossenen Motor innerhalb kürzester Zeit zum Drehen bringen.

Voraussetzungen:

- Der angeschlossene Motor passt leistungsmäßig zum Inverter.
- Die Parametereinstellungen entsprechen dem Auslieferungszustand (Lenze-Einstellung).

1. Vorbereitung

1. Die Leistungsanschlüsse verdrahten.
2. Die Digitaleingänge X3/DI1 (Start/Stop), X3/DI3 (Drehrichtungsumkehr) und X3/DI4 (Frequenz-Preset 20 Hz) verdrahten.
3. Klemme X3/AI1 (analoge Sollwertvorgabe) nicht beschalten oder auf GND legen.

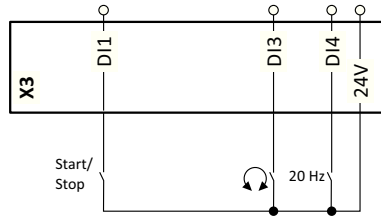

2. Netz einschalten und Betriebsbereitschaft prüfen

1. Netzspannung einschalten.
2. LED-Statusanzeigen "RDY" und "ERR" auf der Frontseite des Inverters beachten:
 - a) Blinkt die blaue LED "RDY" und die rote LED "ERR" ist aus, ist der Inverter betriebsbereit. Der Regler ist gesperrt.
Sie können den Antrieb starten.
 - b) Ist die rote LED "ERR" dauerhaft an, ist eine Störung aktiv.
Beheben Sie die Störung, bevor Sie mit dem Funktionstest fortfahren.

LED-Statusanzeigen

LED "RDY" (blau)	LED "ERR" (rot)	Zustand/Bedeutung	
aus	aus	Versorgungsspannung nicht vorhanden.	
blinkt (1 Hz)	aus	Sicher abgeschaltetes Moment (STO) aktiv.	
	blinkt schnell (4 Hz)	Sicher abgeschaltetes Moment (STO) aktiv, Warnung aktiv.	
blinkt (2 Hz)	aus	Inverter gesperrt.	
	alle 1.5 s kurz an	Inverter gesperrt, Zwischenkreisspannung nicht vorhanden.	
	blinkt schnell (4 Hz)	Inverter gesperrt, Warnung aktiv.	
	an	Inverter gesperrt, Störung aktiv.	
an	aus	Inverter freigegeben.	
	blinkt schnell (4 Hz)	Inverter freigegeben, Warnung aktiv.	Motor dreht sich entsprechend dem vorgegebenen Sollwert oder Schnellhalt aktiv.
	blinkt (1 Hz)	Inverter freigegeben, Schnellhalt als Reaktion auf eine Störung aktiv.	

Funktionstest durchführen

1. Antrieb starten

1. Inverter starten: X3/DI1 = HIGH.
2. Frequenz-Preset 1 (20 Hz) als Drehzahlsollwert aktivieren: X3/DI4 = HIGH.
Der Antrieb dreht mit 20 Hz.
3. Optional: Drehrichtungsumkehr aktivieren.
 - a) X3/DI3 = HIGH.
Der Antrieb dreht mit 20 Hz in die Gegenrichtung.
 - b) Drehrichtungsumkehr wieder deaktivieren: X3/DI3 = LOW.
Drehzahlverlauf (Beispiel)

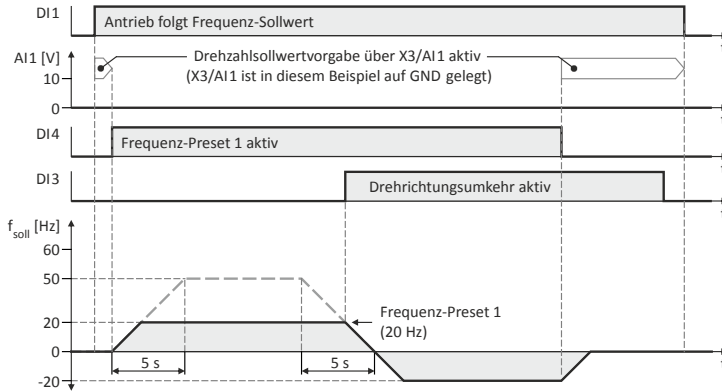

2. Antrieb stoppen

1. Frequenz-Preset 1 wieder deaktivieren: X3/DI4 = LOW.
 2. Inverter wieder stoppen: X3/DI1 = LOW.
- Der Funktionstest ist abgeschlossen.

Technische Daten

Normen und Einsatzbedingungen

Konformitäten/Approbationen

Konformität		
CE	2014/35/EU 2014/30/EU	Niederspannungsrichtlinie EMV-Richtlinie (Bezug: CE-typisches Antriebssystem)
EAC	TR ZU 004/2011	Eurasische Konformität: Sicherheit von Niederspannungsausrüstung
	TR ZU 020/2011	Eurasische Konformität: Elektromagnetische Verträglichkeit von technischen Erzeugnissen
RoHS	2011/65/EU	Beschränkung der Verwendung bestimmter gefährlicher Stoffe in Elektro- und Elektronikgeräten
Approbation		
UL	UL 61800-5-1	für USA und Kanada (Anforderungen der CSA 22.2 No. 274) File No. E132659

Personenschutz und Geräteschutz

Schutzart		
IP20	EN 60529	Angabe gilt für den betriebsfertig montierten Zustand und nicht im Anschlussbereich der Klemmen
Open type	UL 50	nur Berührschutz nur in UL-approbierten Anlagen
Isolationsfestigkeit		
Überspannungskategorie III	EN 61800-5-1	0 ... 2000 m ü. NN
Überspannungskategorie II	EN 61800-5-1	über 2000 m ü. NN
Isolation von Steuerschaltkreisen		
Sichere Trennung vom Netz durch doppelte/verstärkte Isolierung	EN 61800-5-1	
Ableitstrom		
> 3.5 mA AC, > 10 mA DC	EN 61800-5-1	Bestimmungen und Sicherheitshinweise beachten!
Einschaltstrom		
≤ 3 x Netzbemessungsstrom		
Schutzmaßnahmen gegen		
Kurzschluss		
Erdschluss		Erdschlussfestigkeit abhängig vom Betriebszustand
Übertemperatur des Motors		I ² t-Überwachung
Überspannung		
Kippen des Motors		

Angaben zur EMV

Störaussendung		
Kategorie C2	EN 61800-3	siehe Bemessungsdaten
Kategorie C3	EN 61800-3	siehe Bemessungsdaten
Störfestigkeit		
Erfüllt Anforderungen nach	EN 61800-3	
Betrieb an öffentlichen Netzen		
Maßnahmen treffen, um die zu erwartenden Funkstörungen zu begrenzen:		Die Einhaltung der Anforderungen für die Maschine/Anlage liegt in der Verantwortung des Maschinen-/Anlagenherstellers!
< 1 kW: mit Netzdrossel	EN 61000-3-2	
> 1 kW bei Netzstrom ≤ 16 A: ohne zusätzliche Maßnahmen		
Netzstrom > 16 A: Mit Netzdrossel oder Netzfilter, bei Auslegung für Bemessungsleistung.	EN 61000-3-12	

Motoranschluss

Anforderungen an die geschirmte Motorleitung		
Kapazitätsbelag		
C-Ader-Ader/C-Ader-Schirm < 75/150 pF/m		≤ 2.5 mm ² / AWG 14
C-Ader-Ader/C-Ader-Schirm < 150/300 pF/m		≥ 4 mm ² / AWG 12
Spannungsfestigkeit		
U ₀ /U = 0.6/1.0 kV		U ₀ = Effektivwert Außenleiter zu PE U = Effektivwert Außenleiter zu Außenleiter
U ≥ 600 V	UL	U = Effektivwert Außenleiter zu Außenleiter

Umweltbedingungen

Energieeffizienz		
Klasse IE2	EN 50598-2	
Klima		
1K3 (-25 ... +60 °C)	EN 60721-3-1	Lagerung
2K3 (-25 ... +70 °C)	EN 60721-3-2	Transport
3K3 (-10 ... +55 °C)	EN 60721-3-3	Betrieb
		Betrieb bei Schaltfrequenz 2 oder 4 kHz: Über +45 °C Ausgangsbemessungsstrom um 2.5 %/°C reduzieren Betrieb bei Schaltfrequenz 8 oder 16 kHz: Über +40 °C Ausgangsbemessungsstrom um 2.5 %/°C reduzieren
Aufstellhöhe		
0 ... 1000 m ü. NN		
1000 ... 4000 m ü. NN		Ausgangsbemessungsstrom um 5 %/1000 m reduzieren
Verschmutzung		
Verschmutzungsgrad 2	EN 61800-5-1	
	UL 61800-5-1	
Vibrationsfestigkeit		
Transport		
2M2 (Sinus, Schock)	EN 60721-3-2	in Originalverpackung
Betrieb		
Amplitude 1 mm beschleunigungsfest bis 0.7 g	Germanischer Lloyd	5 ... 13.2 Hz 13.2 ... 100 Hz
Amplitude 0.075 mm beschleunigungsfest bis 1 g	EN 61800-5-1	10 ... 57 Hz 57 ... 150 Hz

Netzbedingungen

Zulässige Netzsysteme		
TT		Spannung gegen Erde: max. 300 V
TN		Spannung gegen Erde: max. 300 V
IT		Die für IT-Netze beschriebenen Maßnahmen anwenden!
		IT-Netze nicht relevant für UL-approbierte Anlagen

1-phasiger Netzanschluss 230/240 V

Bemessungsdaten

Die Ausgangsströme gelten für diese Einsatzbedingungen:

- Bei Schaltfrequenz 2 kHz oder 4 kHz: Umgebungstemperatur max. 45 °C.
- Bei Schaltfrequenz 8 kHz oder 16 kHz: Umgebungstemperatur max. 40 °C.

Inverter		I51AE125B	I51AE125D	I51AE137B	I51AE137D	I51AE155B	I51AE155D
Bemessungsleistung	kW	0.25	0.25	0.37	0.37	0.55	0.55
Bemessungsleistung	hp	0.33	0.33	0.5	0.5	0.75	0.75
Netzspannungsbereich		1/PE AC 170 V ... 264 V, 45 Hz ... 65 Hz					
Ausgangsspannung		3 AC 0-230/240 V					
Netz Bemessungsstrom							
ohne Netzdrossel	A	4	4	5.7	5.7	7.6	7.6
mit Netzdrossel	A	3.6	3.6	4.8	4.8	7.1	7.1
Ausgangsscheinleistung	kVA	0.6	0.6	0.9	0.9	1.2	1.2
Ausgangsbemessungsstrom							
2 kHz	A	-	-	-	-	3.2	3.2
4 kHz	A	1.7	1.7	2.4	2.4	3.2	3.2
8 kHz	A	1.7	1.7	2.4	2.4	3.2	3.2
16 kHz	A	1.1	1.1	1.6	1.6	2.1	2.1
Verlustleistung							
2 kHz	W	-	-	-	-	22	22
4 kHz	W	15	15	18	18	23	23
8 kHz	W	15	15	20	20	25	25
16 kHz	W	19	19	24	24	30	30
bei Reglersperre	W	6	6	6	6	6	6
Zyklisches Netzschalten		3-mal pro Minute					
Max. Motorleitungslänge geschirmt							
Kategorie C2 (2 kHz, 4 kHz, 8 kHz)	m	15	-	15	-	20	-
Kategorie C3 (2 kHz, 4 kHz, 8 kHz)	m	15	-	15	-	50	-
ohne EMV-Kategorie	m	50	50	50	50	50	50
Gewicht	kg	0.75	0.75	0.75	0.75	0.95	0.95
Gewicht	lb	1.7	1.7	1.7	1.7	2.1	2.1

Technische Daten

1-phasiger Netzanschluss 230/240 V

Bemessungsdaten

Inverter		I51AE175B	I51AE175D	I51AE211B	I51AE211D	I51AE215B	I51AE215D
Bemessungsleistung	kW	0.75	0.75	1.1	1.1	1.5	1.5
Bemessungsleistung	hp	1	1	1.5	1.5	2	2
Netzspannungsbereich		1/PE AC 170 V ... 264 V, 45 Hz ... 65 Hz					
Ausgangsspannung		3 AC 0-230/240 V					
Netz Bemessungsstrom							
ohne Netzdrossel	A	10	10	14.3	14.3	16.7	16.7
mit Netzdrossel	A	8.8	8.8	11.9	11.9	13.9	13.9
Ausgangsscheinleistung	kVA	1.6	1.6	2.2	2.2	2.6	2.6
Ausgangs Bemessungsstrom							
2 kHz	A	4.2	4.2	6	6	7	7
4 kHz	A	4.2	4.2	6	6	7	7
8 kHz	A	4.2	4.2	6	6	7	7
16 kHz	A	2.8	2.8	4	4	4.7	4.7
Verlustleistung							
2 kHz	W	27	27	36	36	41	41
4 kHz	W	29	29	37	37	43	43
8 kHz	W	33	33	42	42	50	50
16 kHz	W	38	38	51	51	59	59
bei Reglersperre	W	6	6	6	6	6	6
Zyklisches Netzschalten		3-mal pro Minute					
Max. Motorleitungslänge geschirmt							
Kategorie C2 (2 kHz, 4 kHz, 8 kHz)	m	20	-	20	-	20	-
Kategorie C3 (2 kHz, 4 kHz, 8 kHz)	m	50	-	35	-	35	-
ohne EMV-Kategorie	m	50	50	50	50	50	50
Gewicht	kg	0.95	0.95	1.35	1.35	1.35	1.35
Gewicht	lb	2.1	2.1	3	3	3	3

Inverter		I51AE222B		I51AE222D	
Bemessungsleistung	kW	2.2		2.2	
Bemessungsleistung	hp	3		3	
Netzspannungsbereich		1/PE AC 170 V ... 264 V, 45 Hz ... 65 Hz			
Ausgangsspannung		3 AC 0-230/240 V			
Netz Bemessungsstrom					
ohne Netzdrossel	A	22.5		22.5	
mit Netzdrossel	A	16.9		16.9	
Ausgangsscheinleistung	kVA	3.6		3.6	
Ausgangs Bemessungsstrom					
2 kHz	A	9.6		9.6	
4 kHz	A	9.6		9.6	
8 kHz	A	9.6		9.6	
16 kHz	A	6.4		6.4	
Verlustleistung					
2 kHz	W	54		54	
4 kHz	W	60		60	
8 kHz	W	70		70	
16 kHz	W	78		78	
bei Reglersperre	W	6		6	
Zyklisches Netzschalten		3-mal pro Minute			
Max. Motorleitungslänge geschirmt					
Kategorie C2 (2 kHz, 4 kHz, 8 kHz)	m	20		-	
Kategorie C3 (2 kHz, 4 kHz, 8 kHz)	m	35		-	
ohne EMV-Kategorie	m	50		50	
Gewicht	kg	1.35		1.35	
Gewicht	lb	3		3	

3-phasiger Netzanschluss 230/240 V

Bemessungsdaten

Die Ausgangsströme gelten für diese Einsatzbedingungen:

- Bei Schaltfrequenz 2 kHz oder 4 kHz: Umgebungstemperatur max. 45 °C.
- Bei Schaltfrequenz 8 kHz oder 16 kHz: Umgebungstemperatur max. 40 °C.

Inverter		I51AE125D	I51AE137D	I51AE155D	I51AE175D	I51AE211D	I51AE215D
Bemessungsleistung	kW	0.25	0.37	0.55	0.75	1.1	1.5
Bemessungsleistung	hp	0.33	0.5	0.75	1	1.5	2
Netzspannungsbereich		3/PE AC 170 V ... 264 V, 45 Hz ... 65 Hz					
Ausgangsspannung		3 AC 0-230/240 V					
Netzbemessungsstrom							
ohne Netzdrossel	A	2.6	3.9	4.8	6.4	7.8	9.5
mit Netzdrossel	A	2	3	3.8	5.1	5.6	6.8
Ausgangsscheinleistung	kVA	0.6	0.9	1.2	1.6	2.2	2.6
Ausgangsbemessungsstrom							
2 kHz	A	-	-	3.2	4.2	6	7
4 kHz	A	1.7	2.4	3.2	4.2	6	7
8 kHz	A	1.7	2.4	3.2	4.2	6	7
16 kHz	A	1.1	1.6	2.1	2.8	4	4.7
Verlustleistung							
2 kHz	W	-	-	22	27	36	41
4 kHz	W	15	18	23	29	37	43
8 kHz	W	15	20	25	33	42	50
16 kHz	W	19	24	30	38	51	59
bei Reglersperre	W	6	6	6	6	6	6
Zyklisches Netzschalten		3-mal pro Minute					
Max. Motorleitungslänge geschirmt							
Kategorie C2 (2 kHz, 4 kHz, 8 kHz)	m	-	-	-	-	-	-
Kategorie C3 (2 kHz, 4 kHz, 8 kHz)	m	-	-	-	-	-	-
ohne EMV-Kategorie	m	50	50	50	50	50	50
Gewicht	kg	0.75	0.75	0.95	0.95	1.35	1.35
Gewicht	lb	1.7	1.7	2.1	2.1	3	3

Technische Daten

3-phasier Netzanschluss 230/240 V

Bemessungsdaten

Inverter		I51AE222D	I51AE240C	I51AE255C
Bemessungsleistung	kW	2.2	4	5.5
Bemessungsleistung	hp	3	5	7.5
Netzspannungsbereich		3/PE AC 170 V ... 264 V, 45 Hz ... 65 Hz		
Ausgangsspannung		3 AC 0-230/240 V		
Netz Bemessungsstrom				
ohne Netzdrossel	A	13.6	20.6	28.8
mit Netzdrossel	A	9.8	15.7	21.9
Ausgangsscheinleistung	kVA	3.6	6.4	8.7
Ausgangsbemessungsstrom				
2 kHz	A	9.6	16.5	23
4 kHz	A	9.6	16.5	23
8 kHz	A	9.6	16.5	23
16 kHz	A	6.4	11	15.3
Verlustleistung				
2 kHz	W	54	113	166
4 kHz	W	60	115	175
8 kHz	W	70	130	195
16 kHz	W	78	116	159
bei Reglersperre	W	6	6	6
Zyklisches Netzschalten		3-mal pro Minute		
Max. Motorleitungslänge geschirmt				
Kategorie C2 (2 kHz, 4 kHz, 8 kHz)	m	-	-	-
Kategorie C3 (2 kHz, 4 kHz, 8 kHz)	m	-	-	-
ohne EMV-Kategorie	m	50	50	50
Gewicht	kg	1.35	2.1	2.1
Gewicht	lb	3	4.6	4.6

3-phasiger Netzanschluss 230/240 V "Light Duty"

Bemessungsdaten

Die Ausgangsströme gelten für diese Einsatzbedingungen:

- Bei Schaltfrequenz 2 kHz oder 4 kHz: Umgebungstemperatur über 40 °C mit 2.5 %/°C reduziertem Ausgangsbemessungsstrom.
- Bei gewählter Lastcharakteristik "Light Duty" und Auswahl der Schaltfrequenzen 8 kHz oder 16 kHz werden nur die Werte der Lastcharakteristik "Heavy Duty" erreicht.

Inverter		I51AE240C	I51AE255C
Bemessungsleistung	kW	5.5	7.5
Bemessungsleistung	hp	7.5	10
Netzspannungsbereich		3/PE AC 170 V ... 264 V, 45 Hz ... 65 Hz	
Ausgangsspannung		3 AC 0-230/240 V	
Netz Bemessungsstrom			
ohne Netzdrossel	A	25.8	-
mit Netzdrossel	A	18.9	24.2
Ausgangsscheinleistung	kVA	8	10.5
Ausgangsbemessungsstrom			
2 kHz	A	20.6	27.6
4 kHz	A	20.6	27.6
8 kHz	A	-	-
16 kHz	A	-	-
Verlustleistung			
2 kHz	W	124	190
4 kHz	W	131	200
8 kHz	W	-	-
16 kHz	W	-	-
bei Reglersperre	W	6	6
Zyklisches Netzschalten		3-mal pro Minute	
Max. Motorleitungslänge geschirmt			
Kategorie C2 (2 kHz, 4 kHz, 8 kHz)	m	-	-
Kategorie C3 (2 kHz, 4 kHz, 8 kHz)	m	-	-
ohne EMV-Kategorie	m	50	50
Gewicht	kg	2.1	2.1
Gewicht	lb	4.6	4.6

3-phasier Netzanschluss 400 V

Bemessungsdaten

Die Ausgangsströme gelten für diese Einsatzbedingungen:

- Bei Schaltfrequenz 2 kHz oder 4 kHz: Umgebungstemperatur max. 45 °C.
- Bei Schaltfrequenz 8 kHz oder 16 kHz: Umgebungstemperatur max. 40 °C.

Inverter		I51AE137F	I51AE155F	I51AE175F	I51AE211F	I51AE215F	I51AE222F
Bemessungsleistung	kW	0.37	0.55	0.75	1.1	1.5	2.2
Bemessungsleistung	hp	0.5	0.75	1	1.5	2	3
Netzspannungsbereich		3/PE AC 340 V ... 528 V, 45 Hz ... 65 Hz					
Ausgangsspannung		3 AC 0-400/480 V					
Netz Bemessungsstrom							
ohne Netzdrossel	A	1.8	2.5	3.3	4.4	5.4	7.8
mit Netzdrossel	A	1.4	2	2.6	3	3.7	5.3
Ausgangsscheinleistung	kVA	0.9	1.2	1.6	2.2	2.6	3.8
Ausgangsbemessungsstrom							
2 kHz	A	-	1.8	2.4	3.2	3.9	5.6
4 kHz	A	1.3	1.8	2.4	3.2	3.9	5.6
8 kHz	A	1.3	1.8	2.4	3.2	3.9	5.6
16 kHz	A	0.9	1.2	1.6	2.1	2.6	3.7
Verlustleistung							
2 kHz	W	-	24	30	38	45	62
4 kHz	W	20	25	32	40	48	66
8 kHz	W	24	31	40	51	61	85
16 kHz	W	24	31	40	51	61	85
bei Reglersperre	W	6	6	6	6	6	6
Zyklisches Netzschalten		3-mal pro Minute					
Max. Motorleitungslänge geschirmt							
Kategorie C2 (2 kHz, 4 kHz, 8 kHz)	m	15	15	15	20	20	20
Kategorie C3 (2 kHz, 4 kHz, 8 kHz)	m	15	20	20	35	35	35
ohne EMV-Kategorie	m	15	50	50	50	50	50
Gewicht	kg	0.75	0.95	0.95	1.35	1.35	1.35
Gewicht	lb	1.7	2.1	2.1	3	3	3

Inverter		I51AE230F	I51BE230F	I51AE240F	I51BE240F	I51AE255F	I51AE275F	I51AE311F
Bemessungsleistung	kW	3	3	4	4	5.5	7.5	11
Bemessungsleistung	hp	4	4	5	5	7.5	10	15
Netzspannungsbereich		3/PE AC 340 V ... 528 V, 45 Hz ... 65 Hz						
Ausgangsspannung		3 AC 0-400/480 V						
Netzbemessungsstrom								
ohne Netzdrossel	A	9.6	9.6	12.5	12.5	17.2	20	28.4
mit Netzdrossel	A	6.9	6.9	9	9	12.4	15.7	22.3
Ausgangsscheinleistung	kVA	4.9	4.9	6.4	6.4	8.7	11	16
Ausgangsbemessungsstrom								
2 kHz	A	7.3	7.3	9.5	9.5	13	16.5	23.5
4 kHz	A	7.3	7.3	9.5	9.5	13	16.5	23.5
8 kHz	A	7.3	7.3	9.5	9.5	13	16.5	23.5
16 kHz	A	4.9	4.9	6.3	6.3	8.7	11	15.7
Verlustleistung								
2 kHz	W	79	79	102	102	137	172	242
4 kHz	W	85	85	110	110	145	185	260
8 kHz	W	110	110	140	140	190	240	340
16 kHz	W	109	109	140	140	189	238	337
bei Reglersperre	W	6	6	6	6	6	6	6
Zyklisches Netzschalten		3-mal pro Minute						
Max. Motorleitungslänge geschirmt								
Kategorie C2 (2 kHz, 4 kHz, 8 kHz)	m	20	20	20	20	20	20	20
Kategorie C3 (2 kHz, 4 kHz, 8 kHz)	m	35	35	35	35	35	50	50
ohne EMV-Kategorie	m	100	50	100	50	100	100	100
Gewicht	kg	2.3	1.35	2.3	1.35	2.3	3.7	3.7
Gewicht	lb	5	3	5	3	5	8	8

Technische Daten

3-phasiger Netzanschluss 400 V "Light Duty"

Bemessungsdaten

3-phasiger Netzanschluss 400 V "Light Duty"

Bemessungsdaten

Die Ausgangsströme gelten für diese Einsatzbedingungen:

- Bei Schaltfrequenz 2 kHz oder 4 kHz: Umgebungstemperatur über 40 °C mit 2.5 %/°C reduziertem Ausgangsbemessungsstrom.
- Bei gewählter Lastcharakteristik "Light Duty" und Auswahl der Schaltfrequenzen 8 kHz oder 16 kHz werden nur die Werte der Lastcharakteristik "Heavy Duty" erreicht.

Inverter		I51AE230F	I51BE230F	I51AE240F	I51BE240F	I51AE255F	I51AE275F	I51AE311F
Bemessungsleistung	kW	4	4	5.5	5.5	7.5	11	15
Bemessungsleistung	hp	5	5	7.5	7.5	10	15	20
Netzspannungsbereich		3/PE AC 340 V ... 528 V, 45 Hz ... 65 Hz						
Ausgangsspannung		3 AC 0-400/480 V						
Netz Bemessungsstrom								
ohne Netzdrossel	A	10.3	10.3	14	14	18.3	28	-
mit Netzdrossel	A	8.2	8.2	11	11	14.5	22	27.1
Ausgangsscheinleistung	kVA	5.9	5.9	8	8	10.5	15	19
Ausgangsbemessungsstrom								
2 kHz	A	8.8	8.8	11.9	11.9	15.6	23	28.2
4 kHz	A	8.8	8.8	11.9	11.9	15.6	23	28.2
8 kHz	A	-	-	-	-	-	-	-
16 kHz	A	-	-	-	-	-	-	-
Verlustleistung								
2 kHz	W	94	94	125	125	163	238	290
4 kHz	W	100	100	133	133	173	253	309
8 kHz	W	-	-	-	-	-	-	-
16 kHz	W	-	-	-	-	-	-	-
bei Reglersperre	W	6	6	6	6	6	6	6
Zyklisches Netzschalten		3-mal pro Minute						
Max. Motorleitungslänge geschirmt								
Kategorie C2 (2 kHz, 4 kHz, 8 kHz)	m	20	20	20	20	20	20	20
Kategorie C3 (2 kHz, 4 kHz, 8 kHz)	m	35	35	35	35	35	50	50
ohne EMV-Kategorie	m	100	50	100	50	100	100	100
Gewicht	kg	2.3	1.35	2.3	1.35	2.3	3.7	3.7
Gewicht	lb	5	3	5	3	5	8	8

3-phasiger Netzanschluss 480 V

Bemessungsdaten

Die Ausgangsströme gelten für diese Einsatzbedingungen:

- Bei Schaltfrequenz 2 kHz oder 4 kHz: Umgebungstemperatur max. 45 °C.
- Bei Schaltfrequenz 8 kHz oder 16 kHz: Umgebungstemperatur max. 40 °C.

Inverter		I51AE137F	I51AE155F	I51AE175F	I51AE211F	I51AE215F	I51AE222F
Bemessungsleistung	kW	0.37	0.55	0.75	1.1	1.5	2.2
Bemessungsleistung	hp	0.5	0.75	1	1.5	2	3
Netzspannungsbereich		3/PE AC 340 V ... 528 V, 45 Hz ... 65 Hz					
Ausgangsspannung		3 AC 0-400/480 V					
Netz Bemessungsstrom							
ohne Netzdrossel	A	1.5	2.1	2.8	3.7	4.5	6.5
mit Netzdrossel	A	1.2	1.7	2.2	2.5	3.1	4.4
Ausgangsscheinleistung	kVA	0.9	1.2	1.6	2.2	2.6	3.8
Ausgangsbemessungsstrom							
2 kHz	A	-	1.6	2.1	3	3.5	4.8
4 kHz	A	1.1	1.6	2.1	3	3.5	4.8
8 kHz	A	1.1	1.6	2.1	3	3.5	4.8
16 kHz	A	0.7	1.1	1.4	2	2.3	3.2
Verlustleistung							
2 kHz	W	-	24	30	38	45	62
4 kHz	W	20	25	32	40	48	66
8 kHz	W	24	31	40	51	61	85
16 kHz	W	24	31	40	51	61	85
bei Reglersperre	W	6	6	6	6	6	6
Zyklisches Netzschalten		3-mal pro Minute					
Max. Motorleitungslänge geschirmt							
Kategorie C2 (2 kHz, 4 kHz, 8 kHz)	m	15	15	15	20	20	20
Kategorie C3 (2 kHz, 4 kHz, 8 kHz)	m	15	20	20	35	35	35
ohne EMV-Kategorie	m	15	50	50	50	50	50
Gewicht	kg	0.75	0.95	0.95	1.35	1.35	1.35
Gewicht	lb	1.7	2.1	2.1	3	3	3

Technische Daten
 3-phasiger Netzanschluss 480 V
 Bemessungsdaten

Inverter		I51AE230F	I51BE230F	I51AE240F	I51BE240F	I51AE255F	I51AE275F	I51AE311F
Bemessungsleistung	kW	3	3	4	4	5.5	7.5	11
Bemessungsleistung	hp	4	4	5	5	7.5	10	15
Netzspannungsbereich		3/PE AC 340 V ... 528 V, 45 Hz ... 65 Hz						
Ausgangsspannung		3 AC 0-400/480 V						
Netz Bemessungsstrom								
ohne Netzdrossel	A	8	8	10.5	10.5	14.3	16.6	23.7
mit Netzdrossel	A	5.8	5.8	7.5	7.5	10.3	13.1	18.6
Ausgangsscheinleistung	kVA	4.9	4.9	6.4	6.4	8.7	11	16
Ausgangs Bemessungsstrom								
2 kHz	A	6.3	6.3	8.2	8.2	11	14	21
4 kHz	A	6.3	6.3	8.2	8.2	11	14	21
8 kHz	A	6.3	6.3	8.2	8.2	11	14	21
16 kHz	A	4.2	4.2	5.5	5.5	7.3	9.3	14
Verlustleistung								
2 kHz	W	79	79	102	102	137	172	242
4 kHz	W	85	85	110	110	145	185	260
8 kHz	W	110	110	140	140	190	240	340
16 kHz	W	109	109	140	140	189	238	337
bei Reglersperre	W	6	6	6	6	6	6	6
Zyklisches Netzschalten		3-mal pro Minute						
Max. Motorleitungslänge geschirmt								
Kategorie C2 (2 kHz, 4 kHz, 8 kHz)	m	20	20	20	20	20	20	20
Kategorie C3 (2 kHz, 4 kHz, 8 kHz)	m	35	35	35	35	35	50	50
ohne EMV-Kategorie	m	100	50	100	50	100	100	100
Gewicht	kg	2.3	1.35	2.3	1.35	2.3	3.7	3.7
Gewicht	lb	5	3	5	3	5	8	8

3-phasiger Netzanschluss 480 V "Light Duty"

Bemessungsdaten

Die Ausgangsströme gelten für diese Einsatzbedingungen:

- Bei Schaltfrequenz 2 kHz oder 4 kHz: Umgebungstemperatur über 40 °C mit 2.5 %/°C reduziertem Ausgangsbemessungsstrom.
- Bei gewählter Lastcharakteristik "Light Duty" und Auswahl der Schaltfrequenzen 8 kHz oder 16 kHz werden nur die Werte der Lastcharakteristik "Heavy Duty" erreicht.

Inverter		I51AE230F	I51BE230F	I51AE240F	I51BE240F	I51AE255F	I51AE275F	I51AE311F
Bemessungsleistung	kW	4	4	5.5	5.5	7.5	11	15
Bemessungsleistung	hp	5	5	7.5	7.5	10	15	20
Netzspannungsbereich		3/PE AC 340 V ... 528 V, 45 Hz ... 65 Hz						
Ausgangsspannung		3 AC 0-400/480 V						
Netz Bemessungsstrom								
ohne Netzdrossel	A	8.6	8.6	11.2	11.2	15.3	22	-
mit Netzdrossel	A	6.8	6.8	8.8	8.8	12.1	17.2	22.6
Ausgangsscheinleistung	kVA	5.9	5.9	8	8	10.5	15	19
Ausgangsbemessungsstrom								
2 kHz	A	7.6	7.6	9.8	9.8	13.2	18.3	25.2
4 kHz	A	7.6	7.6	9.8	9.8	13.2	18.3	25.2
8 kHz	A	-	-	-	-	-	-	-
16 kHz	A	-	-	-	-	-	-	-
Verlustleistung								
2 kHz	W	94	94	125	125	163	238	290
4 kHz	W	100	100	133	133	173	253	309
8 kHz	W	-	-	-	-	-	-	-
16 kHz	W	-	-	-	-	-	-	-
bei Reglersperre	W	6	6	6	6	6	6	6
Zyklisches Netzschalten		3-mal pro Minute						
Max. Motorleitungslänge geschirmt								
Kategorie C2 (2 kHz, 4 kHz, 8 kHz)	m	20	20	20	20	20	20	20
Kategorie C3 (2 kHz, 4 kHz, 8 kHz)	m	35	35	35	35	35	50	50
ohne EMV-Kategorie	m	100	50	100	50	100	100	100
Gewicht	kg	2.3	1.35	2.3	1.35	2.3	3.7	3.7
Gewicht	lb	5	3	5	3	5	8	8

Contents

About this document	70
Document description.....	70
Further documents.....	70
Notations and conventions.....	71
Safety instructions	72
Basic safety instructions.....	72
Application as directed.....	73
Handling.....	73
Residual hazards.....	74
Product information	75
Identification of the products.....	75
Features.....	76
Mechanical installation	80
Important notes.....	80
Preparation.....	81
Dimensions.....	83

Electrical installation	95
Important notes.....	95
Connection according to UL.....	96
Mains connection	100
1-phase mains connection 230/240 V	100
Connection diagrams	100
Terminal data	102
Fusing data	102
3-phase mains connection 230/240 V	103
Connection diagrams	103
Terminal data	105
Fusing data	105
3-phase mains connection 230/240 V "Light Duty"	105
Connection diagrams	105
Terminal data	105
Fusing data	105
3-phase mains connection 400 V.....	106
Connection diagrams	106
Terminal data	107
Fusing data	107
3-phase mains connection 400 V "Light Duty".....	108
Connection diagrams	108
Terminal data	108
Fusing data	108
3-phase mains connection 480 V.....	109
Connection diagrams	109
Terminal data	109
Fusing data	110
3-phase mains connection 480 V "Light Duty".....	110
Connection diagrams	110
Terminal data	110
Fusing data	110
Connection to the IT system	111
Control connections	112
Networks	113
CANopen/Modbus.....	113
BACnet.....	114
Commissioning	115
Important notes.....	115
Initial switch-on and functional test	116

Technical data	118
Standards and operating conditions	118
Conformities/approvals	118
Protection of persons and device protection	118
EMC data	118
Motor connection	119
Environmental conditions	119
Electrical supply conditions	119
1-phase mains connection 230/240 V	120
Rated data	120
3-phase mains connection 230/240 V	122
Rated data	122
3-phase mains connection 230/240 V "Light Duty"	124
Rated data	124
3-phase mains connection 400 V	125
Rated data	125
3-phase mains connection 400 V "Light Duty"	127
Rated data	127
3-phase mains connection 480 V	128
Rated data	128
3-phase mains connection 480 V "Light Duty"	130
Rated data	130

About this document

Document description

Further documents

About this document



Read this documentation carefully before starting any work.

► Please observe the safety instructions!

Document description

Further documents

For certain tasks, information is available in other forms.





Form	Contents/topics
Engineering Tools	For commissioning
AKB articles	Application Knowledge Base with additional technical information for users
CAD data	Exports in different formats
EPLAN macros	Project planning, documentation and management of projects for P8. <ul style="list-style-type: none">• Data reference via Lenze or EPLAN data portal



Information and tools with regard to the Lenze products can be found on the Internet:
<http://www.lenze.com> → Downloads

Notations and conventions

This document uses the following conventions to distinguish different types of information:

Numeric notation			
	Decimal separator	Point	The decimal point is always used. Example: 1 234.56
Warning			
	UL warning	UL	Are used in English and French.
	UR warning	UR	
Text			
	Engineering tools	» «	Software Example: »Engineer«, »EASY Starter«
Icons			
	Page reference		Reference to another page with additional information Example:  16 = see page 16
	Documentation reference		Reference to another documentation with additional information Example:  EDKxxx = see documentation EDKxxx

Layout of the safety instructions

DANGER!

Indicates an extremely hazardous situation. Failure to comply with this instruction will result in severe irreparable injury and even death.

WARNING!

Indicates an extremely hazardous situation. Failure to comply with this instruction may result in severe irreparable injury and even death.

CAUTION!

Indicates a hazardous situation. Failure to comply with this instruction may result in slight to medium injury.

NOTICE

Indicates a material hazard. Failure to comply with this instruction may result in material damage.

Safety instructions

Disregarding the following basic safety measures and safety information may lead to severe personal injury and damage to property!

Observe all specifications of the corresponding documentation supplied. This is the precondition for safe and trouble-free operation and for obtaining the product features specified.

Please observe the specific safety information in the other sections!

DANGER!

Electrical voltage

Possible consequences: Death or severe injuries

- ▶ Any work on the inverter must only be carried out in the deenergised state.
 - ▶ Inverter up to 45 kW: After switching off the mains voltage, wait for at least 3 min before you start working.
 - ▶ Inverter from 55 kW onwards: After switching off the mains voltage, wait for at least 10 min before you start working.
-

Basic safety instructions

DANGER!

Dangerous electrical voltage

Death or severe injuries from electric shock.

- ▶ Any work on the inverter must only be carried out in a deenergized state.
 - ▶ After switching off the mains voltage, observe the signs on the product.
-

Personnel

The product must only be used by qualified personnel. IEC 60364 or CENELEC HD 384 define the skills of these persons:

- They are familiar with installing, mounting, commissioning, and operating the product.
- They have the corresponding qualifications for their work.
- They know and can apply all regulations for the prevention of accidents, directives, and laws applicable at the place of use.

Process engineering

The procedural notes and circuit details described are only proposals. It is up to the user to check whether they can be adapted to the particular applications. Lenze does not take any responsibility for the suitability of the procedures and circuit proposals described.

Device protection

- The maximum test voltage for insulation tests between a control potential of 24 V and PE must not exceed 110 V DC (EN 61800-5-1).

Application as directed

- The product must only be operated under the operating conditions prescribed in this documentation.
- The product meets the protection requirements of 2014/35/EU: Low-Voltage Directive.
- The product is not a machine in terms of 2006/42/EU: Machinery Directive.
- Commissioning or starting the operation as directed of a machine with the product is not permitted until it has been ensured that the machine meets the regulations of the EU Directive 2006/42/EU: Machinery Directive; observe EN 60204-1.
- Commissioning or starting operation as directed is only permissible if the EMC Directive 2014/30/EU is complied with.
- The harmonised standard EN 61800-5-1 is applied.
- The product is not a household appliance, but is only designed as a component for commercial or professional use in terms of EN 61000-3-2.
- The product can be used according to the technical data if drive systems have to comply with categories according to EN 61800-3.
In residential areas, the product may cause EMC interferences. The operator is responsible for taking interference suppression measures.
- The product must only be actuated with motors that are suitable for the operation with inverters.
 - Lenze L-force motors meet the requirements
 - Exception: m240 motors are designed for mains operation only.

Handling

- Never commission the product in the event of visible damage.
- The product must never be technically modified.
- Never commission the product before assembly has been completed.
- The product must never be operated without required covers.
- Establish, separate and change all electrical connections only in deenergised state!

Safety instructions

Residual hazards

Residual hazards





Even if notes given are taken into consideration and protective measures are implemented, the occurrence of residual risks cannot be fully prevented.

The user must take the residual hazards mentioned into consideration in the risk assessment for his/her machine/system.

If the above is disregarded, this can lead to severe injuries to persons and damage to property!

Product

Observe the warning labels on the product!

Icon	Description
	Electrostatic sensitive devices: Before working on the product, the staff must ensure to be free of electrostatic charge!
	Dangerous electrical voltage Before working on the product, make sure there is no voltage applied to the power terminals! After mains disconnection, the power terminals will still carry the hazardous electrical voltage for the time given next to the symbol!
	High leakage current: Carry out fixed installation and PE connection in compliance with EN 61800-5-1 or EN 60204-1!
	Hot surface: Use personal protective equipment or wait until the device has cooled down!

Motor protection

With some settings of the inverter, the connected motor can be overheated.

- E. g. by longer operation of self-ventilated motors at low speed.
- E. g. by longer operation of the DC-injection brake.

Protection of the machine/system

Drives can reach dangerous overspeeds.

- E. g. by setting high output frequencies in connection with motors and machines not suitable for this purpose.
- The inverters do not provide protection against such operating conditions. For this purpose, use additional components.

Switch contactors in the motor cable only if the controller is inhibited.

- Switching while the inverter is enabled is only permissible if no monitoring functions are activated.

Motor

If there is a short circuit of two power transistors, a residual movement of up to 180°/number of pole pairs can occur at the motor! (e. g. 4-pole motor: residual movement max. $180^\circ/2 = 90^\circ$).

Degree of protection - protection of persons and device protection

- Information applies to the mounted and ready-for-use state.
- Information does not apply to the wire range of the terminals.
 - Terminals that are not wired have low protection against physical contact.
 - Terminals for large cable cross-sections have lower classes of protection, e. g. from 15 kW IP10 only.

Product information

Identification of the products

In tables, the first 9 digits of the corresponding product code are used to identify the products:

Product code

Product type	Inverter	I	5	1	A	E	□□□	□	1	0	□	□	□	□□□□
Product family	i500	I	5											
Product	i510			1										
Product generation	Generation 1				A									
	Generation 2				B									
Mounting type	Control cabinet mounting					E								
Rated power (Example)	0.25 kW						125							
	0.55 kW						155							
	2.2 kW						222							
Mains voltage and connection type	1/N/PE AC 230/240 V										B			
	1/N/PE AC 230/240 V													
	2/N/PE AC 230/240 V										D			
	3/PE AC 230/240 V										C			
	3/PE AC 400 V 3/PE AC 480 V										F			
Motor connections	Single axis								1					
Integrated functional safety	Without safety function									0				
Degree of protection	IP20										0			
	IP20, coated										V			
Interference suppression	Without											0		
	Integrated RFI filter											1		
Design types	Global model 50 Hz												0	
	Local model 60 Hz												1	
	Basic-I/O without network													000S
	Basic-I/O with CANopen/Modbus													001S

Example:

Product code	Meaning
I51AE215F10010001S	Inverter i510 Cabinet, 1.5 kW, three-phase, 400 V/480 V IP20, integrated RFI filter, 50-Hz version Basic I/O with CANopen/Modbus network

Features

Example of 0.25 kW ... 4 kW

PE connection

X100 Mains connection/DC bus

X9 Relay output

IT screw from 0.55 kW

X216 Network

Option

X20 Memory module

Network status LEDs

Inverter status LEDs

Shield connection

Option

Toggle switch

CAN open/Modbus

X16 Interface
Diagnostic module

Shielding of control connections

X3 Control terminals

Basic I/O

IT screw

X105 Motor connection

Brake resistor connection

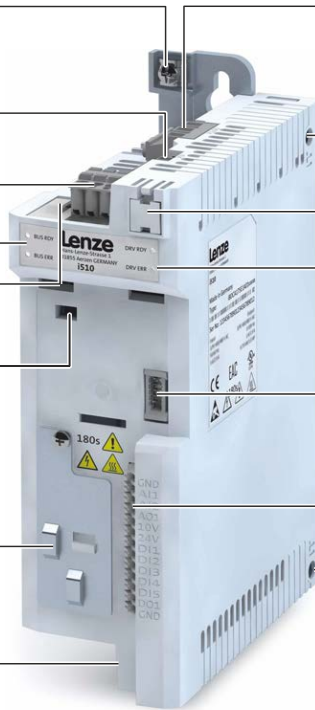

Example of 0.25 kW ... 2.2 kW

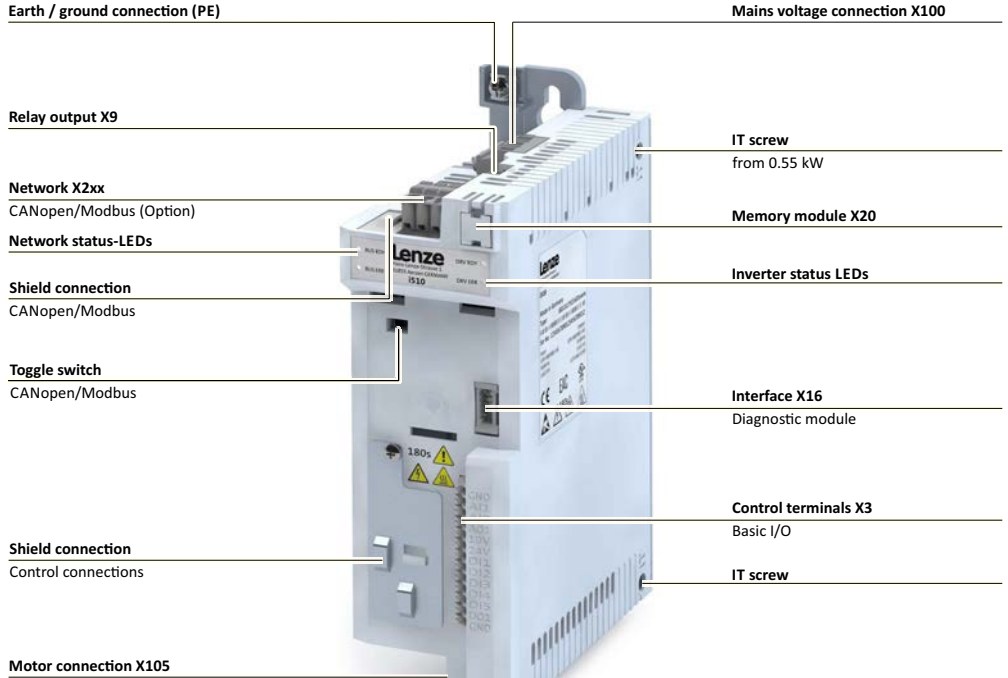

Example of 5.5 kW

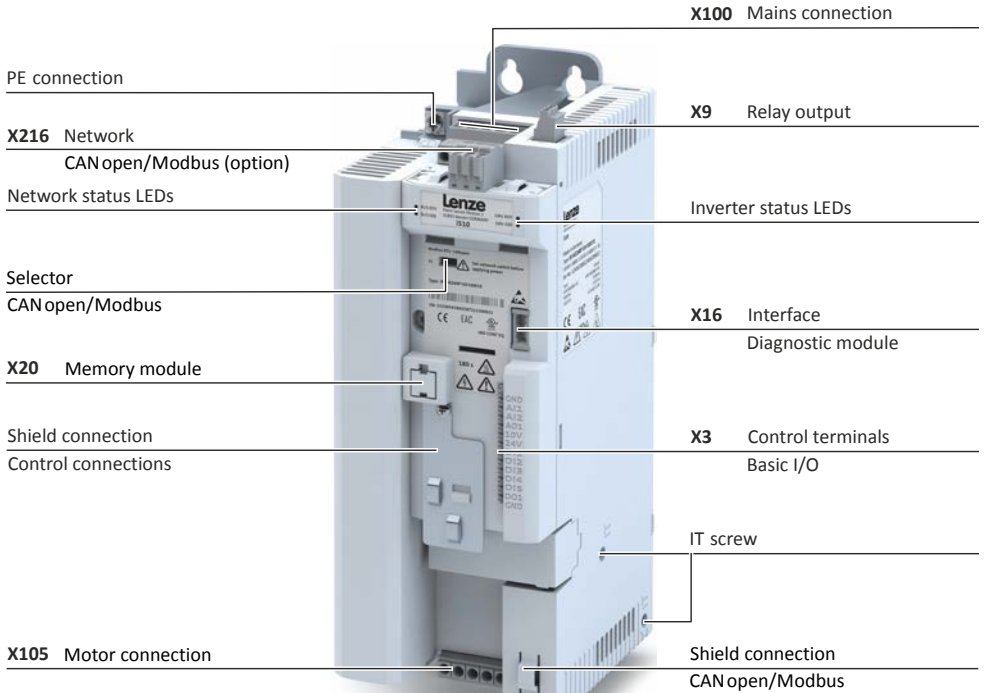

Example of 7.5 kW ... 11 kW

PE connection

X100 Mains connection

Network status LEDs

X9 Relay output

X216 Network
CAN open/Modbus (option)

Selector

Inverter status LEDs

CAN open/Modbus

X16 Interface
Diagnostic module

X20 Memory module

X3 Control terminals
Basic I/O

Shield connection

Control connections

IT screw

X105 Motor connection

Shield connection
CAN open/Modbus

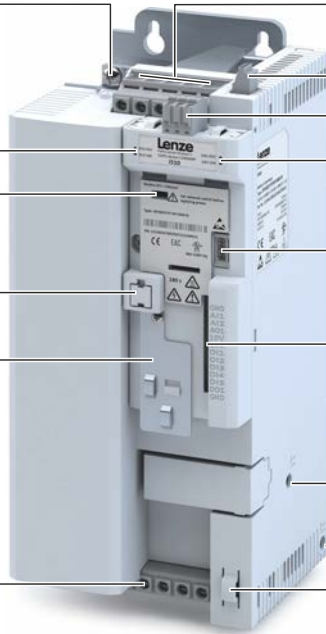

Mechanical installation

Important notes

NOTICE

- ▶ **UL marking**
 - ▶ Modular construction - A complete drive consists of a power unit series no. I5D in combination with a control unit series no. I5C only.
 - ▶ **Marquage UL**
 - ▶ Conception modulaire – Le système d'entraînement complet comprend un module d'alimentation de série I5D, impérativement associé à une unité de commande de série I5C.
-

Preparation

Installation of shield connection sheet for the motor cable 0.25 kW to 4 kW (optional accessories)

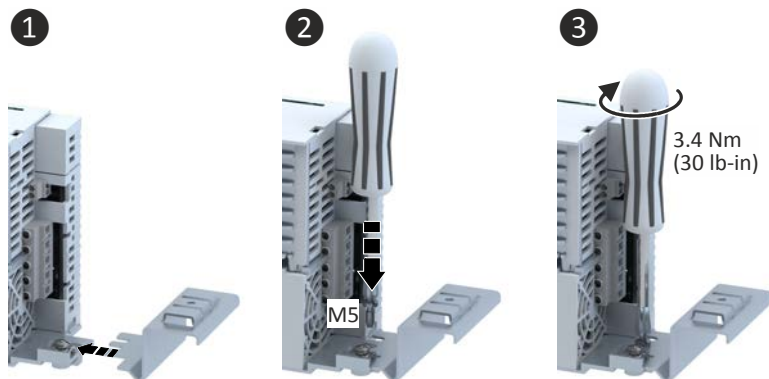

Together with the inverter, the shield connection sheet is screwed onto the mounting plate.

Installation of shield connection sheet for the motor cable 5.5 kW (optional accessories)

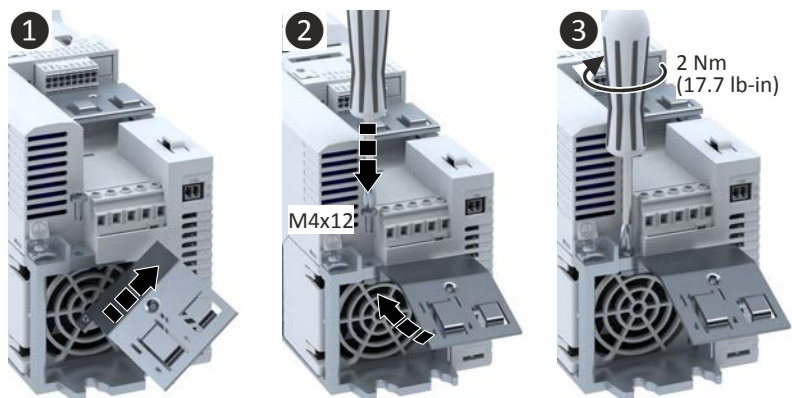

Installation of shield connection sheet for the motor cable 7.5 kW to 11 kW (optional accessories)

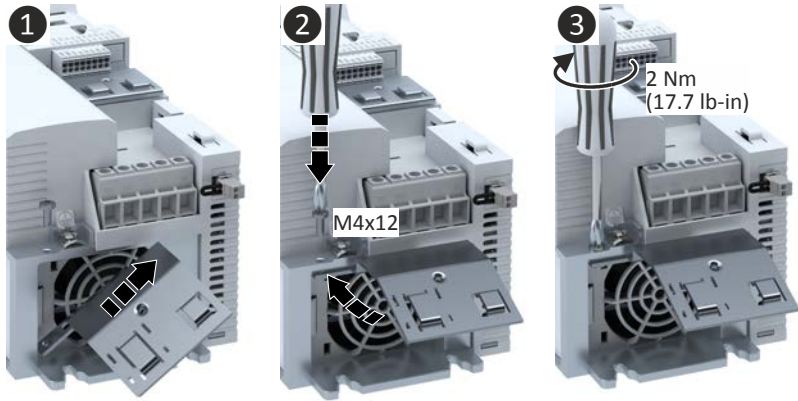

Dimensions

0.25 kW ... 0.37 kW

The dimensions in mm apply to:

0.25 kW	I51AE125B	I51AE125D	
0.37 kW	I51AE137B	I51AE137D	I51AE137F

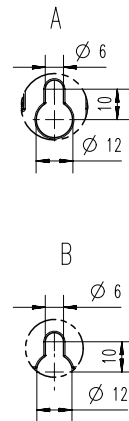
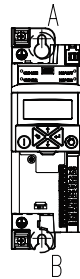
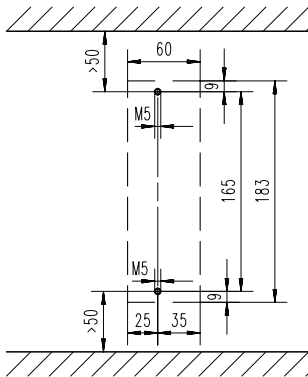
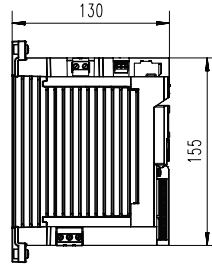
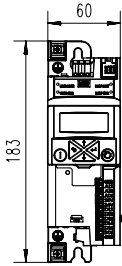

8800270

Mechanical installation

Dimensions

0.33 hp ... 0.5 hp

The dimensions in inch apply to:

0.33 hp	I51AE125B	I51AE125D	
0.5 hp	I51AE137B	I51AE137D	I51AE137F

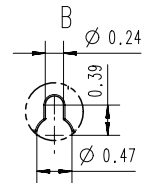
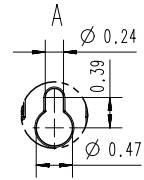
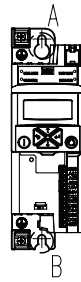
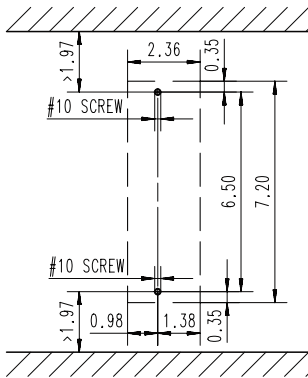
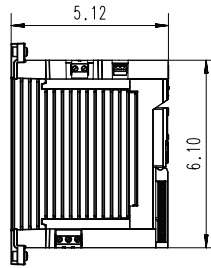
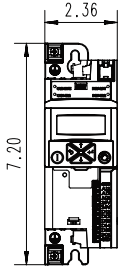

8800305

0.55 kW ... 0.75 kW

The dimensions in mm apply to:

0.55 kW	I51AE155B	I51AE155D	I51AE155F
0.75 kW	I51AE175B	I51AE175D	I51AE175F

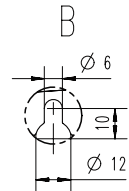
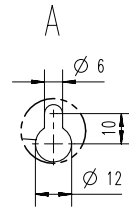
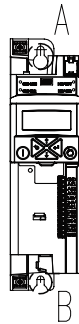
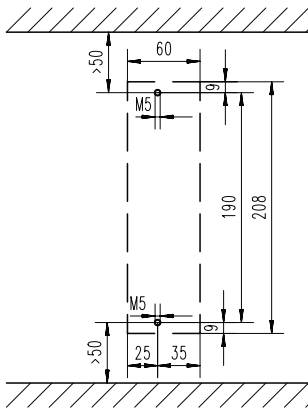
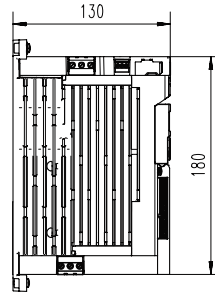
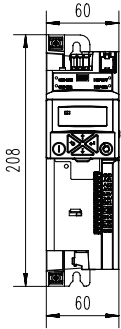

8800271

Mechanical installation

Dimensions

0.75 hp ... 1 hp

The dimensions in inch apply to:

0.75 hp	I51AE155B	I51AE155D	I51AE155F
1 hp	I51AE175B	I51AE175D	I51AE175F

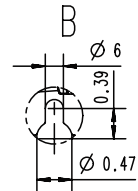
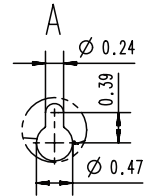
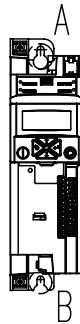
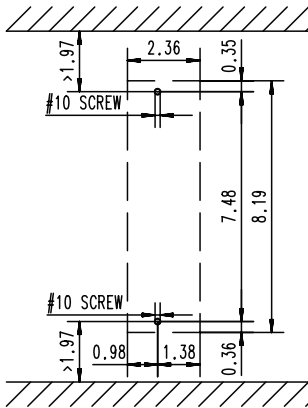
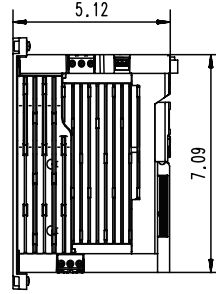
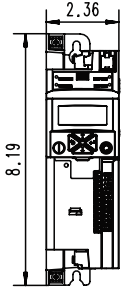

8800306

1.1 kW ... 4 kW

The dimensions in mm apply to:

1.1 kW	I51AE211B	I51AE211D	I51AE211F
1.5 kW	I51AE215B	I51AE215D	I51AE215F
2.2 kW	I51AE222B	I51AE222D	I51AE222F
3 kW			I51BE230F
4 kW			I51BE240F

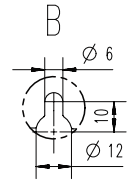
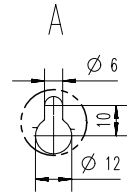
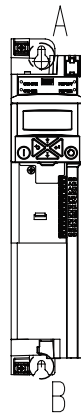
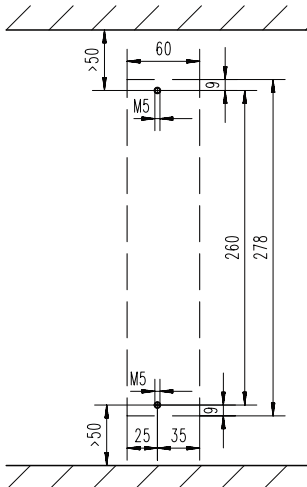
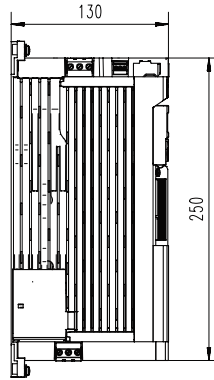
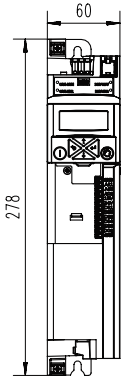

8800272

Mechanical installation

Dimensions

1.5 hp ... 5.5 hp

The dimensions in inch apply to:

1.5 hp	I51AE211B	I51AE211D	I51AE211F
2 hp	I51AE215B	I51AE215D	I51AE215F
3 hp	I51AE222B	I51AE222D	I51AE222F
4 hp			I51BE230F
5.5 hp			I51BE240F

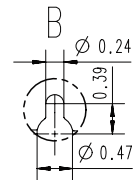
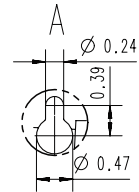
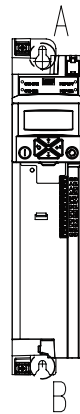
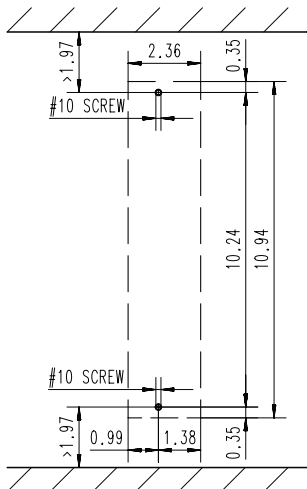
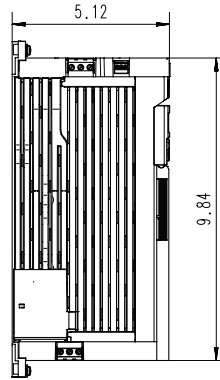
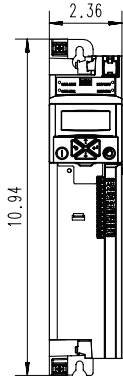

8800307

1.1 kW ... 2.2 kW

The dimensions in mm apply to:

1.1 kW	I51AE211B	I51AE211D	I51AE211F
1.5 kW	I51AE215B	I51AE215D	I51AE215F
2.2 kW	I51AE222B	I51AE222D	I51AE222F

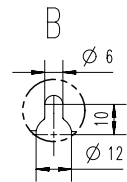
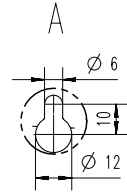
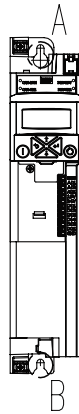
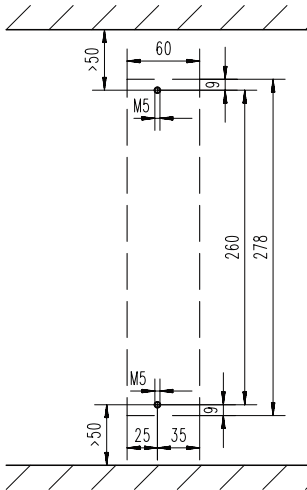
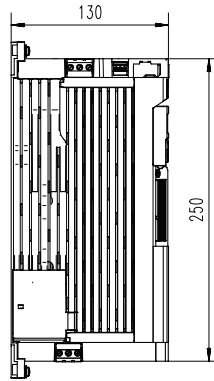
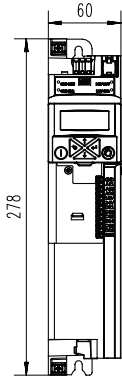

8800272

Mechanical installation

Dimensions

1.5 hp ... 3 hp

The dimensions in inch apply to:

1.5 hp	I51AE211B	I51AE211D	I51AE211F
2 hp	I51AE215B	I51AE215D	I51AE215F
3 hp	I51AE222B	I51AE222D	I51AE222F

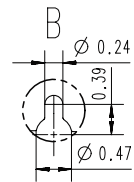
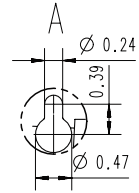
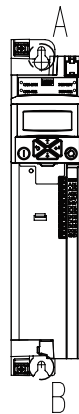
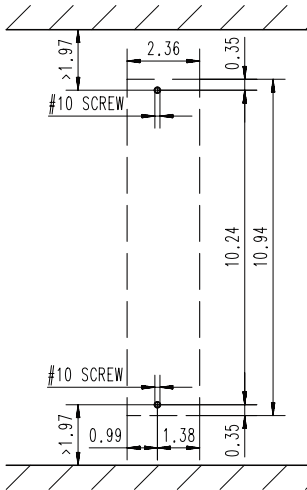
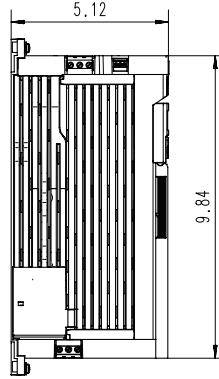
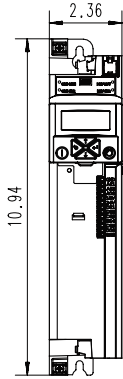

8800307

5.5 kW

The dimensions in mm apply to:

5.5 kW	I51AE255C	I51AE255F
--------	-----------	-----------

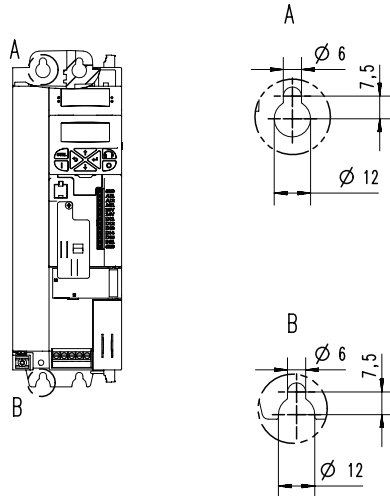
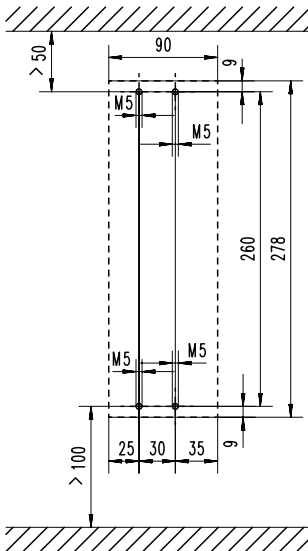
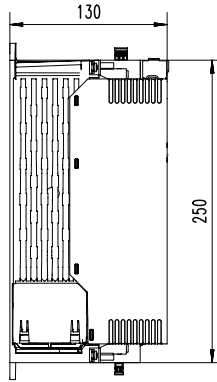
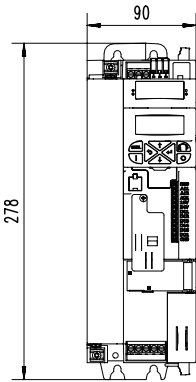

8800599

Mechanical installation

Dimensions

7.5 hp

The dimensions in inch apply to:

7.5 hp	I51AE255C	I51AE255F
--------	-----------	-----------

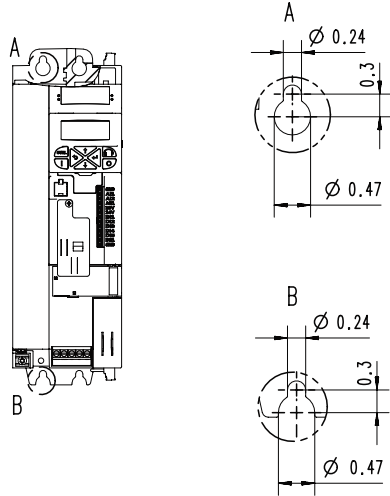
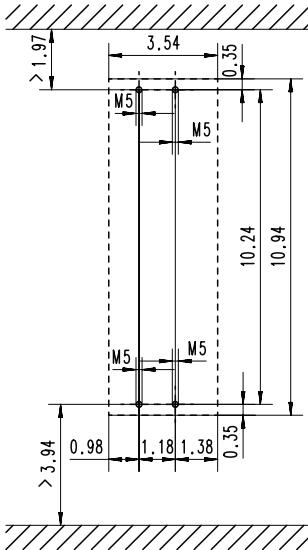
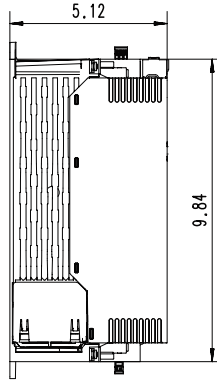
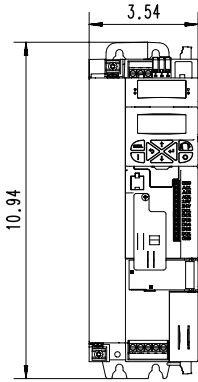

8800601

7.5 kW ... 11 kW

The dimensions in mm apply to:

7.5 kW	I51AE275F
11 kW	I51AE311F

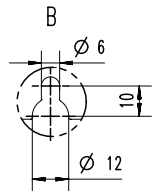
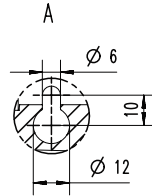
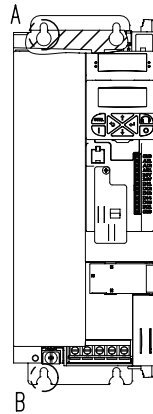
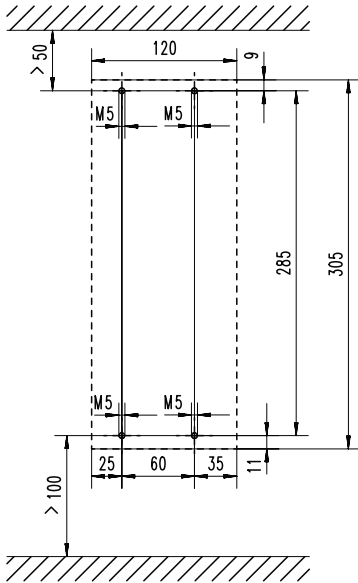
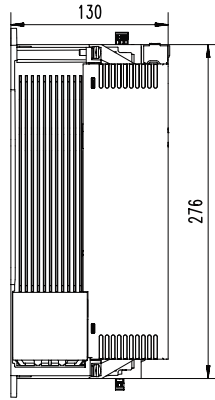
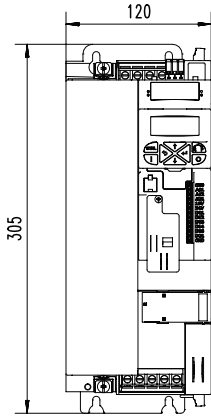

8800600

Mechanical installation

Dimensions

10 hp ... 15 hp

The dimensions in inch apply to:

10 hp	I51AE275F
15 hp	I51AE311F

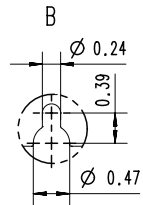
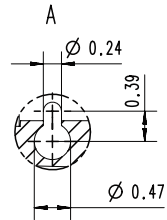
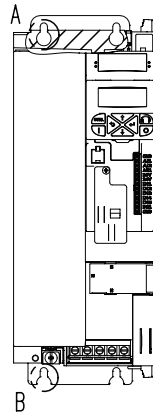
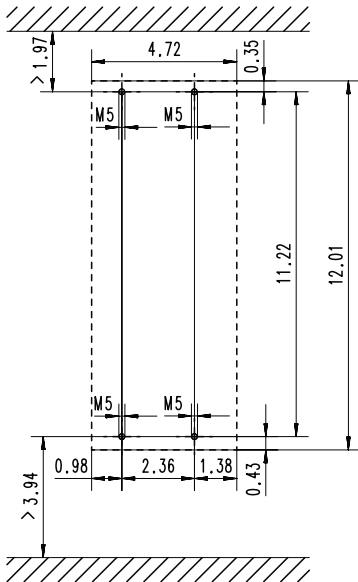
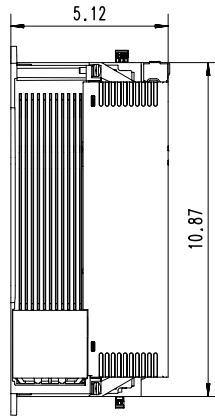
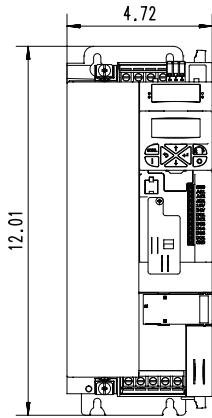

8800602

Electrical installation

Important notes

DANGER!

Electrical voltage

Possible consequences: Death or severe injuries

- ▶ Any work on the inverter must only be carried out in the deenergised state.
 - ▶ Inverter up to 45 kW: After switching off the mains voltage, wait for at least 3 min before you start working.
 - ▶ Inverter from 55 kW onwards: After switching off the mains voltage, wait for at least 10 min before you start working.
-

DANGER!

Dangerous electrical voltage

The leakage current against earth (PE) is > 3.5 mA AC or > 10 mA DC.

Possible consequences: Death or severe injuries when touching the device in the event of an error.

- ▶ Implement the measures requested in EN 61800-5-1 or EN 60204-1. Especially:
 - ▶ Fixed installation
 - ▶ The PE connection must comply with the standards (PE conductor diameter ≥ 10 mm² or use a double PE conductor)
-

Connection according to UL

WARNING!

▶ **UL marking**

- ▶ The integral solid state short circuit protection included in the inverter does not provide branch circuit protection. Branch circuit protection must be provided in accordance with the National Electrical Code / Canadian Electrical Code and any additional local codes.

▶ **Marquage UL**

- ▶ La protection statique intégrée contre les courts-circuits n'offre pas la même protection que le dispositif de protection du circuit de dérivation. Un tel dispositif doit être fourni, conformément au National Electrical Code / Canadian Electrical Code et aux autres dispositions applicables au niveau local.
-

NOTICE

▶ **UL marking**

- ▶ The opening of the Branch Circuit Protective Device may be an indication that a fault has been interrupted. To reduce the risk of fire or electric shock, current-carrying parts and other components of the controller should be examined and replaced if damaged. If burnout of the current element of an overload relay occurs, the complete overload relay must be replaced.

▶ **Marquage UL**

- ▶ Le déclenchement du dispositif de protection du circuit de dérivation peut être dû à une coupure qui résulte d'un courant de défaut. Pour limiter le risque d'incendie ou de choc électrique, examiner les pièces porteuses de courant et les autres éléments du contrôleur et les remplacer s'ils sont endommagés. En cas de grillage de l'élément traversé par le courant dans un relais de surcharge, le relais tout entier doit être remplacé.
-

NOTICE

▶ **UL marking**

- ▶ Internal overload protection rated for 125 % of the rated FLA.

▶ **Marquage UL**

- ▶ Protection contre les surcharges conçue pour se déclencher à 125 % de l'intensité assignée à pleine charge.
-

WARNING!

▶ **UL marking**

- ▶ Use 75°C copper wire only, except for control circuits.

▶ **Marquage UL**

- ▶ Utiliser exclusivement des conducteurs en cuivre 75 °C, sauf pour la partie commande.
-

 **WARNING!**

▶ **UL marking**

- ▶ Suitable for motor group installation or use on a circuit capable of delivering not more than the rms symmetrical amperes (SCCR) of the drive at its rated voltage.
- ▶ Approved fusing is specified in SCCR tables below.

▶ **Marquage UL**

- ▶ Convient pour l'utilisation sur une installation avec un groupe de moteurs ou sur un circuit capable de fournir au maximum une valeur de courant efficace symétrique en ampères à la tension assignée de l'appareil.
 - ▶ Les dispositifs de protection adaptés sont spécifiés dans les SCCR tableaux suivants.
-

Branch Circuit Protection (BCP) with Short Circuit Current Ratings (SCCR) with Standard Fuses. (Tested per UL61800-5-1, reference UL file E132659)

These devices are suitable for motor group installation when used with Standard Fuses. For single motor installation, if the fuse value indicated is higher than 400% of the motor current (FLA), the fuse value has to be calculated. If the value of the fuse is below two standard ratings, the nearest standard ratings less than the calculated value shall apply.

Inverter			Standard Fuses (UL248)		
Mains	kW	hp	SCCR	Max. rated current	Class
120 V, 1-ph	0.25	0.33	5 kA	15 A	CC
120 V, 1-ph	0.37	0.50	5 kA	15 A	CC
120 V, 1-ph	0.75	1.00	5 kA	30 A	CC, J, T
120 V, 1-ph	1.10	1.50	5 kA	30 A	CC, J, T
230 V, 1-ph	0.25	0.33	65 kA	15 A	CC
230 V, 1-ph	0.37	0.50	65 kA	15 A	CC
230 V, 1-ph	0.55	0.75	65 kA	15 A	CC
230 V, 1-ph	0.75	1.00	65 kA	15 A	CC
230 V, 1-ph	1.10	1.50	65 kA	30 A	CC, J, T
230 V, 1-ph	1.50	2.00	65 kA	30 A	CC, J, T
230 V, 1-ph	2.20	3.00	65 kA	30 A	CC, J, T
230 V, 1/3-ph	0.25	0.33	65 kA	15 A	CC
230 V, 1/3-ph	0.37	0.50	65 kA	15 A	CC
230 V, 1/3-ph	0.55	0.75	65 kA	15 A	CC
230 V, 1/3-ph	0.75	1.00	65 kA	15 A	CC
230 V, 1/3-ph	1.10	1.50	65 kA	30 A	CC, J, T
230 V, 1/3-ph	1.50	2.00	65 kA	30 A	CC, J, T
230 V, 1/3-ph	2.20	3.00	65 kA	30 A	CC, J, T
230 V, 3-ph	4.00	5.00	100 kA	40 A	J, T
230 V, 3-ph	5.50	7.50	100 kA	40 A	J, T
480 V, 3-ph	0.37	0.50	65 kA	15 A	CC
480 V, 3-ph	0.55	0.75	65 kA	15 A	CC
480 V, 3-ph	0.75	1.00	65 kA	15 A	CC
480 V, 3-ph	1.1	1.5	65 kA	15 A	CC
480 V, 3-ph	1.5	2.0	65 kA	15 A	CC
480 V, 3-ph	2.2	3.0	65 kA	15 A	CC
480 V, 3-ph	3.0	4.0	65 kA	25 A	CC, J, T
480 V, 3-ph	4.0	5.0	65 kA	25 A	CC, J, T
480 V, 3-ph	5.5	7.5	65 kA	25 A	CC, J, T
480 V, 3-ph	7.5	10.0	65 kA	40 A	J, T
480 V, 3-ph	11.0	15.0	65 kA	40 A	J, T
480 V, 3-ph	15.0	20.0	100 kA	70 A	J, T
480 V, 3-ph	18.5	25.0	100 kA	70 A	J, T
480 V, 3-ph	22	30	100 kA	70 A	J, T
480 V, 3-ph *	30	40	22 kA	125 A	J, T
480 V, 3-ph *	37	50	22 kA	125 A	J, T
480 V, 3-ph *	45	60	22 kA	125 A	J, T
480 V, 3-ph *	55	75	22 kA	200 A	J, T
480 V, 3-ph *	75	100	22 kA	200 A	J, T
480 V, 3-ph *	90	125	22 kA	300 A	J, T
480 V, 3-ph *	110	150	22 kA	300 A	J, T

* Mains choke required

Branch Circuit Protection (BCP) with Short Circuit Current Rating (SCCR) for Semiconductor Fuses and Circuit Breaker. (Tested per UL161800-5-1, reference UL file E132659)

These devices are suitable for motor group installation when used with Circuit Breakers. For single motor installation, if the fuse value indicated is higher than 400% of the motor current (FLA), the fuse value has to be calculated. If the value of the fuse is below two standard ratings, the nearest standard ratings less than the calculated value shall apply.

Inverter			Alternate Fuse (Semiconductor Fuse)		Circuit Breaker (UL489)		
Mains	kW	hp	SCCR	Fuse type	SCCR	Max. rated current	Min. cabinet dimensions
120 V, 1-ph	0.25	0.33			5 kA	15 A	n/a
120 V, 1-ph	0.37	0.50			5 kA	15 A	
120 V, 1-ph	0.75	1.00		n/a	5 kA	30 A	
120 V, 1-ph	1.10	1.50			5 kA	30 A	
230 V, 1-ph	0.25	0.33	100 kA	Mersen A60Q15-2	65 kA	15 A	0.042 m ³ 1.48 ft ³
230 V, 1-ph	0.37	0.50	100 kA	Mersen A60Q15-2	65 kA	15 A	
230 V, 1-ph	0.55	0.75	100 kA	Mersen A70QS40-14F	65 kA	15 A	
230 V, 1-ph	0.75	1.00	100 kA	Mersen A70QS40-14F	65 kA	15 A	
230 V, 1-ph	1.10	1.50	100 kA	Mersen A70QS40-14F	65 kA	30 A	
230 V, 1-ph	1.50	2.00	100 kA	Mersen A70QS40-14F	65 kA	30 A	
230 V, 1-ph	2.20	3.00	100 kA	Mersen A70QS40-14F	65 kA	30 A	
230 V, 1/3-ph	0.25	0.33	100 kA	Mersen A60Q15-2	65 kA	15 A	0.042 m ³ 1.48 ft ³
230 V, 1/3-ph	0.37	0.50	100 kA	Mersen A60Q15-2	65 kA	15 A	
230 V, 1/3-ph	0.55	0.75	100 kA	Mersen A70QS40-14F	65 kA	15 A	
230 V, 1/3-ph	0.75	1.00	100 kA	Mersen A70QS40-14F	65 kA	15 A	
230 V, 1/3-ph	1.10	1.50	100 kA	Mersen A70QS40-14F	65 kA	30 A	
230 V, 1/3-ph	1.50	2.00	100 kA	Mersen A70QS40-14F	65 kA	30 A	
230 V, 1/3-ph	2.20	3.00	100 kA	Mersen A70QS40-14F	65 kA	30 A	
230 V, 3-ph	4.00	5.00	100 kA	Mersen A70QS50-22F	65 kA	40 A	0.042 m ³
230 V, 3-ph	5.50	7.50	100 kA	Mersen A70QS50-22F	65 kA	40 A	1.48 ft ³
480 V, 3-ph	0.37	0.50	100 kA	Mersen A70QS6-14F	65 kA	15 A	0.042 m ³ 1.48 ft ³
480 V, 3-ph	0.55	0.75	100 kA	Mersen A60Q15-2	65 kA	15 A	
480 V, 3-ph	0.75	1.00	100 kA	Mersen A60Q15-2	65 kA	15 A	
480 V, 3-ph	1.1	1.5	100 kA	Mersen A60Q15-2	65 kA	15 A	
480 V, 3-ph	1.5	2.0	100 kA	Mersen A60Q15-2	65 kA	15 A	
480 V, 3-ph	2.2	3.0	100 kA	Mersen A60Q15-2	65 kA	15 A	
480 V, 3-ph	3.0	4.0		Mersen A70QS40-14F Mersen A70QS40-22F Mersen A70QS40-4			
480 V, 3-ph	4.0	5.0	100 kA	Eaton/Bussmann FWP-50A14Fa Eaton/Bussmann FWP-50A22F Eaton/Bussmann FWP-50B Littlefuse L70QS050	65 kA	25 A	
480 V, 3-ph	5.5	7.5	100 kA	Mersen A70QS40-14F	65 kA	25 A	0.042 m ³ 1.48 ft ³
480 V, 3-ph	7.5	10.0	100 kA	Mersen A70QS50-22F	65 kA	40 A	
480 V, 3-ph	11.0	15.0	100 kA	Mersen A70QS50-22F	65 kA	40 A	
480 V, 3-ph	15.0	20.0	100 kA	Mersen A70QS80-22F	65 kA	60 A	0.17 m ³ 6 ft ³
480 V, 3-ph	18.5	25.0	100 kA	Mersen A70QS80-22F	65 kA	60 A	
480 V, 3-ph	22	30	100 kA	Mersen A70QS80-22F	65 kA	60 A	
480 V, 3-ph *	30	40	100 kA	Mersen A70QS80-4	35 kA	125 A	0.57 m ³ 20 ft ³
480 V, 3-ph *	37	50	100 kA	Mersen A70QS100-4	35 kA	125 A	
480 V, 3-ph *	45	60	100 kA	Mersen A70QS125-4	35 kA	125 A	
480 V, 3-ph *	55	75	100 kA	Mersen A70QS200-4	35 kA	200 A	
480 V, 3-ph *	75	100	100 kA	Mersen A70QS200-4	35 kA	200 A	
480 V, 3-ph *	90	125	100 kA	Eaton FWP-350A Mersen A70QS350-4	10 kA	300 A	
480 V, 3-ph *	110	150	100 kA	Eaton FWP-350A Mersen A70QS350-4	10 kA	300 A	

* Mains choke required

Mains connection

1-phase mains connection 230/240 V

Connection diagrams

The connection plan is valid for the inverters I51AExxxB.

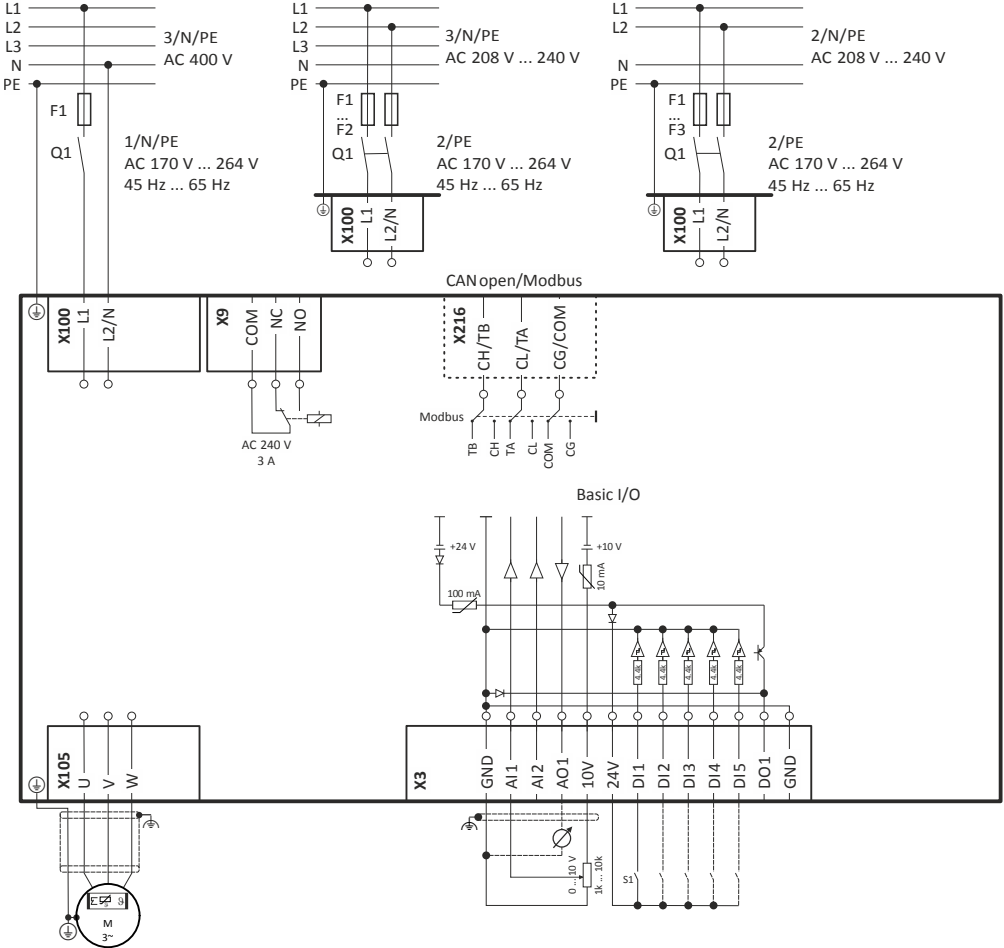

Fig. 7: Wiring example

S1 Start/Stop
Fx Fuses

Q1 Mains contactor
--- Dashed line = options

The connection plan is valid for the inverters I51AExxxD.



Inverters I51AExxxD do not have an integrated RFI filter in the AC mains supply.

In order to meet the EMC requirements according to EN 61800-3, an external EMC filter according to IEC EN 60939 must be used.

The user must verify that the conformity with EN 61800-3 is fulfilled.

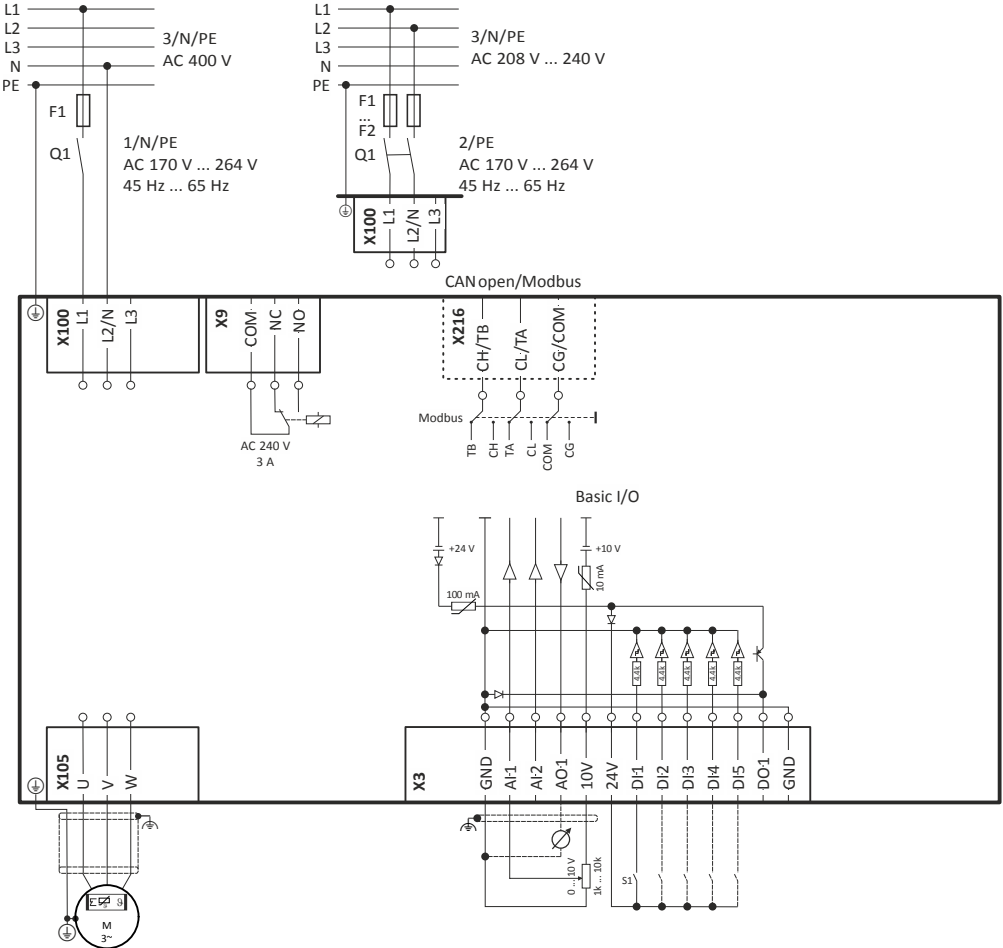

Fig. 8: Wiring example

S1 Start/Stop
Fx Fuses

Q1 Mains contactor
--- Dashed line = options

Electrical installation

Mains connection

1-phase mains connection 230/240 V

Terminal data

Inverter	I51AExxxx					
Inverter	kW	0.25 ... 0.75		1.1 ... 2.2	0.25 ... 2.2	0.25 ... 2.2
Connection		Mains connection X100			PE connection	Motor connection X105
Connection type		Pluggable screw terminal			PE screw	Pluggable screw terminal
Max. cable cross-section	mm ²	2.5	6		6	2.5
Stripping length	mm	8	8		10	8
Tightening torque	Nm	0.5	0.7		2	0.5
Required tool		0.5 x 3.0	0.6 x 3.5		Torx 20	0.5 x 3.0

Fusing data

EN 60204-1

Inverter	Fuse		Circuit breaker		Earth-leakage circuit breaker
	Characteristic	Max. rated current	Characteristic	Max. rated current	
		A		A	
I51AE125B	gG/gL or gRL	10	B	10	≥ 30 mA, type A or B
I51AE125D	gG/gL or gRL	10	B	10	≥ 30 mA, type A or B
I51AE137B	gG/gL or gRL	10	B	10	≥ 30 mA, type A or B
I51AE137D	gG/gL or gRL	10	B	10	≥ 30 mA, type A or B
I51AE155B	gG/gL or gRL	16	B	16	≥ 30 mA, type A or B
I51AE155D	gG/gL or gRL	16	B	16	≥ 30 mA, type A or B
I51AE175B	gG/gL or gRL	16	B	16	≥ 30 mA, type A or B
I51AE175D	gG/gL or gRL	16	B	16	≥ 30 mA, type A or B
I51AE211B	gG/gL or gRL	25	B	25	≥ 30 mA, type A or B
I51AE211D	gG/gL or gRL	25	B	25	≥ 30 mA, type A or B
I51AE215B	gG/gL or gRL	25	B	25	≥ 30 mA, type A or B
I51AE215D	gG/gL or gRL	25	B	25	≥ 30 mA, type A or B
I51AE222B	gG/gL or gRL	25	B	25	≥ 30 mA, type A or B
I51AE222D	gG/gL or gRL	25	B	25	≥ 30 mA, type A or B

3-phase mains connection 230/240 V

Connection diagrams

The connection plan is valid for the inverter I51AExxxC.



The I51AExxxC inverter does not have an integrated RFI filter in the AC mains supply.

In order to meet the EMC requirements according to EN 61800-3, an external EMC filter according to IEC EN 60939 must be used.

The user must verify that the conformity with EN 61800-3 is fulfilled.

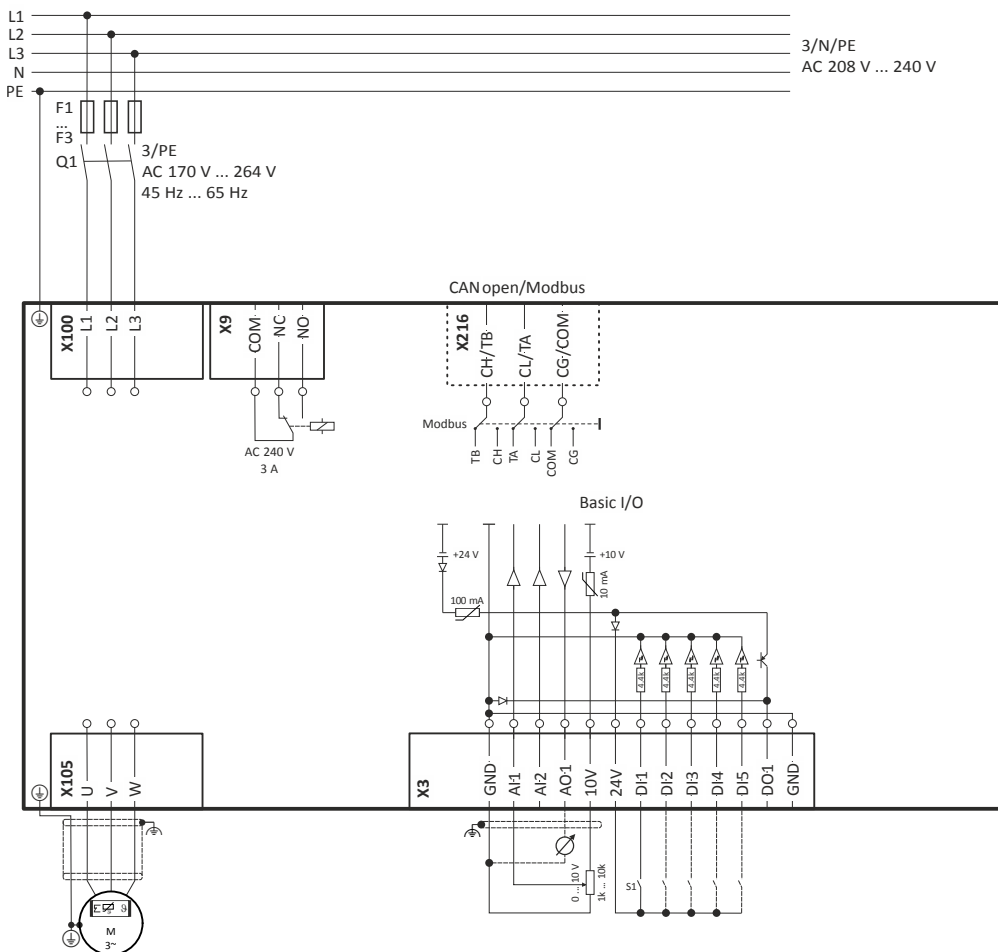

Fig. 9: Wiring example

S1 Start/Stop
Fx Fuses

Q1 Mains contactor
--- Dashed line = options

Electrical installation

Mains connection

3-phase mains connection 230/240 V

The connection plan is valid for the I51AE \times x \times D inverter.



The I51AE \times x \times D inverter does not have an integrated RFI filter in the AC mains supply.

In order to meet the EMC requirements according to EN 61800–3, an external EMC filter according to IEC EN 60939 must be used.

The user must verify that the conformity with EN 61800–3 is fulfilled.

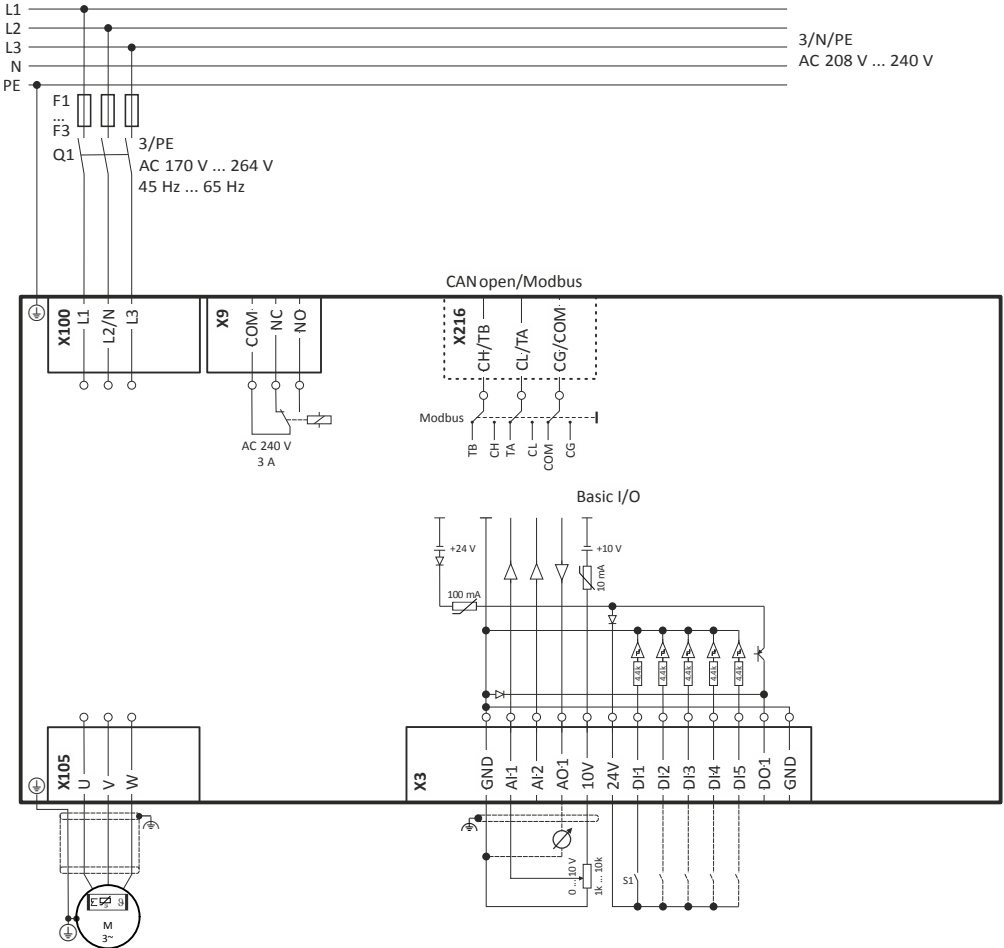

Fig. 10: Wiring example

S1 Start/Stop
Fx Fuses

Q1 Mains contactor
--- Dashed line = options

Terminal data

Inverter	kW	I51AExxxx					
		0.25 ... 0.75	1.1 ... 2.2	4.0 ... 5.5	0.25 ... 5.5	0.25 ... 2.2	4.0 ... 5.5
Connection		Mains connection X100			PE connection	Motor connection X105	
Connection type		Pluggable screw terminal		Screw terminal	PE screw	Pluggable screw terminal	Screw terminal
Max. cable cross-section	mm ²	2.5	6	6	6	2.5	6
Stripping length	mm	8	8	9	10	8	9
Tightening torque	Nm	0.5	0.7	0.5	2	0.5	0.5
Required tool		0.5 x 3.0		0.6 x 3.5		Torx 20	0.5 x 3.0

Fusing data

EN 60204-1

Inverter	Fuse		Circuit breaker		Earth-leakage circuit breaker
	Characteristic	Max. rated current	Characteristic	Max. rated current	
		A		A	
I51AE125D	gG/gL or gRL	10	B	10	≥ 30 mA, type B
I51AE137D	gG/gL or gRL	10	B	10	≥ 30 mA, type B
I51AE155D	gG/gL or gRL	16	B	16	≥ 30 mA, type B
I51AE175D	gG/gL or gRL	16	B	16	≥ 30 mA, type B
I51AE211D	gG/gL or gRL	25	B	25	≥ 30 mA, type B
I51AE215D	gG/gL or gRL	25	B	25	≥ 30 mA, type B
I51AE222D	gG/gL or gRL	25	B	25	≥ 30 mA, type B
I51AE240C	gG/gL or gRL	32	B	32	≥ 300 mA, type B
I51AE255C	gG/gL or gRL	32	B	32	≥ 300 mA, type B

3-phase mains connection 230/240 V "Light Duty"

Connection diagrams

See "3-phase mains connection 230/240 V". [103](#)

Terminal data

Inverter	kW	I51AExxxx		
		5.5 ... 7.5	5.5 ... 7.5	5.5 ... 7.5
Connection		Mains connection X100	PE connection	Motor connection X105
Connection type		Screw terminal		Screw terminal
Max. cable cross-section	mm ²	6	6	6
Stripping length	mm	9	10	9
Tightening torque	Nm	0.5	2	0.5
Required tool		0.6 x 3.5		Torx 20

Fusing data

EN 60204-1

Inverter	Fuse		Circuit breaker		Earth-leakage circuit breaker
	Characteristic	Max. rated current	Characteristic	Max. rated current	
		A		A	
I51AE240C	gG/gL or gRL	32	B	32	≥ 300 mA, type B
I51AE255C	gG/gL or gRL	32	B	32	≥ 300 mA, type B

3-phase mains connection 400 V

Connection diagrams

The connection plan is valid for the inverter I51AExxxF and I51BExxxF .

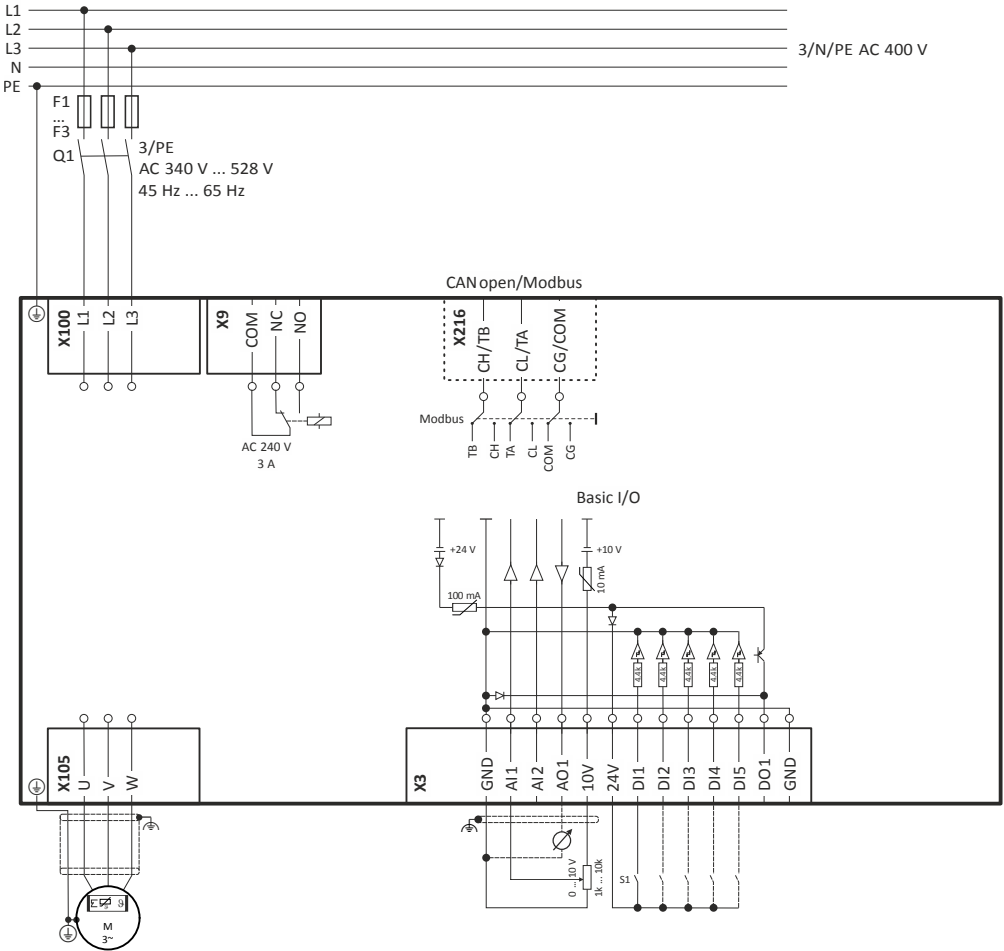

Fig. 11: Wiring example

S1 Start/Stop
Fx Fuses

Q1 Mains contactor
-- Dashed line = options

Terminal data

Inverter		I51AExxxF					
Inverter	kW	0.37 ... 2.2	3.0 ... 4.0	5.5	7.5 ... 11	0.37 ... 5.5	3.0 ... 4.0
Connection		Mains connection X100				PE connection	
Connection type		Pluggable screw terminal	Screw terminal			PE screw	
Max. cable cross-section	mm ²	2.5	6	6	16	6	6
Stripping length	mm	8	9	9	11	10	10
Tightening torque	Nm	0.5	0.5	0.5	1.2	2	2
Required tool		0.5 x 3.0	0.6 x 3.5		0.8 x 4.0	Torx 20	

Inverter		I51AExxxF					
Inverter	kW	7.5 ... 11	0.37 ... 2.2	3.0 ... 4.0	5.5	7.5 ... 11	
Connection		PE connection	Motor connection X105				
Connection type		PE screw	Pluggable screw terminal	Screw terminal			
Max. cable cross-section	mm ²	16	2.5	6	6	16	
Stripping length	mm	11	8	9	9	11	
Tightening torque	Nm	3.4	0.5	0.5	0.5	1.2	
Required tool		PZ2	0.5 x 3.0	0.6 x 3.5			0.8 x 4.0

Inverter		I51BExxxF			
Inverter	kW	3.0 ... 4.0	3.0 ... 4.0	3.0 ... 4.0	3.0 ... 4.0
Connection		Mains connection X100	PE connection	Motor connection X105	
Connection type		Pluggable screw terminal	PE screw	Pluggable screw terminal	
Max. cable cross-section	mm ²	4	6	2.5	
Stripping length	mm	8	10	8	
Tightening torque	Nm	0.6	2	0.5	
Required tool		0.5 x 3.0	Torx 20	0.5 x 3.0	

Fusing data

EN 60204-1

Inverter	Fuse		Circuit breaker		Earth-leakage circuit breaker
	Characteristic	Max. rated current	Characteristic	Max. rated current	
		A		A	
I51AE137F	gG/gL or gRL	10	B	10	≥ 30 mA, type B
I51AE155F	gG/gL or gRL	10	B	10	≥ 30 mA, type B
I51AE175F	gG/gL or gRL	10	B	10	≥ 30 mA, type B
I51AE211F	gG/gL or gRL	16	B	16	≥ 30 mA, type B
I51AE215F	gG/gL or gRL	16	B	16	≥ 30 mA, type B
I51AE222F	gG/gL or gRL	16	B	16	≥ 30 mA, type B
I51AE230F	gG/gL or gRL	25	B	25	≥ 300 mA, type B
I51BE230F	gG/gL or gRL	25	B	25	≥ 30 mA, type B
I51AE240F	gG/gL or gRL	25	B	25	≥ 300 mA, type B
I51BE240F	gG/gL or gRL	25	B	25	≥ 30 mA, type B
I51AE255F	gG/gL or gRL	25	B	25	≥ 300 mA, type B
I51AE275F	gG/gL or gRL	32	B	32	≥ 300 mA, type B
I51AE311F	gG/gL or gRL	32	B	32	≥ 300 mA, type B

Electrical installation

Mains connection

3-phase mains connection 400 V "Light Duty"

3-phase mains connection 400 V "Light Duty"

Connection diagrams

See "[3-phase mains connection 400 V](#)". [106](#)

Terminal data

See "[Terminal data](#)". [107](#)

Fusing data

EN 60204-1

Inverter	Fuse		Circuit breaker		Earth-leakage circuit breaker
	Characteristic	Max. rated current	Characteristic	Max. rated current	
		A		A	
I51AE230F	gG/gL or gRL	25	B	25	≥ 300 mA, type B
I51BE230F	gG/gL or gRL	25	B	25	≥ 30 mA, type B
I51AE240F	gG/gL or gRL	25	B	25	≥ 300 mA, type B
I51BE240F	gG/gL or gRL	25	B	25	≥ 30 mA, type B
I51AE255F	gG/gL or gRL	25	B	25	≥ 300 mA, type B
I51AE275F	gG/gL or gRL	32	B	32	≥ 300 mA, type B
I51AE311F	gG/gL or gRL	32	B	32	≥ 300 mA, type B

3-phase mains connection 480 V

Connection diagrams

The connection plan is valid for the inverters I51AExxxF.

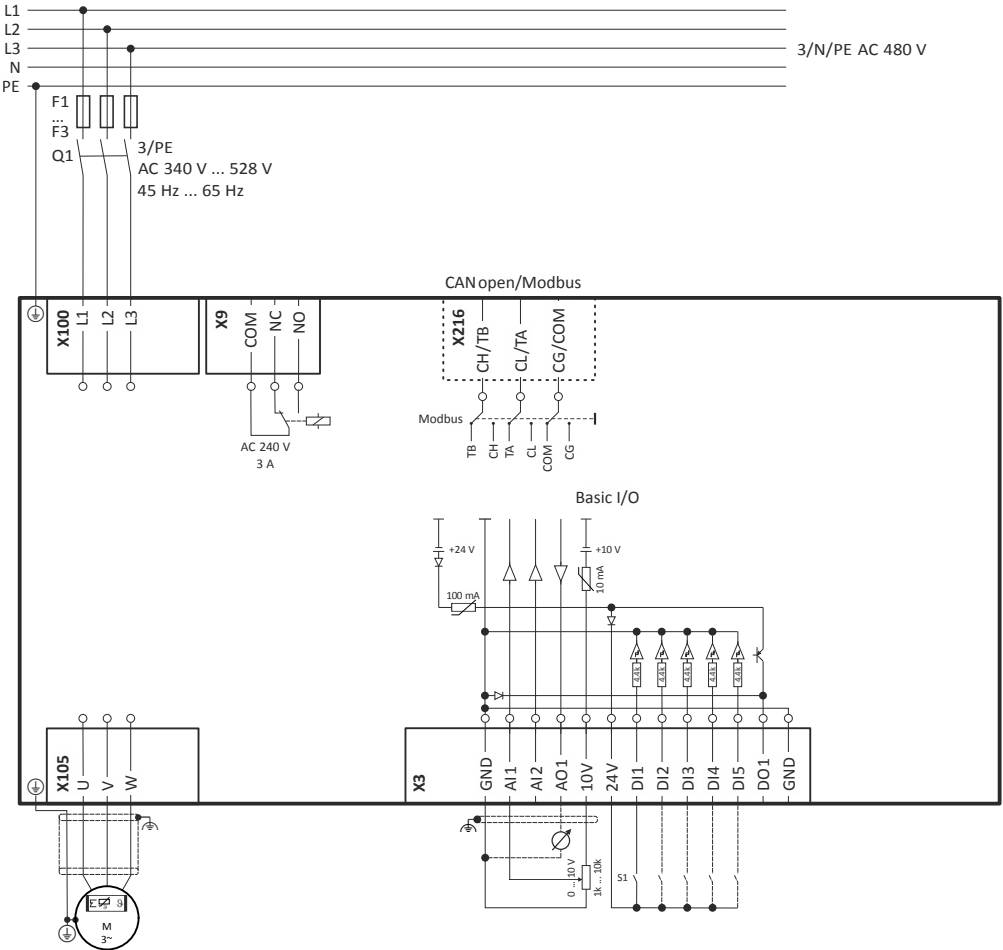

Fig. 12: Wiring example

S1 Start/Stop
Fx Fuses

Q1 Mains contactor
-- Dashed line = options

Terminal data

See "Terminal data". [107](#)

Electrical installation

Mains connection

3-phase mains connection 480 V "Light Duty"

Fusing data

EN 60204-1

Inverter	Fuse		Circuit breaker		Earth-leakage circuit breaker
	Characteristic	Max. rated current	Characteristic	Max. rated current	
		A		A	
I51AE137F	gG/gL or gRL	10	B	10	≥ 30 mA, type B
I51AE155F	gG/gL or gRL	10	B	10	≥ 30 mA, type B
I51AE175F	gG/gL or gRL	10	B	10	≥ 30 mA, type B
I51AE211F	gG/gL or gRL	16	B	16	≥ 30 mA, type B
I51AE215F	gG/gL or gRL	16	B	16	≥ 30 mA, type B
I51AE222F	gG/gL or gRL	16	B	16	≥ 30 mA, type B
I51AE230F	gG/gL or gRL	25	B	25	≥ 300 mA, type B
I51BE230F	gG/gL or gRL	25	B	25	≥ 30 mA, type B
I51AE240F	gG/gL or gRL	25	B	25	≥ 300 mA, type B
I51BE240F	gG/gL or gRL	25	B	25	≥ 30 mA, type B
I51AE255F	gG/gL or gRL	25	B	25	≥ 300 mA, type B
I51AE275F	gG/gL or gRL	32	B	32	≥ 300 mA, type B
I51AE311F	gG/gL or gRL	32	B	32	≥ 300 mA, type B

3-phase mains connection 480 V "Light Duty"

Connection diagrams

See "3-phase mains connection 480 V". [109](#)

Terminal data

See "Terminal data". [107](#)

Fusing data

EN 60204-1

Inverter	Fuse		Circuit breaker		Earth-leakage circuit breaker
	Characteristic	Max. rated current	Characteristic	Max. rated current	
		A		A	
I51AE230F	gG/gL or gRL	25	B	25	≥ 300 mA, type B
I51BE230F	gG/gL or gRL	25	B	25	≥ 30 mA, type B
I51AE240F	gG/gL or gRL	25	B	25	≥ 300 mA, type B
I51BE240F	gG/gL or gRL	25	B	25	≥ 30 mA, type B
I51AE255F	gG/gL or gRL	25	B	25	≥ 300 mA, type B
I51AE275F	gG/gL or gRL	32	B	32	≥ 300 mA, type B
I51AE311F	gG/gL or gRL	32	B	32	≥ 300 mA, type B

Connection to the IT system

For a trouble-free operation on the IT system, observe the following measures:

- Connect an isolating transformer upstream.
- Remove the IT screws. Otherwise the monitoring devices of the IT system will be triggered because internal components are connected to protective earth (PE).

I51AE125x, I51AE137x



I51AE155x, I51AE175x, I51AE211x, I51AE215x, I51AE222x,
I51BE230F, I51BE240F



I51AE230x, I51AE240x, I51AE255x, I51AE275x, I51AE311x

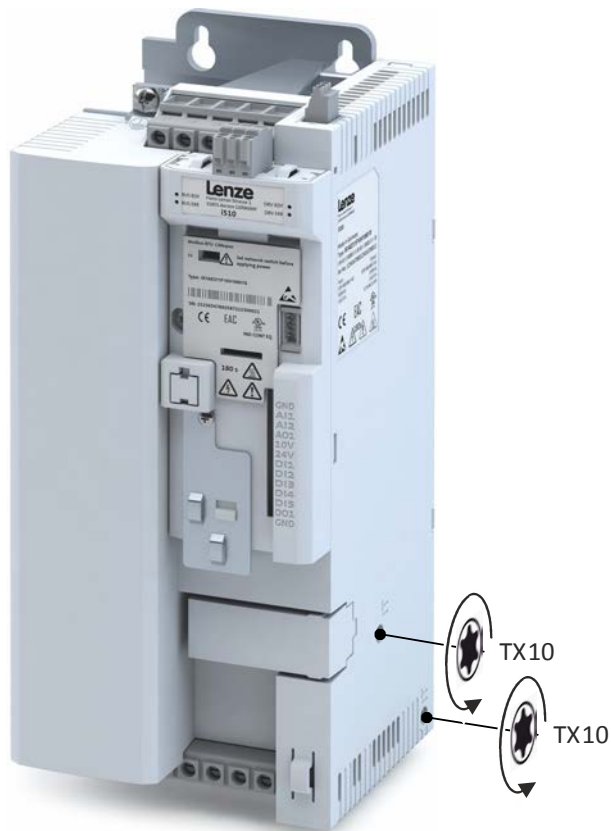

Control connections

Connection description		Control terminals
Connection		X3
Connection type		Spring terminal
Max. cable cross-section	mm ²	1.5
Max. cable cross-section	AWG	16
Stripping length	mm	9
Stripping length	inch	0.35
Tightening torque	Nm	-
Tightening torque	lb-in	-
Required tool		0.4 x 2.5

Networks

CANopen/Modbus



The network must be terminated with a 120 Ω resistor at the physically first and last node. Connect resistor to terminals CH/TB and CL/TA.

Typical topologies

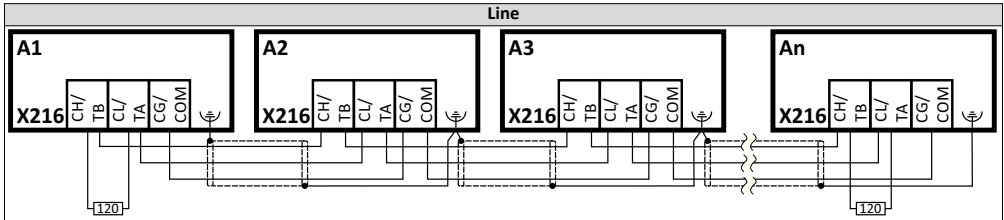

Connection description		CANopen/Modbus	
Connection		X216	
Connection type		pluggable double spring terminal	
Max. cable cross-section	mm ²	2.5	
Max. cable cross-section	AWG	12	
Stripping length	mm	10	
Stripping length	inch	0.39	
Tightening torque	Nm	-	
Tightening torque	lb-in	-	
Required tool		0.4 x 2.5	

Basic network settings

1. Select network CANopen or Modbus using the switch on the front of the inverter.

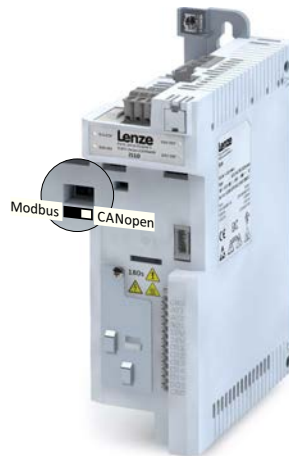

2. Set node address and baud rate via the corresponding parameters.

BACnet

Typical topologies

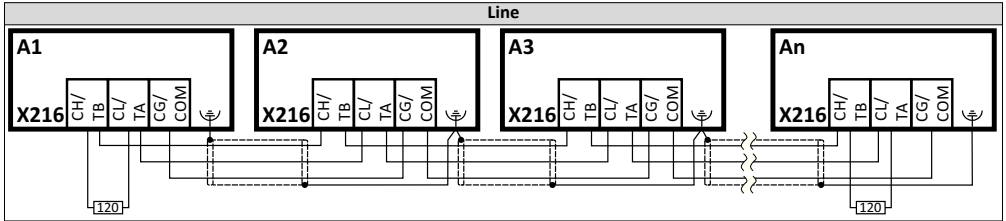

Connection description		BACnet MS/TP	
Connection		X216	
Connection type		pluggable double spring terminal	
Max. cable cross-section	mm ²	2.5	
Max. cable cross-section	AWG	12	
Stripping length	mm	10	
Stripping length	inch	0.39	
Tightening torque	Nm	-	
Tightening torque	lb-in	-	
Required tool		0.4 x 2.5	

Basic network settings

1. Select network BACnet using the switch on the front of the inverter.



2. Set node address and baud rate via the corresponding parameters.

Commissioning

The purpose of commissioning is to adapt the inverter as part of a machine with a variable-speed drive system to its drive task.

Important notes

DANGER!

Incorrect wiring can cause unexpected states during the commissioning phase.

Possible consequences: death, severe injuries or damage to property

Ensure the following before switching on the mains voltage:

- ▶ Wiring must be complete and correct.
 - ▶ Wiring must be free of short circuits and earth faults.
 - ▶ The motor circuit configuration (star/delta) must be adapted to the inverter output voltage.
 - ▶ The motor must be connected in-phase (direction of rotation).
 - ▶ The "emergency off" function of the overall system must operate correctly.
-

Initial switch-on and functional test

Target: achieve rotation of the motor connected to the inverter as quickly as possible.

Requirements:

- The connected motor matches the inverter in terms of power.
- The parameter settings comply with the delivery status (Lenze setting).

1. Preparation

1. Wire power terminals.
2. Wire digital inputs X3/DI1 (start/stop), X3/DI3 (reversal) and X3/DI4 (frequency preset 20 Hz).
3. Do not connect terminal X3/AI1 (analog setpoint selection) or connect it to GND.

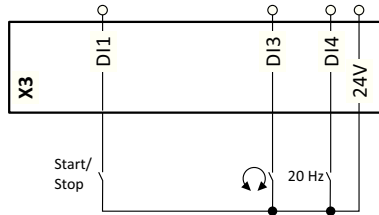

2. Switch on mains and check readiness for operation

1. Switch on mains voltage.
2. Observe LED status displays "RDY" and "ERR" on the front of the inverter:
 - a) If the blue "RDY" LED is blinking and the red "ERR" LED is off, the inverter is ready for operation. The controller is inhibited. You can now start the drive.
 - b) If the red "ERR" LED is lit permanently, a fault is pending. Eliminate the fault before you carry on with the functional test.

LED status displays

"RDY" LED (blue)	"ERR" LED (red)	Status/meaning
off	off	No supply voltage.
blinking (1 Hz)	off	Safe torque off (STO) active.
	blinking fast (4 Hz)	Safe torque off (STO) active. Warning active.
blinking (2 Hz)	off	Inverter inhibited.
	lit every 1.5 s for a short time	Inverter inhibited, no DC-bus voltage.
	blinking fast (4 Hz)	Inverter inhibited, warning active.
	on	Inverter inhibited, fault active.
on	off	Inverter enabled.
	blinking fast (4 Hz)	Inverter enabled, warning active.
	blinking (1 Hz)	Inverter enabled, quick stop as response to a fault active.

Carry out functional test

1. Start drive

1. Start inverter: X3/DI1 = HIGH.
2. Activate frequency preset 1 (20 Hz) as speed setpoint: X3/DI4 = HIGH.
The drive rotates with 20 Hz.
3. Optional: activate the function for the reversal of rotation direction.
 - a) X3/DI3 = HIGH.
The drive rotates at 20 Hz in the opposite direction.
 - b) Deactivate the function for the reversal of rotation direction again: X3/DI3 = LOW.
Speed characteristic (example)

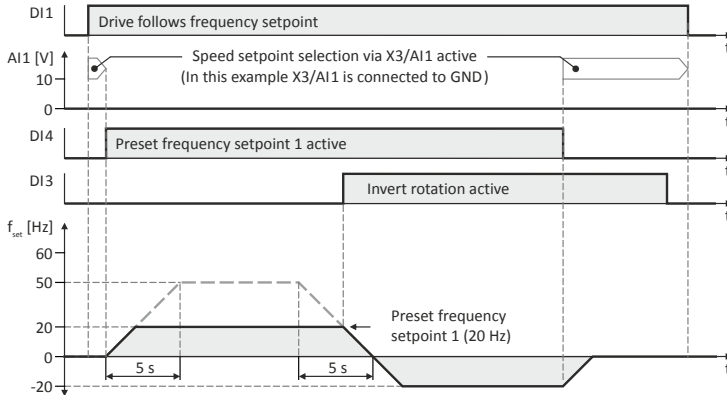

2. Stop drive

1. Deactivate frequency preset 1 again: X3/DI4 = LOW.
2. Stop inverter again: X3/DI1 = LOW.

The functional test has been completed.

Technical data

Standards and operating conditions

Conformities/approvals

Conformity		
CE	2014/35/EU	Low-Voltage Directive
	2014/30/EU	EMC Directive (reference: CE-typical drive system)
EAC	TR CU 004/2011	Eurasian conformity: safety of low voltage equipment
	TR CU 020/2011	Eurasian conformity: electromagnetic compatibility of technical means
RoHS	2011/65/EU	Restrictions on the use of certain hazardous substances in electrical and electronic devices
Approval		
UL	UL 61800-5-1	for USA and Canada (requirements of the CSA 22.2 No. 274) File No. E132659

Protection of persons and device protection

Degree of protection		
IP20	EN 60529	Data applies for operationally ready mounted state and not in wire range of terminals
Open type	UL 50	Protection against accidental contact only Only in UL-approved systems
Insulation resistance		
Overvoltage category III	EN 61800-5-1	0 ... 2000 m amsl
Overvoltage category II	EN 61800-5-1	over 2000 m amsl
Isolation of control circuits		
Safe mains isolation via double/reinforced insulation	EN 61800-5-1	
Leakage current		
> 3.5 mA AC, > 10 mA DC	EN 61800-5-1	Please observe regulations and safety instructions!
Starting current		
≤ 3 x rated mains current		
Protective measures against		
Short circuit		
Earth fault		Earth-fault protected depending on operating status
Overtemperature of motor		I ² t monitoring
Overvoltage		
Motor stalling		

EMC data

Noise emission		
Category C2	EN 61800-3	See rated data
Category C3	EN 61800-3	See rated data
Noise immunity		
Fulfills requirements according to	EN 61800-3	
Operation on public supply systems		
Take measures to limit the expected radio interference:		The machine or system manufacturer is responsible for compliance with the requirements for the machine/system!
< 1 kW: With mains choke	EN 61000-3-2	
> 1 kW for mains current ≤ 16 A: Without additional measures		
Mains current > 16 A: with mains choke or mains filter, with dimensioning for rated power.	EN 61000-3-12	

Motor connection

Requirements for the shielded motor cable		
Capacitance per unit length		
C-core-core/C-core-shielding < 75/150 pF/m		≤ 2.5 mm ² / AWG 14
C-core-core/C-core-shielding < 150/300 pF/m		≥ 4 mm ² / AWG 12
Electric strength		
U ₀ /U = 0.6/1.0 kV		U ₀ = r.m.s. value external conductor to PE U = r.m.s. value from external conductor to external conductor
U ≥ 600 V	UL	U = r.m.s. value from external conductor to external conductor

Environmental conditions

Energy efficiency		
Class IE2	EN 50598-2	
Climate		
1K3 (-25 ... +60°C)	EN 60721-3-1	Storage
2K3 (-25 ... +70°C)	EN 60721-3-2	Transport
3K3 (-10 ... +55°C)	EN 60721-3-3	Operation
		Operation at a switching frequency of 2 or 4 kHz: above +45°C, reduce rated output current by 2.5 %/°C
		Operation at a switching frequency of 8 or 16 kHz: above +40°C reduce rated output current by 2.5 %/°C
Site altitude		
0 ... 1000 m amsl		
1000 ... 4000 m amsl		Reduce rated output current by 5 %/1000 m
Pollution		
Degree of pollution 2	EN 61800-5-1 UL 61800-5-1	
Vibration resistance		
Transport		
2M2 (sine, shock)	EN 60721-3-2	In original packaging
Operation		
Amplitude 1 mm	Germanischer Lloyd	5 ... 13.2 Hz
Acceleration resistant up to 0.7 g		13.2 ... 100 Hz
Amplitude 0.075 mm		10 ... 57 Hz
Acceleration resistant up to 1 g	EN 61800-5-1	57 ... 150 Hz

Electrical supply conditions

Permissible power systems		
TT		Voltage to earth: max. 300 V
TN		Voltage to earth: max. 300 V
IT		Please employ the measures described for IT systems!
		IT systems not relevant for UL-approved systems

Technical data

1-phase mains connection 230/240 V

Rated data

1-phase mains connection 230/240 V

Rated data

The output currents apply to these operating conditions:

- At a switching frequency of 2 kHz or 4 kHz: Max. ambient temperature 45°C.
- At a switching frequency of 8 kHz or 16 kHz: Max. ambient temperature 40 °C.

Inverter		I51AE125B	I51AE125D	I51AE137B	I51AE137D	I51AE155B	I51AE155D
Rated power	kW	0.25	0.25	0.37	0.37	0.55	0.55
Rated power	hp	0.33	0.33	0.5	0.5	0.75	0.75
Mains voltage range		1/PE AC 170 V ... 264 V, 45 Hz ... 65 Hz					
Output voltage		3 AC 0-230/240 V					
Rated mains current							
Without mains choke	A	4	4	5.7	5.7	7.6	7.6
With mains choke	A	3.6	3.6	4.8	4.8	7.1	7.1
Apparent output power	kVA	0.6	0.6	0.9	0.9	1.2	1.2
Rated output current							
2 kHz	A	-	-	-	-	3.2	3.2
4 kHz	A	1.7	1.7	2.4	2.4	3.2	3.2
8 kHz	A	1.7	1.7	2.4	2.4	3.2	3.2
16 kHz	A	1.1	1.1	1.6	1.6	2.1	2.1
Power loss							
2 kHz	W	-	-	-	-	22	22
4 kHz	W	15	15	18	18	23	23
8 kHz	W	15	15	20	20	25	25
16 kHz	W	19	19	24	24	30	30
For controller inhibit	W	6	6	6	6	6	6
Cyclic mains switching		3 times per minute					
Max. motor cable length shielded							
Category C2 (2 kHz, 4 kHz, 8 kHz)	m	15	-	15	-	20	-
Category C3 (2 kHz, 4 kHz, 8 kHz)	m	15	-	15	-	50	-
Without EMC category	m	50	50	50	50	50	50
Weight	kg	0.75	0.75	0.75	0.75	0.95	0.95
Weight	lb	1.7	1.7	1.7	1.7	2.1	2.1

Inverter		I51AE175B	I51AE175D	I51AE211B	I51AE211D	I51AE215B	I51AE215D
Rated power	kW	0.75	0.75	1.1	1.1	1.5	1.5
Rated power	hp	1	1	1.5	1.5	2	2
Mains voltage range		1/PE AC 170 V ... 264 V, 45 Hz ... 65 Hz					
Output voltage		3 AC 0-230/240 V					
Rated mains current							
Without mains choke	A	10	10	14.3	14.3	16.7	16.7
With mains choke	A	8.8	8.8	11.9	11.9	13.9	13.9
Apparent output power	kVA	1.6	1.6	2.2	2.2	2.6	2.6
Rated output current							
2 kHz	A	4.2	4.2	6	6	7	7
4 kHz	A	4.2	4.2	6	6	7	7
8 kHz	A	4.2	4.2	6	6	7	7
16 kHz	A	2.8	2.8	4	4	4.7	4.7
Power loss							
2 kHz	W	27	27	36	36	41	41
4 kHz	W	29	29	37	37	43	43
8 kHz	W	33	33	42	42	50	50
16 kHz	W	38	38	51	51	59	59
For controller inhibit	W	6	6	6	6	6	6
Cyclic mains switching		3 times per minute					
Max. motor cable length shielded							
Category C2 (2 kHz, 4 kHz, 8 kHz)	m	20	-	20	-	20	-
Category C3 (2 kHz, 4 kHz, 8 kHz)	m	50	-	35	-	35	-
Without EMC category	m	50	50	50	50	50	50
Weight	kg	0.95	0.95	1.35	1.35	1.35	1.35
Weight	lb	2.1	2.1	3	3	3	3

Inverter		I51AE222B		I51AE222D	
Rated power	kW	2.2		2.2	
Rated power	hp	3		3	
Mains voltage range		1/PE AC 170 V ... 264 V, 45 Hz ... 65 Hz			
Output voltage		3 AC 0-230/240 V			
Rated mains current					
Without mains choke	A	22.5		22.5	
With mains choke	A	16.9		16.9	
Apparent output power	kVA	3.6		3.6	
Rated output current					
2 kHz	A	9.6		9.6	
4 kHz	A	9.6		9.6	
8 kHz	A	9.6		9.6	
16 kHz	A	6.4		6.4	
Power loss					
2 kHz	W	54		54	
4 kHz	W	60		60	
8 kHz	W	70		70	
16 kHz	W	78		78	
For controller inhibit	W	6		6	
Cyclic mains switching		3 times per minute			
Max. motor cable length shielded					
Category C2 (2 kHz, 4 kHz, 8 kHz)	m	20		-	
Category C3 (2 kHz, 4 kHz, 8 kHz)	m	35		-	
Without EMC category	m	50		50	
Weight	kg	1.35		1.35	
Weight	lb	3		3	

Technical data

3-phase mains connection 230/240 V

Rated data

3-phase mains connection 230/240 V

Rated data

The output currents apply to these operating conditions:

- At a switching frequency of 2 kHz or 4 kHz: Max. ambient temperature 45°C.
- At a switching frequency of 8 kHz or 16 kHz: Max. ambient temperature 40 °C.

Inverter		I51AE125D	I51AE137D	I51AE155D	I51AE175D	I51AE211D	I51AE215D
Rated power	kW	0.25	0.37	0.55	0.75	1.1	1.5
Rated power	hp	0.33	0.5	0.75	1	1.5	2
Mains voltage range		3/PE AC 170 V ... 264 V, 45 Hz ... 65 Hz					
Output voltage		3 AC 0-230/240 V					
Rated mains current							
Without mains choke	A	2.6	3.9	4.8	6.4	7.8	9.5
With mains choke	A	2	3	3.8	5.1	5.6	6.8
Apparent output power	kVA	0.6	0.9	1.2	1.6	2.2	2.6
Rated output current							
2 kHz	A	-	-	3.2	4.2	6	7
4 kHz	A	1.7	2.4	3.2	4.2	6	7
8 kHz	A	1.7	2.4	3.2	4.2	6	7
16 kHz	A	1.1	1.6	2.1	2.8	4	4.7
Power loss							
2 kHz	W	-	-	22	27	36	41
4 kHz	W	15	18	23	29	37	43
8 kHz	W	15	20	25	33	42	50
16 kHz	W	19	24	30	38	51	59
For controller inhibit	W	6	6	6	6	6	6
Cyclic mains switching		3 times per minute					
Max. motor cable length shielded							
Category C2 (2 kHz, 4 kHz, 8 kHz)	m	-	-	-	-	-	-
Category C3 (2 kHz, 4 kHz, 8 kHz)	m	-	-	-	-	-	-
Without EMC category	m	50	50	50	50	50	50
Weight	kg	0.75	0.75	0.95	0.95	1.35	1.35
Weight	lb	1.7	1.7	2.1	2.1	3	3

Inverter		I51AE222D	I51AE240C	I51AE255C
Rated power	kW	2.2	4	5.5
Rated power	hp	3	5	7.5
Mains voltage range		3/PE AC 170 V ... 264 V, 45 Hz ... 65 Hz		
Output voltage		3 AC 0-230/240 V		
Rated mains current				
Without mains choke	A	13.6	20.6	28.8
With mains choke	A	9.8	15.7	21.9
Apparent output power	kVA	3.6	6.4	8.7
Rated output current				
2 kHz	A	9.6	16.5	23
4 kHz	A	9.6	16.5	23
8 kHz	A	9.6	16.5	23
16 kHz	A	6.4	11	15.3
Power loss				
2 kHz	W	54	113	166
4 kHz	W	60	115	175
8 kHz	W	70	130	195
16 kHz	W	78	116	159
For controller inhibit	W	6	6	6
Cyclic mains switching		3 times per minute		
Max. motor cable length shielded				
Category C2 (2 kHz, 4 kHz, 8 kHz)	m	-	-	-
Category C3 (2 kHz, 4 kHz, 8 kHz)	m	-	-	-
Without EMC category	m	50	50	50
Weight	kg	1.35	2.1	2.1
Weight	lb	3	4.6	4.6

Technical data

3-phase mains connection 230/240 V "Light Duty"

Rated data

3-phase mains connection 230/240 V "Light Duty"

Rated data

The output currents apply to these operating conditions:

- At a switching frequency of 2 kHz or 4 kHz: Ambient temperature above 40 °C with a rated output current reduced by 2.5 %/°C.
- If the load characteristic "Light Duty" and the switching frequencies 8 kHz or 16 kHz are selected, only the values of the load characteristic "Heavy Duty" are reached.

Inverter		I51AE240C	I51AE255C
Rated power	kW	5.5	7.5
Rated power	hp	7.5	10
Mains voltage range		3/PE AC 170 V ... 264 V, 45 Hz ... 65 Hz	
Output voltage		3 AC 0-230/240 V	
Rated mains current			
Without mains choke	A	25.8	-
With mains choke	A	18.9	24.2
Apparent output power	kVA	8	10.5
Rated output current			
2 kHz	A	20.6	27.6
4 kHz	A	20.6	27.6
8 kHz	A	-	-
16 kHz	A	-	-
Power loss			
2 kHz	W	124	190
4 kHz	W	131	200
8 kHz	W	-	-
16 kHz	W	-	-
For controller inhibit	W	6	6
Cyclic mains switching		3 times per minute	
Max. motor cable length shielded			
Category C2 (2 kHz, 4 kHz, 8 kHz)	m	-	-
Category C3 (2 kHz, 4 kHz, 8 kHz)	m	-	-
Without EMC category	m	50	50
Weight	kg	2.1	2.1
Weight	lb	4.6	4.6

3-phase mains connection 400 V

Rated data

The output currents apply to these operating conditions:

- At a switching frequency of 2 kHz or 4 kHz: Max. ambient temperature 45°C.
- At a switching frequency of 8 kHz or 16 kHz: Max. ambient temperature 40 °C.

Inverter		I51AE137F	I51AE155F	I51AE175F	I51AE211F	I51AE215F	I51AE222F
Rated power	kW	0.37	0.55	0.75	1.1	1.5	2.2
Rated power	hp	0.5	0.75	1	1.5	2	3
Mains voltage range		3/PE AC 340 V ... 528 V, 45 Hz ... 65 Hz					
Output voltage		3 AC 0-400/480 V					
Rated mains current							
Without mains choke	A	1.8	2.5	3.3	4.4	5.4	7.8
With mains choke	A	1.4	2	2.6	3	3.7	5.3
Apparent output power	kVA	0.9	1.2	1.6	2.2	2.6	3.8
Rated output current							
2 kHz	A	-	1.8	2.4	3.2	3.9	5.6
4 kHz	A	1.3	1.8	2.4	3.2	3.9	5.6
8 kHz	A	1.3	1.8	2.4	3.2	3.9	5.6
16 kHz	A	0.9	1.2	1.6	2.1	2.6	3.7
Power loss							
2 kHz	W	-	24	30	38	45	62
4 kHz	W	20	25	32	40	48	66
8 kHz	W	24	31	40	51	61	85
16 kHz	W	24	31	40	51	61	85
For controller inhibit	W	6	6	6	6	6	6
Cyclic mains switching		3 times per minute					
Max. motor cable length shielded							
Category C2 (2 kHz, 4 kHz, 8 kHz)	m	15	15	15	20	20	20
Category C3 (2 kHz, 4 kHz, 8 kHz)	m	15	20	20	35	35	35
Without EMC category	m	15	50	50	50	50	50
Weight	kg	0.75	0.95	0.95	1.35	1.35	1.35
Weight	lb	1.7	2.1	2.1	3	3	3

Technical data

3-phase mains connection 400 V

Rated data

Inverter		I51AE230F	I51BE230F	I51AE240F	I51BE240F	I51AE255F	I51AE275F	I51AE311F
Rated power	kW	3	3	4	4	5.5	7.5	11
Rated power	hp	4	4	5	5	7.5	10	15
Mains voltage range		3/PE AC 340 V ... 528 V, 45 Hz ... 65 Hz						
Output voltage		3 AC 0-400/480 V						
Rated mains current								
Without mains choke	A	9.6	9.6	12.5	12.5	17.2	20	28.4
With mains choke	A	6.9	6.9	9	9	12.4	15.7	22.3
Apparent output power	kVA	4.9	4.9	6.4	6.4	8.7	11	16
Rated output current								
2 kHz	A	7.3	7.3	9.5	9.5	13	16.5	23.5
4 kHz	A	7.3	7.3	9.5	9.5	13	16.5	23.5
8 kHz	A	7.3	7.3	9.5	9.5	13	16.5	23.5
16 kHz	A	4.9	4.9	6.3	6.3	8.7	11	15.7
Power loss								
2 kHz	W	79	79	102	102	137	172	242
4 kHz	W	85	85	110	110	145	185	260
8 kHz	W	110	110	140	140	190	240	340
16 kHz	W	109	109	140	140	189	238	337
For controller inhibit	W	6	6	6	6	6	6	6
Cyclic mains switching		3 times per minute						
Max. motor cable length shielded								
Category C2 (2 kHz, 4 kHz, 8 kHz)	m	20	20	20	20	20	20	20
Category C3 (2 kHz, 4 kHz, 8 kHz)	m	35	35	35	35	35	50	50
Without EMC category	m	100	50	100	50	100	100	100
Weight	kg	2.3	1.35	2.3	1.35	2.3	3.7	3.7
Weight	lb	5	3	5	3	5	8	8

3-phase mains connection 400 V "Light Duty"

Rated data

The output currents apply to these operating conditions:

- At a switching frequency of 2 kHz or 4 kHz: Ambient temperature above 40 °C with a rated output current reduced by 2.5 %/°C.
- If the load characteristic "Light Duty" and the switching frequencies 8 kHz or 16 kHz are selected, only the values of the load characteristic "Heavy Duty" are reached.

Inverter		I51AE230F	I51BE230F	I51AE240F	I51BE240F	I51AE255F	I51AE275F	I51AE311F
Rated power	kW	4	4	5.5	5.5	7.5	11	15
Rated power	hp	5	5	7.5	7.5	10	15	20
Mains voltage range		3/PE AC 340 V ... 528 V, 45 Hz ... 65 Hz						
Output voltage		3 AC 0-400/480 V						
Rated mains current								
Without mains choke	A	10.3	10.3	14	14	18.3	28	-
With mains choke	A	8.2	8.2	11	11	14.5	22	27.1
Apparent output power	kVA	5.9	5.9	8	8	10.5	15	19
Rated output current								
2 kHz	A	8.8	8.8	11.9	11.9	15.6	23	28.2
4 kHz	A	8.8	8.8	11.9	11.9	15.6	23	28.2
8 kHz	A	-	-	-	-	-	-	-
16 kHz	A	-	-	-	-	-	-	-
Power loss								
2 kHz	W	94	94	125	125	163	238	290
4 kHz	W	100	100	133	133	173	253	309
8 kHz	W	-	-	-	-	-	-	-
16 kHz	W	-	-	-	-	-	-	-
For controller inhibit	W	6	6	6	6	6	6	6
Cyclic mains switching		3 times per minute						
Max. motor cable length shielded								
Category C2 (2 kHz, 4 kHz, 8 kHz)	m	20	20	20	20	20	20	20
Category C3 (2 kHz, 4 kHz, 8 kHz)	m	35	35	35	35	35	50	50
Without EMC category	m	100	50	100	50	100	100	100
Weight	kg	2.3	1.35	2.3	1.35	2.3	3.7	3.7
Weight	lb	5	3	5	3	5	8	8

Technical data

3-phase mains connection 480 V

Rated data

3-phase mains connection 480 V

Rated data

The output currents apply to these operating conditions:

- At a switching frequency of 2 kHz or 4 kHz: Max. ambient temperature 45°C.
- At a switching frequency of 8 kHz or 16 kHz: Max. ambient temperature 40 °C.

Inverter		I51AE137F	I51AE155F	I51AE175F	I51AE211F	I51AE215F	I51AE222F
Rated power	kW	0.37	0.55	0.75	1.1	1.5	2.2
Rated power	hp	0.5	0.75	1	1.5	2	3
Mains voltage range		3/PE AC 340 V ... 528 V, 45 Hz ... 65 Hz					
Output voltage		3 AC 0-400/480 V					
Rated mains current							
Without mains choke	A	1.5	2.1	2.8	3.7	4.5	6.5
With mains choke	A	1.2	1.7	2.2	2.5	3.1	4.4
Apparent output power	kVA	0.9	1.2	1.6	2.2	2.6	3.8
Rated output current							
2 kHz	A	-	1.6	2.1	3	3.5	4.8
4 kHz	A	1.1	1.6	2.1	3	3.5	4.8
8 kHz	A	1.1	1.6	2.1	3	3.5	4.8
16 kHz	A	0.7	1.1	1.4	2	2.3	3.2
Power loss							
2 kHz	W	-	24	30	38	45	62
4 kHz	W	20	25	32	40	48	66
8 kHz	W	24	31	40	51	61	85
16 kHz	W	24	31	40	51	61	85
For controller inhibit	W	6	6	6	6	6	6
Cyclic mains switching		3 times per minute					
Max. motor cable length shielded							
Category C2 (2 kHz, 4 kHz, 8 kHz)	m	15	15	15	20	20	20
Category C3 (2 kHz, 4 kHz, 8 kHz)	m	15	20	20	35	35	35
Without EMC category	m	15	50	50	50	50	50
Weight	kg	0.75	0.95	0.95	1.35	1.35	1.35
Weight	lb	1.7	2.1	2.1	3	3	3

Inverter		I51AE230F	I51BE230F	I51AE240F	I51BE240F	I51AE255F	I51AE275F	I51AE311F
Rated power	kW	3	3	4	4	5.5	7.5	11
Rated power	hp	4	4	5	5	7.5	10	15
Mains voltage range		3/PE AC 340 V ... 528 V, 45 Hz ... 65 Hz						
Output voltage		3 AC 0-400/480 V						
Rated mains current								
Without mains choke	A	8	8	10.5	10.5	14.3	16.6	23.7
With mains choke	A	5.8	5.8	7.5	7.5	10.3	13.1	18.6
Apparent output power	kVA	4.9	4.9	6.4	6.4	8.7	11	16
Rated output current								
2 kHz	A	6.3	6.3	8.2	8.2	11	14	21
4 kHz	A	6.3	6.3	8.2	8.2	11	14	21
8 kHz	A	6.3	6.3	8.2	8.2	11	14	21
16 kHz	A	4.2	4.2	5.5	5.5	7.3	9.3	14
Power loss								
2 kHz	W	79	79	102	102	137	172	242
4 kHz	W	85	85	110	110	145	185	260
8 kHz	W	110	110	140	140	190	240	340
16 kHz	W	109	109	140	140	189	238	337
For controller inhibit	W	6	6	6	6	6	6	6
Cyclic mains switching		3 times per minute						
Max. motor cable length shielded								
Category C2 (2 kHz, 4 kHz, 8 kHz)	m	20	20	20	20	20	20	20
Category C3 (2 kHz, 4 kHz, 8 kHz)	m	35	35	35	35	35	50	50
Without EMC category	m	100	50	100	50	100	100	100
Weight	kg	2.3	1.35	2.3	1.35	2.3	3.7	3.7
Weight	lb	5	3	5	3	5	8	8

Technical data

3-phase mains connection 480 V "Light Duty"

Rated data

3-phase mains connection 480 V "Light Duty"





Rated data

The output currents apply to these operating conditions:

- At a switching frequency of 2 kHz or 4 kHz: Ambient temperature above 40 °C with a rated output current reduced by 2.5 %/°C.
- If the load characteristic "Light Duty" and the switching frequencies 8 kHz or 16 kHz are selected, only the values of the load characteristic "Heavy Duty" are reached.

Inverter		I51AE230F	I51BE230F	I51AE240F	I51BE240F	I51AE255F	I51AE275F	I51AE311F
Rated power	kW	4	4	5.5	5.5	7.5	11	15
Rated power	hp	5	5	7.5	7.5	10	15	20
Mains voltage range		3/PE AC 340 V ... 528 V, 45 Hz ... 65 Hz						
Output voltage		3 AC 0-400/480 V						
Rated mains current								
Without mains choke	A	8.6	8.6	11.2	11.2	15.3	22	-
With mains choke	A	6.8	6.8	8.8	8.8	12.1	17.2	22.6
Apparent output power	kVA	5.9	5.9	8	8	10.5	15	19
Rated output current								
2 kHz	A	7.6	7.6	9.8	9.8	13.2	18.3	25.2
4 kHz	A	7.6	7.6	9.8	9.8	13.2	18.3	25.2
8 kHz	A	-	-	-	-	-	-	-
16 kHz	A	-	-	-	-	-	-	-
Power loss								
2 kHz	W	94	94	125	125	163	238	290
4 kHz	W	100	100	133	133	173	253	309
8 kHz	W	-	-	-	-	-	-	-
16 kHz	W	-	-	-	-	-	-	-
For controller inhibit	W	6	6	6	6	6	6	6
Cyclic mains switching		3 times per minute						
Max. motor cable length shielded								
Category C2 (2 kHz, 4 kHz, 8 kHz)	m	20	20	20	20	20	20	20
Category C3 (2 kHz, 4 kHz, 8 kHz)	m	35	35	35	35	35	50	50
Without EMC category	m	100	50	100	50	100	100	100
Weight	kg	2.3	1.35	2.3	1.35	2.3	3.7	3.7
Weight	lb	5	3	5	3	5	8	8

 Lenze Drives GmbH
Postfach 10 13 52, D-31763 Hameln
Breslauer Straße 3, D-32699 Extertal
Germany
HR Lemgo B 6478
 +49 5154 82-0
 +49 5154 82-2800
 sales.de@lenze.com
 www.lenze.com

 Lenze Service GmbH
Breslauer Straße 3, D-32699 Extertal
Germany
 0080002446877 (24 h Helpline)
 +49 5154 82-1112
 service.de@lenze.com