

6mm Interface Relays

RV8 Series

Electromechanical C1D2 (screw terminal)



Solid State (spring clamp)



SPECIFICATIONS

Models	Electromechanical Standard/ Hazardous Locations C1D2	Solid State
Ratings	Class I, Division 2, Groups A, B, C, D, T4A Class I, Zone 2 AEx nA nC IIC T4 Class I, Zone 2 Ex nA nC IIC T4 X Gc UL/c-UL Listed CE	UL/c-UL Listed, CE
Number of Poles	1 pole	1 pole
Contact Configuration	1 form C (SPDT)	1 form A (SPST)
Contact Material	AgNi (Au plating)	MOSFET, Transistor or Triac
Degree of Protection	IP20	IP20
Dielectric Strength	Between Contact and Coil	4,000V AC for 1 min
	Between Pole	1,000V AC for 1 min
Vibration Resistance	Operating Extremes	NO: Frequency 10 to 55Hz, Amplitude 0.5mm NC: Frequency 10 to 55Hz, Amplitude 0.2mm
	Damage Limits	-
Shock Resistance	Operating Extremes	NO: 49m/s ² (5G) NC: 29.4m/s ² (3G)
	Damage Limits	980m/s ² (100G)
Mechanical Life (without load)	Over 10,000,000 operations (operation frequency 18,000 operations per hour)	-
Operating Temperature	-40 to +70°C without freezing (-40 to +55°C for AD110 and AD220 coil voltages)	-20 to +60°C
Operating Humidity	5 to 85% (without condensation)	5 to 85% (without condensation)
Weight (approx.)	30g (RV8H-L), 26g (RV8H-S)	30g (RV8S-L), 26g (RV8S-S)

PRODUCT DESCRIPTION

IDEC 6mm interface relays provide a compact solution for general purpose relay requirements. Now available with solid state models, the RV8 series Interface relays are ideal for PLC and electronic systems, industrial automation, panel builders, assembly machine applications and other applications that require a high switching capability in a compact space. The RV8 series interface relays can be used as interfaces between the controller and the actuator to switch small and medium size loads.

KEY FEATURES

- Class I, Division 2 and Class I, Zone 2 Hazardous Location options (electromechanical relays only)
- Solid State relay versions available
- Only 70mm in height from DIN rail
- Gold-plated contacts (electrical mechanical relays only)
- Pre-assembled relay and DIN mount socket
- Universal screw terminals (flat and phillips) or spring clamp terminals
- Universal AC/DC socket with built-in surge suppression and green LED
- 6A contact rating (electromechanical relays only)
- Lever for easy locking and removal of relay
- Operating temperature of -40°C ~ +70°C (-20°C ~ +60°C for SSR)
- RoHS compliant



(when using combination of RV relay and SV socket)

PART NUMBERS

Electromechanical General Purpose and Hazardous Location (Class I, Division 2) Relays

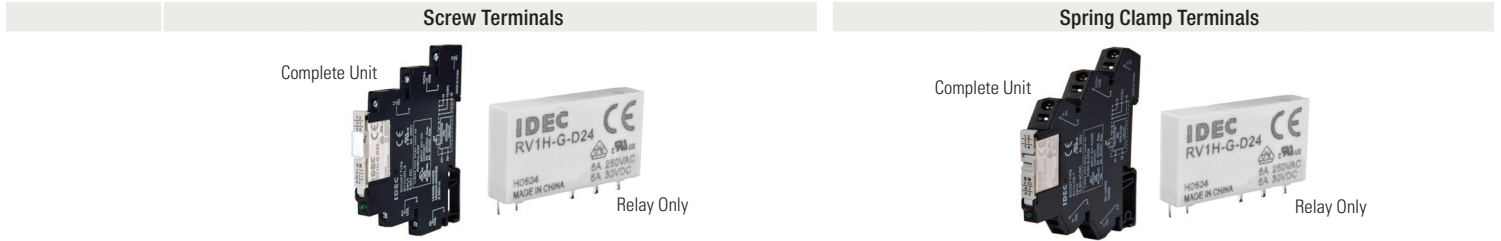

Coil Voltage	General Purpose		Hazardous Location (C1D2)		General Purpose		Hazardous Location (C1D2)		
	Complete Part Number	Replacement (Relay Only)	Complete Part Number	Replacement (Relay Only)	Complete Part Number	Replacement (Relay Only)	Complete Part Number	Replacement (Relay Only)	
DC	6V	RV8H-L-D6	RV1H-G-D5	RV8H-L-D6-C1D2	RV1H-G-D5-C1D2	RV8H-S-D6	RV1H-G-D5	RV8H-S-D6-C1D2	RV1H-G-D5-C1D2
	9V	RV8H-L-D9	RV1H-G-D9	RV8H-L-D9-C1D2	RV1H-G-D9-C1D2	RV8H-S-D9	RV1H-G-D9	RV8H-S-D9-C1D2	RV1H-G-D9-C1D2
	12V	RV8H-L-D12	RV1H-G-D12	RV8H-L-D12-C1D2	RV1H-G-D12-C1D2	RV8H-S-D12	RV1H-G-D12	RV8H-S-D12-C1D2	RV1H-G-D12-C1D2
	18V	RV8H-L-D18	RV1H-G-D18	RV8H-L-D18-C1D2	RV1H-G-D18-C1D2	RV8H-S-D18	RV1H-G-D18	RV8H-S-D18-C1D2	RV1H-G-D18-C1D2
	24V	RV8H-L-D24	RV1H-G-D24	RV8H-L-D24-C1D2	RV1H-G-D24-C1D2	RV8H-S-D24	RV1H-G-D24	RV8H-S-D24-C1D2	RV1H-G-D24-C1D2
AC/DC	12V	RV8H-L-AD12	RV1H-G-D12	RV8H-L-AD12-C1D2	RV1H-G-D12-C1D2	RV8H-S-AD12	RV1H-G-D12	RV8H-S-AD12-C1D2	RV1H-G-D12-C1D2
	18V	RV8H-L-AD18	RV1H-G-D18	RV8H-L-AD18-C1D2	RV1H-G-D18-C1D2	RV8H-S-AD18	RV1H-G-D18	RV8H-S-AD18-C1D2	RV1H-G-D18-C1D2
	24V	RV8H-L-AD24	RV1H-G-D24	RV8H-L-AD24-C1D2	RV1H-G-D24-C1D2	RV8H-S-AD24	RV1H-G-D24	RV8H-S-AD24-C1D2	RV1H-G-D24-C1D2
	48V	RV8H-L-AD48	RV1H-G-D48	RV8H-L-AD48-C1D2	RV1H-G-D48-C1D2	RV8H-S-AD48	RV1H-G-D48	RV8H-S-AD48-C1D2	RV1H-G-D48-C1D2
	60V	RV8H-L-AD60	RV1H-G-D60	RV8H-L-AD60-C1D2	RV1H-G-D60-C1D2	RV8H-S-AD60	RV1H-G-D60	RV8H-S-AD60-C1D2	RV1H-G-D60-C1D2
	110V - 125V	RV8H-L-AD110	RV1H-G-D60	RV8H-L-AD110-C1D2	RV1H-G-D60-C1D2	RV8H-S-AD110	RV1H-G-D60	RV8H-S-AD110-C1D2	RV1H-G-D60-C1D2
	220V - 240V	RV8H-L-AD220	RV1H-G-D60	RV8H-L-AD220-C1D2	RV1H-G-D60-C1D2	RV8H-S-AD220	RV1H-G-D60	RV8H-S-AD220-C1D2	RV1H-G-D60-C1D2

Solid State Relays

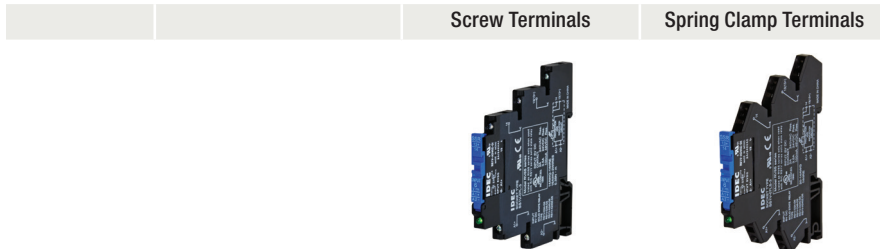

Input Voltage	Output Voltage	Complete Part Number	Complete Part Number	
DC	6V	24V DC, 3.5A	RV8S-L-D24-D6	RV8S-S-D24-D6
		48V DC, 0.1A	RV8S-L-D48-D6	RV8S-S-D48-D6
		240V AC, 2A zero cross	RV8S-L-A240Z-D6	RV8S-S-A240Z-D6
		240V AC, 2A random	RV8S-L-A240-D6	RV8S-S-A240-D6
	24V	24V DC, 3.5A	RV8S-L-D24-D24	RV8S-S-D24-D24
		48V DC, 0.1A	RV8S-L-D48-D24	RV8S-S-D48-D24
		240V AC, 2A zero cross	RV8S-L-A240Z-D24	RV8S-S-A240Z-D24
		240V AC, 2A random	RV8S-L-A240-D24	RV8S-S-A240-D24
AC	120V	24V DC, 3.5A	RV8S-L-D24-A120	RV8S-S-D24-A120
		48V DC, 0.1A	RV8S-L-D48-A120	RV8S-S-D48-A120
		240V AC, 2A zero cross	RV8S-L-A240Z-A120	RV8S-S-A240Z-A120
		240V AC, 2A random	RV8S-L-A240-A120	RV8S-S-A240-A120
	240V	24V DC, 3.5A	RV8S-L-D24-A240	RV8S-S-D24-A240
		48V DC, 0.1A	RV8S-L-D48-A240	RV8S-S-D48-A240
		240V AC, 2A zero cross	RV8S-L-A240Z-A240	RV8S-S-A240Z-A240
		240V AC, 2A random	RV8S-L-A240-A240	RV8S-S-A240-A240

800.262.4332
www.IDEC.com/relays

RATINGS

Electromechanical Coil Ratings

Rated Voltage	Rated Current ±15% (mA)*	Circuit AC Resistance ±15% (Ω)*	Circuit DC Resistance ±15% (Ω)*	Operating Characteristics			Power Consumption	
				Pickup Voltage	Dropout Voltage	Maximum Allowable Voltage		
DC	6V	35	-	170	90% max	7% min	110%	0.21W
	9V	18.6	-	485				0.2W
	12V	14.6	-	820				0.2W
	18V	11.6	-	1550				0.2W
	24V	10.6	-	2270				0.25W
AC/DC	12V	15.5	755	800	90% max	7% min	110%	0.2W
	18V	13.3	1365	1345				0.25W
	24V	13.7	1730	1790				0.33W
	48V	4	11880	12230				0.2W
	60V	3.4	17600	17910				0.2W
	110V - 125V	3.4 - 3.9	31790 - 31890	32450 - 32900				0.5W
	220V - 240V	3.3 - 3.6	65670 - 66070	65940 - 68570				0.85W

*±10% for 6V, 9V and 12V

Electromechanical Contact Ratings

Allowable Contact Power	Resistive Load	1500VA, 180W DC
Rated Load	Resistive Load	250V AC 6A, 30V DC 6A
Allowable Switching Current		6A
Allowable Switching Voltage		400V AC, 125V DC
Allowable Switching Power		1500VA, 180W DC
Minimum Applicable Load		6V DC/10mA

Solid State Input Ratings



Type	Control Voltage Range	Output / Input Voltage	Pickup Voltage	Dropout Voltage	Input Current	Maximum Operation Time	Maximum Release Time
	4.5-12V DC	24V DC / 6V DC	4.5V DC	1.5V DC	10mA±10%(±6VDC)	120µs	200µs
	19.6-30V DC	24V DC / 24V DC	19.6V DC	5V DC	9mA±10%(±24VDC)	350µs	200µs
	96-132V AC	24V DC / 120V AC	96V AC	12V AC	10mA±10%(±120VAC)	11ms	14ms
	192-264V AC	24V DC / 240V AC	192V AC	24V AC	10mA±10%(±240VAC)	11ms	14ms
	4.5-12V DC	48V DC / 6V DC	4.5V DC	1.5V DC	6mA±10%(±6VDC)	40µs	300µs
	19.6-30V DC	48V DC / 24V DC	19.6V DC	5V DC	7mA±10%(±24VDC)	40µs	300µs
	96-132V AC	48V DC / 120V AC	96V AC	12V AC	10mA±10%(±120VAC)	8ms	14ms
	192-264V AC	48V DC / 240V AC	192V AC	24V AC	10mA±10%(±240VAC)	8ms	14ms
Zero Crossing	4.5-12V DC	240V AC / 6V DC	4.5V DC	2V DC	15mA±10%(±6VDC)	10ms	10ms
	19.6-30V DC	240V AC / 24V DC	19.6V DC	5V DC	7mA±10%(±24VDC)	10ms	10ms
	96-132V AC	240V AC / 120V AC	96V AC	12V AC	10mA±10%(±120VAC)	16ms	20ms
	192-264V AC	240V AC / 240V AC	192V AC	24V AC	10mA±10%(±240VAC)	16ms	20ms
Random Crossing	4.5-12V DC	240V AC / 6V DC	4.5V DC	2V DC	15mA±10%(±6VDC)	300µs	10ms
	19.6-30V DC	240V AC / 24V DC	19.6V DC	5V DC	7mA±10%(±24VDC)	300µs	10ms
	96-132V AC	240V AC / 120V AC	96V AC	12V AC	10mA±10%(±120VAC)	8ms	20ms
	192-264V AC	240V AC / 240V AC	192V AC	24V AC	10mA±10%(±240VAC)	8ms	20ms

Solid State Output Ratings

Typical Input Voltage	24V DC	48V DC	240V AC
Output Device	MOSFET	Photo-transistor	Triac
Operating Voltage Range	0-24V DC	0-48V DC	24-280V AC (47-63Hz)
Maximum Load Current	3.5A	100mA	2A
Minimum Load Current	1mA	1mA	70mA
Maximum Blocking Voltage	30V DC	60V DC	600V AC
Maximum Surge Current	9A (10ms)	300mA (10ms)	120A pk (16.6ms)
Maximum I ² t for Fusing	-	-	60A ² sec
Typical On-State Leakage Current	0.4V	1V	1.1V (peak)
Maximum Off-State Leakage Current	0.001mA	0.001mA	4mA
Switching Configuration	Normally Open	Normally Open	Normally Open

ACCESSORIES

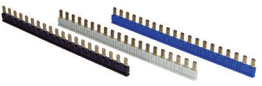
Jumpers, Spacer, and Screwdriver

Item	Color	Part Number
Jumper (20 combs) <small>Note 1, 2, 4</small> 	Black	SV9Z-J20B
	Gray	SV9Z-J20W
	Blue	SV9Z-J20S
Spacer (circuit separator) <small>Note 3, 4</small> 	-	SV9Z-SA2W
Screwdriver 	-	BC1S-SD0

1. Jumper combs come with 20 points, if shorter lengths are needed simply cut off the excess points.
2. Ensure that the total current to the jumper does not exceed the overall rated current (Rated current: 6A).
3. Width of spacer: 2mm
4. When using a cut jumper, please use a spacer on the cut side. For additional information see instruction sheet.

Marking Plates (Blank and Pre-marked)

Item	Part Number	Engraving
 Horizontal Orientation	SV9Z-PW10	blank
	SV9Z-PW10-⓪1-10	1-10
	SV9Z-PW10-⓪11-20	11-20
	SV9Z-PW10-⓪21-30	21-30
	SV9Z-PW10-⓪31-40	31-40
	SV9Z-PW10-⓪41-50	41-50
	SV9Z-PW10-⓪51-60	51-60
	SV9Z-PW10-⓪61-70	61-70
	SV9Z-PW10-⓪71-80	71-80
	SV9Z-PW10-⓪81-90	81-90
 Vertical Orientation	SV9Z-PW10-⓪91-100	91-100
	SV9Z-PW10-⓪A-J	A-J
	SV9Z-PW10-⓪K-T	K-T
	SV9Z-PW10-⓪U-Z	U-Z
	SV9Z-PW10-⓪GROUND	⓪
	SV9Z-PW10-⓪AC	⓪

1. In place of ⓪ insert orientation code: V=Vertical, H=Horizontal
2. Each unit has 10 pieces (marking plates).

Marking Plate Placement

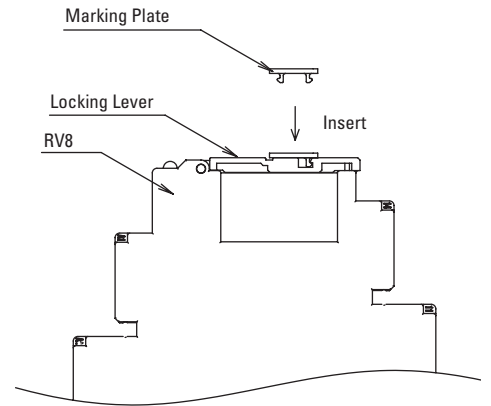

Dimensions (mm)

SV9Z-PW10* Marking Plate

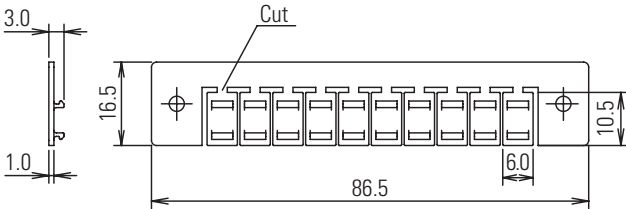

*Available blank or pre-marked.

SV9Z-SA2W Spacer

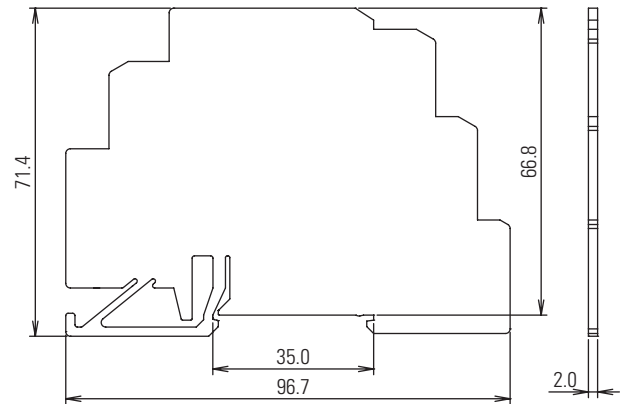

SV9Z-J20* Jumper

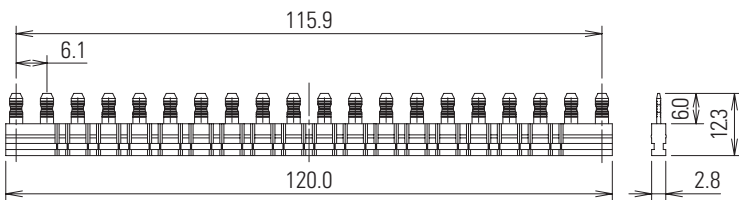

*Available in black, gray and blue.

DIMENSIONS

Electromechanical Relays

RV8H-L Screw Terminal (mm)

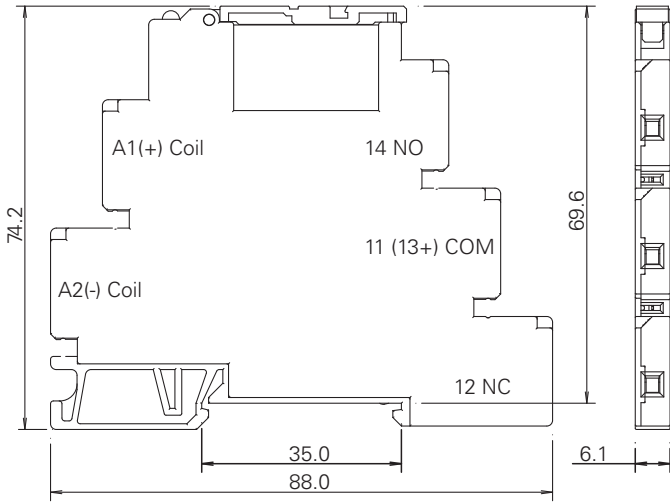

RV8H-S Spring Clamp Terminal (mm)

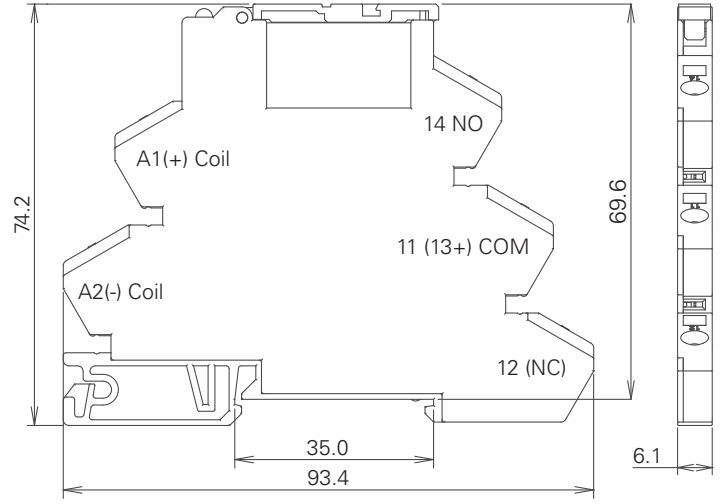

Solid State Relays

RV8S-L Screw Terminal (mm)

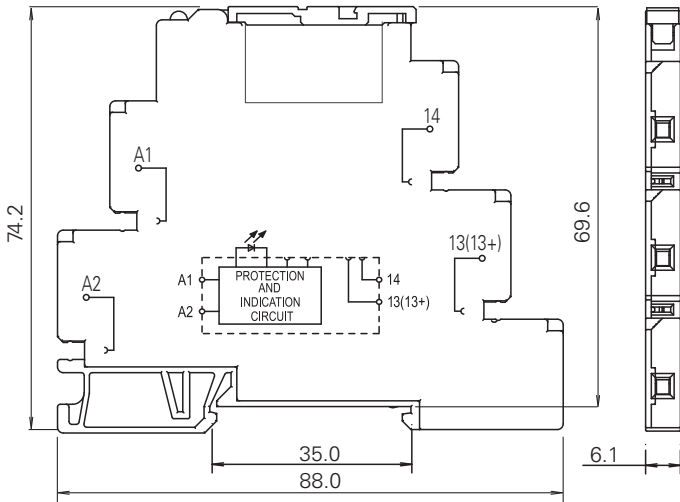

RV8S-S Spring Clamp Terminal (mm)

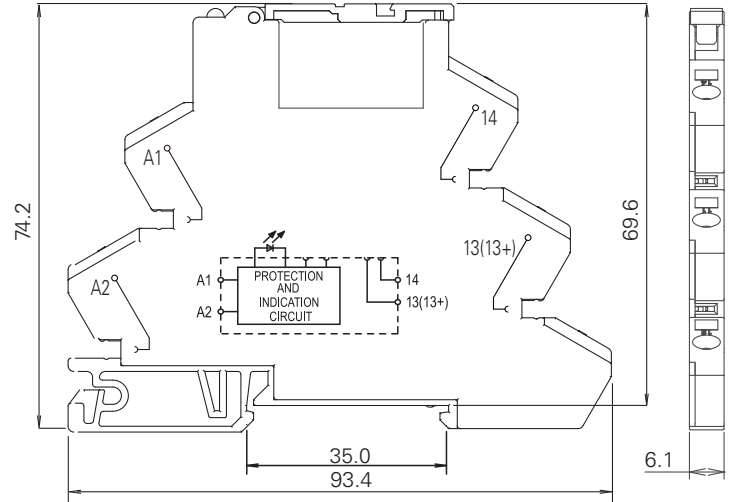

RV1H Replacement Electromechanical Relay (mm)

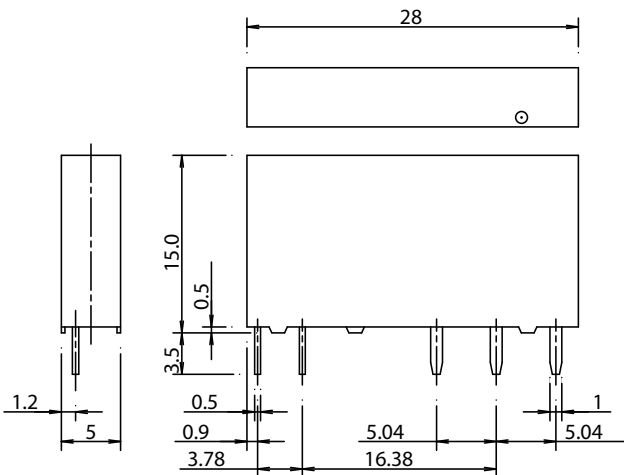

Internal Connection bottom view (mm)

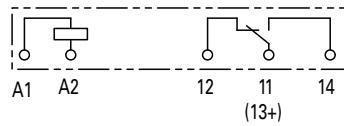

Note: Drawings are not to scale

CHARACTERISTICS

RV1H Replacement Electromechanical Relay

Maximum Switching Power AC

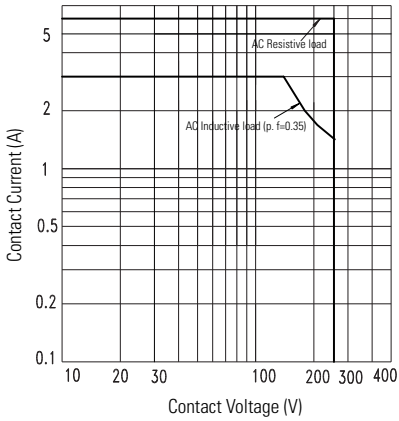

Maximum Switching Power DC

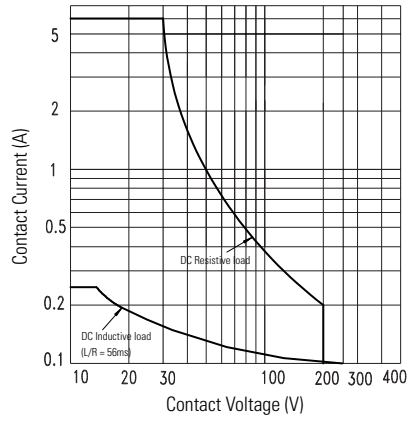

Solid State Continuous Load Current vs. Ambient Temperature Curves

24V DC

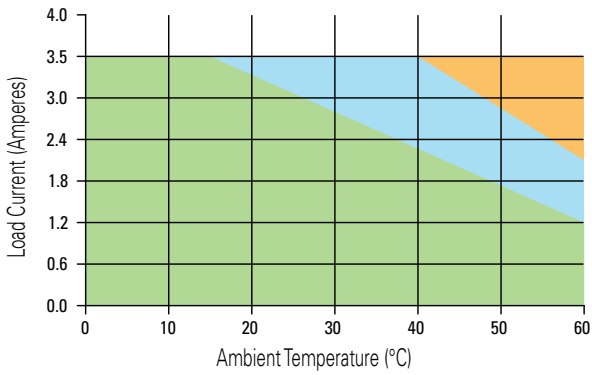

48V DC

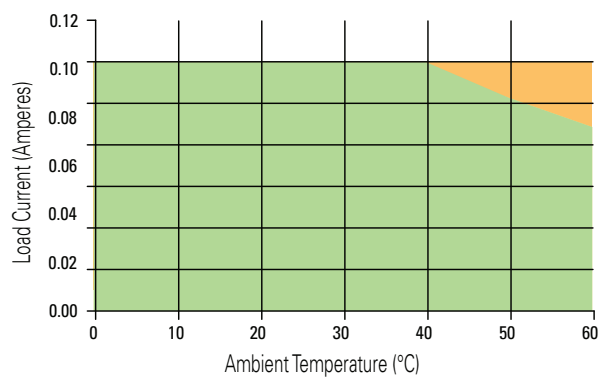

240V AC Zero Cross

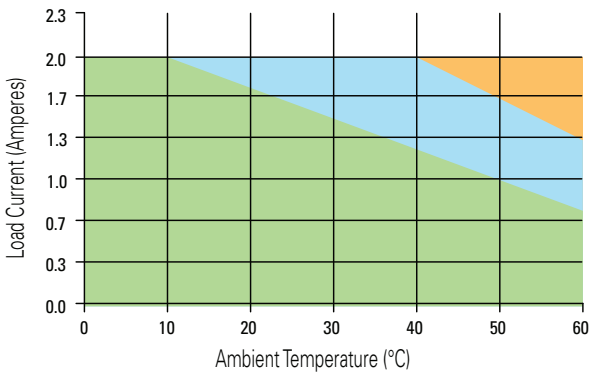

240V AC Random Cross

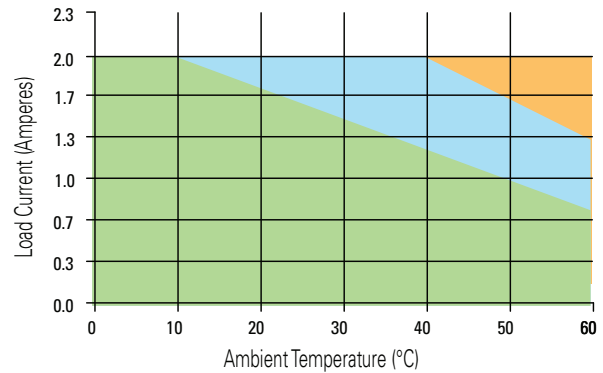

Legend

- No spacing required between units.
- Spacing of 6.2mm minimum required between units
- Not Recommended

