

FC6A SERIES

MICROSmart

PID Module
User's Manual



SAFETY PRECAUTIONS

- Read this manual to make sure of correct operation before starting installation, wiring, operation, maintenance, and inspection of the FC6A series MicroSmart PID modules.
- All MicroSmart modules are manufactured under IDEC's rigorous quality control system, but users must add a backup or failsafe provision to the control system using the FC6A Series MicroSmart in applications where heavy damage or personal injury may be caused in case the FC6A Series MicroSmart should fail.
- In this manual, safety precautions are categorized in order of importance from Warning to Caution.



Warning Warning notices are used to emphasize that improper operation may cause severe personal injury or death.

- The FC6A Series MicroSmart is not designed for use in applications requiring a high degree of reliability and safety. The FC6A Series MicroSmart should not be used for such applications.
- When using the FC6A Series MicroSmart in applications not described above that require a high degree of reliability in terms of functionality and precision, ensure that all system devices are designed with failsafe mechanisms, redundant mechanisms, and other measures. The following are specific examples.
 - Special expertise is required to install, wire, program, and operate the FC6A Series MicroSmart.
 - If relays or transistors in output circuits should fail, outputs may remain in an on or off state. For output signals which may cause serious accidents, provide a status monitor circuit outside the FC6A Series MicroSmart.
 - The FC6A Series MicroSmart self-diagnostic function may detect internal circuit or program errors, stop programs, and turn outputs off. Organize circuits so that the system the FC6A Series MicroSmart has been built into is not jeopardized when outputs turn off.
- Turn off the power to the FC6A Series MicroSmart before starting installation, removal, wiring, maintenance, and inspection of the FC6A Series MicroSmart. Failure to turn power off may cause electrical shocks or fire hazard.
- Emergency stop and interlocking circuits must be configured outside the FC6A Series MicroSmart. If such a circuit is configured inside the FC6A Series MicroSmart, failure of the FC6A Series MicroSmart may cause a malfunction of the control system, damage, or accidents.
- Install the FC6A Series MicroSmart according to the instructions described in this manual. Improper installation will result in disattachment, failure, or malfunction of the FC6A Series MicroSmart.



Caution Caution notices are used where inattention might cause personal injury or damage to equipment.

- the FC6A Series MicroSmart is designed for installation in a cabinet. Do not install the FC6A Series MicroSmart outside a cabinet.
- Install the FC6A Series MicroSmart in environments described in this manual. If the FC6A Series MicroSmart is used in places where the FC6A Series MicroSmart is subjected to high-temperature, high-humidity, condensation, corrosive gases, excessive vibrations, and excessive shocks, then electrical shocks, fire hazard, or malfunction will result.
- The environment for using the FC6A Series MicroSmart is "Pollution degree 2." Use the FC6A Series MicroSmart in environments of pollution degree 2 (according to IEC 60664-1).
- Prevent the FC6A Series MicroSmart from being dropped while moving or transporting the FC6A Series MicroSmart, otherwise damage or malfunction of the FC6A Series MicroSmart will result.
- Wiring must use lead sizes that are appropriate for the applied voltage and current. Terminal screws must be tightened with the prescribed tightening torque.
- Prevent metal fragments and pieces of wire from dropping inside the FC6A Series MicroSmart housing. Put a cover on the FC6A Series MicroSmart modules during installation and wiring. Ingress of such fragments and chips may cause fire hazard, damage, or malfunction.
- Use a power supply matching the rated value. Use of an incorrect power supply may cause fire hazard.
- Use an IEC 60127-compliant fuse on the exterior side of the power line. This is required when equipment containing the FC6A Series MicroSmart is destined for Europe.
- Use an IEC 60127-compliant fuse on the output circuit. This is required when equipment containing the FC6A Series MicroSmart is destined for Europe.
- Use an EU-approved circuit breaker. This is required when equipment containing the FC6A Series MicroSmart is destined for Europe.
- Make sure of safety before starting and stopping the FC6A Series MicroSmart or when operating the FC6A Series MicroSmart to force outputs on or off. Incorrect operation on the FC6A Series MicroSmart may cause machine damage or accidents.
- Do not connect the ground wire directly to the FC6A Series MicroSmart. Connect a protective ground to the cabinet containing the FC6A Series MicroSmart using an M4 or larger screw. This is required when equipment containing the FC6A Series MicroSmart is destined for Europe.
- Do not disassemble, repair, or modify the FC6A Series MicroSmart modules.
- The FC6A Series MicroSmart contains electronic parts and batteries. When disposing of the FC6A Series MicroSmart, do so in accordance with national and local regulations.

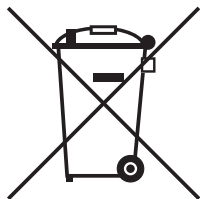

ABOUT THIS MANUAL

Thank you for purchasing the FC6A Series MicroSmart manufactured by IDEC Corporation. This document describes the FC6A Series MicroSmart system configuration, specifications, and installation methods, and it provides descriptions of the various functions. Read this manual to ensure the correct understanding of the entire functions of the PID module.

Publication history

December 2015 First Edition

NOTICE

- IDEC Corporation holds all rights related to this manual. This publication is not to be, nor any parts of it, photocopied, reprinted, sold, transferred, or rented out without the specific written permission and consent of IDEC.
- The content of this manual may change without prior notification.
- We have taken all possible measures with the content of this product, but if you notice any portions that are unclear, or any mistakes, please contact the dealer where purchased or an IDEC sales or field office.

Trademarks

FC6A Series MicroSmart is a trademark of IDEC Corporation.

Regarding laws and compatible standards

This product adheres to the laws and compatible standards of all countries involved, as shown below.

European laws and standards

This product complies with the following EU directives.

- Low Voltage Directive
- EMC Directive

To comply with these directives, this product has been designed and evaluated on the basis of the following international and European standard.

- IEC/EN 61131-2: 2007

For details on the compatible standards and EU Directives, contact the distributor from which you purchased this product or visit our web site.

North America laws and standards

This product complies with the following standards.

- UL508
- CSA C22.2 No.142
- ANSI/ISA 12,12,01*1
- CAN/CSA C22.2 No.213*1

*1 Certain FC6A Series MicroSmart models are not compatible. For details, please contact IDEC Corporation.

For details on compatible standards and EU directives, please contact the dealer where purchased or check the IDEC website.

IMPORTANT INFORMATION

Under no circumstances shall IDEC Corporation be held liable or responsible for indirect or consequential damages resulting from the use of or the application of IDEC PLC components, individually or in combination with other equipment.

All persons using these components must be willing to accept responsibility for choosing the correct component to suit their application and for choosing an application appropriate for the component, individually or in combination with other equipment. All diagrams and examples in this user's manual are for illustrative purposes only. In no way does including these diagrams and examples in this manual constitute a guarantee as to their suitability for any specific application. To test and approve all programs, prior to installation, is the responsibility of the end user.

RELATED MANUALS

The following manuals related to the FC6A series MicroSmart are available. Refer to them in conjunction with this manual.

Type No.	Manual Name	Description
FC9Y-B1722	FC6A Series MicroSmart All-in-One Type User's Manual	Describes product specifications, installation and wiring instructions, instructions for basic programming operations and special functions, device and instruction lists, communication functions, and troubleshooting procedures for the FC6A Series MicroSmart series.
FC9Y-B1726	FC6A Series MicroSmart LAD Programming Manual	Describes basic operations for programming with ladders on the FC6A Series MicroSmart, monitoring methods, device and instruction lists, and details of each instruction.
FC9Y-B1730	FC6A Series MicroSmart All-in-One Type Communication Manual	Describes specifications related to FC6A Series MicroSmart communication, descriptions of functions, configuration methods, and usage examples.
FC9Y-B1734	FC6A Series MicroSmart PID Module User's Manual (this manual)	Describes PID module specifications and functions.
WindLDR Help		Describes usage instructions for WindLDR, programming software for the FC6A Series MicroSmart series.

NAMES AND ABBREVIATIONS USED IN THIS MANUAL

Model Names

Name Used in This Manual		Type Number, Part Code, or Official Name	
FC6A Series MicroSmart		FC6A Series MICROSmart	
CPU module	All-in-One Type	FC6A-C16R1AE, FC6A-C16R1CE, FC6A-C16K1CE, FC6A-C16P1CE, FC6A-C24R1AE, FC6A-C24R1CE, FC6A-C24K1CE, FC6A-C24P1CE, FC6A-C40R1AE, FC6A-C40R1CE, FC6A-C40K1CE, FC6A-C40P1CE, FC6A-C40R1DE, FC6A-C40R1DE, FC6A-C40K1DE, FC6A-C40P1DE	
	CAN J1939 All-in-One Type	FC6A-C40R1AEJ, FC6A-C40R1CEJ, FC6A-C40K1CEJ, FC6A-C40P1CEJ, FC6A-C40R1DEJ, FC6A-C40K1DEJ, FC6A-C40P1DEJ	
	16-I/O type	The general term for the model with 16 I/O points (FC6A-C16R1AE, FC6A-C16R1CE, FC6A-C16K1CE, FC6A-C16P1CE)	
	24-I/O type	The general term for the model with 24 I/O points (FC6A-C24R1AE, FC6A-C24R1CE, FC6A-C24K1CE, FC6A-C24P1CE)	
	40-I/O type	The general term for the model with 40 I/O points (FC6A-C40R1AE, FC6A-C40R1CE, FC6A-C40K1CE, FC6A-C40P1CE, FC6A-C40R1DE, FC6A-C40R1DE, FC6A-C40K1DE, FC6A-C40P1DE, FC6A-C40R1AEJ, FC6A-C40R1CEJ, FC6A-C40K1CEJ, FC6A-C40P1CEJ, FC6A-C40R1DEJ, FC6A-C40K1DEJ, FC6A-C40P1DEJ)	
	AC power type		FC6A-C16R1AE, FC6A-C24R1AE, FC6A-C40R1AE, FC6A-C40R1AEJ
	DC power type	24V DC power type	FC6A-C16R1CE, FC6A-C24R1CE, FC6A-C40R1CE, FC6A-C16K1CE, FC6A-C24K1CE, FC6A-C40K1CE, FC6A-C16P1CE, FC6A-C24P1CE, FC6A-C40P1CE, FC6A-C40R1CEJ, FC6A-C40K1CEJ, FC6A-C40P1CEJ
		12V DC power type	FC6A-C40R1DE, FC6A-C40K1DE, FC6A-C40P1DE, FC6A-C40R1DEJ, FC6A-C40K1DEJ, FC6A-C40P1DEJ
	Relay output type		FC6A-C16R1AE, FC6A-C16R1CE, FC6A-C24R1AE, FC6A-C24R1CE, FC6A-C40R1AE, FC6A-C40R1CE, FC6A-C40R1DE, FC6A-C40R1AEJ, FC6A-C40R1CEJ, FC6A-C40R1DEJ
	Transistor output type	Transistor sink output type	FC6A-C16K1CE, FC6A-C24K1CE, FC6A-C40K1CE, FC6A-C40K1DE, FC6A-C40K1CEJ, FC6A-C40K1DEJ
Transistor protection source output type		FC6A-C16P1CE, FC6A-C24P1CE, FC6A-C40P1CE, FC6A-C40P1DE, FC6A-C40P1CEJ, FC6A-C40P1DEJ	
Expansion module		Expansion I/O module, functional module, analog module	
Expansion I/O module		Input module, output module, mixed I/O module	
Functional module		Analog module, PID module	
Analog module		Analog input module, analog output module, mixed analog I/O module	
Option module		HMI module, expansion interface module, analog cartridge, communication cartridge	
Cartridge		Analog cartridge, communication cartridge	
WindLDR		WindLDR application software	
USB cable		USB maintenance cable (HG9Z-XCM42), USB Mini-B extension cable (HG9Z-XCE21)	

Name Used in this Manual	WindLDR Operating Procedure
Function area settings	Configuration tab > Function Area Settings group
Monitors	Select Online > Monitor > Start Monitor .
PLC status	Select Online > PLC > Status .
Communication settings	Select Online > Communication > Set Up .
Modbus master request table	On the Configuration tab, in Function Area Settings , click Communication Ports , and in the displayed Function Area Settings dialog box, for Communication Mode under Communication Ports , select Modbus RTU Master or Modbus TCP Client
Application button	The button displayed on the left side of the menu bar. Click to display the menu with New , Save , and Save As , recent projects, WindLDR Options , and Exit WindLDR .

TABLE OF CONTENTS

	Safety Precautions	Preface-1
	About This Manual	Preface-2
	Related Manuals	Preface-3
	Names and Abbreviations Used in this Manual.....	Preface-4
CHAPTER 1:	General Information	
	About the PID Modules.....	1-1
	Quantity of Applicable PID Modules.....	1-1
	System Software.....	1-1
CHAPTER 2:	Module Specifications	
	PID Module	2-1
	Dimensions.....	2-8
CHAPTER 3:	Installation and Wiring	
	Mounting Hole Layout for Direct Mounting on Panel Surface.....	3-1
	Terminal Connection	3-2
CHAPTER 4:	PID Module Main Functions	
	Temperature Control Using the PID Module	4-1
	Fixed Value Control.....	4-4
	Auto-Tuning (AT)/Auto-Reset.....	4-7
	Program Control	4-10
	Heating/Cooling Control	4-14
	Difference Input Control	4-14
	Cascade Control.....	4-15
	External PV Mode.....	4-19
CHAPTER 5:	Device Allocation of PID Module	
	Device Allocation of PID Module.....	5-1
	Control Register	5-2
	Control Relay	5-2
	Data Register Allocation	5-7
CHAPTER 6:	Configuring PID Module Using WindLDR	
	Procedure to configure the PID module	6-1
	Module Configuration Editor Description	6-6
	PID Module Configuration Dialog Box	6-7
	PID Module Configuration - Input Parameters List (CH0 and CH1)	6-8
	PID Module Configuration - Control Parameters List (CH0 and CH1).....	6-13
	PID Module Configuration - Output Parameters List (CH0 and CH1)	6-18
	PID Module Configuration - Program Parameters List (CH0 and CH1).....	6-20
	PID Module Configuration - I/O Function Selections.....	6-22
	PID Module Configuration - Input Parameters Details	6-26
	PID Module Configuration - Control Parameters Details.....	6-36
	PID Module Configuration - Output Parameters Details	6-46
	PID Module Configuration - Program Parameters Details.....	6-48
	Monitoring PID Module.....	6-53
CHAPTER 7:	Application Examples	
	Application Example 1	7-1
	Application Example 2	7-9
	Application Example 3	7-16
CHAPTER 8:	Troubleshooting	
	Countermeasures for Errors and Problems	8-1
APPENDIX		
	PID Module Function References.....	A-1
	Output Action	A-5

CH0, CH1 Output Action of PID, PI, PD, and P Control ActionA-5
CH0, CH1 Output Action of ON/OFF Control ActionA-5
Output Action of Heating/Cooling ControlA-6
Output Action of Heating/Cooling Control with Overlap.....A-7
Output Action of Heating/Cooling Control with Dead Band.....A-8
Factory Default Settings of the PID ModuleA-9

***I*NDEX**

TABLE OF CONTENTS

1: GENERAL INFORMATION

In order to provide an overview of the PID modules, this chapter describes the PID module types and the maximum number of PID modules that can be connected to the CPU module.

Make effective use of the PID modules after reading and understanding thoroughly functions and characteristics.

About the PID Modules

The PID module performs control actions to eliminate the deviation between the set point (SP) and process variable (PV). The PID module, which is an expansion module, is required to connect to the FC6A Series MicroSmart for use. Depending on the difference of output specifications, the PID modules are categorized into two types.

The input channel can accept voltage, current, thermocouple or resistance thermometer signals. The output channel generates relay output, non-contact voltage (for SSR drive), or current signals.

To configure the PID modules, the **Expansion Modules Configuration** dialog box in WindLDR is used.

The following table shows the PID module type numbers.

PID Module Type Numbers

Module Type	I/O Points	I/O Signal	Type No.
Relay Output	2 inputs	Thermocouple [K, J, R, S, B, E, T, N, PL- II, C (W/Re5-26)] Resistance thermometer (Pt100, JPt100) Voltage (0 to 1V DC, 0 to 5V DC, 1 to 5V DC, 0 to 10V DC) Current (0 to 20mA DC, 4 to 20mA DC)	FC6A-F2MR1
	2 outputs	Relay contact	
Non-Contact Voltage (for SSR drive)/ Current Output	2 inputs	Thermocouple [K, J, R, S, B, E, T, N, PL- II, C (W/Re5-26)] Resistance thermometer (Pt100, JPt100) Voltage (0 to 1V DC, 0 to 5V DC, 1 to 5V DC, 0 to 10V DC) Current (0 to 20mA DC, 4 to 20mA DC)	FC6A-F2M1
	2 outputs	Non-contact voltage (for SSR drive)/Current	

Quantity of Applicable PID Modules

The maximum number of PID modules that can be connected to the FC6A Series MicroSmart CPU differs depending on the CPU type. For details about the maximum number of PID modules that can be connected to the CPU modules, see Chapter 9 "Functional Modules" in the "FC6A Series MicroSmart All-in-One Type User's Manual".

System Software

The PID module system software can be upgraded to the latest version of the system software using WindLDR.

For how to upgrade to the latest version of the system software, see Appendix "System Software" in the "FC6A Series MicroSmart All-in-One Type User's Manual".

2: MODULE SPECIFICATIONS

This chapter describes parts names, functions, specifications, and dimensions of the PID modules.

PID Module

Parts Description

Example: FC6A-F2M1

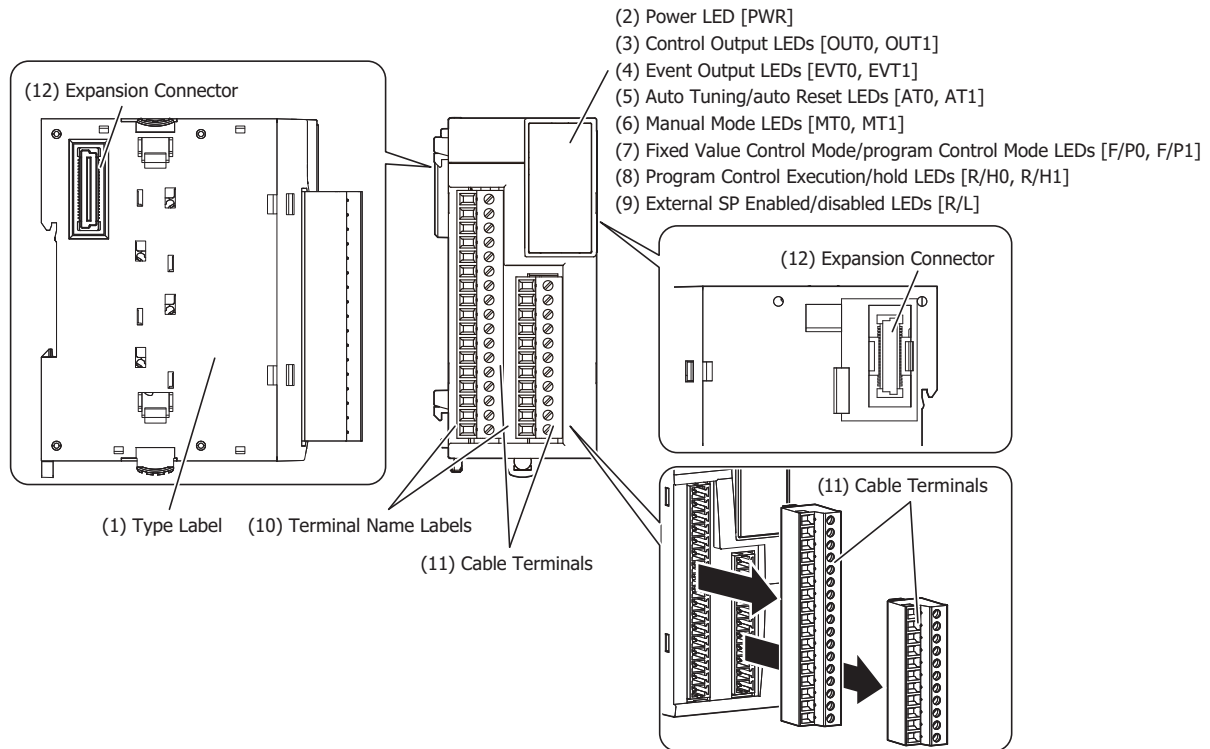

The content in brackets is the LED indicator name on the PID module.

LED Indicators

PWR	□	(2)
OUT0	□	(3)
EVT0	□	(4)
AT0	□	(5)
MT0	□	(6)
F/P0	□	(7)
R/H0	□	(8)
R/L	□	(9)
OUT1	□	(3)
EVT1	□	(4)
AT1	□	(5)
MT1	□	(6)
F/P1	□	(7)
R/H1	□	(8)

2: MODULE SPECIFICATIONS

(1) Type Label

Indicates the PID module type No. and specifications.

(2) Power LED (PWR)

ON : Power is normally supplied.

Flashes : External power supply (24V DC) error.

OFF : Power is not supplied.

(3) Control Output LED (OUT0, OUT1)

ON : Control output is turned on.

OFF : Control output is turned off.

Flashes : When current output is used, the LED flashes in a cycle of 100 ms according to the duty ratio of the output manipulated variable (MV). When output manipulated variable (MV) is 20%, the LED turns on for 20 ms and off for 80 ms continuously.

(4) Event Output LED (EVT0, EVT1)

ON : Any alarm out of alarm 1 to alarm 8, loop break alarm is triggered.

OFF : None of the alarms is triggered.

(5) Auto-tuning (AT)/Auto-reset LED (AT0, AT1)

Flashes : Auto-tuning (AT) or auto-reset is performing.

OFF : Auto-tuning (AT) or auto-reset is stopped.

(6) Manual Mode LED (MT0, MT1)

ON : Manual mode

OFF : Auto mode

(7) Fixed Value Control Mode/Program Control Mode LED (F/P0, F/P1)

ON : Program control mode

OFF : Fixed value control mode

(8) Program Control RUN/HOLD LED (R/H0, R/H1)

ON : Program control is performing, or while in fixed value control enabled.

Flashes : When recovering from a power interruption during program control hold or program control.

OFF : Program control is stopped, or while in fixed value control disabled.

(9) External SP Enable/Disable LED (R/L)

ON : External SP input is enabled.

OFF : External SP input is disabled.

(10) Terminal Name Label

Indicates terminal numbers.

(11) Cable Terminals

These terminals are for connecting cables. Terminal block type (3.81 mm pitch), spring clamp system.

(12) Expansion Connector

Connects to the CPU module and other expansion modules.

Power Supply Specifications

Type No.		FC6A-F2M1	FC6A-F2MR1
External Power	Power Supply Voltage	24V DC	
	Allowed Fluctuation Range	20.4 to 28.8V DC	
Terminal Arrangement		See "Terminal Arrangement and Wiring Examples" on page 2-7	
Connector	Connector on Mother Board	ECH381R-11P-BK, ECH381R-17P-BK	
	Insertion/Removal Durability	100 times minimum	
Module	5V DC	65 mA	65 mA
Internal Current Draw	24V DC	0 mA	0 mA
Module External Power Supply Current Draw		150 mA (24V DC)	150 mA (24V DC)

Function Specifications

■ **Input Specifications**

Type No.		FC6A-F2M1, FC6A-F2MR1		
Input Type and Input Range	Voltage	0 to +10V DC		
		0 to +5V DC		
	Current	1 to +5V DC		
		0 to +1V DC		
	Thermocouple	K	-200 to 1,370°C	-328 to 2,498°F
		K (with decimal point)	-200.0 to 400.0°C	-328.0 to 752.0°F
		J	-200 to 1,000°C	-328 to 1,832°F
		R	0 to 1,760°C	32 to 3,200°F
		S	0 to 1,760°C	32 to 3,200°F
		B	0 to 1,820°C	32 to 3,308°F
		E	-200 to 800°C	-328 to 1,472°F
		T	-200.0 to 400.0°C	-328.0 to 752.0°F
		N	-200 to 1,300°C	-328 to 2,372°F
		PL-II	0 to 1,390°C	32 to 2,534°F
C (W/Re5-26)	0 to 2,315°C	32 to 4,199°F		
Resistance Thermometer	Pt100	-200 to 850°C	-328 to 1,562°F	
	Pt100 (with decimal point)	-200.0 to 850.0°C	-328.0 to 1,562.0°F	
	JPt100	-200 to 500°C	-328 to 932°F	
	JPt100 (with decimal point)	-200.0 to 500.0°C	-328.0 to 932.0°F	
Input Impedance	Voltage	1 MΩ or higher (0 to 1 V range) 100 kΩ or higher (other range)		
	Current	50 Ω or lower		
	Thermocouple	1 MΩ or higher		
	Resistance Thermometer	1 MΩ or higher		
AD Conversion	Sample Duration Time	100 ms		
	Sample Repetition Time	100 ms		
	Total Input Delay Time*1	Sample duration time + Sample Repetition Time + 1 scan time		
	Type of Input	Single-ended input		
	Operation Mode	Self-scan		
Conversion Method	ΣΔ type ADC			

2: MODULE SPECIFICATIONS

Type No.		FC6A-F2M1, FC6A-F2MR1			
Input Error	Maximum Error at 25°C	Thermocouple	Within ±0.2% of full scale or ±2°C (4°F), whichever is larger Cold junction compensation accuracy: ±1.0°C or lower Exceptions: R, S: 0 to 200°C (0 to 400°F) is within ±6°C (12°F) B: Not possible to guarantee accuracy (0 to 300°C (0 to 600°F)) K, J, E, T, N: +/-0.4% of full scale (less than 0°C (32°F))		
		Resistance Thermometer	Within ±0.1% of full scale or ±1°C (2°F), whichever is larger		
		Voltage/Current	Within ±0.2% of full scale		
		Temperature Coefficient	±0.005% of full scale/°C		
Data	Digital Resolution	Voltage	12,000 (14 bits)		
		Current	12,000 (14 bits)		
		Thermocouple		Celsius (°C)	Fahrenheit (°F)
			K	1,570	2,826
			K (with decimal point)	6,000	10,800
			J	1,200	2,160
			R	1,760	3,169
			S	1,760	3,169
			B	1,820	3,277
			E	1,000	1,800
			T	6,000	10,800
			N	1,500	2,700
			PL-II	1,390	2,503
	C (W/Re5-26)	2,315	4,168		
	Resistance Thermometer		Celsius (°C)	Fahrenheit (°F)	
		Pt100	1,050	1,890	
		Pt100 (with decimal point)	10,500	18,900	
		JPt100	700	1,260	
	JPt100 (with decimal point)	7,000	12,600		
	Input Value per Step	Voltage	0 to +10V DC: 0.83 mV 0 to +5V DC: 0.416 mV 1 to +5V DC: 0.333 mV 0 to +1V DC: 0.083 mV		
Current		4 to 20mA DC: 1.333 µA 0 to 20mA DC: 1.666 µA			
Thermocouple		Type	Input Value per Step		
		K	1°C (°F)		
		K (with decimal point)	0.1°C (°F)		
		J	1°C (°F)		
		R	1°C (°F)		
		S	1°C (°F)		
		B	1°C (°F)		
		E	1°C (°F)		
		T	0.1°C (°F)		
		N	1°C (°F)		
		PL-II	1°C (°F)		
C (W/Re5-26)	1°C (°F)				

Type No.	FC6A-F2M1, FC6A-F2MR1			
Data	Input Value per Step	Resistance Thermometer	Type	Input Value per Step
			Pt100	1°C (°F)
			Pt100 (with decimal point)	0.1°C (°F)
			JPt100	1°C (°F)
	JPt100 (with decimal point)	0.1°C (°F)		
Data Type in Application Program			Can be arbitrarily set for each CH in a range between -32,768 to 32,767*1	
Monotonicity			Yes	
Input Data Out of Range			Detectable*2	
Noise Resistance	Maximum Temporary Deviation during Electrical Noise Tests		±4% or less of full scale	
	Input Filter		Yes	
	Recommended Cable for Noise Immunity		Current/voltage: Twisted pair shielded cable Other: Twisted pair cable	
	Crosstalk		None	
Isolation	Between Input and Power Circuit		Transformer isolated	
	Between I/O and Internal Circuit		Photocoupler isolated	
	Between Inputs		Photocoupler isolated	
Effect of Improper Input Connection			No damage	
Maximum Permanent Allowed Overload (No Damage)			15V DC or lower (0 to 1 V range is 5V DC or lower), 50 mA or lower	
Selection of Analog Input Signal Type			Using programming software	
Calibration or Verification to Maintain Rated Accuracy			Not possible	

*1 The arbitrary setting is a function that uses the digital resolution data by scaling it to arbitrary data (that arbitrarily sets the lower limit value and the upper limit value). The range setting (-32,768 to 32,767) is specified with data registers.

Example: When -5 V is input, 1,024 is displayed as long as the arbitrary setting is not configured, but -500 is displayed when the arbitrary setting is configured as upper limit value = 1,000 and lower limit value = -1,000, and this makes it easier to intuitively read the input voltage value.

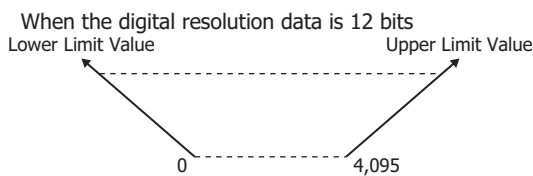

*2 Input data out of range is reflected in the status of the analog module.

Input Internal Circuit

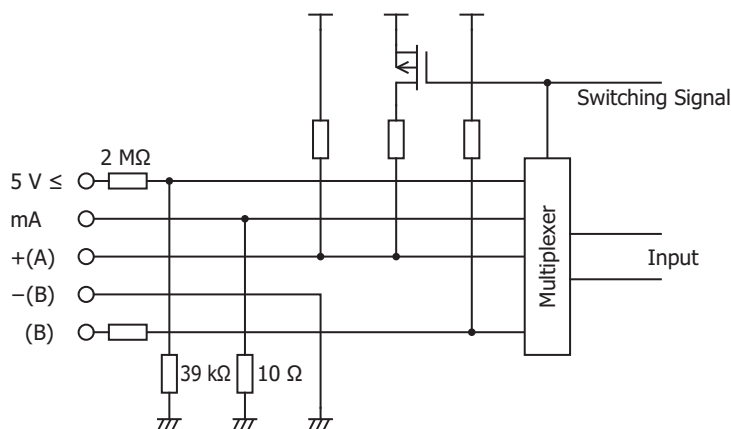

2: MODULE SPECIFICATIONS

■ Output Specifications

Type No.		FC6A-F2M1	FC6A-F2MR1	
Output Type and Output Range	Digital Output	Transistor protection source output (12V DC output)	Relay output	
	Analog Output	4 to 20 mA	—	
Load	Digital Output	Max 40 mA (12V DC)	—	
	Analog Output	550 Ω or lower	—	
	Relay Output	—	—	5 A 250V AC (resistive load)
				5 A 30V DC (resistive load)
				3 A 250V AC (inductive load $\cos\phi=0.4$)
3 A 30V DC (inductive load $L/R=7$ ms)				
Load Type	Resistive load	Resistive load/inductive load		
DA Conversion	Analog Output Settling Time	80 ms	—	
	Digital Output Delay Time	Turn OFF time: 10 ms Turn ON time: 5 ms	—	
	Relay Output Delay Time	—	Turn OFF time: 15 ms Turn ON time: 15 ms (including bounce)	
	Total Output System Transfer Time	Analog output: Settling time + input sample duration time (100 ms) Digital output/relay output: Output delay time + proportional cycle (1 to 120 sec)		
Output Error	Maximum Error at 25°C	±0.5% of full scale		
	Temperature Coefficient	±0.01% of full scale/°C		
	Output Ripple	±0.2% or less of full scale		
	Overshoot	0%		
Data	Digital Resolution	1,000 steps (10 bits)		
	Output Value of LSB	0.0016 mA (4 to 20 mA)		
	Monotonicity	Yes		
	Current Loop Open	Not detectable		
Noise Resistance	Maximum Temporary Deviation during Electrical Noise Tests	±4% or less of full scale		
	Recommended Cable for Noise Immunity	Current/voltage: Twisted pair shielded cable		
	Crosstalk	1 LSB		
Isolation	Between Output and Power Circuit	Transformer isolated		
	Between Output and Internal Circuit	Photocoupler isolated		
Effect of Improper Output Connection		No damage		
Selection of Output Type and Output Range		Using programming software		
Calibration or Verification to Maintain Rated Accuracy		Not possible		

Output Internal Circuit

FC6A-F2M1 (non-contact voltage output (to drive SSRs))

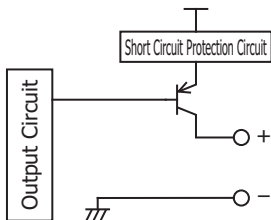

FC6A-F2M1 (current output)

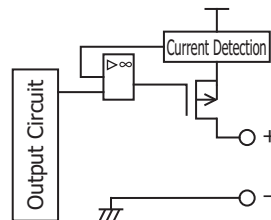

FC6A-F2MR1

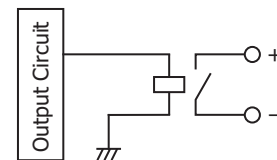

2: MODULE SPECIFICATIONS

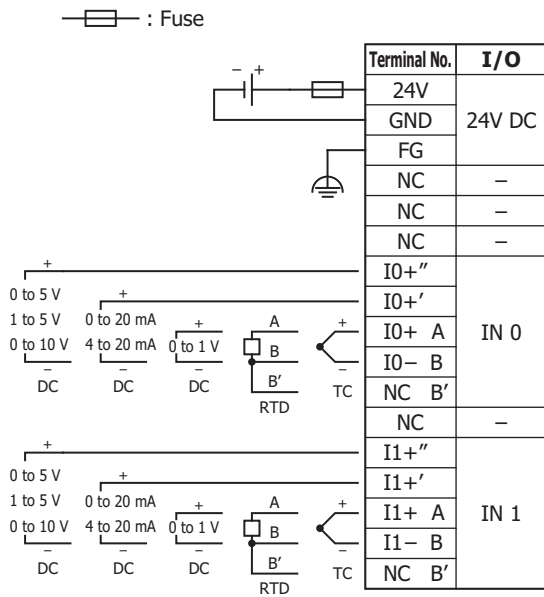

DC : Voltage/current
 RTD : Resistance Thermometer
 TC : Thermocouple
 —(L)— : Load
 —(X)— : Analog Current Input Device
 —|— : Fuse

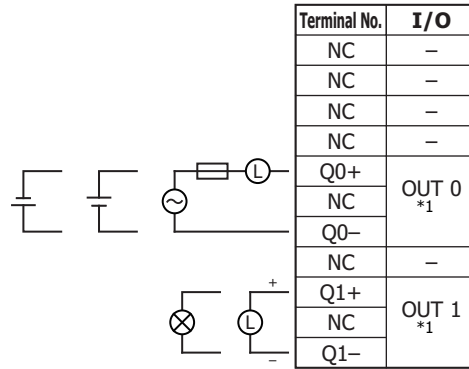

*1 OUT0: Relay output and OUT1: Non-contact voltage/current output connection examples are shown. There are no models with both types of specifications.

Dimensions

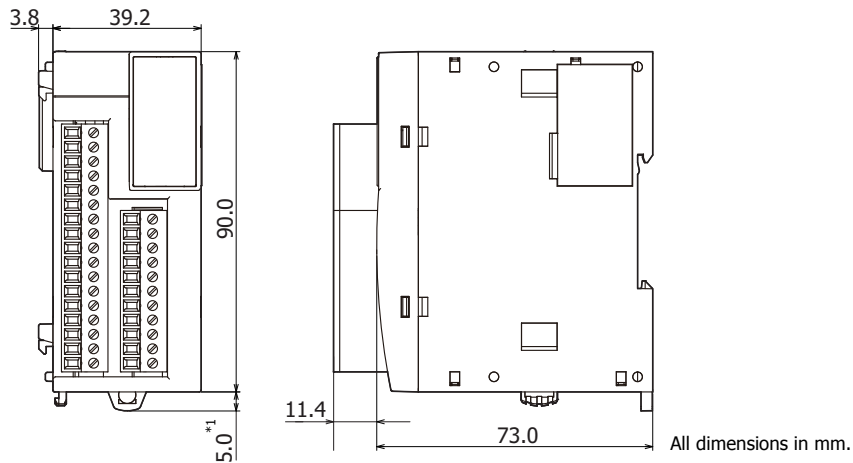

*1 9.3 mm when the clamp is pulled out.

3: INSTALLATION AND WIRING

This chapter describes how to install and wire the PID modules. For installation methods and precautions for installation and wiring, see Chapter 3 "Installation and Wiring" in the "FC6A Series MicroSmart All-in-One Type User's Manual".

Be sure to use the PID modules properly after understanding installation and wiring thoroughly.

	<p>Caution</p> <ul style="list-style-type: none"> Assemble the CPU module and PID modules before installing them on a DIN rail. Otherwise, they may break. Do not lay out or wire the modules while power is supplied to them. Otherwise, they may be damaged. When installing modules, follow the instructions described in the "FC6A Series MicroSmart All-in-One Type User's Manual". If there are flaws in the installation, it may cause disattachment, failure or malfunction.
---	--

Mounting Hole Layout for Direct Mounting on Panel Surface

As shown in the following diagram, mount the PID module to the mounting plate with M4 screws.

Always give sufficient consideration to operability, ease-of-maintenance, and environmental resistance when deciding on the mounting position.

	<p>Caution When directly mounting the PID module, tighten the mounting screws with 1 N·m (kgf·cm) of torque.</p>
---	---

For details on the direct mounting hooks (maintenance part), see the FC6A Series MicroSmart All-in-One Type User's Manual.

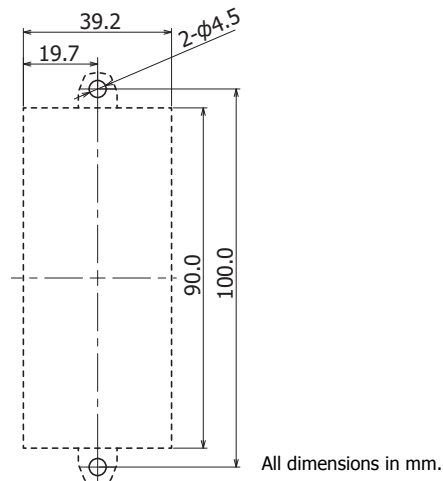

Example: Mounting hole layout for FC6A-C40R1AE and four PID modules

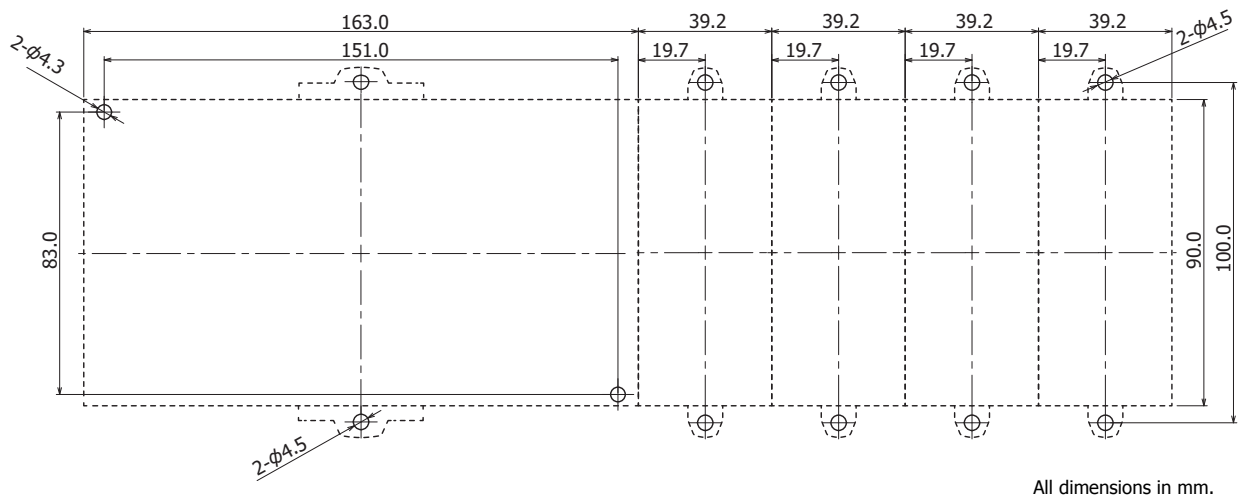

Terminal Connection

This section describes types of terminals and how to use them.

- When connecting stranded wire or multiple solid wires to a terminal block, use appropriate ferrule for the terminal block. For details, see "Recommended Ferrule List" on page 3-3.
- 1-wire and 2-wire ferrules can be used with the FC6A Series MicroSmart.

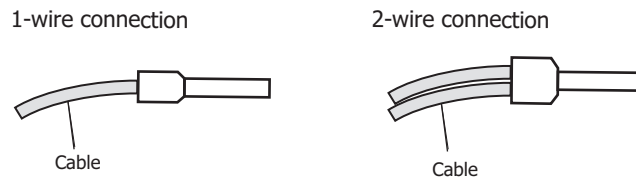

Terminals for Terminal Blocks

Crimp ferrules using an appropriate tool according to the size of ferrules. Cut the end of the wire to the same length or about 0.5 mm longer than the ferrule.

Ensure that the core wire does not protrude at the end of the shield and there are no whiskers.

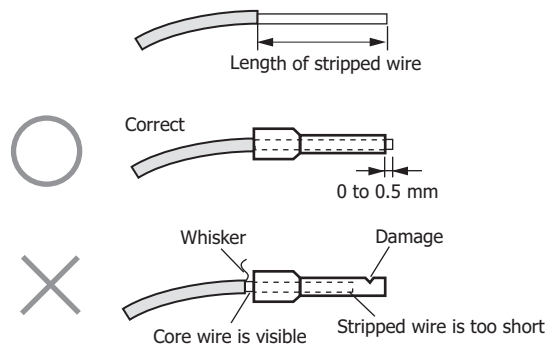

- The thickness and stripping length of stranded wire and single wire differs according to the connectors that will be used. For wire thickness, see "Recommended Ferrule List" on page 3-3.
- Single wire assumes the use of one wire. Do not attach two or more wires to the one connector hole.

Recommended Ferrule List

The following ferrules can be used with the FC6A Series MicroSmart.

The recommended ferrules are manufactured by Phoenix Contact.

PID Module Terminals				3.81 mm Pitch	
Model				FC6A-F2MR1, FC6A-F2M1	
Wire Type				UL1007 UL2464	UL1015
Stripping length (mm)				9	
Wire thickness (mm ²)				0.14 to 1.50	
Wire gauge	AWG 24	1-wire usage	AI 0,25- 6 (3203040)	—	—
			AI 0,25- 8 (3203037)	Yes	—
			AI 0,25-10 (3241128)	Yes	—
	AWG22	1-wire usage	AI 0,34- 6 (3203053)	—	—
			AI 0,34- 8 (3203066)	Yes	—
			AI 0,34-10 (3241129)	Yes	—
	AWG20	1-wire usage	AI 0,5- 6 (3200687)	—	—
			AI 0,5- 8 (3200014)	Yes	—
			AI 0,5- 8 GB (1208966)	—	Yes
			AI 0,5-10 (3201275)	Yes	—
			AI 0,5-10 GB (3203150)	—	Yes
		2-wire usage	AI-TWIN 2 x 0,5-8 (3200933)	—	—
			AI-TWIN 2 x 0,5-10 (3203309)	Yes	—
	AWG18	1-wire usage	AI 0,75- 6 (3200690)	—	—
			AI 0,75- 8 (3200519)	—	—
			AI 0,75-10 (3201288)	—	—
			AI 1-8 (3200030)	—	—
			AI 1-10 (3200182)	—	—
		2-wire usage	AI-TWIN 2 x 0,75-8 (3200807)	—	—
			AI-TWIN 2 x 0,75-10 (3200975)	—	—
	AWG16	1-wire usage	AI 1,5- 6 (3200755)	—	—
			AI 1,5- 8 (3200043)	—	—
			AI 1,5-10 (3200195)	—	—
		2-wire usage	AI-TWIN 2 x 1,5-8 (3200823)	—	—
Screwdriver			SZS 0.4x2.5 (1205037)	Yes	
			SZS 0.6x3.5 (1205053)	—	
Tightening torque (N)				0.22 to 0.25	

Crimping Tool

The following crimping tool can be used with FC6A Series MicroSmart.

Tool Name	Phoenix Contact Model Number (order number)
Crimping tool	CRIMPFOX 6 (1212034)

 <p>Caution</p>	<ul style="list-style-type: none"> Do not touch live terminals. There is a risk of electric shock. When powered, the terminals that are connected to external devices may become hot. Do not touch the terminals immediately after turning the power off. Do not touch the power supply terminals immediately after turning the power off. There is a risk of electric shock. Insert the wire all the way to the tip of the ferrule and crimp it. When connecting stranded wire or multiple wires to a terminal block, use a ferrule. Otherwise there is a risk of wires becoming disconnected.
---	--

3: INSTALLATION AND WIRING

Precautions when Supplying Power to the PID Module

When the PID module and the CPU module are set to the same power supply, the PID module will be initialized for a maximum of approximately 5 seconds after the power is turned on and the CPU module is set to run, so the parameters will not be stable. Always enable control after the module status flag changes to "0001H" (operating normally).

Wiring PID Module Power and I/O Lines

Separate I/O lines (resistance thermometers in particular) from power lines as much as possible to reduce the effect of noise.

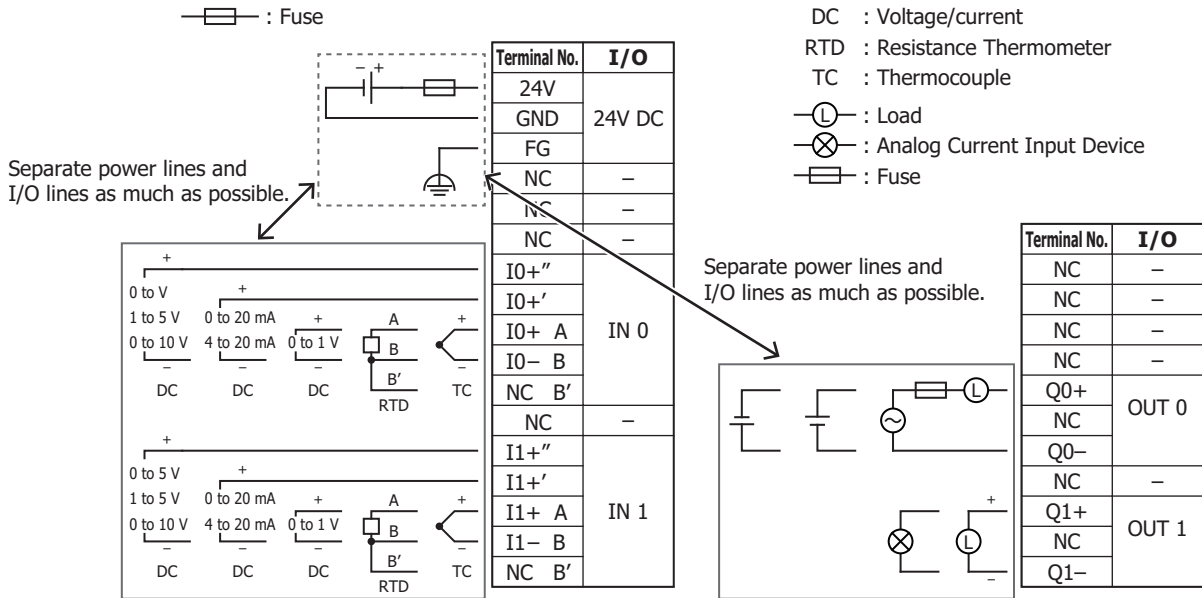

4: PID MODULE MAIN FUNCTIONS

This chapter describes the temperature control, fixed value control, auto-tuning (AT), program control, heating/cooling control, difference input control, and cascade control of the PID module.

Temperature Control Using the PID Module

Temperature Control Configuration Example Using the PID Module

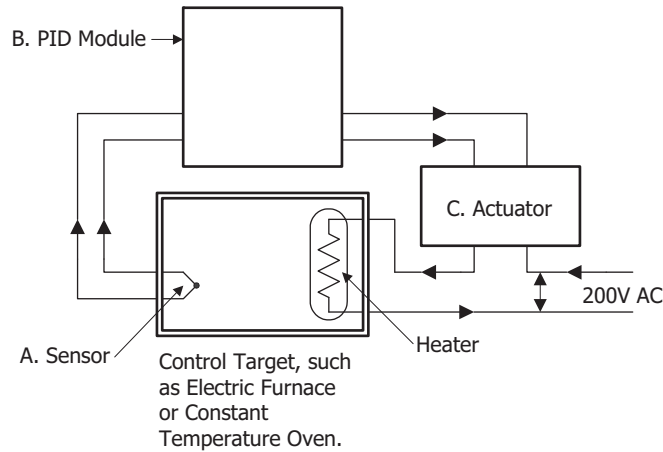

A. Sensor

Measures temperature of the control target. Thermocouple, resistance thermometer, voltage input, or current input can be used as the sensor.

B. PID module

Receives the temperature measured by the sensor as the process variable (PV), and calculates the output manipulated variable (MV) so that temperature difference (deviation) between the process variable (PV) and the set point (SP) can be eliminated. The output manipulated variable (MV) is outputted to the actuator as a control signal. Relay output, non-contact voltage output, or 4 to 20 mA analog current can be used as the control signal.

C. Actuator

Receives a control signal from the PID module and turns on the load power supply to the heater. Electromagnetic switches, SSR, or power controllers can be used as the actuator.

Optimal Temperature Control

The ideal temperature control, as shown in Figure 1, is to control the temperature to correspond with the set point (SP) regardless of any disturbances. There should be no overshoot or response delay of time until the temperature reaches the set point (SP).

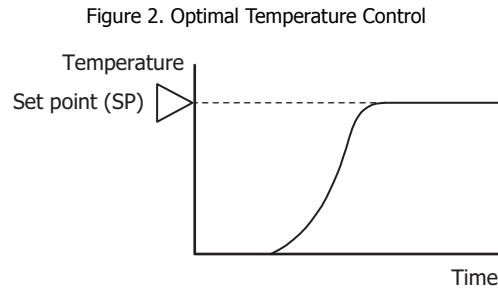
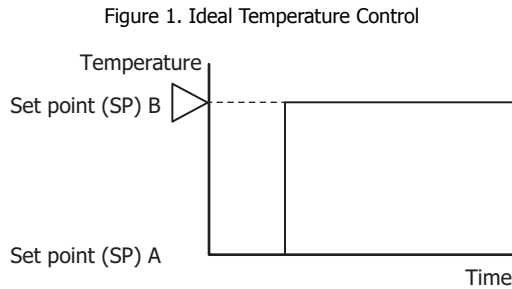

In reality, the ideal temperature control shown in Figure 1 on the previous page is almost impossible to achieve due to a number of complicated factors such as thermal capacity, static characteristics, dynamic characteristics and disturbances.

Figure 2 is regarded as an optimal temperature control result. Depending on the usage and objective, for some temperature control applications, suppression of overshoot is required even if the temperature rises very slowly as shown in Figure 3. For some temperature control applications, it is necessary to stabilize the temperature as quickly as possible by raising the temperature rapidly even if overshoot is generated as shown in Figure 4. In general, however, Figure 2 is regarded as an optimal temperature control. The PID module is designed to raise the process variable (PV) to the set point (SP) as quickly as possible in order to stabilize the process variable (PV) at the set point (SP) so as to perform the optimal temperature control. If the temperature fluctuates due to sudden disturbances, the PID module responds to the fluctuation with speedy response in the shortest possible time and performs quick control to stabilize the temperature.

Figure 3. Stable but slow temperature rise control

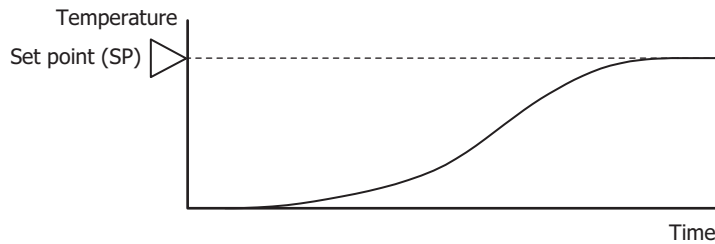
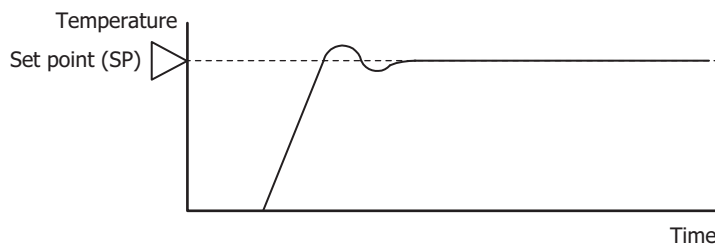

Figure 4. The temperature rises rapidly; however, the control stabilizes after overshoot and undershoot.



Characteristics of the Control Target

To perform optimal temperature control, it is necessary to have a good knowledge of the thermal characteristics of the PID module, sensors, actuators as well as control targets. For example, the PID module controls a constant temperature oven and its temperature can rise up to 100°C. Even if the set point (SP) of the PID modules is configured as 200°C, the temperature of the constant temperature oven rise only up to 100°C due to its static characteristic.

The characteristic of the control target is determined by the combination of the following 4 factors.

1. Thermal capacity:

This represents how the target is easily heated, and has a relation with the volume size of the control target.

2. Static characteristic:

This represents the capability of heating, and is determined by the size of the heater capacity.

3. Dynamic characteristic:

This represents the rising characteristic (transitional response) during initial heating. This is a complicated process involving heater capacity, furnace capacity size and sensor location.

4. Disturbance:

Any change in control temperature causes disturbance. For example, the change of ambient temperature or supply voltage can cause disturbance.

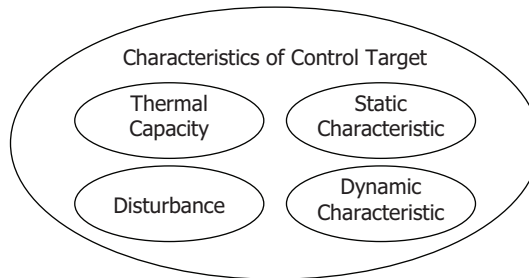

Fixed Value Control

The PID module provides 2 control modes, one is the fixed value control and the other is the program control.

The fixed value control is a standard temperature control which performs to eliminate the deviation between the single set point (SP) and process variable (PV). The program control allows you to define the set point (SP) that changes as the time progresses so that the process variable (PV) can be controlled to match the set point (SP) changing as the time progresses. For details, see "Program Control" on page 4-10.

Control actions that can be used for fixed value control and program control are described below.

ON/OFF Control Action

In the ON/OFF control action, when the process variable (PV) is lower than the set point (SP), the control output is turned on, and when the process variable (PV) exceeds the set point (SP), the control output is turned off. Overshoot, undershoot, and hunting are generated. ON/OFF control is suitable for processes which do not require accuracy.

If the proportional band or proportional gain of the PID module parameter is set to 0, the control action becomes ON/OFF control.

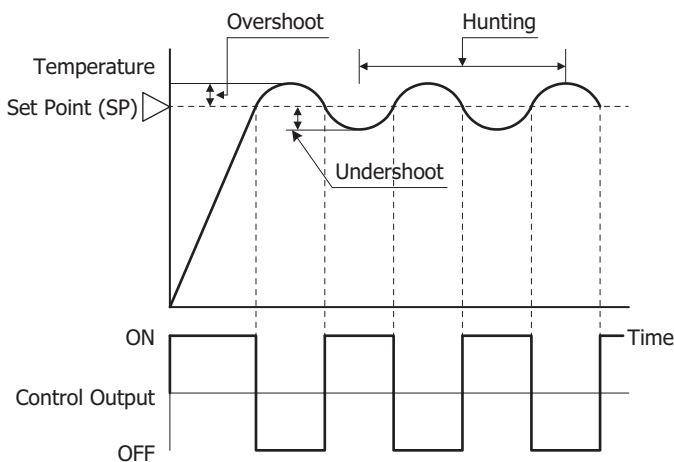

Overshoot, Undershoot

As the temperature of the control target rises as shown in the figure on the right, the process variable (PV) sometimes exceeds the set point (SP) greatly.

This is called overshoot. If the process variable (PV) drops below the set point (SP), this is called undershoot.

Hunting

The control result oscillates as shown in the figure on the right. This is the hunting.

P Control Action (Proportional Action)

P control action outputs the manipulated variable (MV) in proportion to the deviation between the process variable (PV) and the set point (SP) within the proportional band. The control output is ON until the process variable (PV) reaches the point A that is determined by the proportional band. If the process variable (PV) exceeds the point A (enters the proportional band), the control output starts turn on/off according to the control period and the manipulated variable (MV). If the process variable (PV) exceeds the set point (SP), the control output is completely turned off. While the process variable (PV) rises from the point A to the set point (SP), the control output ON time decreases and the control output OFF time increases. Compared to ON/OFF control action, there is no overshoot in P control action, and hunting becomes less frequent; however, the offset is generated. The P control action is suitable for processes such as gas pressure control or level control.

If the integral time and derivative time of the PID module parameter are set to 0, the control action becomes the P control action.

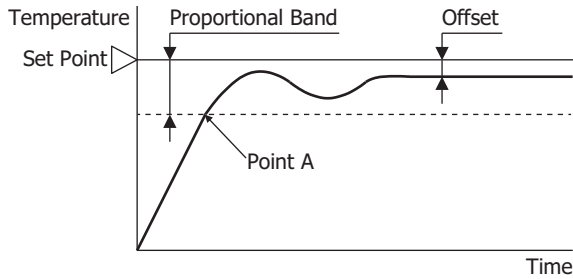

- If the proportional band is narrowed (Proportional gain is made larger)
Because the control output starts turning on/off at around the set point (SP), the time until the process variable (PV) reaches the set point (SP) is shortened, and the offset is small; however, hunting is frequent. If the proportional band is greatly narrowed, the control action becomes similar to the ON/OFF control action.
- If the proportional band is broadened (Proportional gain is made smaller)
Because the control output starts turning on/off at the significantly low temperature from the set point (SP), overshoot or hunting is reduced; however, it takes time for the process variable (PV) to reach to the set point (SP), and the offset between the process variable (PV) and the set point (SP) becomes broadened.

The offset caused by the P control action can be corrected by configuring the reset value. If the reset value is configured, the proportional band range can be shifted as shown in the figure below. The reset value can be automatically calculated by the auto-reset function.

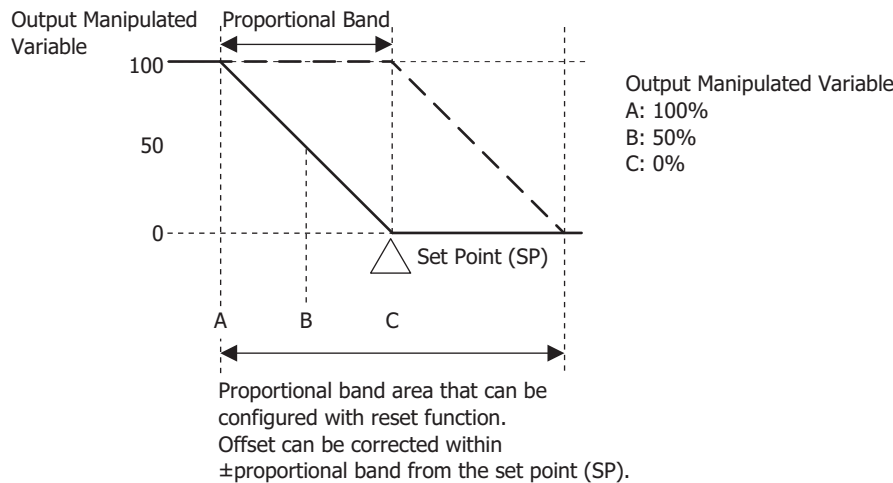

4: PID MODULE MAIN FUNCTIONS

PI Control Action (Proportional + Integral Action)

I (Integral) action automatically corrects the offset caused by P control action, and temperature control is performed at the set point (SP). However, it takes time for the process variable (PV) to be stable if the process variable (PV) is changed rapidly due to disturbance. PI control action is suitable for the processes in which the temperature slowly changes.

If the derivative time of the PID module parameter is set to 0, the control action becomes the PI control action.

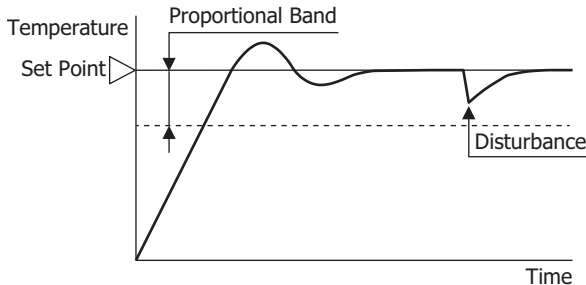

- If the integral time is shortened too much, the integral action becomes strong. The offset can be corrected in a shorter time; however, hunting with a long cycle may be caused.
- If the integral time is extended too much, the integral action becomes weak and it takes time to correct the offset.

PD Control Action (Proportional + Derivative Action)

Compared with P action, the response to rapid temperature change due to disturbance is faster, the temperature control can be stabilized in a shorter time, and transitional response characteristic can be improved in PD control action. PD control action is suitable for the processes in which the temperature rapidly changes.

If the integral time of the PID module parameter is set to 0, the control action becomes the PD control action.

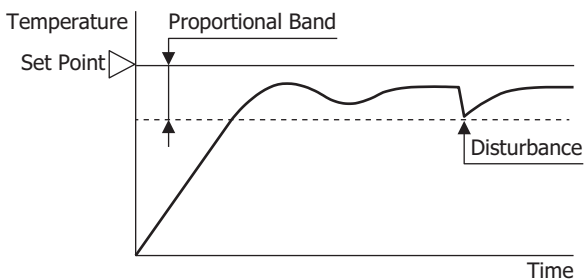

- If the derivative time is shortened, the derivative action becomes weak. The response to the rapid temperature change becomes slower. Because the action to suppress the rapid temperature rises becomes weaker, the time for the process variable (PV) to reach the set point (SP) is shortened; however, overshoot can occur.
- If the derivative time is extended, the derivative action becomes strong. The response to the rapid temperature change becomes faster. Because the action to suppress the rapid temperature rises becomes strong, the time for the process variable (PV) to reach the set point (SP) is extended; however, overshoot can be decreased.

The offset caused by the PD control action can be corrected by configuring the reset value. The reset value can be automatically calculated by the auto-reset function.

PID Control Action (Proportional + Integral + Derivative Action)

P action suppresses the overshoot and the hunting, I action corrects the offset, and D action corrects rapid temperature change due to disturbance in shorter time. Thus, using PID control action, optimal temperature control can be performed. The proportional band, integral time, derivative time, and ARW can be automatically calculated by the auto-tuning (AT).

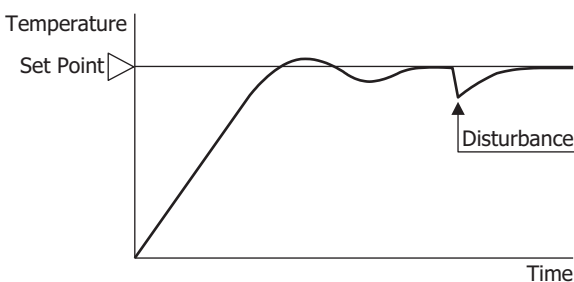

Auto-Tuning (AT)/Auto-Reset

The optimal temperature control parameters differ depending on the characteristics of the process to control. For PID control action, the proportional band, integral time, derivative time, and ARW*¹ are automatically configured by performing auto-tuning (AT). For P control or PD control action, the reset value is automatically configured by performing auto-reset.

*1 For details, see "(9) Control Register+29: ARW (Anti-Reset Windup)" on page 6-39.

Auto-tuning (AT)

In order to configure P (proportional band), I (integral time), D (derivative time), and ARW (Anti-Reset Windup) automatically with optimal values, the auto-tuning (AT) can be performed. The auto-tuning (AT) gives temperature fluctuation to the process to calculate those parameters. To perform an optimal auto-tuning (AT), temperature fluctuation is given to the process when the process variable (PV) reaches near the set point (SP). By setting the AT bias, the temperature to start giving fluctuation can be configured. The relation between the set point (SP), AT bias, auto-tuning (AT) starting point, and fluctuation starting point are shown below.

 Caution	<ul style="list-style-type: none"> • Perform auto-tuning (AT)/auto-reset during the trial run. • If the auto-tuning (AT) is performed near the ambient temperature, sufficient fluctuations cannot be given to the process, and auto-tuning (AT) may fail. In such case, configure the P, I, D, and ARW values manually. • Perform auto-reset when the process variable (PV) is stabilized within the proportional band. • Once auto-tuning (AT)/auto-reset is performed, it is unnecessary to perform auto-tuning (AT)/auto-reset again as long as the process is unchanged. • When voltage or current input is selected and the auto-tuning (AT) is performed, fluctuations are given to the process at the set point (SP) regardless of AT bias. • During program control, fluctuations are given to the process as soon as auto-tuning (AT) is started.
--	---

[Process variable (PV) ≤ Set point (SP) - AT bias value]

When AT bias is set to 20°C, the PID module starts giving the temperature fluctuation to the process at the temperature 20°C lower from the set point (SP).

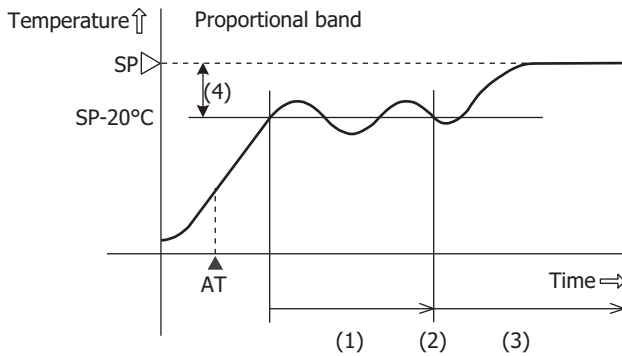

- (1) Fluctuation period. PID parameters are measured.
- (2) PID parameters are calculated and auto tuning (AT) is finished.
- (3) Temperature is controlled with the PID parameters configured with auto-tuning (AT).
- (4) AT bias value (20°C)

▲ AT: Auto-tuning (AT) perform bit is turned on

[Set point (SP) - AT bias value < Process variable (PV) < Set point (SP) + AT bias value]

The PID module starts giving the temperature fluctuation to the process when the process variable (PV) reaches the set point (SP).

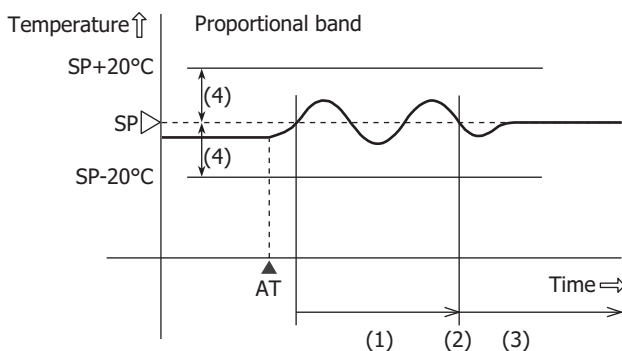

- (1) Fluctuation period. PID parameters are measured.
- (2) PID parameters are calculated and auto tuning (AT) is finished.
- (3) Temperature is controlled with the PID parameters configured with auto-tuning (AT).
- (4) AT bias value (20°C)

▲ AT: Auto-tuning (AT) perform bit is turned on

4: PID MODULE MAIN FUNCTIONS

[Process variable (PV) ≥ Set point (SP) + AT bias value]

When AT bias is set to 20°C, the PID module starts giving the temperature fluctuation to the process at the temperature 20°C higher from the set point (SP).

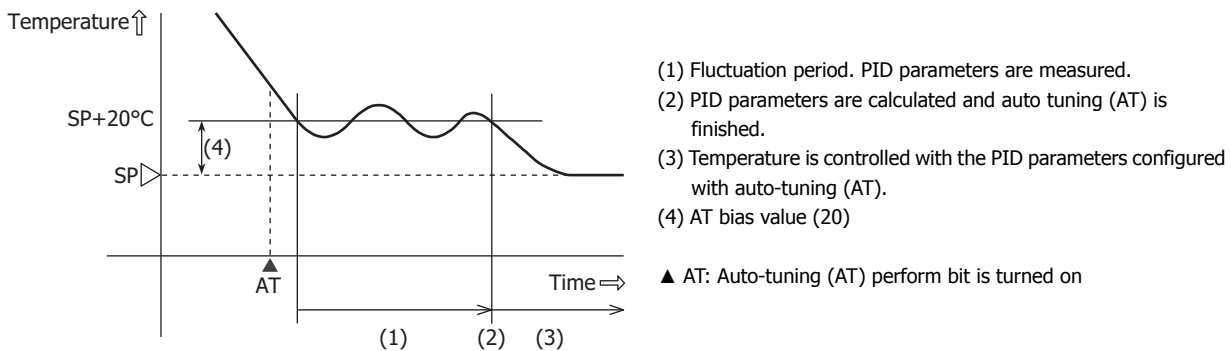

Auto-reset

During the P control or PD control action, the deviation (offset) between the process variable (PV) and the set point (SP) is generated when the process variable (PV) is stabilized. By performing auto-reset, the reset value can automatically be calculated to correct the offset. It is required to perform auto-reset when the process variable (PV) is stabilized within the proportional band. When the auto-reset is completed, the CPU module automatically reads all parameters including the calculated reset value from the PID module and stores those parameters in the data registers. It is unnecessary to perform the auto-reset again as long as the process is unchanged.

When the proportional band (P) is set to 0 or 0.0, the reset value is cleared.

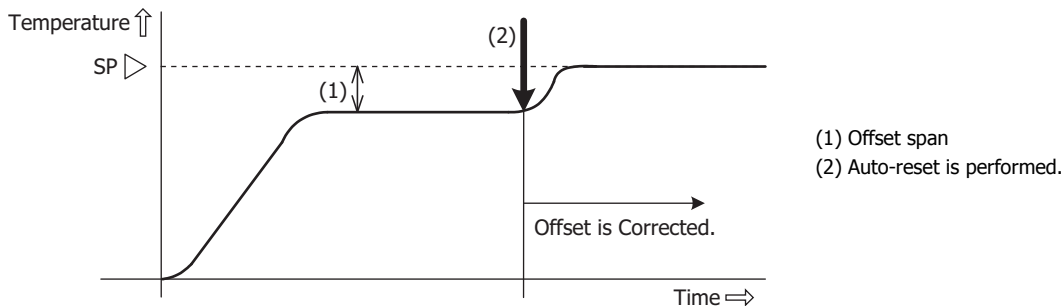

Auto-tuning (AT)/Auto-reset Perform/Cancel

The Auto-tuning (AT)/Auto-reset function can be performed or cancelled by turning on/off the operation parameter bits allocated to each channel. For details on the operation parameter bits, see "Operation Parameters" on page 5-11.

Perform Auto-tuning (AT)

To perform auto-tuning (AT), turn on the control enable/disable bit (Bit0) and auto-tuning (AT)/auto-reset bit (Bit1) of the operation parameter. P, I, D and ARW values will automatically be configured.

When auto-tuning (AT) is performed during the program control, P, I, D and ARW values of the current step are configured.

While auto-tuning (AT) is performed, the Auto-tuning (AT)/Auto-reset LED (AT0/AT1) flashes.

When auto-tuning (AT) is completed, the operation parameter Bit1 is automatically turned off, and the CPU module reads all parameters of the AT performed channel from the PID module and store those parameters in the data registers. If any parameters in the data registers of the CPU module have been changed but have not been written to the PID module, those parameters will be overwritten with the parameters read from the PID module when auto-tuning (AT) is finished.

Cancel Auto-tuning (AT)

To cancel auto-tuning (AT) while it is performed, turn off Auto-tuning (AT)/Auto-reset bit (Bit1) of the operation parameter.

When the operation parameter Bit1 is turned off, auto-tuning (AT) is canceled, and the Auto-tuning (AT)/Auto-reset LED (AT0/AT1) will go off. When auto-tuning (AT) is cancelled, P, I, D and ARW values are reverted to the original values at the time that auto-tuning (AT) was started.

Perform Auto-reset

To perform auto-reset, turn on Auto-tuning (AT)/Auto-reset bit (Bit1) of the operation parameter. The reset value will automatically be configured and the offset is corrected. During auto-reset is performed, the Auto-tuning (AT)/Auto-reset LED (AT0/AT1) flashes. Auto-reset cannot be cancelled.

Auto-tuning (AT)/Auto-reset Program Example

The ladder program and the timing chart below describe an example of performing and canceling auto-tuning (AT). When the starting data register allocated to the PID module is D1000, CH0 control auto-tuning (AT) is executed.

Ladder Program

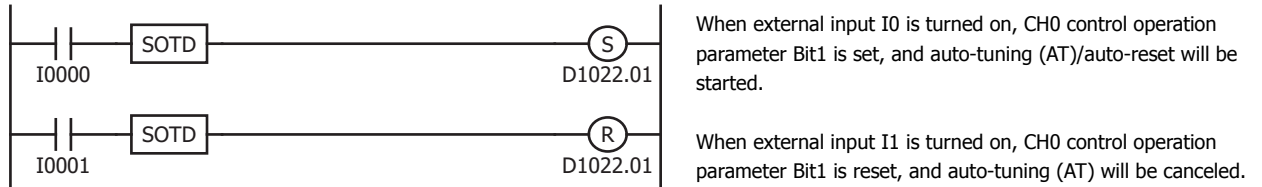

Timing Chart

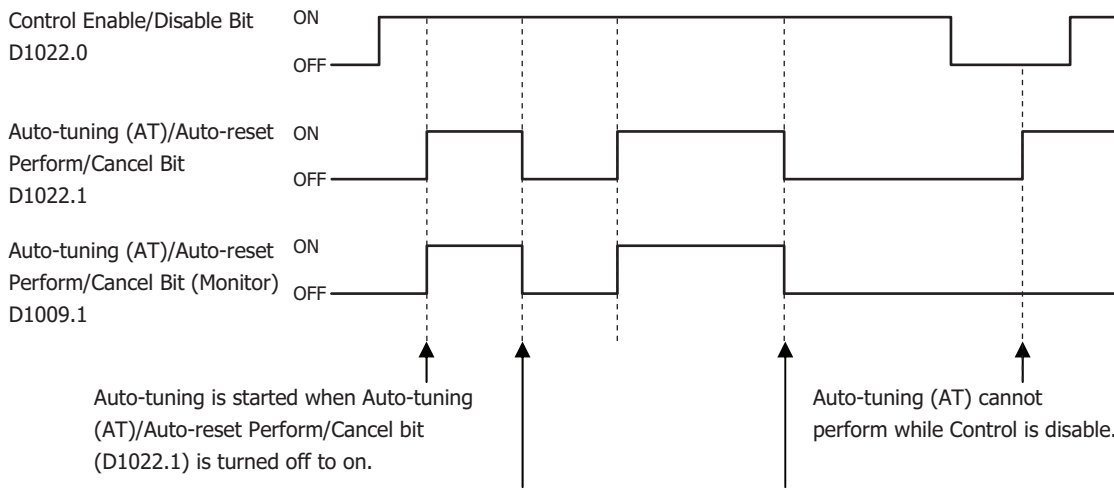

If auto-tuning (AT) is cancelled while it is performed, the P, I, D and ARW values will be reverted to the original values at the time that auto-tuning (AT) was started.

When auto-tuning (AT) is completed:

- The P, I, D, and ARW values will be updated.
- Auto-tuning (AT)/Auto-reset Perform/Cancel bit (D1022.1) will be automatically turned off.

Notes:

- Auto-tuning (AT)/Auto-reset bit is automatically turned off when Auto-tuning (AT)/Auto-reset is completed.
- If Auto-tuning (AT)/Auto-reset bit is kept on, Auto-tuning (AT)/Auto-reset will be performed continuously. Use SOTU and SET instructions to turn on Auto-tuning (AT)/Auto-reset bit so that auto-tuning (AT)/auto-reset is performed only once.
- If auto-tuning (AT) is cancelled while it is performed, P, I, D, and ARW values will be reverted to the original values at the time that auto-tuning (AT) was started.
- Auto-reset cannot be cancelled.

4: PID MODULE MAIN FUNCTIONS

Program Control

The program control allows you to define the set point (SP) that changes as the time progresses so that the process variable (PV) can be controlled to match the set point (SP) changing as the time progresses. The set point (SP) and time can be configured for each step. A maximum of 10 steps can be configured and performed. The set point (SP) can be configured as shown in the following diagram. The program control is suitable for applications, such as electric furnaces for ceramic industries or food machineries.

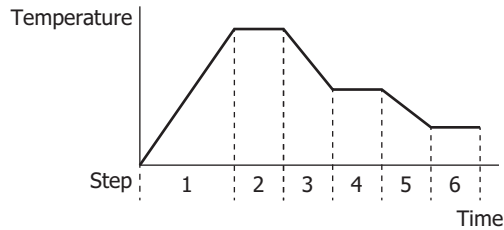

Main functions of the program control are described as follows:

Program Pattern and Steps

1 program pattern consisting of 10 steps can be performed per channel.

Program Hold Function

Suspends the progression of the program control while the program control is running and performs the fixed value control with the set point (SP) at the time that the program control is held.

Advance Next Function

Terminates the current step while the program control is running and proceeds to the start of the next step.

Advance Previous Function

Moves back the progression of the program control while the program control is running.

Wait Function

When a step ends during program control, if the deviation between the process variable (PV) and set point (SP) is bigger than the wait value, the program control does not move to the next step. The program control proceeds to the next step once the deviation between the process variable (PV) and set point (SP) becomes smaller than the wait value.

Repeat Function

When the all steps are executed and the program control is terminated, the program control can be repeated from Step 0 as many times as the repeat number configured.

Program Control Operation Bits and Status Monitoring

By turning on/off the operation parameter bit, program control progression can be operated. By monitoring program run status, the current status of program control can be monitored.

For details on the allocation of operation parameter, program run status, operating status, see Chapter 5 "Block 1: Write Only Parameters" - "Operation Parameter Monitor" on page 5-8 and "Operating Status" on page 5-9, and Chapter 5 "Blocks 2, 3: Basic Parameters (SHOT Action)" - "Operation Parameters" on page 5-11.

Program Control Start (Start the program control)

Turn on the program control bit (Bit3) of the operation parameter. Program control starts.

Program Control Stop (Stop the program control)

Turn off the program control bit (Bit3) of the operation parameter. Program control stops and enters standby status.

Program Hold (Suspend the program control)

Turn on the program hold bit (Bit4) of the operation parameter. Program control is held (Suspended). While the program control is held, time progression is suspended, and fixed value control is performed with the set point (SP) at the time that the program control is held. Program hold causes the Program Control RUN/HOLD LED (R/H0 or R/H1) on the PID module to flash. To resume the program control, turn off the program hold bit (Bit4).

Advance Next Function (Proceed to the next step)

Turn off to on the advance next step (Bit6) of the operation parameter. The current step is terminated and the program control is proceeded to the start of the next step. The advance next function is also effective while the program control is in wait action.

Advance Previous Function (Move back the program control)

Turn off to on the advance previous step (Bit7) of the operation parameter. The progression of the current step is stopped and the program control is moved back. If the elapsed time in the current step is less than 1 minute, the program control goes back to the start of the previous step. If the elapsed time in the current step is longer than 1 minute, the program control goes back to the start of the current step.

Even when the advance previous function is executed at Step 0, the program control does not move back to Step 9 regardless of the program end action.

Current Step Remaining Time

The remaining time of the current step is stored in the "Current Step Remaining Time" of Block 0. The remaining time is stored in seconds or minutes according to the "Step time unit" setting.

Current Step Number

The current step number (0 to 9) is stored in the "Current Step Number" of Block 0.

Program Wait (Perform program wait)

While the program wait is functioning, the program wait bit (Bit5) of the operating status is turned on. If the condition below is satisfied, the wait function is cancelled, the program control proceeds to the next step, and the program wait bit (Bit5) is turned off.

$$\text{Set point (SP) - Wait value} \leq \text{Process variable (PV)} \leq \text{Set point (SP) + Wait value}$$

If the advance next function (Bit6) is turned from off to on or if the program control bit (Bit3) is turned off, the wait function is canceled.

Program End Output (Program Termination)

When the program control is finished, the program end output bit (Bit6) of the operating status is turned on. If the program control bit (Bit3) of the operation parameter is turned off, the program end output bit (Bit6) is turned off. To start program control again, turn off to on on the program control bit (Bit3) of the operation parameter.

Action when Program Control Starts

The program control mode start type can be selected from 3 types: PV start, PVR start, and SP start.

When SP start is selected, the program control starts from the set point (SP) configured with "Set point (SP) when program control starts." When PV start or PVR start is selected, and the program control starts, the step time is advanced until the set point (SP) matches to the process variable (PV), and then the program control starts. For details about the program control mode start type, see "(23) Control Register+91: Program Control Mode Start Type" on page 6-42.

In the following example, the set point (SP) is 100°C, the step time is 60 minutes, and the process variable (PV) when program control starts is 25°C.

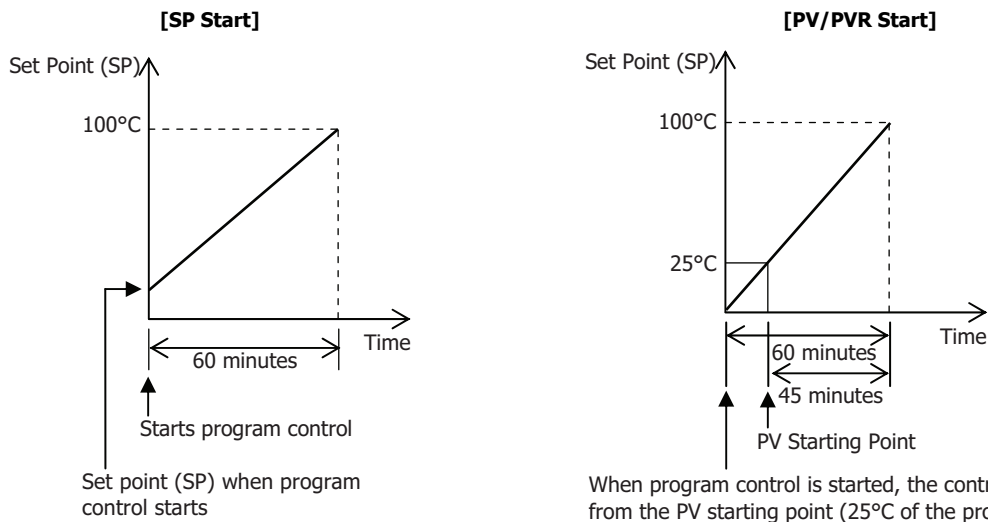

Program End Action

Program end action can be selected from 3 types: Terminate program control, Continue program control (Repeat), and Hold program control. When the all steps from 0 to 9 are executed and completed, the program control is finished. When "Terminate program control" is selected, the PID module will enter standby status after the program control is finished. While in standby status, no control is performed and the control output is in OFF status. If "Continue program control (Repeat)" is selected, the program control is repeated from step 0 as many times as the repeat number configured. When "Hold program control" is selected, the program control is held (suspended) after the program control is finished, and the fixed value control is performed with the set point (SP) of Step 9. For details about the program end action, see "(26) Control Register+93: Program End Action" on page 6-44.

4: PID MODULE MAIN FUNCTIONS

Action after Power Is Restored

When the power is restored, every bit of the operation parameter excluding the program hold bit stored in the data register is maintained. If the power fails and then is later restored while the PID module performs program control, the PID module starts its operation in accordance with the original PID module status before the power turned off as shown in the table below.

Program End Action	PID Module Status before Power Off			
	Standby Status*1	Program Control is Performing.	Program Control is suspended (Hold)	Program Control is Terminated.
Terminate Program Control	Standby status is maintained.	The program control is continued. *2, *3	The program hold is canceled, and the program control is continued. *2, *3	The program control is started from the Step 0.
Continue Program Control (Repeat)				The program hold is maintained. Fixed value control is performed with the set point (SP) at the time that the power is turned off.
Hold Program Control				

*1 The PID module is in standby status when the control enable bit is on but the program control bit is off. While in standby status, the PID module performs no control.

*2 While the program control is running, the PID module saves the program control status every 6 minutes after the program control is started (after the program control bit is turned on). The program control status is also saved at the start of each step. If the power to the PID module is turned off while the program control is running, the PID module resumes the program control from the latest saved point.

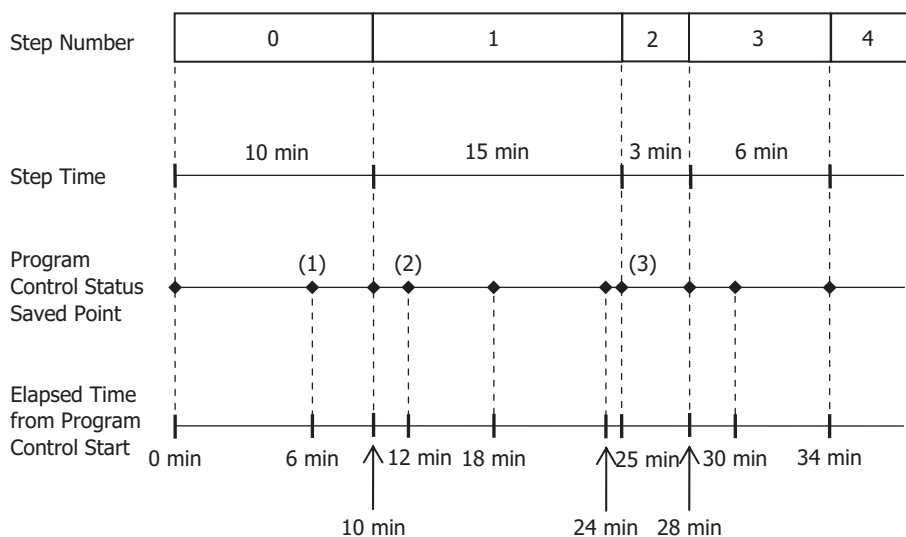

For example, if the power to the PID module is turned off in 7 minutes after the program control is started at step 0, the PID module resumes the program control at the status (1) when the power is restored. If the power to the PID module is turned off in 4 minutes after the program control enters step 1, the PID module resumes the program control at the status (2) when the power is restored. If the power to the PID module is turned off in 2 minutes after the program control enters step 2, the PID module resumes the program control at the status (3), which is the start of step 2, when the power is restored.

*3 To restart the program control from the start of step 0, turn off and on the program control bit (operation parameter Bit3).

Program Pattern Example

The set point (SP) configured for each step is handled as the set point (SP) at the end of the step. The time configured for each step is the process time of each step.

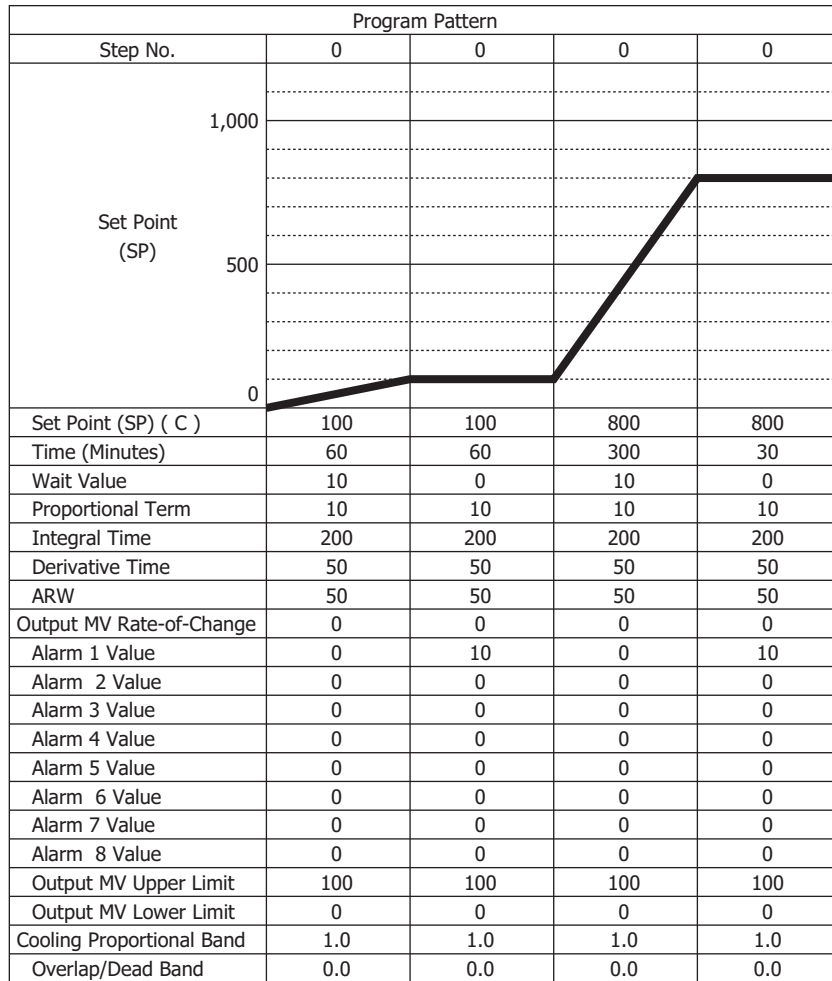

When the program pattern is configured as shown in the above table, the following control is performed at each step:

- [Step 0]: The set point (SP) is gradually risen to 100°C in 60 minutes.
When the step 0 ends, the wait function works so that the program control does not proceed to the step 1 until the process variable (PV) reaches 90°C.
- [Step 1]: The fixed value control is performed at 100°C of the set point (SP) for 60 minutes.
- [Step 2]: The set point (SP) is gradually risen to 800°C in 5 hours.
When the step ends, the wait function works so that the program control does not proceed to the step 3 until the process variable (PV) reaches 790°C.
- [Step 3]: The fixed value control is performed at 800°C of the set point (SP) for 30 minutes.

4: PID MODULE MAIN FUNCTIONS

Heating/Cooling Control

When it is difficult to control the target process with heating control only, cooling control can be added to perform the heating/cooling control. Control results derived from the set point (SP) and process variable (PV) are outputted to 2 outputs, heating output (CH0) and cooling output (CH1). If the process variable (PV) is higher than the set point (SP), cooling output will be turned on. If the process variable (PV) is lower than the set point (SP), heating output will be turned on. The area in which both heating and cooling outputs are turned on can be configured as overlap. The area in which neither heating output nor cooling output is output can be configured as dead band.

Example: Heating/Cooling control uses both heating and cooling outputs and is suitable for the heat producing processes such as extruders or for temperature control at near ambient temperature such as environment testers.

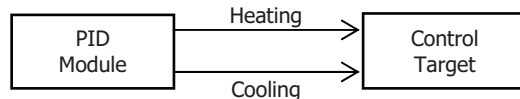

Difference Input Control

Difference input control is the control to keep the input difference between input CH0 and input CH1 at the same level. When the difference input control is selected, input CH0 and input CH1 are independently measured, and the difference between those inputs is used as process variable (PV). PID module controls output so that the difference between those inputs is matched to the set point (SP).

Example 1: Controlling the liquid level difference of 2 tanks

The PID module measures the liquid levels of 2 tanks and controls output to keep liquid level difference between Tank A and Tank B constant.

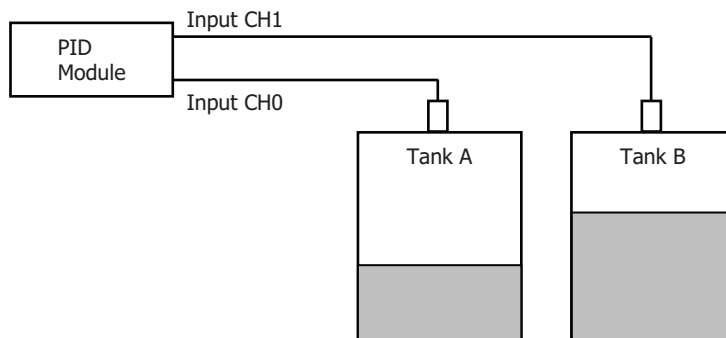

Example 2: Cabinet Interior Dew Condensation Prevention

The PID module measures interior and external temperatures of the cabinet and controls output to keep the temperature difference between interior and external cabinet constant so that dew condensation inside the cabinet can be prevented.

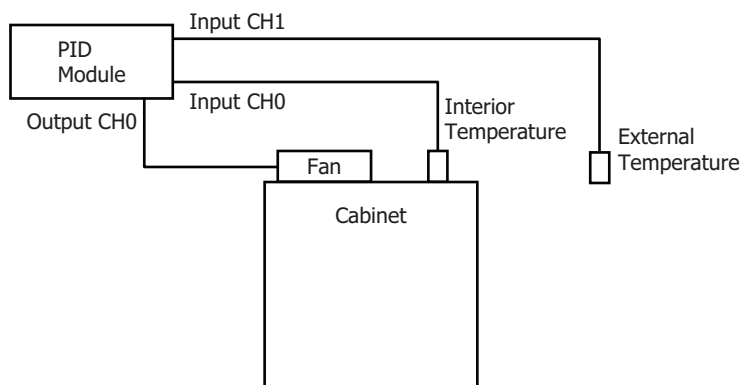

Cascade Control

Cascade control is a type of control that regulates temperature by combining two PID controls to form one feedback loop. The cascade control is effective for applications in which the delay time or dead time is considerably large. When delay time is large, it takes a long time for the process variable (PV) to change after the output manipulated variable (MV) is changed. By using the cascade control, highly stable control can be realized for such applications, though it takes time for the process variable (PV) to reach the set point (SP).

CH1 control is used as the master and CH0 control as the slave of the cascade control. The output manipulated variable (MV) of the master (CH1 control) becomes the set point (SP) of the slave (CH0 control), and the control result of CH0 is outputted from the CH0 output. The output manipulated variable (MV) (0 to 100%) of the master (CH1 control) is corresponded to the set point (SP) of the slave (CH0 control) according to the external SP input linear conversion minimum and maximum values. For example, when the external SP input linear conversion minimum value is 100°C and the maximum value is 400°C, the output manipulated variable (MV) (0 to 100%) of the master (CH1 control) is converted as follows: 0% is converted to 100°C, 50% is converted to 250°C, and 100% is converted to 400°C.

When a system using the cascade control is designed, it is required that the slave (CH0 control) have smaller delay time and faster response comparing to the master (CH1 control).

Example: The cascade control is used for an application in which the heat quantity of a heater is controlled using a power controller in order to control the temperature of the control target as shown in the figure below. It is also possible to utilize the heating/cooling control to prevent a rapid temperature rise of the control target by using a fan as the cooling output.

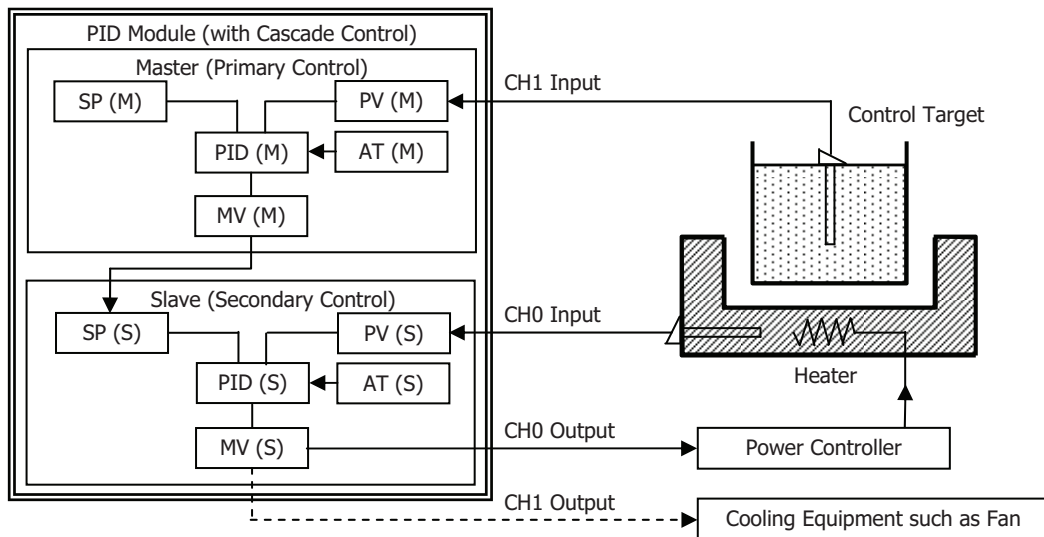

4: PID MODULE MAIN FUNCTIONS

System Configuration and Wiring

Wiring Example of the FC6A-F2M1 [Current Output Type]

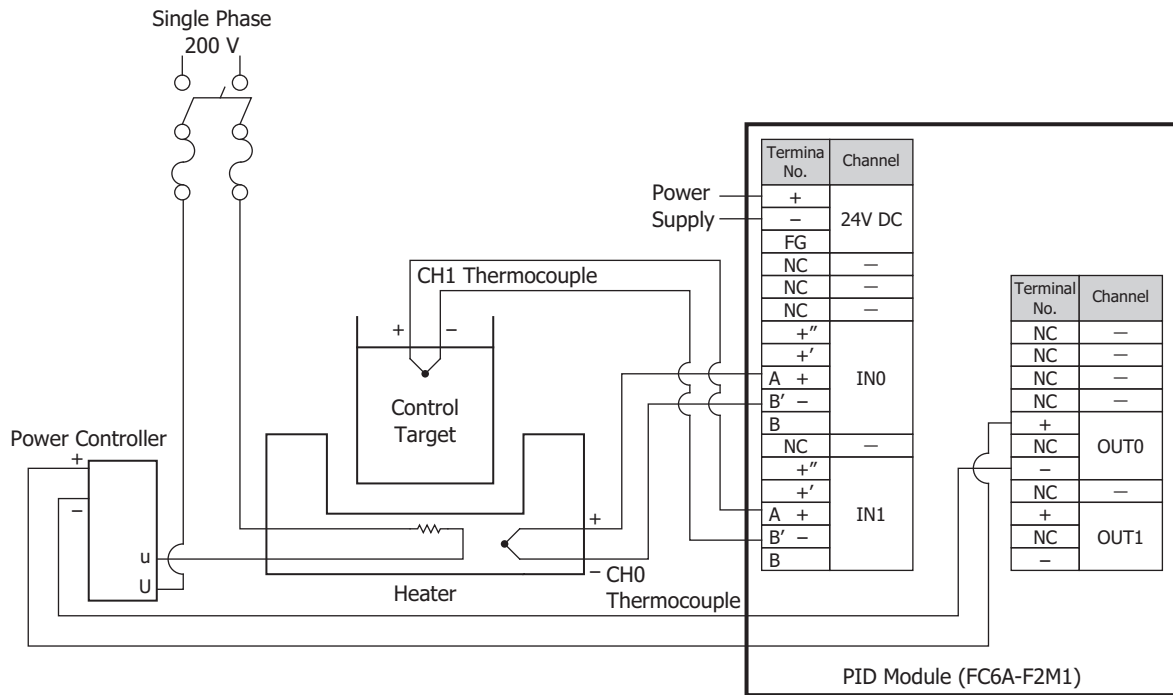

How to perform auto-tuning (AT) in cascade control

Auto-tuning (AT) can be performed for the cascade control with the following procedure.

Auto-tuning (AT) for the slave (CH0)

1. Turning off the CH0 control and CH1 control operation parameter enables bits to prohibit the CH0 control and CH1 control.
2. In order to fix the set point (SP) of the slave (CH0 control), set the set point (SP) of the master (CH1 control) to the set point (SP) of the slave (CH0 control) and the CH1 control external SP input linear conversion maximum and minimum values.
3. Turning on the CH0 control and CH1 control operation parameter enables bits to allow CH0 control and CH1 control. Turn on the CH0 control operation parameter auto-tuning (AT)/auto-reset bit to start the auto-tuning (AT) for CH0 control. When auto-tuning (AT) is completed, P, I, D and ARW values of the slave (CH0 control) will be automatically configured.

Auto-tuning (AT) for the master (CH1)

1. Turn off the CH1 control enable bit of the operation parameter to disable the CH1 control.
2. Restore the original values in the CH1 control external SP input linear conversion maximum and minimum values.
3. Turn on the CH1 control enable bit and CH1 auto-tuning (AT)/auto-reset bit of the operation parameter to enable the CH1 control and start the auto-tuning (AT) for the master (CH1 control). When auto-tuning (AT) is completed, P, I, D and ARW values of the master (CH1 control) will be automatically configured.

Notes:

- When using the cascade control, store the same set point of the master (CH1 control) to the set point (SP) of the slave (CH0 control).
- The output manipulated variable (MV) (0 to 100%) of the master (CH1 control) corresponds to the set point (SP) of the slave (CH0 control). The range of the set point is the external SP input linear conversion minimum value to the external SP input linear conversion maximum value.
- Depending on each control target, optimum values of P, I, D and ARW may not be calculated with the auto-tuning (AT). In such case, configure those parameters manually based on the P, I, D and ARW values calculated with the auto-tuning (AT).

4: PID MODULE MAIN FUNCTIONS

Program Example of Auto-tuning (AT) for Cascade Control

A sample ladder program to execute the auto-tuning (AT) for the master (CH1 control) and slave (CH0 control) in the cascade control is described next.

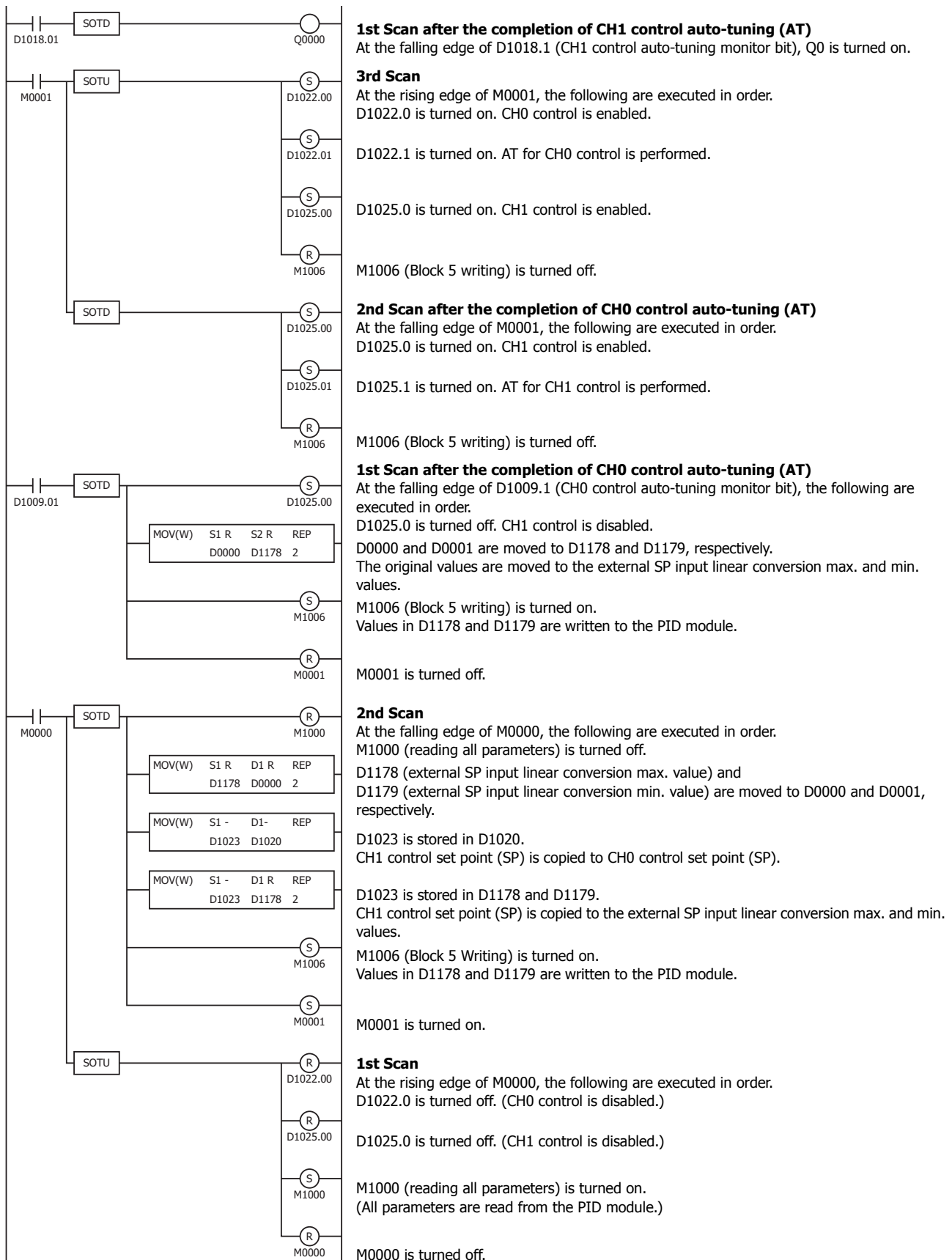

External PV Mode

External PV mode is a mode where control target temperature PV1 (process variable with decimal point) read by the PID module is used for a calculation in the ladder program of the CPU module, and PID control is performed based on that calculated result.

When external PV mode is disabled

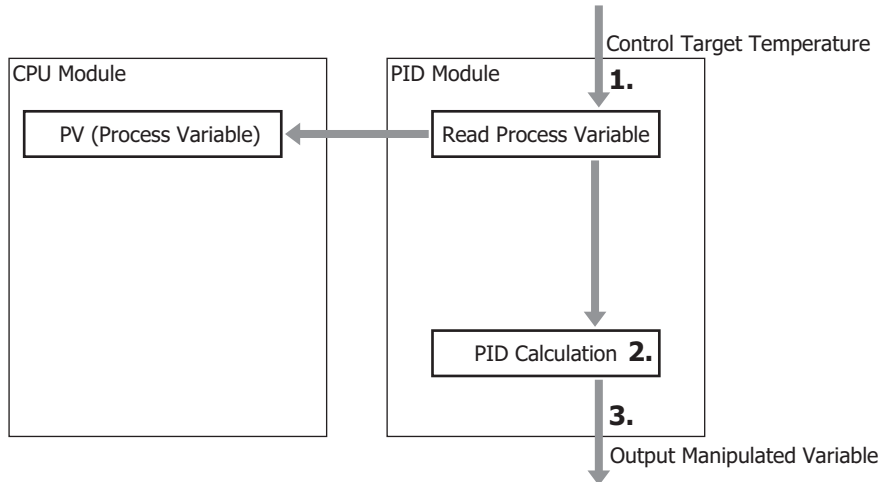

1. The PID module reads the control target temperature as the process variable.
2. The PID module performs the PID calculation using the process variable.
3. The PID module outputs the manipulated variable.

When external PV mode is enabled

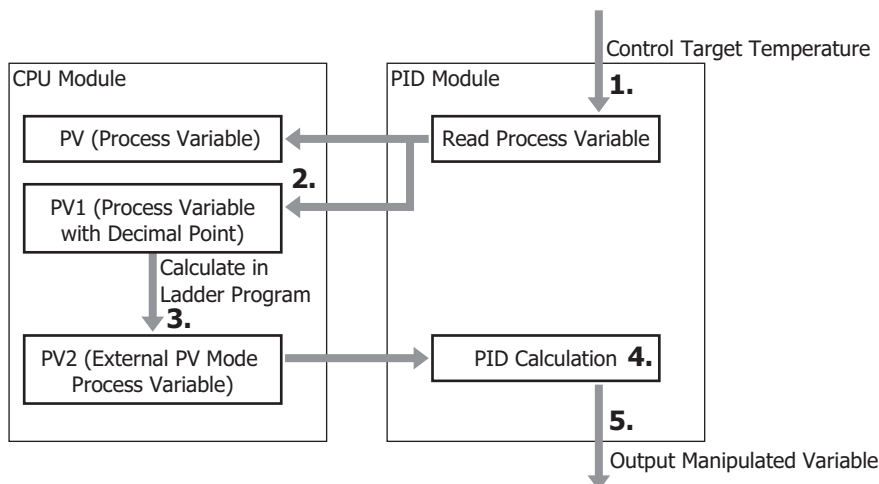

1. The PID module reads the control target temperature as the process variable.
2. The CPU module reads PV1 (process variable with decimal point) from the PID module.
3. The CPU module performs a calculation using PV1 (process variable with decimal point) in the ladder program and calculates PV2 (external PV mode process variable).
4. The PID module reads PV2 (external PV mode process variable) from the CPU module and performs the PID calculation.
5. The PID module outputs the manipulated variable.

Notes :

- The process variable read from the control target is retained as PV (process variable without decimal point) and PV1 (process variable with decimal point).
- When external PV mode is enabled, use PV1 (process variable with decimal point) to obtain PV2 (external PV mode process variable). By using the process variable with decimal point, high-precision PID control can be performed.

4: PID MODULE MAIN FUNCTIONS

5: DEVICE ALLOCATION OF PID MODULE

This chapter describes the valid devices, control registers, control relays, and data register allocation for the PID module.

Device Allocation of PID Module

The PID module is used by connecting to the CPU module. To use the PID module, you must configure the control registers, control relays, and initial parameters using WindLDR and download the program to the CPU module and PID module. The initial parameters are downloaded to the CPU module along with the user program. The CPU module reads/writes data from/to the PID module according to the parameters configured in WindLDR.

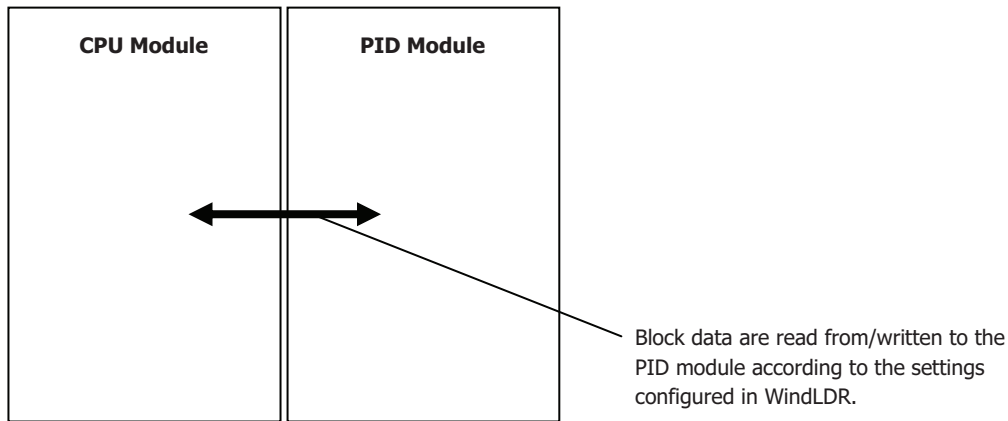

The PID module parameters consist of 26 data blocks divided according to the function and frequency of use of each parameter as shown in the table below. All blocks to be used are allocated to the data registers in the CPU module. The parameters of each block can be read from/written to the PID module using the allocated control relays.

Block	Number of Data Registers	Description
Block 0	20	Read only parameters (CH0, CH1)
Block 1	6	Write only parameters (CH0, CH1)
Block 2	27	Basic parameters (CH0)
Block 3	27	Basic parameters (CH1)
Block 4	50	Initial setting parameters (CH0)
Block 5	50	Initial setting parameters (CH1)
Blocks 10 to 19	21/block	Program parameters (CH0)
Blocks 30 to 39	19/block	Program parameters (CH1)

Block 0 includes parameters such as operating status, current process variable (PV), set point (SP), and output manipulated variable (MV) of the PID module. The CPU module reads those parameters from the PID module every scan. The control status and alarm status of the PID module can be monitored with Block 0 parameters.

Block 1 includes the set point (SP), manual mode output manipulated variable (MV), and operation parameters of the PID module. Those parameters are written to the PID module every scan. Operations such as changing the set point (SP) for the fixed value control, enabling/disabling the control, or performing auto-tuning (AT) can be carried out.

Block 2 and Block 3 include basic parameters of the PID module. By turning the control relay from off to on, parameters can be read from/ written to the PID module.

Block 4 and Block 5 include initial setting parameters of the PID module. Parameters that are usually not changed during the operation are stored.

Blocks 10 to 19 and Blocks 30 to 39 include parameters of each step of the program control. By turning the control relay from off to on, parameters can be read from/written to the PID module.

5: DEVICE ALLOCATION OF PID MODULE

Program Size

The minimum program size used by one PID module is as follows.

CPU Module Type	Program Size	
	When CH0 Control and CH1 Control is Fixed Value Control Mode	When CH0 Control or CH1 Control is Program Control Mode
All-in-One Type	1,300 bytes	4,400 bytes

Valid Devices

The following devices can be allocated as the control register and relay for the PID module. Control register and relay should be configured for each PID module. Duplicated device cannot be configured.

	I	Q	M	R	T	C	D	Constant
Control Register	-	-	-	-	-	-	X	-
Control Relay	-	-	X	-	-	-	-	-

Control Register

The PID module occupies a maximum of 590 data registers (minimum 190 data registers) per PID module. The occupied number of data registers varies between the fixed value control mode and program control mode. When both CH0 control and CH1 control are in fixed value control mode, 190 data registers are occupied, including the first data register designated. When either CH0 control or CH1 control is in program control mode, 590 data registers are occupied, including the first data register designated.

Control Relay

The PID module occupies a maximum of 32 internal relays (minimum 8 internal relays) per module. The occupied number of internal relays varies between the fixed value control mode and program control mode. When both CH0 control and CH1 control are in fixed value control mode, 8 internal relays are occupied. When either CH0 control or CH1 control is in program control mode, 32 internal relays are occupied.

Internal Relay Allocation

When both CH0 control and CH1 control are in fixed value control mode, the following 8 internal relays are allocated:

Offset from the Control Relay	Description	R/W
+0	Reading all parameters (PID module → CPU module data registers)	R/W
+1	Loading initial values (CPU module ROM → data registers)	R/W
+2	Writing all parameters (CPU module data registers → PID module)	R/W
+3	Block 2 (CH0 control basic parameters) writing	R/W
+4	Block 3 (CH1 control basic parameters) writing	R/W
+5	Block 4 (CH0 control initial setting parameters) writing	R/W
+6	Block 5 (CH1 control initial setting parameters) writing	R/W
+7	Reserved	R/W

When either CH0 control or CH1 control is in program control mode, the following 32 internal relays are allocated:

Offset from the Control Relay	Description	R/W
+0	Reading all parameters (PID module → CPU module data register)	R/W
+1	Loading initial values (CPU module ROM → Data register)	R/W
+2	Writing all parameters (CPU module data register → PID module)	R/W
+3	Block 2 (CH0 control basic parameters) writing	R/W
+4	Block 3 (CH1 control basic parameters) writing	R/W
+5	Block 4 (CH0 control initial setting parameters) writing	R/W
+6	Block 5 (CH1 control initial setting parameters) writing	R/W
+7	Reserved	R/W
+8	Block 10 (CH0 control Step 0) writing	R/W
+9	Block 11 (CH0 control Step 1) writing	R/W
+10	Block 12 (CH0 control Step 2) writing	R/W
+11	Block 13 (CH0 control Step 3) writing	R/W
+12	Block 14 (CH0 control Step 4) writing	R/W
+13	Block 15 (CH0 control Step 5) writing	R/W

Offset from the Control Relay	Description	R/W
+14	Block 16 (CH0 control Step 6) writing	R/W
+15	Block 17 (CH0 control Step 7) writing	R/W
+16	Block 18 (CH0 control Step 8) writing	R/W
+17	Block 19 (CH0 control Step 9) writing	R/W
+18	Block 30 (CH1 control Step 0) writing	R/W
+19	Block 31 (CH1 control Step 1) writing	R/W
+20	Block 32 (CH1 control Step 2) writing	R/W
+21	Block 33 (CH1 control Step 3) writing	R/W
+22	Block 34 (CH1 control Step 4) writing	R/W
+23	Block 35 (CH1 control Step 5) writing	R/W
+24	Block 36 (CH1 control Step 6) writing	R/W
+25	Block 37 (CH1 control Step 7) writing	R/W
+26	Block 38 (CH1 control Step 8) writing	R/W
+27	Block 39 (CH1 control Step 9) writing	R/W
+28	Reserved	R/W
+29	Reserved	R/W
+30	Reserved	R/W
+31	Reserved	R/W

For details about blocks, see "Data Register Allocation" on page 5-7.

Notes about the control relays:

- The control relay +0: Reading all parameters
When this bit is turned off to on, all parameters stored in the ROM of the PID module are read out and stored in the data registers in the CPU module.
- The control relay +1: Loading initial values
When the user program is downloaded to the CPU module, the initial values of all parameters for the PID module are also downloaded and stored in the ROM of the CPU module. When this bit is turned off to on, the initial values stored in the ROM are loaded into the data registers (RAM).
- The control relay +2: Writing all parameters
When this bit is turned off to on, all parameters stored in the data registers are written to the ROM of the PID module.
- The control relay +3 through +27: Writing Blocks 2 to 5, 10 to 19, and 30 to 39
When the writing bit is turned off to on, the corresponding block parameters stored in the data registers are written to the ROM of the PID module.

5: DEVICE ALLOCATION OF PID MODULE

Data Flow of the PID module parameters

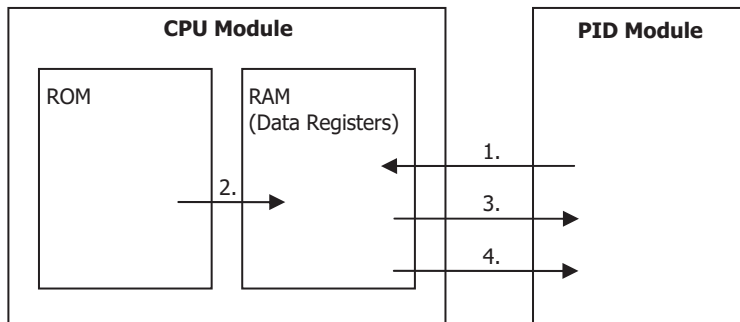

1. All parameters are read out from the PID module and stored in the data registers in the CPU module when the reading all parameters bit is turned off to on.
2. Initial values stored in the ROM of the CPU module are loaded to the data registers when the loading initial values bit is turned off to on.
3. All parameters stored in the data registers are written to the PID module when the writing all parameters bit is turned off to on.
4. The block parameters stored in the data registers are written to the PID module when the block writing bit is turned off to on.

Notes:

The communication status between the CPU module and the PID module can be confirmed with the following data register.

- When both CH0 control and CH1 control are in fixed value control mode: First data register + 189
- When CH0 control or CH1 control is in program control mode: First data register + 589

Data Register Value	Description	
0	Normal operation	
1	Bus error	Turn off the CPU module and connect the PID module again.
3	Invalid module number	The PID module is not connected to the configured slot number. Turn off the CPU module and connect the PID module to the appropriate slot number.

Examples of changing the PID module parameters using the control relay

All parameters of Block 1 to 5, 10 to 19, and 30 to 39 can be changed using a ladder program. The following examples demonstrate how the parameters of the PID module can be changed. For details on the parameters in each block, see "Block 1: Write Only Parameters" on page 5-10 to "Blocks 30-39: Program (CH1) Parameters (SHOT Action)" on page 5-25.

Example 1: Changing Block 1 Parameter

The set point (SP) of CH0 control (D1020) is changed to 250.5°C. In this example, D1000 is allocated to the control register and M500 is allocated to control relay.

When the new set point 2505 is stored in D1020 ^{*1}, it is automatically written to the PID module ^{*2}.

Ladder Program Example:

When external input I0000 is turned on, the set point (SP) of CH0 will be changed to 250.5°C.

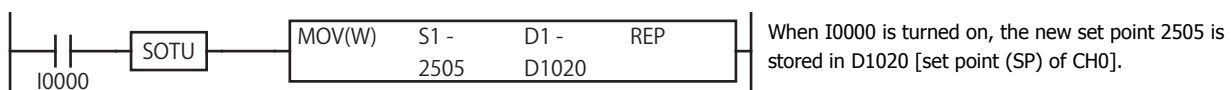

When I0000 is turned on, the new set point 2505 is stored in D1020 [set point (SP) of CH0].

*1 When the input range has a decimal point, store the value multiplied by 10 in the data register.

*2 When the control register is D1000, Block 1 parameters are stored in D1020 to D1025. These values are written to the PID module every scan.

Example 2: Changing Block 2 Parameters

The integral time (D1027) is changed to 150 seconds and the derivative time (D1028) is changed to 45 seconds for CH0 control. In this example, D1000 is allocated to the control register and M0500 is allocated to control relay.

Those parameters can be changed with the following procedure.

1. Turn on M0500 (Reading all parameters). All PID module parameters are read out from the PID module and stored in the data registers. *1
2. Store 150 in D1027 (integral time of CH0) and 45 in D1028 (derivative time of CH0).
3. Turn on M0503 (Block 2 writing) *2. The integral time (150 sec) and derivative time (45 sec) will be written to the PID module.

Ladder Program Example:

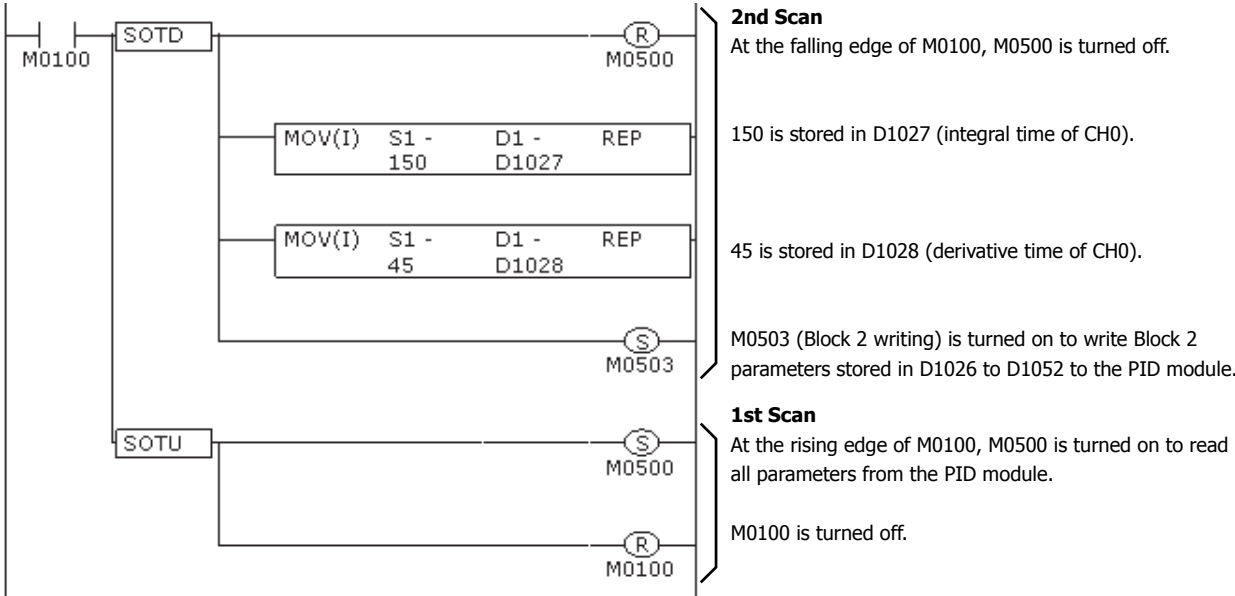

*1 If the reading all parameters bit (M500) is turned on, all PID module parameters are read out from the PID module and stored in the data registers. Block 2 parameters are stored in D1026 to D1052.
 *2 Block 2 parameters stored in D1026 to D1052 are written to the PID module. The parameters of the other blocks are not written.

5: DEVICE ALLOCATION OF PID MODULE

Example 3: Changing Block 4 Parameter

The PV filter time constant (D1063) of CH0 is changed to 1.5 seconds. In this example, D1000 is allocated to the control register and M0500 is allocated to control relay.

The parameter can be changed with the following procedure.

1. Turn on M0500 (Reading all parameters). All PID module parameters are read out from the PID module and stored in the data registers of the CPU module. *1
2. Turn off D1022.0 (Control enable bit of CH0). CH0 control of the PID module will be disabled.
3. Store 15 in D1063 (PV filter time constant of CH0). *2
4. Turn on M0505 (Block 4 writing). *3
5. Turn on D1022.0 (Control enable bit of CH0). CH0 of the PID module will be enabled.

Ladder Program Example:

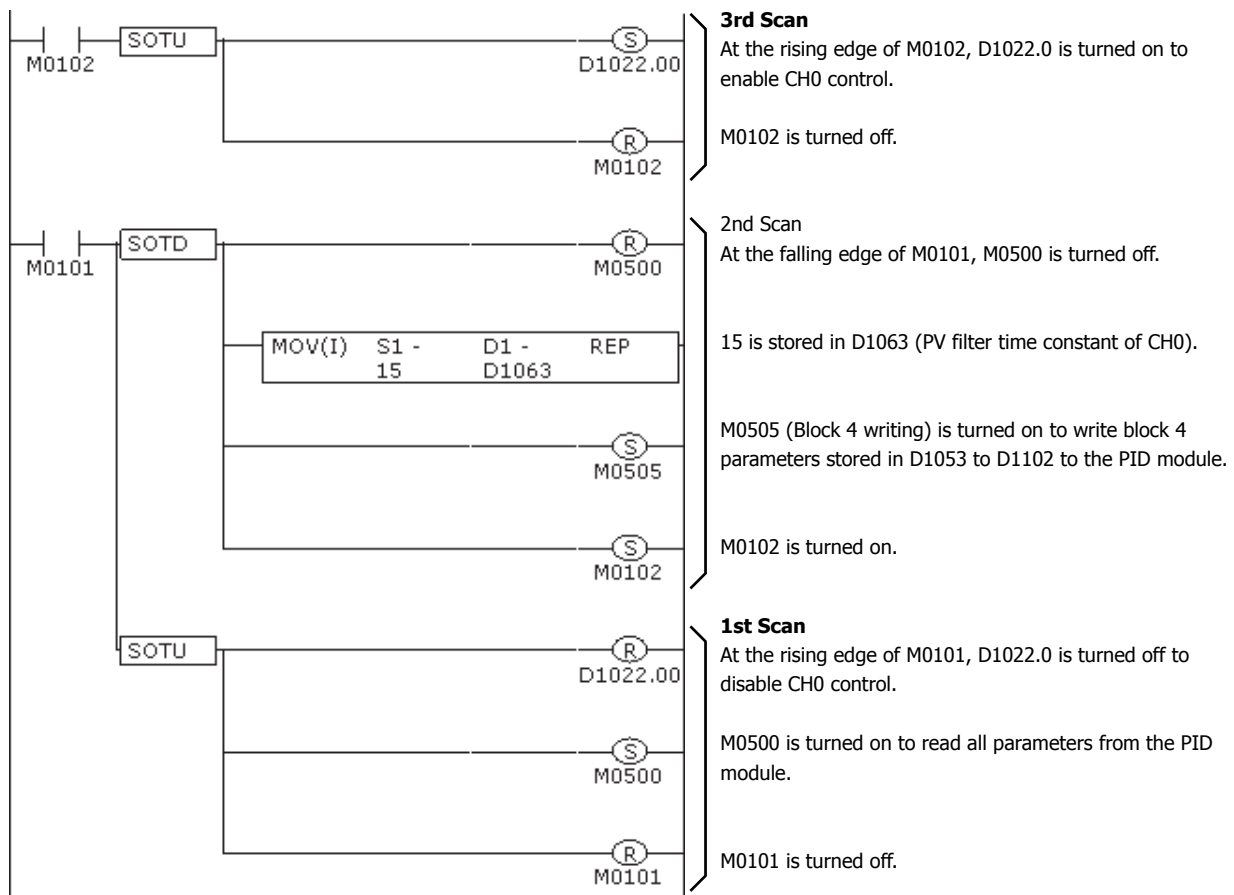

*1 If the reading all parameters (M0500) is turned on, all PID module parameters are read out from the PID module and stored in the data registers. Block 4 parameters are stored in D1053 to D1102.

*2 For a value with a decimal point, store the value multiplied by 10 in the data register.

*3 Block 4 parameters stored in D1053 to D1102 are written to the PID module. The parameters of the other blocks are not written.

Note: If parameters of Block 4 or Block 5 are changed while CH0 or CH1 control is enabled in the PID module, an unexpected operation of the PID module may be caused. It is recommended that the control channel of the PID module be disabled before changing the parameters of Block 4 or Block 5.

Data Register Allocation

Block 0: Read Only Parameters

The CPU module reads the following parameters from the PID module and store them in the data registers every scan.

Offset from the Control Register		Parameter	Description	R/W
0	Common	PID Module Operating Status	0000h: Initialization 0001h: Normal operation 0002h: External power supply error	R
+1	CH0	Current Process Variable (PV)	When input is normal: See the values in "Control Range" on page A-4 When input is invalid: Unknown value	R
+2		Current Heating Output Manipulated Variable (MV)	Output manipulated variable lower limit to upper limit	R
+3		Current Cooling Output Manipulated Variable (MV)	Cooling output manipulated variable lower limit to upper limit	R
+4		Current Set Point (SP)	When input is thermocouple or resistance thermometer: Set point (SP) lower limit to set point (SP) upper limit When input is voltage or current input: Linear conversion min. to linear conversion max.	R
+5		Current Step Remaining Time	0 to 6,000 minutes/seconds	R
+6		Current Step Number	0 to 9	R
+7		Remaining Repeat Number	0 to 10,000	R
+8		When external PV mode is disabled: Reserved	–	R
		When external PV mode is enabled: Current process variable with decimal point (PV1)	When input is normal: See the values in "Input Range" on page 5-22 When input is invalid: Unknown value	
+9		Operation Parameter Monitor	See "Operation Parameter Monitor" on page 5-8.	R
+10	Operating Status	See "Operating Status" on page 5-9.	R	
+11	CH1	Current Process Variable (PV)	When input is normal: See the values in "Control Range" on page A-4 When input is invalid: Unknown value	R
+12		Current Output Manipulated Variable (MV)	Output manipulated variable lower limit to upper limit	R
+13		Current Set Point (SP)	When input is thermocouple or resistance thermometer: Set point (SP) lower limit to set point (SP) upper limit When input is voltage or current input: Linear conversion min. to linear conversion max.	R
+14		Current Step Remaining Time	0 to 6,000 minutes/seconds	R
+15		Current Step Number	0 to 9	R
+16		Remaining Repeat Number	0 to 10,000	R
+17		When external PV mode is disabled: Reserved	–	R
		When external PV mode is enabled: Read current process variable with decimal point (PV1)	When input is normal: See the values in "Input Range" on page 5-22 When input is invalid: Unknown value	
+18		Operation Parameter Monitor	See "Operation Parameter Monitor" on page 5-8	R
+19		Operating Status	See "Operating Status" on page 5-9.	R

5: DEVICE ALLOCATION OF PID MODULE

Operation Parameter Monitor

Bit	Operation Parameter Monitor (1 word)		
	Parameter	Status	Description
Bit0	Control Enable Bit	0	Control is disabled
		1	Control is enabled
Bit1	Auto-tuning (AT)/Auto-Reset Bit	0	Normal operation
		1	Auto-tuning (AT)/Auto-reset is being performed
Bit2	Auto/Manual Mode Bit	0	Auto mode
		1	Manual mode
Bit3	Program Control Bit	0	Program control is stopped
		1	Program control is running
Bit4	Program Hold Bit	0	Normal operation
		1	Program control is held
Bit5	External SP Input Enable Bit (CH0 only)	0	External SP input is disabled
		1	External SP input is enabled
Bit6	Parameter Range Error Bit (Note)	0	All parameters are within the valid range
		1	All parameters are out of the valid range
Bit7	Set point (SP) Range Error Bit	0	Set point (SP) is within the valid range.
		1	Set point (SP) is within the valid range.
Bit8	Manual Mode Output Manipulated Variable Range Error Bit	0	Manual mode output manipulated variable is within the valid range.
		1	Manual mode output manipulated variable is out of the valid range.
Bit9	Proportional Band/Integral Time/Derivative Time/ARW/ Control Period Range Error Bit	0	Proportional band, integral Time, derivative time, ARW, or control period is within the valid range.
		1	Proportional band, integral Time, derivative time, ARW, or control period is out of the valid range.
Bit10	Reset Setting Range Error Bit	0	Reset setting is within the valid range.
		1	Reset setting is out of the valid range.
Bit11	Cooling Proportional Band/Cooling Control Period Range Error Bit (CH0 only)	0	Cooling proportional band or cooling control period is within the valid range.
		1	Cooling proportional band or cooling control period is out of the valid range.
Bit12	Overlap/Dead Band Range Error Bit (CH0 only)	0	Overlap/dead band is within the valid range.
		1	Overlap/dead band is out of the valid range.
Bit13	Alarm 1 to Alarm 8 Value Range Error Bit	0	Alarm 1 to Alarm 8 values are within the valid range.
		1	Alarm 1 to Alarm 8 values are out of the valid range.
Bit14	PV Filter/PV Correction Range Error Bit	0	PV Filter/PV Correction is within the valid range.
		1	PV Filter/PV Correction is out of the valid range.
Bit15	Program Control Set Point (SP) Range Error Bit	0	Program control set point (SP) is within the valid range.
		1	Program control set point (SP) is out of the valid range.

Note: The parameter range error bit is turned on when any parameter of the PID module is out of the valid range. While the parameter range error is occurring, the control output is turned off.

Operating Status

Bit	Operating Status (1 word)		
	Parameter	Status	Description
Bit0	(Heating) Control Output	0	OFF
		1	ON (Unknown for current output)
Bit1	Cooling Control Output (CH0 only)	0	OFF
		1	ON (Unknown for current output)
Bit2	Loop Break Alarm	0	Normal operation
		1	Loop break alarm is occurring
Bit3	Over Range	0	Normal operation
		1	Input value is exceeding the upper limit of the control range (See page A-4). Thermocouple or resistance thermometer may be burnt out. Voltage input (0 to 1V DC) may be disconnected.
Bit4	Under Range	0	Normal operation
		1	Input value is below the lower limit of the control range (See page A-4). Voltage input (0 to 5V DC) may be disconnected. Current input (4 to 20mA DC) may be disconnected.
Bit5	Program Wait	0	Normal operation
		1	Program wait is functioning
Bit6	Program End Output	0	OFF
		1	ON
Bit7	Alarm 1 Output	0	OFF
		1	ON
Bit8	Alarm 2 Output	0	OFF
		1	ON
Bit9	Alarm 3 Output	0	OFF
		1	ON
Bit10	Alarm 4 Output	0	OFF
		1	ON
Bit11	Alarm 5 Output	0	OFF
		1	ON
Bit12	Alarm 6 Output	0	OFF
		1	ON
Bit13	Alarm 7 Output	0	OFF
		1	ON
Bit14	Alarm 8 Output	0	OFF
		1	ON
Bit15	Reserved	0	0 (Fixed value)

5: DEVICE ALLOCATION OF PID MODULE

Block 1: Write Only Parameters

The CPU module writes the following parameters stored in the data registers to the PID module every scan.

Offset from the Control Register	Parameter	Description	R/W
+20	Set Point (SP)	When the input is thermocouple or resistance thermometer: Set point (SP) lower limit to set point (SP) upper limit When the input is current or voltage input: Linear conversion min. to linear conversion max.	W
+21	When external PV mode is disabled: Manual Mode Output Manipulated Variable	When heating/cooling control is disabled: Output manipulated variable lower limit to output manipulated variable upper limit When heating/cooling control is enabled: - Cooling output manipulated variable upper limit to heating output manipulated variable upper limit	W
	When external PV mode is enabled: External PV Mode Process Variable (PV2)	See the values in "Control Range" on page A-4	
+22	Operation Parameter	Refer to the table below for the operation parameters	W
+23	Set Point (SP)	When the input is thermocouple or resistance thermometer: Set point (SP) lower limit to set point (SP) upper limit When the input is current or voltage input: Linear conversion min. to linear conversion max.	W
+24	When external PV mode is disabled: Manual Mode Output Manipulated Variable	When heating/cooling control is disabled: Output manipulated variable lower limit to output manipulated variable upper limit When heating/cooling control is enabled: - Cooling output manipulated variable upper limit to heating output manipulated variable upper limit	W
	When external PV mode is enabled: External PV Mode Process Variable (PV2)	See the values in "Control Range" on page A-4	
+25	Operation Parameter	See "Operation Parameter Monitor" on page 5-8.	W

Note: When the power to the PID module is turned off, Block 1 parameters are cleared to zero.

Operation Parameters

Bit	Operation Parameters (1 word)		
	Item	Status	Description
Bit0	Control Enable Bit	0	Control disable
		1	Control enable
Bit1	Auto-tuning (AT)/Auto-Reset Bit *1	0	Auto-tuning (AT)/Auto-reset cancel
		1	Auto-tuning (AT)/Auto-reset perform
Bit2	Auto/Manual Mode Bit	0	Auto mode
		1	Manual mode
Bit3	Program Control Bit	0	Program control stop
		1	Program control run
Bit4	Program Hold Bit *2	0	Program control run
		1	Program control hold
Bit5	External SP Input Enable Bit	0	External SP input disable
		1	External SP input enable
Bit6	Advance Next Step Bit *3	0	No action
		1	Program control advance next step
Bit7	Advance Previous Step Bit *4	0	No action
		1	Program control advance previous step
Bit8	External PV Mode Enable Bit *5	0	External PV mode disabled
		1	External PV mode enabled
Bit9	Output when the Process Variable is Out of Range (manual mode only) *6	0	Stop output
		1	Continue output
Bit10 to Bit15	Reserved	0	Fixed value 0

*1 Once auto-reset is performed, it cannot be cancelled during its performance.

*2 The program control is suspended while the program hold bit is on.

*3 During the program control, the current step is terminated and the program control is proceeded to the start of the next step when the advance next step bit is turned off to on.

*4 During the program control, the progression of the program control is moved back when the advance previous step bit is turned off to on. If the elapsed time in the current step is less than 1 minute, the program control goes back to the start of the previous step. If the elapsed time in the current step is more than or equal to 1 minute, the program control goes back to the start of the current step. Even when the advance previous step is executed at Step 0, the program control does not move back to Step 9 regardless of the program end action.

*5 External PV mode is only executed in auto mode. External PV mode is not executed in manual mode, even if enabled.

*6 The output can be selected when in manual mode and the PID control input (process variable) is out of range.

When stop output, the output manipulated variable is set to 0% and the control output turns off.

When continue output, the manual mode output MV is output and the control output turns on or off according to the manual mode output MV.

5: DEVICE ALLOCATION OF PID MODULE

Examples of Program Control Progress

Example 1: Terminate Program Control when Program Ends

The following diagram shows an example of the program control when terminate program control is selected as the program end action.

Time of steps: Step 0 and 1: 60 minutes, Step 2: 30 minutes, Steps 3 to 9: 0 minute

In this example, D1000 is allocated to the control register and M500 is allocated to control relay.

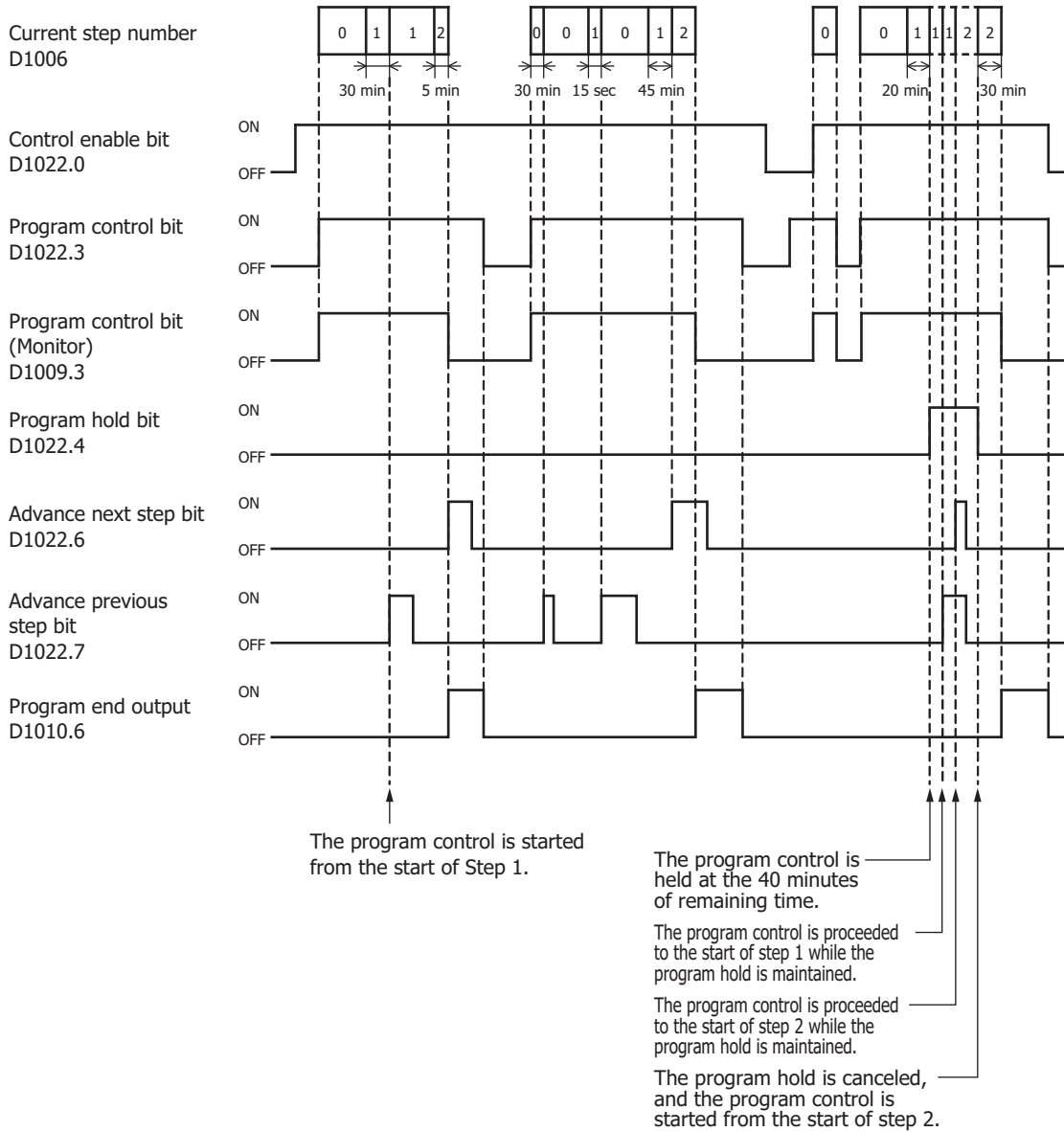

Note: The PID module executes all steps 0 to 9 even if the step times of steps are zero. When the program control is terminated, nine is stored in the current step number of Block 0.

Example 2: Continue Program Control (Repeat) when Program Ends

The following diagram shows an example of the program control when continue program control (repeat) is selected as the program end action.

Time of steps: Step 0 and 1: 60 minutes, Step 2: 30 minutes, Steps 3 to 9: 0 minute

Number of repeats: 1

In this example, D1000 is allocated to the control register and M500 is allocated to control relay.

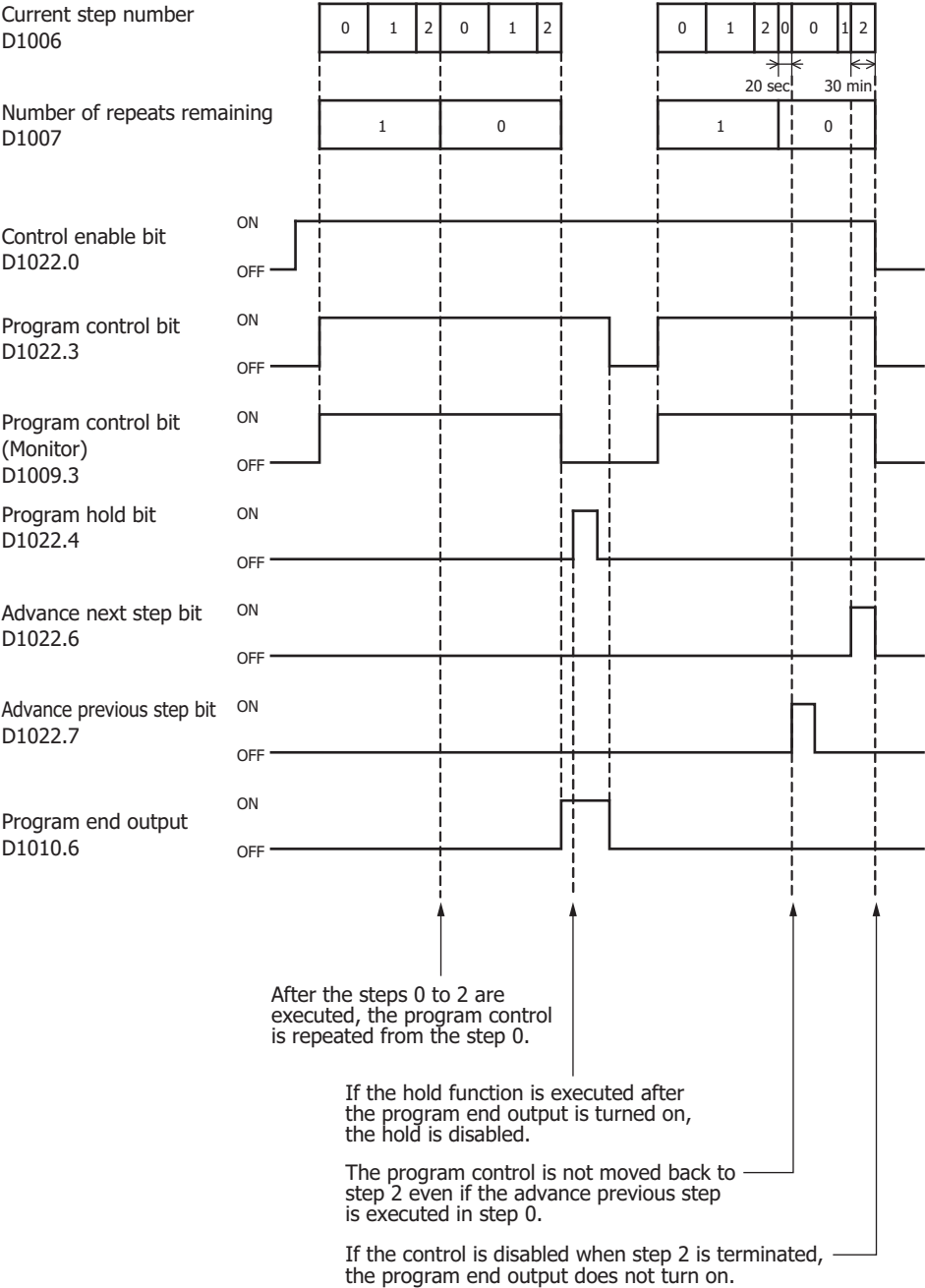

5: DEVICE ALLOCATION OF PID MODULE

Example 3: Continue Program Control (Repeat) when Program Ends

The following diagram shows an example of the program control when continue program control (repeat) is selected as the program end action.

Time of steps: Step 0 and 1: 60 minutes, Step 2: 30 minutes, Steps 3 to 9: 0 minute

Number of repeats: 1

In this example, D1000 is allocated to the control register and M500 is allocated to control relay.

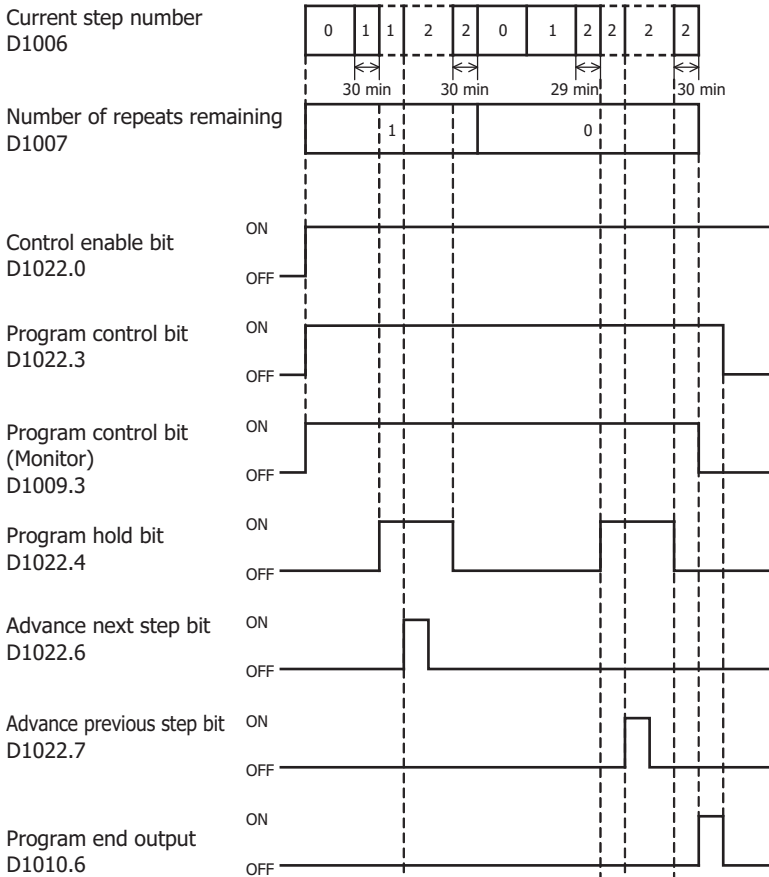

The program control is proceeded to the start of step 2 while the program hold is maintained.

The program control is held at 1 minute of the remaining time. (The program hold works when the remaining time is not zero.)

The program control is proceeded to the start of step 2 while the program hold is maintained.

The program hold is canceled, and the program control is started from the start of step 2.

Example 4: Hold Program Control when Program Ends

The following diagram shows an example of the program control when hold program control is selected as the program end action.

Time of steps: Step 0 and 1: 60 minutes, Step 2: 30 minutes, Steps 3 to 9: 0 minute
 In this example, D1000 is allocated to the control register and M500 is allocated to control relay.

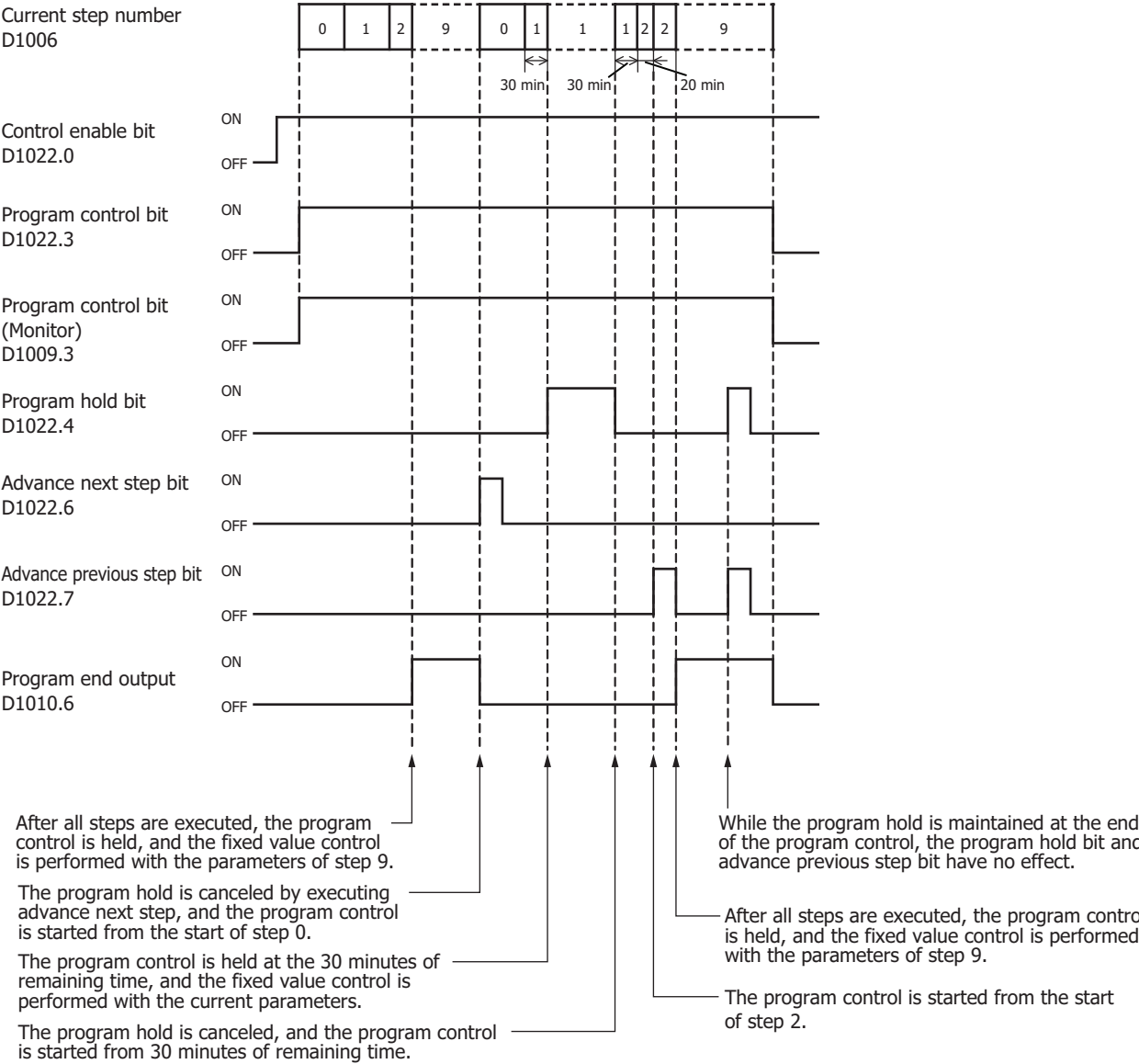

Note: The PID module executes all steps 0 to 9 even if the step times of steps are zero. When the program control is terminated, nine is stored in the current step number of Block 0.

5: DEVICE ALLOCATION OF PID MODULE

Example 5: Hold Program Control when Program Ends

The following diagram shows an example of the program control when hold program control is selected as the program end action.

Time of steps: Step 0 and 1: 60 minutes, Step 2: 30 minutes, Steps 3 to 9: 0 minute

In this example, D1000 is allocated to the control register and M500 is allocated to control relay.

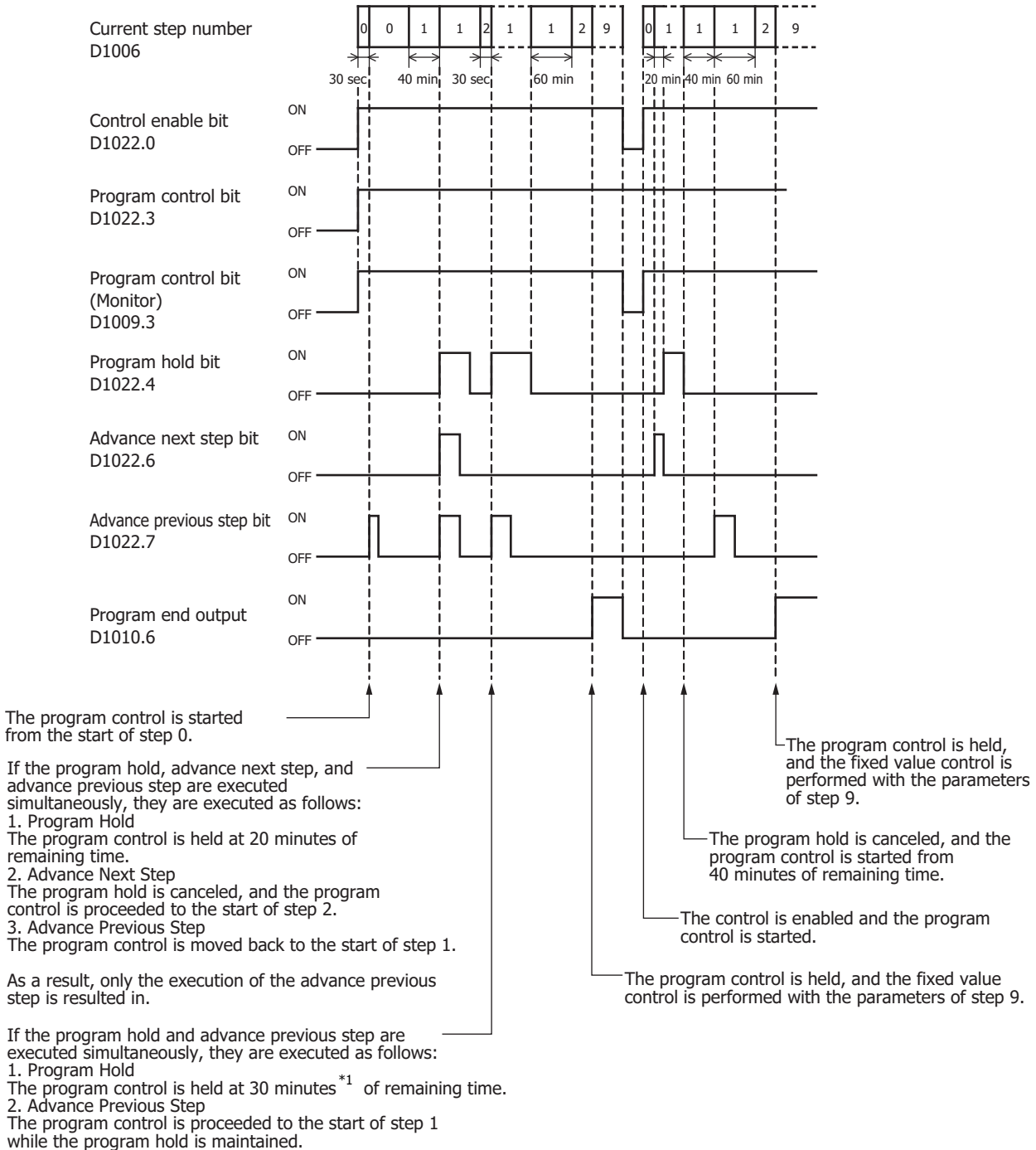

*1 If minute is selected as the step time unit, the remaining time is handled with the unit of minute. If the remaining time is between 29 minutes 1 second and 30 minutes 0 second, the remaining time will be 30 minutes.

Example 6: Hold Program Control when Program Ends

The following diagram shows an example of the program control when hold program control is selected as the program end action.

Time of steps: Step 0 and 1: 60 minutes, Step 2: 30 minutes, Steps 3 to 9: 0 minute
 In this example, D1000 is allocated to the control register and M500 is allocated to control relay.

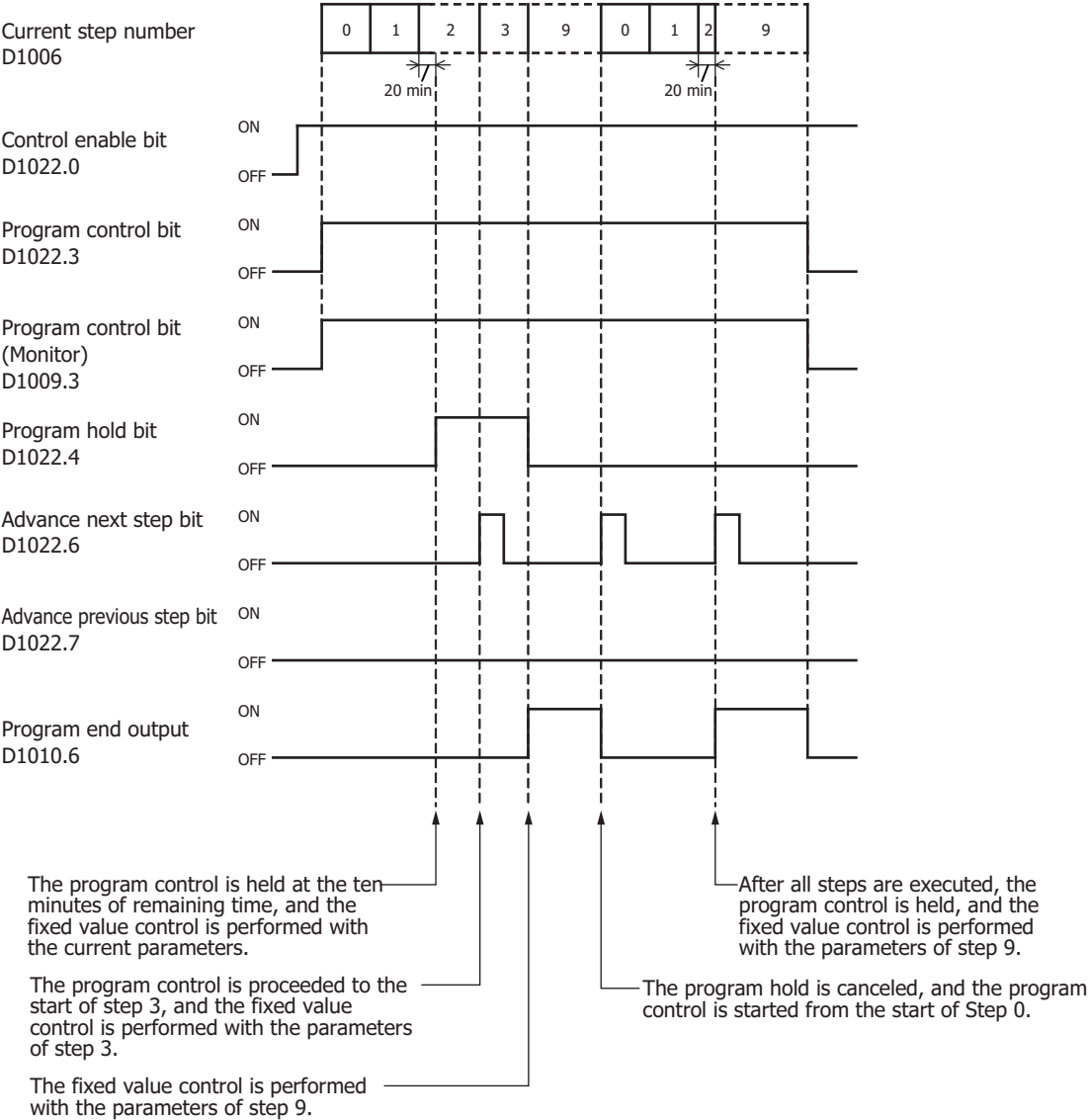

Notes:

- The PID module executes all steps 0 to 9 even if the times of steps are zero. When the program control is terminated, nine is stored in the current step number of Block 0.
- When hold program control is selected as the program end action, the program control is held, and the fixed value control is performed with the parameters of step 9 after all steps are executed.

5: DEVICE ALLOCATION OF PID MODULE

Blocks 2, 3: Basic Parameters (SHOT Action)

Block 2 (CH0 control) and Block 3 (CH1 control) parameters are shown in the table below. The parameters of Block 2 and 3 can be changed while the control of the PID module is enabled.

Offset from the Control Register		Parameter	Description	R/W
CH0	CH1			
+26	+103	Proportional Term	Proportional band: When input range unit is Celsius: 0 to 10,000°C (Range with a decimal point: 0.0 to 1,000.0°C) When input range unit is Fahrenheit: 0 to 10,000°F (Range with a decimal point: 0.0 to 1,000.0°F) When input is voltage or current input: 0.0 to 1,000.0% Proportional gain: 0.00 to 100.00%	R/W
+27	+104	Integral Time	0 to 10,000 sec	R/W
+28	+105	Derivative Time	0 to 10,000 sec	R/W
+29	+106	ARW (Anti-Reset Windup)	0 to 100%	R/W
+30	+107	Control Period	1 to 120 sec	R/W
+31	+108	Reset	When input range unit is Celsius: -100.0 to 100.0°C When input range unit is Fahrenheit: -100.0 to 100.0°F When input is voltage or current input: -1,000 to 1,000	R/W
+32	+109	Output Manipulated Variable Rate-of-Change	0 to 100%/sec	R/W
+33	+110	Set Point (SP) Rise Rate	When input range unit is Celsius: 0 to 10,000°C/min (Range with a decimal point: 0.0 to 1,000.0°C/min) When input range unit is Fahrenheit: 0 to 10,000°F/min (Range with a decimal point: 0.0 to 1,000.0°F/min) When input is voltage or current input: 0 to 10,000/min	R/W
+34	+111	Set Point (SP) Fall Rate	When input range unit is Celsius: 0 to 10,000°C/min (Range with a decimal point: 0.0 to 1,000.0°C/min) When input range unit is Fahrenheit: 0 to 10,000°F/min (Range with a decimal point: 0.0 to 1,000.0°F/min) When input is voltage or current input: 0 to 10,000/min	R/W
+35	+112	Loop Break Alarm (LA) Time	0 to 200 minutes	R/W
+36	+113	Loop Break Alarm (LA) Span	When input range unit is Celsius: 0 to 150°C (Range with a decimal point: 0.0 to 150.0°C) When input range unit is Fahrenheit: 0 to 150°F (Range with a decimal point: 0.0 to 150.0°F) When input is voltage or current input: 0 to 1,500	R/W
+37	+114	Alarm 1 Value	See "Valid Range for Alarm 1 to Alarm 8 Settings" on page 5-19.	R/W
+38	+115	Alarm 2 Value		R/W
+39	+116	Alarm 3 Value		R/W
+40	+117	Alarm 4 Value		R/W
+41	+118	Alarm 5 Value		R/W
+42	+119	Alarm 6 Value		R/W
+43	+120	Alarm 7 Value		R/W
+44	+121	Alarm 8 Value		R/W
+45	+122	Reserved		R/W
+46	+123	Output Manipulated Variable Upper Limit	When output type is relay or voltage: Output manipulated variable lower limit to 100% When output type is current: Output manipulated variable lower limit to 105%	R/W
+47	+124	Output Manipulated Variable Lower Limit	When output type is relay or voltage: 0% to output manipulated variable upper limit When output type is current: -5% to output manipulated variable upper limit	R/W
+48	+125	Cooling Proportional Band (CH0 only)	0.0 to 10.0 times (Cooling proportional band is the multiplication of heating proportional band)	R/W

Offset from the Control Register		Parameter	Description	R/W
CH0	CH1			
+49	+126	Cooling Control Period (CH0 only)	1 to 120 sec	R/W
+50	+127	Overlap/Dead Band (CH0 only)	When input range unit is Celsius: -200.0 to 200.0°C When input range unit is Fahrenheit: -200.0 to 200.0°F When input is voltage or current input: -2,000 to 2,000	R/W
+51	+128	Cooling Output Manipulated Variable Upper Limit (CH0 only)	When output type is relay or voltage: Cooling output manipulated variable lower limit to 100% When output type is current: Cooling output manipulated variable lower limit to 105%	R/W
+52	+129	Cooling Output Manipulated Variable Lower Limit (CH0 only)	When output type is relay or voltage: 0% to cooling output manipulated variable upper limit When output type is current: -5% to cooling output manipulated variable upper limit	R/W

Valid Range for Alarm 1 to Alarm 8 Settings

Alarm Type	Valid Range
Upper Limit Alarm	-(Full scale) to full scale *1
Lower Limit Alarm	-(Full scale) to full scale *1
Upper/Lower Limits Alarm	0 to full scale *1
Upper/Lower Limit Range Alarm	0 to full scale *1
Process High Alarm	Input range lower limit to input range upper limit *2
Process Low Alarm	Input range lower limit to input range upper limit *2
Upper Limit Alarm with Standby	-(Full scale) to full scale *1
Lower Limit Alarm with Standby	-(Full scale) to full scale *1
Upper/Lower Limits Alarm with Standby	0 to full scale *1

*1 When input is voltage/current, full scale is the linear conversion span.

*2 When input is voltage/current, the valid range is the linear conversion minimum value to linear conversion maximum value.

5: DEVICE ALLOCATION OF PID MODULE

Blocks 4, 5: Initial Setting Parameters (SHOT Action)

Block 4 (CH0 control) and Block 5 (CH1 control) parameters are shown in the table below. Before changing the parameters of Block 4 or 5, it is recommended that the control of the PID module be disabled.

Offset from the Control Register		Parameter	Description	R/W
CH0	CH1			
+53	+130	Control Action	0: Reverse control action (Heating) 1: Direct control action (Cooling)	R/W
+54	+131	Heating/Cooling Control (CH0 only)	0: Disable 1: Enable	R/W
+55	+132	External SP Input (CH0 only)	0: Disabled 1: External SP input (4 to 20mA DC) 2: External SP input (0 to 20mA DC) 3: External SP input (1 to 5V DC) 4: External SP input (0 to 1V DC) 5: Cascade control	R/W
+56	+133	Input Function	0: Input (CH0/CH1) 1: Difference input (CH0 - CH1) 2: Difference input (CH1 - CH0) 3: Addition input (CH0 + CH1)	R/W
+57	-	Output Function (CH0)	0: Output (CH0) 1: Output (CH1) 2: Both outputs (CH0, CH1)	R/W
-	+134	Output Function (CH1)	0: Output(CH1) Output Function (CH0) has priority.	R/W
+58	+135	Input Type	See "Input Range" on page 5-22.	R/W
+59	+136	Set Point (SP) Upper Limit/ Linear Conversion Maximum Value	When input is thermocouple or resistance thermometer: Set point (SP) lower limit to input range upper limit When input is voltage or current input: Linear conversion minimum to input range upper limit	R/W
+60	+137	Set Point (SP) Lower Limit/ Linear Conversion Minimum Value	When input is thermocouple or resistance thermometer: Input range lower limit to set point (SP) upper limit When input is voltage or current input: Input range lower limit to linear conversion maximum	R/W
+61	+138	Output ON/OFF Hysteresis	When input range unit is Celsius: 0.1 to 100.0°C When input range unit is Fahrenheit: 0.1 to 100.0°F When input is voltage or current input: 1 to 1,000	R/W
+62	+139	PV Correction	When input range unit is Celsius: -100.0 to 100.0°C When input range unit is Fahrenheit: -100.0 to 100.0°F When input is voltage or current input: -1,000 to 1,000	R/W
+63	+140	PV Filter Time Constant	0.0 to 10.0 sec	R/W
+64	+141	Reserved		R/W
+65	+142	Alarm 1 Type	0: No alarm action	R/W
+66	+143	Alarm 2 Type	1: Upper limit alarm	R/W
+67	+144	Alarm 3 Type	2: Lower limit alarm	R/W
+68	+145	Alarm 4 Type	3: Upper/Lower limits alarm	R/W
+69	+146	Alarm 5 Type	4: Upper/Lower limit range alarm	R/W
+70	+147	Alarm 6 Type	5: Process high alarm	R/W
+71	+148	Alarm 7 Type	6: Process low alarm	R/W
+72	+149	Alarm 8 Type	7: Upper limit alarm with standby 8: Lower limit alarm with standby 9: Upper/Lower limits alarm with standby	R/W

Offset from the Control Register		Parameter	Description	R/W
CH0	CH1			
+73	+150	Alarm 1 Hysteresis	When input range unit is Celsius: 0.1 to 100.0°C When input range unit is Fahrenheit: 0.1 to 100.0°F When input is voltage or current input: 1 to 1,000	R/W
+74	+151	Alarm 2 Hysteresis		R/W
+75	+152	Alarm 3 Hysteresis		R/W
+76	+153	Alarm 4 Hysteresis		R/W
+77	+154	Alarm 5 Hysteresis		R/W
+78	+155	Alarm 6 Hysteresis		R/W
+79	+156	Alarm 7 Hysteresis		R/W
+80	+157	Alarm 8 Hysteresis		R/W
+81	+158	Alarm 1 Delay Time	0 to 10,000 sec	R/W
+82	+159	Alarm 2 Delay Time		R/W
+83	+160	Alarm 3 Delay Time		R/W
+84	+161	Alarm 4 Delay Time		R/W
+85	+162	Alarm 5 Delay Time		R/W
+86	+163	Alarm 6 Delay Time		R/W
+87	+164	Alarm 7 Delay Time		R/W
+88	+165	Alarm 8 Delay Time		R/W
+89	+166	AT Bias	When input range unit is Celsius: 0 to 50°C (0.0 to 50.0°C for input with decimal point) When input range unit is Fahrenheit: 0 to 100°F (0.0 to 100.0°F for input with decimal point)	R/W
+90	+167	Control Mode	0: Fixed value control mode 1: Program control mode	R/W
+91	+168	Program Control Mode Start Type	0: PV start 1: PVR start 2: SP start	R/W
+92	+169	Step Time Unit	0: Minute 1: Second	R/W
+93	+170	Program End Action	0: Terminate program control 1: Continue program control (Repeat) 2: Hold program control	R/W
+94	+171	Proportional Term	0: Proportional band 1: Proportional gain	R/W
+95	+172	Cooling Method (CH0 only)	0: Air cooling 1: Oil cooling 2: Water cooling	R/W
+96	+173	Set Point (SP) when Program Control Starts	When input is thermocouple or resistance thermometer: Set point (SP) lower limit to set point (SP) upper limit When input is voltage or current input: Linear conversion min. to linear conversion max.	R/W
+97	+174	Number of Repeats	0 to 10,000 times	R/W
+98	+175	Cooling Output ON/OFF Hysteresis (CH0 only)	When input range unit is Celsius: 0.1 to 100.0°C When input range unit is Fahrenheit: 0.1 to 100.0°F When input is voltage or current input: 1 to 1,000	R/W
+99	+176	Output Type (FC6A-F2M1 only)	0: Non-contact voltage output (for SSR drive) 1: Current output	R/W
+100	+177	External SP Input Bias (CH1 only)	±20% of the external SP input linear conversion span	R/W
+101	+178	External SP Input Linear Conversion Maximum Value (CH1 only)	External SP input Linear conversion min. to input range upper limit	R/W
+102	+179	External SP Input Linear Conversion Minimum Value (CH1 only)	Input range lower limit to external SP input linear conversion max.	R/W

5: DEVICE ALLOCATION OF PID MODULE

Input Range

Input Range			Range		Unit			
			PV	PV1/PV2	PV	PV1/PV2		
00h	Type K Thermocouple	Celsius	-200 to 1,370°C	-200.0 to 1,370.0°C	1°C	0.1°C		
01h	Type K Thermocouple with Decimal Point		-200.0 to 400.0°C	-200.0 to 400.0°C	0.1°C			
02h	Type J Thermocouple		-200 to 1,000°C	-200.0 to 1,000.0°C	1°C			
03h	Type R Thermocouple		0 to 1,760°C	0.0 to 1,760.0°C	1°C			
04h	Type S Thermocouple		0 to 1,760°C	0.0 to 1,760.0°C	1°C			
05h	Type B Thermocouple		0 to 1,820°C	0.0 to 1,820.0°C	1°C			
06h	Type E Thermocouple		-200 to 800°C	-200.0 to 800.0°C	1°C			
07h	Type T Thermocouple		-200.0 to 400.0°C	-200.0 to 400.0°C	0.1°C			
08h	Type N Thermocouple		-200 to 1,300°C	-200.0 to 1,300.0°C	1°C			
09h	PL-II		0 to 1,390°C	0.0 to 1,390.0°C	1°C			
0Ah	C(W/Re5-26)		0 to 2,315°C	0.0 to 2,315.0°C	1°C			
0Bh	Pt100 with Decimal Point		-200.0 to 850.0°C	-200.0 to 850.0°C	0.1°C			
0Ch	JPt100 with Decimal Point		-200.0 to 500.0°C	-200.0 to 500.0°C	0.1°C			
0Dh	Pt100		-200 to 850°C	-200.0 to 850.0°C	1°C			
0Eh	JPt100		-200 to 500°C	-200.0 to 500.0°C	1°C			
0Fh	Type K Thermocouple		Fahrenheit	-328 to 2,498°F	-328.0 to 2,498.0°F		1°F	0.1°F
10h	Type K Thermocouple with Decimal Point			-328.0 to 752.0°F	-328.0 to 752.0°F		0.1°F	
11h	Type J Thermocouple	-328 to 1,832°F		-328.0 to 1,832.0°F	1°F			
12h	Type R Thermocouple	32 to 3,200°F		32.0 to 3,200.0°F	1°F			
13h	Type S Thermocouple	32 to 3,200°F		32.0 to 3,200.0°F	1°F			
14h	Type B Thermocouple	32 to 3,308°F		32.0 to 3,308.0°F	1°F			
15h	Type E Thermocouple	-328 to 1,472°F		-328.0 to 1,472.0°F	1°F			
16h	Type T Thermocouple	-328.0 to 752.0°F		-328.0 to 752.0°F	0.1°F			
17h	Type N Thermocouple	-328 to 2,372°F		-328.0 to 2,372.0°F	1°F			
18h	PL-II	32 to 2,534°F		32.0 to 2,534.0°F	1°F			
19h	C(W/Re5-26)	32 to 4,199°F		32.0 to 4,199.0°F	1°F			
1Ah	Pt100 with Decimal Point	-328.0 to 1,562.0°F		-328.0 to 1,562.0°F	0.1°F			
1Bh	JPt100 with Decimal Point	-328.0 to 932.0°F		-328.0 to 932.0°F	0.1°F			
1Ch	Pt100	-328 to 1,562°F		-328.0 to 1,562.0°F	1°F			
1Dh	JPt100	-328 to 932°F		-328.0 to 932.0°F	1°F			
1Eh	4 to 20 mA	—		-2,000 to 10,000*1	-2,000 to 10,000	1	1	
1Fh	0 to 20 mA							
20h	0 to 1 V							
21h	0 to 5 V							
22h	1 to 5 V							
23h	0 to 10 V							

*1 Linear conversion is possible in the range of minimum linear conversion value to maximum linear conversion value.

Blocks 10-19: Program (CH0) Parameters (SHOT Action)

When CH0 control is in program control mode, Block 10 to 19 should be configured. A maximum of ten steps from step 0 to step 9 can be configured. All parameters of Block 10 to 19 are shown in the following tables. For detail about each parameter, see "PID Module Configuration - Program Parameters Details" on page 6-48.

Offset from the Control Register					Parameter
Step 0	Step 1	Step 2	Step 3	Step 4	
+180	+201	+222	+243	+264	Set point (SP)
+181	+202	+223	+244	+265	Step time
+182	+203	+224	+245	+266	Wait value
+183	+204	+225	+246	+267	Proportional term
+184	+205	+226	+247	+268	Integral time
+185	+206	+227	+248	+269	Derivative time
+186	+207	+228	+249	+270	ARW (Anti-Reset Windup)
+187	+208	+229	+250	+271	Output manipulated variable rate-of-change
+188	+209	+230	+251	+272	Alarm 1 value
+189	+210	+231	+252	+273	Alarm 2 value
+190	+211	+232	+253	+274	Alarm 3 value
+191	+212	+233	+254	+275	Alarm 4 value
+192	+213	+234	+255	+276	Alarm 5 value
+193	+214	+235	+256	+277	Alarm 6 value
+194	+215	+236	+257	+278	Alarm 7 value
+195	+216	+237	+258	+279	Alarm 8 value
+196	+217	+238	+259	+280	Reserved
+197	+218	+239	+260	+281	Output manipulated variable upper limit
+198	+219	+240	+261	+282	Output manipulated variable lower limit
+199	+220	+241	+262	+283	Cooling proportional band
+200	+221	+242	+263	+284	Overlap/Dead band

Offset from the Control Register					Parameter
Step 5	Step 6	Step 7	Step 8	Step 9	
+285	+306	+327	+348	+369	Set point (SP)
+286	+307	+328	+349	+370	Step time
+287	+308	+329	+350	+371	Wait value
+288	+309	+330	+351	+372	Proportional term
+289	+310	+331	+352	+373	Integral time
+290	+311	+332	+353	+374	Derivative time
+291	+312	+333	+354	+375	ARW (Anti-Reset Windup)
+292	+313	+334	+355	+376	Output manipulated variable rate-of-change
+293	+314	+335	+356	+377	Alarm 1 value
+294	+315	+336	+357	+378	Alarm 2 value
+295	+316	+337	+358	+379	Alarm 3 value
+296	+317	+338	+359	+380	Alarm 4 value
+297	+318	+339	+360	+381	Alarm 5 value
+298	+319	+340	+361	+382	Alarm 6 value
+299	+320	+341	+362	+383	Alarm 7 value
+300	+321	+342	+363	+384	Alarm 8 value
+301	+322	+343	+364	+385	Reserved
+302	+323	+344	+365	+386	Output manipulated variable upper limit
+303	+324	+345	+366	+387	Output manipulated variable lower limit
+304	+325	+346	+367	+388	Cooling proportional band
+305	+326	+347	+368	+389	Overlap/Dead band

5: DEVICE ALLOCATION OF PID MODULE

Program Parameters

Parameter	Description	R/W
Set Point (SP)	When input is thermocouple or resistance thermometer: Set point (SP) lower limit to set point (SP) upper limit When input is voltage or current input: Linear conversion min. to linear conversion max.	R/W
Step Time	When step time unit is Minute: 0 to 6,000 minutes When step time unit is Second: 0 to 6,000 seconds	R/W
Wait Value	When input range unit is Celsius: 0 to 100°C (Range with a decimal point: 0.0 to 100.0°C) When input range unit is Fahrenheit: 0 to 100°F (Range with a decimal point: 0.0 to 100.0°F) When input is voltage or current input: 0 to 1,000	R/W
Proportional Term	Proportional band: When input range unit is Celsius: 0 to 10,000°C (Range with a decimal point: 0.0 to 1,000.0°C) When input range unit is Fahrenheit: 0 to 10,000°F (Range with a decimal point: 0.0 to 1,000.0°F) When input is voltage or current input: 0.0 to 1,000.0% Proportional gain: 0.00 to 100.00%	R/W
Integral Time	0 to 10,000 sec	R/W
Derivative Time	0 to 10,000 sec	R/W
ARW (Anti-Reset Windup)	0 to 100%	R/W
Output Manipulated Variable Rate-of-Change	0 to 100%/sec	R/W
Alarm 1 Value	See "Valid Range for Alarm 1 to Alarm 8 Settings" on page 5-19.	R/W
Alarm 2 Value		R/W
Alarm 3 Value		R/W
Alarm 4 Value		R/W
Alarm 5 Value		R/W
Alarm 6 Value		R/W
Alarm 7 Value		R/W
Alarm 8 Value		R/W
Reserved		R/W
Output Manipulated Variable Upper Limit	When output type is relay or voltage: Output manipulated variable lower limit to 100% When output type is current: Output manipulated variable lower limit to 105%	R/W
Output Manipulated Variable Lower Limit	When output type is relay or voltage: 0% to output manipulated variable upper limit When output type is current: -5% to output manipulated variable upper limit	R/W
Cooling Proportional Band (CH0 only)	0.0 to 10.0 times (Cooling proportional band is the multiplication of heating proportional band)	R/W
Overlap/Dead Band (CH0 only)	When input range unit is Celsius: -200.0 to 200.0°C When input range unit is Fahrenheit: -200.0 to 200.0°F When input is voltage or current input: -2,000 to 2,000	R/W

Blocks 30-39: Program (CH1) Parameters (SHOT Action)

When CH1 control is in program control mode, Block 30 to 39 should be configured. A maximum of ten steps from step 0 to step 9 can be configured. All parameters of Block 30 to 39 are shown in the following tables. For detail about each parameter, see "PID Module Configuration - Program Parameters Details" on page 6-48.

Offset from the Control Register					Parameter
Step 0	Step 1	Step 2	Step 3	Step 4	
+390	+409	+428	+447	+466	Set point (SP)
+391	+410	+429	+448	+467	Step time
+392	+411	+430	+449	+468	Wait value
+393	+412	+431	+450	+469	Proportional term
+394	+413	+432	+451	+470	Integral time
+395	+414	+433	+452	+471	Derivative time
+396	+415	+434	+453	+472	ARW (Anti-Reset Windup)
+397	+416	+435	+454	+473	Output manipulated variable rate-of-change
+398	+417	+436	+455	+474	Alarm 1 value
+399	+418	+437	+456	+475	Alarm 2 value
+400	+419	+438	+457	+476	Alarm 3 value
+401	+420	+439	+458	+477	Alarm 4 value
+402	+421	+440	+459	+478	Alarm 5 value
+403	+422	+441	+460	+479	Alarm 6 value
+404	+423	+442	+461	+480	Alarm 7 value
+405	+424	+443	+462	+481	Alarm 8 value
+406	+425	+444	+463	+482	Reserved
+407	+426	+445	+464	+483	Output manipulated variable upper limit
+408	+427	+446	+465	+484	Output manipulated variable lower limit

Offset from the Control Register					Parameter
Step 5	Step 6	Step 7	Step 8	Step 9	
+485	+504	+523	+542	+561	Set point (SP)
+486	+505	+524	+543	+562	Step time
+487	+506	+525	+544	+563	Wait value
+488	+507	+526	+545	+564	Proportional term
+489	+508	+527	+546	+565	Integral time
+490	+509	+528	+547	+566	Derivative time
+491	+510	+529	+548	+567	ARW (Anti-Reset Windup)
+492	+511	+530	+549	+568	Output manipulated variable rate-of-change
+493	+512	+531	+550	+569	Alarm 1 value
+494	+513	+532	+551	+570	Alarm 2 value
+495	+514	+533	+552	+571	Alarm 3 value
+496	+515	+534	+553	+572	Alarm 4 value
+497	+516	+535	+554	+573	Alarm 5 value
+498	+517	+536	+555	+574	Alarm 6 value
+499	+518	+537	+556	+575	Alarm 7 value
+500	+519	+538	+557	+576	Alarm 8 value
+501	+520	+539	+558	+577	Reserved
+502	+521	+540	+559	+578	Output manipulated variable upper limit
+503	+522	+541	+560	+579	Output manipulated variable lower limit

6: CONFIGURING PID MODULE USING WINDLDR

This chapter describes configuration procedure of the PID modules using WindLDR, PID module configuration dialogs, and monitoring.

Procedure to configure the PID module

This chapter describes the procedures for configuring PID module parameters in the Module Configuration Editor.

1. Module Configuration Editor

Start the Module Configuration Editor with either of the following procedures.

Procedure 1:

1. From the WindLDR menu bar, select **View** > **Project Window** to open the Project Window.
2. Double click **Expansion Modules** in the Project window.

Procedure 2:

1. From the WindLDR menu bar, select **Configuration** > **PLCs** > **Expansion Modules**.

Module Configuration Editor

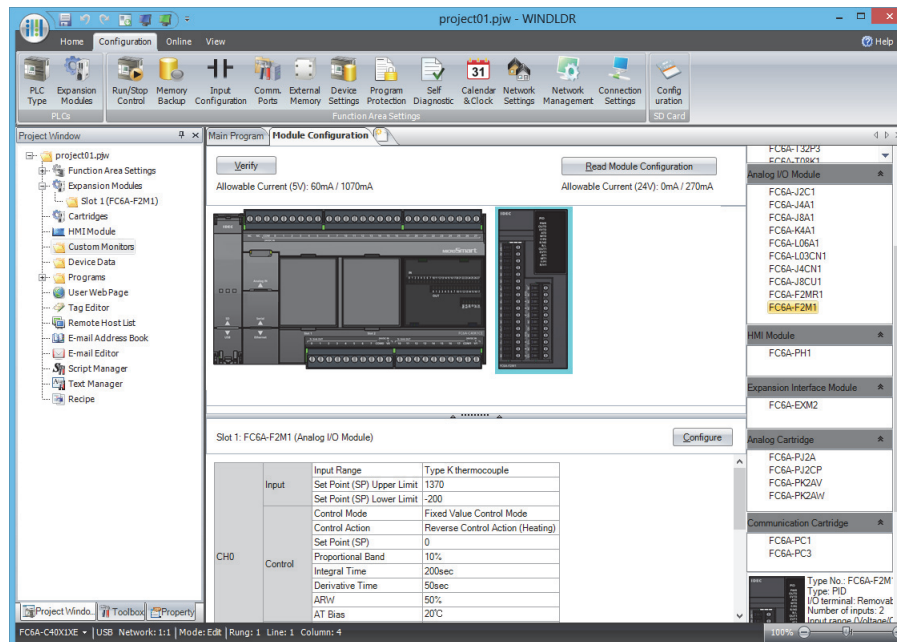

Select the expansion module or cartridge to insert in the expansion modules and cartridges list and drag and drop it to the module configuration area.

Select a PID module and click **Configure** to open the **PID Module Configuration** dialog box.

6: CONFIGURING PID MODULE USING WINDLDR

2. PID Module Configuration Dialog Box

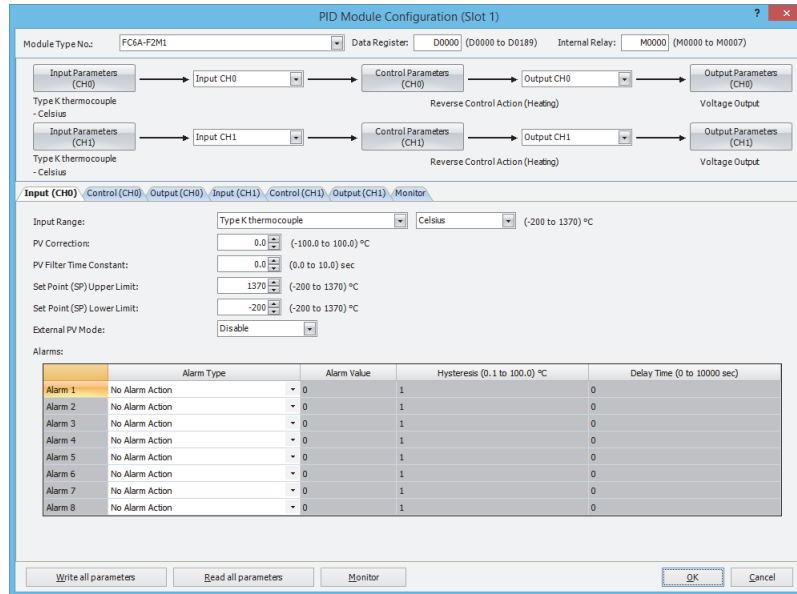

All parameters for the PID module can be configured in this dialog box. Configure the desired parameters and click on **OK** button to close the dialog.

3. Download Dialog Box

From the WindLDR menu bar, on the **Online** tab, in the **Transfer** group, click **Download**. The **Download** dialog box is displayed.

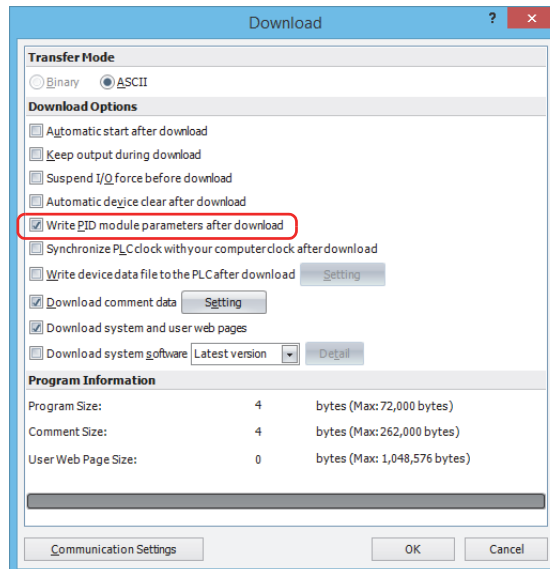

Click the check box on the left of **Write PID module parameters after download** and click **OK** button. The user program will be downloaded. After downloading the user program, the PID module parameters will be automatically written to the data registers in the CPU module and the PID module connected to the CPU module.

Note: The CPU module and the connected PID module exchange data through the allocated data registers in the CPU module. In order for the CPU module to communicate with the PID Module, it is required that the user program be downloaded to the CPU module after configuring the PID Module in the Expansion Modules Configuration dialog box. In order for the PID module to operate, it is required that the parameters be written to the data registers in the CPU module and the PID module.

Writing and Reading Parameters

When **Write All Parameters** or **Read All Parameters** is executed in the **PID Module Configuration** dialog box, all parameters will be written to/read from the PID module as follows.

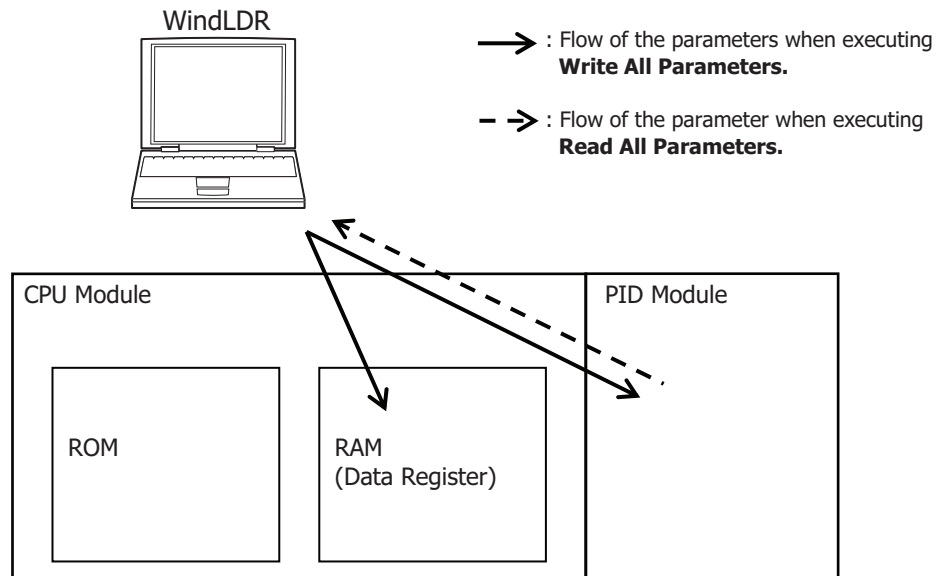

Downloading and Uploading User Program

When the user program download*¹ or upload is executed, the user program is downloaded to/uploaded from the CPU module as follows.

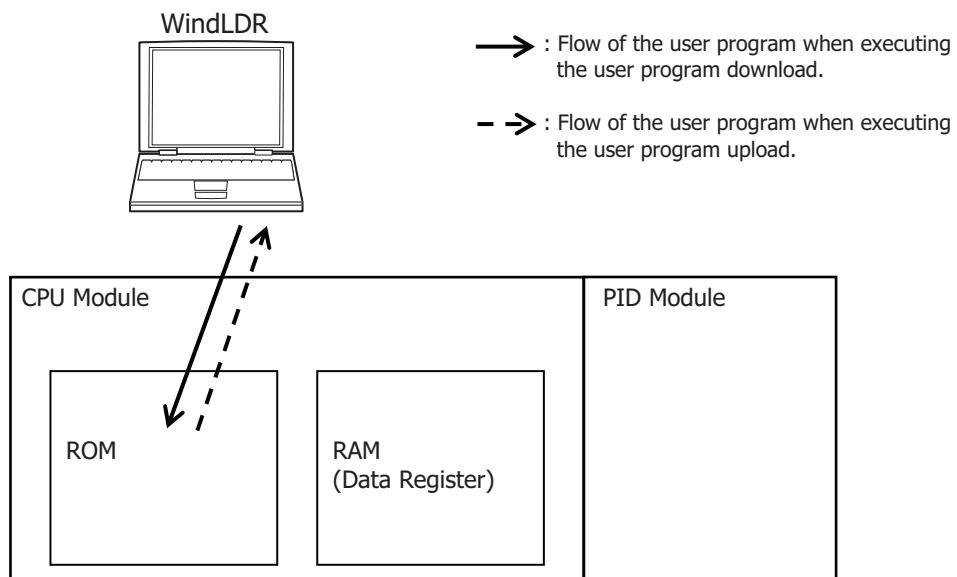

*1 When the **Write PID module parameters after download** check box is selected in the **Download** dialog box, the parameters will be written after the user program is downloaded to the CPU module. The PID module parameters are written to the data registers in the CPU module and the PID modules with the slot numbers that were inserted with the Module Configuration Editor. For details, see "User Program Download" on page 6-4.

6: CONFIGURING PID MODULE USING WINDLDR

User Program Download

The user program contains the user program and the PID module parameters (initial values) configured in the **PID Module Configuration** dialog box. After the user program is downloaded to the CPU module, the CPU module can communicate with the PID Modules through the allocated data registers.

The user program download operates as follows depending on whether the **Write PID module parameters after download** check box in the **Download** dialog box is checked or not.

(1) Check box selected:

After the user program is downloaded to the CPU module, the PID module parameters configured in the **PID Module Configuration** dialog box are written to the CPU module and the connected PID modules.

(2) Check box cleared:

After the user program is downloaded to the CPU module, the PID module parameters are not written to the PID module.

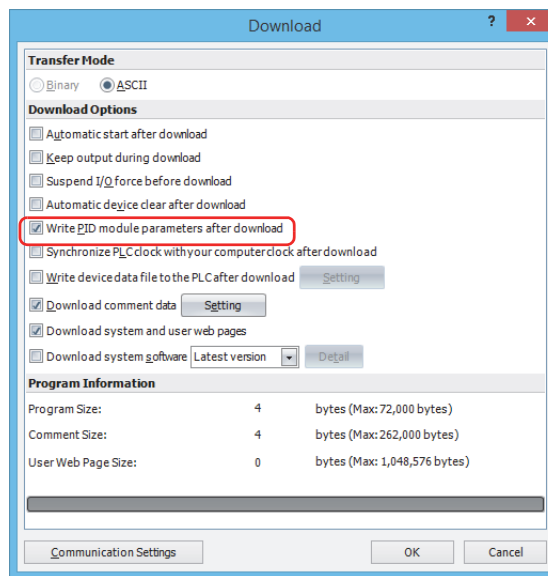

When the **Write PID module parameters after download** check box is selected, after the user program is downloaded to the CPU module, the parameters configured in the **PID Module Configuration** dialog box will be written to the data registers in the CPU module and the PID modules with the slot numbers that were inserted with the Module Configuration Editor.

However, if a PID module with the inserted slot number is not connected to the CPU module, writing parameters to the PID module will fail. Even after an error occurs, WindLDR continues to write the parameters to the PID modules with the slot numbers that were inserted with the Module Configuration Editor.

If writing parameters fails, connect the PID module to the CPU module and write parameters to the PID module again.

To write the PID module parameters without downloading the user program to the CPU module, take the following steps:

1. Connect the PID modules for the slot numbers that were inserted with Module Configuration Editor.
2. Display the **PID Module Configuration** dialog box for the PID module in that slot number.
3. Click on **Write All Parameters** button.

All the configured parameters will be written to the data registers in the CPU module and the PID module.

User Program Upload

When the user program containing the initial parameters of the PID modules is uploaded from the CPU module, the initial values will be restored. The parameters saved in the PID module will not be read.

How to restore data register values when a keep data error has occurred

If more than 30 days pass since the power to the CPU module is turned off, values stored in the data registers will be lost. When the data register values are lost, after the power is turned on, restore the PID module parameters in the data registers of the CPU module using either of the following methods, and then enable the control of the PID module.

Method 1: Use the parameters stored in the PID module

The parameters stored in the PID module can be read out and stored in the data registers of the CPU module with one of the following procedures:

Procedure 1: Using WindLDR

1. Start the Module Configuration Editor in WindLDR.
2. Open the **PID Module Configuration** dialog box for the connected PID module.
3. Click on **Read All Parameters** button to read all parameters from the PID module.
4. **Configure the set point (SP)** and the manual mode output manipulated variable in the PID Module Configuration dialog box. ^{*1}
5. Click on **Write All Parameters** button.

When the control of the PID module is enabled, the PID module will start operating with the downloaded parameters.

Procedure 2: Using the user program

1. Turn off to on the reading all parameters relay (control relay + 0).
 2. Configure the set point (SP) and the manual mode output manipulated variable if necessary. ^{*1}
- When the control of the PID module is enabled, the PID module will start operating with the configured parameters.

^{*1} Because the block 1 parameters are not saved in the PID module, it is required to configure those parameters.

Method 2: Use the default parameters stored in the ROM of the CPU module

When the PID module parameters are configured in the **PID Module Configuration** dialog box and the user program is downloaded to the CPU module, the PID module parameters (initial values) will be saved in ROM of the CPU module. Those initial values can be loaded to the data registers in the CPU module, and the PID module can be operated with those initial values with the following procedure:

1. Turn off to on the loading initial values relay (control relay + 1).
2. Turn off to on the writing all parameters relay (control relay + 2).

When the control of the PID module is enabled, the PID module will start operating with the default values.

6: CONFIGURING PID MODULE USING WINDLDR

Module Configuration Editor Description

This section describes the Module Configuration Editor areas and functions.

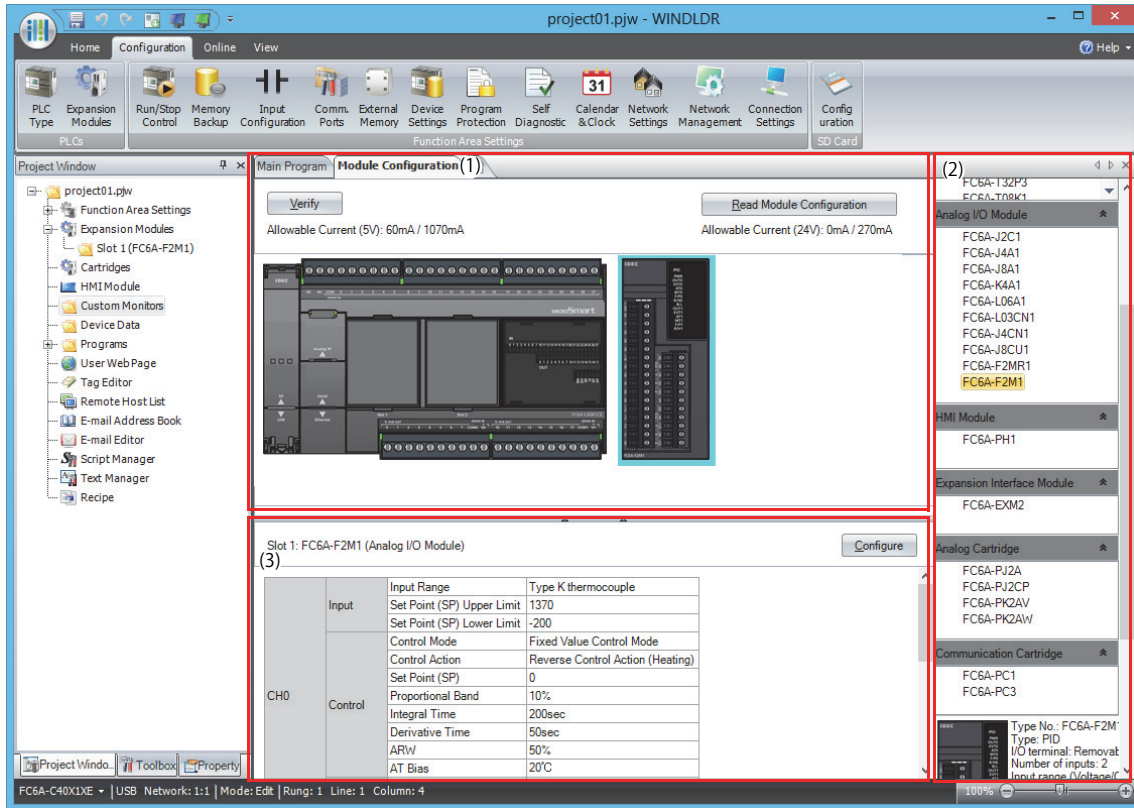

Areas

The Module Configuration Editor is composed of the following three areas.

	Item	Details
(1)	Module configuration area	Displays the configuration of connected expansion modules and cartridges.
(2)	Expansion modules and cartridges list	Displays a list of expansion modules and cartridges that can be connected to the FC6A Series MicroSmart.
(3)	Parameter reference area	Displays the parameters that are configured for the expansion modules and cartridges.

Function

The Module Configuration Editor functions are as follows.

Function	Details
Insert expansion modules and cartridges	Expansion modules and cartridges can be inserted into the module configuration area by dragging and dropping them from the expansion modules and cartridges list.
Delete expansion modules and cartridges	Inserted expansion modules and cartridges can be deleted. When an expansion module is deleted, all of the modules placed on the right side of the deleted module are shifted to the left.
Swap expansion modules and cartridges	Inserted expansion modules and cartridges can be moved to a different position.
System software version upgrade	The system software on the CPU module and expansion modules can be upgraded.
Read module configuration	Information about the expansion modules and cartridges connected to the CPU module is stored in special data registers. The configuration of expansion modules and cartridges connected to the CPU module is automatically displayed by acquiring this information.

PID Module Configuration Dialog Box

This section describes the parameters and buttons in the **PID Module Configuration** dialog box.

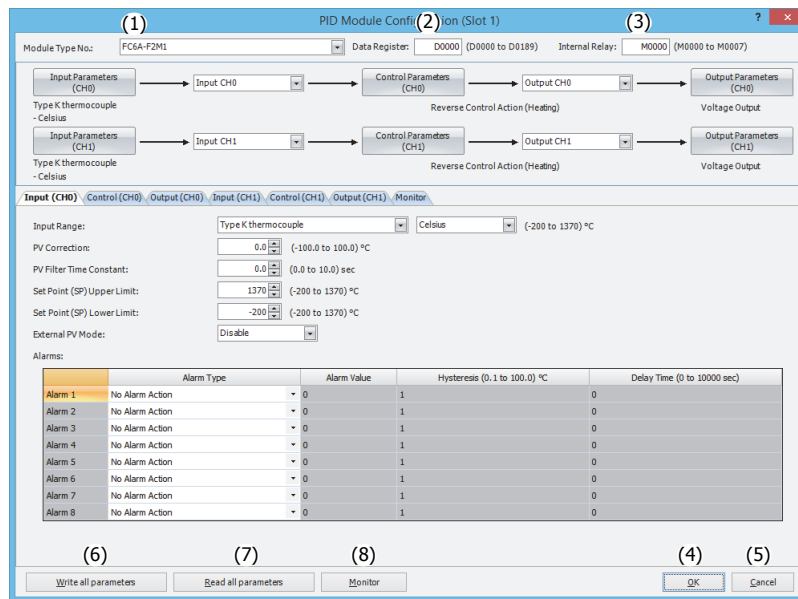

Settings

	Item	Description
(1)	Module Type No.	Select the type number of the PID module to configure.
(2)	Data Register	Designate the control register for the PID module. Data register can be designated. A maximum of 590 data registers (minimum 190 data registers) are occupied, including the first data register designated.
(3)	Internal Relay	Designate the control relay for the PID module. Internal relay can be designated. A maximum of 32 internal relays (minimum 8 internal relays) are occupied, including the first internal relay designated.

Buttons

	Button	Description
(4)	OK	All parameters are saved and the dialog box is closed.
(5)	Cancel	All changes made to the parameters are discarded and the dialog box is closed.
(6)	Write All Parameters	Current parameters configured in the PID Module Configuration dialog box are written to the data registers (RAM) in the CPU module and the PID module.
(7)	Read All Parameters	Loads the parameters saved to the PID module with the slot number selected in Module Configuration Editor into the dialog box.
(8)	Monitor	Monitors the PID module with the slot number selected in Module Configuration Editor.

6: CONFIGURING PID MODULE USING WINDLDR

PID Module Configuration - Input Parameters List (CH0 and CH1)

The input parameters for CH0 and CH1 controls are described here.

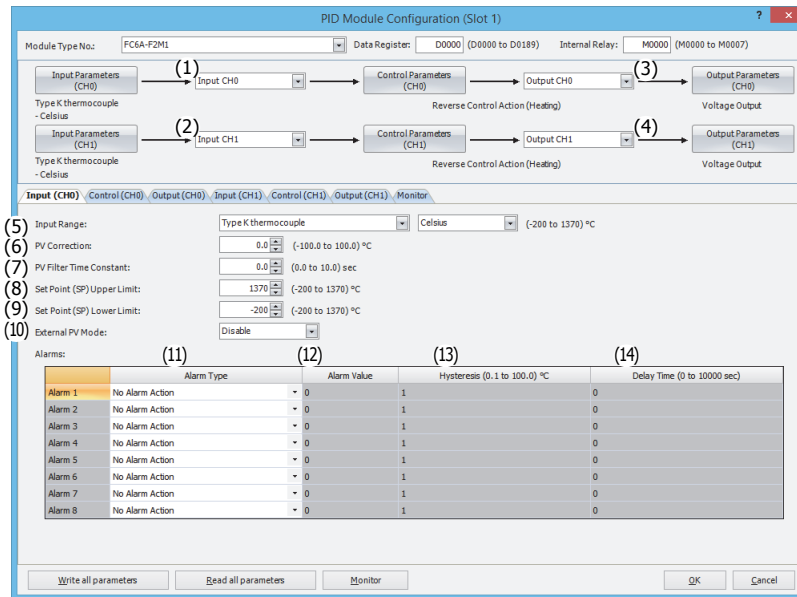

Control Registers

	Offset from the Control Register		Parameter	Description	R/W
	CH0	CH1			
(1)	+56	-	Input CH0 Function	0: Input CH0 1: Difference input (Input CH0 - Input CH1) 2: Difference input (Input CH1 - Input CH0) 3: Addition input (Input CH0 + Input CH1)	R/W
(2)	-	+133	Input CH1 Function	0: Input CH1 1: Difference input (Input CH0 - Input CH1) 2: Difference input (Input CH1 - Input CH0) 3: Addition input (Input CH0 + Input CH1)	R/W
	+55	-	External SP Input	0: Disabled 1: External SP input (4 to 20mA DC) (Note) 2: External SP input (0 to 20mA DC) 3: External SP input (1 to 5V DC) 4: External SP input (0 to 1V DC) 5: Cascade control (Note) Note: When External SP input is selected in Input CH1 Function, "1: External SP input (4 to 20mA DC)" is selected as the default. When Cascade Control is selected in Input CH1 Function, "5: Cascade control" is selected.	R/W
(3)	+57	-	Output CH0 Function	0: Output CH0 1: Output CH1 2: Both outputs (Output CH0, Output CH1)	R/W
(4)	-	+134	Output CH1 Function	0: Output CH1 (The selection of Output CH0 Function has priority.)	R/W
(5)	+58	+135	Input Range	See "Input Range" on page 6-10.	R/W
(6)	+59	+136	Set Point (SP) Upper Limit/Linear Conversion Maximum Value	When input is thermocouple/resistance thermometer: Set point (SP) lower limit to input range upper limit When input is voltage/current: Linear conversion minimum to input range upper limit	R/W
(7)	+60	+137	Set Point (SP) Lower Limit/Linear Conversion Minimum Value	When input is thermocouple/resistance thermometer: Input range lower limit to set point (SP) upper limit When input is voltage/current: Input range lower limit to linear conversion maximum	R/W

	Offset from the Control Register		Parameter	Description	R/W
	CH0	CH1			
(8)	+62	+139	PV Correction	When input range unit is Celsius: -100.0 to 100.0°C When input range unit is Fahrenheit: -100.0 to 100.0°F When input is voltage/current: -1,000 to 1,000	R/W
(9)	+63	+140	PV Filter Time Constant	0.0 to 10.0 sec	R/W
(10)	+22 (Bit8)	+25 (Bit8)	External PV Mode	0: Disabled 1: Enabled	R/W
(11)	+65	+142	Alarm 1 Type	0: No alarm action 1: Upper limit alarm 2: Lower limit alarm 3: Upper/Lower limits alarm 4: Upper/Lower limit range alarm 5: Process high alarm 6: Process low alarm 7: Upper limit alarm with standby 8: Lower limit alarm with standby 9: Upper/Lower limits alarm with standby	R/W
	+66	+143	Alarm 2 Type		
	+67	+144	Alarm 3 Type		
	+68	+145	Alarm 4 Type		
	+69	+146	Alarm 5 Type		
	+70	+147	Alarm 6 Type		
	+71	+148	Alarm 7 Type		
(12)	+72	+149	Alarm 8 Type	See "Valid Range for Alarm 1 to Alarm 8 Value" on page 6-11.	R/W
	+37	+114	Alarm 1 Value		
	+38	+115	Alarm 2 Value		
	+39	+116	Alarm 3 Value		
	+40	+117	Alarm 4 Value		
	+41	+118	Alarm 5 Value		
	+42	+119	Alarm 6 Value		
(13)	+43	+120	Alarm 7 Value	When the unit is Celsius: 0.1 to 100.0°C When the unit is Fahrenheit: 0.1 to 100.0°F When input is voltage/current: 1 to 1,000	R/W
	+44	+121	Alarm 8 Value		
	+73	+150	Alarm 1 Hysteresis		
	+74	+151	Alarm 2 Hysteresis		
	+75	+152	Alarm 3 Hysteresis		
	+76	+153	Alarm 4 Hysteresis		
	+77	+154	Alarm 5 Hysteresis		
(14)	+78	+155	Alarm 6 Hysteresis	0 to 10,000 sec	R/W
	+79	+156	Alarm 7 Hysteresis		
	+80	+157	Alarm 8 Hysteresis		
	+81	+158	Alarm 1 Delay Time		
	+82	+159	Alarm 2 Delay Time		
	+83	+160	Alarm 3 Delay Time		
	+84	+161	Alarm 4 Delay Time		
+85	+162	Alarm 5 Delay Time			
+86	+163	Alarm 6 Delay Time			
+87	+164	Alarm 7 Delay Time			
+88	+165	Alarm 8 Delay Time			

6: CONFIGURING PID MODULE USING WINDLDR

Input Range

Each input setting range is described.

Input Range		Range		Unit				
		PV	PV1/PV2	PV	PV1/PV2			
00h	Type K Thermocouple	Celsius	-200 to 1,370°C	-200.0 to 1,370.0°C	1°C	0.1°C		
01h	Type K Thermocouple with Decimal Point		-200.0 to 400.0°C	-200.0 to 400.0°C	0.1°C			
02h	Type J Thermocouple		-200 to 1,000°C	-200.0 to 1,000.0°C	1°C			
03h	Type R Thermocouple		0 to 1,760°C	0.0 to 1,760.0°C	1°C			
04h	Type S Thermocouple		0 to 1,760°C	0.0 to 1,760.0°C	1°C			
05h	Type B Thermocouple		0 to 1,820°C	0.0 to 1,820.0°C	1°C			
06h	Type E Thermocouple		-200 to 800°C	-200.0 to 800.0°C	1°C			
07h	Type T Thermocouple		-200.0 to 400.0°C	-200.0 to 400.0°C	0.1°C			
08h	Type N Thermocouple		-200 to 1,300°C	-200.0 to 1,300.0°C	1°C			
09h	PL-II		0 to 1,390°C	0.0 to 1,390.0°C	1°C			
0Ah	C(W/Re5-26)		0 to 2,315°C	0.0 to 2,315.0°C	1°C			
0Bh	Pt100 with Decimal Point		-200.0 to 850.0°C	-200.0 to 850.0°C	0.1°C			
0Ch	JPt100 with Decimal Point		-200.0 to 500.0°C	-200.0 to 500.0°C	0.1°C			
0Dh	Pt100		-200 to 850°C	-200.0 to 850.0°C	1°C			
0Eh	JPt100		-200 to 500°C	-200.0 to 500.0°C	1°C			
0Fh	Type K Thermocouple		Fahrenheit	-328 to 2,498°F	-328.0 to 2,498.0°F		1°F	0.1°F
10h	Type K Thermocouple with Decimal Point			-328.0 to 752.0°F	-328.0 to 752.0°F		0.1°F	
11h	Type J Thermocouple			-328 to 1,832°F	-328.0 to 1,832.0°F		1°F	
12h	Type R Thermocouple			32 to 3,200°F	32.0 to 3,200.0°F		1°F	
13h	Type S Thermocouple	32 to 3,200°F		32.0 to 3,200.0°F	1°F			
14h	Type B Thermocouple	32 to 3,308°F		32.0 to 3,308.0°F	1°F			
15h	Type E Thermocouple	-328 to 1,472°F		-328.0 to 1,472.0°F	1°F			
16h	Type T Thermocouple	-328.0 to 752.0°F		-328.0 to 752.0°F	0.1°F			
17h	Type N Thermocouple	-328 to 2,372°F		-328.0 to 2,372.0°F	1°F			
18h	PL-II	32 to 2,534°F		32.0 to 2,534.0°F	1°F			
19h	C(W/Re5-26)	32 to 4,199°F		32.0 to 4,199.0°F	1°F			
1Ah	Pt100 with Decimal Point	-328.0 to 1,562.0°F		-328.0 to 1,562.0°F	0.1°F			
1Bh	JPt100 with Decimal Point	-328.0 to 932.0°F		-328.0 to 932.0°F	0.1°F			
1Ch	Pt100	-328 to 1,562°F		-328.0 to 1,562.0°F	1°F			
1Dh	JPt100	-328 to 932°F	-328.0 to 932.0°F	1°F				
1Eh	4 to 20 mA	—	-2,000 to 10,000*1	-2,000 to 10,000	1	1		
1Fh	0 to 20 mA							
20h	0 to 1 V							
21h	0 to 5 V							
22h	1 to 5 V							
23h	0 to 10 V							

*1 Linear conversion is possible in the range of minimum linear conversion value to maximum linear conversion value.

Valid Range for Alarm 1 to Alarm 8 Value

The valid range of each alarm type is described in the following table.

Alarm Type	Valid Range
Upper Limit Alarm	-(Full scale) to full scale *1
Lower Limit Alarm	-(Full scale) to full scale *1
Upper/Lower Limits Alarm	0 to full scale *1
Upper/Lower Limit Range Alarm	0 to full scale *1
Process High Alarm	Input range lower limit to input range upper limit *2
Process Low Alarm	Input range lower limit to input range upper limit *2
Upper Limit Alarm with Standby	-(Full scale) to full scale *1
Lower Limit Alarm with Standby	-(Full scale) to full scale *1
Upper/Lower Limits Alarm with Standby	0 to full scale *1

*1 When input is voltage/current, full scale is the linear conversion span.

*2 When input is voltage/current, the valid range is the linear conversion minimum value to linear conversion maximum value.

Input Parameters List when External SP Input is Selected

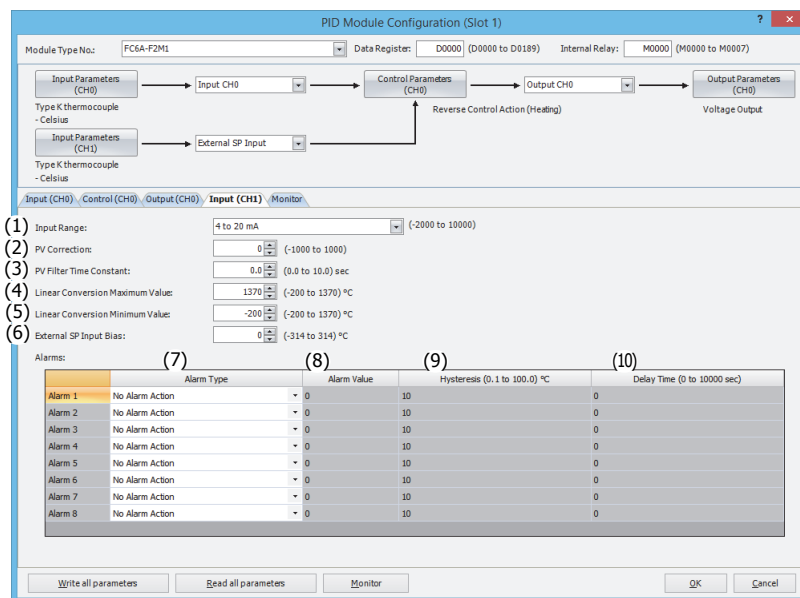

Control Registers

	Offset from the Control Register	Parameter	Description	R/W
(1)	+55	Input Range (External SP input)	0: Disabled (Note) 1: 4 to 20mA DC 2: 0 to 20mA DC 3: 1 to 5V DC 4: 0 to 1V DC 5: Cascade control (Note) Note: Disabled and Cascade control cannot be selected in the input range.	R/W
(2)	+139	PV Correction	-1,000 to 1,000	R/W
(3)	+140	PV Filter Time Constant	0.0 to 10.0 sec	R/W
(4)	+178	External SP Input Linear Conversion Maximum Value	External SP Input linear conversion min. to input range upper limit of CH0	R/W
(5)	+179	External SP Input Linear Conversion Minimum Value	Input range lower limit of CH0 to external SP input linear conversion max.	R/W
(6)	+177	External SP Input Bias	±20% of the external SP input linear conversion span	R/W

6: CONFIGURING PID MODULE USING WINDLDR

	Offset from the Control Register	Parameter	Description	R/W
(7)	+142	Alarm 1 Type	0: No alarm action	R/W
	+143	Alarm 2 Type	1: No alarm action	
	+144	Alarm 3 Type	2: No alarm action	
	+145	Alarm 4 Type	3: No alarm action	
	+146	Alarm 5 Type	4: No alarm action	
	+147	Alarm 6 Type	5: Process high alarm	
	+148	Alarm 7 Type	6: Process low alarm	
	+149	Alarm 8 Type	7: No alarm action 8: No alarm action 9: No alarm action	
(8)	+114	Alarm 1 Value	See "Valid Range for Alarm 1 to Alarm 8 Value" on page 6-11.	R/W
	+115	Alarm 2 Value		
	+116	Alarm 3 Value		
	+117	Alarm 4 Value		
	+118	Alarm 5 Value		
	+119	Alarm 6 Value		
	+120	Alarm 7 Value		
	+121	Alarm 8 Value		
(9)	+150	Alarm 1 Hysteresis	When input range unit is Celsius: 0.1 to 100.0°C When input range unit is Fahrenheit: 0.1 to 100.0°F When input is voltage or current: 1 to 1,000	R/W
	+151	Alarm 2 Hysteresis		
	+152	Alarm 3 Hysteresis		
	+153	Alarm 4 Hysteresis		
	+154	Alarm 5 Hysteresis		
	+155	Alarm 6 Hysteresis		
	+156	Alarm 7 Hysteresis		
	+157	Alarm 8 Hysteresis		
(10)	+158	Alarm 1 Delay Time	0 to 10,000 sec	R/W
	+159	Alarm 2 Delay Time		
	+160	Alarm 3 Delay Time		
	+161	Alarm 4 Delay Time		
	+162	Alarm 5 Delay Time		
	+163	Alarm 6 Delay Time		
	+164	Alarm 7 Delay Time		
	+165	Alarm 8 Delay Time		

PID Module Configuration - Control Parameters List (CH0 and CH1)

The control parameters for CH0 and CH1 are described here.

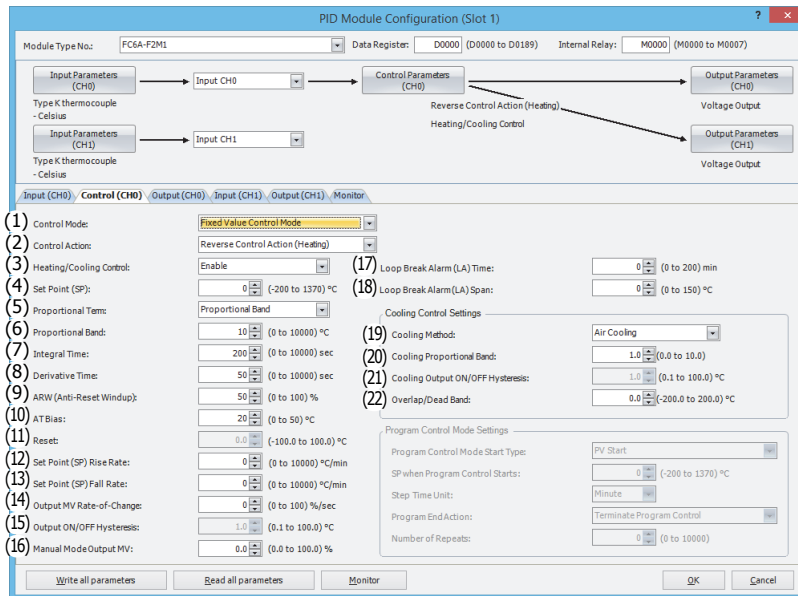

Control Parameters when Program Control Mode is Selected

When the program control mode is selected, parameters (23) to (27) are enabled. Parameters related to fixed value control mode, such as the set point (SP), proportional band/proportional gain, or integral time, are disabled.

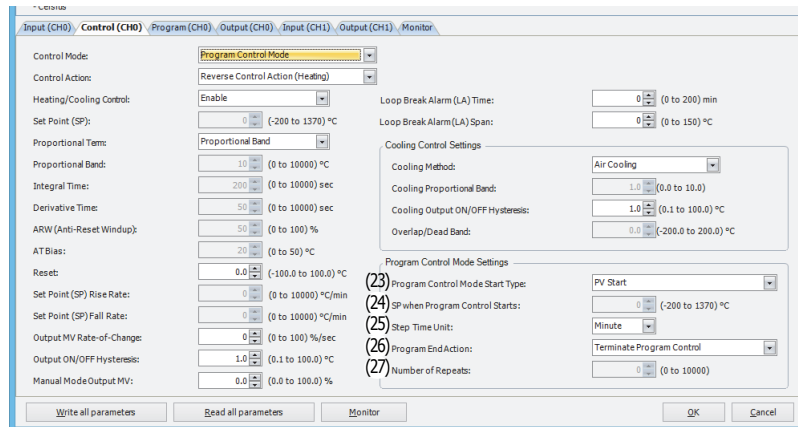

Control Registers

	Offset from the Control Register		Parameter	Description	R/W
	CH0	CH1			
(1)	+90	+167	Control Mode	0: Fixed value control mode 1: Program control mode When the cascade control is selected as Input CH1 Function, only the fixed value control mode can be selected for CH0 control. If program control is selected, external SP input will not work.	R/W
(2)	+53	+130	Control Action	0: Reverse control action (Heating) 1: Direct control action (Cooling)	R/W
(3)	+54	-	Heating/Cooling Control	0: Disable 1: Enable	R/W
(4)	+20	+23	Set Point (SP)	When input is thermocouple/resistance thermometer: Set point (SP) lower limit to set point (SP) upper limit When input is voltage/current: Linear conversion min. to linear conversion max.	R/W

6: CONFIGURING PID MODULE USING WINDLDR

	Offset from the Control Register		Parameter	Description	R/W
	CH0	CH1			
(5)	+94	+171	Proportional Term	0: Proportional band 1: Proportional gain	R/W
(6)	+26	+103	Proportional Band/ Proportional Gain	Proportional band: When input range unit is Celsius: 0 to 10,000°C (Range with a decimal point: 0.0 to 1,000.0°C) When input range unit is Fahrenheit: 0 to 10,000°F (Range with a decimal point: 0.0 to 1,000.0°F) When input is voltage/current: 0.0 to 1,000.0% Proportional gain: 0.00 to 100.00%	R/W
(7)	+27	+104	Integral Time	0 to 10,000 sec	R/W
(8)	+28	+105	Derivative Time	0 to 10,000 sec	R/W
(9)	+29	+106	ARW (Anti-Reset Windup)	0 to 100%	R/W
(10)	+89	+166	AT Bias	When input range unit is Celsius: 0 to 50°C (Range with a decimal point: 0.0 to 50.0°C) When input range unit is Fahrenheit: 0 to 100°F (Range with a decimal point: 0.0 to 100.0°F)	R/W
(11)	+31	+108	Reset	When input range unit is Celsius: -100.0 to 100.0°C When input range unit is Fahrenheit: -100.0 to 100.0°F When input is voltage or current: -1,000 to 1,000	R/W
(12)	+33	+110	Set Point (SP) Rise Rate	When input range unit is Celsius: 0 to 10,000°C/min (Range with a decimal point: 0.0 to 1,000.0°C/min) When input range unit is Fahrenheit: 0 to 10,000°F/min (Range with a decimal point: 0.0 to 1,000.0°F/min) When input is voltage or current: 0 to 10,000/min	R/W
(13)	+34	+111	Set Point (SP) Fall Rate	When input range unit is Celsius: 0 to 10,000°C/min (Range with a decimal point: 0.0 to 1,000.0°C/min) When input range unit is Fahrenheit: 0 to 10,000°F/min (Range with a decimal point: 0.0 to 1,000.0°F/min) When input is voltage or current: 0 to 10,000/min	R/W
(14)	+32	+109	Output Manipulated Variable Rate-of-Change	0 to 100%/sec	R/W
(15)	+61	+138	Output ON/OFF Hysteresis	When input range unit is Celsius: 0.1 to 100.0°C When input range unit is Fahrenheit: 0.1 to 100.0°F When input is voltage or current: 1 to 1,000	R/W
(16)	+21	+24	Manual Mode Output Manipulated Variable	When heating/cooling control is disabled: Output manipulated variable lower limit to output manipulated variable upper limit When heating/cooling control is enabled: - Cooling output manipulated variable upper limit to heating output manipulated variable upper limit	R/W
(17)	+35	+112	Loop Break Alarm (LA) Time	0 to 200 minutes	R/W
(18)	+36	+113	Loop Break Alarm (LA) Span	When input range unit is Celsius: 0 to 150°C (Range with a decimal point: 0.0 to 150.0°C) When input range unit is Fahrenheit: 0 to 150°F (Range with a decimal point: 0.0 to 150.0°F) When input is voltage or current: 0 to 1,500	R/W
(19)	+95	-	Cooling Method	0: Air cooling 1: Oil cooling 2: Water cooling	R/W
(20)	+48	-	Cooling Proportional Band	0.0 to 10.0 times (Cooling proportional band is the product of this value and the heating proportional band)	R/W
(21)	+98	-	Cooling Output ON/OFF Hysteresis	When input range unit is Celsius: 0.1 to 100.0°C When input range unit is Fahrenheit: 0.1 to 100.0°F When input is voltage or current: 1 to 1,000	R/W

6: CONFIGURING PID MODULE USING WINDLDR

	Offset from the Control Register		Parameter	Description	R/W
	CH0	CH1			
(22)	+50	–	Overlap/Dead Band	When input range unit is Celsius: -200.0 to 200.0°C When input range unit is Fahrenheit: -200.0 to 200.0°F When input is voltage or current: -2,000 to 2,000	R/W
(23)	+91	+168	Program Control Mode Start Type	0: PV start 1: PVR start 2: SP start	R/W
(24)	+96	+173	Set Point (SP) when Program Control Starts	When input is thermocouple/resistance thermometer: Set point (SP) lower limit to set point (SP) upper limit When input is voltage or current: Linear conversion min. to linear conversion max.	R/W
(25)	+92	+169	Step Time Unit	0: Minute 1: Second	R/W
(26)	+93	+170	Program End Action	0: Terminate program control 1: Continue program control (Repeat) 2: Hold program control	R/W
(27)	+97	+174	Number of Repeats	0 to 10,000 times	R/W

6: CONFIGURING PID MODULE USING WINDLDR

Control Parameters when Cascade Control is Enabled

Control Registers

	Offset from the Control Register		Parameter	Setting Range	R/W
	CH0	CH1			
(1)	-	+178	External SP Input Linear Conversion Maximum Value	External SP Input linear conversion min. value to input range upper limit of CH0	R/W
(2)	-	+179	External SP Input Linear Conversion Minimum Value	Input range lower limit of CH0 to external SP Input linear conversion max. value	R/W

When Input CH0 External PV Mode and Input CH1 External PV Mode are Enabled

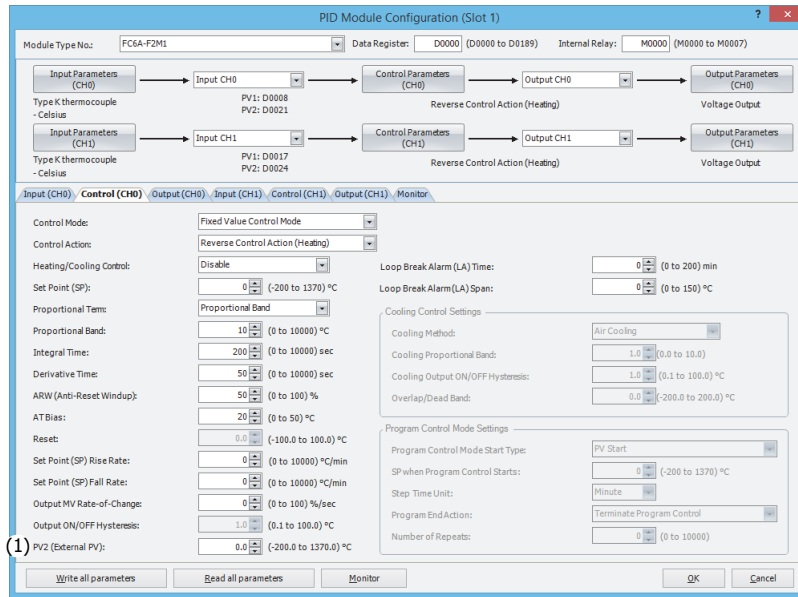

Control Registers

	Offset from the Control Register		Parameter	Setting Range	R/W
	CH0	CH1			
(1)	+21	+24	External PV Mode Process Variable (PV2)	See the values in "Input Range" on page 5-22.	R/W

6: CONFIGURING PID MODULE USING WINDLDR

PID Module Configuration - Output Parameters List (CH0 and CH1)

The output parameters for CH0 and CH1 are described here.

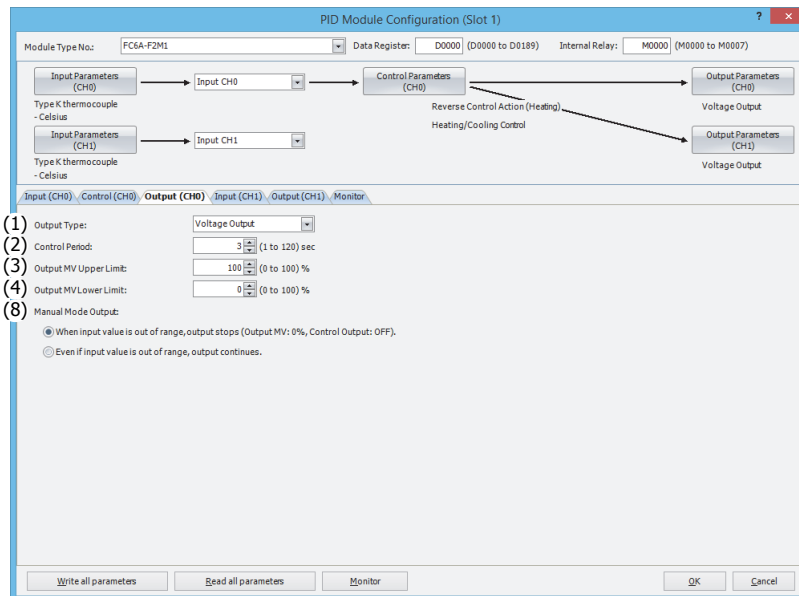

Output Parameters when Heating/Cooling Control is Enabled

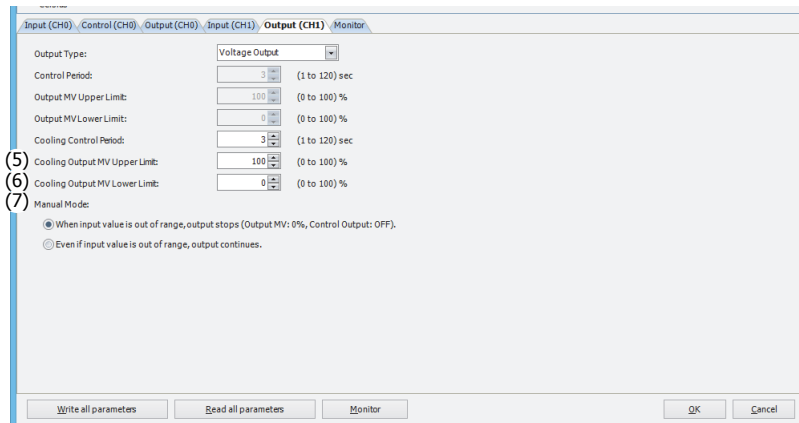

Control Registers

	Offset from the Control Register		Parameter	Description	R/W
	CH0	CH1			
(1)	+99	+176	Output Type	0: Non-contact voltage output (for SSR drive) 1: Current output	R/W
(2)	+30	+107	Control Period	1 to 120 sec	R/W
(3)	+46	+123	Output Manipulated Variable Upper Limit	When output type is voltage: Output manipulated variable lower limit to 100% When output type is current: Output manipulated variable lower limit to 105%	R/W
(4)	+47	+124	Output Manipulated Variable Lower Limit	When output type is voltage: 0% to output manipulated variable upper limit When output type is current: -5% to output manipulated variable upper limit	R/W
(5)	+49	-	Cooling Control Period	1 to 120 sec	R/W
(6)	+51	-	Cooling Output Manipulated Variable Upper Limit	When output type is voltage: Cooling output manipulated variable lower limit to 100% When output type is current: Cooling output manipulated variable lower limit to 105%	R/W

	Offset from the Control Register		Parameter	Description	R/W
	CH0	CH1			
(7)	+52	–	Cooling Output Manipulated Variable Lower Limit	When output type is voltage: 0% to cooling output manipulated variable upper limit When output type is current: -5% to cooling output manipulated variable upper limit	R/W
(8)	+22 Bit9	+25 Bit9	Output when the process variable is out of range (manual mode only)*1	0: Stop output 1: Continue output	R/W

*1 The output can be selected when in manual mode and the PID control input (process variable) is out of range.
 When the stop output is set, the output manipulated variable is set to 0% and the control output turns off.
 When the continue output is set, the manual mode output MV is output and the control output turns on and off according to the manual mode output MV.

6: CONFIGURING PID MODULE USING WINDLDR

PID Module Configuration - Program Parameters List (CH0 and CH1)

Program parameters for CH0 and CH1 are described here.

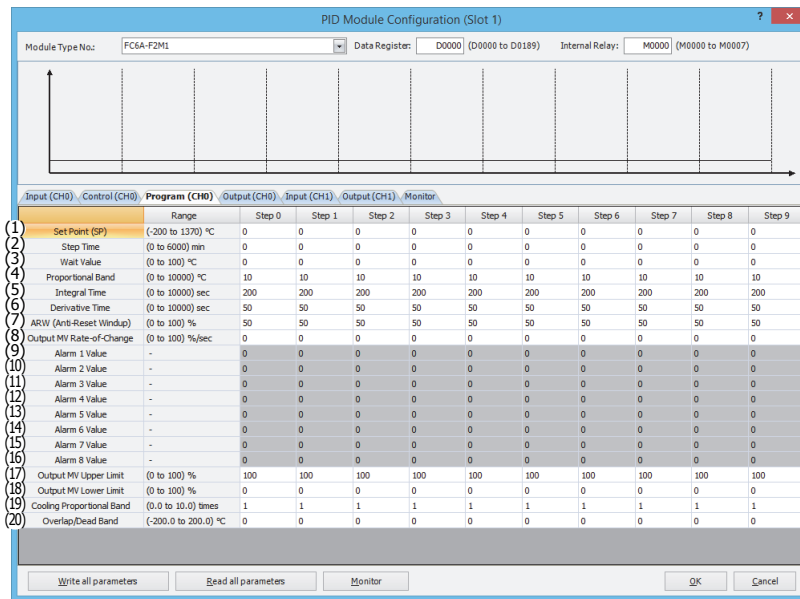

Control Registers

	Offset from the Control Register		Parameter	Description	R/W
	CH0	CH1			
(1)	+180	+390	Set Point (SP)	When input is thermocouple/resistance thermometer: Set point (SP) lower limit to set point (SP) upper limit When input is voltage or current: Linear conversion min. to linear conversion max.	R/W
(2)	+181	+391	Step Time	When step time unit is Minute: 0 to 6,000 minutes When step time unit is Second: 0 to 6,000 seconds	R/W
(3)	+182	+392	Wait Value	When input range unit is Celsius: 0 to 100°C (Range with a decimal point: 0.0 to 100.0°C) When input range unit is Fahrenheit: 0 to 100°F (Range with a decimal point: 0.0 to 100.0°F) When input is voltage or current: 0 to 1,000	R/W
(4)	+183	+393	Proportional Band/ Proportional Gain	Proportional band: When input range unit is Celsius: 0 to 10,000°C (Range with a decimal point: 0.0 to 1,000.0°C) When input range unit is Fahrenheit: 0 to 10,000°F (Range with a decimal point: 0.0 to 1,000.0°F) When input is voltage or current: 0.0 to 1,000.0% Proportional gain: 0.00 to 100.00%	R/W
(5)	+184	+394	Integral Time	0 to 10,000 sec	R/W
(6)	+185	+395	Derivative Time	0 to 10,000 sec	R/W
(7)	+186	+396	ARW (Anti-Reset Windup)	0 to 100%	R/W
(8)	+187	+397	Output Manipulated Variable Rate-of-Change	0 to 100%/sec	R/W
(9)	+188	+398	Alarm 1 Value	Refer to the valid range for alarm 1 to alarm 8 values shown in the following table.	R/W
(10)	+189	+399	Alarm 2 Value		
(11)	+190	+400	Alarm 3 Value		
(12)	+191	+401	Alarm 4 Value		
(13)	+192	+402	Alarm 5 Value		
(14)	+193	+403	Alarm 6 Value		
(15)	+194	+404	Alarm 7 Value		
(16)	+195	+405	Alarm 8 Value		

	Offset from the Control Register		Parameter	Description	R/W
	CH0	CH1			
(17)	+197	+407	Output Manipulated Variable Upper Limit	When output type is voltage: Output manipulated variable lower limit to 100% When output type is current: Output manipulated variable lower limit to 105%	R/W
(18)	+198	+408	Output Manipulated Variable Lower Limit	When output type is voltage: 0% to output manipulated variable upper limit When output type is current: -5% to output manipulated variable upper limit	R/W
(19)	+199	–	Cooling Proportional Band	0.0 to 10.0 times (Cooling proportional band is the multiplication of heating proportional band)	R/W
(20)	+200	–	Overlap/Dead Band	When input range unit is Celsius: -200.0 to 200.0°C When input range unit is Fahrenheit: -200.0 to 200.0°F When input is voltage or current: -2,000 to 2,000	R/W

Valid Range for Alarm 1 to Alarm 8 Value

This table shows the setting range for each alarm.

Alarm Type	Valid Range
Upper Limit Alarm	–(Full scale) to full scale *1
Lower Limit Alarm	–(Full scale) to full scale *1
Upper/Lower Limits Alarm	0 to full scale *1
Upper/Lower Limit Range Alarm	0 to full scale *1
Process High Alarm	Input range lower limit to input range upper limit *2
Process Low Alarm	Input range lower limit to input range upper limit *2
Upper Limit Alarm with Standby	–(Full scale) to full scale *1
Lower Limit Alarm with Standby	–(Full scale) to full scale *1
Upper/Lower Limits Alarm with Standby	0 to full scale *1

*1 When input is voltage/current, full scale is the linear conversion span.

*2 When input is voltage/current, the valid range is the linear conversion minimum value to linear conversion maximum value.

PID Module Configuration - I/O Function Selections

This section describes the input CH0 and input CH1 functions.

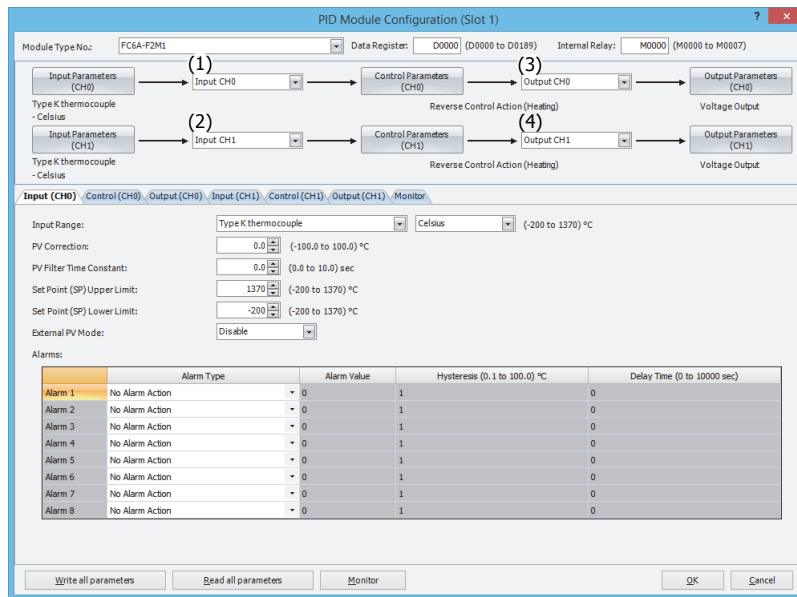

(1) Control Register+56: Input CH0 Function

The one of the following input functions can be selected as the Input CH0 Function.

Input CH0:

Input CH0 is used as the process variable (PV) for CH0 control.

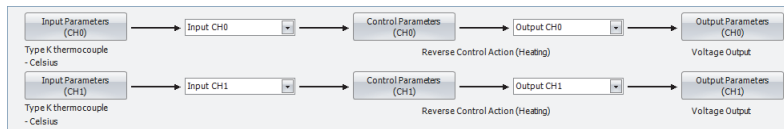

Difference (CH0-CH1):

The difference between input CH0 and input CH1 is used as the process variable (PV) for CH0 control.

Process variable (PV) of CH0 control = Input CH0 input value - Input CH1 input value

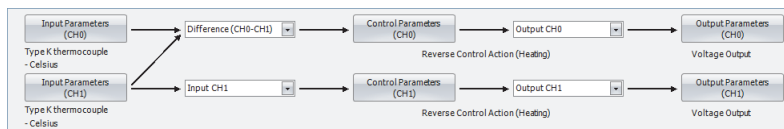

Difference (CH1-CH0):

The difference between input CH1 and input CH0 is used as the process variable (PV) for CH0 control.

Process variable (PV) of CH0 control = Input CH1 input value - Input CH0 input value

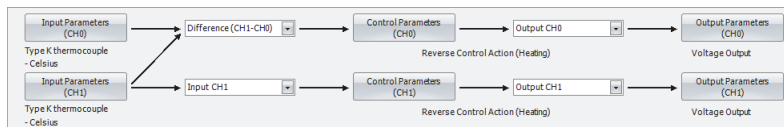

Addition (CH0+CH1):

The addition of input CH0 and input CH1 is used as the process variable (PV) for CH0 control.

Process variable (PV) of CH0 control = Input CH0 input value + Input CH1 input value

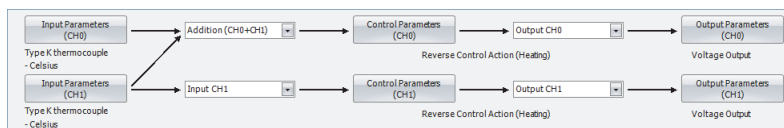

(2) Control Register+133: Input CH1 Function
Control Register+55: External SP Input

The one of the following input functions can be selected as the Input CH1 Function.

Input CH1:

Input CH1 is used as the process variables (PV) for CH1 control.

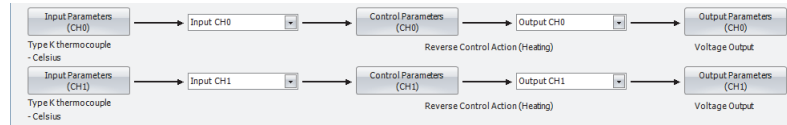

Difference (CH0-CH1):

The difference between input CH0 and input CH1 is used as the process variable (PV) for CH1 control.

Process variable (PV) of CH1 control = Input CH0 input value - Input CH1 input value

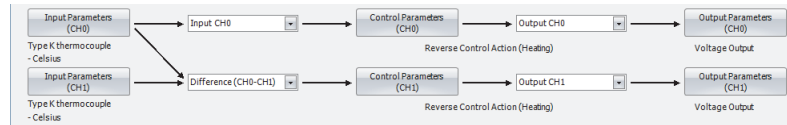

Difference (CH1-CH0):

The difference between input CH1 and input CH0 is used as the process variable (PV) for CH1 control.

Process variable (PV) of CH1 control = Input CH1 input value - Input CH0 input value

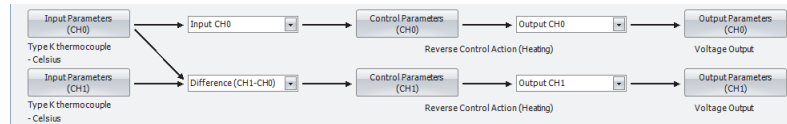

Addition (CH0+CH1):

The addition of input CH0 and input CH1 is used as the process variable (PV) for CH1 control.

Process variable (PV) of CH1 control = Input CH0 input value + Input CH1 input value

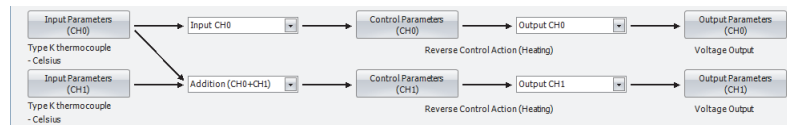

External SP Input:

Input CH1 is used as the set point (SP) for CH0 control.

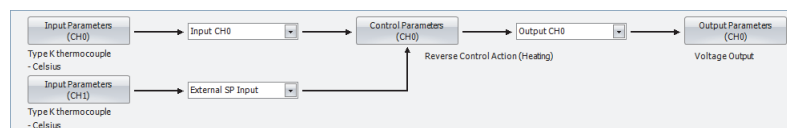

When the external SP input bias is configured, the external SP input bias is added to the input CH1 value, and then the input CH1 value is used as the set point (SP) for CH0 control. One of the analog input types shown in the table below can be selected for the external SP input.

	Current	Voltage
Input Type	4 to 20mA DC or 0 to 20mA DC	1 to 5V DC or 0 to 1V DC
Allowable Input	50mA DC maximum	0 to 1V DC: 5V DC maximum 1 to 5V DC: 10V DC maximum
Input Impedance	50 Ω	100 kΩ

6: CONFIGURING PID MODULE USING WINDLDR

Cascade Control:

The cascade control is an advanced control that uses 2 inputs [CH1 as a master (primary control) and CH0 as a slave (secondary control)] to control a single process.

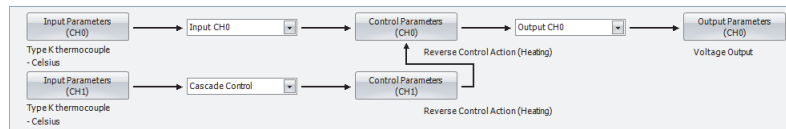

Master (CH1 control) calculates the output manipulated variable (MV) according to the process variable (PV) and the set point (SP). The output manipulated variable (MV) of the master (CH1 control) is used as the set point (SP) of the slave (CH0 control). With the obtained set point (SP), the slave (CH0 control) calculates the output manipulated variable (MV) and controls the output CH0.

When the cascade control is used, the output CH1 is unused. When the output type is current, the output CH1 is 4 mA. When the output type is voltage, the output CH1 is 0 V. When the output type is relay, Output CH1 is turned off. When heating/cooling control is enabled, output CH1 is used as the cooling output.

Output manipulated variable (MV) (0 to 100%) of the master (CH1 control) is converted using the external SP input linear conversion minimum and maximum values and is used as the set point (SP) of the slave (CH0 control).

Example: When the external SP input linear conversion minimum value is 0°C and the external SP input linear conversion maximum value is 1,000°C, the set point (SP) of the slave (CH0 control) is decided as follows:

When master (CH1 control) output manipulated variable (MV) is 0%: 0°C

When master (CH1 control) output manipulated variable (MV) is 50%: 500°C

When master (CH1 control) output manipulated variable (MV) is 100%: 1,000°C

Combination of Input CH0 and Input CH1 Functions

The possible combinations of Input CH0 and CH1 Functions are shown below. (O: Possible, X: Impossible)

Input CH0	Input CH1					
	Input CH1	Difference (CH0-CH1)	Difference (CH1-CH0)	Addition (CH0+CH1)	External SP Input	Cascade Control
Input CH0	O	O	O	O	O	O
Difference (CH0-CH1)	O	O	O	O	X	X
Difference (CH1-CH0)	O	O	O	O	X	X
Addition (CH0+CH1)	O	O	O	O	X	X

(3) Control Register+57: Output CH0 Function

The one of the following output functions can be selected as the Output CH0 Function.

Output (CH0): The output of the CH0 control is outputted from output CH0

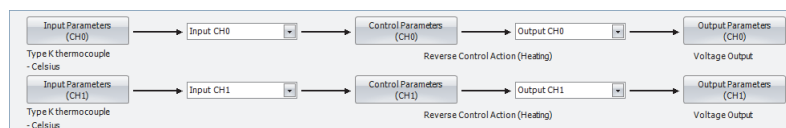

Output (CH1): The output of the CH0 control is outputted from output CH1

When Output (CH1) is selected, CH1 parameters are used for the control period and the output manipulated variable (MV) upper and lower limits. CH0 parameters are used for all other parameters, such as the output manipulated variable rate-of-change, output on/off hysteresis, and manual mode output manipulated variable.

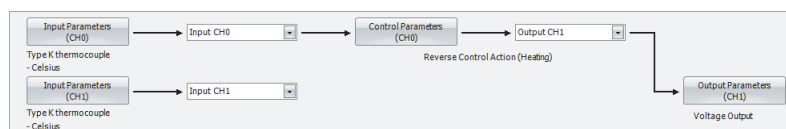

When Output (CH1) is selected, output CH0 is unused. When output type is relay, the output CH0 is turned off. When output type is voltage/current, output CH0 is 0 V/4 mA.

Both Outputs (CH0, CH1): The output of the CH0 control is outputted from both outputs CH0 and CH1

The control period and output manipulated variable (MV) upper and lower limits of CH0 and CH1 are used for the corresponding output. However, for the output manipulated variable rate-of-change, output on/off hysteresis, and manual mode output manipulated variable, CH0 control settings are valid for output CH0 and output CH1.

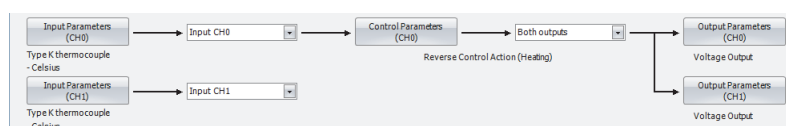

(4) Control Register+134: Output CH1 Function

Output (CH1) is always selected as Output CH1 Function. The output of the CH1 control is outputted from output CH1. Output CH0 Function has priority.

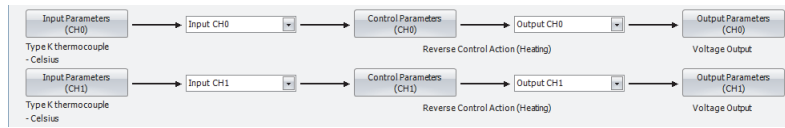

PID Module Configuration - Input Parameters Details

This section describes details about the parameters related to inputs for CH0 control and CH1 control.

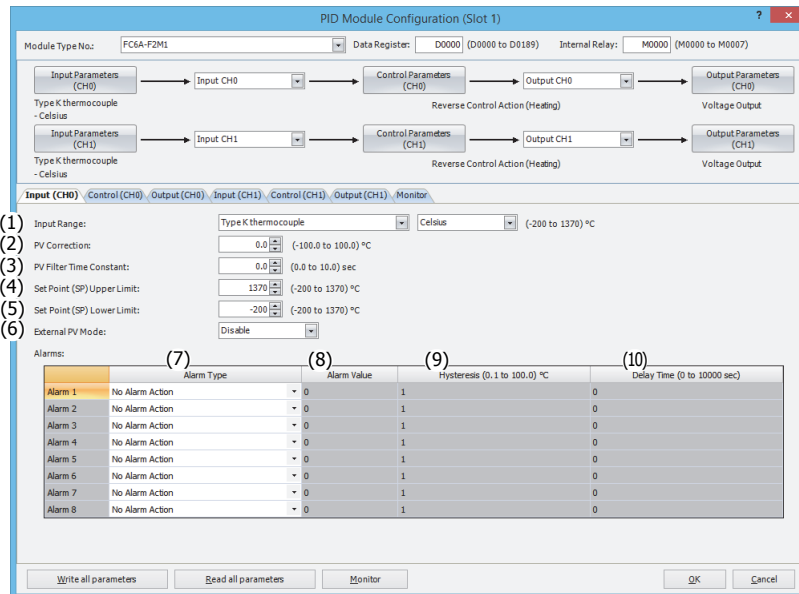

Input parameters for CH0 control are described here. Input parameters for CH1 control are the same as those of CH0 control. However, the position from the control register for each parameter differs. For details about the positions from the control register for CH1 control, see "Blocks 2, 3: Basic Parameters (SHOT Action)" on page 5-18 and "Blocks 4, 5: Initial Setting Parameters (SHOT Action)" on page 5-20.

(1) Control Register+58: Input Range

The input range is the input type and unit handled as the PID control process variable. Select input type and input range unit (Celsius or Fahrenheit). For details about the input range, see "Input Range" on page 6-10.

(2) Control Register+62: PV Correction

PV correction is a function to correct the process value (PV). If the sensor cannot be installed to the location of the control target, the temperature measured by the sensor may deviate from the actual temperature of the control target. When a target is controlled with multiple PID modules, the measured temperatures may not match due to the differences in sensor accuracy or dispersion of load capacities even though the set points (SP) of those PID modules are the same. In such cases, the process variable (PV) of the PID module can be adjusted to the desired temperature by using the PV Correction. The process variable (PV) after the PV correction should be within the control range. For details, see "Control Range" on page A-4. For example, when type K thermocouple (-200 to 1,370°C) is selected as input type, configure an appropriate PV correction value so that the process variable (PV) after the PV correction does not exceed the control range (-250 to 1,420°C) [(Input range lower limit - 50°C) to (Input range upper limit + 50°C)].

When the process variable (PV) after the PV correction is within the control range, the PID module controls the temperature based on the process variable (PV) after the PV correction. When the process variable (PV) after the PV correction is out of the control range, the under or over range error occurs and the control output is turned off.

The process variable (PV) after the PV correction can be calculated using the following formula:

$$\text{Process variable (PV) after the PV correction} = \text{Process variable (PV)} + (\text{PV correction value})$$

Example 1: When process variable (PV) is 198°C

If the PV correction value is 2.0°C, the process variable (PV) will be 200.0°C (198°C + 2.0°C).

If the PV correction value is -2.0°C, the Process variable (PV) will be 196.0°C (198°C - 2.0°C).

Example 2: By setting the PV correction value for the PID module to 10.0°C, the process variable (PV) of the PID module is adjusted from 190°C to 200°C.

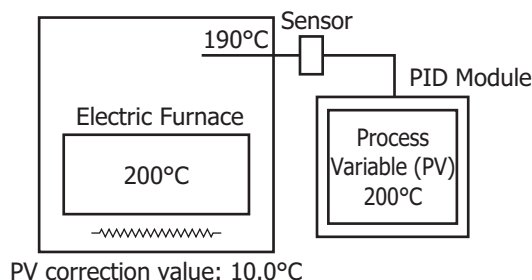

(3) Control Register +63: PV Filter Time Constant

The PV filter function is a software filter to stabilize the process variable (PV) affected by fluctuating processes, such as the pressure or flow rate, by calculating first-order lag of the process variable (PV). Even if the process variable (PV) changes as shown in the Figure 1, when the PV filter time constant is configured, the process variable (PV) changes as shown in the Figure 2. After the PV filtering process, the process variable (PV) reaches 63% of the process variable (PV) in T seconds. If the PV filter time constant is too large, it adversely affects the control results due to the delay of response.

Example: If the least significant digit of the process variable (PV) is fluctuating, the fluctuation can be suppressed by using the PV filter time constant.

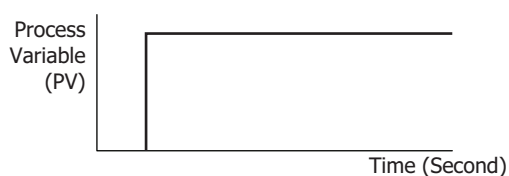

Figure 1. Process variable (PV) before PV filtering process

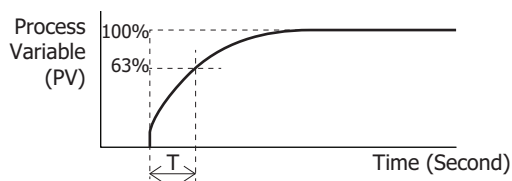

Figure 2. Process variable (PV) after PV filtering process

(4) Control Register+59: Set Point (SP) Upper Limit/Linear Conversion Maximum Value

(5) Control Register+60: Set Point (SP) Lower Limit/Linear Conversion Minimum Value

Linear Conversion Function

The diagram below shows an example of the linear conversion. When the linear conversion maximum value is 5,000 and the linear conversion minimum value is 0, the current input (4 to 20mA DC) is linearly-converted as shown in the diagram.

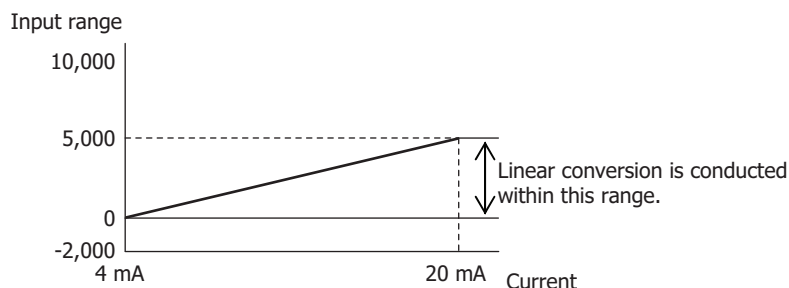

Set Point (SP) Upper Limit/Linear Conversion Maximum Value

When input type is thermocouple or resistance thermometer, the linear conversion is disabled. The linear conversion maximum value is used as the upper limit of the set point (SP). When input type is voltage/current, configure the maximum value of input CH0 as the linear conversion maximum value. Any value within the valid input range can be configured.

Set Point (SP) Lower Limit/Linear Conversion Minimum Value

When input type is thermocouple or resistance thermometer, the linear conversion is disabled. The linear conversion minimum value is used as the lower limit of the set point (SP). When input type is voltage/current, configure the minimum value of input CH0 as the linear conversion minimum value. Any value within the valid range can be configured.

6: CONFIGURING PID MODULE USING WINDLDR

(6) Control Register+22 (Bit8): External PV Mode

Select enable or disable for external PV mode. External PV mode is only executed in auto mode. In manual mode, external PV mode is not executed, even if enabled. For details, see "External PV Mode" on page 4-19.

(7) Control Register+65: Alarm 1 Type

Control Register+66: Alarm 2 Type

Control Register+67: Alarm 3 Type

Control Register+68: Alarm 4 Type

Control Register+69: Alarm 5 Type

Control Register+70: Alarm 6 Type

Control Register+71: Alarm 7 Type

Control Register+72: Alarm 8 Type

The alarm type is the operation type where the PID module compares the process variable (PV) with a preset value (alarm value) and performs ON/OFF control. The alarm type is available in the following 10 operation types.

Select one of the alarm types from upper limit alarm, lower limit alarm, upper/lower limits alarm, upper/lower limit range alarm, process high alarm, process low alarm, upper limit alarm with standby, lower limit alarm with standby, upper/lower limits alarm with standby, and no alarm action.



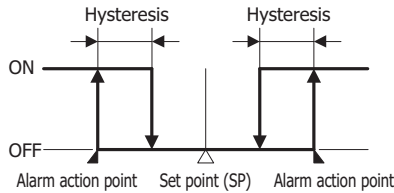
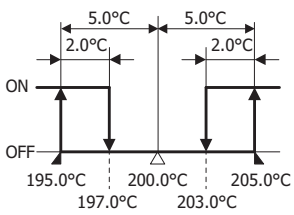
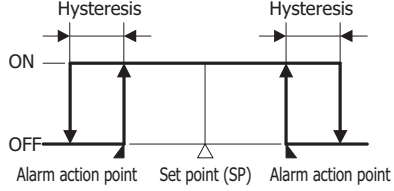
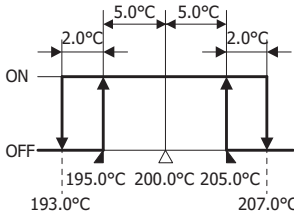
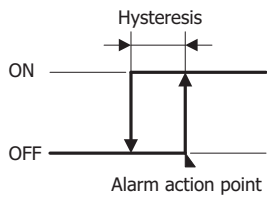
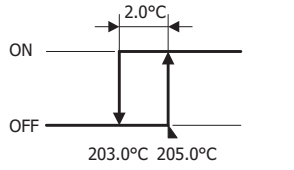
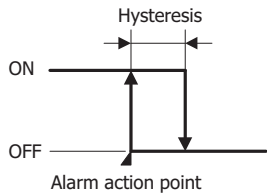
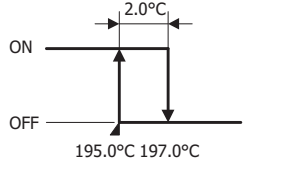

The same alarm type can be selected in multiple alarms.

Alarm Type Diagrams

Type	Operation	Example
Upper Limit Alarm	<p>Turns ON the alarm output when process variable (PV) \geq (set point (SP) + alarm value). Turns OFF the alarm output when process variable (PV) \leq (set point (SP) + alarm value - hysteresis). When (set point (SP) + alarm value - hysteresis) < process variable (PV) < (set point (SP) + alarm value), the alarm output maintains the state of the previous scan.</p> <p style="text-align: center;">-Alarm action point Set point (SP) +Alarm action point</p>	<p>Set point (SP): 200.0°C Alarm 1 alarm value: 5.0°C Alarm 1 hysteresis: 2.0°C</p> <p>When process variable (PV) \geq 205.0°C, the alarm output is turned ON. When process variable (PV) \leq 203.0°C, the alarm output is turned OFF.</p>
	<p>Turns ON the alarm output when process variable (PV) \leq (set point (SP) + alarm value). Turns OFF the alarm output when process variable (PV) \geq (set point (SP) + alarm value + hysteresis). When (set point (SP) + alarm value) < process variable (PV) < (set point (SP) + alarm value + hysteresis), the alarm output maintains the state of the previous scan.</p> <p style="text-align: center;">-Alarm action point Set point (SP) +Alarm action point</p>	<p>Set point (SP): 200.0°C Alarm 1 alarm value: -5.0°C Alarm 1 hysteresis: 2.0°C</p> <p>When process variable (PV) \geq 195.0°C, the alarm output is turned ON. When process variable (PV) \leq 193.0°C, the alarm output is turned OFF.</p>

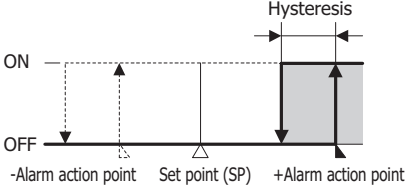
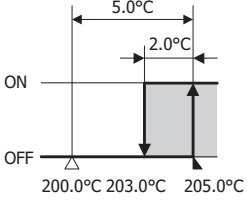
Type	Operation	Example
Upper/ Lower Limits Alarm	<p>Turns ON the alarm output when process variable (PV) \geq (set point (SP) + alarm value).</p> <p>Turns ON the alarm output when process variable (PV) \leq (set point (SP) - alarm value).</p> <p>Turns OFF the alarm output when (set point (SP) - alarm value + hysteresis) \leq process variable (PV) \leq (set point (SP) + alarm value - hysteresis).</p> <p>When (set point (SP) + alarm value - hysteresis) < process variable (PV) < (set point (SP) + alarm value), the alarm output maintains the state of the previous scan.</p> <p>When (set point (SP) - alarm value) < process variable (PV) < (set point (SP) - alarm value + hysteresis), the alarm output maintains the state of the previous scan.</p> 	<p>Set point (SP): 200.0°C Alarm 1 alarm value: 5.0°C Alarm 1 hysteresis: 2.0°C</p>  <p>When process variable (PV) \geq 205.0°C, the alarm output is turned ON. When process variable (PV) \leq 195.0°C, the alarm output is turned ON. When 197.0°C \leq process variable (PV) \leq 203.0°C, the alarm output is turned OFF.</p>
Upper/ Lower Limit Range Alarm	<p>Turns ON the alarm output when (set point (SP) - alarm value) \leq process variable (PV) \leq (set point (SP) + alarm value).</p> <p>Turns OFF the alarm output when process variable (PV) \geq (set point (SP) + alarm value + hysteresis).</p> <p>Turns OFF the alarm output when process variable (PV) \leq (set point (SP) - alarm value - hysteresis).</p> <p>When (set point (SP) + alarm value) < process variable (PV) < (set point (SP) + alarm value + hysteresis), the alarm output maintains the state of the previous scan.</p> <p>When (set point (SP) - alarm value - hysteresis) < process variable (PV) < (set point (SP) - alarm value), the alarm output maintains the state of the previous scan.</p> 	<p>Set point (SP): 200.0°C Alarm 1 alarm value: 5.0°C Alarm 1 hysteresis: 2.0°C</p>  <p>When 195.0°C \leq process variable (PV) \leq 205.0°C, the alarm output is turned ON. When process variable (PV) \geq 207.0°C, the alarm output is turned OFF. When process variable (PV) \leq 193.0°C, the alarm output is turned OFF.</p>
Process High Alarm	<p>Turns ON the alarm output when process variable (PV) \geq alarm value.</p> <p>Turns OFF the alarm output when process variable (PV) \leq (alarm value - hysteresis).</p> <p>When (alarm value - hysteresis) < process variable (PV) < alarm value, the alarm output maintains the state of the previous scan.</p> 	<p>Alarm 1 alarm value: 205.0°C Alarm 1 hysteresis: 2.0°C</p>  <p>When process variable (PV) \geq 205.0°C, the alarm output is turned ON. When process variable (PV) \leq 203.0°C, the alarm output is turned OFF.</p>
Process Low Alarm	<p>Turns ON the alarm output when process variable (PV) \leq alarm value.</p> <p>Turns OFF the alarm output when process variable (PV) \geq (alarm value + hysteresis).</p> <p>When alarm value < process variable (PV) < (alarm value + hysteresis), the alarm output maintains the state of the previous scan.</p> 	<p>Alarm 1 alarm value: 195.0°C Alarm 1 hysteresis: 2.0°C</p>  <p>When process variable (PV) \leq 195.0°C, the alarm output is turned ON. When process variable (PV) \geq 197.0°C, the alarm output is turned OFF.</p>

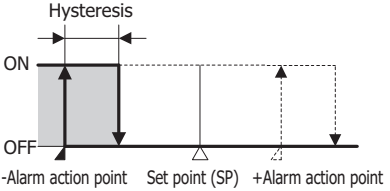
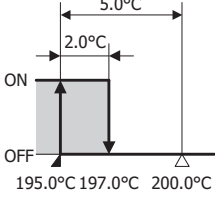
6: CONFIGURING PID MODULE USING WINDLDR

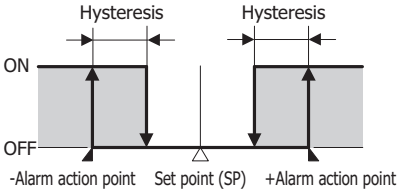
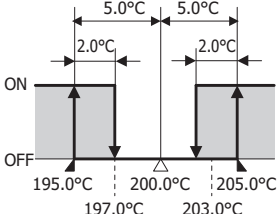
Type	Operation	Example
<p>Upper Limit Alarm with Standby</p>	<p>Turns ON the alarm output when process variable (PV) \geq (set point (SP) + alarm value).</p> <p>Turns OFF the alarm output when process variable (PV) \leq (set point (SP) + alarm value - hysteresis).</p> <p>When (set point (SP) + alarm value - hysteresis) < process variable (PV) < (set point (SP) + alarm value), the alarm output maintains the state of the previous scan.</p> <p> portion is where the standby function operates.</p>  <p style="text-align: center;">-Alarm action point Set point (SP) +Alarm action point</p>	<p>Set point (SP): 200.0°C Alarm 1 alarm value: 5.0°C Alarm 1 hysteresis: 2.0°C</p>  <p>When process variable (PV) \geq 205.0°C, the alarm output is turned ON. When process variable (PV) \leq 203.0°C, the alarm output is turned OFF.</p>
<p>Lower Limit Alarm with Standby</p>	<p>Turns ON the alarm output when process variable (PV) \leq (set point (SP) + alarm value).</p> <p>Turns OFF the alarm output when process variable (PV) \geq (set point (SP) + alarm value + hysteresis).</p> <p>When (set point (SP) + alarm value) < process variable (PV) < (set point (SP) + alarm value + hysteresis), the alarm output maintains the state of the previous scan.</p> <p> portion is where the standby function operates.</p>  <p style="text-align: center;">-Alarm action point Set point (SP) +Alarm action point</p>	<p>Set point (SP): 200.0°C Alarm 1 alarm value: -5.0°C Alarm 1 hysteresis: 2.0°C</p>  <p>When process variable (PV) \leq 195.0°C, the alarm output is turned ON. When process variable (PV) \geq 197.0°C, the alarm output is turned OFF.</p>
<p>Upper/Lower Limits Alarm with Standby</p>	<p>Turns ON the alarm output when process variable (PV) \geq (set point (SP) + alarm value).</p> <p>Turns ON the alarm output when process variable (PV) \leq (set point (SP) - alarm value).</p> <p>Turns OFF the alarm output when (set point (SP) - alarm value + hysteresis) \leq process variable (PV) \leq (set point (SP) + alarm value - hysteresis).</p> <p>When (set point (SP) + alarm value - hysteresis) < process variable (PV) < (set point (SP) + alarm value), the alarm output maintains the state of the previous scan.</p> <p>When (set point (SP) - alarm value) < process variable (PV) < (set point (SP) - alarm value + hysteresis), the alarm output maintains the state of the previous scan.</p> <p> portion is where the standby function operates.</p>  <p style="text-align: center;">-Alarm action point Set point (SP) +Alarm action point</p>	<p>Set point (SP): 200.0°C Alarm 1 alarm value: 5.0°C Alarm 1 hysteresis: 2.0°C</p>  <p>When process variable (PV) \geq 205.0°C, the alarm output is turned ON. When process variable (PV) \leq 195.0°C, the alarm output is turned ON. When 197.0°C \leq process variable (PV) \leq 203.0°C, the alarm output is turned OFF.</p>

Even when alarm output is active, the PID module continues control. To stop control, this must be handled in the ladder program. For ladder program example details, see Chapter 7 "Application Examples" - "Ladder Program Example" on page 7-7.

- (8) Control Register+37: Alarm 1 Value**
Control Register+38: Alarm 2 Value
Control Register+39: Alarm 3 Value
Control Register+40: Alarm 4 Value
Control Register+41: Alarm 5 Value
Control Register+42: Alarm 6 Value
Control Register+43: Alarm 7 Value
Control Register+44: Alarm 8 Value

The alarm value is the value that the PID module compares with the process variable (PV) as the point to perform the alarm action. There are two types of alarms: Deviation alarm and process alarm.

A deviation alarm is a way of specifying the alarm value, and it sets a value that is the deviation from the PID module set point (SP) as the alarm value.

A process alarm is a way of specifying the alarm value, and it sets a temperature to perform the alarm action as the alarm value, regardless of the PID module set point (SP).

	Alarm Type	Alarm Value	Alarm Action
Deviation Alarm	Upper/Lower limit range alarm	Deviation from the set point (SP) is the alarm value.	The alarm output turns off if the process variable (PV) exceeds the range.
	Upper limit alarm, Lower limit alarm, Upper/Lower limits alarm, Upper limit alarm with standby, Lower limit alarm with standby, Upper/Lower limits alarm with standby		The alarm output turns on if the process variable (PV) exceeds the range.
Process Alarm	Process high alarm Process low alarm	The alarm action point is the alarm value.	The alarm output turns on if the process variable (PV) exceeds the alarm value.

- (9) Control Register+73: Alarm 1 Hysteresis**
Control Register+74: Alarm 2 Hysteresis
Control Register+75: Alarm 3 Hysteresis
Control Register+76: Alarm 4 Hysteresis
Control Register+77: Alarm 5 Hysteresis
Control Register+78: Alarm 6 Hysteresis
Control Register+79: Alarm 7 Hysteresis
Control Register+80: Alarm 8 Hysteresis

Alarm hysteresis is the span between when an alarm turns from on to off or vice versa. If the alarm hysteresis is narrowed, the alarm output switches to on or off even by a slight variation of temperature at around the alarm action point. This frequent on/off of an alarm may negatively affect the connected equipment. To prevent that harmful effect, configure the alarm hysteresis for alarm on/off action.

- (10) Control Register+81: Alarm 1 Delay Time**
Control Register+82: Alarm 2 Delay Time
Control Register+83: Alarm 3 Delay Time
Control Register+84: Alarm 4 Delay Time
Control Register+85: Alarm 5 Delay Time
Control Register+86: Alarm 6 Delay Time
Control Register+87: Alarm 7 Delay Time
Control Register+88: Alarm 8 Delay Time

The alarm is not triggered until the configured time elapses after the process variable (PV) enters the alarm output range. The input fluctuation due to noise may result in alarm output turning on. This can be prevented by configuring the alarm delay time. When an alarm output is changed from on to off status, the alarm output turns off and the alarm action delay time is reset. When the alarm output is changed from off to on status, the time counting starts.

6: CONFIGURING PID MODULE USING WINDLDR

Input Parameters when External SP Input is Selected

The input CH1 parameters when External SP input is selected as the Input CH1 Function are described here.

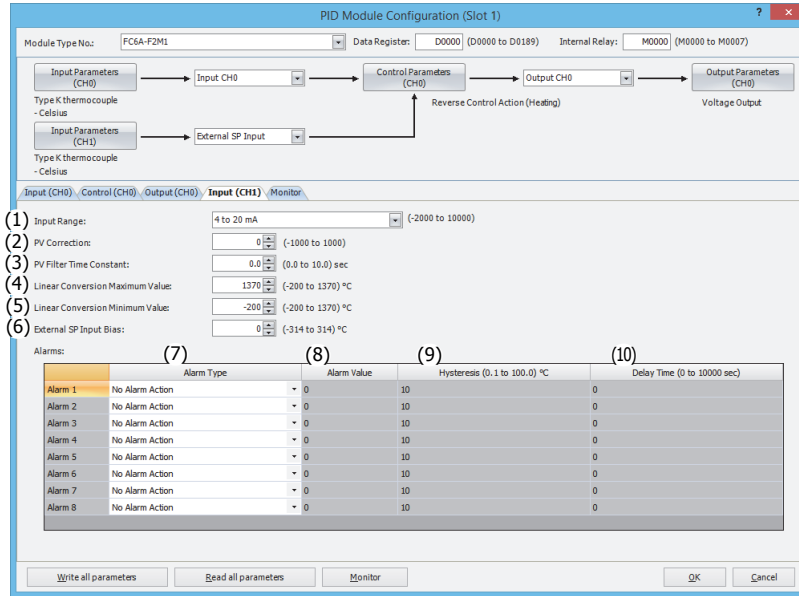

(1) Control Register+55: Input Range

The input range is the input type and unit handled as the PID control process variable. Select input type for the external SP input. Current (4 to 20mA DC or 0 to 20mA DC) or voltage (0 to 1V DC or 1 to 5V DC) can be selected.

(2) Control Register+62: PV Correction

PV correction is a function to correct the process value (PV). If the sensor cannot be installed to the location of the control target, the temperature measured by the sensor may deviate from the actual temperature of the control target. When a target is controlled with multiple PID modules, the measured temperatures may not match due to the differences in sensor accuracy or dispersion of load capacities even though the set points (SP) of those PID modules are the same. In such cases, the process variable (PV) of the PID module can be adjusted to the desired temperature by using the PV Correction.

The process variable (PV) after PV correction can be calculated using the following formula.

$$\text{Process variable (PV) after PV correction} = \text{Process variable (PV)} + (\text{PV correction value})$$

(3) Control Register +63: PV Filter Time Constant

The PV filter function is a software filter to stabilize the process variable (PV) affected by fluctuating processes such as pressure or flow rate by calculating first-order lag of the process variable (PV). Even if the process variable (PV) changes as shown in the Figure 1, when the PV filter time constant is configured, the process variable (PV) changes as shown in the Figure 2. After the PV filtering process, the process variable (PV) reaches 63% of the process variable (PV) in T seconds.

If the PV filter time constant is too large, it adversely affects the control results due to the delay of response.

Example: If the least significant digit of the process variable (PV) is fluctuating, the fluctuation can be suppressed by using the PV filter time constant.

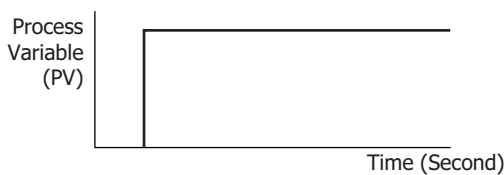

Figure 1. Process variable (PV) before PV filtering process

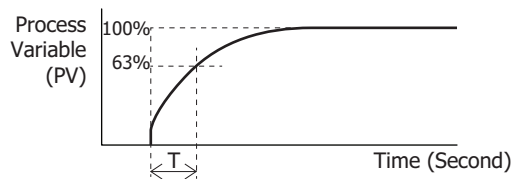

Figure 2. Process variable (PV) after PV filtering process

(4) Control Register+178: External SP Input Linear Conversion Maximum Value

The external SP input linear conversion maximum value is the linear conversion maximum value for the external SP input. When input type is current (4 to 20mA DC or 0 to 20mA DC), configure the value corresponding to 20 mA for input CH1. When input type is voltage (0 to 1V DC or 1 to 5V DC), configure the value corresponding to 1 V or 5 V for input CH1.

Example: When input type is current (4 to 20mA DC), if the external SP input linear conversion maximum value is 1,000°C, external SP input 20mA corresponds to the set point (SP) 1,000°C for CH0 control. When input type is voltage (0 to 1V DC), if external SP input linear conversion maximum value is 1,200°C, external SP input 1 V corresponds to the set point (SP) 1,200°C for CH0 control.

(5) Control Register+179: External SP Input Linear Conversion Minimum Value

The external SP input linear conversion minimum value is the linear conversion minimum value for the external SP input. When input type is current (4 to 20mA DC or 0 to 20mA DC), configure the value corresponding to 4 mA or 0 mA for input CH1. When input type is voltage (0 to 1V DC or 1 to 5V DC), configure the value corresponding to 0 V or 1 V for input CH1.

Example: When input type is current (4 to 20mA DC), if external SP input linear conversion minimum value is 0°C, external SP input 4 mA corresponds to the set point (SP) 0°C for CH0 control. When input type is voltage (0 to 1V DC), if external SP input linear conversion maximum value is set to -20°C, external SP input 0 V corresponds to the set point (SP) -20°C for CH0 control.

(6) Control Register+177: External SP Input Bias

This function sets the CH0 control set point (SP) by first performing linear conversion on the input CH1 input value, and then adding the external SP input bias value to this obtained value.

Examples: When the input type is current (4 to 20mA DC), the linear conversion maximum value is 1,000°C, the linear conversion minimum value is 0°C, and the external SP input bias is 50°C, the set point (SP) of CH0 control corresponding to 12 mA of external SP input will be 550°C.

When the input type is voltage (0 to 1V DC), the linear conversion maximum value is 1,000°C, the linear conversion minimum value is 0°C, and the external SP input bias is 50°C, the set point (SP) of CH0 control corresponding to 0.5 V of external SP input will be 550°C.

- (7) Control Register+65: Alarm 1 Type**
- Control Register+66: Alarm 2 Type**
- Control Register+67: Alarm 3 Type**
- Control Register+68: Alarm 4 Type**
- Control Register+69: Alarm 5 Type**
- Control Register+70: Alarm 6 Type**
- Control Register+71: Alarm 7 Type**
- Control Register+72: Alarm 8 Type**

The alarm type is the operation type where the PID module compares the process variable (PV) with a preset value (alarm value) and performs ON/OFF control. When external SP input is selected with the input CH1 function selection, the following three operation types can be selected as the alarm type.

Select one of the alarm types from process high alarm, process low alarm, and no alarm action. The same alarm type can be selected in multiple alarms.

Alarm Actions

Type	Operation	Example
Process High Alarm	<p>Turns ON the alarm output when process variable (PV) ≥ alarm value. Turns OFF the alarm output when process variable (PV) ≤ (alarm value - hysteresis). When (alarm value - hysteresis) < process variable (PV) < alarm value, the alarm output maintains the state of the previous scan.</p>	<p>Alarm 1 Value: 205.0°C Alarm 1 Hysteresis: 2.0°C</p> <p>When process variable (PV) ≥ 205.0°C, the alarm output is turned ON. When process variable (PV) ≤ 203.0°C, the alarm output is turned OFF.</p>

6: CONFIGURING PID MODULE USING WINDLDR

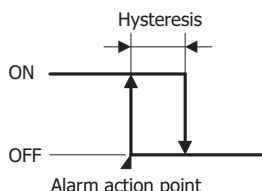
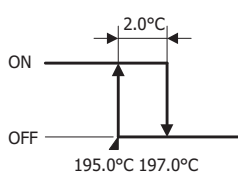
Type	Operation	Example
Process Low Alarm	<p>Turns ON the alarm output when process variable (PV) \leq alarm value. Turns OFF the alarm output when process variable (PV) \geq (alarm value + hysteresis). When alarm value < process variable (PV) < (alarm value + hysteresis), the alarm output maintains the state of the previous scan.</p>  <p>Alarm action point</p>	<p>Alarm 1 alarm value: 195.0°C Alarm 1 hysteresis: 2.0°C</p>  <p>When process variable (PV) \leq 195.0°C, the alarm output is turned ON. When process variable (PV) \geq 197.0°C, the alarm output is turned OFF.</p>

- (8) Control Register+37: Alarm 1 Value**
- Control Register+38: Alarm 2 Value**
- Control Register+39: Alarm 3 Value**
- Control Register+40: Alarm 4 Value**
- Control Register+41: Alarm 5 Value**
- Control Register+42: Alarm 6 Value**
- Control Register+43: Alarm 7 Value**
- Control Register+44: Alarm 8 Value**

The alarm value is the value that the PID module compares with the process variable (PV) as the point to perform the alarm action.

When external SP input is selected with the input CH1 function selection, the alarm type is a process alarm. A process alarm is a way of specifying the alarm value, and it sets a temperature to perform the alarm action as the alarm value, regardless of the PID module set point (SP).

	Alarm Type	Alarm Value	Alarm Action
Process Alarm	Process high alarm	The alarm action point is the alarm value.	The alarm output turns on if the process variable (PV) exceeds the alarm value.
	Process low alarm		

- (9) Control Register+73: Alarm 1 Hysteresis**
- Control Register+74: Alarm 2 Hysteresis**
- Control Register+75: Alarm 3 Hysteresis**
- Control Register+76: Alarm 4 Hysteresis**
- Control Register+77: Alarm 5 Hysteresis**
- Control Register+78: Alarm 6 Hysteresis**
- Control Register+79: Alarm 7 Hysteresis**
- Control Register+80: Alarm 8 Hysteresis**

Alarm hysteresis is the span between when an alarm turns from on to off or vice versa. If the alarm hysteresis is narrowed, the alarm output switches to on or off even by a slight variation of temperature at around the alarm action point. This frequent on/off of an alarm may negatively affect the connected equipment. To prevent that harmful effect, configure the alarm hysteresis for alarm on/off action.

- (10) Control Register+81: Alarm 1 Action Delay Time**
- Control Register+82: Alarm 2 Action Delay Time**
- Control Register+83: Alarm 3 Action Delay Time**
- Control Register+84: Alarm 4 Action Delay Time**
- Control Register+85: Alarm 5 Action Delay Time**
- Control Register+86: Alarm 6 Action Delay Time**
- Control Register+87: Alarm 7 Action Delay Time**
- Control Register+88: Alarm 8 Action Delay Time**

The alarm is not triggered until the configured time elapses after the process variable (PV) enters the alarm output range. The input fluctuation due to noise may result in alarm output turning on. This can be prevented by configuring the alarm delay time. When an alarm output is changed from on to off status, the alarm output turns off and the alarm action delay time is reset. When the alarm output is changed from off to on status, the time counting starts.

PID Module Configuration - Control Parameters Details

This section describes details about the parameters related to control of CH0 control and CH1 control.

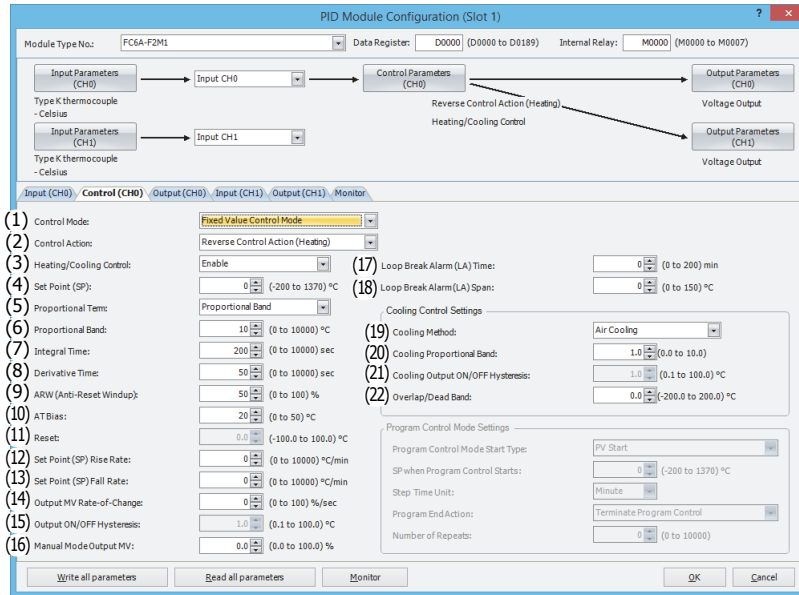

Control Parameters when Program Control Mode Is Selected

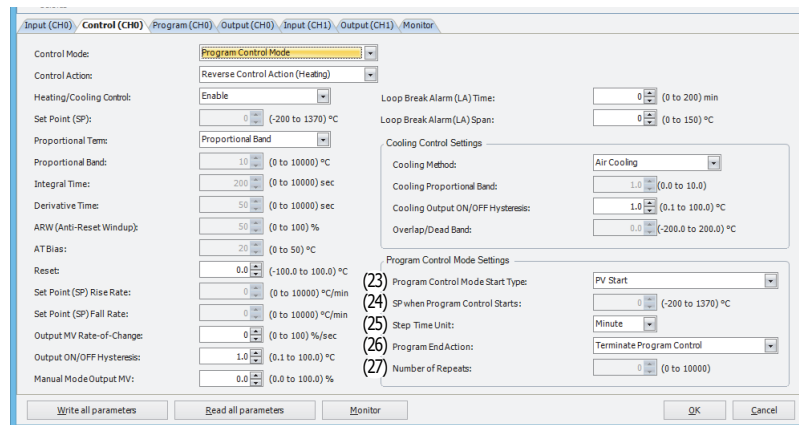

Control parameters of CH0 control are described here. When the program control mode is selected as the control mode, parameters for the fixed value control mode, such as the set point (SP), proportional band/proportional gain, or integral time, are disabled. The parameters for the program control mode (23) to (27) are enabled.

Control parameters for CH1 control are the same as those of CH0 control except cascade control parameters. However, the position from the control register for each parameter differs. For details about the offset from the control register for CH1 control, see "Block 1: Write Only Parameters" on page 5-10 to "Blocks 4, 5: Initial Setting Parameters (SHOT Action)" on page 5-20.

(1) Control Register+90: Control Mode

The control mode is the control type that performs PID control. When the external SP input or the cascade control is selected in Input CH1 Function, the program control mode cannot be used for CH0 control. Select fixed value control mode for control mode of CH0 control. If the program control mode is selected, the external SP input does not function.

The fixed value control is a normal temperature control that the PID module controls the output to eliminate the deviation between a single set point (SP) and the process variable (PV). The following diagram shows an example of the fixed value control.

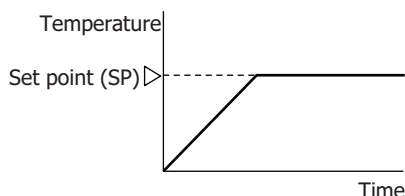

The program control allows you to define the set point (SP) that changes as the time progresses so that the process variable (PV) can be controlled to match the set point (SP) changing as the time progresses. The set point (SP) and time can be configured for each step. A maximum of 10 steps can be configured and performed. The set point (SP) can be configured as shown in the following diagram.

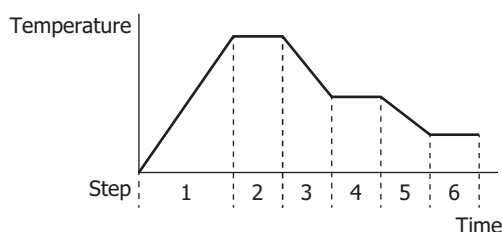

(2) Control Register+53: Control Action

This function selects the control action as direction control action or reverse control action.

In direct control action, the output manipulated variable (MV) increases when the process variable (PV) is higher than the set point (SP) (positive deviation). For example, freezers perform the direct control (cooling) action.

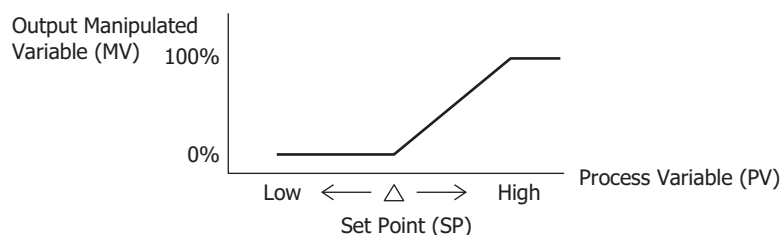

In reverse control action, the output manipulated variable (MV) increases when the process variable (PV) is lower than the set point (SP) (negative deviation). For example, electric furnaces perform the reverse control (heating) action.

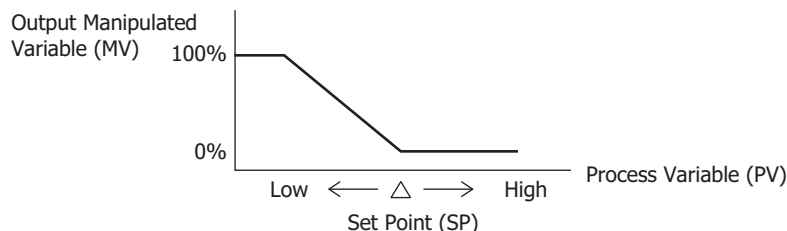

6: CONFIGURING PID MODULE USING WINDLDR

(3) Control Register+54: Heating/Cooling Control

When it is difficult to control a target process with heating control only, cooling control can be added to perform the heating/cooling control. The heating/cooling control can be enabled.

Example: Heating/Cooling control uses both heating and cooling outputs and is suitable for the heat producing processes such as extruders or for temperature control at near the ambient temperature, such as environment testers.

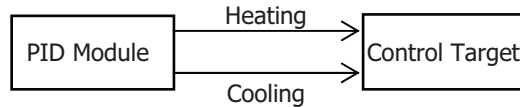

(4) Control Register+20: Set point (SP)

Sets the set point (SP) for PID control.

Any value within the following range can be set.

The valid range of set point (SP) when the input type is thermocouple or resistance thermometer:

Set point (SP) lower limit \leq Set point (SP) \leq Set point (SP) upper limit

The valid range of set point (SP) when the input type is voltage or current:

Linear conversion minimum value \leq Set point (SP) \leq Linear conversion maximum value

If the input type or input unit type is changed, confirm the valid range of set point (SP) and configure an appropriate value.

(5) Control Register+94: Proportional Term

The proportional term is the function to select the proportional term.

Either proportional band or proportional gain can be selected to use. The proportional band, which is expressed in percentage form (%), is the span of the input necessary for the output manipulated variable (MV) to change from 0% to 100%. The proportional gain is the coefficient to calculate the output manipulated variable (MV) of the proportional action. The proportional gain can be obtained as the quotient of 100 and the proportional band.

Example: When the proportional band is 50%, the corresponding proportional gain will be 2% (100/50).

(6) Control Register+26: Proportional Band/Proportional Gain

The proportional band is the range that the manipulated variable is proportionated according to the size of the deviation between the set point (SP) and the process variable (PV). Proportional gain is a factor for calculating the manipulated variable of the proportional action, and it is a value that expressed as 100/proportional band.

The output of the proportional action varies in proportion to the deviation between the set point (SP) and the process variable (PV). When the heating/cooling control is enabled, this parameter becomes the heating proportional band. The control action will be ON/OFF control when the proportional band/proportional gain is 0.

If the proportional band is broadened (proportional gain is made smaller), the control output starts turning on or off at the significantly low temperatures from the set point (SP), overshoot or hunting is reduced; however, it takes time for the process variable (PV) to reach the set point (SP), and the offset between the process variable (PV) and the set point (SP) is broadened.

If the proportional band is narrowed (proportional gain is made larger), the control output starts turning on or off at around the set point (SP), the time until the process variable (PV) reaches the set point (SP) is shortened, and the offset is small; however, the hunting phenomenon is frequent. If the proportional band is greatly narrowed, the control action becomes similar to the ON/OFF control action.

An appropriate proportional band/proportional gain for the control target can be automatically calculated using auto-tuning (AT) function. It is unnecessary to configure the proportional band/proportional gain in the WindLDR when using the auto-tuning (AT) function.

(7) Control Register+27: Integral Time

Integral time is a factor that determines the manipulated variable by the integral action.

In the proportional control action, the offset is generated even when the control is stabilized. The integral action corrects the offset. The integral action is disabled when the integral time is 0.

If the integral time is shortened too much, the integral action becomes strong. The offset can be corrected in a shorter time; however, the hunting phenomenon may be caused over a long cycle. On the contrary, if the integral time is extended too much, the integral action becomes weak and it takes time to correct the offset.

An appropriate integral time for the control target can be automatically calculated using auto-tuning (AT) function. It is unnecessary to configure the integral time in the WindLDR when using the auto-tuning (AT) function.

(8) Control Register+28: Derivative Time

Derivative time is a factor that determines the manipulated variable by the derivative action.

When the set point (SP) is changed or when the deviation between the set point (SP) and the process variable (PV) is increased due to a disturbance, the derivative action increases the output manipulated variable (MV) to rapidly correct the deviation between the process variable (PV) and the set point (SP). The derivative time is a coefficient to determine the output manipulated variable (MV) of the derivative action. The derivative action is disabled when the derivative time is 0.

If the derivative time is shortened, the derivative action becomes weak. The response to the rapid temperature change becomes slower. Because the action to suppress the rapid temperature rise becomes weaker, the time for the process variable (PV) to reach the set point (SP) is shortened; however, overshoot can occur.

If the derivative time is extended, the derivative action becomes strong. The response to the rapid temperature change becomes faster. Because the action to suppress the rapid temperature rise becomes strong, the time for the process variable (PV) to reach the set point (SP) is extended; however, overshoot can be decreased.

An appropriate derivative time for the control target can be automatically calculated using auto-tuning (AT) function. It is unnecessary to configure the derivative time in the WindLDR when using the auto-tuning (AT) function.

(9) Control Register+29: ARW (Anti-Reset Windup)

When the control is started, there is a large deviation between the set point (SP) and the process variable (PV). The integral action continues its action in a given direction until the process variable (PV) reaches the set point (SP). As a result, an overshoot is caused by the excessive integral action. ARW suppresses the overshoot by limiting the integral action area. ARW (anti-reset windup) is a function to prevent this overshooting.

When ARW is 0%, the integral action area becomes the minimum and the suppression of the overshoot is maximized. When ARW is 50%, the integral action area becomes the intermediate and the suppression of the overshoot is intermediate. When ARW is 100%, the integral action area becomes the maximum and the suppression of the overshoot is minimized.

An appropriate ARW for the control target can be automatically calculated using auto-tuning (AT) function. It is unnecessary to configure the ARW in the WindLDR when using the auto-tuning (AT) function.

(10) Control Register+89: AT Bias

AT bias is the bias during auto tuning (AT). Auto-tuning (AT) starting point can be specified with the AT bias.

When Process variable (PV) \leq Set point (SP) – AT bias:

$$\text{AT starting point} = \text{Set point (SP)} - \text{AT bias}$$

When Process variable (PV) \geq Set point (SP) + AT bias:

$$\text{AT starting point} = \text{Set point (SP)} + \text{AT bias}$$

When Set point (SP) – AT bias $<$ Process variable (PV) $<$ Set point (SP) + AT bias:

$$\text{AT starting point} = \text{Set point (SP)}$$

For details about the AT bias, see "Auto-tuning (AT)" on page 4-7.

(11) Control Register+31: Reset

This function corrects the offset (deviation between the set point (SP) and the process variable (PV)) that occurs in the P action or PD action.

Reset can be configured only in P (integral time and derivative time are 0) or PD (integral time is 0) control action.

P or PD control action is used for the control target in which overshoot caused by the integral action is hard to be suppressed.

When the reverse control action is selected, the manipulated variable is calculated with the ratio of the reset to the proportional band, and the calculated manipulated variable is added to the output manipulated variable (MV). When the direct control action is selected, the manipulated variable is calculated with the ratio of the reset to the proportional band, and the calculated manipulated variable is subtracted from the output manipulated variable (MV).

(12) Control Register+33: Set Point (SP) Rise Rate

(13) Control Register+34: Set Point (SP) Fall Rate

When the set point (SP) is widely changed, this function makes the set point (SP) change gradually. The rising/falling span of the set point (SP) in 1 minute can be configured.

When the set point (SP) is changed, the set point (SP) is gradually changed from the original set point (SP) to the new set point (SP) with the configured ratio ($^{\circ}\text{C}/\text{minute}$, $^{\circ}\text{F}/\text{minute}$). When the control is started, the set point (SP) is gradually changed from the process variable (PV) to the set point (SP) with the configured ratio ($^{\circ}\text{C}/\text{minute}$, $^{\circ}\text{F}/\text{minute}$). In the fixed value control mode, this function is used to configure the desired temperature gradient until the process variable (PV) reaches the set point (SP). This function is disabled when the set point (SP) rise/fall rate is 0.

(14) Control Register+32: Output Manipulated Variable Rate-of-Change

The output manipulated variable rate-of-change is the rate that the output manipulated variable changes in one second. This function is disabled when the value is 0.

In the case of heating control, when there is a large deviation between the process variable (PV) and the set point (SP), the output immediately changes from off to on as shown in the diagram below (Normal Output). By configuring the output manipulated variable rate-of-change, the maximum change of the output manipulated variable (MV) in one second can be changed as shown in the diagram below (Output When Output Manipulated Variable Rate-of-Change is Configured).

This function can be used for a high temperature heater (used at approximately 1,500 to 1,800 $^{\circ}\text{C}$) which has to be heated gradually, as the heater can be burnt out if the power is supplied rapidly.

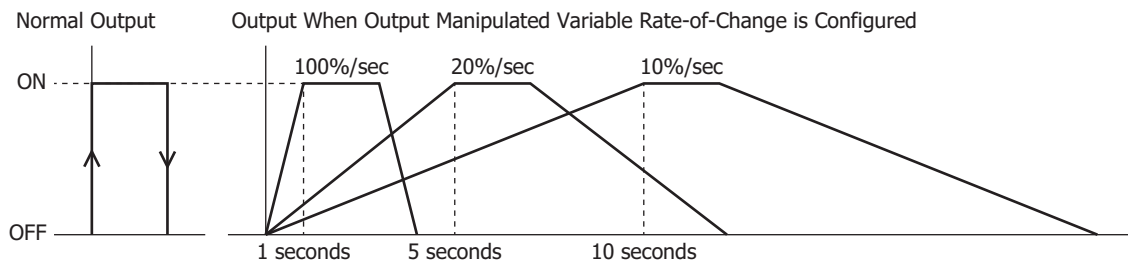

(15) Control Register+61: Output ON/OFF Hysteresis

Output ON/OFF hysteresis is the span between when an alarm turns from on to off or vice versa.

If the output on/off hysteresis is narrowed, the control output switches to on or off even by a slight variation of temperature at around the set point (SP). This frequent on/off shortens the output relay life and may negatively affect the connected equipment. To prevent that harmful effect, the hysteresis is provided for on/off control action.

Output on/off hysteresis can be configured only for the ON/OFF control action (when the proportional band or proportional gain is 0).

(16) Control Register+21: Manual Mode Output Manipulated Variable

Manual mode output manipulated variable is the output manipulated variable (MV) during manual mode.

The output manipulated variable (MV) for the manual mode can be configured.

(17) Control Register+35: Loop Break Alarm Time

The loop break alarm is a function that judges the failure of the heater, sensor, or control element and outputs an alarm in the following cases.

Configure the loop break alarm time to detect the loop break alarm. The loop break alarm is disabled when the loop break alarm time is 0. When one of the following conditions is met, the PID module considers that heater burnout, sensor burnout, or actuator trouble is detected and triggers the loop break alarm.

When the reverse control action is selected:

- The loop break alarm is triggered when the process variable (PV) does not rise as much as the loop break alarm span within the loop break alarm time while the output manipulated variable (MV) is 100% or the output manipulated variable upper limit.
- The loop break alarm is also triggered when the process variable (PV) does not fall as much as the loop break alarm span within the loop break alarm time while the output manipulated variable (MV) is 0% or the output manipulated variable lower limit.

When the direct control action is selected:

- The loop break alarm is triggered when the process variable (PV) does not fall as much as the loop break alarm span within the loop break alarm time while the output manipulated variable (MV) is 100% or the output manipulated variable upper limit.
- The loop break alarm is also triggered when the process variable (PV) does not rise as much as the loop break alarm span within the loop break alarm time while the output manipulated variable (MV) is 0% or the output manipulated variable lower limit value.

Even when the loop break alarm is triggered, the PID module continues its control. To stop the control, ladder programming is needed.

Ladder Program Example

The control register is D1000 in this example.

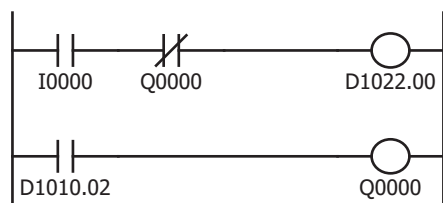

When external input I0 is turned on, CH0 control is enabled. When Q0 (loop break alarm output of CH0 control) is turned on, CH0 control is disabled.

When loop break alarm is triggered, D1010.2 (loop break alarm output) is turned on, and Q0 is turned on.

When the loop break alarm time is set to 0, the loop break alarm does not function.

(18) Control Register+36: Loop Break Alarm Span

The loop break alarm span is the operating span to judge the loop break alarm. The loop break alarm is disabled when the loop break alarm span is 0.

(19) Control Register+95: Cooling Method

When the heating/cooling control is enabled, select the cooling method from air cooling, oil cooling, or water cooling. The output characteristics for the cooling output manipulated variable (MV) are shown below.

Air cooling: linear characteristic

Oil cooling: 1.5th power of the linear characteristic

Water cooling: 2nd power of the linear characteristic

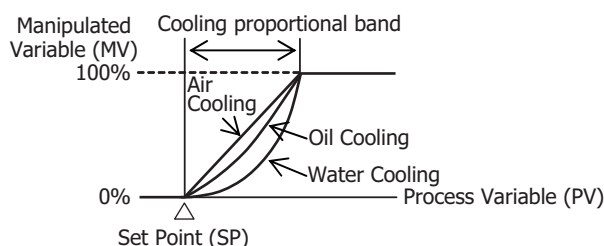

(20) Control Register+48: Cooling Proportional Band

The cooling proportional band is the cooling proportional band when heating/cooling control is enabled. The cooling proportional band is the multiplication of the heating proportional band.

Example: When the heating proportional band is 10°C and the cooling proportional band is 2.0, the cooling proportional band will be 20°C. If cooling proportional band value is 0.5, the cooling proportional band will be 5°C.

If the cooling proportional band is 0, the cooling side control will be ON/OFF control action. If the heating proportional band is 0, both heating and cooling side controls will be ON/OFF control action.

(21) Control Register+98: Cooling Output ON/OFF Hysteresis

Cooling output ON/OFF hysteresis is the span between when the cooling control action turns from on to off or vice versa when heating/cooling control is enabled.

If the cooling output on/off hysteresis is narrowed, the cooling control output switches to on or off even by a slight variation of temperature at around the set point (SP). This frequent on/off shortens the output relay life and may negatively affect the connected equipment. To prevent that harmful effect, the hysteresis is provided for on/off control action.

Cooling output on/off hysteresis can be configured only when cooling control action is in ON/OFF control (when cooling proportional band is 0).

6: CONFIGURING PID MODULE USING WINDLDR

(22) Control Register+50: Overlap/Dead Band

When heating/cooling control is enabled, overlap is the region where both the heating and cooling outputs turn on at the same time around the set point (SP), and dead band is the region where neither output turns on. When the configured value is bigger than 0, the value is used as the dead band. When the configured value is less than 0, the value is used as overlap band.

When the overlap band is configured, the area in which both heating and cooling control outputs are turned on is generated, and the energy loss is caused. However, the overlap helps enhance the control accuracy and accelerate the response.

When the dead band is configured, the area in which neither heating nor cooling control outputs are turned on is generated. In the dead band, the control accuracy and responsiveness is lowered; however, the energy loss can be suppressed.

Overlap Band Action

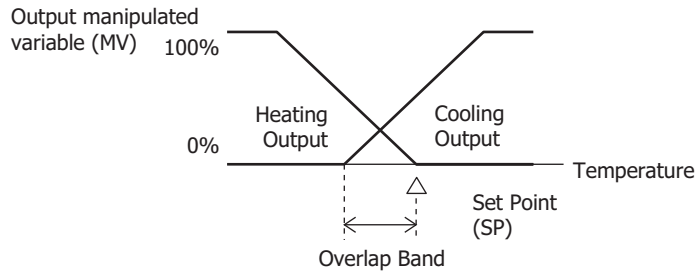

Dead Band Action

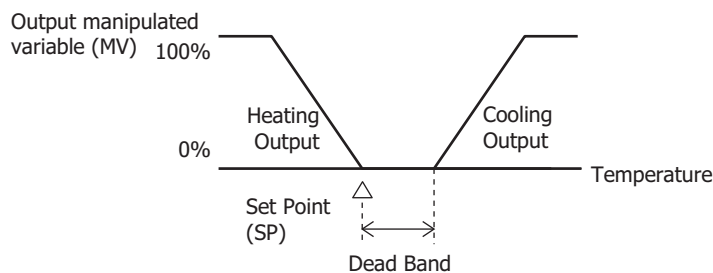

(23) Control Register+91: Program Control Mode Start Type

The program control start type is the starting method for program control, and it is selected from the following.

PV Start: When the program control is started, the time is advanced until the set point (SP) becomes equal to the process variable (PV), and then the program control starts.

PVR Start: When "Continue program control (Repeat)" is selected as the program end action, the time is advanced until the set point (SP) becomes equal to the process variable (PV) at which program control is terminated, and then the next program control starts.

SP Start: When the program control is started, the program control starts from the set point (SP) that is configured as "Set Point (SP) when Program Control Starts."

Examples for the PV start, PVR start and SP start actions are described using the following program pattern.

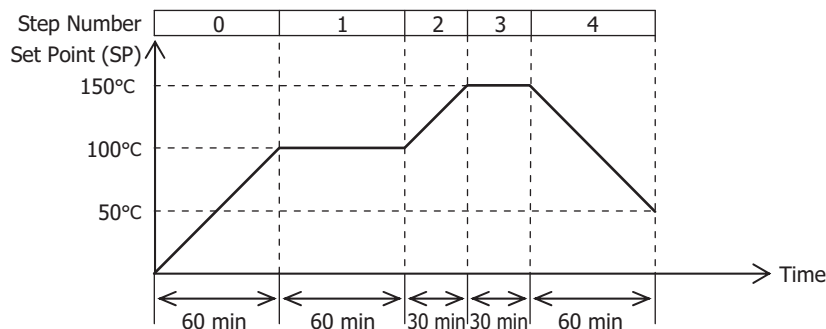

PV Start Action [Process variable (PV) is 25°C]

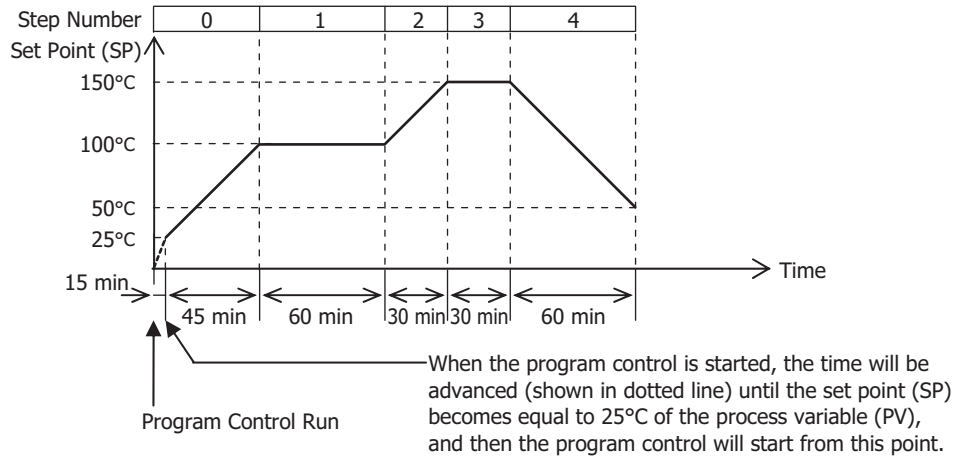

PV Start Action [Process variable (PV) is 170°C]

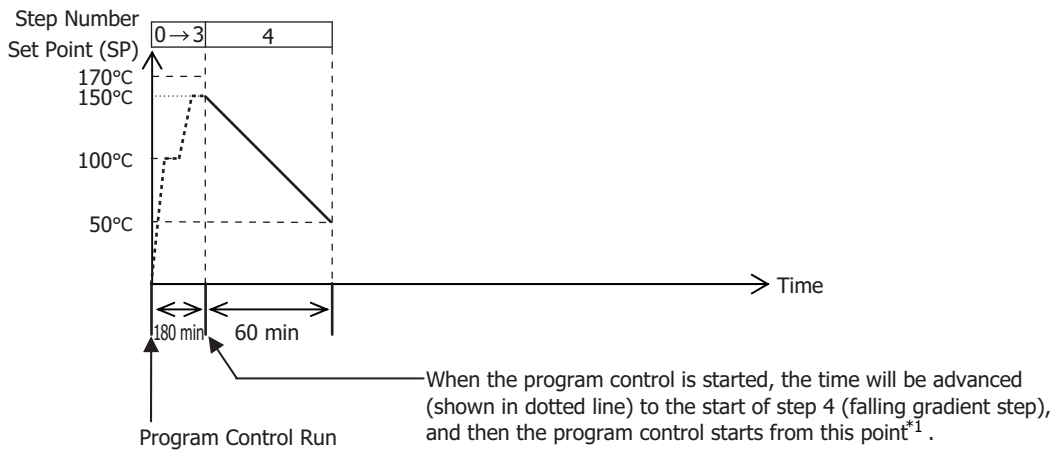

*1 In the above program pattern, if the set point (SP) of step 4 is 0°C and the step time of step 4 is 0 minutes (falling gradient step does not exist), the time will be advanced to the end of Step 3, and the program control will be terminated.

PVR Start Action [Process variable (PV) is 25°C]

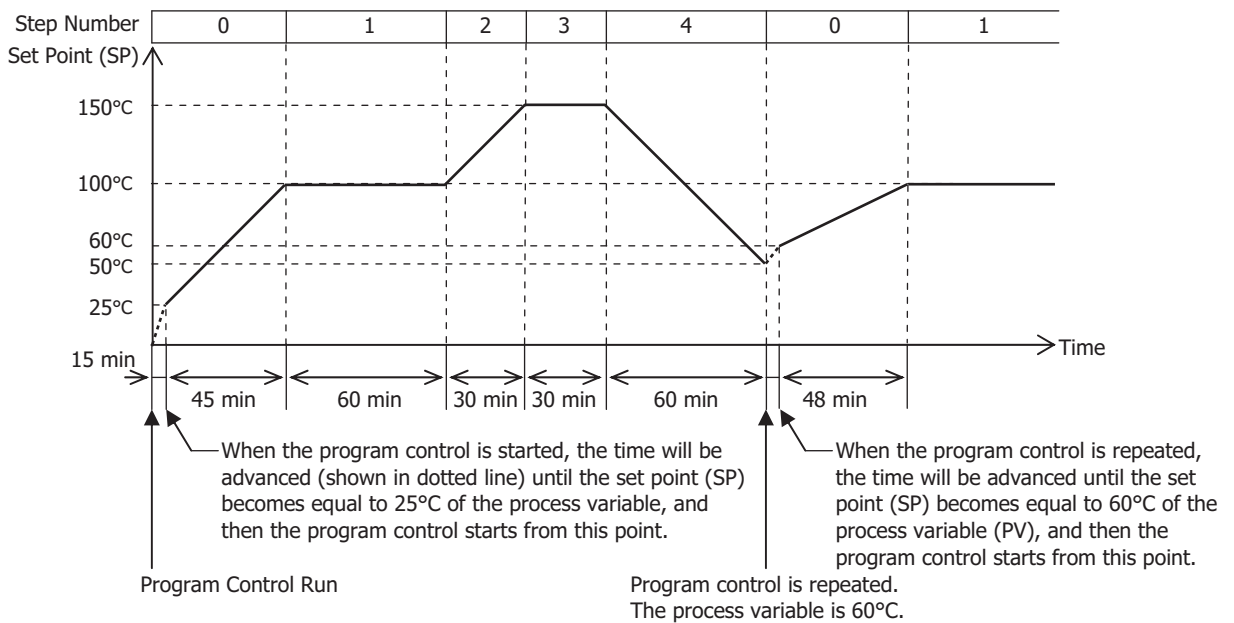

SP Start Action [Set point (SP) when Program Control Starts is 0°C]

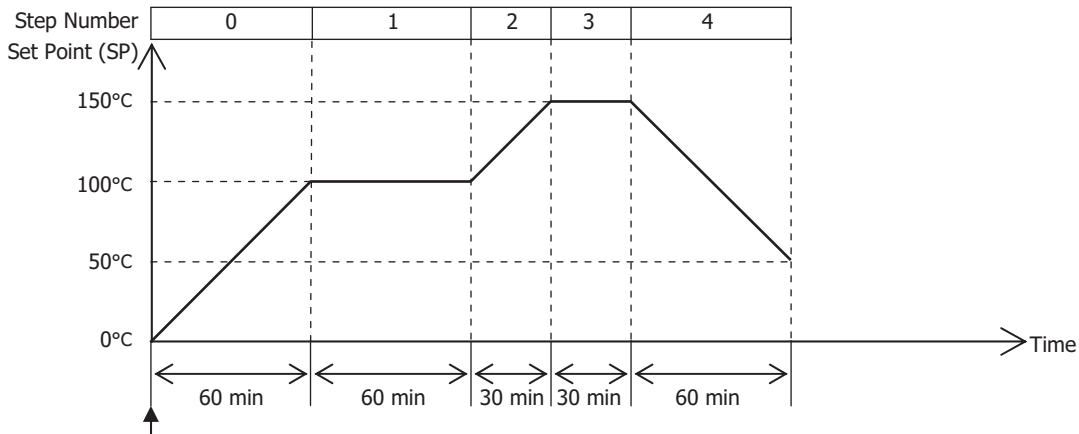

When the program control is started, the program control will start from 0°C of the set point (SP) configured with "Set Point (SP) when Program Control Starts" regardless of the current process variable (PV).

(24) Control Register+96: Set Point (SP) when Program Control Starts

The set point (SP) when program control starts is the set point (SP) when program control starts. The program control starts with this set point (SP) when the SP start is selected as the program control mode start type.

(25) Control Register+92: Step Time Unit

The step time unit is the unit for advancing program control time. Select minute or second for the step time unit.

(26) Control Register+93: Program End Action

The action to be taken when the program control is terminated can be selected. The program control is terminated when all steps 0 to 9 are performed and finished. Each step is performed with the parameters configured for each step. Steps to which step time 0 is configured are also performed. For example, if the program control of 4 steps is required, configure parameters of steps 0 to 3 and set the step time of the remaining steps 4 to 9 to zero.

Terminate programcontrol:

When the program control is terminated, the program end output bit is turned on and maintained, and the PID module will be in standby status. The program control can be executed again by turning off to on the program control bit (operation parameter bit3). During the program control standby (waiting for program control run) status, the control output is turned off, and the operating status is not updated except the over range, the under range, and the program end output.

Continue program control (Repeat):

When the program control is terminated, the program control is repeated from step 0 as many times as the configured number of repeats. When the step 9 of the last program control cycle is performed and finished, the program end output bit is turned on and maintained.

Hold program control:

When the program control is terminated, the program control is held at the last status of step 9. The program end output and program hold bit are turned on and maintained. While the program control is held, the fixed value control is performed with the set point (SP) of step 9. If advance next function (operation parameter Bit6 is turned off to on) is executed while the program control is held, the program control is started again from step 0. The program end output and program hold bit are turned off. While the program control is being held, the parameters of Blocks 10 to 19 and 30 to 39 can be changed. The program control can be executed again after changing the program parameters, such as the set point (SP) or step time of each step.

(27) Control Register+97: Number of Repeats

The number of repeats is the number of times to repeat step 0 to step 9 of program control. Program control can be performed with a number of steps greater than 10 steps by changing the parameters of the steps saved in the data registers while repeating step 0 to step 9.

Control Parameters when Cascade Control is Selected

(1) Control Register+178: External SP Input Linear Conversion Maximum Value

Configure the external SP input linear conversion maximum value for the cascade control. The output manipulated variable (MV) (0 to 100%) of the master (CH1 control) corresponds to the set point (SP) of the slave (CH0 control). The range of the set point (SP) of the slave (CH0 control) is the external SP input linear conversion minimum value to the external SP input linear conversion maximum value.

Configure the external SP input linear conversion maximum value for when the output manipulated variable (MV) of the master (CH1 control) is 100%.

(2) Control Register+179: External SP Input Linear Conversion Minimum Value

Configure the external SP input linear conversion minimum value for the cascade control. The output manipulated variable (MV) (0 to 100%) of the master (CH1 control) corresponds to the set point (SP) of the slave (CH0 control). The range of the set point (SP) of the slave (CH0 control) is the external SP input linear conversion minimum value to the external SP input linear conversion maximum value.

Configure the external SP input linear conversion minimum value for when the output manipulated variable (MV) of the master (CH1 control) is 0%.

PID Module Configuration - Output Parameters Details

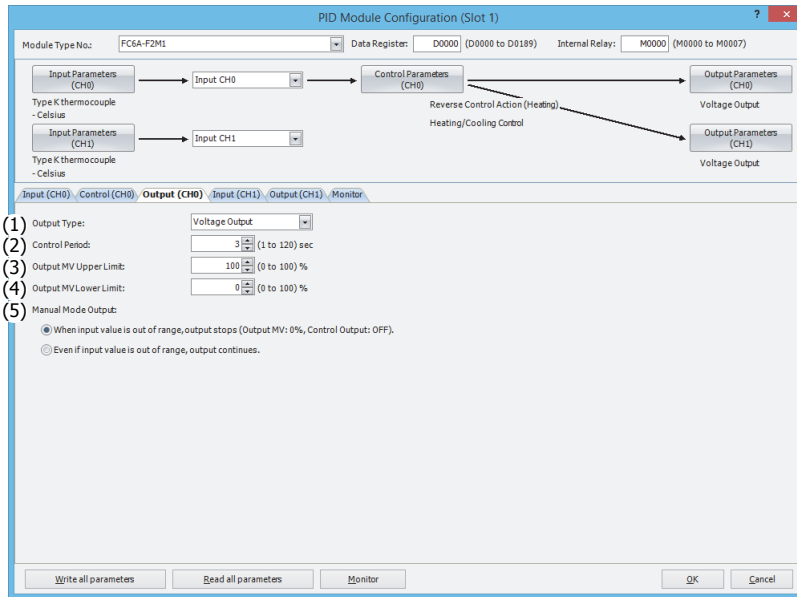

Output Parameters when Heating/Cooling Control is Enabled

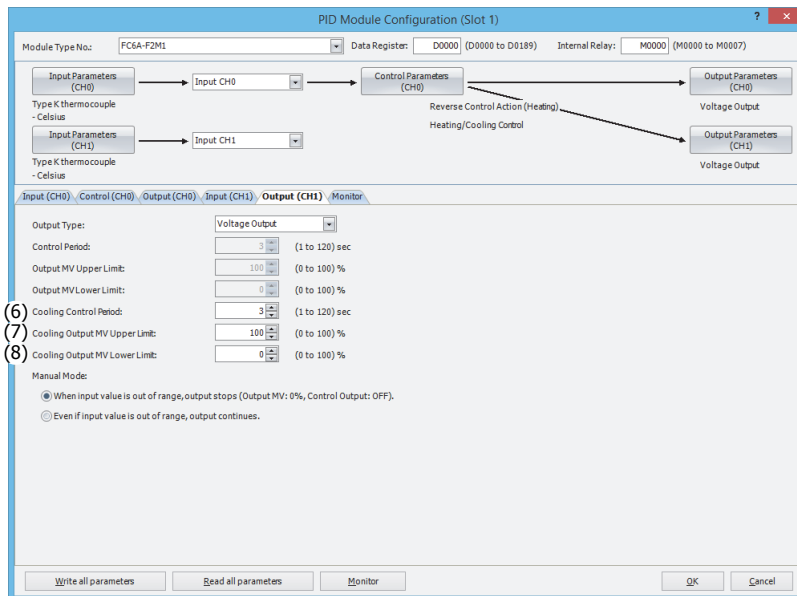

Output parameters of CH0 control are described here. When the heating/cooling control is enabled, the control period and the output manipulated variable (MV) upper and lower limits of CH1 are disabled. The parameters (5) to (7) are enabled.

Output parameters for CH1 control are the same as those of CH0 control except the cooling control parameters. However, the positions from the control register for each parameter differs. For details about the positions from the control register of CH1 control, see "Blocks 2, 3: Basic Parameters (SHOT Action)" on page 5-18 and "Blocks 4, 5: Initial Setting Parameters (SHOT Action)" on page 5-20.

(1) Control Register+99: Output Type

Select the output type for the FC6A-F2M1. Voltage or current output can be selected.

Voltage output: 12V DC±15%

Current output: 4 to 20mA DC

(2) Control Register+30: Control Period

The control period is the period that the control output is turned ON/OFF according to the manipulated variable calculated by PID control. The ON pulse duration of the control output is determined by the product of the control period and the output manipulated variable (MV).

When the heating/cooling control is enabled, the control period will be the heating control period. When the output type is current, the control period is disabled.

Example: When the control period is 5 sec:

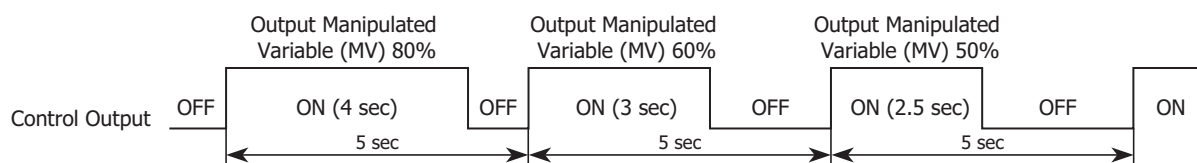
**(3) Control Register+46: Output Manipulated Variable Upper Limit**

The output manipulated variable upper limit is the upper limit value for the output manipulated variable (MV). The output manipulated variable upper limit is used to suppress the output manipulated variable (MV).

Example: When the output manipulated variable (MV) upper limit is 80%, the control output will be 80% even when the output manipulated variable (MV) reaches 100%.

(4) Control Register+47: Output Manipulated Variable Lower Limit

The output manipulated variable lower limit is the lower limit value for the output manipulated variable (MV).

Example: When the output manipulated variable (MV) lower limit is 20%, the control output will be 20% even when the output manipulated variable (MV) is 0%.

(5) Control Register+22 (Bit9): Manual Mode Output Settings

Select the output when in manual mode and the PID control input (process variable) is out of range.

If "Stop output when the input value is out of range (output manipulated variable: 0%, control output: off)", the output manipulated variable is set to 0% and the control output turns off.

If "Continue output when the input value is out of range", the manual mode output MV is output and the control output turns on and off according to the manual mode output MV.

(6) Control Register+49: Cooling Control Period

The cooling control period is the control period for cooling when heating/cooling control is enabled.

The cooling control period is the period that the cooling control output is turned on and off according to the cooling output manipulated variable (MV).

(7) Control Register+51: Cooling Output Manipulated Variable Upper Limit

The cooling output manipulated variable upper limit is the upper limit value for the cooling output manipulated variable (MV). The cooling output manipulated variable upper limit is used to suppress the cooling output manipulated variable (MV).

Example: When the cooling output manipulated variable (MV) upper limit is 80%, the cooling control output will be 80% even when the cooling output manipulated variable (MV) reaches 100%.

(8) Control Register+52: Cooling Output Manipulated Variable Lower Limit

The cooling output manipulated variable lower limit is the lower limit value for the cooling output manipulated variable (MV).

Example: When the cooling output manipulated variable (MV) lower limit is 20%, the cooling control output will be 20% even when the cooling output manipulated variable (MV) is 0%.

PID Module Configuration - Program Parameters Details

This section describes details about the parameters related to program control of CH0 control and CH1 control.

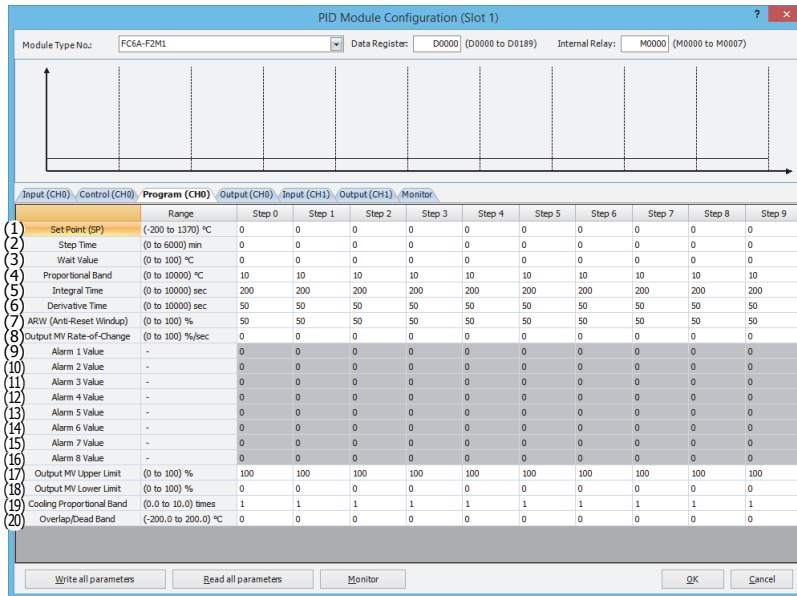

The program parameters of step 0 of CH0 control are described here. The parameters of steps 1 to 9 of CH0 and parameters of steps 0 to 9 of CH1 control are the same as those of step 0 of CH0 control. However, the positions from the control register for each parameter differs. For details about the positions from the control register for each program parameter, see "Blocks 10-19: Program (CH0) Parameters (SHOT Action)" on page 5-23 to "Blocks 30-39: Program (CH1) Parameters (SHOT Action)" on page 5-25.

(1) Control Register+180: Set Point (SP)

Configure the set point (SP) at the end of the step. Any value within the following range can be configured:

When input is thermocouple or resistance thermometer:

$$\text{Set point (SP) lower limit} \leq \text{Set point (SP)} \leq \text{Set point (SP) upper limit}$$

When input is voltage or current:

$$\text{Linear conversion minimum value} \leq \text{Set point (SP)} \leq \text{Linear conversion maximum value}$$

(2) Control Register+181: Step Time

The process time of each step can be configured as the step time.

When the set point (SP) is 500°C and the step time is 30 minutes, the PID module gradually increases the set point (SP) to 500°C in 30 minutes. If the PV Start or PVR Start is selected as the program control mode start type when the program control is started, the time is advanced until the set point (SP) becomes equal to the process variable (PV). Then the program control starts and the set point is gradually increased to 500°C at the end of the step. If the SP Start is selected as the program control mode start type, the set point (SP) is increased from the set point (SP) specified with "Set Point (SP) when Program Control Starts" to the set point (SP) of step 0 in 30 minutes.

For details about the program control mode start type, see "(23) Control Register+91: Program Control Mode Start Type" on page 6-42.

(3) Control Register+182: Wait Value

During the program control running, when a step is finished, the PID module checks whether the deviation between the process variable (PV) and set point (SP) is less than or equal to the wait value. The program control is not proceeded to the next step until the deviation becomes less than or equal to the wait value.

The wait function does not work and the program control is proceeded to the next step if the process variable (PV) satisfies the following condition:

$$\text{Set Point (SP)} - \text{Wait Value} \leq \text{Process Variable (PV)} \leq \text{Set Point (SP)} + \text{Wait Value}$$

Example 1: Wait function when the temperature is rising

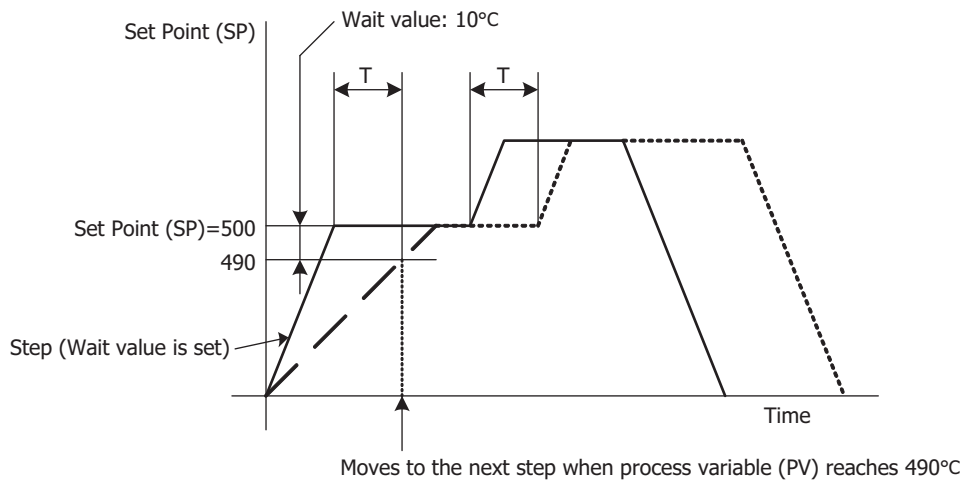

Example 2: Wait function when the temperature is falling

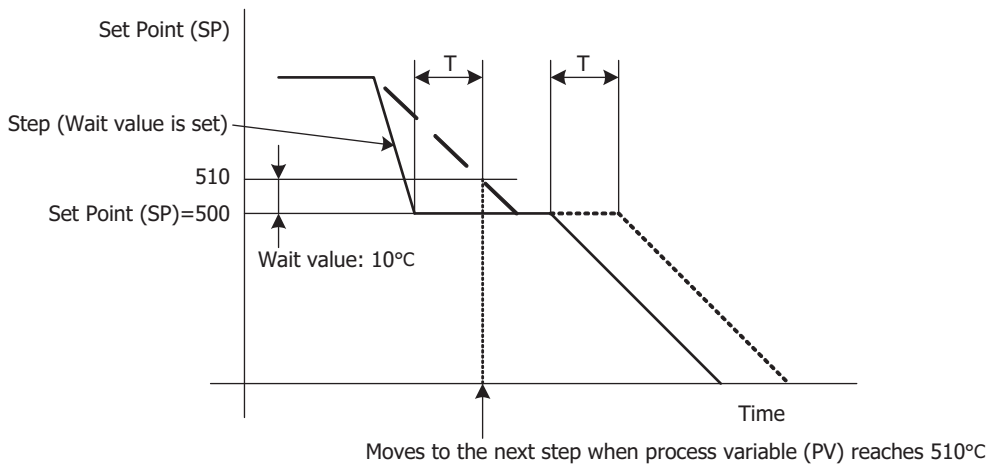

- : Program pattern
- - - - - : Process variable (PV)
- : Program pattern delayed by T due to the wait function

How to Cancel Wait Function

The wait function can be cancelled for the program control to proceed to the next step by turning on the advance next step bit, which is the bit 6 of the operation parameter.

(4) Control Register+183: Proportional Term

This function determines the range to perform the proportional action. The output of the proportional action varies in proportion to the deviation between the set point (SP) and the process variable (PV). It configures the setting for proportional band or proportional gain that was selected as the proportional term. When the heating/cooling control is enabled, this parameter becomes the heating proportional band. The control action will be ON/OFF control when the proportional band/proportional gain is 0.

If the proportional band is broadened (proportional gain is made smaller), the control output starts turning on or off at the significantly low temperatures from the set point (SP), overshoot or hunting is reduced; however, it takes time for the process variable (PV) to reach the set point (SP), and offset between the process variable (PV) and the set point (SP) is broadened.

If the proportional band is narrowed (proportional gain is made larger), the control output starts turning on or off at around the set point (SP), the time until the process variable (PV) reaches the set point (SP) is shortened, and the offset is small; however, the hunting phenomenon is frequent. If the proportional band is greatly narrowed, the control action becomes similar to the ON/OFF control action.

An appropriate proportional band/proportional gain for the control target can be automatically calculated using auto-tuning (AT) function. It is unnecessary to configure the proportional band/proportional gain in the WindLDR when using the auto-tuning (AT) function.

(5) Control Register+184: Integral Time

Integral time is a factor that determines the manipulated variable by the integral action. In the proportional control action, the offset is generated even when the control is stabilized. The integral action corrects the offset. The integral action is disabled when the integral time is 0.

If the integral time is shortened too much, the integral action becomes strong. The offset can be corrected in a shorter time; however, the hunting phenomenon may be caused over a long cycle. On the contrary, if the integral time is extended too much, the integral action becomes weak and it takes time to correct the offset.

An appropriate integral time for the control target can be automatically calculated using auto-tuning (AT) function. It is unnecessary to configure the integral time in the WindLDR when using the auto-tuning (AT) function.

(6) Control Register+185: Derivative Time

Derivative time is a factor that determines the manipulated variable by the derivative action. When the set point (SP) is changed or when the deviation between the set point (SP) and the process variable (PV) is increased due to a disturbance, the derivative action increases the output manipulated variable (MV) to rapidly correct the deviation between the process variable (PV) and the set point (SP). The derivative time is a coefficient to determine the output manipulated variable (MV) of the derivative action. The derivative action is disabled when the derivative time is 0.

If the derivative time is shortened, the derivative action becomes weak. The response to the rapid temperature change becomes slower. Because the action to suppress the rapid temperature rise becomes weaker, the time for the process variable (PV) to reach the set point (SP) is shortened; however, overshoot can occur.

If the derivative time is extended, the derivative action becomes strong. The response to the rapid temperature change becomes faster. Because the action to suppress the rapid temperature rise becomes strong, the time for the process variable (PV) to reach the set point (SP) is extended; however, overshoot can be decreased.

An appropriate derivative time for the control target can be automatically calculated using auto-tuning (AT) function. It is unnecessary to configure the derivative time in the WindLDR when using the auto-tuning (AT) function.

(7) Control Register+186: ARW (Anti-Reset Windup)

When the control is started, there is a large deviation between the set point (SP) and the process variable (PV). The integral action continues its action in a given direction until the process variable (PV) reaches the set point (SP). As a result, an overshoot is caused by the excessive integral action. ARW suppresses the overshoot by limiting the integral action area. ARW (anti-reset windup) is a function to prevent this overshooting.

When ARW is 0%, the integral action area becomes the minimum and the suppression of the overshoot is maximized. When ARW is 50%, the integral action area becomes the intermediate and the suppression of the overshoot is intermediate. When ARW is 100%, the integral action area becomes the maximum and the suppression of the overshoot is minimized.

An appropriate ARW for the control target can be automatically calculated using auto-tuning (AT) function. It is unnecessary to configure the ARW in the WindLDR when using the auto-tuning (AT) function.

(8) Control Register+187: Output Manipulated Variable Rate-of-Change

The output manipulated variable rate-of-change is the rate that the output manipulated variable changes in one second. This function is disabled when the value is 0.

In the case of heating control, when there is a large deviation between the process variable (PV) and the set point (SP), the output immediately changes from off to on as shown in the diagram below (Normal Output). By configuring the output manipulated variable rate-of-change, the maximum change of the output manipulated variable (MV) in 1 minute can be changed as shown in the diagram below (Output When Output Manipulated Variable Rate-of-Change is Configured).

This function can be used for a high temperature heater (used at approximately 1,500 to 1,800°C) which has to be heated gradually, as the heater can be burnt out if the power is supplied rapidly.

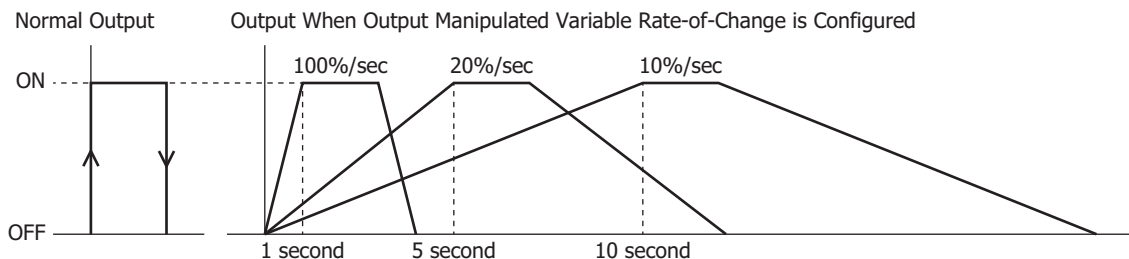

(9) Control Register+188: Alarm 1 Value

(10) Control Register+189: Alarm 2 Value

(11) Control Register+190: Alarm 3 Value

(12) Control Register+191: Alarm 4 Value

(13) Control Register+192: Alarm 5 Value

(14) Control Register+193: Alarm 6 Value

(15) Control Register+194: Alarm 7 Value

(16) Control Register+195: Alarm 8 Value

The alarm value is the value that the PID module compares with the process variable (PV) as the point to perform the alarm action. There are two types of alarms: Deviation alarm and process alarm. A deviation alarm is a way of specifying the alarm value, and it sets a value that is the deviation from the PID module set point (SP) as the alarm value.

A process alarm is a way of specifying the alarm value, and it sets a temperature to perform the alarm action as the alarm value, regardless of the PID module set point (SP).

	Alarm Type	Alarm Value	Alarm Action
Deviation Alarm	Upper/Lower limit range alarm	Deviation from the set point (SP) is the alarm value.	The alarm output turns off if the process variable (PV) exceeds the range.
	Upper limit alarm, Lower limit alarm, Upper/Lower limits alarm, Upper limit alarm with standby, Lower limit alarm with standby, Upper/Lower limits alarm with standby		The alarm output turns on if the process variable (PV) exceeds the range.
Process Alarm	Process high alarm Process low alarm	The alarm action point is the alarm value.	The alarm output turns on if the process variable (PV) exceeds the alarm value.

When the alarm value is 0, the alarm action is disabled except process high alarm and process low alarm.

(17) Control Register+197: Output Manipulated Variable Upper Limit

The output manipulated variable upper limit is the upper limit value for the output manipulated variable (MV). The output manipulated variable upper limit is used to suppress the output manipulated variable (MV).

Example: When the output manipulated variable (MV) upper limit is 80%, the control output will be 80% even when the output manipulated variable (MV) reaches 100%.

(18) Control Register+19: Output Manipulated Variable Lower Limit

The output manipulated variable lower limit is the lower limit value for the output manipulated variable (MV).

Example: When the output manipulated variable (MV) lower limit is 20%, the control output will be 20% even when the output manipulated variable (MV) is 0%.

6: CONFIGURING PID MODULE USING WINDLDR

(19) Control Register+199: Cooling Proportional Band

The cooling proportional band is the proportional band for cooling when heating/cooling control is enabled. The cooling proportional band is the multiplication of the heating proportional band.

Example: When the heating proportional band is 10°C and the cooling proportional band is 2.0, the cooling proportional band will be 20°C. If cooling proportional band value is 0.5, the cooling proportional band will be 5°C.

If the cooling proportional band is 0, the cooling side control will be ON/OFF control action. If the heating proportional band is 0, both heating and cooling side controls will be ON/OFF control action.

(20) Control Register+200: Overlap/Dead Band

When heating/cooling control is enabled, overlap is the region where both the heating and cooling outputs turn on at the same time around the set point (SP), and dead band is the region where neither output turns on. When the configured value is bigger than 0, the value is used as the dead band. When the configured value is less than 0, the value is used as overlap band.

When the overlap band is configured, the area in which both heating and cooling control outputs are turned on is generated, and the energy loss is caused. However, the overlap helps enhance the control accuracy and accelerate the response.

When the dead band is configured, the area in which neither heating nor cooling control outputs are turned on is generated. In the dead band, the control accuracy and responsiveness is lowered; however, the energy loss can be suppressed.

Overlap Band Action

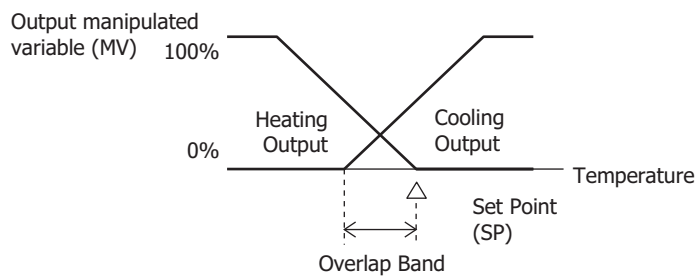

Dead Band Action

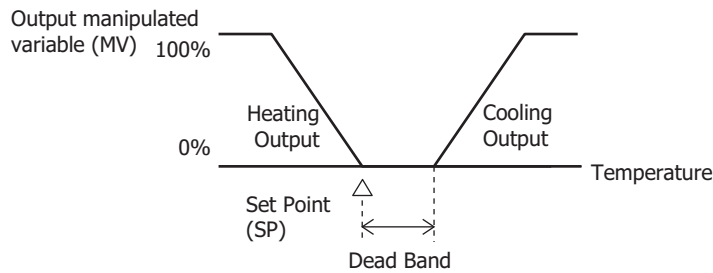

This section describes details about the monitor screen used to monitor the PID module.

Monitoring PID Module

The PID Module status can be monitored on the monitoring screen. Click on Monitor tab in the PID Module Configuration dialog box to open the monitoring screen

Monitoring Screen

When external PV mode is disabled

To start monitoring the PID module, click on **Monitor** button in the PID Module Configuration dialog box.

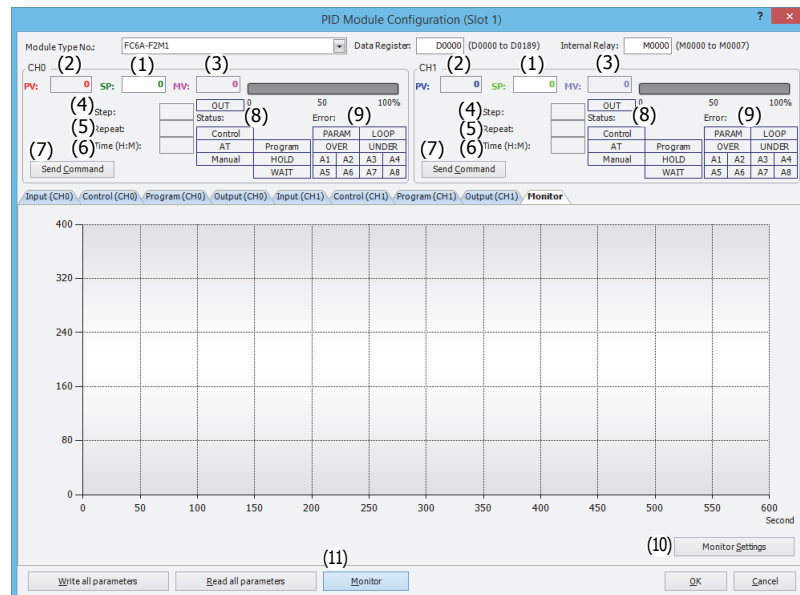

When external PV mode is enabled

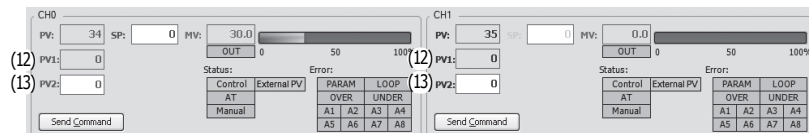

(1) CH0/CH1 SP (Set Point)

The set point (SP) of CH0 control or CH1 control is indicated. During the monitoring, set point (SP) of CH0 control or CH1 control can be changed.

(2) CH0/CH1 PV (Process Variable)

The process variable (PV) of CH0 control or CH1 control is indicated.

(3) CH0/CH1 MV (Output Manipulated Variable)

The output manipulated variable (MV) of CH0 control or CH1 control is indicated. The bar graph on the right is also updated according to the output manipulated variable (MV). While the output is on, the OUT indicator turns green.

While CH0 control or CH1 control is in manual mode, output manipulated variable can be changed.

6: CONFIGURING PID MODULE USING WINDLDR

(4) CH0/CH1 Step

The current step number (0 to 9) is indicated when CH0 control or CH1 control is in program control mode.

(5) CH0/CH1 Repeat

The remaining repeat number is indicated when CH0 control or CH1 control is in program control mode.

(6) CH0/CH1 Time

The remaining time in the current step is indicated when CH0 control or CH1 control is in program control mode.

(7) CH0/CH1 Send Command

When a menu is selected, a command to control the PID module is sent.

Control:	Enable/Disable the control to the PID module.
AT/Auto-reset:	Perform auto-tuning (AT)/auto-reset or cancel auto-tuning (AT).
Manual Mode:	Enable manual/auto mode.
External SP Input (CH0 only):	Enable/Disable the external SP input.
Program Control:	Run/Stop the program control, advance next/previous step, or hold/run the program control.
External PV Mode:	Enable/Disable the external PV mode.

(8) CH0/CH1 Status Indicators

Control:	Turns green while the control of CH0/CH1 is enabled
AT:	Turns green while auto-tuning (AT) is performed for CH0/CH1.
Manual:	Turns green while CH0/CH1 is in the manual control.
External SP (CH0 only):	Turns green while the external SP input is enabled.
Program (Program control only):	Turns green while CH0/CH1 is in program control mode.
HOLD (Program control only):	Turns green while the program control of CH0/CH1 is held.
WAIT (Program control only):	Turns green while the program wait is functioning for CH0/CH1.
External PV:	Turns green while the external PV mode is enabled.

(9) CH0/CH1 Error Indicators

PARAM:	Turns red while parameter range error is occurring.
LOOP:	Turns red while loop break alarm is turned on.
UP:	Turns red while the input is over range.
DOWN:	Turns red while the input is under range.
A1 to A8:	Turns red while the corresponding alarm is turned on.

(10) Monitor Settings

Click on Monitor Settings button to open the PID Module Monitor Settings dialog box.

(11) Monitor

Click on Monitor button to start monitoring and tracing the PID module.

(12) CH0/CH1 Current Process Variable with Decimal Point (PV1)

The current process variable with decimal point (PV1) for CH0 control and CH1 control is indicated when external PV mode (CH0/CH1) is enabled.

(13) CH0/CH1 External PV Mode Process Variable (PV2)

The external PV mode process variable (PV2) for CH0 control and CH1 control is indicated when external PV mode (CH0/CH1) is enabled.

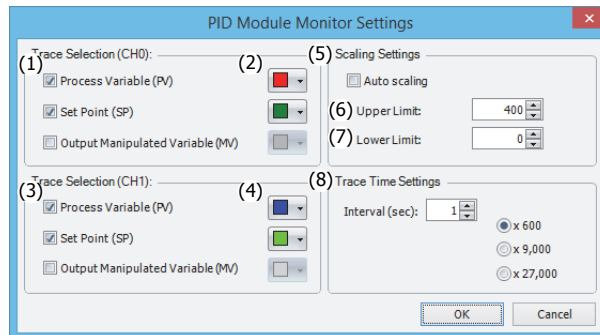
PID Module Monitor Settings dialog box**(1) CH0 Trace Color Selection**

Select the color for the three parameters to be traced.

(2) CH0 Trace Selection

Select the parameter to be traced. If none of the three parameters are selected, CH0 parameters are not traced and only parameters are monitored.

(3) CH1 Trace Color Selection

Select the color for the three parameters to be traced.

(4) CH1 Trace Selection

Select the parameter to be traced. If none of the three parameters are selected, CH1 parameters are not traced and only parameters are monitored.

(5) Auto Scaling

If the auto scaling is enabled, the range of the vertical axis is automatically updated in accordance with the process variable (PV), set point (SP) and output manipulated variable (MV).

(6) Upper Limit

The upper limit of the vertical axis for the trace can be specified.

(7) Lower Limit

The lower limit of the vertical axis for the trace can be specified.

(8) Trace Time Settings

Interval: Configure the interval time for the tracing between 1 to 60 seconds

×600: Interval × 600 = Trace range

Example: If the interval time is 1 sec, the trace range will be 600 sec. When the traced data reaches the right edge, the first half of the traced data is cleared, and the trace continues.

×9,000: Interval × 9,000 = Trace end time

Example: If the interval time is 1 sec, the trace end time will be 9,000 sec. The trace will be finished in 150 minutes.

×27,000: Interval × 27,000 = Trace end time

Example: If the interval time is 1 sec, the trace end time will be 27,000 sec. The trace will be finished in 450 minutes.

6: CONFIGURING PID MODULE USING WINDLDR

Monitoring Screen Example

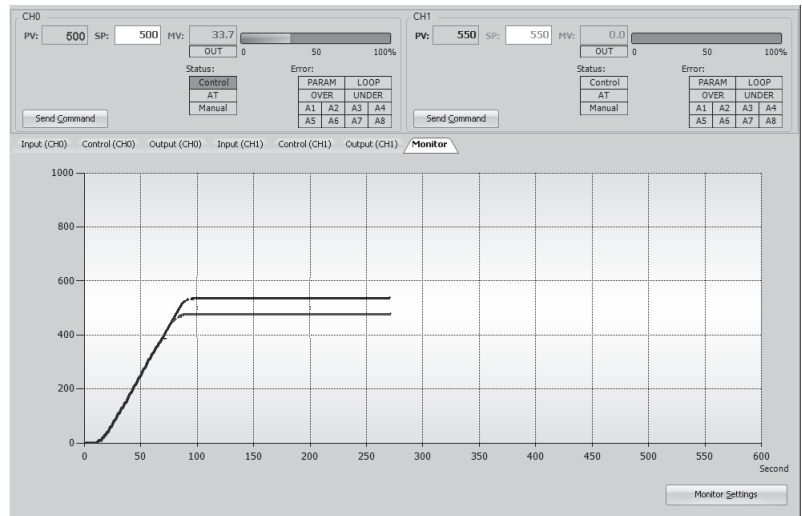

7: APPLICATION EXAMPLES

This chapter describes the PID modules application examples.

Application Example 1

This application example demonstrates the temperature control for a system using two electric furnaces. The set point (SP) of CH0 control is 200°C. The set point (SP) of CH1 control is 210°C.

- PID control is performed based on the temperature input to the PID module. The control output is turned on or off in accordance with the output manipulated variable (MV).
- PID parameters (proportional band/proportional gain, integral time, derivative time, and ARW) are automatically calculated using auto-tuning (AT).
- If the process variable (PV) of CH0 control becomes 205°C or higher, the upper limit alarm output (Q0) is turned on and the control is disabled.
- If the process variable (PV) of CH1 control becomes 215°C or higher, the upper limit alarm output (Q1) is turned on and the control is disabled.

System Configuration and Wiring

Wiring Example of the FC6A-F2M1 [Non-contact voltage output (for SSR drive)/current output type]

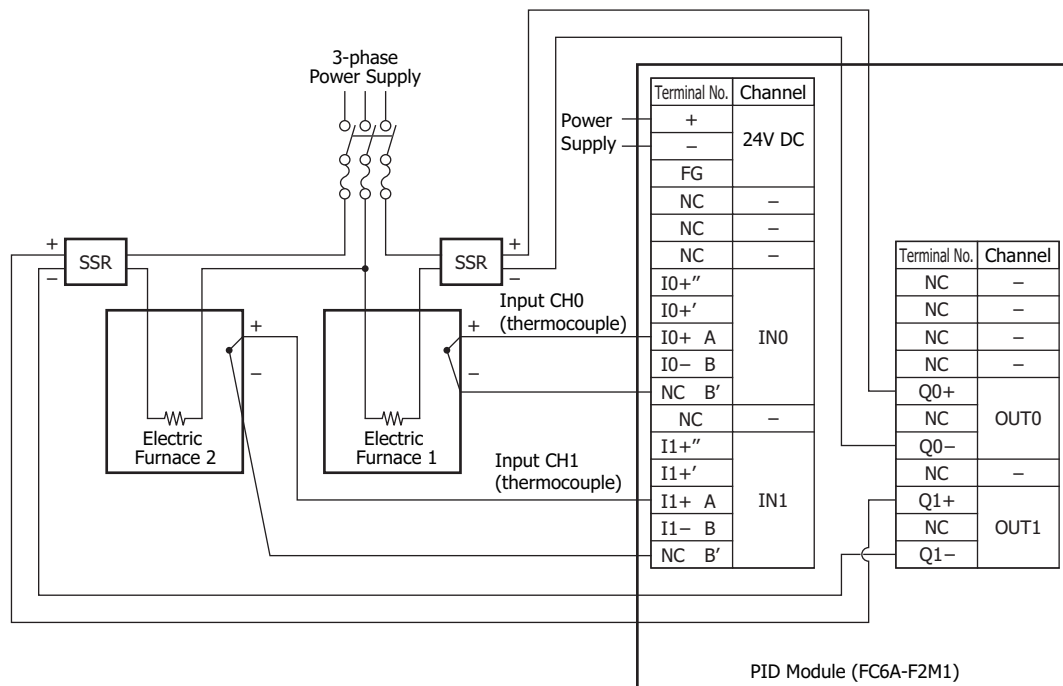

PID Module Parameter Configuration

The PID module parameters can be configured in the Module Configuration Editor and the **PID Module Configuration** dialog box. The procedure to configure the PID module is described below.

Parameter Configuration Example

Quantity of Modules: 1 unit
 Slot Number: Slot 1
 Module Type No.: FC6A-F2M1
 Data Register: D1000
 Internal Relay: M1000
 I/O Function: Used as a 2-channel PID module

	CH0	CH1
Input	Type K thermocouple (-200 to +1,370)°C	Type K thermocouple (-200 to +1,370)°C
Output	Non-contact voltage output (for SSR drive)	Non-contact voltage output (for SSR drive)
Alarm 1 Type	Upper limit alarm	Upper limit alarm
Alarm 1 Value	5°C	5°C
Set Point (SP)	200°C	210°C
Control Action	PID control action [P, I, D and ARW are automatically calculated using auto-tuning (AT)]	PID control action [P, I, D and ARW are automatically calculated using auto-tuning (AT)]
AT Bias	20°C	20°C

Parameter Configuration Procedure

1. Module Configuration Editor

From the WindLDR menu bar, on the **Configuration** tab, in the **PLCs** group, click **Expansion Modules** to start the Module Configuration Editor.

Select the expansion module or cartridge to insert in the expansion modules and cartridges list and drag and drop it to the module configuration area.

Click **Configure** to open the **PID Module Configuration** dialog box.

Module Configuration Editor

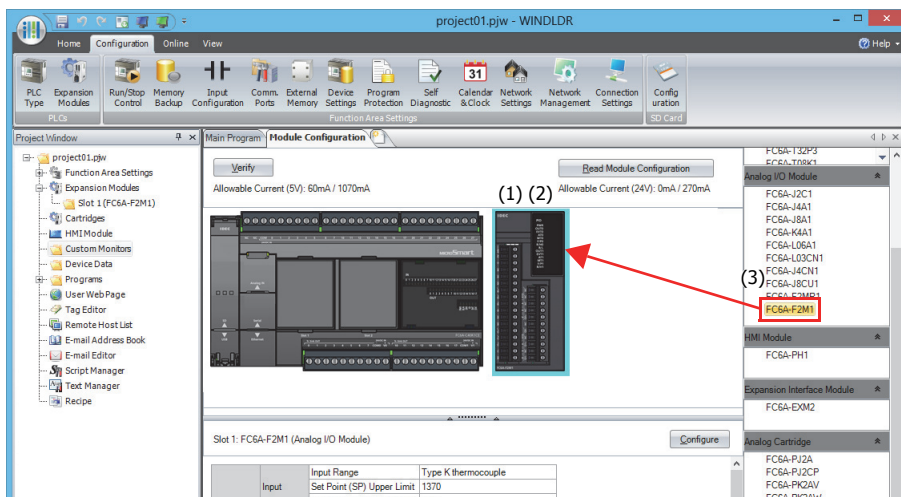

	Item	Setting
(1)	Quantity of Modules	1
(2)	Slot No.	Slot 1
(3)	Module Type No.	FC6A-F2M1

2. PID Module Configuration Dialog Box

Configure the control registers (data registers) and control relays (internal relays).

PID Module Configuration Dialog Box

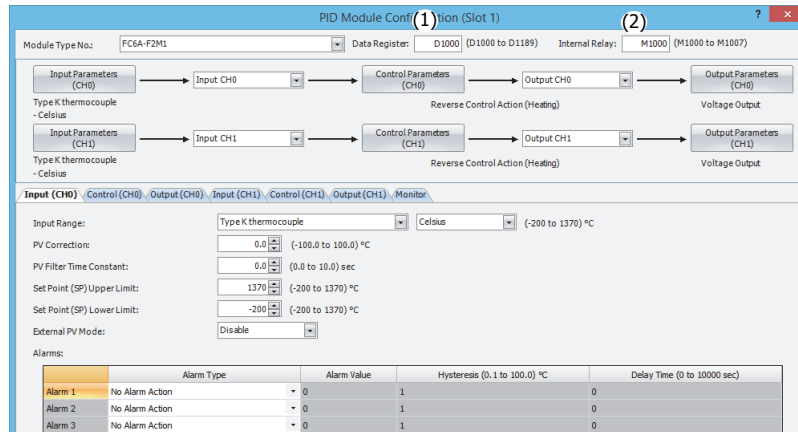

	Item	Setting
(1)	Data Register	D1000
(2)	Internal Relay	M1000

3. I/O Function Selection

Select I/O function for each channel in the **PID Module Configuration** dialog box.

PID Module Configuration Dialog Box (I/O Function Selection)

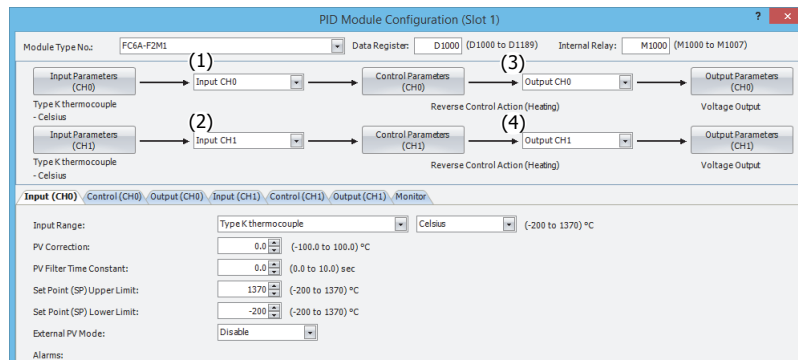

	Item	Setting
(1)	Input CH0 Function	Input CH0
(2)	Input CH1 Function	Input CH1
(3)	Output CH0 Function	Output CH0
(4)	Output CH1 Function	Output CH1

4. Input CH0 Parameters

Configure the Input CH0 parameters in the **PID Module Configuration** dialog box. To open Input CH0 Parameters in the **PID Module Configuration** dialog box, click on **Input Parameters (CH0)** button or **Input (CH0)** tab.

PID Module Configuration Dialog Box (Input CH0 Parameters)

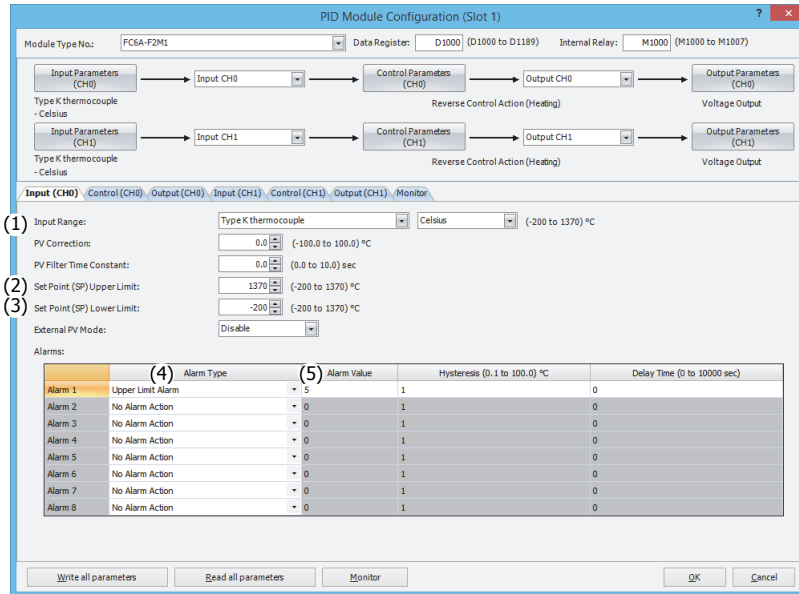

	Item	Setting
(1)	Input Range	Type K thermocouple, Celsius
(2)	Set Point (SP) Upper Limit	1,370°C
(3)	Set Point (SP) Lower Limit	-200°C
(4)	Alarm 1 Type	Upper limit alarm
(5)	Alarm 1 Value	5°C

5. Control CH0 Parameters

Configure the Control CH0 parameters in the **PID Module Configuration** dialog box. To open Control CH0 Parameters in the **PID Module Configuration** dialog box, click on **Control Parameters (CH0)** button or **Control (CH0)** tab.

PID Module Configuration Dialog Box (Control CH0 Parameters)

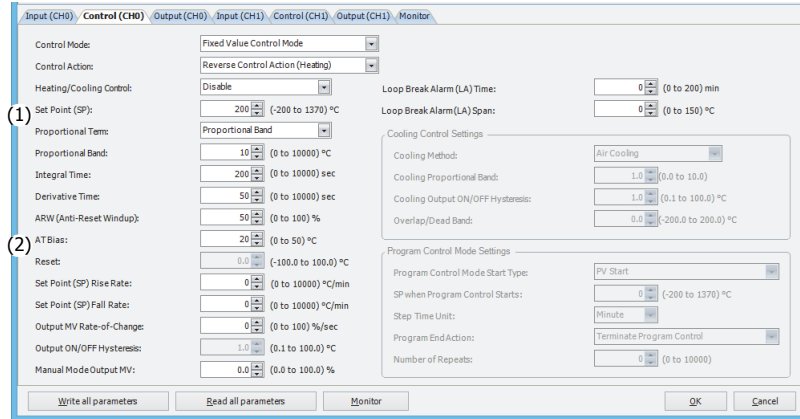

	Item	Setting
(1)	Set Point (SP)	200°C
(2)	AT Bias	20°C

6. Input CH1 Parameters

Configure the Input CH1 parameters in the **PID Module Configuration** dialog box. To open Input CH1 Parameters in the **PID Module Configuration** dialog box, click on **Input Parameters (CH1)** button or **Input (CH1)** tab.

PID Module Configuration Dialog Box (Input CH1 Parameters)

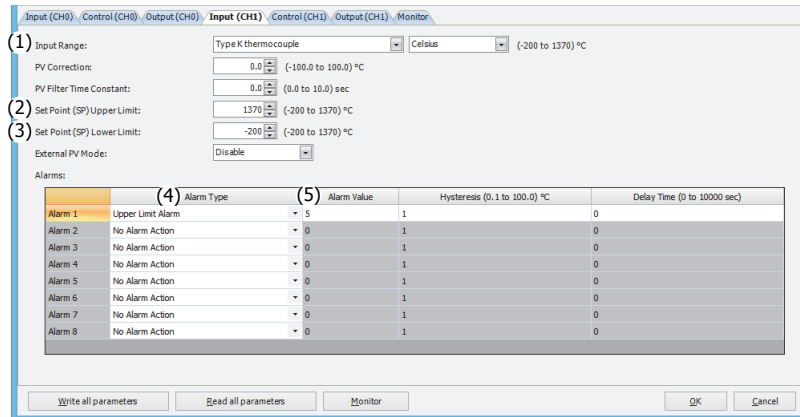

	Item	Setting
(1)	Input Range	Type K thermocouple, Celsius
(2)	Set Point (SP) Upper Limit	1,370°C
(3)	Set Point (SP) Lower Limit	-200°C
(4)	Alarm 1 Type	Upper limit alarm
(5)	Alarm 1 Value	5°C

7: APPLICATION EXAMPLES

7. Control CH1 Parameters Setting

Configure the Control CH1 parameters in the **PID Module Configuration** dialog box. To open Control CH1 Parameters in the **PID Module Configuration** dialog box, click on **Control Parameters (CH1)** button or the **Control (CH1)** tab.

PID Module Configuration Dialog Box (Control CH1 Parameters)

The screenshot shows the 'PID Module Configuration (Slot 1)' dialog box. At the top, it displays 'Module Type No.: FC6A-F2M1', 'Data Register: D1000 (D1000 to D1189)', and 'Internal Relay: M1000 (M1000 to M1007)'. Below this, there are two channels: CH0 and CH1. The 'Control (CH1)' tab is active, showing the following parameters:

- Control Mode: Fixed Value Control Mode
- Control Action: Reverse Control Action (Heating)
- Set Point (SP): 210 (-200 to 1370) °C
- Proportional Term: Proportional Band
- Proportional Band: 10 (0 to 10000) °C
- Integral Time: 200 (0 to 10000) sec
- Derivative Time: 50 (0 to 10000) sec
- ARW (Anti-Reset Windup): 50 (0 to 100) %
- AT Bias: 20 (0 to 50) °C
- Reset: 0.0 (-100.0 to 100.0) °C
- Set Point (SP) Rise Rate: 0 (0 to 10000) °C/min
- Set Point (SP) Fall Rate: 0 (0 to 10000) °C/min
- Output MV Rate-of-Change: 0 (0 to 100) %/sec
- Output ON/OFF Hysteresis: 1.0 (0.1 to 100.0) °C
- Manual Mode Output MV: 0.0 (0.0 to 100.0) %
- Loop Break Alarm (LA) Time: 0 (0 to 200) min
- Loop Break Alarm (LA) Span: 0 (0 to 150) °C
- Cascade Control Settings (External SP Input Min & Max Values):
 - Linear Conversion Maximum Value: 1370 (-200 to 1370) °C
 - Linear Conversion Minimum Value: -200 (-200 to 1370) °C
- Program Control Mode Settings:
 - Program Control Mode Start Type: PV Start
 - SP when Program Control Starts: 0 (-200 to 1370) °C
 - Step Time Unit: Minute
 - Program End Action: Terminate Program Control
 - Number of Repeats: 0 (0 to 10000)

Buttons at the bottom include 'Write all parameters', 'Read all parameters', 'Monitor', 'OK', and 'Cancel'.

	Item	Setting
(1)	Set Point (SP)	210°C
(2)	AT Bias	20°C

8. Saving Parameters

Click **OK** button to save the configured parameters.

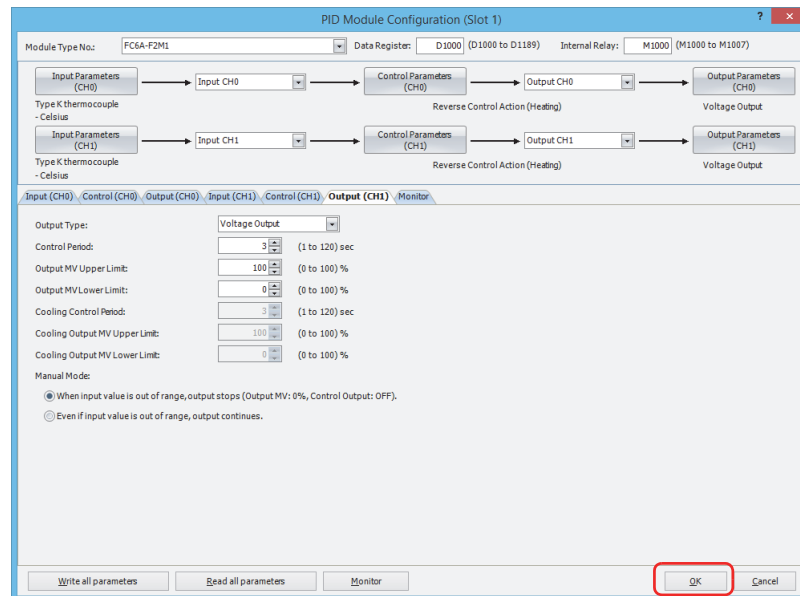

9. Ladder Programming

Create a ladder program to control the PID module.

Ladder Program Example

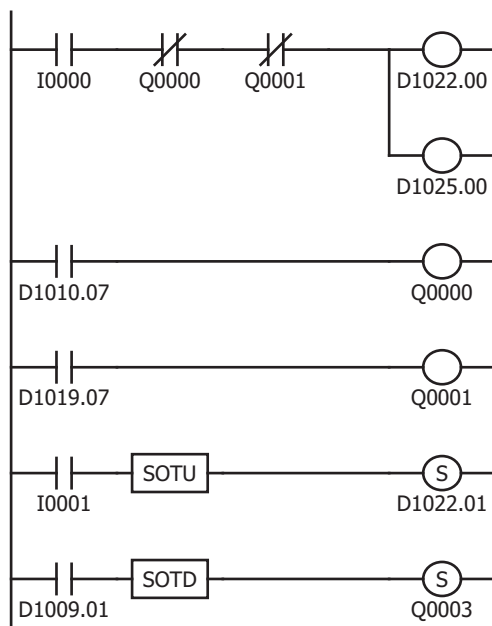

While external input I0 is on, the control of the PID module is enabled. When Q0 (CH0 control upper limit alarm output) is on or when Q1 (CH1 control upper limit alarm output) is on, the control of the PID module is disabled.

When the process variable (PV) of CH0 control exceeds 205°C, D1010.7 (Alarm 1 output) is turned on, which turns Q0 on.

When the process variable (PV) of CH1 control exceeds 215°C, D1019.7 (Alarm 1 output) is turned on, which turns Q1 on.

When external input I1 is turned on, D1022.1 [Auto-tuning (AT)/Auto-reset bit] is turned on. While D1022.1 is on, the PID module performs auto-tuning (AT) for CH0 control.

When the PID module completes auto-tuning (AT) for CH0, D1009.1 [Auto-tuning (AT)/Auto-reset monitor bit] is turned off. When D1009.1 is turned off, Q3 is turned on.

Notes:

- The temperature at which Auto-tuning (AT) is performed is determined by the set point (SP) and AT bias. In the above example, auto-tuning (AT) will be performed when the process variable (PV) reaches 180°C.
- The ladder program should be customized depending on actual applications.

10. User Program Download

From the WindLDR menu bar, select **Online > Transfer > Download** to open **Download** dialog box. Select the **Write PID module parameters after download** check box.

Click **OK** to download the user program to the CPU module.

After downloading the user program, the PID module parameters will be written to the data registers in the CPU module and the PID module.

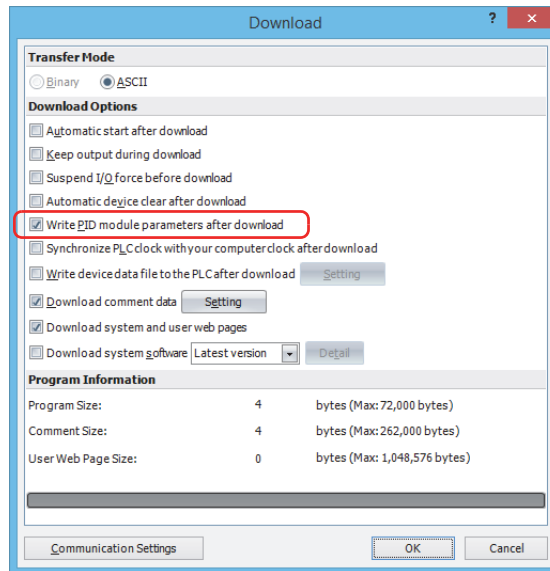

When program download is successfully completed, the following message will appear. Click **OK** button to close the message.

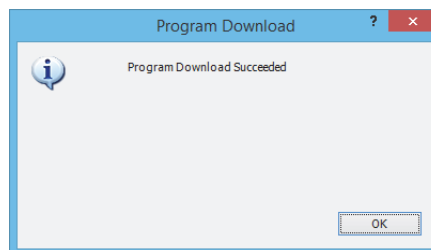

11. Starting Control

1. Confirm that 200 is stored in D1020 and 210 in D1023 of the CPU module.
2. Turn on the external input I0 to enable CH0 and CH1 controls.
3. Turn on the load circuit power.

The PID module starts the control action to keep the temperature of the control target at the set point (SP). Turn on I1 to perform the auto-tuning (AT) for CH0 control whenever necessary. For details, see "Perform Auto-tuning (AT)" on page 4-8.

Application Example 2

This application example demonstrates the program control for a system using two electric furnaces for ceramic industries.

- The PID module controls electric furnace 1 with CH0 control and electric furnace 2 with CH1 control using program control.
- PID control is performed based on the temperature input to the PID module and the program pattern below. The control output is turned on or off in accordance with the output manipulated variable (MV).
- The program pattern for the program control consists of the following 4 steps.
 - [Step 0]: Preheat process Step
0 is the process to gradually raise the set point (SP) to the preheat temperature (100°C) in 60 minutes to evaporate water in the specimen and electric furnace interior. When the elapsed time in step 0 is 60 minutes, if the process variable (PV) is less than 90°C, the PID module waits until the temperature reaches 90°C. When the temperature reaches 90°C, the PID module proceeds to the next step.
 - [Step 1]: Preheat process
Step 1 is the process to keep the preheat temperature (100°C) constant for 60 minutes.
 - [Step 2]: Firing process
Step 2 is the process to gradually raise the set point (SP) to the firing temperature (800°C) in 5 hours to prevent the specimen from being damaged by a rapid temperature rise. When the elapsed time in step 2 is 5 hours, if the process variable is less than 790°C, the PID module waits until the temperature reaches 790°C. When the temperature reaches 790°C, the PID module proceeds to the next step.
 - [Step 3]: Firing process
Step 3 is the process to keep the firing temperature (800°C) constant for 30 minutes.
- PID parameters (proportional band/proportional gain, integral time, derivative time, and ARW) of each step are automatically calculated using auto-tuning (AT).
- In CH0 control, if the process variable (PV) in step 1 becomes 110°C or higher or if the process variable (PV) in step 3 becomes 810°C or higher, the upper limit alarm output (Q0) is turned on and the control is disabled.
- In CH1 control, if the process variable (PV) in step 1 becomes 110°C or higher or if the process variable (PV) in step 3 becomes 810°C or higher, the upper limit alarm output (Q1) is turned on and the control is disabled.

System Configuration and Wiring

Wiring Example of the FC6A-F2MR1 [Relay output type]

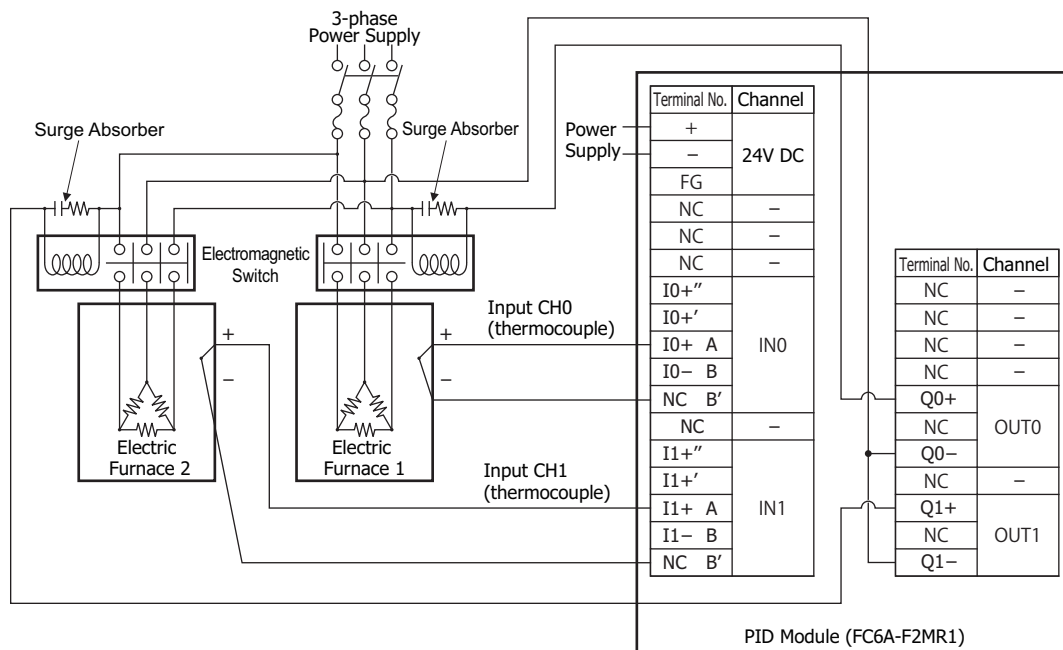

7: APPLICATION EXAMPLES

PID Module Parameter Configuration

The PID module parameters can be configured in the Module Configuration Editor and the **PID Module Configuration** dialog box. The procedure to configure the PID module is described below.

Parameter Configuration Example

Quantity of Modules: 1 unit
 Slot No.: Slot 1
 Module Type No.: FC6A-F2MR1
 Data Register: D1000
 Internal Relay: M1000
 I/O Function: Used as a 2-channel PID module

	CH0	CH1
Input	Type K thermocouple (-200 to +1,370)°C	Type K thermocouple (-200 to +1,370)°C
Output	Relay output	Relay output
Alarm 1 Type	Upper limit alarm	Upper limit alarm

Program Pattern: Settings are common between CH0 and CH1.

	Step 0	Step 1	Step 2	Step 3
Set Point (SP)	100°C	100°C	800°C	800°C
Step Time	60 minutes	60 minutes	300 minutes	30 minutes
Wait Value	10°C	0°C	10°C	0°C
Alarm 1 Value	0°C	10°C	0°C	10°C

Parameter Configuration Procedure

1. Module Configuration Editor

From the WindLDR menu bar, on the **Configuration** tab, in the **PLCs** group, click **Expansion Modules** to start the Module Configuration Editor.

Select the expansion module or cartridge to insert in the expansion modules and cartridges list and drag and drop it to the module configuration area.

Click **Configure** to open the **PID Module Configuration** dialog box.

Module Configuration Editor

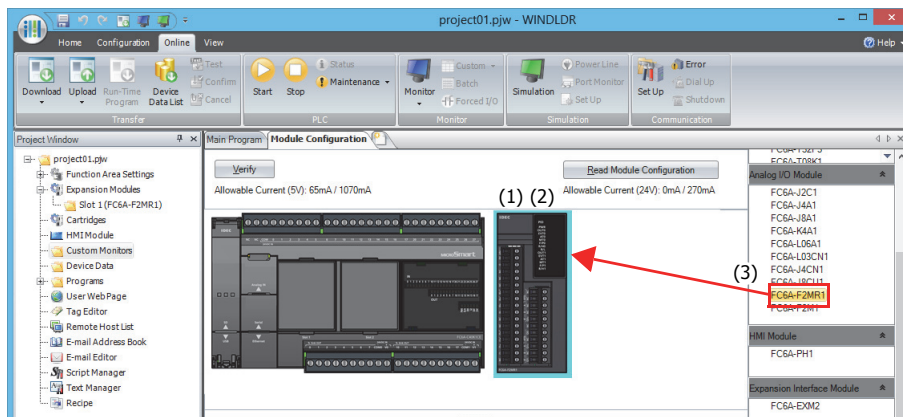

	Item	Setting
(1)	Quantity of Modules	1
(2)	Slot No.	Slot 1
(3)	Module Type No.	FC6A-F2MR1

2. PID Module Configuration Dialog Box

Configure the control registers (data registers) and control relays (internal relays).

PID Module Configuration Dialog Box

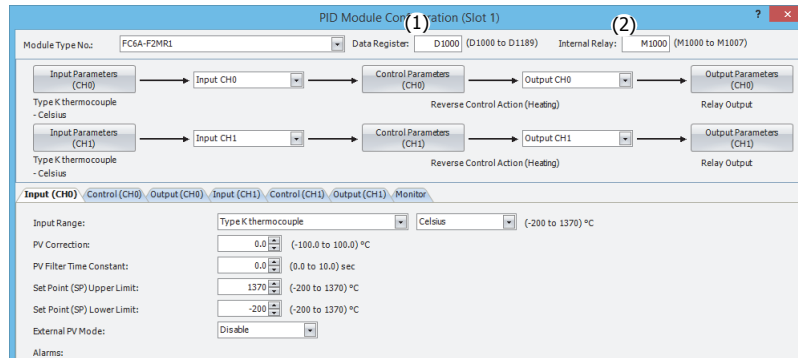

	Item	Setting
(1)	Data Register	D1000
(2)	Internal Relay	M1000

3. I/O Function Selection

Select I/O function for each channel in the **PID Module Configuration** dialog box.

PID Module Configuration Dialog Box (I/O Function Selection)

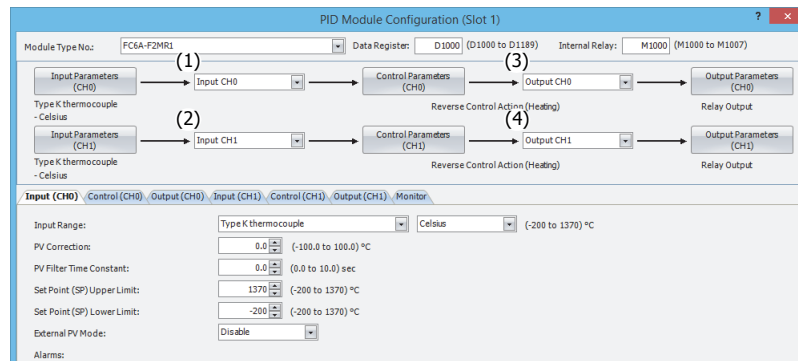

	Item	Setting
(1)	Input CH0 Function	Input CH0
(2)	Input CH1 Function	Input CH1
(3)	Output CH0 Function	Output CH0
(4)	Output CH1 Function	Output CH1

4. Input CH0 Parameters

Configure the Input CH0 parameters in the **PID Module Configuration** dialog box. To open Input CH0 Parameters in the **PID Module Configuration** dialog box, click on **Input Parameters (CH0)** button or **Input (CH0)** tab.

PID Module Configuration Dialog Box (Input CH0 Parameters)

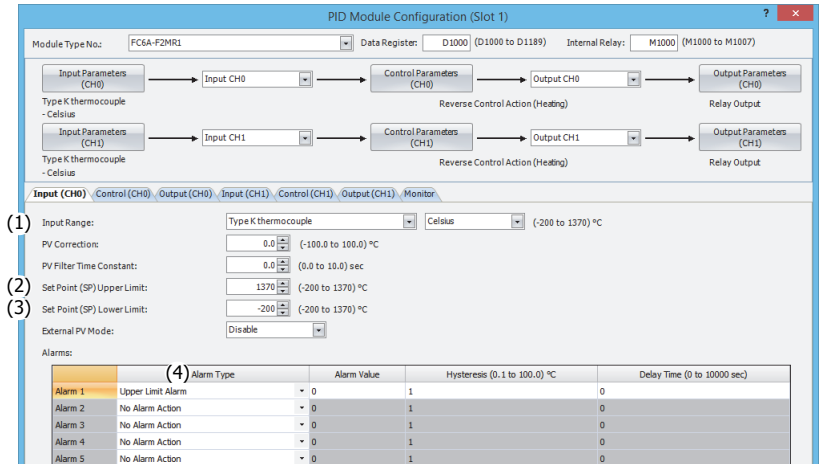

	Item	Setting
(1)	Input Range	Type K thermocouple, Celsius
(2)	Set Point (SP) Upper Limit	1,370°C
(3)	Set Point (SP) Lower Limit	-200°C
(4)	Alarm 1 Type	Upper limit alarm

5. Control CH0 Parameters

Configure the Control CH0 parameters in the **PID Module Configuration** dialog box. To open Control CH0 Parameters in the **PID Module Configuration** dialog box, click on **Control Parameters (CH0)** button or **Control (CH0)** tab.

PID Module Configuration Dialog Box (Control CH0 Parameters)

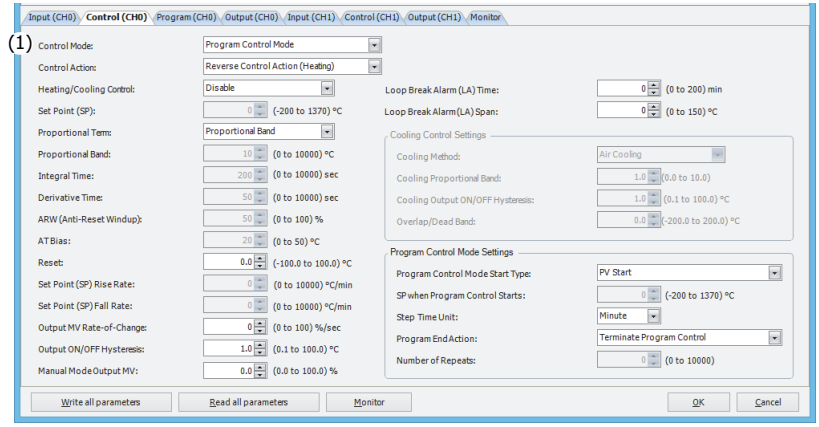

	Item	Setting
(1)	Control Mode	Program control mode

6. Program CH0 Parameters

Configure the Program CH0 parameters in the **PID Module Configuration** dialog box. To open Input CH1 Parameters in the **PID Module Configuration** dialog box, click on **Program (CH0)** tab.

PID Module Configuration Dialog Box (Program CH0 Parameters)

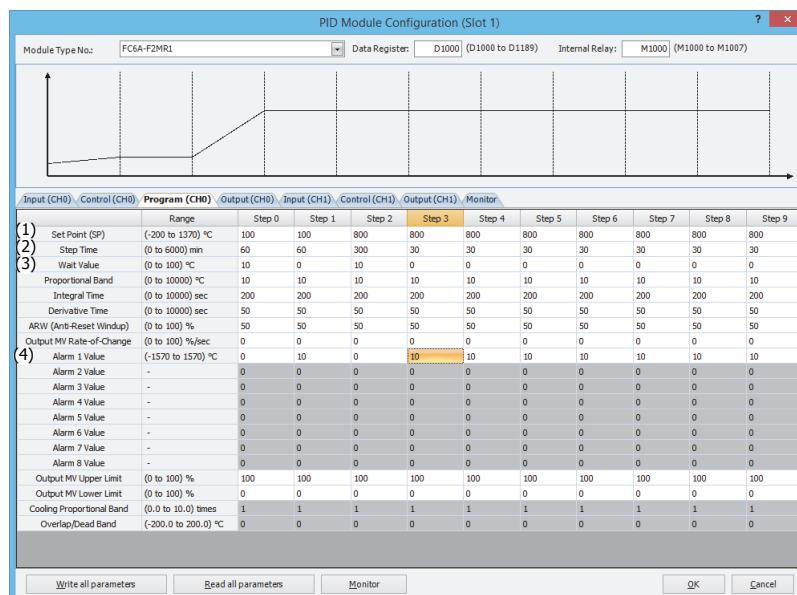

	Item	Setting			
		Step 0	Step 1	Step 2	Step 3 and Subsequent Steps
(1)	Set Point (SP)	100°C	100°C	800°C	800°C
(2)	Step Time	60 minutes	60 minutes	300 minutes	30 minutes
(3)	Wait Value	10°C	0°C	10°C	0°C
(4)	Alarm 1 Value	0°C	10°C	0°C	10°C

Notes:

- When the wait value is 0°C, the wait function is disabled.
- When the alarm value is 0°C, the alarm function is disabled.

7. CH1 Parameters Setting

Configure CH1 Parameters in the same way as CH0.

8. Saving Parameters

Click **OK** button to save the configured parameters.

9. Ladder Programming

Create a ladder program to control the PID module.

Ladder Program Example

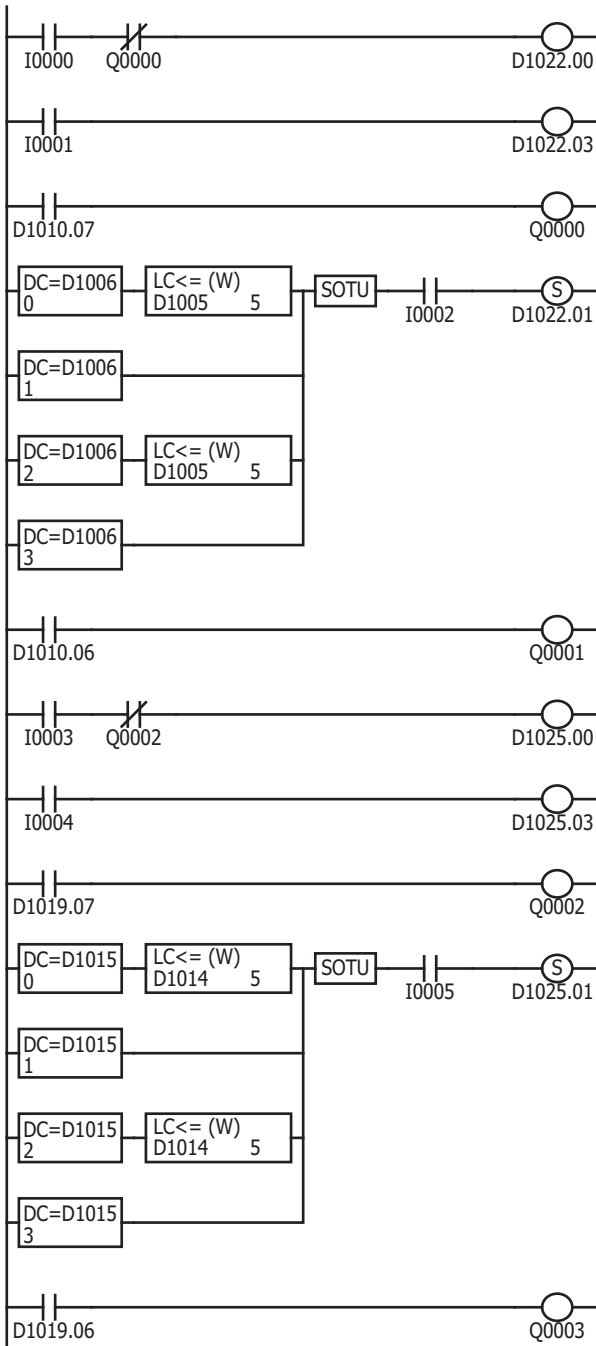

While external input I0 is on, CH0 control is enabled. When Q0 (CH0 control upper limit alarm output) is on, CH0 control is disabled.

When external input I1 is turned on, program control for CH0 control is started. When I1 is turned off, the program control is stopped.

When CH0 control alarm 1 is triggered, Q0 is turned on.

While external input I2 is on, auto-tuning (AT) is performed in each step of the program control as follows:

- Step 0: When the remaining time is 5 minutes
- Step 1: When step 1 is started
- Step 2: When the remaining time is 5 minutes
- Step 3: When step 3 is started

When program control for CH0 control is completed, Q1 is turned on.

While external input I3 is on, CH1 control is enabled. When Q2 (CH1 control upper limit alarm output) is on, CH1 control is disabled.

When external input I4 is turned on, CH1 program control is started. When I4 is turned off, the program control is stopped.

When CH1 alarm 1 is triggered, Q2 is turned on.

While external input I5 is on, auto-tuning (AT) is performed in each step of the program control as follows:

- Step 0: When the remaining time is 5 minutes
- Step 1: When step 1 is started
- Step 2: When the remaining time is 5 minutes
- Step 3: When step 3 is started

When CH1 program control is completed, Q3 is turned on.

Notes:

- The ladder program should be customized depending on actual applications.
- Perform the auto-tuning (AT) near the set point (SP). If auto-tuning (AT) is performed near the ambient temperature, temperature fluctuation cannot be given to the process. In such case, the auto-tuning (AT) may not finish normally.
- Once auto-tuning (AT) is performed, it is unnecessary to perform auto-tuning (AT) again as long as the process is unchanged.

10. User Program Download

From the WindLDR menu bar, select **Online > Transfer > Download** to open **Download** dialog box. Select the **Write PID module parameters after download** check box.

Click **OK** to download the user program to the CPU module.

After downloading the user program, the PID module parameters will be written to the data registers in the CPU module and the PID module.

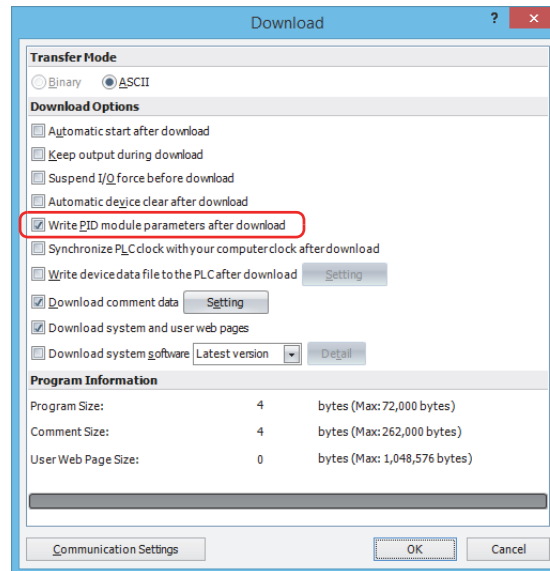

When program download is successfully completed, the following message will appear. Click **OK** button to close the message.

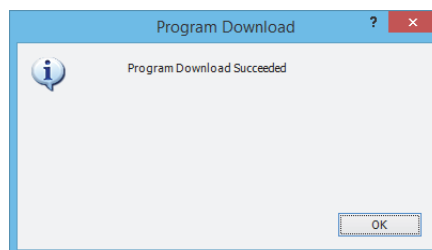

11. Starting Program Control

1. Turn on external input I0 and I3 to enable CH0 and CH1 controls.
2. Turn on external input I2 and I5 to allow auto-tuning (AT) to be performed.
3. Turn on external input I1 and I4 to start the program control for CH0 and CH1 controls.
4. Turn on the load circuit power.

The PID module starts the configured program control from step 0. Auto-tuning (AT) will be performed in each step. When the program control for CH0 control or CH1 control is completed, Q1 or Q3 will be turned on, respectively.

Application Example 3

This application example demonstrates the heating/cooling control for a system using an electric furnace. The set point (SP) of CH0 control is 200.0°C.

- PID control is performed based on the process variable (PV) of CH0 control. The heating output and cooling output is turned on or off in accordance with heating output manipulated variable (MV) and cooling output manipulated variable (MV).
- PID parameters (proportional band/proportional gain, integral time, derivative time, and ARW) are automatically calculated using auto-tuning (AT).
- If the process variable (PV) of CH0 control becomes out of the range between 194.5°C and 205.5°C, the upper/lower limits alarm output (Q0) is turned on and the control is disabled.

System Configuration and Wiring

Wiring Example of the FC6A-F2M1 [Non-contact voltage output (for SSR drive)/current output type]

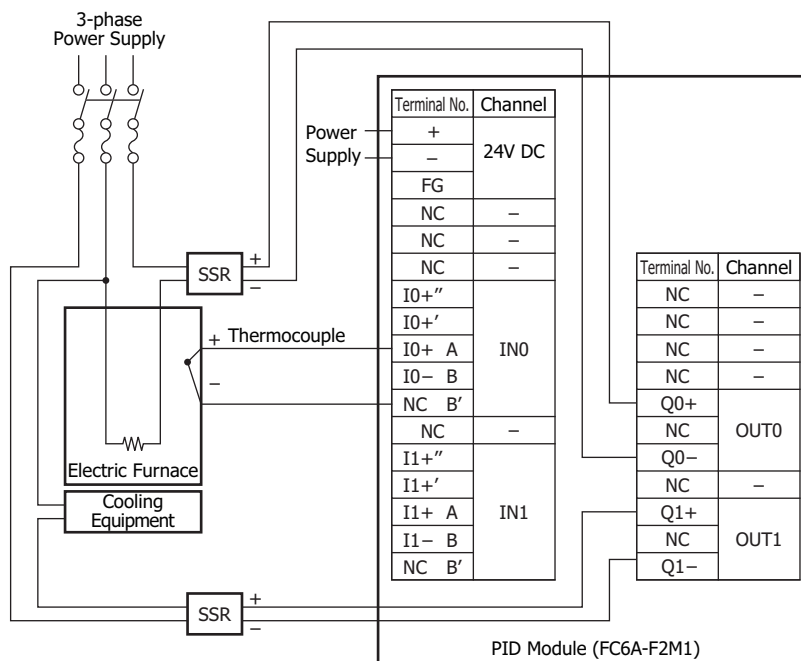

PID Module Parameter Configuration

The PID module parameters can be configured in the Module Configuration Editor and the **PID Module Configuration** dialog box. The procedure to configure the PID module is described below.

Parameter Configuration Example

Quantity of Modules: 1 unit
 Slot No.: Slot 1
 Module Type No.: FC6A-F2M1
 Data Register: D1000
 Internal Relay: M1000
 I/O Function: Used as a heating/cooling control PID module

	CH0	CH1
Input	Type K thermocouple with a decimal point (0.0 to 400.0)°C	–
Output	Non-contact voltage output (for SSR drive)	Non-contact voltage output (for SSR drive)
Alarm 1 Type	Upper/Lower limits alarm with standby	–
Alarm 1 Value	5.5°C	–
Set Point (SP)	200.0°C	–
Control Action	PID control action [P, I, D, and ARW are automatically calculated using auto-tuning (AT).]	–
AT Bias Value	20.0°C	–

Parameter Configuration Procedure

1. Module Configuration Editor

From the WindLDR menu bar, on the **Configuration** tab, in the **PLCs** group, click **Expansion Modules** to start the Module Configuration Editor.

Select the expansion module or cartridge to insert in the expansion modules and cartridges list and drag and drop it to the module configuration area.

Click **Configure** to open the **PID Module Configuration** dialog box.

Module Configuration Editor

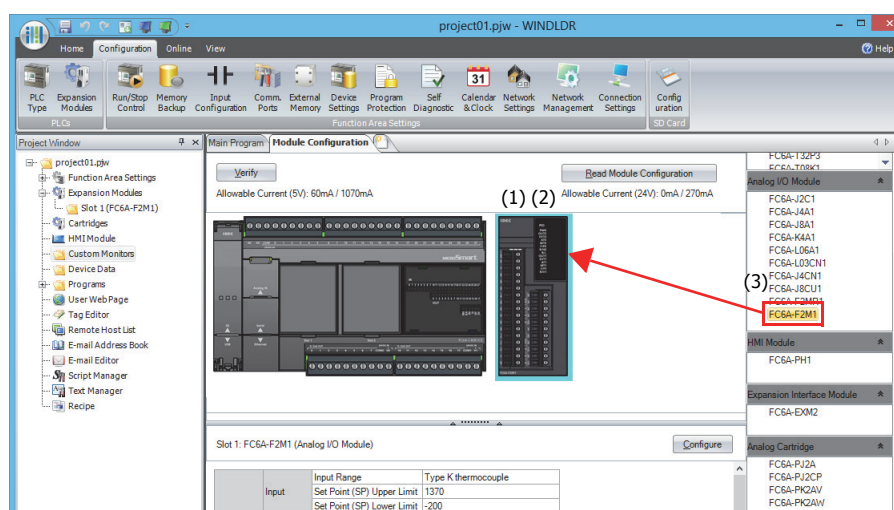

	Item	Setting
(1)	Quantity of Modules	1
(2)	Slot No.	Slot 1
(3)	Module Type No.	FC6A-F2M1

7: APPLICATION EXAMPLES

2. PID Module Configuration Dialog Box

Configure the control registers (data registers) and control relays (internal relays).

PID Module Configuration Dialog Box

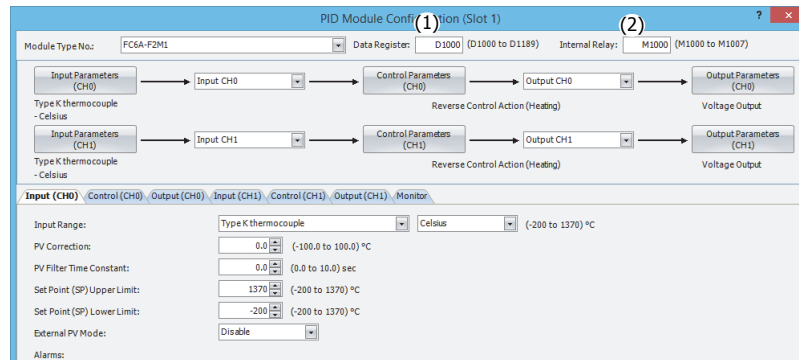

	Item	Setting
(1)	Data Register	D1000
(2)	Internal Relay	M1000

3. I/O Function Selection

Select I/O function for each channel in the **PID Module Configuration** dialog box.

PID Module Configuration Dialog Box (I/O Function Selection)

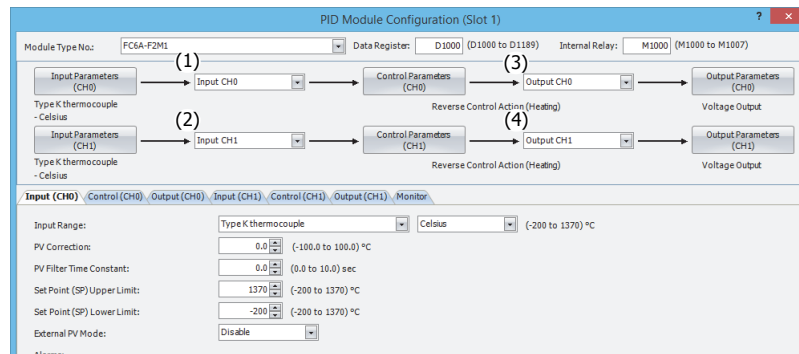

	Item	Setting
(1)	Input CH0 Function	Input CH0
(2)	Input CH1 Function	Input CH1
(3)	Output CH0 Function	Output CH0
(4)	Output CH1 Function	Output CH1

4. Input CH0 Parameters

Configure the Input CH0 parameters in the **PID Module Configuration** dialog box. To open Input CH0 Parameters in the **PID Module Configuration** dialog box, click on **Input Parameters (CH0)** button or **Input (CH0)** tab.

PID Module Configuration Dialog Box (Input CH0 Parameters)

The screenshot shows the 'PID Module Configuration (Slot 1)' dialog box. The 'Input Parameters (CH0)' tab is active. The 'Input Range' is set to 'Type K thermocouple with decimal point' and 'Celsius', with a range of '-200.0 to 400.0 °C'. The 'Set Point (SP) Upper Limit' is 400.0 °C and the 'Set Point (SP) Lower Limit' is 0.0 °C. The 'Alarm 1 Type' is 'Upper/Lower Limits Alarm with Standby' and the 'Alarm 1 Value' is 5.5 °C.

	Item	Setting
(1)	Input Range	Type K thermocouple with decimal point, Celsius
(2)	Set Point (SP) Upper Limit	400.0°C
(3)	Set Point (SP) Lower Limit	0.0°C
(4)	Alarm 1 Type	Upper/Lower limits alarm with standby
(5)	Alarm 1 Value	5.5°C

5. Control CH0 Parameters

Configure the Control CH0 parameters in the **PID Module Configuration** dialog box. To open Control CH0 Parameters in the **PID Module Configuration** dialog box, click on **Control Parameters (CH0)** button or **Control (CH0)** tab.

PID Module Configuration Dialog Box (Control CH0 Parameters)

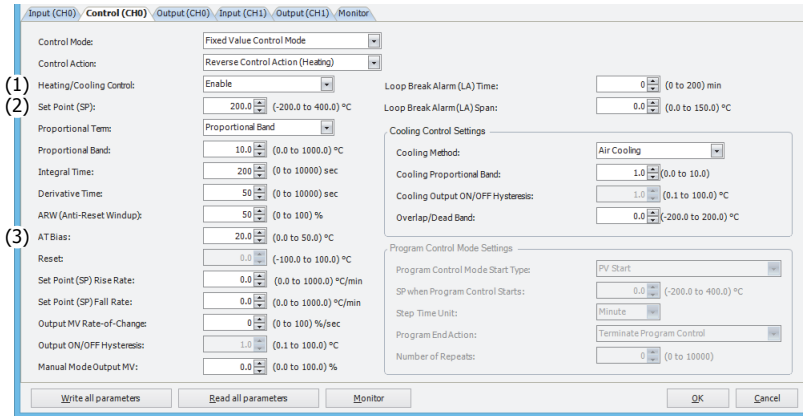

	Item	Setting
(1)	Heating/Cooling Control	Enable
(2)	Set Point (SP)	200.0°C
(3)	AT Bias	20.0°C

6. Saving Parameters

Click **OK** button to save the configured parameters.

7. Ladder Programming

Create a ladder program for heating/cooling control of the PID module.

Ladder Program Example

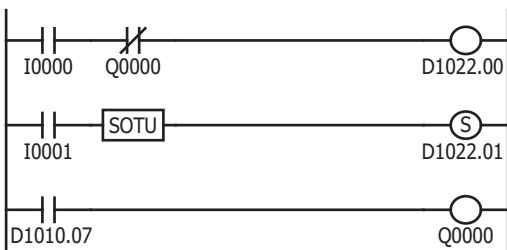

While external input I0 is on, CH0 control is enabled. When Q0 (CH0 control upper/lower limits alarm output) is on, CH0 control is disabled.

When external input I1 is turned on, D1022.1 [auto-tuning (AT) perform bit] is turned on. When the process variable (PV) reaches 180.0°C, auto-tuning (AT) is performed.

When the process variable (PV) is out of the range between 194.5°C and 205.5°C, D1010.7 (Alarm 1 output) is turned on, which turns Q0 on.

Notes:

- The temperature at which Auto-tuning (AT) is performed is determined by the set point (SP) and AT bias. In the above example, auto-tuning (AT) will be performed when the process variable (PV) reaches 180.0°C
- When upper/lower limits alarm with standby is selected as the alarm type, the alarm is not activated until the process variable (PV) enters the alarm output OFF range (194.5°C to 205.5°C). Once the process variable (PV) enters the alarm output OFF range, the standby is cancelled and the alarm is activated.
- The ladder program should be customized depending on actual applications.

8. User Program Download

From the WindLDR menu bar, select **Online > Transfer > Download** to open **Download** dialog box. Select the **Write PID module parameters after download** check box.

Click **OK** to download the user program to the CPU module.

After downloading the user program, the PID module parameters will be written to the data registers in the CPU module and the PID module.

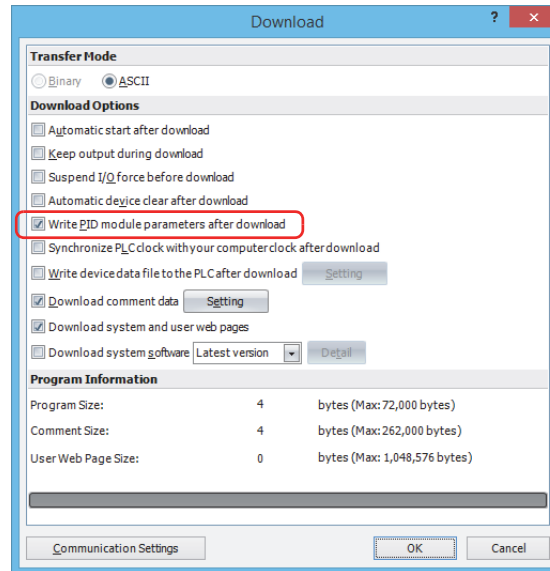

When program download is successfully completed, the following message will appear. Click **OK** button to close the message.

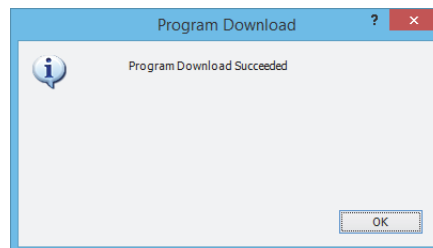

9. Starting Heating/Cooling Control

1. Confirm that 2000 is stored in D1020 of CPU module.
2. Turn on the external input I0 to enable CH0 control.
3. Turn on the load circuit power.

The PID module starts the heating/cooling control action to keep the temperature of the control target at the set point (SP). Turn on I1 to perform the auto-tuning (AT) for CH0 control whenever necessary. For details, see "Perform Auto-tuning (AT)" on page 4-8.

8: TROUBLESHOOTING

This chapter describes the countermeasures when any errors or problems occur while operating the PID module. If any problem occurs, take actions described in the flowchart corresponding to the problem.

Countermeasures for Errors and Problems

The PID Module Power LED (PWR) is OFF or Flashing.

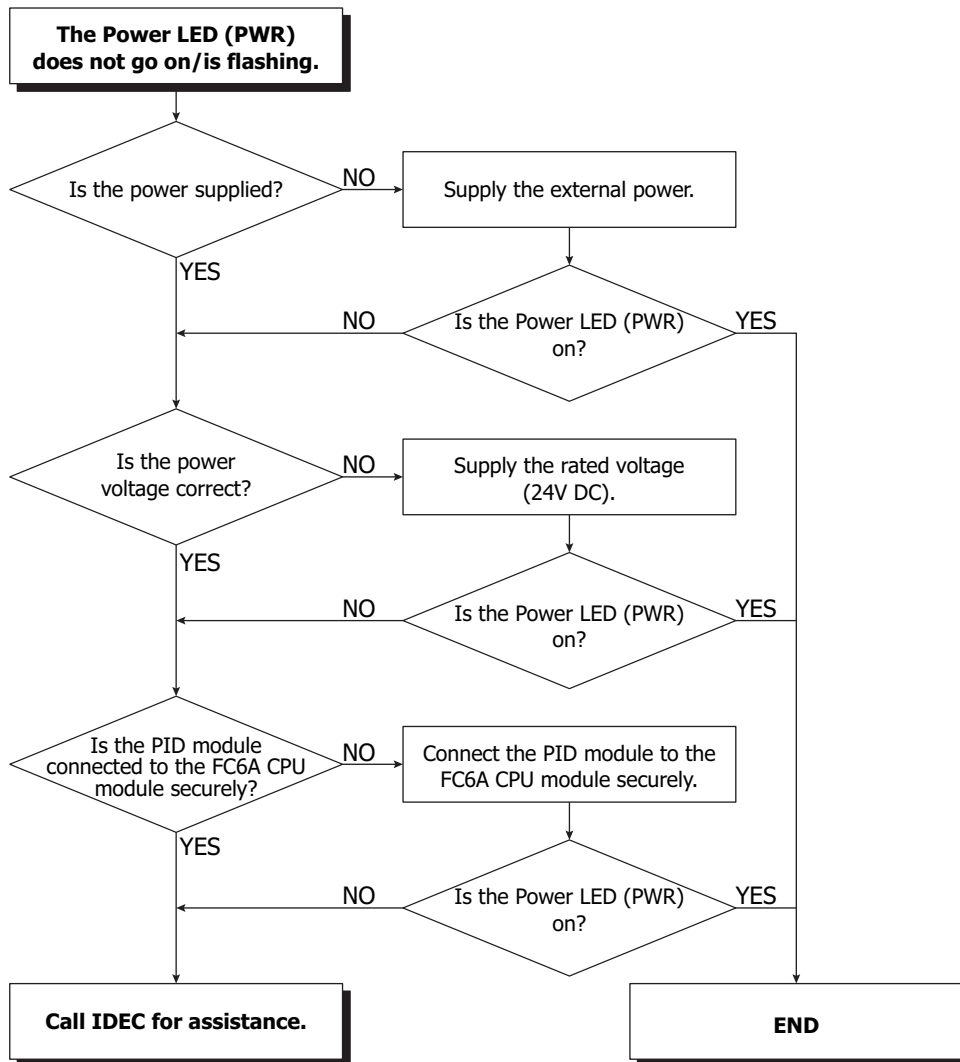

The PID Module output does not operate normally.

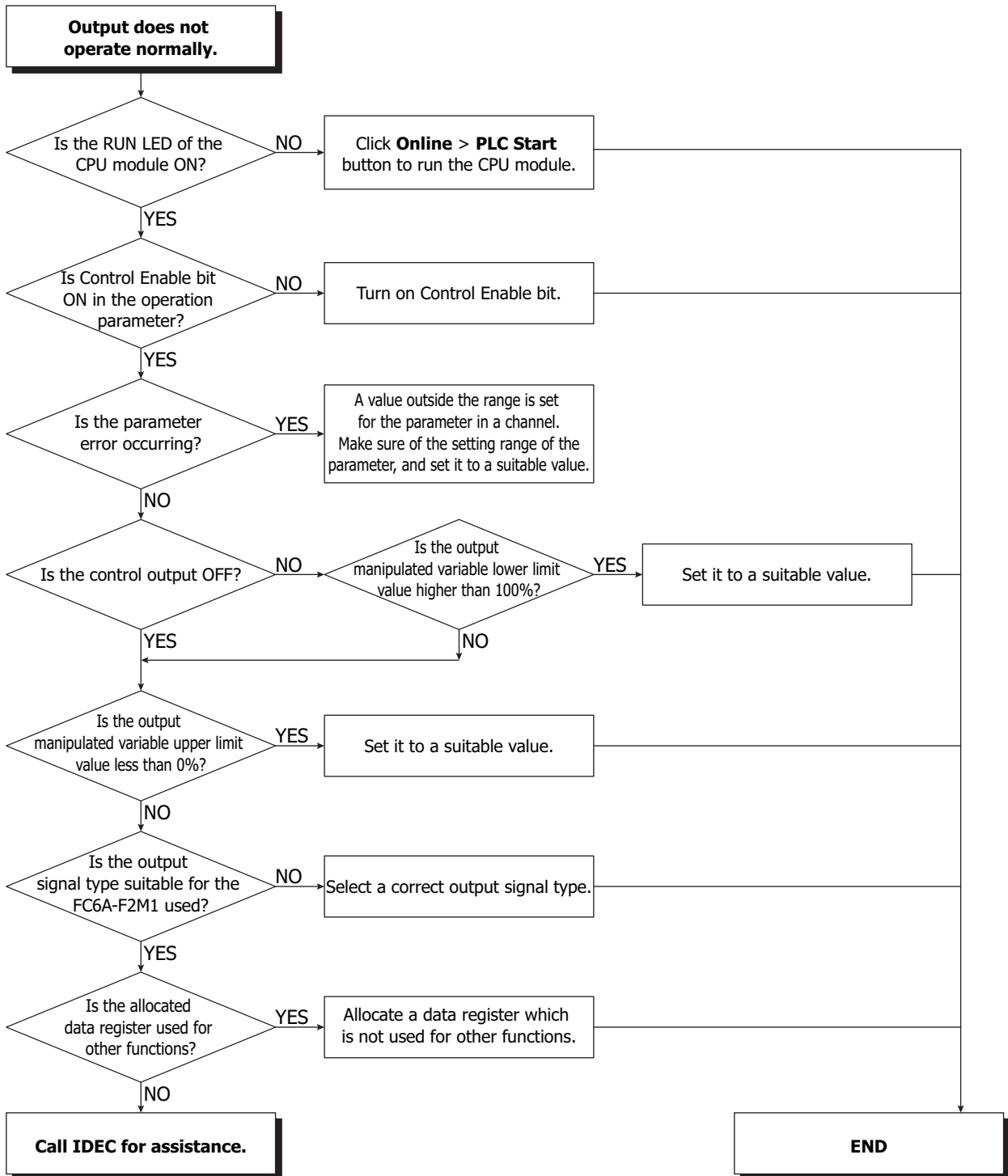

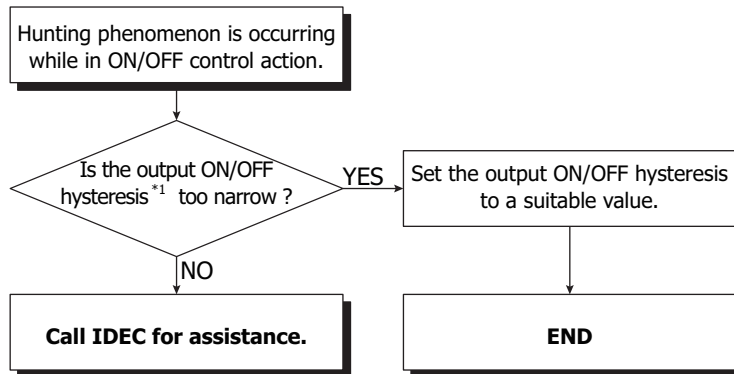
Hunting phenomenon is occurring while in ON/OFF control action

*1 For detail about the output ON/OFF hysteresis, see "(15) Control Register+61: Output ON/OFF Hysteresis" on page 6-40.

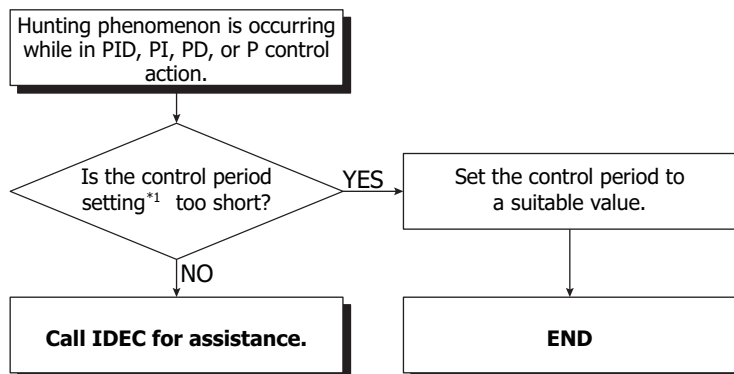
Hunting phenomenon is occurring while in PID, PI, PD, or P control action

*1 For detail about the control period, see "(2) Control Register+30: Control Period" on page 6-47.

The PID Module input does not operate normally.

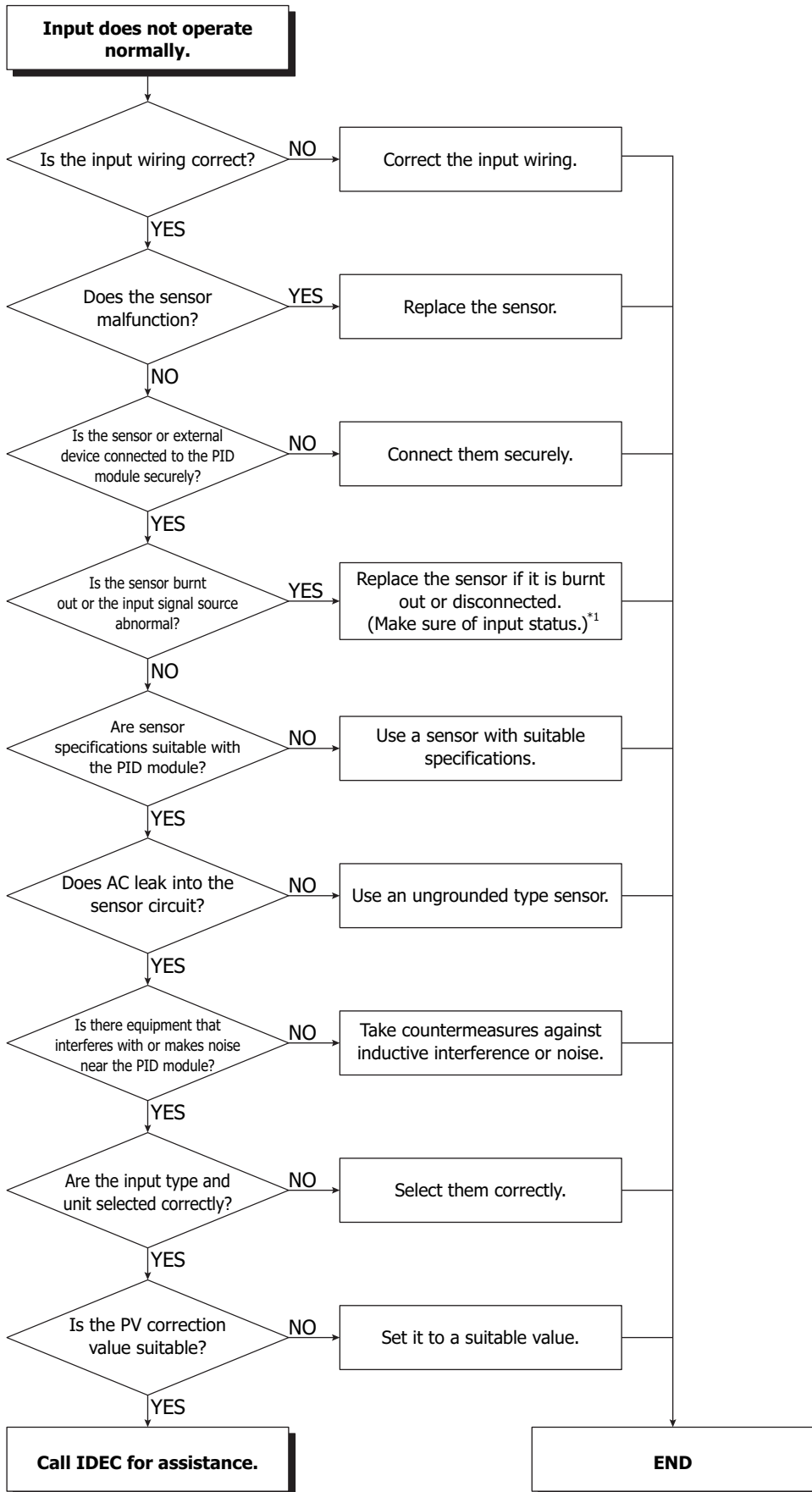

*1 See "Input Status Checking" on page 8-5.

Input Status Checking

Sensor may be burnt out if any of the following problems occur.

- (1) Operating status over range flag remains ON.
- (2) Operating status under range flag remains ON.
- (3) Input value constantly shows 0 mA or 0 V.

Please make sure these conditions are checked thoroughly and take the appropriate action.

(1) Operating status over range flag remains ON.

Checking Items	Action
Is thermocouple or resistance thermometer burnt out? Is voltage input (0 to 1V DC) disconnected?	Replace sensor. [How to check sensor burn out or voltage disconnection] [Thermocouple] Short the input terminals of the PID module. If a value around room temperature is indicated, the PID module is operating normally and the sensor may be burnt out. [Resistance thermometer] Connect approx. 100 Ω resistor between the input terminals A and B, and short the input terminals B and B of the PID module. If a value around 0°C (32°F) is indicated, the PID module is operating normally and the sensor may be burnt out. [Voltage (0 to 1V DC)] Short the input terminals of the PID module. If a linear conversion minimum value is indicated, the PID module is operating normally and the signal wire may be disconnected.

(2) Operating status under range flag remains ON.

Checking Items	Action
Does the input signal source for voltage (1 to 5V DC) or current (4 to 20 mA) operate normally?	Check the input signal source for voltage (1 to 5V DC) or current (4 to 20 mA). [How to check whether the input signal wire is disconnected] [Voltage (1 to 5V DC)] Input 1V DC to the input terminals of the PID module. If a linear conversion minimum value is indicated, the PID module is operating normally and the signal wire may be disconnected. [Current (4 to 20 mA)] Input 4 mA to the input terminals of the PID module. If a linear conversion minimum value is indicated, the PID module is operating normally and the signal wire may be disconnected.

(3) The process variable (PV) constantly shows the linear conversion minimum value.

Checking Items	Action
Does the input signal source for voltage (0 to 5V DC, 0 to 10V DC) or current (0 to 20 mA) operate normally?	Check input signal source for voltage (0 to 5V DC or 0 to 10V DC) or current (0 to 20 mA). [How to check whether the input signal wire is disconnected] [Voltage (0 to 5V DC or 0 to 10V DC)] Input 1V DC to the input terminals of the PID module. If a converted value, calculated with the linear conversion minimum and maximum values, corresponding to 1V DC is indicated, the PID module is operating normally and the signal wire may be disconnected. [Current (0 to 20 mA)] Input 4 mA to the input terminals of the PID module. If a converted value, calculated with the linear conversion minimum and maximum values, corresponding to 4 mA is indicated, the PID module is operating normally and the signal wire may be disconnected.

Loop break alarm turns on even though the actuator operates normally.

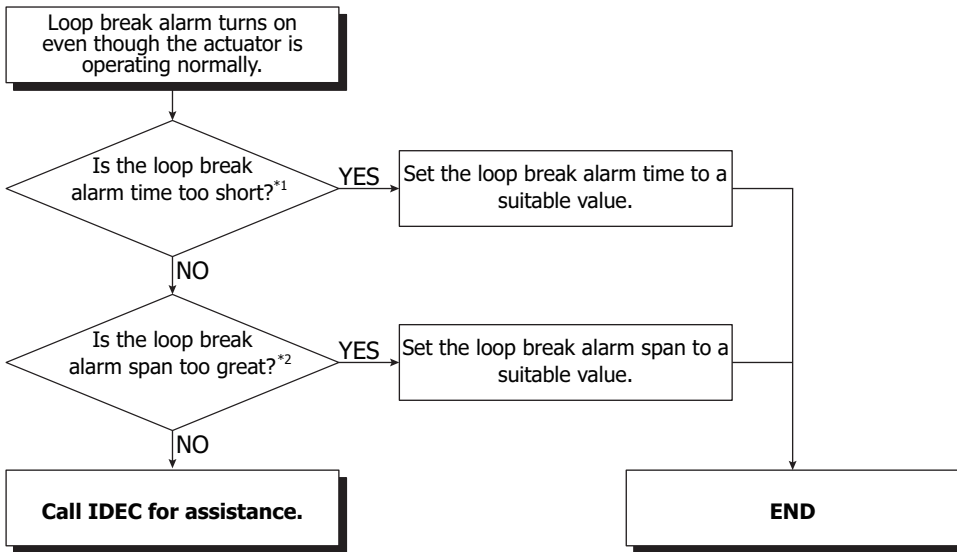

*1 Loop break alarm time may be too short compared to the loop break alarm span.

*2 Loop break alarm span may be too great compared to the loop break alarm time.

Note: Loop break alarm time and loop break alarm span

Set the loop break alarm span to a value around 1.25 times bigger than the operation span in normal operation.

Example: Heater in which temperature rises 150°C in 30 minutes

When the loop break alarm time is 10 minutes, the operation span in normal operation is 50°C (150°C/30 minutes × 10 minutes). Set the loop break alarm span to 65°C which is about 1.25 times bigger than 50°C.

Program control is terminated earlier than the configured time.

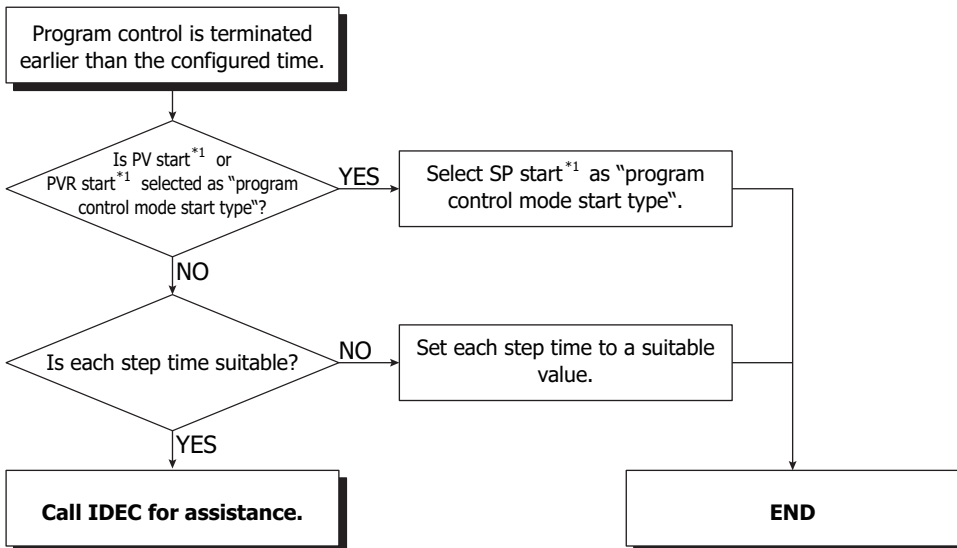

*1 For program control mode start type, see "(23) Control Register+91: Program Control Mode Start Type" on page 6-42.

APPENDIX

This chapter describes the function references, output actions, and factory default settings of the PID module.

PID Module Function References

Control Action

- PID control [with auto-tuning (AT)]
- PI control
- PD control (with auto-reset)
- P control (with auto-reset)
- ON/OFF control

Item	Specifications		
Proportional term (P)	Proportional band	When input range unit is Celsius	0 to 10,000°C (Range with a decimal point: 0.0 to 1,000.0°C)
		When input range unit is Fahrenheit	0 to 10,000°F (Range with a decimal point: 0.0 to 1,000.0°F)
		When input is voltage/current	0.0 to 1,000.0%
	Proportional gain		0.00 to 100.00% (ON/OFF control when the setting value is set to 0, 0.0, or 0.00)
Integral time (I)	0 to 10,000 seconds		
Derivative time (D)	0 to 10,000 seconds		
Control period	1 to 120 seconds		
ARW	0 to 100%		
Reset	When input range unit is Celsius		-100.0 to +100.0°C
	When input range unit is Fahrenheit		-100.0 to +100.0°F
	When input is voltage/current		-1,000 to +1,000
Output ON/OFF hysteresis	When input range unit is Celsius		0.1 to 100.0°C
	When input range unit is Fahrenheit		0.1 to 100.0°F
	When input is voltage/current		1 to 1,000
Output manipulated variable (MV) upper limit, lower limit	When output type is relay or voltage	Upper limit	Output manipulated variable lower limit value to 100%
		Lower limit	0 to output manipulated variable upper limit value
	When output type is current	Upper limit	Output manipulated variable lower limit value to 105%
		Lower limit	-5 to output manipulated variable upper limit value
Output manipulated variable rate-of-change	0 to 100%/sec		

Alarm

The alarm range can be configured with the alarm value. When the process variable (PV) goes outside of the range, the alarm output turns on or off.

Alarm type can be selected from upper limit alarm, lower limit alarm, upper/lower limits alarm, upper/lower limit range alarm, process low alarm, process high alarm, upper limit alarm with standby, lower limit alarm with standby, upper/lower limits alarm with standby, and no alarm action.

For details about the alarm, see "Alarm Type Diagrams" on page 6-28.

Item	Specifications	
Setting accuracy	Same with input error (See "Input Error" on page 2-4)	
Action	ON/OFF action	
Hysteresis	When input range unit is Celsius	0.1 to 100.0°C
	When input range unit is Fahrenheit	0.1 to 100.0°F
	When input is voltage/current	1 to 1,000
Output	Operating status	
Alarm Delay time	0 to 10,000 seconds	

Loop Break Alarm

A trouble of the actuator, such as heater break or heater adhesion, can be detected as the loop break alarm. For details about the loop break alarm, see "(18) Control Register+36: Loop Break Alarm Span" on page 6-41.

Item	Specifications	
Loop break alarm time	0 to 200 minutes	
Loop break alarm span	When input range unit is Celsius	0 to 150°C or 0.0 to 150.0°C
	When input range unit is Fahrenheit	0 to 150°F or 0.0 to 150.0°F
	When input is voltage/current	0 to 1,500
Output	Bit 2 of the operating status	

Set Point (SP) Ramp Function

When the set point (SP) is changed, the set point (SP) is gradually increased from the original set point (SP) to the new set point (SP) according to the configured rate-of-change (°C/minute, °F/minute).

When the control is started, the set point (SP) is increased from the current process variable (PV) to the configured set point (SP) according to the configured rate-of-change (°C/minute, °F/minute).

Auto/Manual Mode Switching

The cascade control is an advanced control that uses 2 inputs [CH1 as a master (primary control) and CH0 as a slave (secondary control)] to control one process.

The output manipulated variable (MV) calculated according to the process variable (PV) and the set point (SP) of the master (CH1) is used as the set point (SP) of the slave (CH0) for control. The control results will be outputted from the output CH0.

Heating/Cooling Control Output (CH0 only)

When it is difficult to control the target process with heating control only, cooling control can be added to perform the heating/cooling control.

Item	Specifications		
Cooling proportional band	0.0 to 10.0 times. Cooling proportional band is the product of this value and the heating proportional band. The cooling control becomes ON/OFF control when the cooling proportional band is 0.		
Integral time (I)	0 to 10,000 seconds		
Derivative time (D)	0 to 10,000 seconds		
Cooling control period	1 to 120 seconds		
Overlap/Dead band	When input range unit is Celsius	-200.0 to +200.0°C	
	When input range unit is Fahrenheit	-200.0 to +200.0°F	
	When input is voltage/current	-2,000 to +2,000	
Cooling output ON/OFF hysteresis	When input range unit is Celsius	0.1 to 100.0°C	
	When input range unit is Fahrenheit	0.1 to 100.0°F	
	When input is voltage/current	1 to 1,000	
Cooling output manipulated variable (MV) upper limit, lower limit	When output type is voltage	Upper limit	Cooling output manipulated variable lower limit to 100%
		Lower limit	0% to cooling output manipulated variable upper limit
	When output type is current	Upper limit	Cooling output manipulated variable lower limit to 105%
		Lower limit	-5% to cooling output manipulated variable upper limit
Cooling method	Air cooling (Linear characteristic), Oil cooling (1.5th power of the linear characteristic), or Water cooling (2nd power of the linear characteristic)		
Cooling output	CH1 output		

External SP Input

The input value of input CH1 is used as the set point (SP) of CH0 control.

When the external SP input bias is configured, it is added to the set point (SP) of CH0 control.

The input types that can be selected are shown in the following table.

Item	Specifications	
Input type	Current	4 to 20 mA or 0 to 20 mA
	Voltage	1 to 5 V or 0 to 1 V
Allowable input	Current	50mA DC maximum
	Voltage (0 to 1 V)	5V DC maximum
	Voltage (1 to 5 V)	10V DC maximum
Input impedance	Current	50 Ω
	Voltage	100 k Ω

Wait Function

During the program control running, when a step is finished, the program control does not proceed to the next step until the deviation between the process variable (PV) and set point (SP) becomes less than the wait value.

Program Hold

During the program control running, when the program control is held, the progression of the program control is suspended. While the program control is held, the fixed value control is performed with the set point (SP) at the hold point.

Advance Next Step

During the program control running, when the advance next step bit is turned on, the current step is terminated, and the program control is proceeded to the next step.

Advance Previous Step

During the program control running, when the advance previous step bit is turned on, the progression of the program control is moved back. If the elapsed time in the current step is less than 1 minute, the program control goes back to the start of the previous step. If the elapsed time in the current step is more than or equal to 1 minute, the program control goes back to the start of the current step. Even when the advance previous function is executed at Step 0, the program control does not move back to Step 9 regardless of the program end action.

Repeat Function

When the program control is terminated, the program control can be repeated from step 0 as many times as the number of repeats configured.

Program End Action

The action to be taken when the program control is terminated can be selected.

Item	Specifications
Terminate program control	When the program control is terminated, the program end output bit is turned on and maintained, and the PID module will be in standby status. The program control can be executed again by turning off to on the program control bit (operation parameter bit3). During the program control standby (waiting for program control run) status, the control output is turned off, and the operating status is not updated except the over range, the under range, and the program end output.
Continue program control (Repeat)	When the program control is terminated, the program control is repeated from step 0 as many times as the configured number of repeats. When the step 9 of the last program control cycle is performed and finished, the program end output bit is turned on and maintained.
Hold program control	When the program control is terminated, the program control is held at the last status of step 9. The program end output and program hold bit are turned on and maintained. While the program control is held, the fixed value control is performed with the set point (SP) of step 9. If advance next function (operation parameter Bit6 is turned off to on) is executed while the program control is held, the program control is started again from step 0. The program end output and program hold bit are turned off. While the program control is being held, the parameters of Blocks 10 to 19 and 30 to 39 can be changed. The program control can be executed again after changing the program parameters, such as the set point (SP) or step time of each step.

External PV Mode

When the external PV mode is enabled, the PID module performs PID control with the process variable given by the CPU module. The process variable with decimal point (PV1) of the control target can be used to calculate the process variable using the ladder program in the CPU module.

Output Manipulated Variable (MV) Rate-of-Change

The maximum change of the output manipulated variable in one second can be configured.

PV Correction

If the sensor cannot be installed to the location of the control target, the temperature measured by the sensor may deviate from the actual temperature of the control target. When a target is controlled with multiple PID modules, the measured temperatures may not match due to the differences in sensor accuracy or dispersion of load capacities even though the set points (SP) of those PID modules are the same.

In such cases, the process variable (PV) of the PID module can be adjusted to the desired temperature by using the PV Correction. The process variable (PV) after PV correction is added should be within the control range.

The process variable (PV) after PV correction can be calculated using the following formula:

Process variable (PV) after PV correction = Process variable (PV) + (PV correction value)

- PV Correction Range When input range unit is Celsius: -100.0 to +100.0°C
- When input range unit is Fahrenheit: -100.0 to +100.0°F
- When input is voltage/current: -1,000 to +1,000

PV Filter Time Constant

The PV filter function is a software filter to stabilize the process variable (PV) affected by fluctuating processes, such as pressure or flow rate, by calculating first-order lag of the process variable (PV).

Automatic Cold Junction Temperature Compensation

The PID module measures the temperature at the input terminal and maintains the reference junction as if the reference junction was at 0°C or 32°F.

Burnout (Over Range)

When thermocouple input or resistance thermometer input is burnt out, the over range bit of the operating status is turned on, and control output is turned off (when output type is current, the output manipulated variable lower limit value is outputted).

Control Range

- When input is thermocouple: Input range lower limit -50°C (100°F) to Input range +50°C (100°F)
Range with a decimal point: -(Full scale x 1%)°C (°F) to Input range +50°C (100°F)
- When input is resistance thermometer: -(Full scale x 1%)°C (°F) to Input range +50°C (100°F)
- When input is voltage/current: Linear conversion minimum value -(1% of linear conversion span) to Linear conversion maximum value +(10% of linear conversion span)

PID Module Standby

When the power is turned on, the PID module starts with the standby status. During the standby, the control and alarm assessment are not conducted.

The control and alarm assessment are enabled when the control enable bit of the operation parameters is turned on.

When the control mode is the program control and the power is restored, the PID module resumes with the status at the time of the power failure.

Output Action

CH0, CH1 Output Action of PID, PI, PD, and P Control Action

	Heating (Reverse) Control Action	Cooling (Direct) Control Action
Control Action		
Relay Output	<p>Cycle Action is Performed According to Deviation.</p>	<p>Cycle Action is Performed According to Deviation.</p>
Non-contact Voltage Output	<p>Cycle Action is Performed According to Deviation.</p>	<p>Cycle Action is Performed According to Deviation.</p>
Current Output	<p>Changes Continuously According to Deviation.</p>	<p>Changes Continuously According to Deviation.</p>
Control Output LEDs [OUT0, OUT1]		

: Turns ON or OFF.

CH0, CH1 Output Action of ON/OFF Control Action

	Heating (Reverse) Control Action	Cooling (Direct) Control Action
Control Action		
Relay Output		
Non-contact Voltage Output		
Current Output		
Control Output LEDs [OUT0, OUT1]		

: Turns ON or OFF.

Output Action of Heating/Cooling Control

Control Action			
CH0 Relay Output	<p>Cycle Action is Performed According to Deviation.</p>		
CH1 Relay Output	<p>Cycle Action is Performed According to Deviation.</p>		
CH0 Non-contact Voltage Output	<p>Cycle Action is Performed According to Deviation.</p>		
CH1 Non-contact Voltage Output	<p>Cycle Action is Performed According to Deviation.</p>		
CH0 Current Output	<p>Changes Continuously According to Deviation.</p>		
CH1 Current Output	<p>Changes Continuously According to Deviation.</p>		
Control Output LED [OUT0]			
Control Output LED [OUT1]			

- : Turns ON or OFF.
- : Represents heating control action.
- : Represents cooling control action.

Output Action of Heating/Cooling Control with Overlap

Control Action			
CH0 Relay Output	<p>Cycle Action is Performed According to Deviation.</p>		
CH1 Relay Output	<p>Cycle Action is Performed According to Deviation.</p>		
CH0 Non-contact Voltage Output	<p>Cycle Action is Performed According to Deviation.</p>		
CH1 Non-contact Voltage Output	<p>Cycle Action is Performed According to Deviation.</p>		
CH0 Current Output	<p>Changes Continuously According to Deviation.</p>		
CH1 Current Output	<p>Changes Continuously According to Deviation.</p>		
Control Output LED [OUT0]			
Control Output LED [OUT1]			

: Turns ON or OFF.
 : Represents heating control action.
 : Represents cooling control action.

Output Action of Heating/Cooling Control with Dead Band

	Heating Proportional Band	Dead Band	Cooling Proportional Band
Control Action	ON Heating Control Action OFF	SP	ON Cooling Control Action OFF
CH0 Relay Output			
CH1 Relay Output			
CH0 Non-contact Voltage Output	+ 12 V DC -	+ 12/0V DC -	+ 0V DC -
CH1 Non-contact Voltage Output		+ 0V DC -	+ 0/12 V DC - 12 V DC
CH0 Current Output	+ 20 mA DC -	+ 20 to 4 mA DC -	+ 4 mA DC -
CH1 Current Output		+ 4 mA DC -	+ 4 to 20 mA DC - 20 mA DC
Control Output LED [OUT0]	(Green) Lit		Unlit
Control Output LED [OUT1]	Unlit		(Green) Lit

: Turns ON or OFF.
 : Represents heating control action.
 : Represents cooling control action.

Factory Default Settings of the PID Module

The factory default settings of the parameters of each block are described. Values indicated in parentheses are stored in the data registers allocated to each block.

Block 1: Write Only Parameters

Offset from the Control Register		Parameter	Default Value
CH0	CH1		
+20	+23	Set Point (SP)	0°C (0)
+21	+24	Manual Mode Output Manipulated Variable (External PV mode disabled)	0% (0)
+22	+25	Operation Parameter *1	0

*1 For details about the operation parameter, see "Operation Parameters" on page 5-11.

Blocks 2, 3: Basic Parameters

Offset from the Control Register		Parameter	Default Value
CH0	CH1		
+26	+103	Proportional Term	Proportional band: 10°C (10)
+27	+104	Integral Time	200 sec (200)
+28	+105	Derivative Time	50 sec (50)
+29	+106	ARW (Anti-Reset Windup)	50% (50)
+30	+107	Control Period	FC6A-F2MR1 (Relay output): 30 sec (30) FC6A-F2M1 (Non-contact voltage output): 3 sec (3)
+31	+108	Reset	0.0°C (0)
+32	+109	Output Manipulated Variable Rate-of-Change	0%/second (0)
+33	+110	Set Point (SP) Rise Rate	0°C/minute (0)
+34	+111	Set Point (SP) Fall Rate	0°C/minute (0)
+35	+112	Loop Break Alarm (LA) Time	0 minutes (0)
+36	+113	Loop Break Alarm (LA) Span	0°C (0)
+37	+114	Alarm 1 Value	0°C (0)
+38	+115	Alarm 2 Value	
+39	+116	Alarm 3 Value	
+40	+117	Alarm 4 Value	
+41	+118	Alarm 5 Value	
+42	+119	Alarm 6 Value	
+43	+120	Alarm 7 Value	
+44	+121	Alarm 8 Value	
+45	+122	Reserved	0
+46	+123	Output Manipulated Variable Upper Limit	100% (100)
+47	+124	Output Manipulated Variable Lower Limit	0% (0)
+48	+125	Cooling Proportional Band (CH0 only)	[CH0] 1.0 times (10) [CH1] 0
+49	+126	Cooling Control Period (CH0 only)	[CH0] FC6A-F2MR1 (Relay output): 30 sec (30) FC6A-F2M1 (Non-contact voltage output): 3 sec (3) [CH1] 0
+50	+127	Overlap/Dead Band (CH0 only)	[CH0] 0.0°C (0) [CH1] 0
+51	+128	Cooling Output Manipulated Variable Upper Limit (CH0 only)	[CH0] 100% (100) [CH1] 0
+52	+129	Cooling Output Manipulated Variable Lower Limit (CH0 only)	[CH0] 0% (0) [CH1] 0

APPENDIX

Blocks 4, 5: Initial Setting Parameters

Offset from the Control Register		Parameter	Default Value
CH0	CH1		
+53	+130	Control Action	0: Reverse action (Heating)
+54	+131	Heating/Cooling Control (CH0 only)	[CH0] 0: Disable [CH1] 0
+55	+132	External SP Input (CH0 only)	[CH0] 0: Disable [CH1] 0
+56	+133	Input Function	[CH0/CH1] 0: Input (CH0/CH1)
+57	-	Output Function (CH0)	[CH0] 0: Output (CH0)
-	+134	Output Function (CH1)	[CH1] 0: Output (CH1)
+58	+135	Input Type	00h: Type K thermocouple -200 to 1,370°C
+59	+136	Set Point (SP) Upper Limit/Linear Conversion Maximum Value	1,370°C (1370)
+60	+137	Set Point (SP) Lower Limit/Linear Conversion Minimum Value	-200°C (-200)
+61	+138	Output ON/OFF Hysteresis	1.0°C (10)
+62	+139	PV Correction	0.0°C (0)
+63	+140	PV Filter Time Constant	0.0 seconds (0)
+64	+141	Reserved	0
+65	+142	Alarm 1 Type	0: No alarm action
+66	+143	Alarm 2 Type	
+67	+144	Alarm 3 Type	
+68	+145	Alarm 4 Type	
+69	+146	Alarm 5 Type	
+70	+147	Alarm 6 Type	
+71	+148	Alarm 7 Type	
+72	+149	Alarm 8 Type	
+73	+150	Alarm 1 Hysteresis	1.0°C (10)
+74	+151	Alarm 2 Hysteresis	
+75	+152	Alarm 3 Hysteresis	
+76	+153	Alarm 4 Hysteresis	
+77	+154	Alarm 5 Hysteresis	
+78	+155	Alarm 6 Hysteresis	
+79	+156	Alarm 7 Hysteresis	
+80	+157	Alarm 8 Hysteresis	
+81	+158	Alarm 1 Delay Time	0.0 seconds (0)
+82	+159	Alarm 2 Delay Time	
+83	+160	Alarm 3 Delay Time	
+84	+161	Alarm 4 Delay Time	
+85	+162	Alarm 5 Delay Time	
+86	+163	Alarm 6 Delay Time	
+87	+164	Alarm 7 Delay Time	
+88	+165	Alarm 8 Delay Time	
+89	+166	AT Bias	20°C (20)
+90	+167	Control Mode	0: Fixed value control
+91	+168	Program Control Mode Start Type	0: PV start
+92	+169	Step Time Unit	0: Minute
+93	+170	Program End Action	0: Terminate program control
+94	+171	Proportional Term	0: Proportional band
+95	+172	Cooling Method (CH0 only)	[CH0] 0: Air cooling [CH1] 0
+96	+173	Set Point (SP) when Program Control Starts	0.0°C (0)
+97	+174	Number of Repeats	0 times (0)
+98	+175	Cooling Output ON/OFF Hysteresis (CH0 only)	[CH0] 1.0°C (10) [CH1] 0

Offset from the Control Register		Parameter	Default Value
CH0	CH1		
+99	+176	Output Specifications (FC6A-F2M1 only)	0: Non-contact voltage output (for SSR drive)
+100	+177	External SP Input Bias (CH1 only)	[CH0] 0 [CH1] 0.0°C (0)
+101	+178	External SP Input Linear Conversion Maximum Value (CH1 only)	[CH0] 0 [CH1] 1,370°C (1370)
+102	+179	External SP Input Linear Conversion Minimum Value (CH1 only)	[CH0] 0 [CH1] -200°C (-200)

Blocks 10-19: Program (CH0) Parameters

Offset from the Control Register					Parameter	Default Value
Step 0	Step 1	Step 2	Step 3	Step 4		
+180	+201	+222	+243	+264	Set Point (SP)	0°C (0)
+181	+202	+223	+244	+265	Step Time	0 minutes (0)
+182	+203	+224	+245	+266	Wait Value	0°C (0)
+183	+204	+225	+246	+267	Proportional Term	Proportional band: 10°C (10)
+184	+205	+226	+247	+268	Integral Time	200 sec (200)
+185	+206	+227	+248	+269	Derivative Time	50 sec (50)
+186	+207	+228	+249	+270	ARW (Anti-Reset Windup)	50% (50)
+187	+208	+229	+250	+271	Output Manipulated Variable Rate-of-Change	0%/second (0)
+188	+209	+230	+251	+272	Alarm 1 Value	0°C (0)
+189	+210	+231	+252	+273	Alarm 2 Value	
+190	+211	+232	+253	+274	Alarm 3 Value	
+191	+212	+233	+254	+275	Alarm 4 Value	
+192	+213	+234	+255	+276	Alarm 5 Value	
+193	+214	+235	+256	+277	Alarm 6 Value	
+194	+215	+236	+257	+278	Alarm 7 Value	
+195	+216	+237	+258	+279	Alarm 8 Value	
+196	+217	+238	+259	+280	Reserved	0
+197	+218	+239	+260	+281	Output Manipulated Variable Upper Limit	100% (100)
+198	+219	+240	+261	+282	Output Manipulated Variable Lower Limit	0% (0)
+199	+220	+241	+262	+283	Cooling Proportional Band	1.0 times (10)
+200	+221	+242	+263	+284	Overlap/Dead Band	0.0°C (0)

Offset from the Control Register					Parameter	Default Value
Step 5	Step 6	Step 7	Step 8	Step 9		
+285	+306	+327	+348	+369	Set Point (SP)	0°C (0)
+286	+307	+328	+349	+370	Step Time	0 minutes (0)
+287	+308	+329	+350	+371	Wait Value	0°C (0)
+288	+309	+330	+351	+372	Proportional Term	Proportional band: 10°C (10)
+289	+310	+331	+352	+373	Integral Time	200 sec (200)
+290	+311	+332	+353	+374	Derivative Time	50 sec (50)
+291	+312	+333	+354	+375	ARW (Anti-Reset Windup)	50% (50)
+292	+313	+334	+355	+376	Output Manipulated Variable Rate-of-Change	0%/second (0)
+293	+314	+335	+356	+377	Alarm 1 Value	0°C (0)
+294	+315	+336	+357	+378	Alarm 2 Value	
+295	+316	+337	+358	+379	Alarm 3 Value	
+296	+317	+338	+359	+380	Alarm 4 Value	
+297	+318	+339	+360	+381	Alarm 5 Value	
+298	+319	+340	+361	+382	Alarm 6 Value	
+299	+320	+341	+362	+383	Alarm 7 Value	
+300	+321	+342	+363	+384	Alarm 8 Value	
+301	+322	+343	+364	+385	Reserved	0
+302	+323	+344	+365	+386	Output Manipulated Variable Upper Limit	100% (100)
+303	+324	+345	+366	+387	Output Manipulated Variable Lower Limit	0% (0)
+304	+325	+346	+367	+388	Cooling Proportional Band	1.0 times (10)

APPENDIX

Offset from the Control Register					Parameter	Default Value
Step 5	Step 6	Step 7	Step 8	Step 9		
+305	+326	+347	+368	+389	Overlap/Dead Band	0.0°C (0)

Blocks 30-39: Program (CH1) Parameters

Offset from the Control Register					Parameter	Default Value
Step 0	Step 1	Step 2	Step 3	Step 4		
+390	+409	+428	+447	+466	Set Point (SP)	0°C (0)
+391	+410	+429	+448	+467	Step Time	0 minutes (0)
+392	+411	+430	+449	+468	Wait Value	0°C (0)
+393	+412	+431	+450	+469	Proportional Term	Proportional band: 10°C (10)
+394	+413	+432	+451	+470	Integral Time	200 sec (200)
+395	+414	+433	+452	+471	Derivative Time	50 sec (50)
+396	+415	+434	+453	+472	ARW (Anti-Reset Windup)	50% (50)
+397	+416	+435	+454	+473	Output Manipulated Variable Rate-of-Change	0%/second (0)
+398	+417	+436	+455	+474	Alarm 1 Value	0°C (0)
+399	+418	+437	+456	+475	Alarm 2 Value	
+400	+419	+438	+457	+476	Alarm 3 Value	
+401	+420	+439	+458	+477	Alarm 4 Value	
+402	+421	+440	+459	+478	Alarm 5 Value	
+403	+422	+441	+460	+479	Alarm 6 Value	
+404	+423	+442	+461	+480	Alarm 7 Value	
+405	+424	+443	+462	+481	Alarm 8 Value	
+406	+425	+444	+463	+482	Reserved	0
+407	+426	+445	+464	+483	Output Manipulated Variable Upper Limit	100% (100)
+408	+427	+446	+465	+484	Output Manipulated Variable Lower Limit	0% (0)

Offset from the Control Register					Parameter	Default Value
Step 5	Step 6	Step 7	Step 8	Step 9		
+485	+504	+523	+542	+561	Set Point (SP)	0°C (0)
+486	+505	+524	+543	+562	Step Time	0 minutes (0)
+487	+506	+525	+544	+563	Wait Value	0°C (0)
+488	+507	+526	+545	+564	Proportional Term	Proportional band: 10°C (10)
+489	+508	+527	+546	+565	Integral Time	200 sec (200)
+490	+509	+528	+547	+566	Derivative Time	50 sec (50)
+491	+510	+529	+548	+567	ARW (Anti-Reset Windup)	50% (50)
+492	+511	+530	+549	+568	Output Manipulated Variable Rate-of-Change	0%/second (0)
+493	+512	+531	+550	+569	Alarm 1 Value	0°C (0)
+494	+513	+532	+551	+570	Alarm 2 Value	
+495	+514	+533	+552	+571	Alarm 3 Value	
+496	+515	+534	+553	+572	Alarm 4 Value	
+497	+516	+535	+554	+573	Alarm 5 Value	
+498	+517	+536	+555	+574	Alarm 6 Value	
+499	+518	+537	+556	+575	Alarm 7 Value	
+500	+519	+538	+557	+576	Alarm 8 Value	
+501	+520	+539	+558	+577	Reserved	0
+502	+521	+540	+559	+578	Output Manipulated Variable Upper Limit	100% (100)
+503	+522	+541	+560	+579	Output Manipulated Variable Lower Limit	0% (0)

INDEX

- A**
 - alarm
 - delay time 5-21, 6-31
 - hysteresis 5-21, 6-31
 - output 5-9
 - type 5-20
 - upper limit alarm 7-1, 7-10
 - upper/lower limits alarm with standby 7-20
 - valid range 5-19
 - Alarm Type
 - Lower Limit Alarm 6-28
 - Lower Limit Alarm with Standby 6-30
 - Process High Alarm 6-29, 6-33
 - Process Low Alarm 6-29, 6-34
 - Upper Limit Alarm 6-28
 - Upper Limit Alarm with Standby 6-30
 - Upper/Lower Limit Range Alarm 6-29
 - Upper/Lower Limits Alarm 6-29
 - Upper/Lower Limits Alarm with Standby 6-30
 - Alarm type 6-28
 - ARW 5-18, 6-39
 - AT bias 4-7, 5-21, 6-39, 7-7
 - auto-reset 4-8, 5-8, 5-11
 - auto-tuning (AT) 5-8, 7-7
 - cancel 4-8
 - perform 4-8, 5-11
 - auto-tuning (AT)/auto-reset 4-7
 - LED 2-2
 - program example 4-9
- B**
 - basic parameters 5-2, 5-18, A-9
 - block 0 5-1, 5-7
 - block 1 5-1, 5-10, A-9
 - blocks 10-19 5-1, 5-23, A-11
 - blocks 2, 3 5-1, 5-18, A-9
 - blocks 30-39 5-1, 5-25, A-12
 - blocks 4, 5 5-1, 5-20, A-10
- C**
 - cascade control 4-15, 5-20, 6-24
 - linear conversion maximum value 6-45
 - linear conversion minimum value 6-45
 - control action 5-20, 6-37
 - ON/OFF control action 4-4, 8-3
 - P control action 4-5
 - PD control action 4-6
 - PI control action 4-6
 - PID control action 4-6, 7-1
 - control parameters 6-13
 - details 6-36
 - control period 5-18, 6-47
 - Control Range A-4
 - control range
 - over range 5-9
 - under range 5-9
 - control register 5-2, 6-7
 - control relay 5-2, 6-7
 - loading initial values 5-3, 6-5
 - reading all parameters 5-3, 6-5
 - writing all parameters 5-3, 6-5
 - writing block 5-3
 - cooling
 - control period 5-19, 6-47
 - output manipulated variable (MV) 5-7
 - output manipulated variable lower limit 6-47
 - output manipulated variable upper limit 6-47
 - output ON/OFF hysteresis 6-41
 - proportional band 5-18
 - Crimping tool 3-3
- D**
 - decimal point 5-4, 5-6
 - derivative time 5-5, 5-18, 6-39
 - difference input control 4-14, 4-19, 6-22, 6-23
 - direct control action 6-37
- E**
 - external SP 5-11, 5-20, 6-11, 6-23, 6-32
 - enable/disable LED 2-2
 - input bias 5-21, 6-33
 - linear conversion maximum value 5-21, 6-33
 - linear conversion minimum value 5-21, 6-33
- F**
 - factory default settings A-9
 - Ferrule 3-3
 - fixed value control 4-4, 7-1
 - full scale 5-19
- H**
 - heating/cooling control 4-14, 5-20, 6-38, 7-16
 - cooling method 6-41
 - cooling proportional band 6-41
 - hunting phenomenon 8-3
- I**
 - I/O function
 - combination 6-24
 - input function 6-22
 - output function 6-24
 - initial setting parameters 5-2, 5-20, A-10
 - input
 - operation 8-4
 - range 5-22, 6-10
 - status checking 8-5
 - Input internal circuit 2-5
 - input parameters 6-8
 - details 6-26
 - input range 6-10, 6-26
 - installation and wiring 3-1
 - integral time 5-5, 5-18, 6-38
- L**
 - linear conversion 6-27
 - linear conversion span 5-19
 - loop break alarm 5-9, 8-6
 - span 5-18, 6-41
 - time 5-18, 6-40
- M**
 - manual mode
 - LED 2-2
 - output manipulated variable 5-10, 6-40
 - Module Configuration Editor 6-6
 - mounting hole layout for direct mounting 3-1
- O**
 - operating status 5-9

- over range 8-5
 - under range 8-5
 - operation parameters 5-11
 - monitor 5-8
 - output
 - action A-5, A-6, A-7, A-8
 - lower limit 6-47
 - manipulated variable (MV) 5-7
 - ON/OFF hysteresis 6-40
 - operation 8-2
 - rate-of-change 6-40
 - type 5-21, 6-47
 - upper limit 6-47
 - Output delay 2-7
 - Output internal circuit 2-6
 - output parameters 6-18
 - details 6-46
 - overlap/dead band 5-19, 6-42
- P**
- parameter range error 5-8
 - PID module 1-1
 - applicable CPU and WindLDR version 1-1
 - control output 5-9
 - device allocation 5-1
 - dimensions 2-8
 - enable control 5-11
 - monitoring 6-53
 - parameters 6-3
 - parts description 2-1
 - power LED (PWR) 8-1
 - status 5-4, 5-7
 - temperature control 4-1
 - type numbers 1-1
 - PID module configuration dialog box 6-2
 - Precautions when supplying power 3-4
 - process variable (PV) 5-7
 - program control 4-10, 7-9
 - advance next 4-10, 5-11
 - advance previous 4-10, 5-11
 - auto-tuning (AT) 7-14
 - examples 5-12
 - hold 4-10, 5-11, 5-15
 - number of repeats 5-21
 - parameters 5-23, 5-24, A-11
 - program end action 4-11, 4-12, 5-21, 6-44
 - program end output 4-11, 5-9
 - program pattern example 4-13, 7-9
 - remaining time 5-7
 - repeat number 5-7, 6-44
 - run 5-11
 - set point (SP) 6-48
 - standby 4-12
 - start 4-10
 - start type 5-21, 6-42
 - step number 5-7
 - step time 5-24, 6-48, 7-10, 8-6
 - step time unit 5-21, 6-44
 - stop 4-10
 - terminate 5-12
 - wait 4-11, 5-9, 5-24, 6-49, 7-9, 7-13
 - program control mode
 - LED 2-2
 - program end action
 - continue (repeat) 5-13, 5-14
 - hold 5-17
 - terminate 5-12
 - program parameters 5-2, 5-25, A-11
 - details 6-48
 - list 6-20
 - Program performance 2-7
 - program size 5-2
 - Progression time error after power interruption 2-7
 - proportional band 6-38
 - proportional term 5-18, 6-38
 - PV correction 5-20, 6-26
 - PV filter time constant 5-6, 5-20, 6-27
- R**
- read only parameters 5-7
 - reset setting 6-39
 - reverse control action 6-37
- S**
- set point (SP) 5-4, 5-7, 5-10, 6-38
 - fall rate 5-18, 6-40
 - lower limit 6-27
 - rise rate 5-18, 6-40
 - upper limit 6-8, 6-27
 - when program control starts 6-44
- T**
- terminal
 - connection 3-2
 - Terminals for Terminal Blocks 3-2
- U**
- user program download and upload 6-3
- V**
- valid devices 5-2
- W**
- write only parameters 5-10, A-9