

Programmable Operator Interface

# MONITOUCH

**Edge-computing accelerates  
the transition to smart production sites**



**X1** STANDARD MODEL  
*Series*

# The X1 series features the broad FA and IT connectivity and flexibility to digitize your factory.

## Integration with IT systems

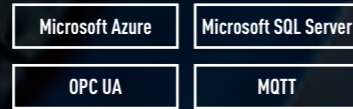

In addition to the HMI functions for operating and monitoring production machines, the X1 achieves data linkage between FA and higher level IT or cloud systems via OPC UA and MQTT connections.

By connecting with MES and ERP systems, data visualization, improvement of productivity and optimization of production management can be conducted.

## Visibility and User-friendliness



A high speed CPU, high resolution LCD and PCAP touchscreen improve visibility and operability.

A vectorized rendering engine allows for high quality scaling. Beautiful high quality screens can be created regardless of the display resolution.



## Utilization of User Applications



Since Windows is installed, Windows applications and user applications can be used at production sites.

Applications can be run by switches on the HMI display and used freely at production sites.

Data collection, processing and analysis can be conducted between production sites and host systems, contributing to the digitization of your factory.

## Inheritance of V-series Screen Assets



Screen assets created for the V-series can be converted for use in the X1 series. The configuration software V-SFT Ver.6 can be used as well.

MONITOUCH's highly-developed communication drivers can be used for connection with various equipment without programming.

## Positioning

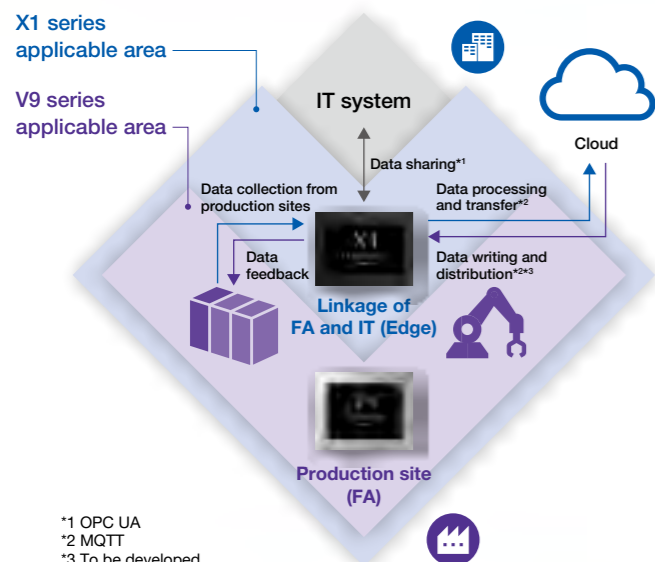

\*1 OPC UA  
\*2 MQTT  
\*3 To be developed

## Operation Scheme

In addition to the communication and display functions of the MONITOUCH HMI, data processing and analysis are available through connecting with user applications and the host system.

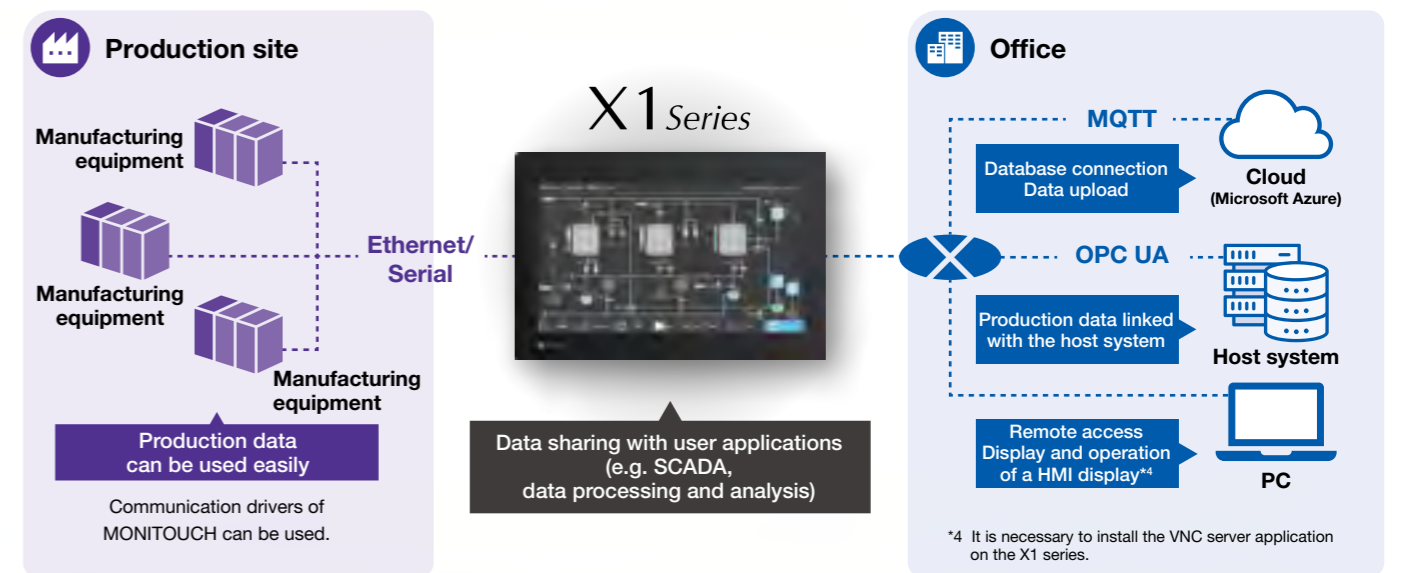

\*4 It is necessary to install the VNC server application on the X1 series.



# The X1 series facilitates the implementation of smart factories that effectively utilize data.

## Compatible with OPC UA Server and Client

- The X1 series is equipped with OPC UA server and client, so data can be collected by connecting to both offices and production sites.
- Even if devices at the production site are incompatible with OPC UA, the X1 series can fulfil the role of a gateway to OPC UA in order to transfer data to OPC UA clients in the host system.
- OPC UA enables data sharing between production sites and the host system, and facilitates the standardization of equipment.

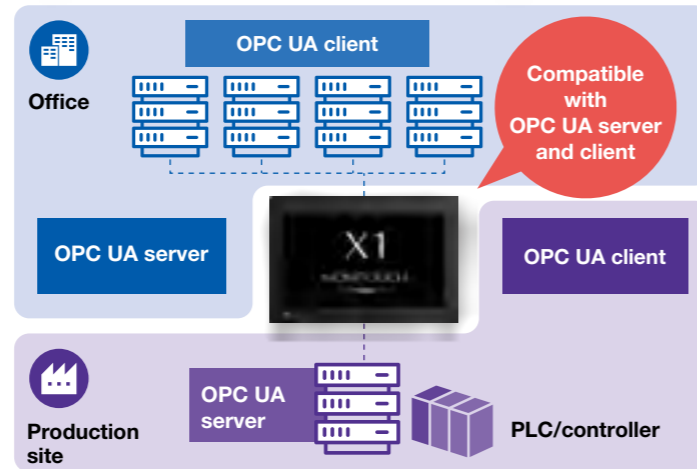

## Application example

### Workpiece conveyor

The X1 series collects data from multiple machines at production sites and shares it with the host system via OPC UA. This helps to improve productivity and product quality, and it facilitates the standardization of equipment. Adoption of the X1 series for devices equipped with industrial robots adds further value to the robots that contribute to factory automation.

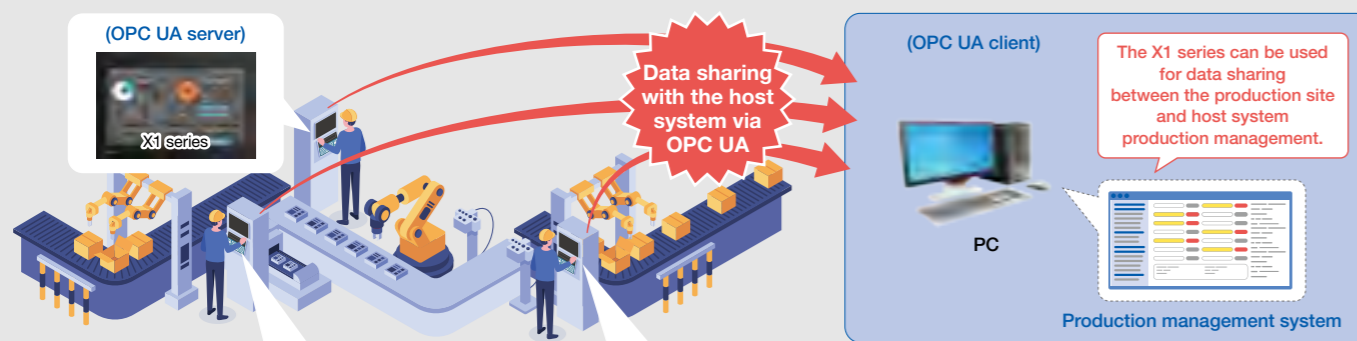

**Engineering tool**

If engineering tools of connected devices are installed, it is possible to edit and monitor the programs of robots or PLCs through the X1 series. Bringing a PC into the production site is no longer necessary.

**Data collection using Excel**

Operation data of transfer robots can be linked to Excel on the X1 via V-Server (our data collection software). Graphs created by Excel can be displayed on the X1 by installing and linking Excel and V-Server.

It is possible to use applications such as Excel on the X1 at the production sites.

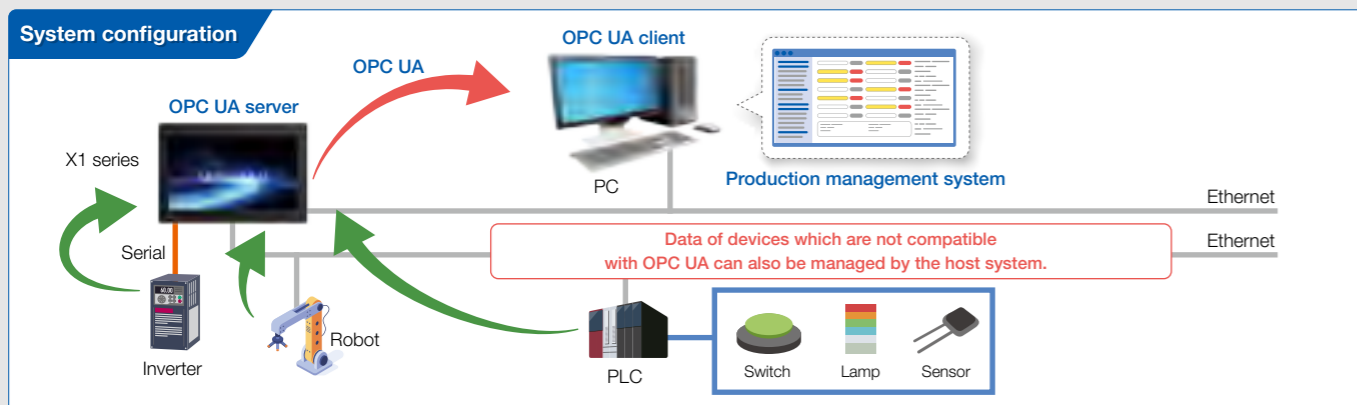

## Cloud (MQTT) Compatible

- Operation data, production data, status data, etc. are sent to the cloud system via MQTT for collection and storage. It contributes to the visualization and improvement of the factory.
- Since the system is linked with the Microsoft Azure platform, various tools and frameworks of the cloud service can be used.

Linkage with Microsoft services via Azure IoT Hub is possible

Visualization, analysis, AI / Machine learning

- Visualization
- Progress management
- Diagnosis / Analysis
- Prediction / Status detection
- Cause analysis
- KPI management

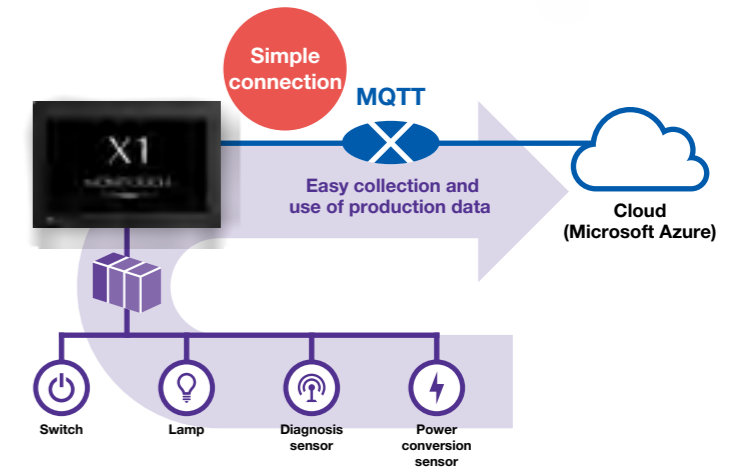

## Application example

### Pharmaceutical equipment

Increased efficiency and improvement of the production system is realized by connecting to the cloud and analyzing, visualizing and identifying trends of the collected data. Besides, it contributes to ensuring the security in pharmaceutical manufacturing by installing the X1 series on pharmaceutical equipment that requires high-level security management.

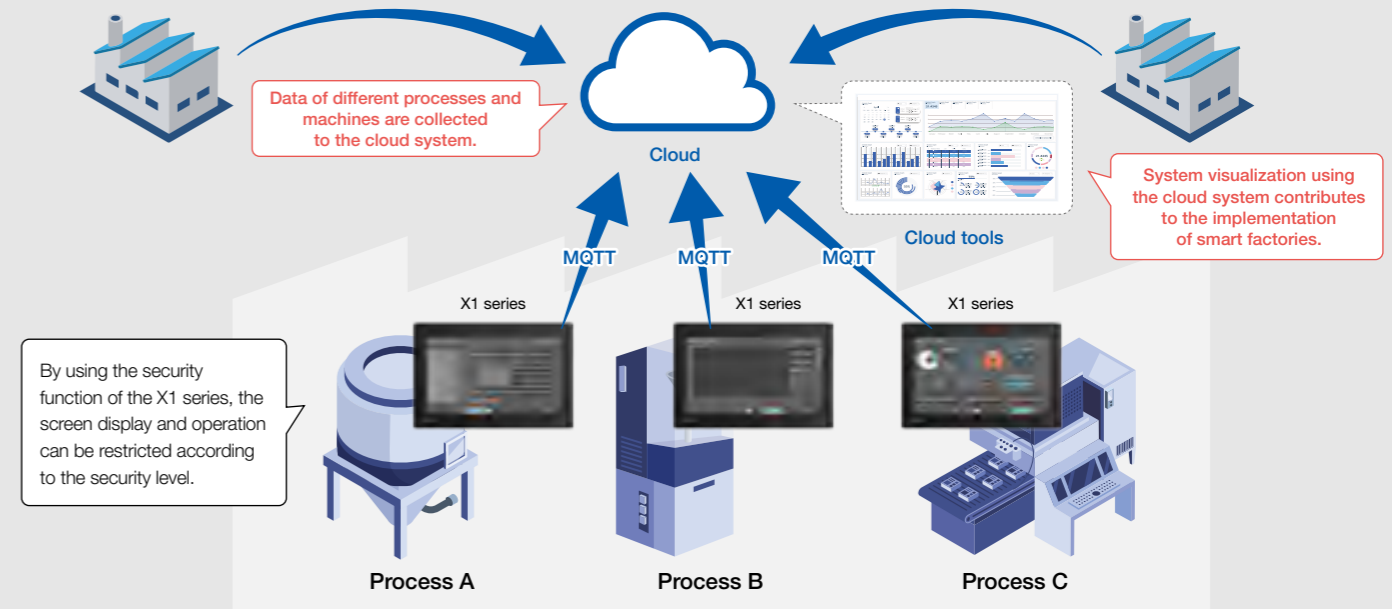

### System configuration

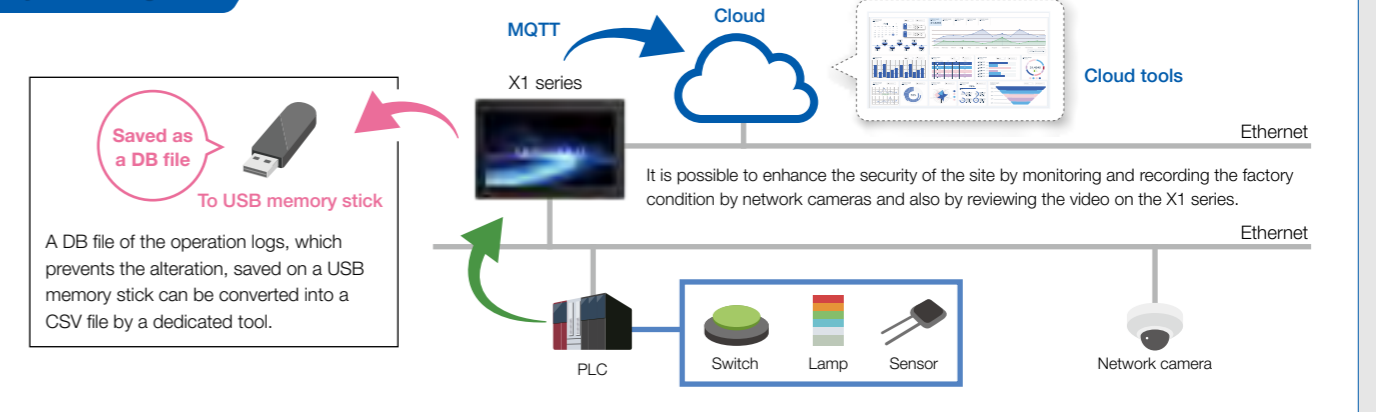

## Operation

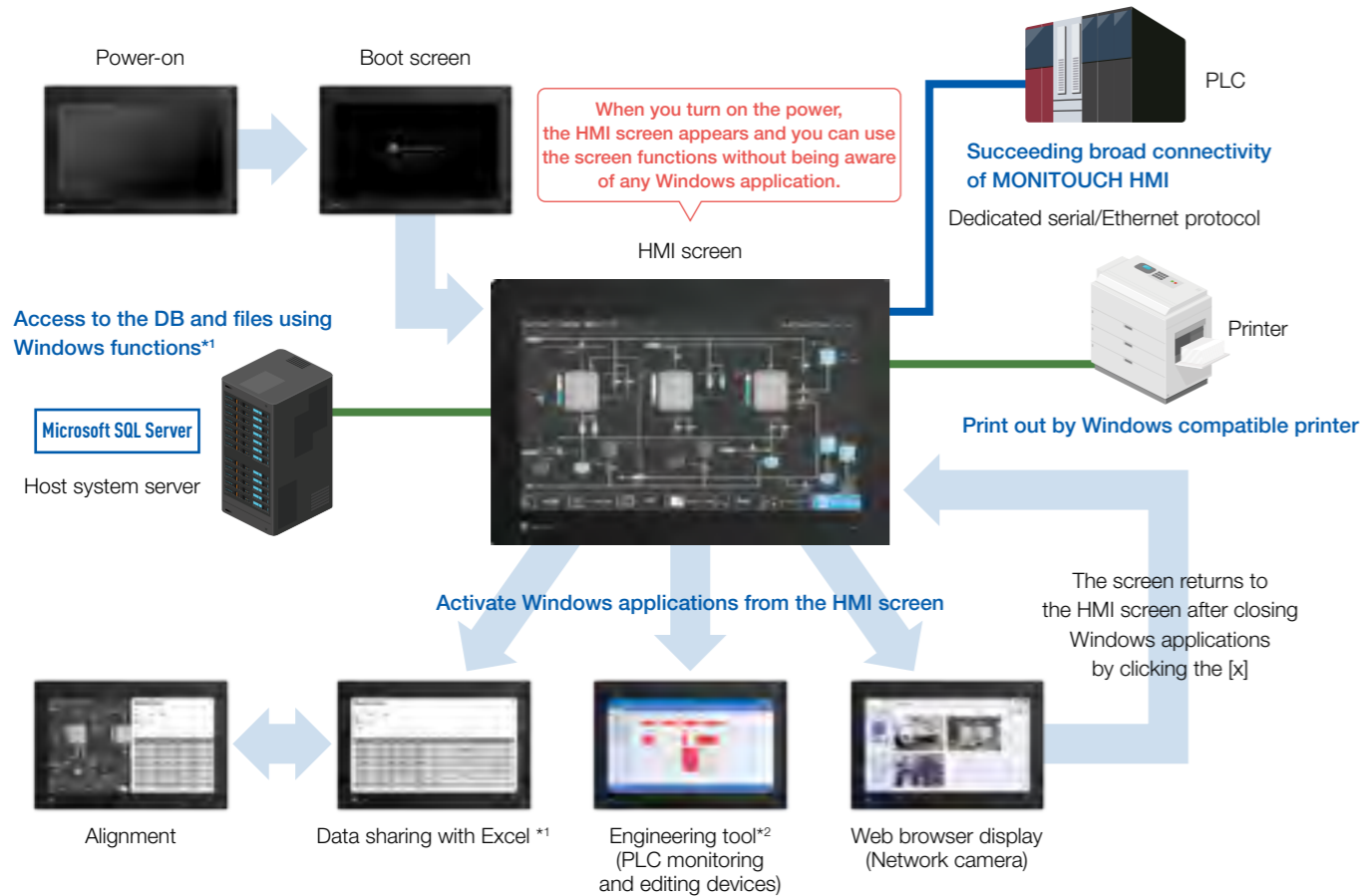

\*1 V-Server (our data collection software) is necessary.  
\*2 Engineering tools of the connected devices are necessary.

## Vector Graphics

Vector graphics enable high quality and tailored screen creation as it allows the enlargement/reduction of parts while maintaining a clear image.

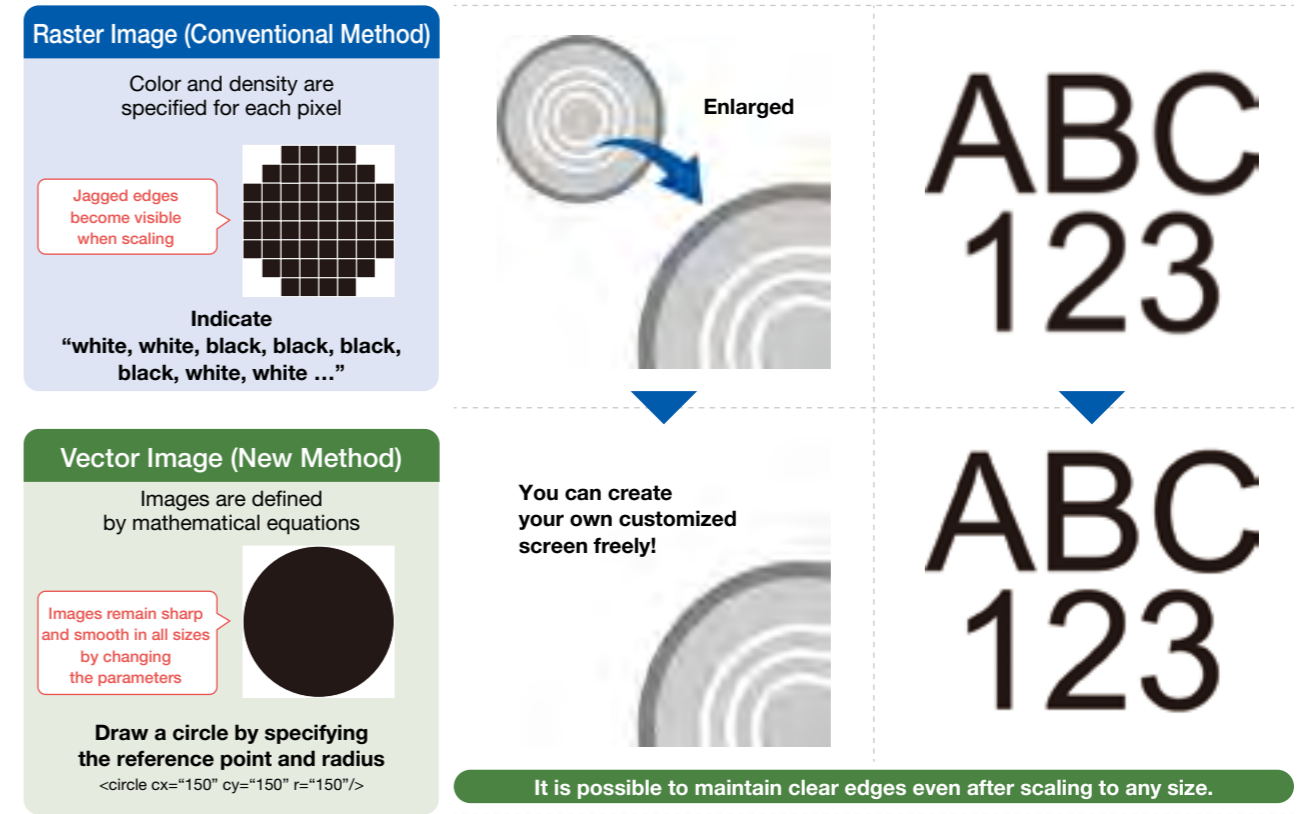

## Application Alignment

Active applications can be aligned by pressing the button without using the keyboard or the mouse. This function helps you to switch multiple application windows easily and improves operability.



## Utilization of User Applications



Windows applications can be freely operated at production sites. Once engineering tools of production machines are installed on the X1 series, it is possible to edit and monitor the program through the X1 series without bringing a PC to the production site.

In addition, it is possible to reduce maintenance tasks and the space required for PCs at the production site by integrating PCs with the X1 series.

The X1 series with Windows applications improve versatility and expandability, as well as functioning of HMIs.

## Standardized Web Browser

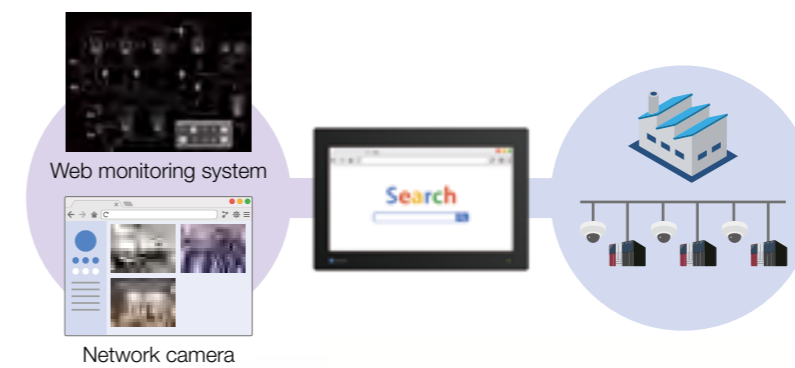

Since the X1 series is equipped with a web browser as standard, it is possible to use the browser function in applications and IT systems.

When combined with a monitoring system or network cameras, it is possible to monitor different machines on the network, and to check each status easily.



# The X1 series with Windows performs as a gateway from the production sites to the IT systems. It contributes to efficient communication between the factory and management office or cloud system.

X1121iSD / X1121iSRD



X1151iSD / X1151iSRD



12.1" wide screen

Resolution: WXGA 1,280 × 800  
Dimensions (W×H×D): 320 × 241 × 66.7 mm

15.6" wide screen

Resolution: FHD 1,920 × 1,080  
Dimensions (W×H×D): 406 × 271 × 68.2 mm

- PCAP (Capacitance)
- 16.7M colors \*1
- Ethernet 2ch
- Wireless LAN \*2
- Bluetooth \*2
- USB-A 3.0x2 2.0x2
- HDMI 1ch
- Serial 1ch
- IP66
- Sound output 1ch

\*1 Only pictures and 3D parts available for HMI screens \*2 Only R-type available

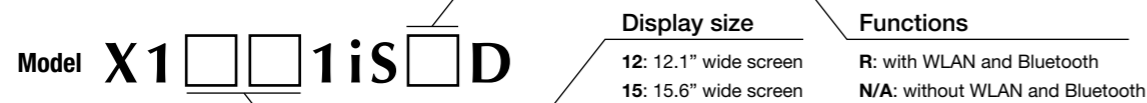

## General Specifications

Item	X1121iSD	X1121iSRD	X1151iSD	X1151iSRD	
Power Supply	Rated Voltage	DC24V			
	Permissible Range of Voltage	±10%			
	Permissible Momentary Power Failure	Within 1ms			
	Power Consumption (Max. Rating)	41W or less		51W or less	
	Rush Current	24A or less, 6ms (Ambient temperature 25°C)			
Insulation Resistance	Between DC external terminal and FG: DC500V 10MΩ or higher				
Physical Environment	Ambient Temperature	0 to 45°C			
	Ambient Humidity	85%RH or less (without dew condensation, max. wet-bulb temperature: 39°C or lower)			
	Operating Altitude	2,000m or less			
	Operating Atmosphere	No exposure to corrosive gas or conductive dust			
	Storage Ambient Temperature	-10 to 60°C			
	Storage Ambient Humidity	85%RH or less (without dew condensation, max. wet-bulb temperature: 39°C or lower)			
Mechanical Operating Conditions	Contamination Level	2			
	Resistance to Oscillation	JIS B 3502 (IEC61131-2) compliant Vibration frequency: 5 to 9 Hz, Half amplitude: 3.5 mm, 9 to 150 Hz, Constant acceleration 9.8 m/s <sup>2</sup> (1G) X, Y, Z: 3 directions (10 times each)			
	Resistance to Shock	JIS B 3502 (IEC61131-2) compliant Peak acceleration: 147 m/s <sup>2</sup> (15G), X,Y,Z: 3 directions, 3 times each (18 times in total)			
Electric Operating Conditions	Resistance to Noise	Noise voltage: 1,000Vp-p, Pulse width: 1μs, Pulse rise time: 1ns (by noise simulator)			
	Resistance to Static Discharge	Complies with IEC61000-4-2, contact: 6kV, air: 8kV			
Installation Conditions	Grounding	D class grounding (3 <sup>rd</sup> -class grounding) FG/SG is internally connected in the X1 series.			
	Protection Structure	Front case: IP66 (when water-proof gasket is used), Rear case: IP20			
	Cooling System	Natural air cooling			
	Dimensions W*H*D (mm)	320 × 241 × 66.7 mm		406 × 271 × 68.2 mm	
	Panel Cutout (mm)	309 × 230 mm		395 × 260 mm	
Case	Weight	Approx. 3.2 kg		Approx. 3.9 kg	
	Color	Black			
	Material	PBT and GF30 resin (front part)			

## Interface

Various interfaces for achieving edge-computing

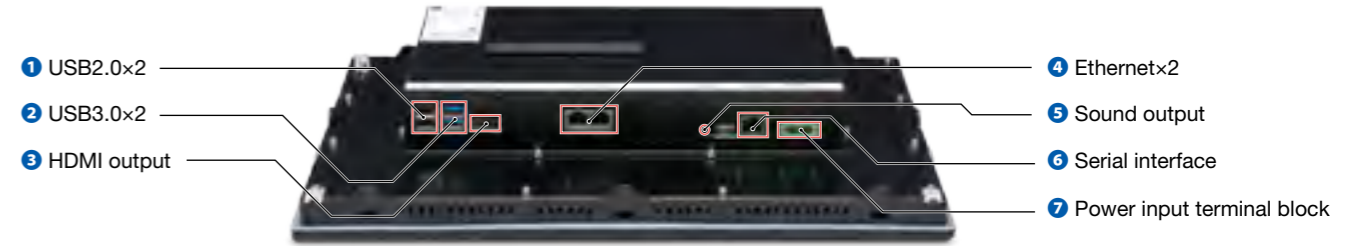

## Dimensions and Panel Cutout

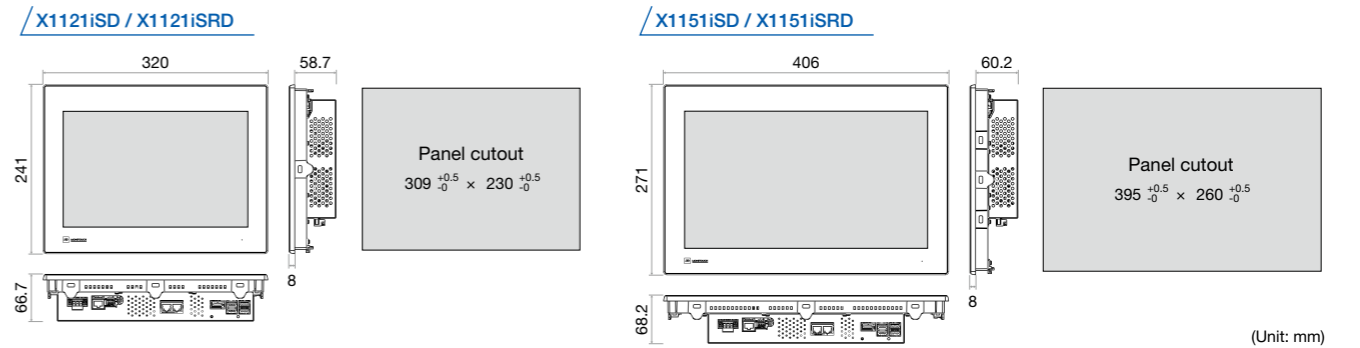

## Performance Specifications

Item	X1121iSD	X1121iSRD	X1151iSD	X1151iSRD	
Hardware	Processor	Intel Atom® x5-E3940			
	Number of Cores / Number of Threads	4/4			
	Main Memory	4GB			
	Internal Storage	64GB (free space 30GB)			
Software	OS	Windows 10 IoT Enterprise 2019 LTSC			
Display	Display Device	TFT color			
	Resolution	WXGA: 1,280 × 800		FHD: 1,920 × 1,080	
	Display Size	12.1" widescreen		15.6" widescreen	
	Colors	16.7 million colors (for HMI screens, pictures and 3D parts only)			
	Contrast Ratio	1,000:1			
	Backlight	LED			
Touch Switch	Backlight Life	Approx. 50,000 hours			
		PCAP (Capacitive type)			
External Interface	Ethernet (RJ-45) × 2	10BASE-T/100BASE-TX/1000BASE-T			
	Serial Port (RJ-45) × 1	Asynchronous: RS-232C/RS-422/RS-485 (switchable) Data length: 7, 8 bits Parity: Even, odd, none Stop bit: 1, 2 bits Baud rate: 4800, 9600, 19200, 38400, 57600, 76800, 115200 bps			
	USB-A Ver. 3.0 × 2	Ver.3.0 (Low speed: 1.5Mbps, Full speed: 12Mbps, High speed: 480Mbps, Super speed: 5.0Gbps)			
	USB-A Ver. 2.0 × 2	Ver.2.0 (Low speed: 1.5Mbps, Full speed: 12Mbps, High speed: 480Mbps)			
	Sound Output (AUDIO) × 1	3.5φ stereo mini jack, line output			
	Wireless LAN (WLAN)	-	1 × WLAN IEEE 802.11 ac/a/b/g/n	-	1 × WLAN IEEE 802.11 ac/a/b/g/n
Clock	Bluetooth	-	1 × Bluetooth	-	
	HDMI	1,280 × 800		1,920 × 1,080	
	Backup Period	3 years (Ambient temperature 25°C)			
Standard	CE Marking	Compatible			
	UL / cUL	UL61010-1/UL61010-2-201			
	KC	Compatible			
	Radio Act	Japan: MIC, USA: FCC, Canada: ISED, Europe: RED, South Korea: KC, Taiwan: NCC			

## Configuration Software

Achieve Sleeker Screens with Simple, Easy-to-Understand Operations



### V-SFT Ver. 6

Computer	PC/AT compatible computer running Windows
OS*	Windows XP/XP 64Edition/Windows Vista(32bit, 64bit)/Windows 7(32bit, 64bit)/Windows 8(32bit, 64bit)/Windows 8.1(32bit, 64bit)/Windows 10(32bit, 64bit)
CPU	Pentium 4 2.0 GHz or higher is recommended
Memory	1.0 GB or higher (2.0 GB or higher is recommended)
Hard disk	When installed: 4.0 GB or higher
Disc drive	DVD-ROM drive
Display	1024 x 768 (XGA) resolution or higher
Display colors	High color (16 bits) or higher
Others	Microsoft .NET Framework 4.0 or 4.5 (Microsoft .NET Framework 4.0 is installed automatically on computers that do not have either Microsoft .NET Framework 4.0 or 4.5 installed.)

\*Administrator privileges are required for installation.

## Vector format SVG parts are installed as standard

Since vector format SVG parts are provided with the unit, image quality is maintained regardless of scaling. Beautiful high quality screens can be created.



## Product List

Model	Display Size	Resolution	Specifications		
			Touch Switch	Wireless LAN	Bluetooth
X1121SD	12.1" wide screen	1,280 x 800	PCAP (Capacitive type)	-	-
X1121SRD				✓	✓
X1151SD	15.6" wide screen	1,920 x 1,080	PCAP (Capacitive type)	-	-
X1151SRD				✓	✓

## Optional Accessories List

Model	Description
V-SFT-6	Configuration software for MONITOUCH Ver.6
X1-BT	Replacement lithium battery for X1 series
X1-SS	Security software for X1 series

## System Configuration

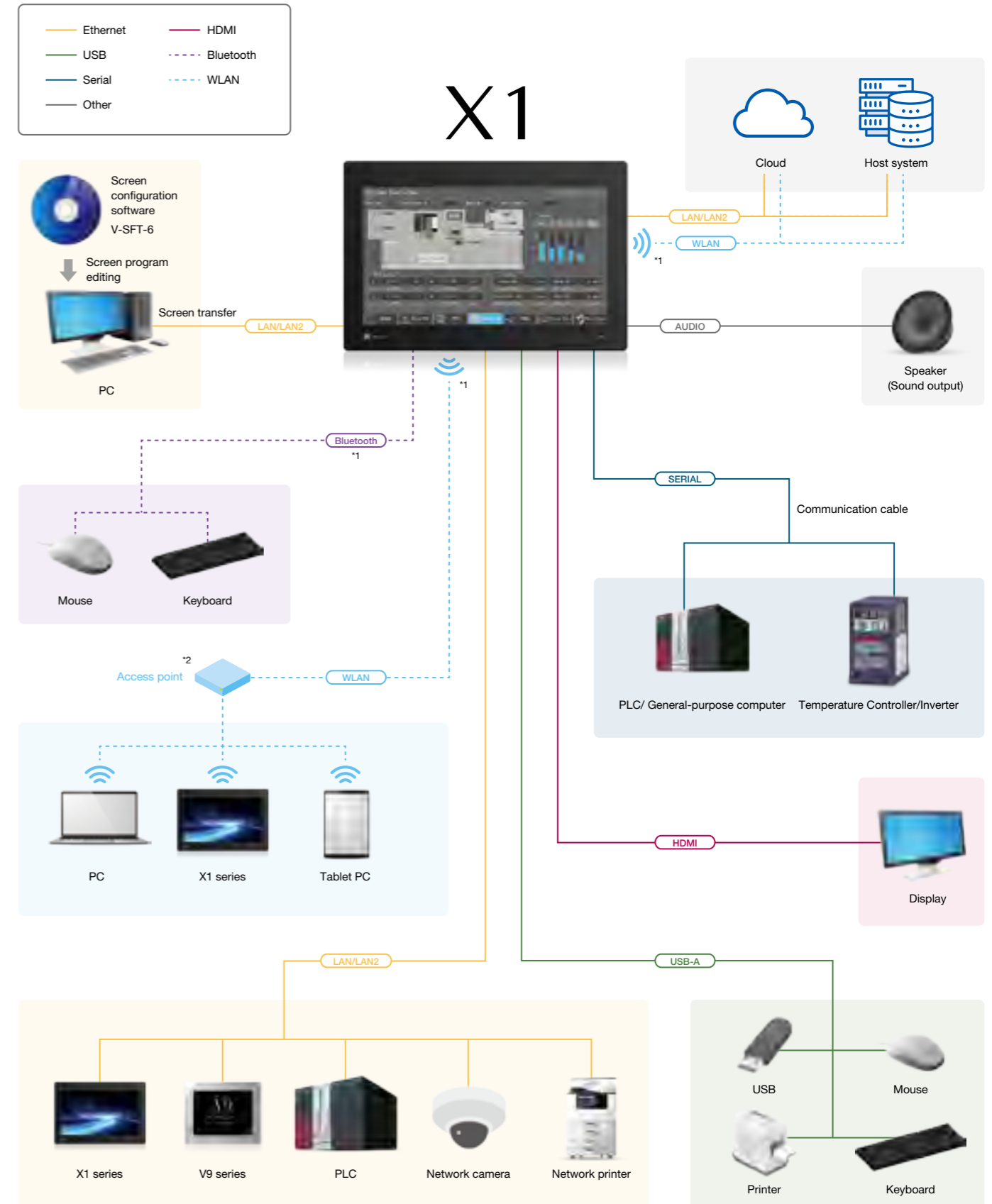

\*1 Models with wireless LAN and Bluetooth only.

\*2 An access point is necessary.

Industry-leading number of connectable equipment

\* According to our own research

# Outstanding connectability with multiple devices for simultaneous communication and data transfer

## PLC Connection

Manufacturer	Models
Fuji Electric	MICREX-F series MICREX-F series V4 Compatible SPB(N mode)&FLEX-PC series SPB(N mode)&FLEX-PC CPU MICREX-SX SPH/SPB/SPM/SPE/SPF series MICREX-SX SPH/SPB/SPM/SPE/SPF CPU MICREX-SX(Ethernet)
Allen-Bradley	PLC-5 PLC-5(Ethernet) SLC500 SLC500(Ethernet TCP/IP) NET-ENI(SLC500 Ethernet TCP/IP) NET-ENI(MicroLogix Ethernet TCP/IP) Micro Logix Micro Logix(Ethernet TCP/IP) Control Logix/Compact Logix Control Logix(Ethernet) Micro800 Controllers Micro800 Controllers(Ethernet TCP/IP)
Automationdirect	Direct LOGIC(K-Sequence) Direct LOGIC(Ethernet UDP/IP) Direct LOGIC(Modbus RTU)
Azbil	MX series
Baumüller	Bmx-x-PLC
Beckhoff	ADS Protocol(Ethernet) Tag ADS Protocol(Ethernet TCP/IP)
CIMON	BP Series CP Series XP Series S Series S Series(Ethernet) CP3E
DELTA	DVP series DVP-SE(MODBUS ASCII) DVP-SE(MODBUS TCP/IP)
EATON Outler-Hammer	ELC
EMERSON	EC10/EC20/EC20H (MODBUS RTU)
FANUC	Power Mate
FATEK AUTOMATION	FACON FB series FACON FBs series(Ethernet)
FESTO	FEC
FUFENG	APC Series Controller
GE Fanuc	90 series 90 series(SNP-X) 90 series(SNP) 90 series(Ethernet TCP/IP) FX3(Ethernet TCP/IP) HIDIC-S10/2alpha.S10mini HIDIC-S10/2alpha.S10mini(Ethernet) HIDIC-S10/4alpha HIDIC-S10V
Hitachi	HIDIC-S10V(Ethernet)
Hitachi Industrial Equipment Systems	HIDIC-H (Ethernet) HIDIC-EHV(Ethernet)
HYUNDAI	H15 Robot(MODBUS RTU) H14 Robot(MODBUS RTU)
IDEC	MICRO3 MICRO Smart MICRO Smart Penra MICRO Smart(Ethernet TCP/IP)
JTEKT	TOYOPUC TOYOPUC(Ethernet) TOYOPUC(Ethernet PC10Mode) TOYOPUC-Plus TOYOPUC-Plus(Ethernet) TOYOPUC-Nano(Ethernet)
KEYENCE	KZ series link KZ/KV series CPU KZ24/300 CPU KV10/24 CPU KV-700 KV-700(Ethernet TCP/IP) KV-1000 KV-1000(Ethernet TCP/IP) KV-3000/5000

Manufacturer	Models
KEYENCE	KV-3000/5000(Ethernet TCP/IP) KV-7000(Ethernet TCP/IP) KV Nano KV Nano(Ethernet TCP/IP)
KOYO ELECTRONICS	SU/SG SR-T(K prt) SU/SG(K-Sequence) SU/SG(Modbus RTU)
LS	MASTER-KxxxS MASTER-KxxxS CNET MASTER-K series(Ethernet) GLOFA CNET GLOFA GM7 CNET GLOFA GM series CPU GLOFA GM series(Ethernet UDP/IP) XGT/XGK series CNET XGT/XGK series CPU XGT/XGK series(Ethernet) XGT/XGI series CNET XGT/XGI series CPU XGT/XGI series(Ethernet)
MITSUBISHI ELECTRIC	A series link QnA series link QnA series(Ethernet) QnH(Q) series link QnH(Q) series CPU QnU series CPU Q00J/00/01 CPU QnH(Q) series(Ethernet) QnH(Q) series link (Multi CPU) QnH(Q) series (Multi CPU) (Ethernet) QnH(Q) series CPU (Multi CPU) QnH(Q) series(Ethernet ASCII) QnH(Q) series (Multi CPU) (Ethernet ASCII) QnU series(Built-in Ethernet) QnU series (Multi CPU) (Built-in Ethernet)
MODICON	Modbus RTU
MOELLER	PS4
OMRON	SYSMAC C SYSMAC CV SYSMAC CS1/CJ1/CJ2 SYSMAC CS1/CJ1/CJ2 DNA SYSMAC CS1/CJ1/CJ2/CP series(Ethernet) SYSMAC CS1/CJ1/CJ2/CP series(Ethernet Auto) SYSMAC CS1/CJ1/CJ2/CP series DNA(Ethernet) NJ Series(EtherNet/IP) FP Series(RS232C/422) FP Series(TCP/IP) FP Series(UDP/IP) FP-X(TCP/IP) FP7 Series(RS232C/422) FP7 Series(Ethernet)
Panasonic	FP Series(TCP/IP) FP Series(UDP/IP) FP-X(TCP/IP) FP7 Series(RS232C/422) FP7 Series(Ethernet)
RS Automation	NX7/NX Plus Series(70P/700P/CCU+) N7/NX Series(70/700/750/CCU) NX700 Series(Ethernet) X8 Series X8 Series(Ethernet)
SAIA	PCD S-BUS(Ethernet)
SAMSUNG	SPC series N_plus

### As of the product release date

Manufacturer	Models
SAMSUNG	SENET
SHARP	JW series JW100/70H COM port JW20 COM port JW series(Ethernet) JW300 series JW311/312/321/322 series(Ethernet) JW331/332/341/342/352/362 series(Ethernet)
SINFONIA TECHNOLOGY	SELMART
Siemens	S5 PG port S7 S7-200(Ethernet ISOTCP) S7-300/400(Ethernet ISOTCP) S7-300/400(Ethernet TCP/IP PG protocol) S7-1200/1500(Ethernet ISOTCP) S7-1200/1500 Tag(Ethernet ISOTCP) LOGO(Ethernet ISOTCP) TI500/505 TI500/505 V4 Compatible
TECO	TP03(MODBUS RTU)
TOSHIBA	T series/V series(T compatible) T series/V series(T compatible)(Ethernet UDP/IP) EX series rv series(Ethernet UDP/IP)
TOSHIBA MACHINE	TC200
TOYO DENKI	μGPCsx series μGPCsx CPU μGPCsx series(Ethernet)
TURCK	BL Series Distributed I/O(MODBUS TCP/IP)
Ultra Instruments	UIC CPU(MODBUS ASCII)
UNITRONICS	M90/M91/Vision Series(ASCII) Vision Series(ASCII Ethernet TCP/IP)
VIGOR	M series
XINJE	XC Series(MODBUS RTU)
Yaskawa Electric	MEMOBUS CP9200SH/MP900 MP2300(MODBUS TCP/IP) CP/MP EXPANSION MEMOBUS (UDP/IP) MP2000 series MP2000 series(UDP/IP) MP3000 series MP3000 series (Ethernet UDP/IP) MP3000 series EXPANSION MEMOBUS (Ethernet)
Yokogawa Electric	FA-M3 FA-M3R FA-M3/FA-M3R(Ethernet UDP/IP) FA-M3/FA-M3R(Ethernet UDP/IP ASCII) FA-M3/FA-M3R(Ethernet TCP/IP) FA-M3/FA-M3R(Ethernet TCP/IP ASCII) FA-M3V FA-M3V(Ethernet ) FA-M3V(Ethernet ASCII)
WAGO	750 series(MODBUS RTU) 750 series(MODBUS Ethernet)
3S-Smart Software Solutions	CODESYS V3(Ethernet)
Others	Universal Serial Without PLC connection MODBUS RTU MODBUS RTU EXT Format MODBUS TCP/IP(Ethernet) MODBUS TCP/IP(Ethernet)Sub Station MODBUS TCP/IP(Ethernet) EXT Format MODBUS ASCII Modbus slave(RTU) Modbus slave(TCP/IP) Modbus slave(ASCII) V-Link OPC UA TCP/IP(Ethernet)

## Temperature controller / Servo / Inverter Connection

### As of the product release date

Manufacturer	Models
Fuji Electric	PYX(MODBUS RTU) PXR(MODBUS RTU) PXF(MODBUS RTU) PXG(MODBUS RTU) PXH(MODBUS RTU) PUM(MODBUS RTU) F-MPC04P(Loader) F-MPC Series /FePSU FVR-E11S FVR-E11S(MODBUS RTU) FVR-C11S(MODBUS RTU) FRENIC5000G11S/P11S FRENIC5000G11S/P11S(MODBUS RTU) FRENIC5000V7S(MODBUS RTU) FRENIC-Ace(MODBUS RTU) FRENIC-Eco(MODBUS RTU) FRENIC-HVAC/AQUA(MODBUS RTU) FRENIC MEGA(MODBUS RTU) FRENIC MEGA SERVO(MODBUS RTU) FRENIC-Mini(MODBUS RTU) FRENIC-Multi(MODBUS RTU) FRENIC-VG1(MODBUS RTU) FRENIC Series (Loader) HFR-C9K HFR-C11K HFR-K1K PPMC(MODBUS RTU) FALDIC-alpha series FALDIC-W series PH series PHR(MODBUS RTU) WA5000 APR-NI(MODBUS RTU) ALPHA5 (MODBUS RTU) ALPHA5 Smart (MODBUS RTU) ALPHA7 (MODBUS RTU) WE1MA(Ver.A)(MODBUS RTU) WE1MA(Ver.B)(MODBUS RTU) WSZ series WSZ series(Ethernet)
Agilent	4263 Series
Azbil	SDC10 SDC15 SDC20 SDC21 SDC25/26 SDC30/31 SDC35/36 SDC45/46 SDC40A SDC40G DMC10 DMC50(COM) AHC2001 AHC2001+DCP31/32 DCP31/32 NX(CPL) NX(Modbus RTU) NX(Modbus TCP/IP) NX(Modbus TCP/IP)
A&D	AD4402(MODBUS RTU) AD4404(MODBUS RTU)
Banner	PresencePLUS(Ethernet/IP(TCP/IP))
Bosch Rexroth	LT400 Series(MODBUS RTU)
CHINO	DP1000 DB1000B(MODBUS RTU) KR2000(MODBUS RTU) LT2300(MODBUS RTU) LT3000(MODBUS RTU) LT830(MODBUS RTU)
DELTA TAU DATA SYSTEMS	PMAC PMA(Ethernet TCP/IP)
Gammaflux	TTC2100 G24(Ethernet TCP/IP)

Manufacturer	Models
Hitachi Industrial Equipment Systems	SJ300 series SJ700 series SJ Series P1(MODBUS RTU)
IAI	X-SEL Controller ROBO CYLINDER(RCP2/ERC) ROBO CYLINDER(RCS/E-CON) PCON/ACON/SCON(MODBUS RTU)
KEYENCE	DL-RS1A(SK-1000)
Koatsu Gas Kogyo	R-BLT
Koganei	IBFL-TC
Lenze	Servo Drive 9400(Ethernet TCP/IP)
MITSUBISHI ELECTRIC	FR-500 FR-V500 MR-J2S-A MR-J2S-CL MR-J3-A MR-J3-T MR-J4-A FR-E700
MOOG	J124-04x series
M-SYSTEM	R1M series (MODBUS RTU)
NITTOKU	ITS-HRW110
OMRON	E5AK E5AK-T E5AN/E5EN/E5CN/E5GN E5AR/E5ER E5CC/E5EC/E5AC/E5DC/E5GC E5CK E5CK-T E5CN-HT E5EK E5ZD E5ZE E5ZN V600/620/680 KM20 KM100 V680S(Ethernet TCP/IP) EJ1
Orientalmotor	High-efficiency AR Series(MODBUS RTU) CRK Series(MODBUS RTU)
Panasonic	MINAS A4 Series LP-400 LP-RF series LP-RF series(Ethernet) KW Series
RKC	SR-Mini(MODBUS RTU) CB100/CB400/CB500/CB700/CB900(MODBUS RTU) SR-Mini(Standard Protocol) REX-F400/F700/F900(Standard Protocol) REX-F9000(Standard Protocol) SRV(MODBUS RTU) MA900/MA901(MODBUS RTU) SRZ(MODBUS RTU) FB100/FB400/FB900(MODBUS RTU)
RS Automation	CSD5(MODBUS RTU) Moscon-F50(MODBUS RTU)
SANMEI	Cuty Axis
SanRex	DC AUTO (HKD type)
SHARP	DS-30D DS-32D
SHIMADEN	Shimaden Standard Protocol
SHINKO TECHNOS	C Series FC Series GC Series DCL-33A JCx-300 Series PC-900 PCD-33A ACS-13A ACD/ACR Series WCL-13A
Siemens	S120(Ethernet ISOTCP)
SUS	XA-A*

Manufacturer	Models
TOHO	TTM-000 TTM-00BT TTM-200(MODBUS RTU)
TOKIO CHOKUJYU PRODUCTS	MB3315/1010
TOSHIBA	VF-S7 VF-S9 VF-S11 VF-S15 VF-A7 VF-AS1 VF-P7 VF-PS1 VF-FS1 VF-MB1 VF-nc1 VF-nc3
TOSHIBA MACHINE	VELCONIC Series
ULVAC	G-TRAN Series
UNIPULSE	F340A F371 F800 F720A F805A
YAMAHA	RXC142
Yaskawa Electric	DX200(High-Speed Ethernet)
Yokogawa Electric	UT100 UT750 UT550 UT520 UT350 UT320 UT2400/2800 UT450 UT32A/35A(MODBUS RTU) UT52A/55A(MODBUS RTU) UT75A(MODBUS RTU) μR10000/20000(Ethernet TCP/IP)
Others	MODBUS RTU MODBUS TCP/IP (Ethernet)



# Worldwide service network for trouble-free operations

TEL

TEL **+81-76-274-2144**

FAX

FAX **+81-76-274-5136**

E-mail

 [sales@hakko-elec.co.jp](mailto:sales@hakko-elec.co.jp)

WEB

[www.monitouch.com](http://www.monitouch.com)

Global Sales Network

Our distributors are ready to support your worldwide business.

[www.monitouch.com/site/distributors-e/distributors-oversea-01.html](http://www.monitouch.com/site/distributors-e/distributors-oversea-01.html)



To the purchasers:

The warranty of this product is as follows, unless there are special instructions that state otherwise in the quote, contract, catalog, or specifications at the time of the quote or order.

The purpose or area of use may be limited, and a routine checkup may be required depending on the product. Please contact the distributor from which you purchased the product, or Fuji Electric/Hakko Electronics for further information.

Please conduct inspection of the product promptly upon purchase or delivery. Also, please give sufficient consideration to management and maintenance of the product prior to accepting it.

## 1 Period and Coverage of the Warranty

### 1-1 Period

- (1) The period of the warranty is effective until twenty-four (24) months from the date of manufacture printed on the plate.
- (2) The above period may not be applicable if the particular environment, conditions or frequency of use affects the lifetime of the product.
- (3) The warranty for the parts repaired by our service department is effective for six (6) months from the date of repair.

### 1-2 Coverage

- (1) If malfunction occurs during the period of warranty due to negligence on the part of Fuji Electric/Hakko Electronics, the malfunctioning parts are exchanged or repaired free of charge at the point of purchase or delivery. However, the warranty does not apply to the following cases:
  - 1) The malfunction occurs due to inappropriate conditions, environment, handling or usage that is not specified in the catalog, instruction book or users' manual.
  - 2) The malfunction is caused by factors that do not originate in the purchased or delivered product.
  - 3) The malfunction is caused by another device or software design that does not originate in a Fuji Electric/Hakko Electronics product.
  - 4) The malfunction occurs due to an alteration or repair that was not performed by Fuji Electric/Hakko Electronics.
  - 5) The malfunction occurs because the expendable parts listed in the instruction book or catalog were not maintained or replaced in an appropriate manner.
  - 6) The malfunction occurs due to factors that were not foreseeable by the practical application of science and technology at the time of purchase or delivery.
  - 7) The malfunction occurs because the product is used for a purpose other than that for which it is intended.
  - 8) The malfunction occurs due to a disaster or natural disaster that Fuji Electric/Hakko Electronics are not responsible for.
- (2) The warranty is only applicable to the single purchased and delivered product.
- (3) The warranty is only valid for the conditions stated in (1) above. Any damage induced by the malfunction of the purchased or delivered product, including damage or loss to a device or machine and passive damage, is not covered by the warranty.

### 1-3 Malfunction Diagnosis

The initial diagnosis of malfunction is to be made by the purchaser. The diagnosis can be conducted by Fuji Electric/Hakko Electronics or our delegated service provider with due charge upon the request of the purchaser. The charge is to be paid by the purchaser at the rate stipulated in the rate schedule of Fuji Electric/Hakko Electronics.

## 2 Liability for Opportunity Loss

Regardless of the time of occurrence, Fuji Electric/Hakko Electronics are not liable for damage caused by factors that Fuji Electric/Hakko Electronics are not responsible for, opportunity loss on the part of the purchaser caused by the malfunction of a Fuji Electric/Hakko Electronics product, passive damage, damage due to a special situation regardless of whether it was foreseeable or not, or secondary damage, accident compensation, damage to products that were not manufactured by Fuji Electric/Hakko Electronics, or compensation towards other operations.

## 3 Period for Repair and Provision of Spare Parts after Production is Discontinued (Maintenance Period)

Discontinued models (products) can be repaired for seven (7) years from the date of discontinuation. Also, most spare parts used for repair are provided for seven (7) years from the date of discontinuation. However, some electric parts may not be available due to their short life cycle. In this case, it may be difficult to repair or provide the parts during the seven-year period. Please contact Fuji Electric/Hakko Electronics or our service providers for further information.

## 4 Delivery

Standard products that do not entail application setting or adjustment are regarded as received by the purchaser upon delivery. Fuji Electric/Hakko Electronics are not responsible for local adjustments and test runs.

## 5 Service

The price of the delivered or purchased products does not include the service fee for the technician. Please contact Fuji Electric/Hakko Electronics or our service providers for further information.

## 6 Scope of Application

The above contents shall be assumed to apply to transactions and product use in the country where a Fuji Electric/Hakko Electronics product is purchased. Please consult your local supplier or Fuji Electric/Hakko Electronics for details.

### Operating system and performance guarantee



- The X1 series is equipped with Microsoft's Windows 10 IoT Enterprise 2019 LTSC. Fuji Electric/Hakko Electronics shall not be held responsible for any damages resulting from problems caused by Microsoft products. For problems and specifications of Microsoft products, refer to Microsoft's user manual or contact Microsoft support in your country.
- You can operate your own Windows applications on the X1 series. However, we will not guarantee the performance of applications installed by the customer. Please use them after verifying the performance.



## Safety Considerations

- For safe operation, read the instruction manual or user manual that comes with the product carefully or consult the distributor from which you purchased the product, before using the product.
- Products introduced in this catalog have not been designed or manufactured for such applications in a system or equipment that will affect human bodies or lives.
- Customers, who want to use the products introduced in this catalog for special systems or devices such as for atomic-energy control, aerospace use, medical use, passenger vehicle, and traffic control, are requested to consult the Hakko Overseas Sales Section.
- Customers are requested to prepare safety measures when they apply the products introduced in this catalog to such systems or facilities that will affect human lives or cause severe damage to property if the products become faulty.
- For safe operation, wiring should be conducted only by qualified engineers who have sufficient technical knowledge about electrical work or wiring.

## Notes to consider before purchasing

- Appearance and specifications are subject to modification without prior notice due to technical improvements.
- Colors in the catalog may differ from the actual colors due to printing inaccuracies.
- Consult your distributor or us for further information about products in this catalog.

# www.monitouch.com

Sales company :

**Fuji Electric Co., Ltd.**

URL : [www.fujielectric.com/](http://www.fujielectric.com/)

Gate City Ohsaki, East Tower,  
11-2, Osaki 1-chome, Shinagawa-ku,  
Tokyo 141-0032, Japan

Phone : +81-3-5435-7066

Fax : +81-3-5435-7475

Manufacturer :

**Hakko Electronics Co., Ltd.**

URL : [www.monitouch.com/](http://www.monitouch.com/)

890-1 Kamikashiwano-machi,  
Hakusan, Ishikawa 924-0035, Japan

Phone : +81-76-274-2144

Fax : +81-76-274-5136

E-mail : [sales@hakko-elec.co.jp](mailto:sales@hakko-elec.co.jp)

Distributor

- \* Product specifications and design are subject to modification.
- \* Combined images are used for the screen images.
- \* Product colors may differ from colors in brochure photos due to printing.
- \* Windows and Excel are trademarks of Microsoft (USA) in the U.S. and other countries.
- \* Other company and product names in this brochure are registered trademarks.