

Record of Revisions

Reference numbers are shown at the bottom left corner on the back cover of each manual.

Printing Date	Reference No.	Revised Contents
January, 2015	1072NE0	First edition

Preface

Thank you for selecting the MONITOUCH V9 series.

For correct setup of the V9 series, you are requested to read through this manual to understand more about the product.

For details on other operating procedures for the V9 series, refer to the following related manuals.

Manual Name	Contents	Reference No.
V9 Series Operation Manual	Explains the operation of V-SFT version 6, important points when using the editor, and provides an overview on configuring screens.	1072NE
V9 Series Reference Manual [1]	Explains the functions and operation of the V9 series.	1065NE
V9 Series Reference Manual [2]		1066NE
V9 Series Setup Manual	Explains the installation procedure of V-SFT version 6, the creation process of simple screen programs as well as how to transfer a created screen program using V-SFT version 6.	1067NE
V9 Series Troubleshooting/Maintenance Manual	Provides an error list and explains the operating procedures for the V9 series.	1068NE
V9 Series Training Manual Beginner's Guide	Explains the screen configuration process for the V9 series using V-SFT version 6 with examples.	1069NE
V9 Series Training Manual Practical Guide		1070NE
V9 Series Macro Reference	Provides an overview of macros of V-SFT version 6 and explains macro editor operations and macro command descriptions in detail.	1071NE
V9 Series Operation Manual	Explains the configuration of V-SFT version 6, the editing process of each part and limitations regarding operation in detail.	1072NE
V9 Series Hardware Specifications	Explains hardware specifications and precautions when handling the V9 series.	2023NE
V9 Series Connection Manual [1]	Explains the connection and communication parameters for the V9 series and controllers in detail. Included Makers ALLEN BRADLEY, Automationdirect, Azbil, Baumuller, BECKHOFF, CHINO, CIMON, DELTA, DELTA TAU DATA SYSTEMS, EATON Cutler-Hammer, EMERSON, FANUC, FATEK AUTOMATION, FUFENG, Fuji Electric, Gammaflux, GE Fanuc, Hitachi, Hitachi Industrial Equipment Systems	2210NE
V9 Series Connection Manual [2]	Explains the connection and communication parameters for the V9 series and controllers in detail. Included Makers IAI, IDEC, JTEKT, KEYENCE, KOGANEI, KOYO ELECTRONICS, LS, MITSUBISHI ELECTRIC, MODICON, MOELLER, M-SYSTEM, OMRON, Oriental Motor, Panasonic, RKC, RS Automation	2211NE
V9 Series Connection Manual [3]	Explains the connection and communication parameters for the V9 series and controllers in detail. Included Makers SAIA, SAMSUNG, SanRex, SANMEI, SHARP, SHIMADEN, SHINKO TECHNOS, Siemens, SINFONIA TECHNOLOGY, TECO, Telemecanique, TOHO, TOSHIBA, TOSHIBA MACHINE, TURCK, UNIPULSE, UNITRONICS, VIGOR, WAGO, XINJE, YAMAHA, Yaskawa Electric, Yokogawa Electric, MODBUS, Barcode Reader, Slave Communication Function, Universal Serial Communication	2212NE

For details on devices including PLCs, inverters, and temperature controllers, refer to the manual for each device.

Notes:

1. This manual may not, in whole or in part, be printed or reproduced without the prior written consent of Hakko Electronics Co., Ltd.
2. The information in this manual is subject to change without prior notice.
3. Windows, Excel, and Word are registered trademarks of Microsoft Corporation in the United States and other countries.
4. All other company names or product names are trademarks or registered trademarks of their respective holders.
5. This manual is intended to give accurate information about MONITOUCH hardware. If you have any questions, please contact your local distributor.

Notes on Safe Usage of MONITOUCH

In this manual, you will find various notes categorized under the following levels with the signal words "DANGER" and "CAUTION".

 **DANGER** Indicates an imminently hazardous situation which, if not avoided, will result in death or serious injury.

 **CAUTION** Indicates a potentially hazardous situation which, if not avoided, may result in minor or moderate injury and could cause property damage.

Note that there is a possibility that items listed with  **CAUTION** may have serious ramifications.

DANGER

- Never use the output signal of the V9 series for operations that may threaten human life or damage the system, such as signals used in case of emergency. Please design the system so that it can cope with a touch switch malfunction. A touch switch malfunction may result in machine accidents or damage.
- Turn off the power supply when you set up the unit, connect new cables, or perform maintenance or inspections. Otherwise, electrical shock or damage may occur.
- Never touch any terminals while the power is on. Otherwise, electrical shock may occur.
- You must cover the terminals on the unit before turning the power on and operating the unit. Otherwise, electrical shock may occur.
- The liquid crystal in the LCD panel is a hazardous substance. If the LCD panel is damaged, do not ingest the leaked liquid crystal. If leaked liquid crystal makes contact with skin or clothing, wash it away with soap and water.
- Never disassemble, recharge, deform by pressure, short-circuit, reverse the polarity of the lithium battery, nor dispose of the lithium battery in fire. Failure to follow these conditions will lead to explosion or ignition.
- Never use a lithium battery that is deformed, leaking, or shows any other signs of abnormality. Failure to follow these conditions will lead to explosion or ignition.
- Switches on the screen are operable even when the screen has become dark due to a faulty backlight or when the backlight has reached the end of its service life. If the screen is dark and hard to see, do not touch the screen. Otherwise, a malfunction may occur resulting in machine accidents or damage.

CAUTION

- Check the appearance of the unit when it is unpacked. Do not use the unit if any damage or deformation is found. Failure to do so may lead to fire, damage, or malfunction.
- For use in a facility or as part of a system related to nuclear energy, aerospace, medical, traffic equipment, or mobile installations, please consult your local distributor.
- Operate (or store) the V9 series under the conditions indicated in this manual and related manuals. Failure to do so could cause fire, malfunction, physical damage, or deterioration.
- Observe the following environmental restrictions on use and storage of the unit. Otherwise, fire or damage to the unit may result.
 - Avoid locations where there is a possibility that water, corrosive gas, flammable gas, solvents, grinding fluids, or cutting oil can come into contact with the unit.
 - Avoid high temperatures, high humidity, and outside weather conditions, such as wind, rain, or direct sunlight.
 - Avoid locations where excessive dust, salt, and metallic particles are present.
 - Avoid installing the unit in a location where vibrations or physical shocks may be transmitted.
- Equipment must be correctly mounted so that the main terminal of the V9 series will not be touched inadvertently. Otherwise, an accident or electric shock may occur.
- Tighten the mounting screw on the fixtures of the V9 series to an equal torque of 0.6 N·m. Excessive tightening may distort the panel surface. Loose mounting screws may cause the unit to fall down, malfunction, or short-circuit.
- Check periodically that terminal screws on the power supply terminal block and fixtures are firmly tightened. Loosened screws or nuts may result in fire or malfunction.
- Tighten the terminal screws on the power supply terminal block of the V9 series to an equal torque of 7.1 to 8.8 inch-lbf (0.8 to 1.0 N·m). Improper tightening of screws may result in fire, malfunction, or other serious trouble.
- The V9 series has a glass screen. Do not drop the unit or impart physical shocks to the unit. Otherwise, the screen may be damaged.
- Correctly connect cables to the terminals of the V9 series in accordance with the specified voltage and wattage. Overvoltage, overwattage, or incorrect cable connection could cause fire, malfunction, or damage to the unit.
- Always ground the V9 series. The FG terminal must be used exclusively for the V9 series with the level of grounding resistance less than 100 Ω. Otherwise, you may sustain an electric shock, a fire may occur, MONITOUCH may not recognize touch operations, and malfunctions may occur.
- Prevent any conductive particles from entering the V9 series. Failure to do so may lead to fire, damage, or malfunction.
- After wiring is finished, remove the paper used as a dust cover before starting operation of the V9 series. Operation with the dust cover attached may result in accidents, fire, malfunction, or other trouble.

CAUTION

- Do not attempt to repair the V9 series yourself. Contact Hako Electronics or the designated contractor for repairs.
- Do not repair, disassemble, or modify the V9 series. Hako Electronics Co., Ltd. is not responsible for any damages resulting from repair, disassembly, or modification of the unit that was performed by an unauthorized person.
- Do not use sharp-pointed tools to press touch switches. Doing so may damage the display unit.
- Only experts are authorized to set up the unit, connect cables, and perform maintenance and inspection.
- Lithium batteries contain combustible material such as lithium and organic solvents. Mishandling may cause heat, explosion, or ignition resulting in fire or injury. Read the related manuals carefully and correctly handle the lithium battery as instructed.
- Take safety precautions during operations such as changing settings when the unit is running, forced output, and starting and stopping the unit. Any misoperations may cause unexpected machine movement, resulting in machine accidents or damage.
- In facilities where the failure of the V9 series could lead to accidents that threaten human life or other serious damage, be sure that such facilities are equipped with adequate safeguards.
- When disposing of the V9 series, it must be treated as industrial waste.
- Before touching the V9 series, discharge static electricity from your body by touching grounded metal. Excessive static electricity may cause malfunction or trouble.
- Insert an SD card into MONITOUCH in the same orientation as pictured on the unit. Failure to do so may damage the SD card or the slot on the unit.
- The SD card access LED flashes red when the SD card is being accessed. Never remove the SD card or turn off power to the unit while the LED is flashing. Doing so may destroy the data on the SD card. Check that the LED has turned off before removing the SD card or turning off the power to the unit.
- Be sure to remove the protective sheet that is attached to the touch panel surface at delivery before use. If used with the protective sheet attached, MONITOUCH may not recognize touch operations or malfunctions may occur.
- When using an analog resistive-film type V9 series unit, do not touch two positions on the screen at the same time. If two or more positions are pressed at the same time, the switch located between the pressed positions may be activated.
- When using a capacitive V9 series unit, take note of the following cautions.
 - Use a Class 2 power supply for a 24-VDC unit. If an unstable power supply is used, MONITOUCH may not recognize touch operations or malfunctions may occur.
 - Capacitive touch panel types support two-point touch operations. If a third point is touched, the touch operation will be cancelled.
 - Capacitive touch panel types are prone to the influence of conductive material. Do not place conductive material such as metals near the touch panel surface and do not use the panel if it is wet. Otherwise, malfunctions may occur.

[General Notes]

- Never bundle control cables or input/output cables with high-voltage and large-current carrying cables such as power supply cables. Keep control cables and input/output cables at least 200 mm away from high-voltage and large-current carrying cables. Otherwise, malfunction may occur due to noise.
- When using the V9 series in an environment where a source of high-frequency noise is present, it is recommended that the FG shielded cable (communication cable) be grounded at each end. However, when communication is unstable, select between grounding one or both ends, as permitted by the usage environment.
- Be sure to plug connectors and sockets of the V9 series in the correct orientation. Failure to do so may lead to damage or malfunction.
- If a LAN cable is inserted into the MJ1 or MJ2 connector, the device on the other end may be damaged. Check the connector names on the unit and insert cables into the correct connectors.
- Do not use thinners for cleaning because it may discolor the V9 series surface. Use commercially available alcohol.
- If a data receive error occurs when the V9 series unit and a counterpart unit (PLC, temperature controller, etc.) are started at the same time, read the manual of the counterpart unit to correctly resolve the error.
- Avoid discharging static electricity on the mounting panel of the V9 series. Static charge can damage the unit and cause malfunctions. Discharging static electricity on the mounting panel may cause malfunction to occur due to noise.
- Avoid prolonged display of any fixed pattern. Due to the characteristic of liquid crystal displays, an afterimage may occur. If prolonged display of a fixed pattern is expected, use the backlight's auto OFF function.
- The V9 series is identified as a class-A product in industrial environments. In the case of use in a domestic environment, the unit is likely to cause electromagnetic interference. Preventive measures should thereby be taken appropriately.

[Notes on the LCD]

Note that the following conditions may occur under normal circumstances.

- The response time, brightness, and colors of the V9 series may be affected by the ambient temperature.
- Tiny spots (dark or luminescent) may appear on the display due to the characteristics of liquid crystal.
- There are variations in brightness and color between units.

[Notes on Capacitive Touch Panels]

- Touch panel operability may not be optimal if used with dry fingers or skin. In such a case, use a capacitive stylus pen.
- Periodically clean the touch panel surface for optimum touch operations.

When cleaning, take note of the following points.

<When cleaning>

- The panel surface is made of glass. Be sure to clean the surface gently with a cloth or sponge. Otherwise, you may scratch or damage the glass.
- Take care not to let cleaning detergent seep into the touch panel unit.
Do not directly apply or spray cleaning detergent on the panel surface.

[Notes on Wireless LAN]

For details regarding supported wireless LAN standards, radio law certifications, and countries where wireless LAN can be used, refer to the "V9 Series About Wireless LAN" manual and the "V9 Series Hardware Specifications" manual provided with the V9 series unit at delivery.

Contents

1 Introduction

1.1 Edit Model and Resolution

1.2 Screen Program File Structure

1.2.1	Screen Structural Components	1-2
1.2.2	Base Screen/Overlap Display Structure	1-3
	What Is an ID?	1-4
	Restrictions on identical ID placement	1-4
	Necessity of ID agreement	1-4
	When using a screen library	1-5
	ID number check	1-6
1.2.3	Screen Capacity	1-6

2 V-SFT Ver. 6 Configuration and Screen Editing Procedures

2.1 Editing Procedure

Editing Procedure	2-1
-------------------------	-----

2.2 Starting and Quitting

2.2.1	Starting	2-2
	Procedure for Creating a New File	2-2
	Opening an Existing File	2-4
	Edit Model Selection	2-5
	Automatic size adjustment function	2-6
	Procedure for changing the MONITOUCH model	2-6
	Hardware Settings	2-7
	PLC Property Settings	2-7
	Control Area Settings	2-8
2.2.2	Quitting	2-9

2.3 V-SFT Ver. 6 Configuration

2.3.1	Names of Parts	2-10
2.3.2	Application Menu	2-11
	Language	2-11
	Text Font	2-11
2.3.3	Quick Access Toolbar	2-12
	Customization Procedure	2-12
2.3.4	Ribbon Menu	2-14
	File	2-14
	[Property] window	2-15
	[File Information]	2-15
	[PLC Information]	2-16
	[General]	2-16
	[Edit]	2-17
	[Transfer]	2-17
	[Splash Screen]	2-18
	Home	2-18
	Parts	2-19
	Edit	2-20
	View	2-21
	Screen Setting	2-21
	Transfer	2-22
	System Setting	2-22
	Tool	2-23
	Help	2-23

2.3.5	Item Settings Window	2-24
	Other Settings	2-24
	Preview Display	2-25
	Style Settings of Linked Parts	2-26
	Position adjustment procedure	2-27
	[Select from catalogs]	2-29
	[Additional Parts List]	2-29
	[Add Parts]	2-30
2.3.6	View Windows	2-31
	Display Method	2-31
	Types of View Windows	2-31
	Project list view window	2-31
	Catalog view window	2-31
	Item list view window	2-32
	Function item view window	2-32
	Movement Method	2-33
	Docking	2-33
2.4	Types of Setting Menus	
2.4.1	Menu Types	2-34
	Pull-down Type	2-34
	Option Button	2-34
	Numerical Data Entry: Box Type	2-34
	Numerical Data Entry: Underlined Type	2-35
	Checkbox	2-35
	List Type	2-36
	Command Buttons	2-36
	Detailed Settings > >	2-36
2.4.2	Device Memory Settings	2-37
	Changing the Specification Method	2-37
	Device Memory Display Types and Specification Methods	2-37
	Normal display	2-37
	Normal display (no input window)	2-37
	Simple display	2-38
	Types of Device Memory	2-38
	PLC device memory	2-38
	Internal device memory	2-39
	Address list	2-39
	I/O device memory	2-40
2.4.3	Color Settings	2-41
	Color Type Setting	2-41
	Color Selection Procedure	2-41
	[Custom Color] Window	2-42
	Blinking Setting	2-43
	Blinking setting procedure	2-43
	Blinking time setting	2-43
2.5	Configuring the Editing Environment	
2.5.1	Changing the Background Color	2-44
2.5.2	Grid Display	2-46
	What Is the "Grid"?	2-46
	Detailed Grid Settings	2-46
2.5.3	Changing the Handle Color	2-47
2.5.4	Changing the Margin Color	2-48
2.6	Basic Operations	
2.6.1	Screen Switching Procedure	2-49
	Switching Screens on the [Home] Menu	2-49
	Previous screen/Next screen icons	2-49
	Jump	2-49
	Selecting from the Screen List	2-50
	Selecting from the Project List View Window	2-51
2.6.2	Copying Screens	2-53
	Copy Using the Screen List	2-53
	Copy Using the Project List View Window	2-55
2.6.3	Moving Screens	2-57
	Move Using the Screen List	2-57
	Move Using Screen Settings	2-59

2.6.4	Deleting Screens	2-61
	Deleting Using the [Edit] Menu.....	2-61
	Delete Using the Screen List.....	2-62
	Delete Using the Project List View Window	2-63
2.7	Saving Files	
2.7.1	Saving by Overwriting	2-65
2.7.2	Saving by Specifying a Name	2-65
2.8	File Comparison	
	Operating Procedure.....	2-66
	[Comparison] Tab Window	2-67
	File comparing menu.....	2-68
	Procedure for Checking Content Details.....	2-68
	Checking details in text format	2-68
	Checking using screen lists.....	2-69
	Procedure for Copying after Comparison.....	2-70
	Using icon checkboxes.....	2-70
	Copying by specifying a number	2-71
	Dragging and dropping between screen lists.....	2-72
	Saving After Copying	2-75

3 Placing Parts

3.1	Parts Types and Limitations	
3.1.1	Part Types	3-1
	Part Files.....	3-2
3.1.2	Limits on Maximum Number of Placeable Parts	3-3
3.2	Placement Procedure	
3.2.1	Placing Parts from the Ribbon Menu	3-4
	Placement Procedure (E.g.: Switch).....	3-4
3.2.2	Placement from the [Catalog] View Window	3-5
	Placement Procedure (E.g.: Switch).....	3-5
3.3	Changing a Part After Placement	
3.3.1	Single Parts	3-7
	Item Settings Window.....	3-7
	Changing the Part Design	3-7
	Changing the ON/OFF Design (Only for Switches and Lamps)	3-9
	Changing Coordinates and Size.....	3-10
3.3.2	Linked Parts	3-11
	What Are "Linked Parts".....	3-11
	Example of Changing Part Settings (E.g.: Trend Parts).....	3-11
	Adding and deleting parts.....	3-11
	Changing the placement position and size of individual parts.....	3-13
	Removing links	3-14
	Linking parts.....	3-15
3.4	Placing and Setting Parts	
3.4.1	Overlaps	3-16
	Normal Overlap Display	3-16
	Placement procedure.....	3-16
	Placing items on overlap displays.....	3-17
	Multi-overlap (Call-overlap) Display.....	3-22
	Placement procedure.....	3-22
	Overlap parts placement and editing.....	3-22
3.4.2	Switches and Lamps	3-23
	Placement procedure.....	3-23
	Setting method	3-23
3.4.3	Data Display	3-24
	Numerical Display, Character Display, and Message Display.....	3-24
	Placement procedure.....	3-24
	Setting method	3-24

	Table Data Display.....	3-25
	Placement procedure.....	3-25
	Setting method.....	3-25
	Setting and changing data.....	3-26
	Changing the properties of multiple data cells.....	3-27
	Changing the height and width of cells.....	3-28
	Right-click menu.....	3-28
3.4.4	Entry.....	3-30
	Placement procedure.....	3-30
	Setting method.....	3-30
	Placing from the [Catalog] view window.....	3-31
3.4.5	Trend.....	3-32
	Placement procedure.....	3-32
	Setting method.....	3-32
3.4.6	Alarm.....	3-33
	Placement procedure.....	3-33
	Setting method.....	3-33
3.4.7	Graph.....	3-34
	Placement procedure.....	3-34
	Setting method.....	3-34
3.4.8	Time Display/Calendar.....	3-35
	Placement procedure.....	3-35
	Setting method.....	3-35
3.4.9	Video/RGB Display, JPEG Display, Network Camera Display, and Remote Desktop Display.....	3-36
	Placement procedure.....	3-36
	Setting method.....	3-36
3.4.10	Graphic.....	3-37
	Placement procedure.....	3-37
	Setting method.....	3-37
3.4.11	Message and Comment Displays.....	3-38
	Placement procedure.....	3-38
	Setting method.....	3-38
3.4.12	Recipe, Slider Switch, Data Block Area, Memory Card, and Memo Pad.....	3-39
	Placement procedure.....	3-39
	Setting method.....	3-39

3.5 Registering Function Items

3.5.1	Sound.....	3-40
	Registration Procedure.....	3-40
	Registering from the [Screen Setting] menu.....	3-40
	Registering from the [Function Item] view window.....	3-41
3.5.2	Animation.....	3-42
	Registration Procedure.....	3-42
	Registering from the [Screen Setting] menu.....	3-42
	Registering from the [Function Item] view window.....	3-43
3.5.3	Macro.....	3-44
	Registration Procedure.....	3-44
	Registering from the [Screen Setting] menu.....	3-44
	Registering from the [Function Item] view window.....	3-45
3.5.4	Interval Timer.....	3-46
	Registration Procedure.....	3-46
	Registering from the [Screen Setting] menu.....	3-46
	Registering from the [Function Item] view window.....	3-47

3.6 Shape and Text Graphics

3.6.1	Shape.....	3-48
	Line.....	3-48
	[Straight Line], [Line (Arrow)], and [Line (Arrows at Both Ends)].....	3-48
	[Continuous Line].....	3-49
	Rectangle.....	3-51
	[Rectangle], [Round Chamfering], and [Chamfering].....	3-51
	Selecting a tile pattern.....	3-52
	Notes on [Round Chamfering] and [Chamfering].....	3-53
	Parallelogram.....	3-54
	Polygon.....	3-55

	Circle	3-57
	[Circle]	3-57
	[Arc] and [Sector]	3-59
	[Ellipse]	3-62
	[Elliptical Arc]/[Elliptical Sector]	3-63
	Paint	3-66
	Paint procedure	3-66
	Checking the painting position	3-67
	Paint properties	3-68
	Dot	3-69
	Drawing method	3-69
	Scale	3-70
	[Bar Graph Scale]	3-70
	[Pie Graph Scale]	3-71
	Drawing method	3-71
	[Trend Graph Scale]	3-73
	Library	3-74
	[Pattern]	3-74
	Placing a pattern	3-74
	Placing multiple patterns consecutively	3-75
	Graphic library (GLIB)	3-76
	Screen library (SLIB)	3-78
	Item view window	3-79
3.6.2	Text	3-80
	Text and Multi Text	3-80
	Placement procedure	3-80
	Item view window	3-81
3.6.3	Pattern	3-83
	Picture	3-83
	Placement procedure	3-83
	Item view window	3-84
	Pattern	3-85
	Placement procedure	3-85
	Dialog box displayed during image import	3-87
	Item view window	3-87
	Parts	3-88
	Applicable items	3-88
	Placement procedure	3-88
3.6.4	Changing the Properties of Drawing Parts	3-93
	Displaying the Item View Window	3-93
	Display by clicking	3-93
	Display by double-clicking	3-93
	Examples of Item View Windows	3-94
	Straight line	3-94
	Rectangle	3-94
	Text	3-94
3.7	Component Parts	
3.7.1	Overview	3-95
3.7.2	Placement Procedure	3-95
3.7.3	Settings	3-96

4 Useful Editing and View Menus

4.1 Edit Menu

4.1.1	Edit	4-1
	Multi-copy	4-1
	Setting example	4-3
	Selection Pasting	4-4
4.1.2	Place	4-5
	Place (E.g. Left End)	4-6
	Arrangement (E.g.: Vertical Align)	4-7
4.1.3	Size	4-8
	Setting Example	4-8
4.1.4	Style	4-9
	Arrow Type	4-9
	Line Type	4-9
	Frame Type	4-10

4.1.5	Modify Parts	4-11
	Change to Switch / Change to Lamp.....	4-11
	Change to Multi-Text	4-12
4.1.6	Selection Environment Setting	4-14
	Settings.....	4-14
4.1.7	Select/Delete	4-14
4.1.8	Right-click Menu	4-15
	Menu Display When No Items are Selected.....	4-15
	Menu Display When Items are Selected.....	4-15
	Batch Change.....	4-16
	Setting method	4-16
	Detail Setting.....	4-17
	Setting method	4-17
4.2	View Menu	
4.2.1	Display Change	4-18
4.2.2	View	4-18
	[Project View] Window	4-18
	Example: Hardware Setting	4-19
	Example: Screen	4-19
	Catalog View Window.....	4-20
	Item List.....	4-21
	Icon menu.....	4-21
	Operation Method	4-22
	Changing text.....	4-22
	Changing Device Memory.....	4-22
	Changing Coordinates.....	4-23
	Displaying the Item Settings Window	4-23
	[Function Item] View Window.....	4-24
	Operation method	4-25
4.2.3	Grid	4-26
	[Grid Setting] Window	4-26
	[Grid] tab.....	4-26
	[Initial Frame Display] tab	4-28
4.2.4	Display Environment	4-28
	Display Environment Settings.....	4-29
	[Display] tab.....	4-29
	[Others] Tab.....	4-32
4.2.5	Zoom	4-34
4.2.6	Redraw	4-34
4.3	Screen Setting Menu	
4.3.1	[Screen Setting] Window	4-35
	[Main] Tab.....	4-35
	[Scroll] Tab.....	4-35
	[Entry] Tab.....	4-35
	[Others] Tab	4-36
	[PLC Device Transfer] Tab.....	4-36
	[Unhide] Tab	4-37

5 Tools

5.1	Tool Menu	
5.2	Error Check	
5.2.1	Display Method	5-2
5.2.2	Error Types	5-2
5.2.3	Icon Menu	5-2
5.3	List of Memory Use	
5.3.1	Display Method	5-3

5.3.2	Checking Registration Details of Registered Items	5-4
5.3.3	3D Bitmap Area List	5-5
	Overview.....	5-5
	Parts	5-5
	Display Method	5-5
	Checking Locations of Use.....	5-6
	Checking Part Sizes.....	5-6
	Notes	5-6
5.4	Search	
5.4.1	Device Memory Addresses	5-7
	Search Method	5-7
	Searching using cross-referencing	5-7
	Searching without using cross-referencing.....	5-9
	[View] Menu.....	5-10
5.4.2	Tag Usage	5-11
	Displaying the [Tag Use] View Window	5-11
	Tag Use View Window	5-12
	Operation Method	5-13
	To search for the position where a tag is used.....	5-13
	To check the status of use	5-14
5.4.3	Text	5-15
	Operating Procedure.....	5-19
	Search	5-19
	Replacement.....	5-21
5.4.4	Windows Font	5-22
5.4.5	Macro Command	5-23
	Display Method	5-23
	Operating Procedure.....	5-25
5.4.6	Cross-reference	5-27
	Display Method	5-27
	Operating Procedure.....	5-28
5.5	Batch Change	
5.5.1	Device Memory Addresses	5-30
	Operating procedure	5-30
	Option settings.....	5-31
	Changing Device Memory of Selected Items Only.....	5-32
	Operating procedure	5-32
	Option settings.....	5-33
5.5.2	Windows Font	5-33
5.5.3	Multi Language	5-34
	Multi Language Batch Change	5-34
	Location of settings.....	5-34
	Setting items	5-35
	Setting procedure	5-37
	Multi Language Batch Copy	5-38
	Location of settings.....	5-38
	Setting items	5-39
	Setting procedure	5-41
	Rearrange Language Order	5-42
	Location of settings.....	5-42
	Setting items	5-42
	Setting procedure	5-43
5.5.4	Change Order INC	5-44
	Target Items.....	5-45
	Setting Items.....	5-46
	[Change Order INC] window.....	5-46
	Order Change Procedure.....	5-47
	[Automatic Allocation]: [Coordinate Order].....	5-47
	[Automatic Allocation]: [Placement Order]	5-49
	[Specify with Mouse].....	5-50
5.5.5	Screen Library	5-52
	Setting Method.....	5-52
5.5.6	Fix 3D Parts Frame	5-54
	Setting Method.....	5-54

5.6	Others	
5.6.1	Screen Image	5-56
	Save as Pattern Image	5-56
	Operation method	5-56
	Copy to Clipboard	5-58
	Operation method	5-58
	Pasting the copied image in other application software	5-59
	Save in Image File	5-60
	Saving format	5-60
	Saving target	5-60
	Operation method	5-60
5.6.2	Convert to Rich Text Format	5-62
5.6.3	DXF File Convert	5-64
	Operating Procedure	5-64
	[Detail Setting] options	5-65

6 Registration Items

6.1	Overview	
6.1.1	Outline of Registration Items	6-1
6.1.2	Types of Registration Items	6-2
6.2	Screen	
6.2.1	Calling a Screen	6-3
6.2.2	Editing Procedure	6-3
6.3	Message	
6.3.1	Message Structure	6-4
	Relationship between Group Numbers and Absolute Addresses	6-4
6.3.2	Calling a Message	6-5
	Message Edit Window	6-5
6.3.3	Message Editing	6-6
	Text Properties (Windows Font)	6-6
	Copying and Pasting Messages	6-7
	Deleting Messages	6-7
	Message Search and Replacement	6-8
	Search	6-8
	Replacement	6-8
6.3.4	Display Environment of the Message Editing Window	6-9
6.4	Overlap Library	
6.4.1	Overlap Library Structure	6-10
6.4.2	Calling an Overlap Library	6-10
6.4.3	Editing an Overlap Library	6-11
	Placing an Overlap	6-11
	Item Placement on Overlap Display	6-12
	Method 1: Select the overlap	6-12
	Method 2: Display the [Overlap Edit] window	6-12
6.4.4	Other Settings	6-14
	Macro Settings	6-15
	Macro setting commands	6-15
	Macro editing and deleting	6-15
6.5	Screen Library	
6.5.1	Outline of Screen Library	6-16
	Saving of Screen Memory Space	6-16
	Screen Parts Management Through Screen Library	6-16
6.5.2	Screen Library Structure	6-17

6.5.3	Calling a Screen Library	6-17
6.5.4	Screen Library Editing	6-18
	Offset Position Setting.....	6-18
	Changing an offset position.....	6-18
	Placing a Screen Library	6-19
	Changing Numbers After Screen Library Placement	6-19
	Screen Library Device Memory Specification.....	6-20
	[Display] area.....	6-20
6.5.5	Screen Library Environment Settings	6-21
	[Base Screen Dsp.] ([Others] tab).....	6-21
	[Background] ([Others] tab).....	6-22
6.6	Graphic Library	
6.6.1	Graphic Library Structure	6-23
6.6.2	Calling the Graphic Library	6-23
6.6.3	Graphic Library Editing	6-24
	Offset Position Setting.....	6-24
	Outline of offset position	6-24
	Changing an offset position.....	6-25
	Parameter Settings.....	6-25
	Outline of parameters.....	6-25
	Parameter setting procedure.....	6-26
	[Parameter] area	6-26
	Parameter setting items.....	6-29
	Data Display.....	6-31
	Outline of data display in the graphic library.....	6-31
	Data display placement procedure	6-31
	Data display setting procedure.....	6-32
6.6.4	Graphic Library Environment Settings	6-33
6.7	Multi-language	
6.8	Macro Block	
6.8.1	Macro Block Structure	6-33
6.8.2	Calling a Macro Block	6-33
6.8.3	Macro Block Editing	6-33
6.9	Tag Database	
6.10	Data Sheet	
6.10.1	Data Sheet Structure	6-34
6.10.2	Calling a Data Sheet	6-34
6.10.3	Data Sheet Editing	6-35
	Data Sheet Setting.....	6-35
	Graphics.....	6-35
	[Convert to Extended Data Sheet]: Unselected	6-36
	[Convert to Extended Data Sheet]: Selected.....	6-37
6.11	Comment	
6.11.1	Comment Structure	6-38
	Limitations on Comments	6-38
6.11.2	Calling a Comment	6-38
6.11.3	Editing a Comment	6-39
	Entering a Comment	6-39
	Text Properties.....	6-39
	Deleting a Comment.....	6-40
	Comment Import and Export.....	6-41
	Comment import and export procedure.....	6-41
	About TXT format.....	6-41
	About CSV format	6-42
6.11.4	[Page] Menu	6-43

6.12	Animation	
6.12.1	Animation Function Structure	6-44
6.12.2	Calling an Animation	6-44
6.12.3	Animation Editing	6-45
6.12.4	Frame Editing	6-47
	Frame Structure.....	6-47
	Frame Editing	6-47
6.13	Pattern	
6.13.1	Pattern Structure	6-48
6.13.2	Calling a Pattern	6-48
6.13.3	Pattern Editing	6-49
	Eraser.....	6-49
	Line.....	6-50
	Rectangle	6-50
	Text.....	6-51
	Paint.....	6-52
	Box Select Area.....	6-52
	Using [Box Select Area].....	6-52
6.13.4	Transforming Patterns	6-53
	[Rotate Graphic] (rotate 90° to the left).....	6-53
	[Mirror Horizontal].....	6-53
	[Mirror Vertical].....	6-53
	[Change Size]	6-54
	[Transparent Color Setting]	6-54
6.13.5	Image File Import and Saving	6-55
	Importing Image Files.....	6-55
	Window displayed during image import.....	6-56
	Saving Image Files.....	6-57
6.13.6	Pattern Environment Settings	6-58
	Display Environment Settings.....	6-58
6.13.7	Placing a Pattern	6-59
	Pattern number setting on multi-language screens.....	6-59
6.14	Data Block	
6.14.1	Data Block Structure	6-60
6.14.2	Calling a Data Block	6-60
6.14.3	Data Block Editing	6-61
	Placing Parts	6-61
	Placement procedure.....	6-61
	Offset Position Setting.....	6-61
	Changing an offset position.....	6-61
	Data Block Environment Settings.....	6-62
	[Base Screen Dsp.] ([Others] tab).....	6-62
	[Background] ([Others] tab).....	6-63
6.15	Page Block	
6.15.1	Page Block Structure	6-64
6.15.2	Calling a Page Block	6-64
6.15.3	Page Block Editing	6-65
6.16	Direct Block	
6.16.1	Direct Block Structure	6-66
6.16.2	Calling a Direct Block	6-66
6.16.3	Direct Block Editing	6-67

6.17	Tile	
6.17.1	Tile Structure	6-69
6.17.2	Calling a Tile	6-69
6.17.3	Tile Editing	6-70

7 Transfer

7.1 Overview

7.1.1	Transfer Methods	7-1
	Using a Communication Cable	7-1
	USB (USB mini-B port)	7-1
	Ethernet (LAN port)	7-1
	V-CP (serial port)	7-2
	Using a Storage Device	7-2
	SD card	7-2
	USB flash drive.....	7-2
7.1.2	Types of Data to Transfer	7-3
	Transfer Data List	7-3

7.2 Preparation for Transfer

7.2.1	Preparation for MONITOUCH	7-4
	New MONITOUCH	7-4
	When transferring via USB or V-CP:.....	7-4
	When transferring via Ethernet or a storage device:.....	7-4
	Existing MONITOUCH	7-5
	Via USB	7-6
	Via Ethernet	7-6
	Via V-CP	7-6
	Via a storage device	7-6
	Preparation of Peripheral Equipment	7-6

7.3 USB Transfer

7.3.1	Installing the USB Driver	7-7
	For Windows Vista/7/8/8.1	7-7
	For Windows XP	7-7
	When USB driver installation fails	7-8
	Confirming Installation of the USB Driver	7-9
7.3.2	Transfer	7-10
	Download.....	7-10
	Upload.....	7-12
	File Comparing.....	7-13

7.4 Ethernet Transfer

7.4.1	IP Address Settings	7-14
	Configuring New Units	7-14
	Configuring Existing Units.....	7-15
	V9 Advanced	7-15
	V9 Standard / Lite.....	7-16
	Network Test	7-18
	Testing in Local Mode on the V9 Series Unit	7-18
	Testing using the PING command on the computer	7-20
7.4.2	Transfer	7-21
	Download.....	7-21
	Upload.....	7-23
	File Comparing.....	7-24

7.5 V-CP Transfer

	Download.....	7-25
	Upload.....	7-27
	File Comparing.....	7-28

7.6 Transfer via Storage

	Transfer Procedure for Storage Device → V9 Series Unit.....	7-29
	Transfer procedure for editor → storage device (using storage manager).....	7-29
	Transfer procedure for storage device → V9 series unit	7-32

Transfer Procedure for V9 Series Unit → Storage Device.....	7-34
Transfer procedure for V9 series unit → storage device	7-34
Converting a Storage Device File → V9 File (using storage manager).....	7-36
Procedure for V9 Series Unit ↔ Storage Device Comparison	7-38

7.7 Selective Transfer

Operation Example.....	7-39
Setting Items.....	7-40
Setting Procedure.....	7-42
Administrator settings	7-42
Settings for users 1 to 4.....	7-43
PC <- V9 series unit transfer.....	7-44
Notes	7-44

7.8 Message/Comment Transfer

Operation Example.....	7-45
Target Items.....	7-46
Location of Settings.....	7-46
Setting Procedure.....	7-46
Message	7-46
Comment.....	7-48
Notes	7-50

8 Simulation

8.1 Simulator

8.1.1	Overview	8-1
8.1.2	Operating Procedure	8-2
8.1.3	Establishing a Connection Between the Computer and V9 Series Unit	8-3
	Via USB.....	8-3
	Via Ethernet.....	8-3
	Via V-CP.....	8-3
8.1.4	Screen Program and Simulator Program Transfer	8-4
	Screen Program Transfer	8-4
	V9 Series Unit Settings	8-5
8.1.5	Starting and Quitting the Simulator	8-7
	Startup.....	8-7
	Quitting.....	8-7
8.1.6	Starting and Stopping Communication	8-8
	Starting Communication.....	8-8
	Stopping Communication	8-8
	Communication Settings	8-9
	Via USB.....	8-9
	Via Ethernet	8-9
	Via serial communication.....	8-10
8.1.7	Structure of the [Simulator] Window	8-11
	Menu Bar.....	8-12
	File.....	8-12
	Edit	8-12
	Communication.....	8-13
	View	8-13
	Window	8-13
	Help.....	8-13
	Icon Menu.....	8-14
	Sheet Structure	8-15
8.1.8	Operation Method	8-16
	Changing Values (Word Address)	8-16
	Adding a New Address.....	8-17
	Display Device Memory.....	8-18
8.1.9	Test Example	8-19
	Testing Bit Device Memory.....	8-19
	V9 series unit → simulator.....	8-19
	Simulator → V9 series unit	8-20
	Testing Word Device Memory.....	8-21
8.1.10	Error List	8-22

8.2	Emulator	
8.2.1	Overview	8-23
8.2.2	Operating Procedure	8-24
	Starting and Quitting	8-24
	Startup	8-24
	Quitting	8-24
	Operation Example.....	8-25
8.2.3	Structure of the [Emulator] Window	8-26
	Menu Bar.....	8-26
	File	8-26
	View	8-26
	Icon Menu.....	8-26

9 Printing

9.1	Overview	
9.1.1	Compatible Printers	9-1
9.2	Printing	
9.2.1	Operating Procedure	9-2
9.2.2	Print Settings	9-2
	Output Range.....	9-3
	[Current Screen]	9-3
	[All]	9-3
	[Select]	9-3
	Print Format.....	9-4
	Page Settings.....	9-5
9.3	Print Preview	
9.3.1	Operating Procedure	9-6
9.4	Print Current Window	
9.4.1	Operating Procedure	9-6
9.5	Example of Printing	
	Screen Output.....	9-6
	List Output.....	9-7
	System settings	9-7
	List of memory use	9-8
	Table Print.....	9-8
	For screens.....	9-8
	For screen library	9-8
	Use Cross-reference.....	9-8

10 Fonts

10.1	Font Types	
	System Fonts	10-1
	Windows Fonts	10-1
	Supported Language List.....	10-2
	Checking Fonts in Local Mode	10-3
	Font Size.....	10-4
	Bitmap font	10-4
	Memory Sizes of Fonts	10-4
10.2	Setting Fonts	
10.2.1	Font Settings	10-5
	Fonts	10-5
	Transfer Font Settings.....	10-6
	Import and Export	10-7

10.3	Entering Multiple Languages	
	Example: Entering "Chinese (simplified)" Text in a English OS.....	10-8
	Adding input method editors (IMEs).....	10-8
	Text entry procedure.....	10-10
10.4	Windows Font	
10.4.1	Limitations	10-11
10.4.2	Setting Items	10-12
10.4.3	Setting Procedure	10-13
	Character Properties.....	10-13
	In Message Editing.....	10-14
	Font Registration.....	10-15
	Font registration file.....	10-16
	[Windows Font Registration] window	10-16
10.4.4	[Windows Font List] Window	10-17
	Window Location.....	10-17
10.4.5	Change All Windows Fonts	10-17
	Procedure.....	10-17
10.4.6	Windows Fonts for Language Selection	10-19
	Conditions for Language Selection Using Windows Fonts	10-19
	Multi-Language Editing Using Windows Fonts.....	10-19
10.4.7	Windows Fonts Not Installed on Your Computer Exist in a Screen Program	10-20
	When Opening a File.....	10-20
	When Error Checking is Performed	10-20
	When Viewing Text Properties	10-20
	When Enlarging/Reducing	10-21
	[Windows Font List] Window	10-21
	[Windows Font Registration] Window.....	10-21

11 Parts Editing

11.1	Parts	
11.2	Selecting from Images Files	
11.2.1	Setting Procedure	11-2
	Using an Image File on a Placed Part	11-2
	Apply to all patterns (switches and lamps only).....	11-3
	Creating New Parts from Image Files	11-6
	Creating additional parts using the catalog.....	11-6
11.3	Changing Placed Parts	
11.3.1	Part Structure	11-10
11.3.2	Editable Parts	11-10
11.3.3	Displaying the [Modify Part] Tab Window	11-11
	Display Procedure.....	11-11
	Closing the Tab Window.....	11-12
11.3.4	Editing Parts	11-13
	Overlap.....	11-13
	Structure.....	11-13
	Editing procedure.....	11-13
	Switch/Lamp	11-14
	Structure.....	11-14
	Editing procedure.....	11-14
	Properties of graphic frames and areas.....	11-15
	Re-setting the touch area	11-15
	Re-setting the basic part area	11-16
	Re-setting the frame	11-17
	Data Display.....	11-18
	Structure.....	11-18
	Editing procedure.....	11-18
	Keypad	11-19
	Structure.....	11-19
	Editing procedure.....	11-19

Slider Switch/Scroll Bar.....	11-19
Structure.....	11-19
Editing procedure.....	11-19
Graph.....	11-20
Bar Graph.....	11-20
Structure.....	11-20
Procedure.....	11-20
Pie Graph.....	11-21
Structure.....	11-21
Procedure.....	11-21
Icons dedicated to pie graph editing.....	11-22
Closed Area Graph.....	11-24
Structure.....	11-24
Procedure.....	11-24
Panel Meter.....	11-26
Structure.....	11-26
Editing procedure.....	11-26
Statistic Bar Graph.....	11-27
Structure.....	11-27
Editing procedure.....	11-27
Statistic Pie Graph.....	11-28
Structure.....	11-28
Editing procedure.....	11-28
Trend Part.....	11-29
Structure.....	11-29
Display Area.....	11-30
Structure.....	11-30
Editing procedure.....	11-30
Trend Part (Display Method: Data Display).....	11-31
Structure.....	11-31
Editing procedure.....	11-31
Calendar Part.....	11-32
Structure.....	11-32
Editing procedure.....	11-33
11.3.5 After Completing Part Editing.....	11-34
Viewing from the [Catalog] View Window.....	11-34

11.4 Component Parts

11.4.1 Overview.....	11-36
11.4.2 Component Part Creation Procedure.....	11-37
Creation Sequence.....	11-37
Step 1: Create a New Component Part.....	11-37
Step 2: Place Items.....	11-39
Step 3: Register the Component Name and Comments.....	11-39
Step 4: Register \$C Device Memory.....	11-41
Step 5: Register a Device Memory Table.....	11-42
Step 6: Register a Text Table.....	11-45
Step 7: Save the Component Part.....	11-46
11.4.3 Procedure for Placing Created Component Parts.....	11-47
Placement Procedure.....	11-47
Other Settings.....	11-49
Connection device settings.....	11-49
Device memory map.....	11-50
Multi-language settings.....	11-50
11.4.4 Editing Placed Component Parts.....	11-51
Editing Procedure.....	11-51

1 Introduction

1.1 Edit Model and Resolution

1.2 Screen Program File Structure

1.1 Edit Model and Resolution

The screen resolution differs between MONITOUCH models.

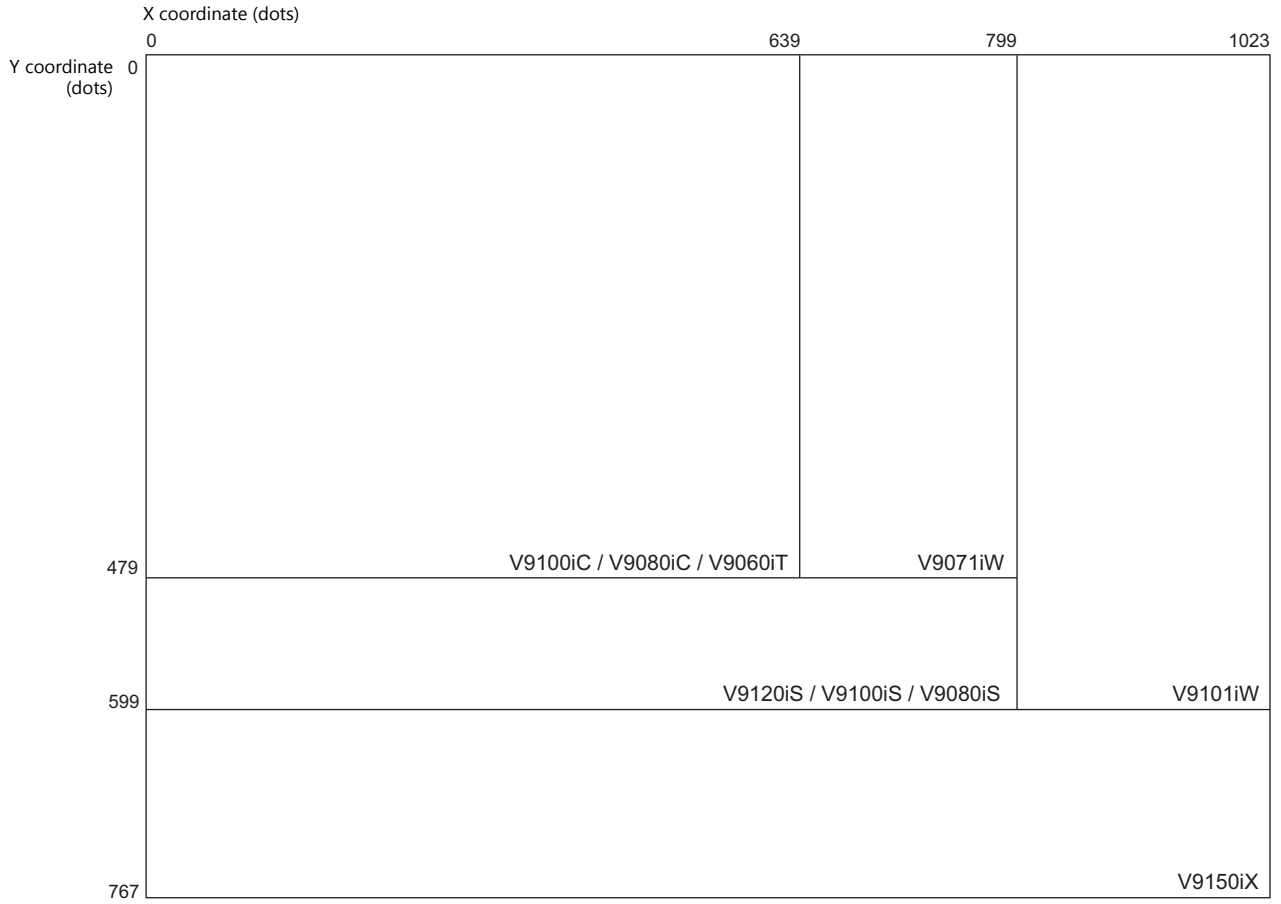

Model	Type	Inches	Resolution
V9 Advanced	V9101iW	10.1 model	1024 × 600 (WSVGA)
	V9071iW	7.0 model	800 × 480 (WVGA)
V9 Standard	V9150iX	15.0 model	1024 × 768 (XGA)
	V9120iS	12.1 model	800 × 600 (SVGA)
	V9100iS	10.4 model	
	V9080iS	8.4 model	
V9 Lite	V9100iC	10.4 model	640 × 480 (VGA)
	V9080iC	8.4 model	
	V9060iT	5.7 model	

1.2 Screen Program File Structure

The screen program file for MONITOUCH is structured based on an area referred to as a "screen".

Screens are created by placing various parts and graphic items in the "screen" area.

A single file can store up to 4,000 screens.

Items such as data and graphics which change over time and that cannot be placed directly on screens can be registered to a separate area and then combined for display on MONITOUCH. (For more information, refer to "6 Registration Items".)

This section explains the structure of screens.

1.2.1 Screen Structural Components

Each screen is composed of a base screen (mandatory) and overlaps (a maximum of 10 overlaps can be placed).

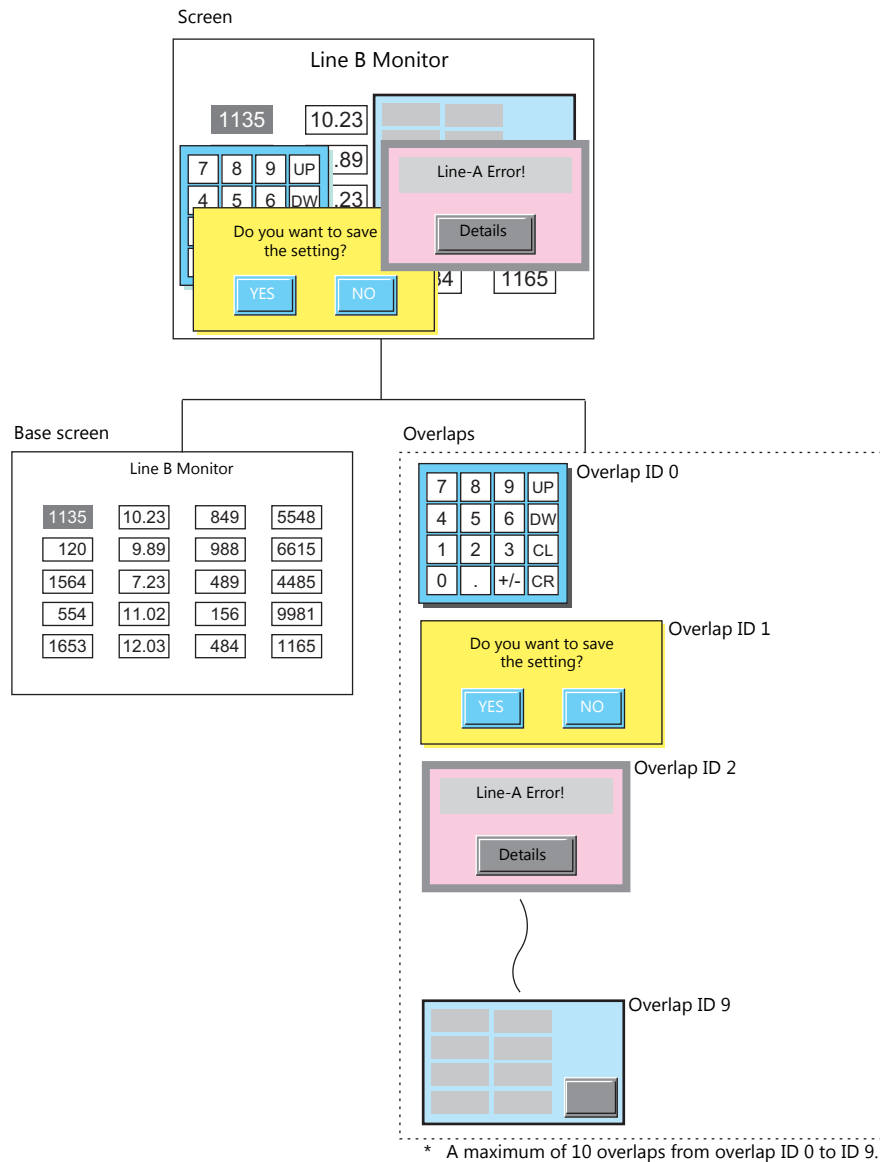

1.2.2 Base Screen/Overlap Display Structure

Each base screen and overlap contains areas referred to as "IDs." There are 256 IDs overlaid like invisible sheets.

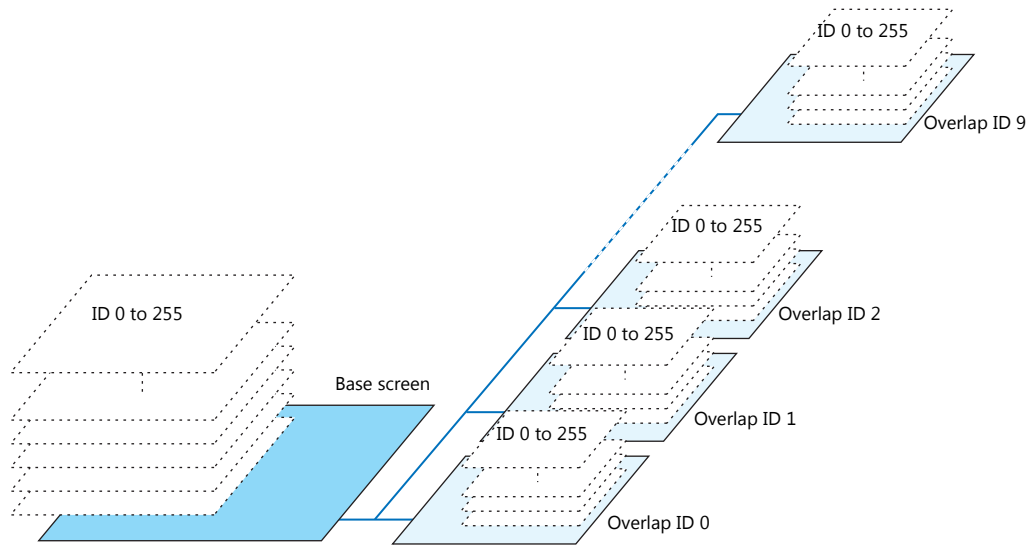

Parts, such as switches, are placed on sheets from ID 0 to 255 of the base screen and overlaps. These parts are always assigned numbers identical to their respective sheet numbers (= ID numbers).

Drawing parts, such as text and lines, are placed directly onto the base screen and overlaps. For this reason, these drawing parts are not assigned ID numbers.

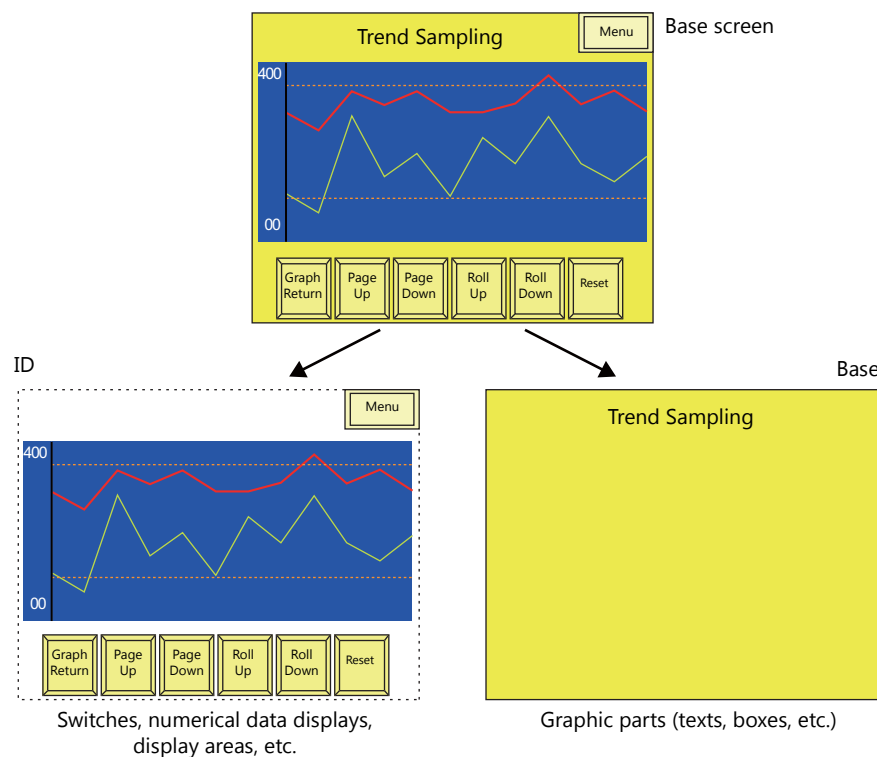

What Is an ID?

An "ID" is a number assigned to each invisible sheet.

Each part that comprises a function on the screen is always placed on an invisible sheet. In order to discriminate between placed sheet numbers, each part is assigned an ID number.

Whether a sheet can contain multiple parts or only one part depends on the types of parts.

The editor automatically performs ID number allocations. Normally, you do not need to worry about the allocation of ID numbers.

A part that executes its function singly, such as a switch, lamp, numerical data display, or bar graph, has no limit on the number of parts per ID.

ID numbers do not need to be taken into consideration when placing these types of parts.

Restrictions on identical ID placement

	Part
Restricted (only one ID per part)	Entry mode, trend parts, alarm parts, JPEG display, network camera display, remote desktop display, graphic parts, message parts, comment parts, animation function, macro mode function, interval timer macro function, sound function, table data displays, statistic bar graphs, statistic pie graphs, calendar parts, data block areas, and memos
Unrestricted	Switches, lamps, data displays (numerical data displays, character displays, message displays), slider switches, bar graphs, pie graphs, closed area graphs, panel meters, time displays, and screen libraries

Necessity of ID agreement

Different parts may be combined to execute a single function, as shown below. Such parts must share the same ID number.

- Error message display (= alarm)
- Numerical data entry on the V9 series unit (= entry mode)

Assign the same ID number to the icon, display area, and scroll switches.

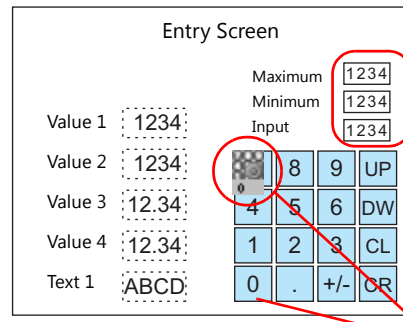
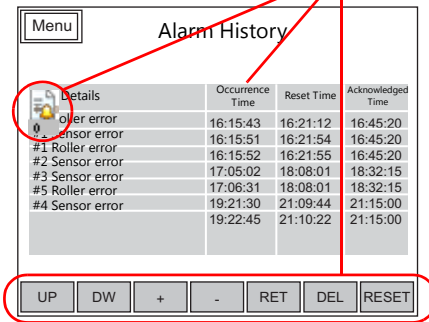

Assign the same ID.

If the parts are assigned different ID numbers, the function will not work correctly.

Check the ID numbers and assign them correctly.

When using a screen library

With the use of an editing area called "screen library," a single part can be placed on multiple screens.

Before using this area, check that the ID numbers of parts registered in the screen library are different from the ID numbers of the parts already placed on screens.

In the case of parts with a placement restriction, using the same ID number will prevent these parts from working correctly.

- Example: When a screen library that contains calendar parts is placed on multiple screens

E.g. ID number for the alarm part is set to "10":

Details	Occurrence Time	Reset Time	Acknowledged Time
10 oller error	16:15:43	16:21:12	16:45:20
#1 Roller error	16:15:51	16:21:54	16:45:20
#2 Sensor error	16:15:52	16:21:55	16:45:20
#3 Sensor error	17:05:02	18:08:01	18:32:15
#5 Roller error	19:21:30	21:09:44	21:15:00
#4 Sensor error	19:22:45	21:10:22	21:15:00

ID number for the entry mode part is set to "0":

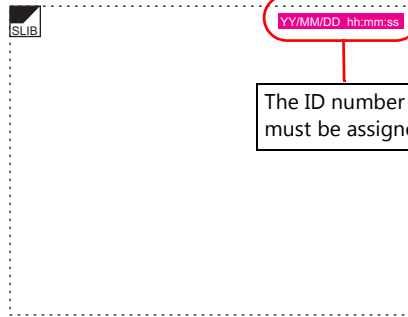

The ID number of the calendar part on the screen library must be assigned to a number other than "0" and "10".



For more information on the screen library, refer to "6.5 Screen Library" page 6-16.

ID number check

When the [View] → [ID No.] checkbox is selected, the ID number of parts placed on the screen can be checked at a glance.

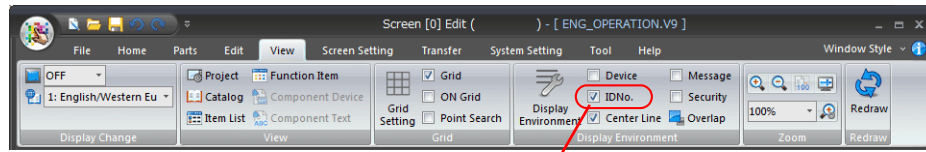

Sections marked with :
ID number of each part

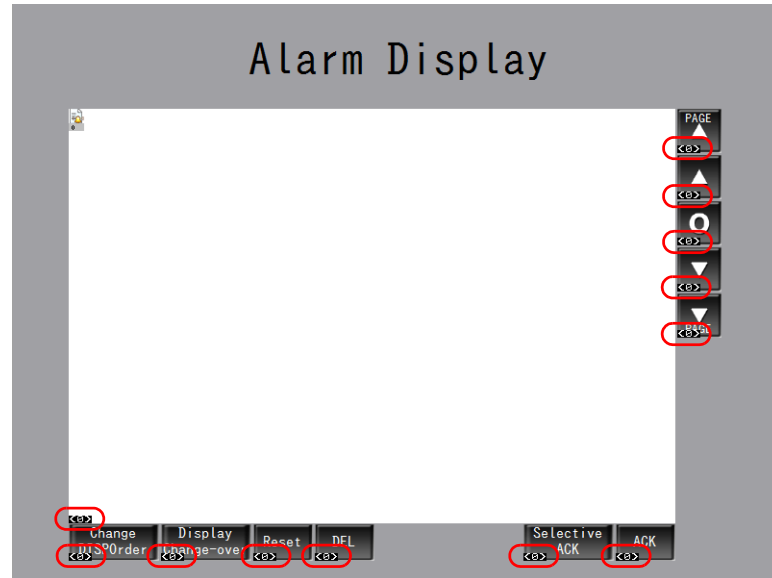

For more information on the [Display Environment] settings, refer to "4.2.4 Display Environment" page 4-28.

1.2.3 Screen Capacity

- There is no particular limitation on the capacity per screen.
However, there is a limitation on the number of items that can be registered per screen.
For more information, refer to "3.1 Parts Types and Limitations" page 3-1.
- One file is capable of storing a maximum of 4,000 screens.
- The available capacity per file differs depending on the used font types.
For more information, refer to "Memory Sizes of Fonts" page 10-4.
- Make sure to check the use environment and perform screen registration such that screens fit into the available capacity of a single file.
- * **If a screen program file exceeds the maximum capacity, any attempt to transfer the file will display the alarm message "The size is too large to communicate" and result in a transfer failure.**



The used capacity and remaining capacity for the current screen program can be checked via [Tool] → [List of Memory Use].
For more information, refer to "5.3 List of Memory Use" page 5-3.

2 V-SFT Ver. 6 Configuration and Screen Editing Procedures

- 2.1 Editing Procedure
- 2.2 Starting and Quitting
- 2.3 V-SFT Ver. 6 Configuration
- 2.4 Types of Setting Menus
- 2.5 Configuring the Editing Environment
- 2.6 Basic Operations
- 2.7 Saving Files
- 2.8 File Comparison

2.1 Editing Procedure

Editing Procedure

The following flowchart shows the procedure from creating a new screen program to transferring the created screen program to the V9 series unit.

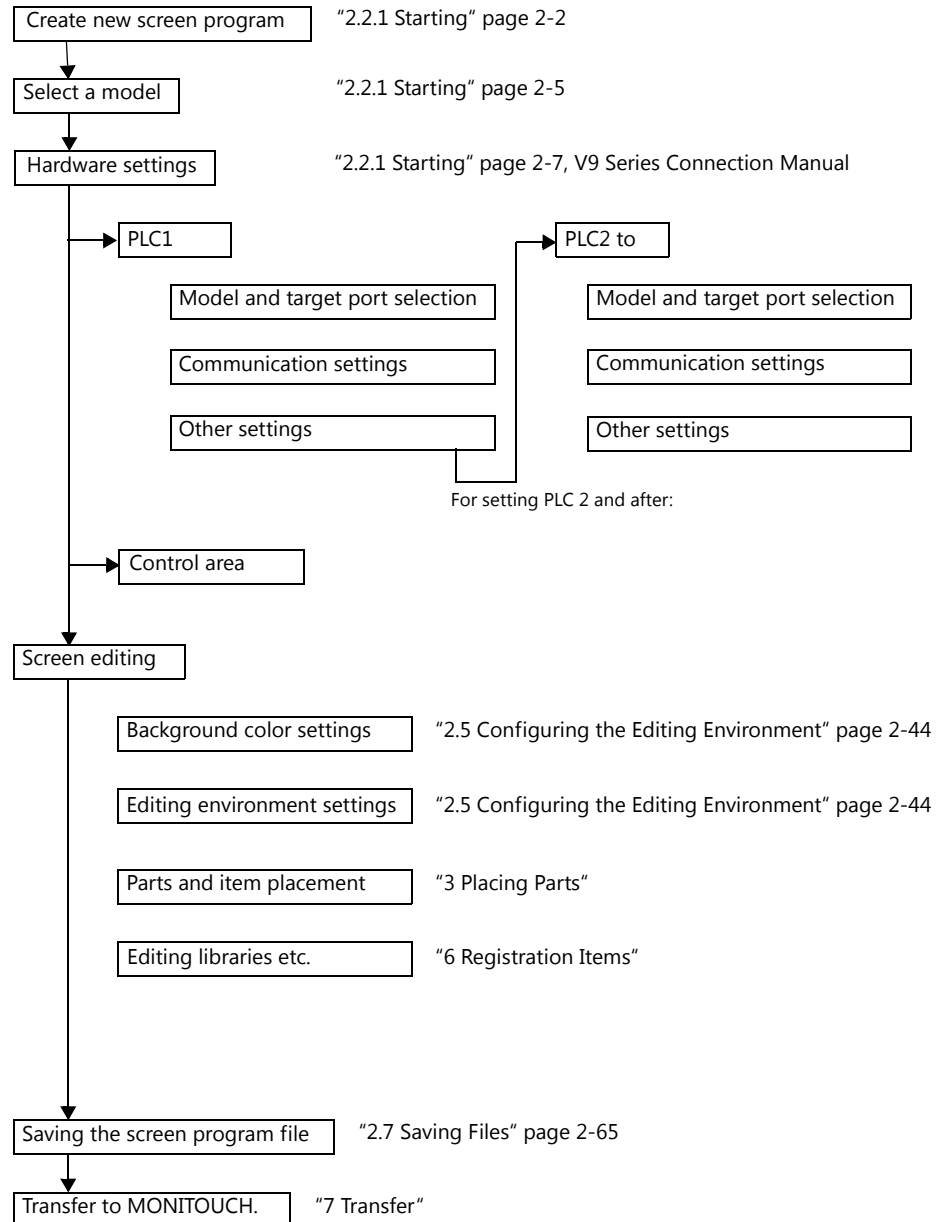

2.2 Starting and Quitting

2.2.1 Starting

Procedure for Creating a New File

1. Start V-SFT version 6 using any of the following methods.

- Double-click on the desktop shortcut.



- Double-click "Vsft60.exe" in the installation folder.
E.g.: C:\MONITOUCH\V-SFT V6\Vsft60.exe

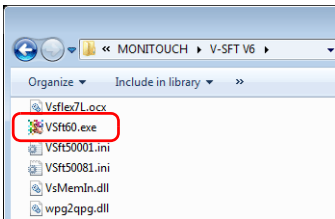

- Click [V-SFTV6] from the Start menu.

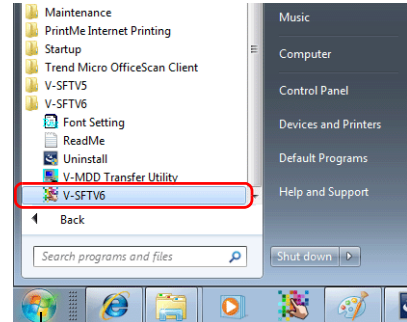

Start menu

2. The startup menu is displayed.

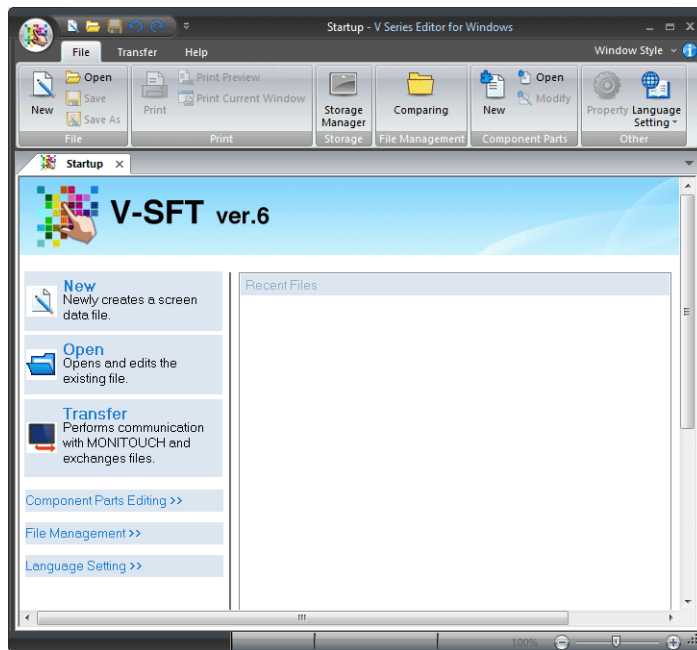

3. Click [New].

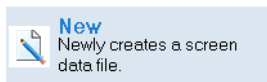

OR

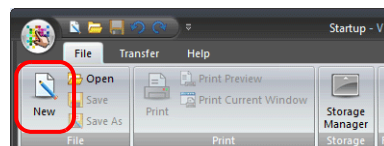

- The [Edit Model Selection] window is displayed.
Select the MONITOUCH model for which you wish to create a screen program and click [OK].

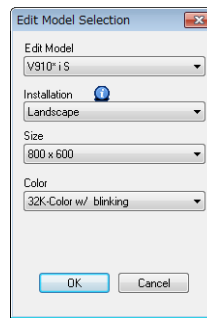

- The [PLC1 Connection Device Selection] window is displayed.
Select the PLC model and connection port and click [Finish].

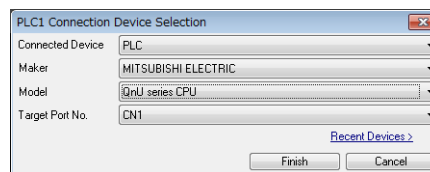

- The hardware settings and PLC properties are displayed.
Configure the communication settings in the PLC properties window and then close the PLC properties window.

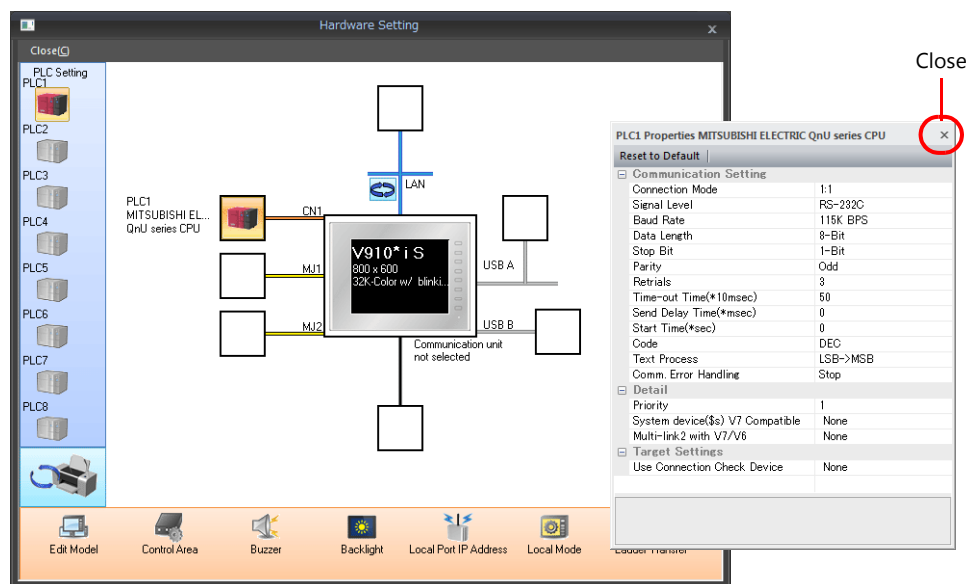

- Click [Control Area] and configure the following settings.
[Displaying Screen Device]
[Initial Screen]

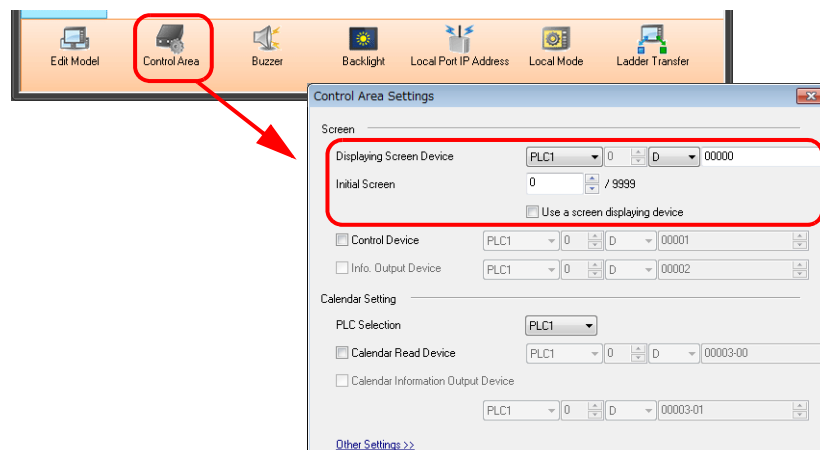

- Click the [Close] button to close the [Hardware Setting] window.
The [Screen [0] Edit] tab window is displayed.

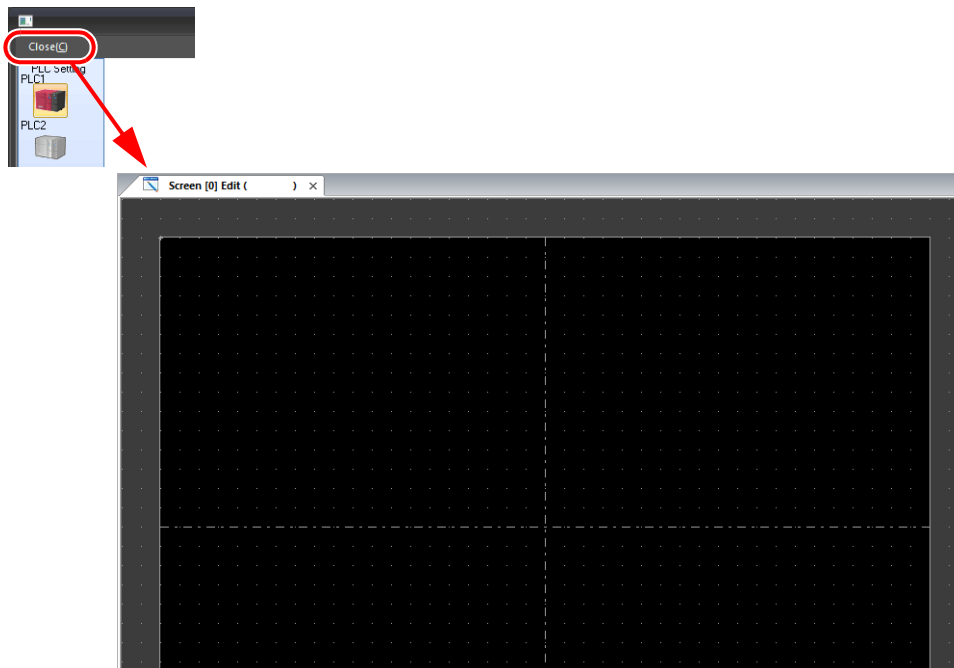

This completes the settings required to create a new screen program.

Opening an Existing File

- Start V-SFT version 6.
- Click [File] → [Open].

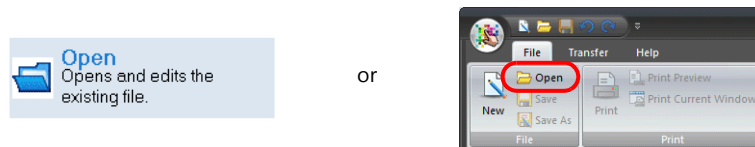

- In the [Open] window that appears, select the desired file and click [Open].

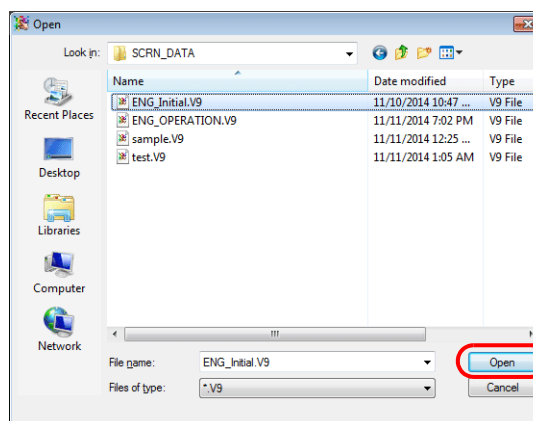

4. The file is opened.



V-SFT version 6 can also be started by double-clicking on an existing screen program file.

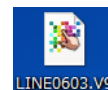

Edit Model Selection

Select the MONITOUCH model for which you wish to configure a screen program.

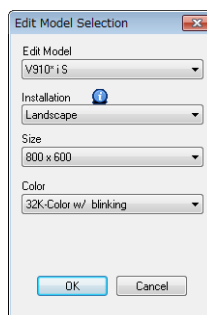

Item	Description
Edit Model	Select a model.
Installation	Select the installation direction of the MONITOUCH.
Size	Display resolutions for the selected model are displayed.
Color	Select the number of display colors.

Automatic size adjustment function

When changing the MONITOUCH model of an existing screen program file to another model with a different resolution, the resolution of the screen program can be adjusted automatically as much as possible at the time of model change.



The resolution of 640 × 480 is changed to 800 × 600 when the MONITOUCH model is changed.

Procedure for changing the MONITOUCH model

This procedure is explained with an example of changing the model from V9100iC → V9100iS.

1. Click [System Setting] → [Edit Model Selection].
2. The [Edit Model Selection] window is displayed.
Change [Edit Model] from [V910*iC] (resolution: 640 × 480) to [V910*iS] (resolution: 800 × 600) and click [OK].

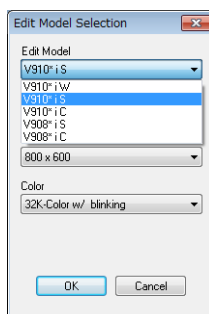

3. The following confirmation dialog box is displayed.

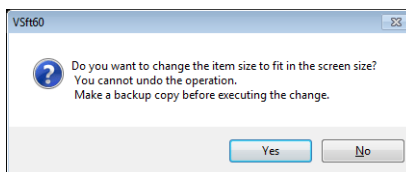

4. Click [Yes] to execute automatic size adjustment.
Click [No] to only change the MONITOUCH model without adjusting the screen resolution.



- The target areas of the automatic size adjustment function are:
Screens, screen libraries, overlap libraries, graphic libraries, data blocks
- Size adjustment cannot be performed for patterns and animation frames.
- Text is adjusted as much as possible according to the new resolution.
However, note that the size of text in the following functions cannot be adjusted.
Alarm parts, message parts, data display type trend parts
- For video displays, the display size is not changed.
- For features whose size cannot be changed automatically, adjust each of them manually.

Hardware Settings

Configure the settings of the V9 series unit and the settings of devices that connect to the V9 series unit.

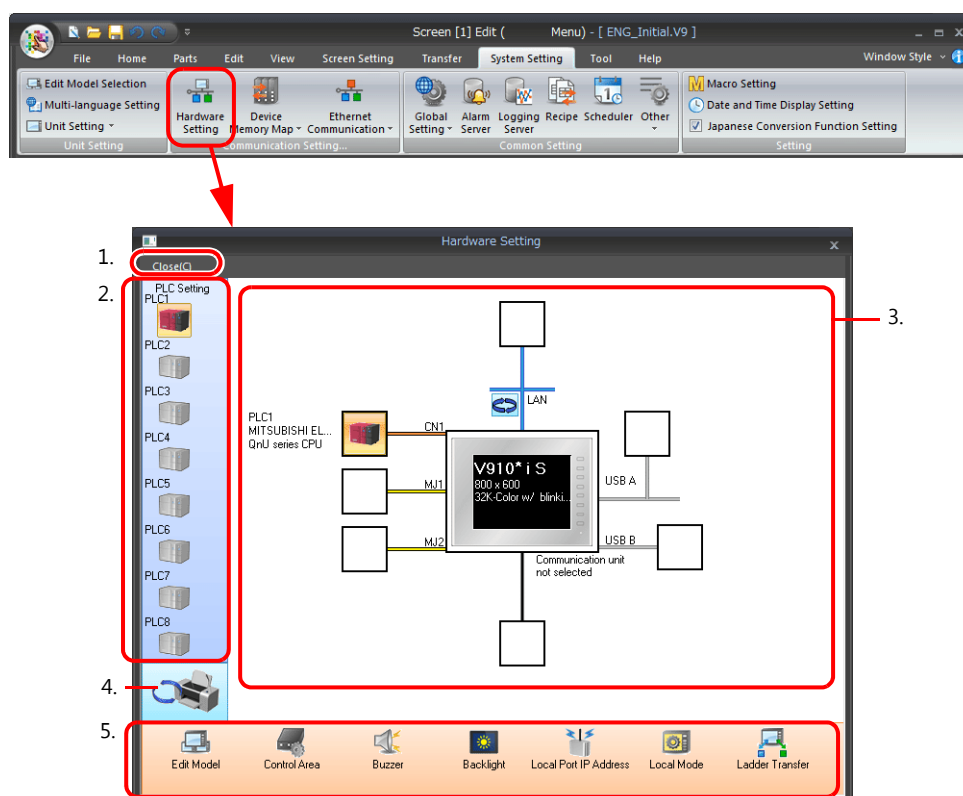

Item	Description
1. Close	Close the [Hardware Setting] window.
2. PLC Setting/Other Devices	Set the device (PLC/temperature controller/servo/inverter/barcode reader etc.) for connection to PLC1 to PLC8. Click the toggle icon (4) to change the display to [Other Devices]. [Other Devices] is used to configure connection settings for the simulator and any printers.
3. Connection diagram	Displays the devices configured for connection. Devices and communication settings can be changed.
4. PLC Setting/Other Devices settings toggle button	Switch the display between PLC settings and other settings. The display changes each time the button is clicked.
5. Unit settings	Configure the settings of the V9 series unit.

 For details on hardware settings, refer to the V9 Series Connection Manual.

PLC Property Settings

Configure the settings of PLCs connected to the V9 series unit.

Match the communication settings with the settings on the relevant PLC.

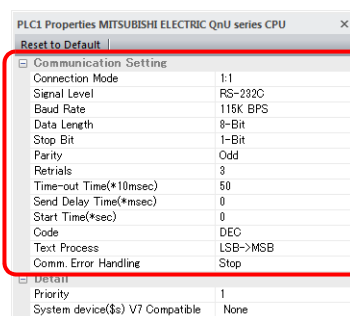

 For details on PLC property settings, refer to the V9 Series Connection Manual.

Control Area Settings

Specify the device memory to use for switching screens by commands from a connected device. The initial screen displayed at V9 series unit startup is also set here.

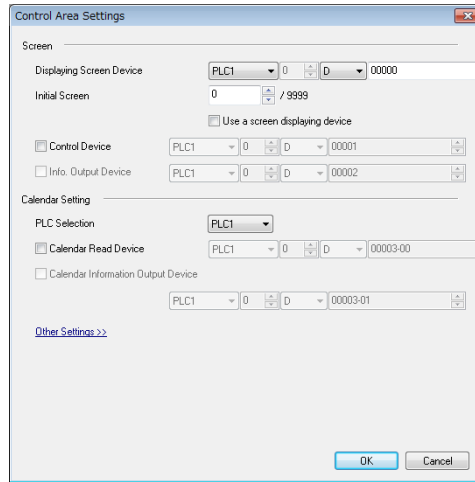

Item		Description
Screen	Displaying Screen Device	This device memory is used for switching the screen via an external command. When a screen number is specified to this device memory, the screen is displayed.
	Initial Screen	Specify the screen number to display when power to MONITOUCH is turned on. If a nonexistent screen number is specified, the lowest screen number in the screen program is displayed. Use a screen displaying device Display the screen of the number stored in the [Displaying Screen Device] memory.
	Control Device	For more information, refer to the V9 Series Reference Manual 1.
	Info Output Device	
Calendar Setting	PLC Selection	Set the reading target of the calendar. PLC1 to 8
	Calendar Read Device	This bit is valid when the built-in clock of the V9 series unit is not used. This bit should be used differently depending on whether the connected PLC is equipped with a calendar function. When connecting to a PLC with a calendar function When calendar data in the PLC is updated, it can forcibly be read by setting this bit to ON (at the leading edge of [0 → 1]). When connecting to a PLC without a calendar function Allocate a virtual calendar data area by specifying device memory for [Calendar Device] and set the calendar data by setting this bit to ON. * For more information, refer to the V9 Series Reference Manual 1.
	Calendar Information Output Device	This device memory stores the state of the [Calendar Read Device] memory.
Other Settings	Watchdog Device	When any data is saved to [Watchdog Device], the same data is also written to [Answer-back Device] after the screen display operation is complete. In addition to watch dog monitoring, these device memory addresses can be used for display scanning. * For more information, refer to the V9 Series Connection Manual.
	Answer-back Device	
	Calendar Device	For more information, refer to the V9 Series Reference Manual 1.

2.2.2 Quitting

Quit V-SFT version 6 using any of the following methods.

Click the application button → [Quit Application],
or click [X] at the top right of the editor.

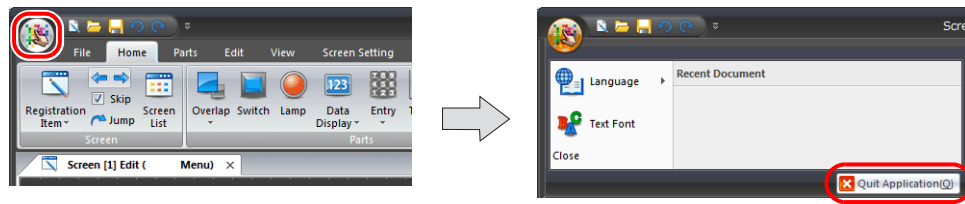

OR

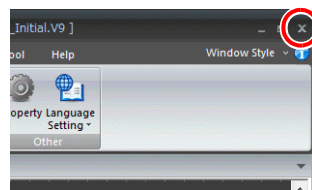

2.3 V-SFT Ver. 6 Configuration

2.3.1 Names of Parts

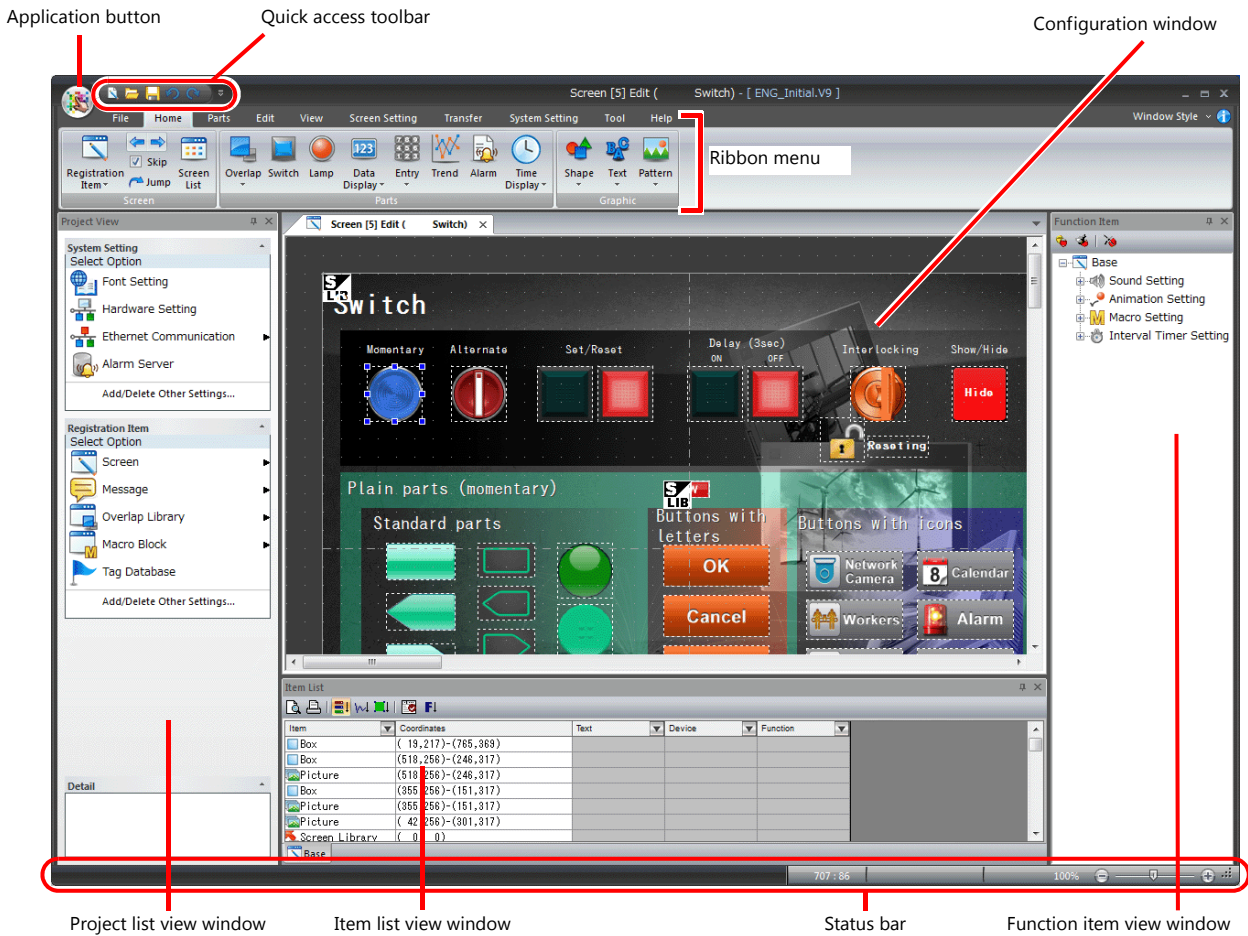

Item settings window

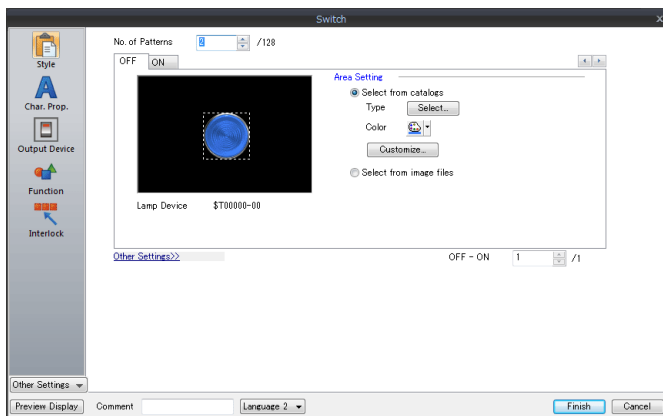

Catalog view window

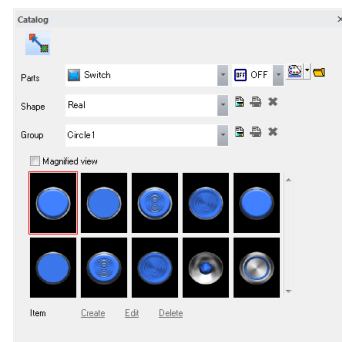

2.3.2 Application Menu

This menu is used to set the menu display language of the editor and the font of text registered in item setting windows and message registration screens.

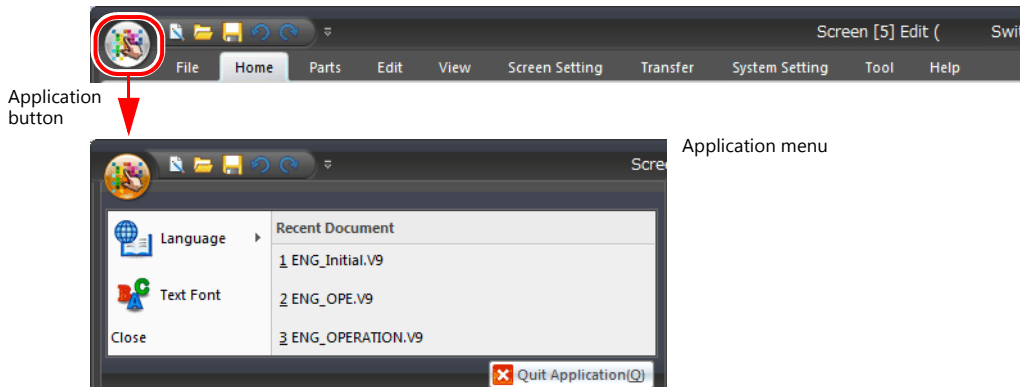

Item	Setting
Language	Select the display language to use for menus in the editor.
Text Font	Set the font of text registered in item setting windows and message registration screens.
Close	Close this menu.
Recent Document	Displays up to 10 of the most recently opened screen program files.
Quit Application	Quit V-SFT version 6.

Language

Select the display language to use for menus in the editor.
The editor must be restarted for any changes to take effect.

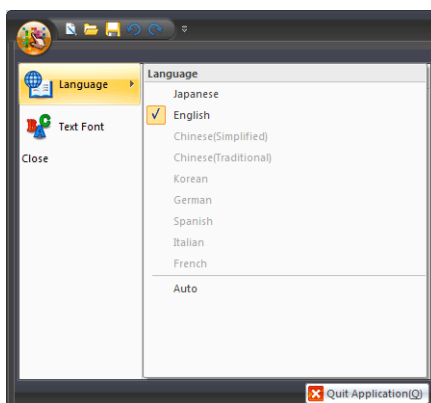

Text Font

Register the font of text set in item setting windows, message registration screens, and comment registration screens for each language.

When using Windows fonts for items, the font set here is the default font setting.

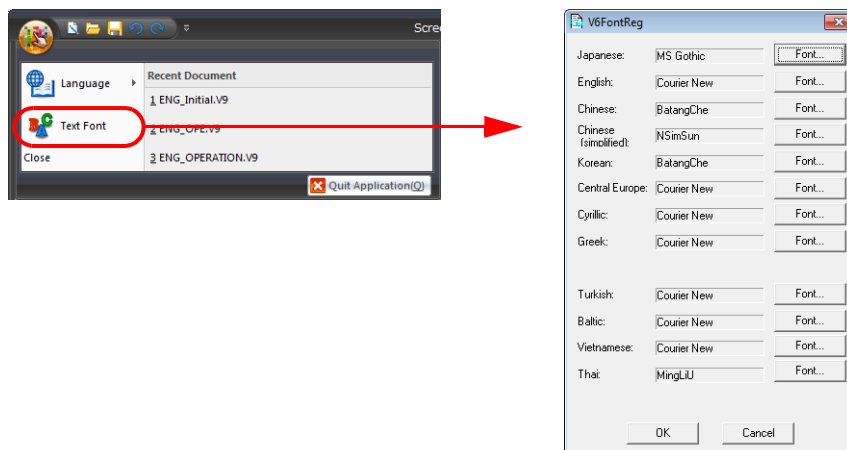

2.3.3 Quick Access Toolbar

This menu is always displayed. The types of icons that are displayed can be customized.

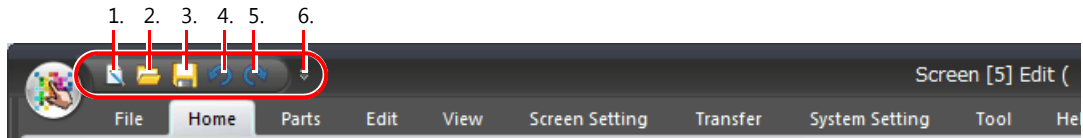

Item	Description	
1.	New	Create a new screen program file.
2.	Open	Open an existing screen program file.
3.	Overwrite	Save the screen program.
4.	Undo	Undo the last operation.
5.	Redo	Redo the operation that was undone using the [Undo] button.
6.	Customize Quick Access Toolbar	Select the menu items to display on the quick access toolbar.

Customization Procedure

1. Click the ▼ mark on the right side of the quick access toolbar to display the customization menu.
Click [More Commands].

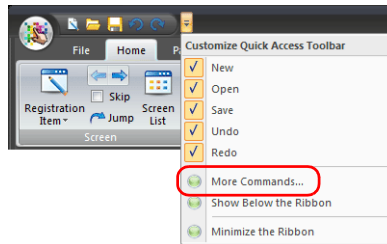

2. The [Customize] window is displayed.
Select the icons to add and click the [Add] button.

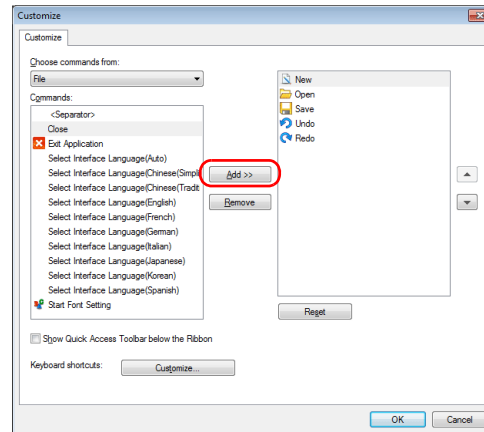

3. Check that the icons are added to the right-side window and click [OK].

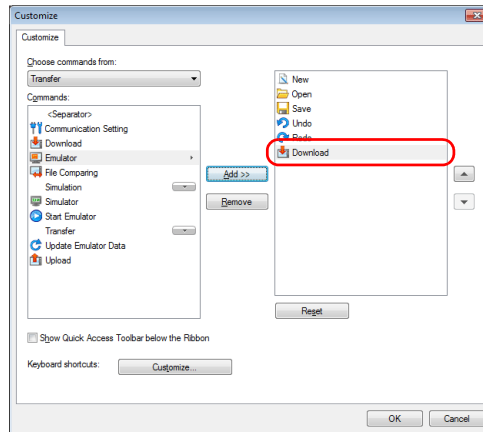

4. The icons are added to the quick access toolbar.

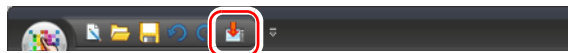

2.3.4 Ribbon Menu

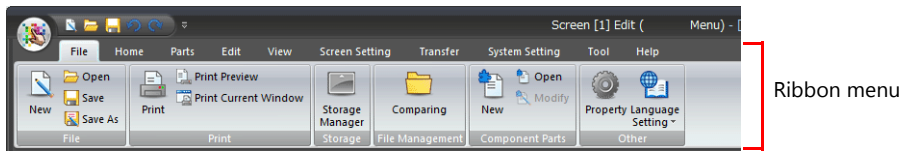

Item	Description
File	Perform operations including new file creation, printing, storage manager startup, file comparison, component parts editing, and property configuration.
Home	Register registration items, switch between the screen for editing, and place primary parts and items.
Parts	Place parts and items.
Edit	Perform helpful operations during editing including copying, cutting, pasting, grouping, placement, and arrangement.
View	Change the state of switches and lamps, switch between multiple languages, show/hide each view window, configure grid display settings, configure display environment settings, and set the magnification.
Screen Setting	Configure the screen background color and macros, function switches, and function item settings.
Transfer	Transfer screen programs and execute the simulation function.
System Setting	Select the model for editing and configure unit settings, communication settings, and function settings common to all screens.
Tool	Execute helpful functions including error checking, search, and batch device memory change.
Help	Refer to manuals and check version information.

File

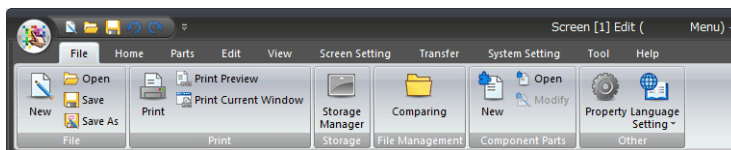

Item	Description	
File	New	Create a new screen program file.
	Open	Open an existing screen program file. V8 series screen program files can be opened and converted to V9 series screen program files.
	Save	Save the file currently being edited (if it is a new file, you must give it a filename.)
	Save As	Save the file currently being edited to a new file with a different filename.
Print	Print	Print out the created screen program file from the printer connected to the computer. For more information, refer to "9.2 Printing".
	Print Preview	Display a preview of printer output. For more information, refer to "9.3 Print Preview".
	Print Current Window	Print out the currently open window.
Storage	Storage Manager	The storage manager is an application that facilitates writing of data used by the V9 series unit to a storage device, such as an SD card or USB flash drive, and importing of data from a storage device for conversion into other file formats. For more information, refer to "8 Storage Device" in the V9 Series Reference Manual 2.
File Management	Comparing	Execute a file comparison. For more information, refer to "2.8 File Comparison" page 2-66.
Component Parts	New	Perform editing of component parts. For more information, refer to "11.4 Component Parts".
	Open	
	Modify	
Other	Property	Check the information on the current file and configure the editing environment. For more information, refer to page 2-15.
	Language Setting	Select the display language to use for menus in the editor.

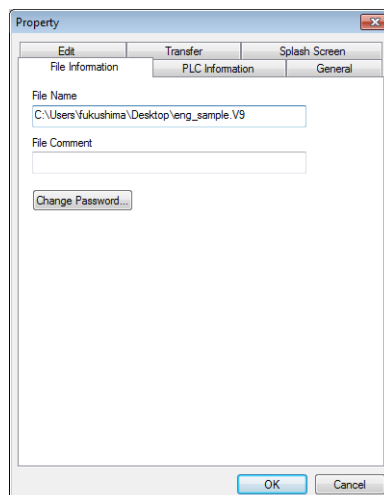
[Property] window

Item	Description	Refer to
File Information	Set a file comment and change the password.	page 2-15
PLC Information	Displays the set PLC information.	page 2-16
General	Configure environment settings, such as title displays and automatic saving.	page 2-16
Edit	Configure editing environment settings.	page 2-17
Transfer	Configure message transfer settings for selective transfers and text.	page 7-39, page 7-45
Splash Screen	Configure these settings when displaying a splash screen.	V9 Series Reference Manual 2

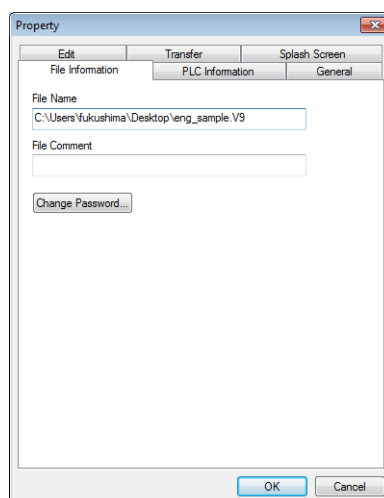
[File Information]

Item	Description
File Name	Displays the name of the screen program file and the path of the storage target folder.
File Comment (16 one-byte characters/8 two-byte characters max.)	A comment for the current screen program file can be entered. The entered comment is transferred together with the screen program file to MONITOUCH and can be checked in Local mode.
Change Password (6 one-byte alphanumeric characters max.)	It is possible to prohibit screen program files from being opened in the editor. Once a password is set here, the password must be subsequently entered each time the file is opened or when displaying data loaded from MONITOUCH. A password ensures security against unauthorized access.



Manage the password on your own. Note that Hako Electronics is not liable for any damages resulting from unknown or forgotten passwords.

[PLC Information]

This tab shows the device names designated as PLC 1 to PLC 8 in the [Hardware Setting] window.

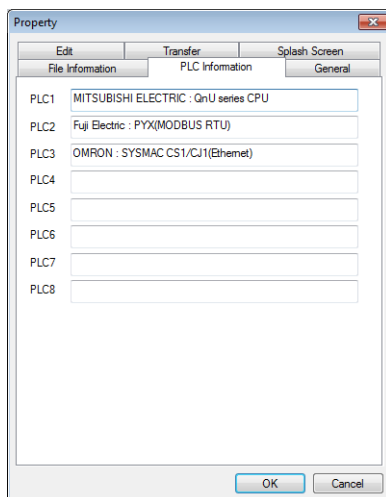

[General]

Configure environment settings, such as title displays and automatic saving.

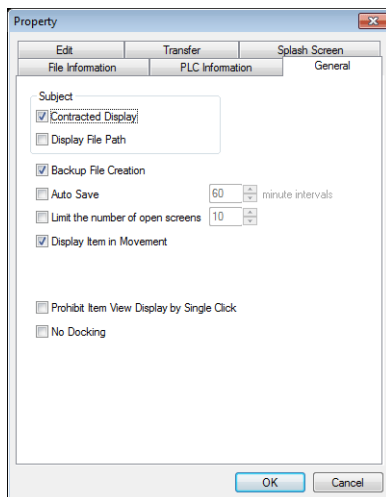

Item	Description
Contracted Display *	Shorten the product name displayed in the window title at the top of the editor.
Display File Path *	Display the path of the screen program file in the window title at the top of the editor. When this checkbox is unselected, the path is not displayed.
Backup File Creation	Always create a backup file (with extension "*.bak") when saving a screen program file. (Data previously saved is saved as a backup file, which is different from the saved data.) If unnecessary, deselect the checkbox.
Auto Save	Automatically save the screen program file at regular intervals (setting range: 10 to 60 minutes). When auto-saving a newly created screen program for the first time, you will be prompted to name the file. The auto-save function does not work when the macro editing window or the message window is open.
Limit the number of open screens	Set the maximum number of windows that can be open when the editor is running. When this checkbox is unselected, you can open as many windows as possible.
Display Item in Movement	Display parts graphically on the editor while moving them. When this checkbox is unselected, a dotted box showing the part size is displayed instead.
Prohibit Item View Display by Single Click	Double-click to display the item view window, such as for drawing parts.
No Docking	Select this checkbox to prevent item view windows from being inset into the editing screen.

*** Title display examples**

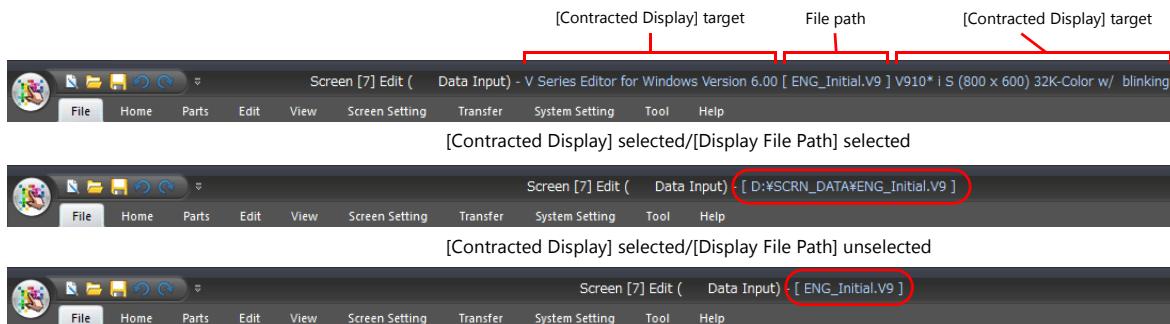

[Edit]

Configure editing environment settings.

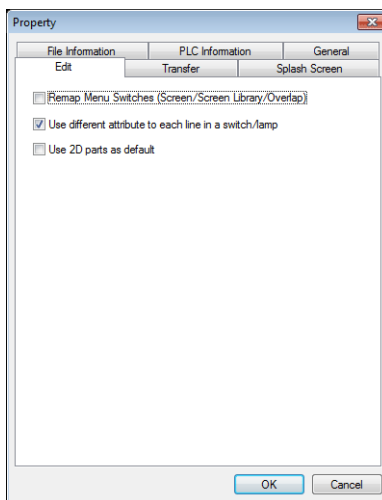

Item	Description
Remap Menu Switches (Screen/Screen Library/Overlap)	When moving screens or overlaps, on the [Screen List] tab window for example, automatically remap values such as switch target numbers as well as associated functions. For more information, refer to page 2-58.
Use a different attribute to each line in a switch/lamp	When registering text for switches and lamps, allow different text properties on each line.
Use 2D parts as default	Place 2D parts as the default parts when placing parts from the menu.

[Transfer]

For more information, refer to "7.7 Selective Transfer" page 7-39 and "7.8 Message/Comment Transfer" page 7-45.

[Splash Screen]

Set the screen that is displayed when the V9 series unit starts up. For more information, refer to the V9 Series Reference Manual 2.

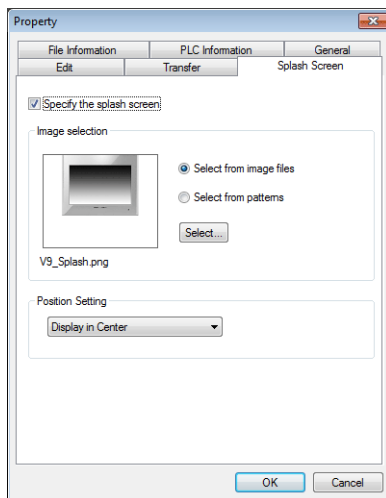

Home

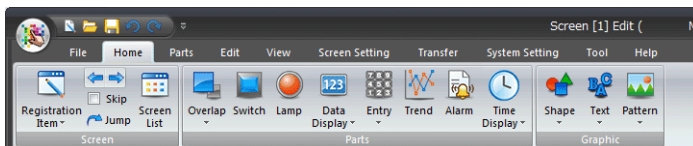

	Item	Description	Refer to
Screen	Registration Item	Configure registration items, such as overlap libraries and messages.	"6 Registration Items"
	Previous Screen	Displays the previous screen.	"2.6 Basic Operations"
	Next Screen	Displays the next screen.	
	Skip	Select this checkbox to skip unregistered screens when changing between screens.	
	Screen List	Displays a list of screens being edited or overlap libraries.	
Parts	Overlap	Place an overlap.	"3.4 Placing and Setting Parts"
	Switch	Place a switch.	
	Lamp	Place a lamp.	
	Data Display	Place a data display (numerical data display, character display, message display, table data display).	
	Entry	Place a keypad for entry and entry mode icon.	
	Trend	Place trend parts.	
	Alarm	Place alarm parts.	
Graphic	Time Display	Place a time display part and calendar part.	"3.6 Shape and Text Graphics"
	Shape	Place parts including line, rectangle, circle, paint, dot, and pattern.	
	Text	Place text and multi-text.	
	Pattern	Place an image file pasted as a picture part, pattern, or other part.	

Parts

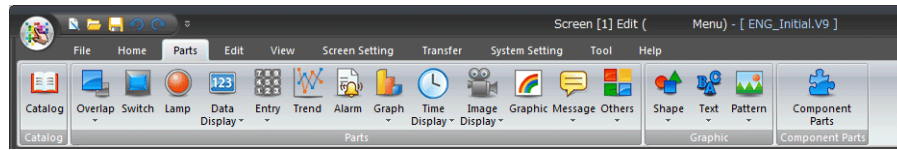

Item	Description	Refer to
Catalog	Display the parts catalog.	"3.2.2 Placement from the [Catalog] View Window"
Parts	Overlap	Place an overlap.
	Switch	Place a switch.
	Lamp	Place a lamp.
	Data Display	Place a data display (numerical data display, character display, message display, table data display).
	Entry	Place a keypad for entry and entry mode icon.
	Trend	Place trend parts.
	Alarm	Place alarm parts.
	Graph	Place a bar graph, pie graph, closed area graph, panel meter, statistic bar graph, and statistic pie graph.
	Time Display	Place a time display part and calendar part.
	Image Display	Place a video/RGB display, JPEG display, network camera display, and remote desktop display.
	Graphic	Place a graphic part.
	Message	Place message parts and a comment part.
	Others	Place recipe parts, slider switch, data block area, and memo pad parts.
Graphic	Shape	Place parts including line, rectangle, circle, paint, dot, and pattern.
	Text	Place text and multi-text.
	Pattern	Place an image file pasted as a picture part, pattern, or other part.
Component Parts	Place a component part.	"3.7 Component Parts"

Edit

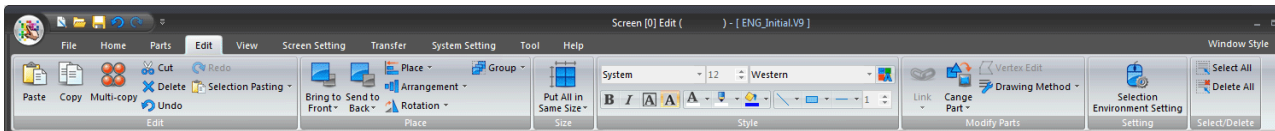

Item	Description	Refer to	
Edit	Paste	Paste the item on the clipboard onto the screen.	"4.1.1 Edit"
	Copy	Copy the selected item to the clipboard.	
	Multi-copy	Copy the selected item and paste multiple instances of the item.	
	Cut	Cut the selected item and move it to the clipboard.	
	Delete	Delete the selected item.	
	Undo	Restore the screen to the state before the last action was performed.	
	Redo	This command becomes active when [Undo] is performed. Click this button to restore the screen to the state before [Undo] was executed.	
	Selection Pasting	Copy the selected item and paste it onto the specified screen. Or undo selection pasting.	
Place	Bring to Front	Move the selected item into the foreground.	"4.1.2 Place"
	Send to Back	Move the selected item into the background.	
	Place	Align the placement position of multiple selected items.	
	Arrangement	Arrange multiple selected items vertically or horizontally at regular intervals.	
	Rotate	Rotate the selected item.	
	Group	Group or ungroup multiple selected items.	
Put All in Same Size	Change the size of multiple selected items to that of a reference part.	"4.1.3 Size"	
Style	Change the color, style, and text font of graphic parts.	"4.1.4 Style"	
Modify Parts	Link	Set the ID of multiple selected items to the same ID.	"3.3 Changing a Part After Placement"
	Change Part	Edit the selected item.	"11 Parts Editing"
	Vertex Edit	Use this command to change the angular position or radius of polygons.	
	Drawing Method	Change the drawing method used for polygons and round parts.	
Setting	Selection Environment Setting	Change the types of parts that can be selected using the mouse.	"4.1.6 Selection Environment Setting"
Select/Delete	Select All	Select all items on the screen.	"4.1.7 Select/Delete"
	Delete All	Delete all items on the screen.	

View

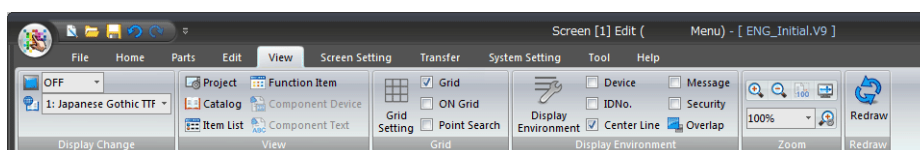

Item	Description	Refer to
Display Change	State Change	Change the display state of switches and lamps.
	Language Display	Change the display language number when using multi-language screens.
View	Project	Display the project list view window.
	Catalog	Display the catalog view window.
	Item List	Display the item list view window.
	Function Item	Display the function item view window.
	Component Device	Display the component device view window.
	Component Text	Display the component text view window.
Grid	Grid Setting	Display the [Grid Setting] window.
	Grid	Display a grid in the editing area.
	ON Grid	Snap items to the grid.
	Point Search	Place the selected item on the vertex of another item.
Display Environment	Display Environment	Configure detailed display environment settings.
	Device	Display the device memory set for parts.
	IDNo.	Display the ID number of parts.
	Center Line	Display center lines in the editing area.
	Message	Display the messages set for items such as alarm parts.
	Security	Display the set security level.
Zoom	Zoom In	Increase the display magnification of the screen.
	Zoom Out	Reduce the display magnification of the screen.
	100%	Display the screen at 100% magnification.
	Fit in Display Area	Display the screen at a magnification that matches the display range of the editor.
	Scaling Display	Display the screen at the specified magnification.
Redraw	Redraw the screen.	

Screen Setting

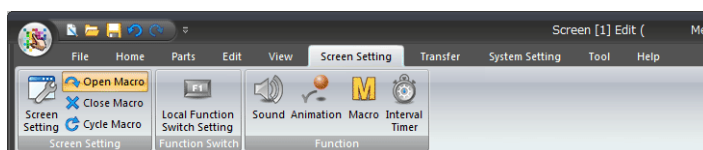

Item	Description	Refer to
Screen Setting	Screen Setting	Set items unique to the current screen, such as screen background and comments.
	Open Macro	Register an open macro.
	Close Macro	Register a close macro.
	Cycle Macro	Register a cycle macro.
Function Switch	Local Function Switch Setting	Configure local function switch settings.
Function	Sound	Register a sound function.
	Animation	Register an animation.
	Macro	Register a macro mode.
	Interval Timer	Register an interval timer macro.

Transfer

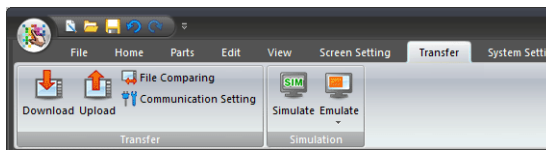

Item	Description	Refer to	
Transfer	Download	Write the screen program to the V9 series unit.	"7 Transfer"
	Upload	Read the screen program from the V9 series unit.	
	File Comparing	Compare the program in the editor with the program on the V9 series unit.	
	Communication Setting	Configure the settings for communication between the PC and V9 series unit.	
Simulation	Simulator	Start the simulator.	"8 Simulation"
	Emulator	Start the emulator.	

System Setting

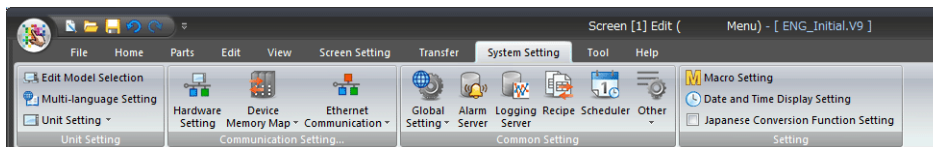

Item	Description	Refer to	
Unit Setting	Edit Model Selection	Select the V9 series model for which to configure a screen program.	V9 Series Reference Manual 1
	Multi-language Setting	Set the languages displayed on the V9 series unit.	
	Unit Setting	Configure settings for the V9 series unit, such as the backlight and buzzer.	
Communication Setting	Hardware Setting	Select the types of controller models connected to the V9 series unit.	V9 Series Reference Manual 1
	Device Memory Map	Configure the settings to use when performing batch data transfer or sampling between controllers.	V9 Series Reference Manual 2
	Ethernet Communication	Configure the local port (V9 series) IP address, network table, email, and FTP server settings.	
Common Setting	Global Setting	Configure global function switch settings and global overlap settings.	V9 Series Reference Manual 1
	Alarm Server	Configure alarm server settings.	
	Logging Server	Configure logging server settings.	
	Recipe	Configure recipe settings.	V9 Series Reference Manual 2
	Scheduler	Configure scheduler settings.	
	Other	Configure storage settings, memory card settings, MES settings, operation log settings, security settings, remote desktop table settings, network camera table settings, time display format settings, and scrolling message settings.	
Setting	Macro Setting	Set the initial macro, global macro, and event timer macros.	V9 Series Macro Reference
	Date and Time Display Setting	Set the date and time format to display for items such as alarm parts.	V9 Series Reference Manual 1
	Japanese Conversion Function Setting	Select this checkbox to use the Japanese conversion function.	

Tool

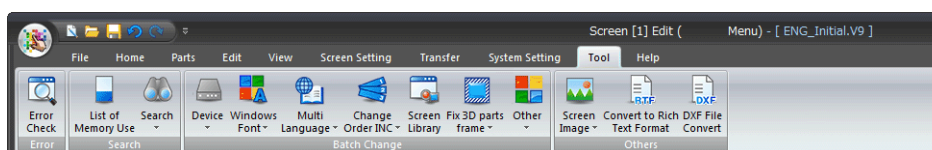

	Item	Description	Refer to
Error	Error Check	Perform an error check on the screen program currently being configured.	"5.2 Error Check"
Search	List of Memory Use	Display the available capacity of the screen program currently being configured.	"5.3 List of Memory Use"
	Search	Search device memory addresses, tag usage, text, Windows fonts, and macro commands.	"5.4 Search"
Batch Change	Device	Perform a batch change of device memory addresses.	"5.5 Batch Change"
	Windows Font	Perform a batch change of Windows fonts.	
	Multi Language	Perform a batch change of properties such as language switching and text color.	
	Cursor Order INC	Perform a batch change of cursor movement order numbers.	
	Screen Library	Perform a batch change of specified numbers of screen libraries placed on the screen.	
	Fix 3D parts frame	Perform a batch change of the frame size of real type and 3D square type parts.	-
Other	Perform a batch change of overlap transparency settings.		
Others	Screen Image	Capture an image of the displayed screen. Select from the three commands of saving as a pattern image, copying to the clipboard, and saving to an image file.	"5.6 Others"
	Convert to Rich Text Format	Save an image of the screen program currently being configured to a rich text format file. (extension: *.RTF)	
	DXF File Convert	Import a DXF file into the screen program currently being configured.	

Help

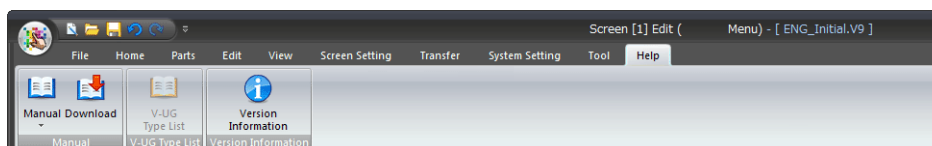

	Item	Description
Manual	Manual	Refer to manuals in PDF format. <ul style="list-style-type: none"> V9 Series Hardware Specifications V9 Series Connection Manual 1/2/3 V9 Series Reference Manual 1/2 V9 Series Operation Manual (this manual) V9 Series Macro Reference V9 Series Troubleshooting and Maintenance Manual V9 Series Training Manual Beginner's Guide/Practical Guide V9 Series Setup Manual
	Download	Display the website for downloading manuals.
	V-UG Type List	Reference the V series/UG series type comparative table.
	Version Information	Check detailed version information for V-SFT version 6.

2.3.5 Item Settings Window

This window is displayed by double-clicking on a placed item. The settings of parts can be checked and changed. The categories of settings are displayed on the left side of the window. Select a category for configuration.

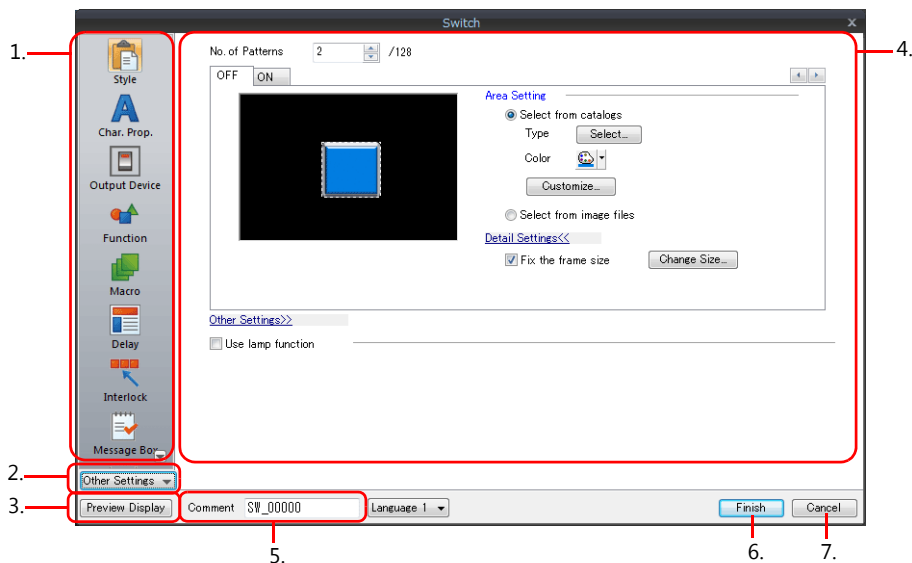

Item	Description	
1	Setting categories	Displays the setting categories available for the part.
2	Other Settings	Add categories that are not displayed to the setting category display area on the left side of the window.
3	Preview Display	Temporarily hide the item settings window and display the preview window.
4	Detailed settings	Configure the settings of the selected setting category.
5	Comment	Register a comment for the part. This is used in the operation log function. * For details on operation logs, refer to the V9 Series Reference Manual 2.
6	Finish	Accept any part settings made and close the item settings window.
7	Cancel	Cancel any part settings made and close the item settings window.

Other Settings

Add category menus that are not displayed to the setting category display area on the left side of the window. Click the [Other Settings] button and select the category to add to the setting category display area.

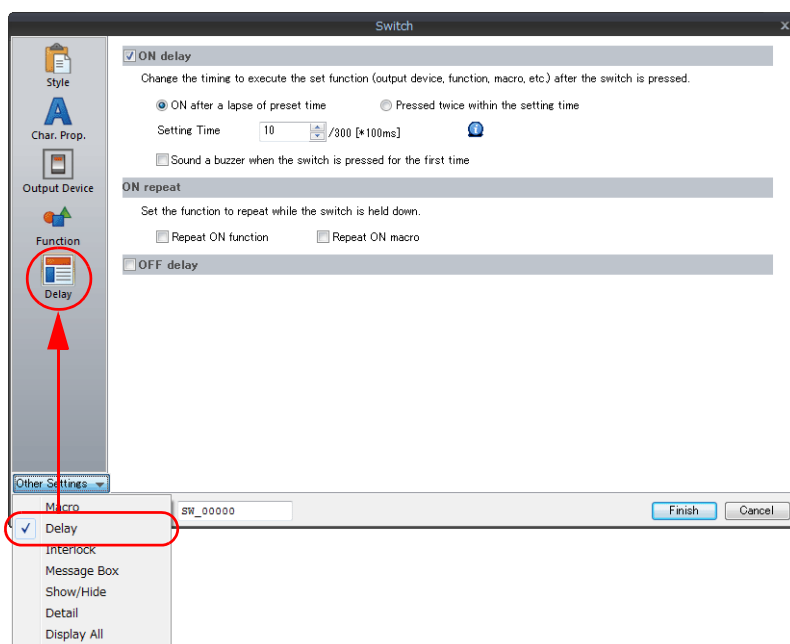

Preview Display

Temporarily hide the item settings window and display a preview of the screen for checking purposes. Double-click the preview screen to return to the item settings window.

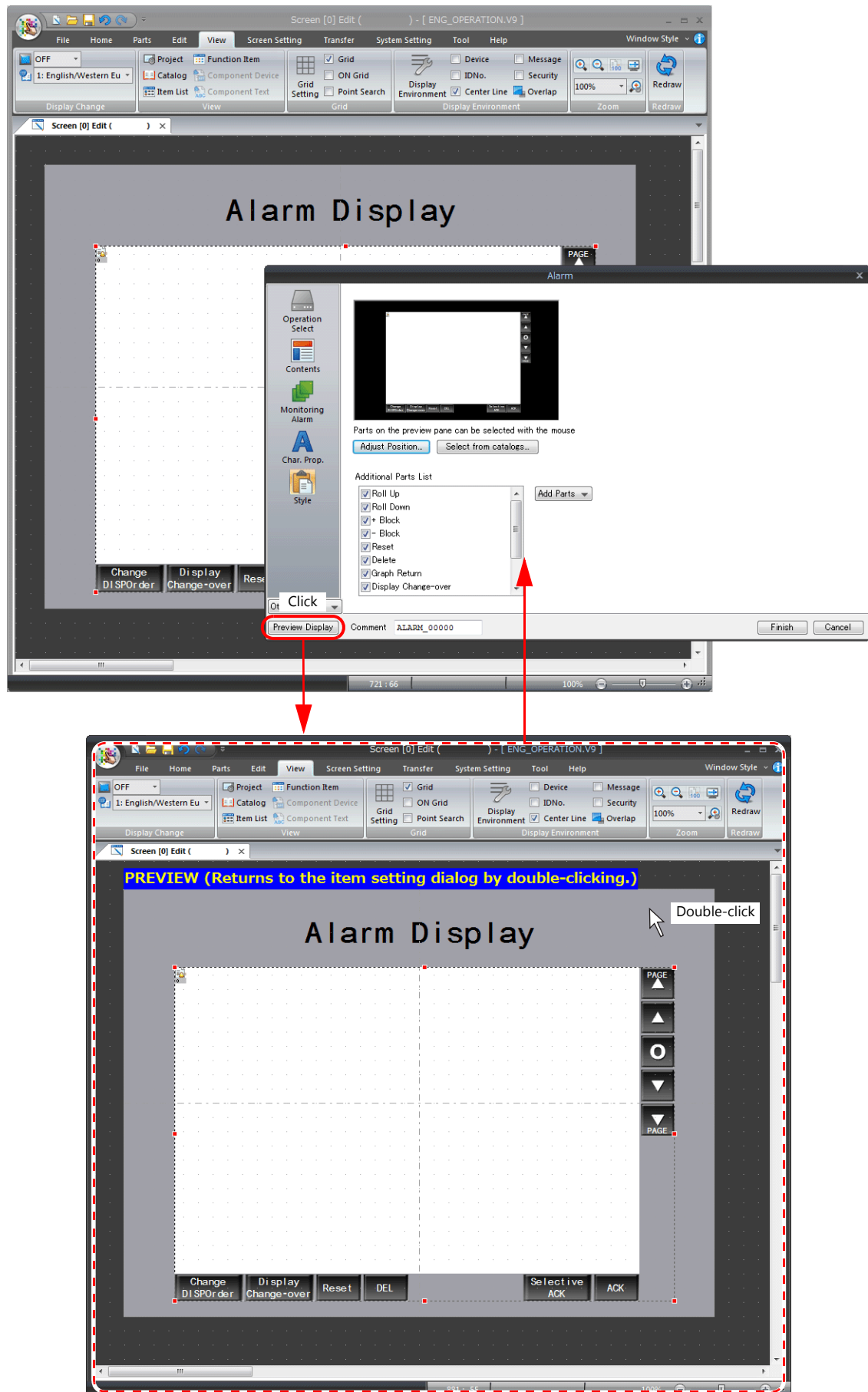

Style Settings of Linked Parts

The [Style] category is used to configure the settings of linked parts, such as adding or deleting associated switches and numerical data displays and changing the style and placement position of parts.

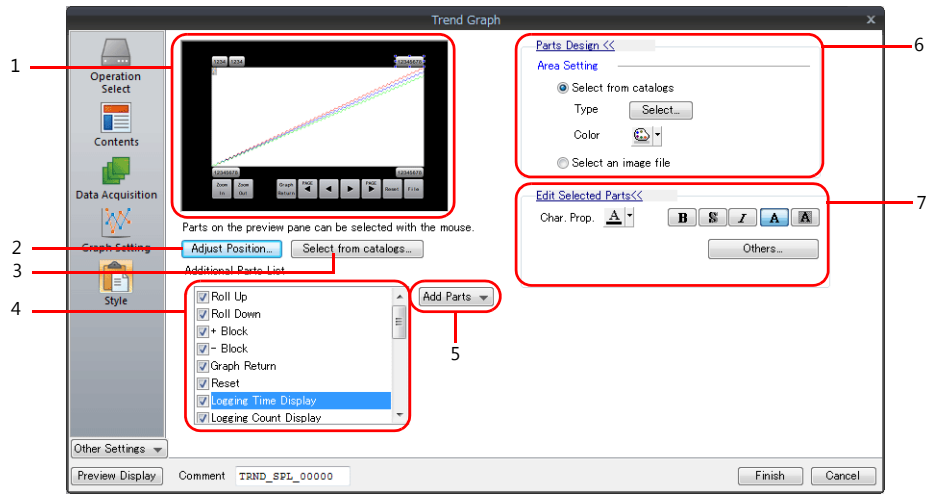

Item	Description
1 Preview pane	Displays a preview of the part.
2 Adjust Position	Display the position adjustment window. After changing the position of parts, double-click the linked parts to return to the item settings window.
3 Select from catalogs	Select the design of linked parts from the catalog.
4 Additional Parts List	Select the checkboxes of the associated function parts to use, such as switches and numerical data displays.
5 Add Parts	Use this button to add associated parts that are not displayed under [Additional Parts List].
6 Parts Design	This is displayed when a part in the preview pane is selected. Set the type and color of the selected part.
7 Edit Selected Parts	This is displayed when a part in the preview pane is selected. Set the displayed text and text properties for the part. Click [Others] to display the item settings window for the part selected in the preview pane and change the part's settings. For more information of the setting items for each part, refer to the V9 Series Reference Manual 1 and 2.

Position adjustment procedure

1. Click the [Adjust Position] button to display the position adjustment window.

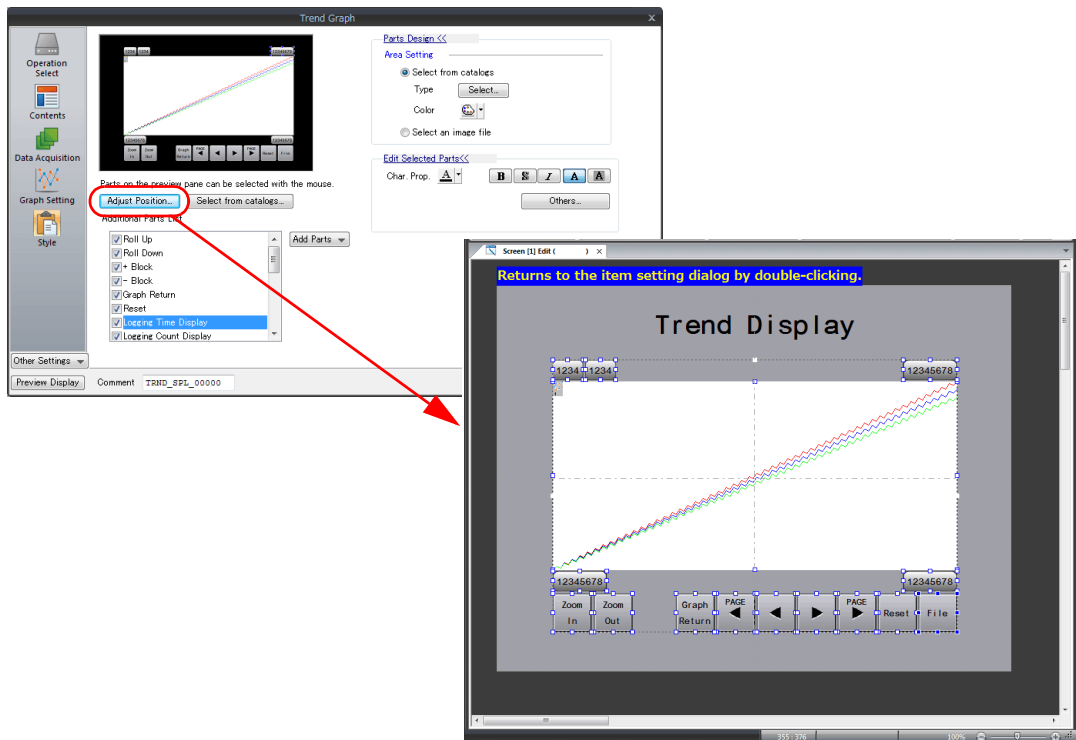

2. First, click on an empty area of the screen so that nothing is selected.

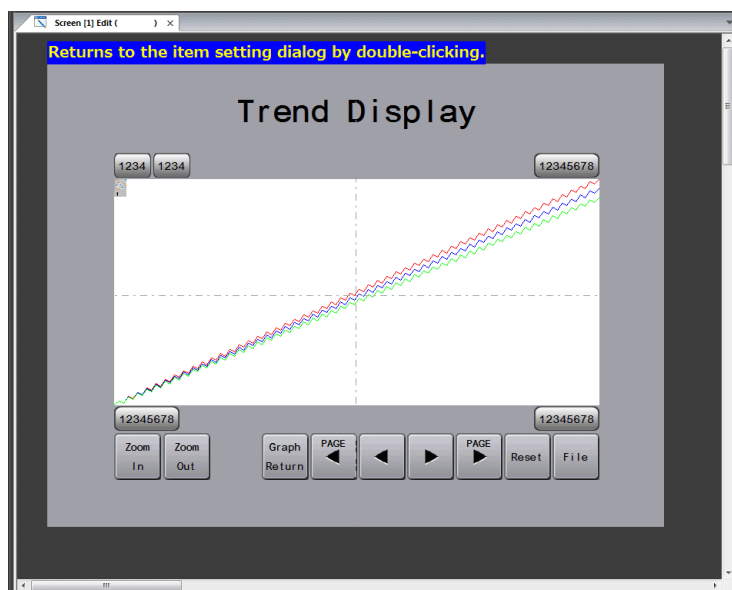

- Next, select the parts to move and drag the parts to change their position.

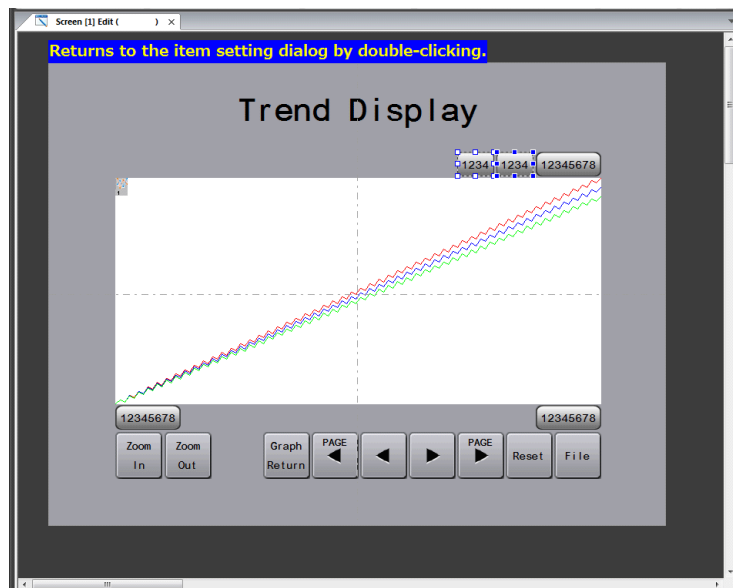
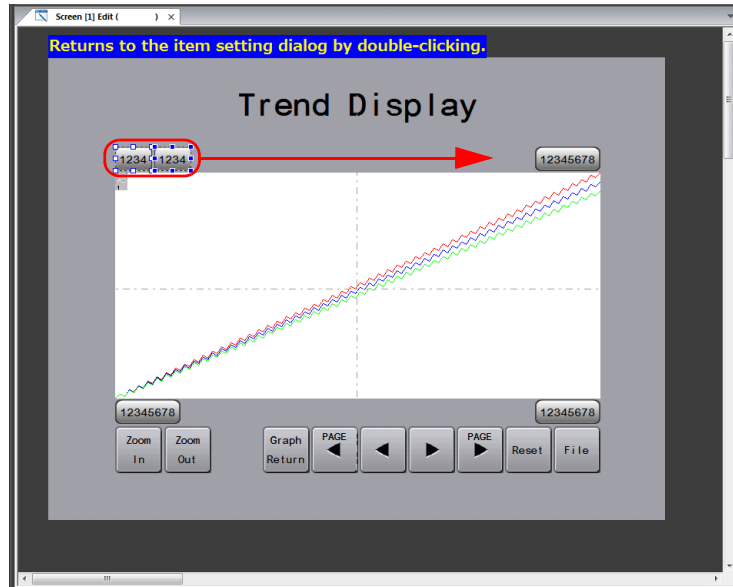

- After changing the position of the parts, double-click the screen to return to the item settings window.

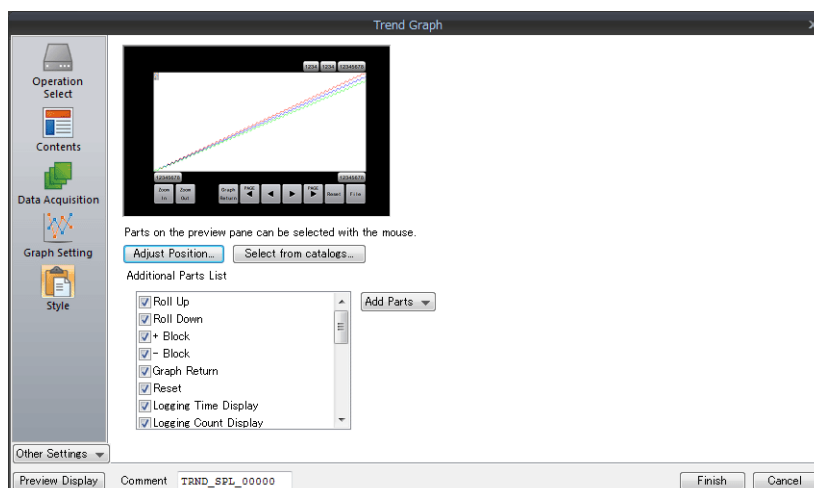

[Select from catalogs]

Click this button to display the [Part Type Select] window.
Specify settings for [Shape] and [Group] and select the desired parts.

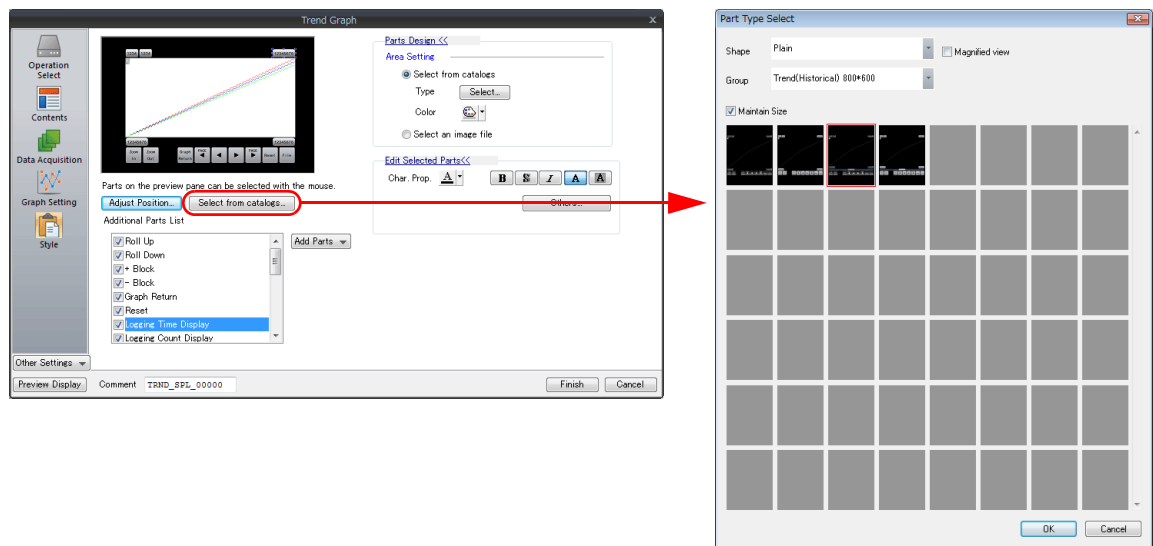

[Additional Parts List]

Select the checkboxes of the associated function parts to use, such as switches and numerical data displays. Deselect the checkboxes of any unnecessary parts to delete them.

- E.g.: Deleting the [Reset] switch

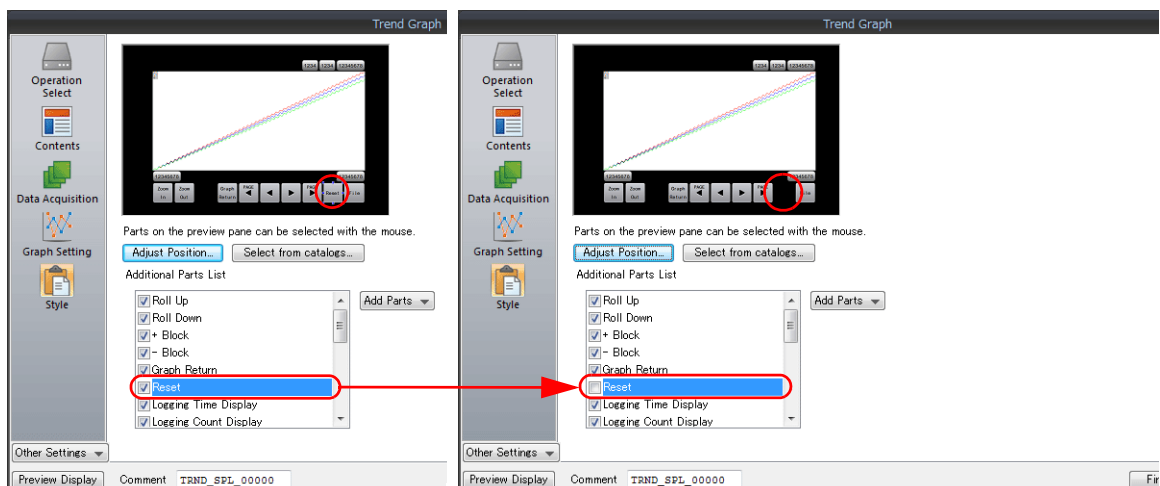

[Add Parts]

Click the [Add Parts] button to select additional parts. Selecting a part will display the item settings window for the part.

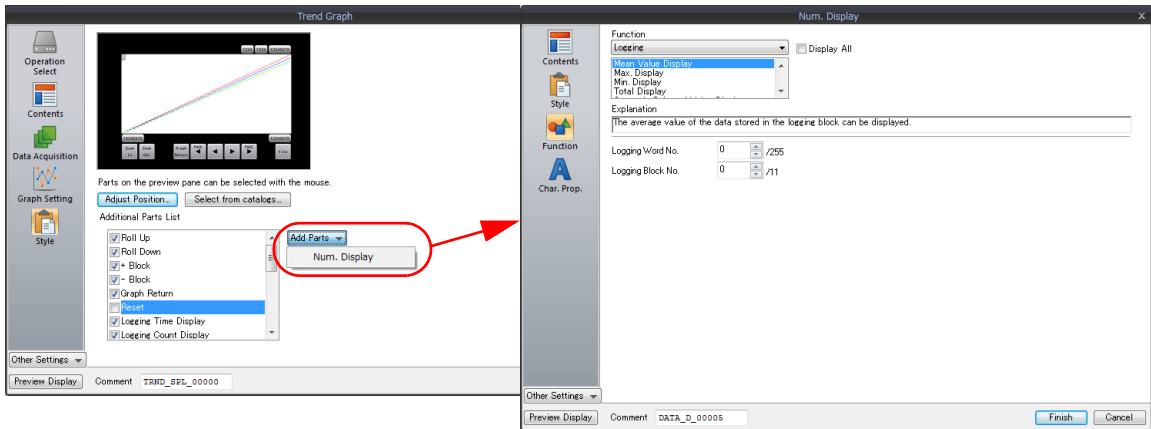

Select any functions and required items and click [Finish] to add parts to the linked parts.

- E.g.: Adding [Currently Selected Value Display] for a numerical data display

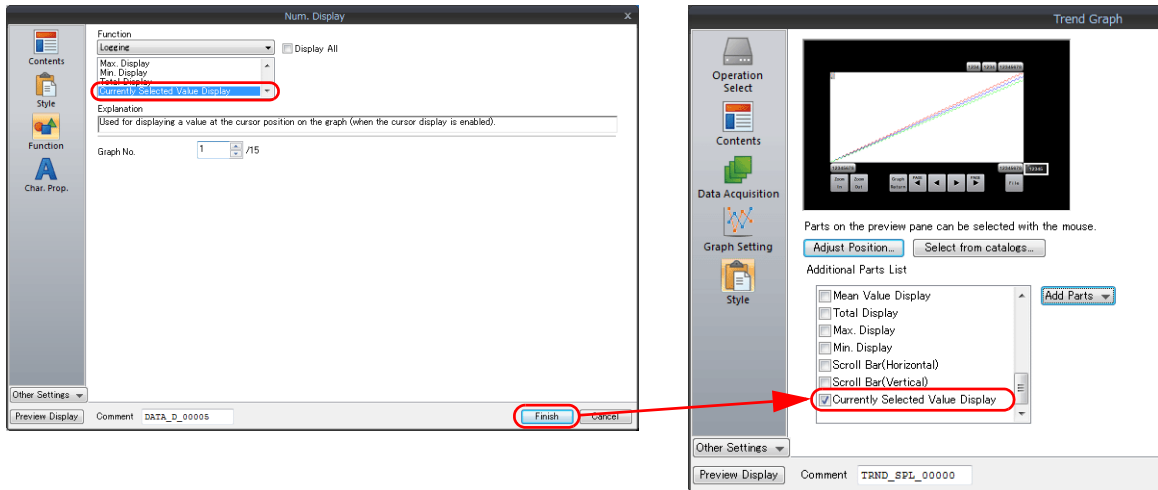

2.3.6 View Windows

Display Method

Use [View] on the ribbon menu to select and display the respective view window.

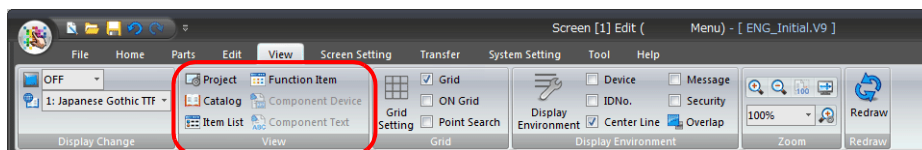

Types of View Windows

Project list view window

Use this view window to check and change system settings and settings of registered items.

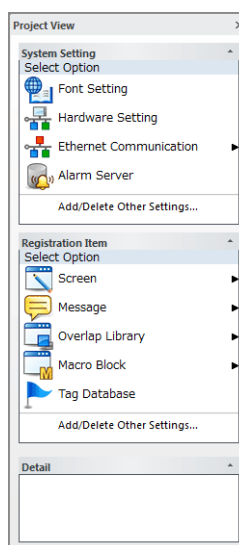

For more information, refer to "4.2.2 View".

Catalog view window

Use this view window when placing parts. Select parts and place them on the screen.

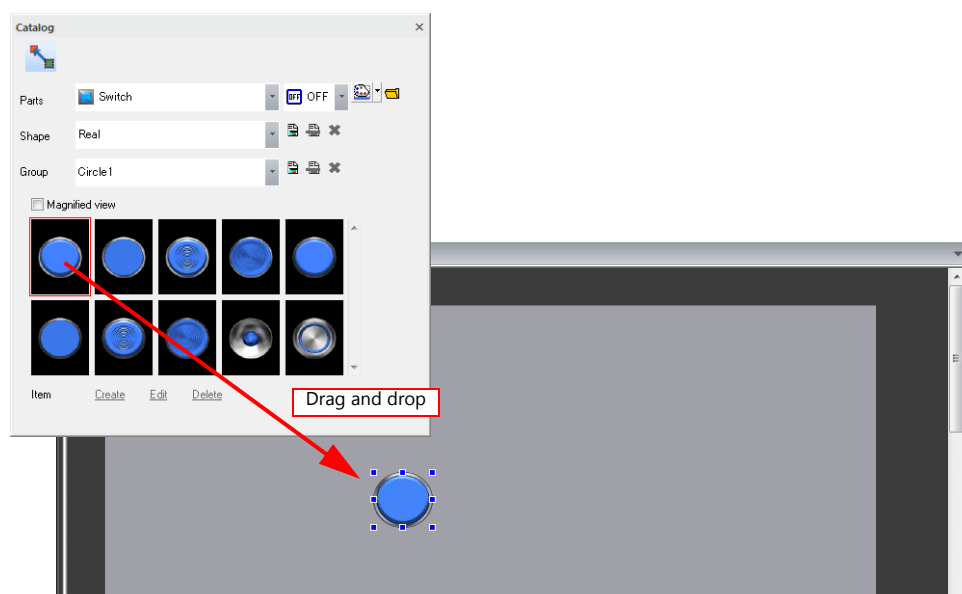

For more information, refer to "3.2.2 Placement from the [Catalog] View Window".

Item list view window

This view window displays a list of items placed on the screen.
 To change the settings of items that are difficult to locate or select, use this window to easily select the item for changing.

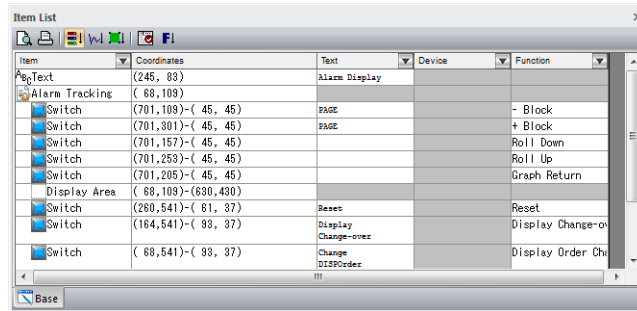

For more information, refer to "4.2.2 View".

Function item view window

Configure and check items that do not have an area on the screen (such as audio, animations, macro modes, and interval timer macros).

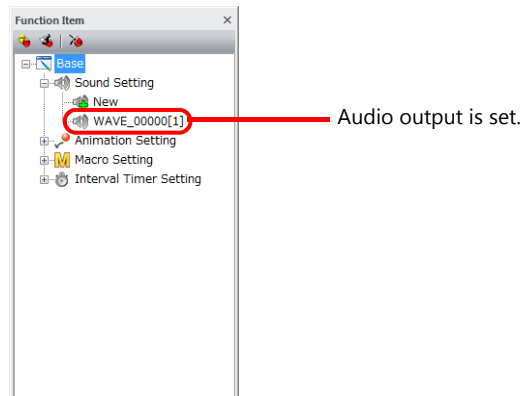

For more information, refer to "4.2.2 View".

Movement Method

Displayed view windows can be moved in the editor.

Double-click on the title bar of a view window or drag the title bar and move it to another position to change the window to the floating state.

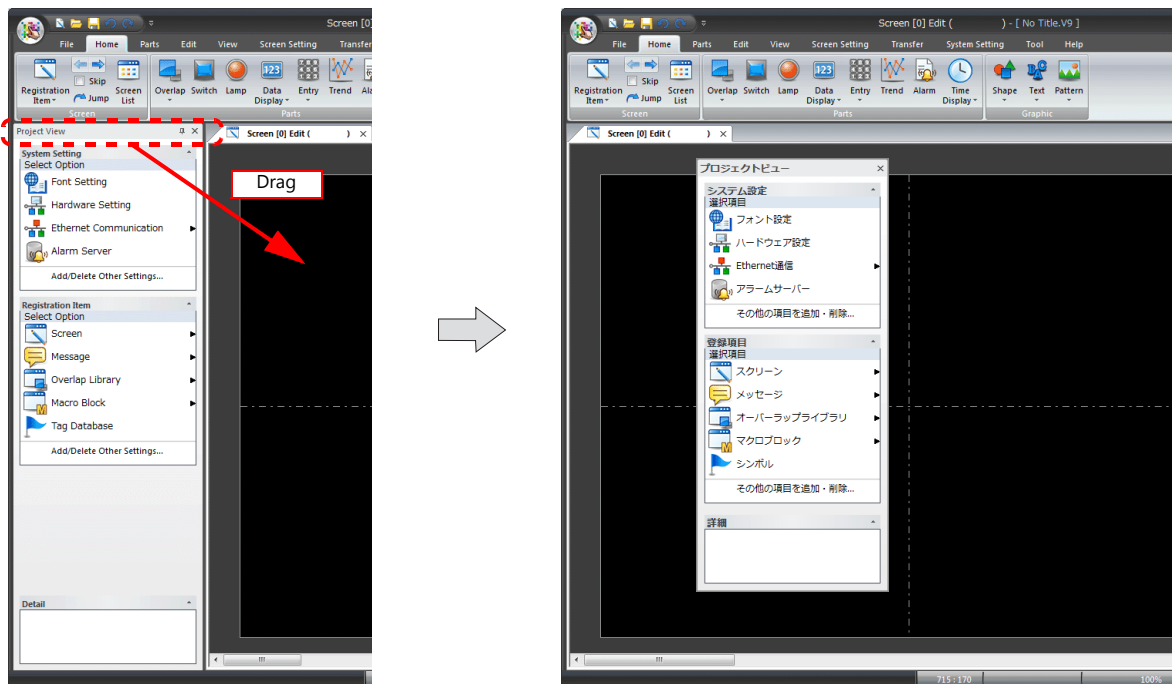

Docking

Double-click on the title bar of a view window or drag the title bar and move it to dock the window in the editor.

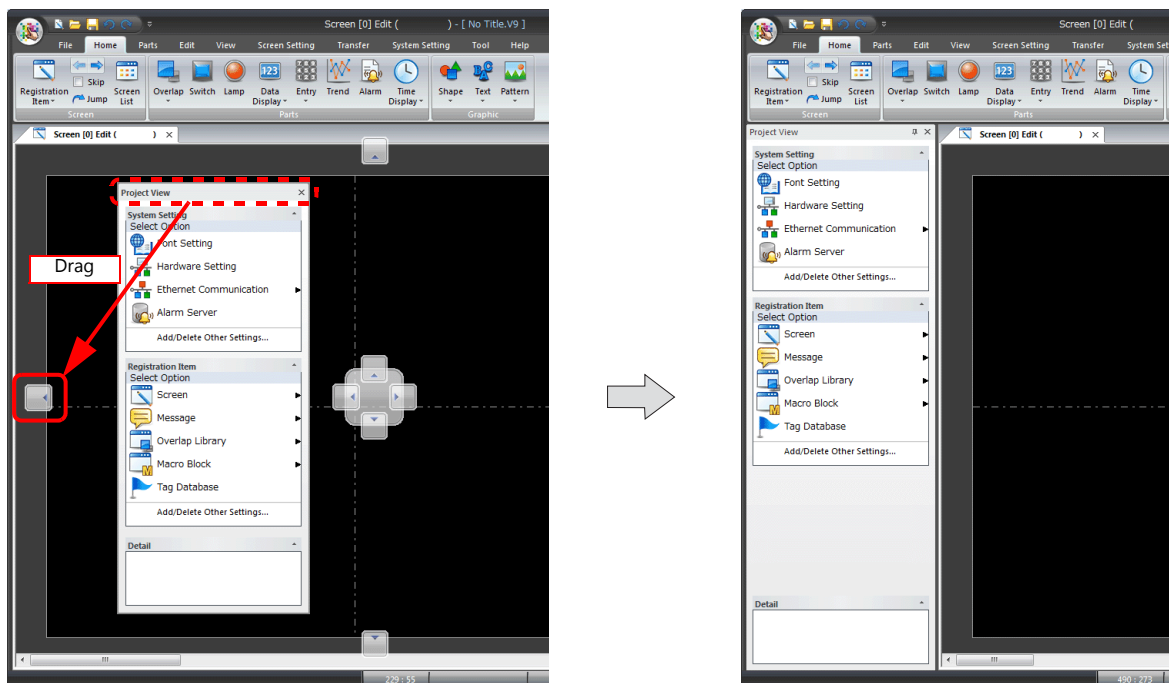

2.4 Types of Setting Menus

2.4.1 Menu Types

Pull-down Type

- Click the arrow button or item itself to bring up the pull-down menu.
- Click the desired item and then click [OK].

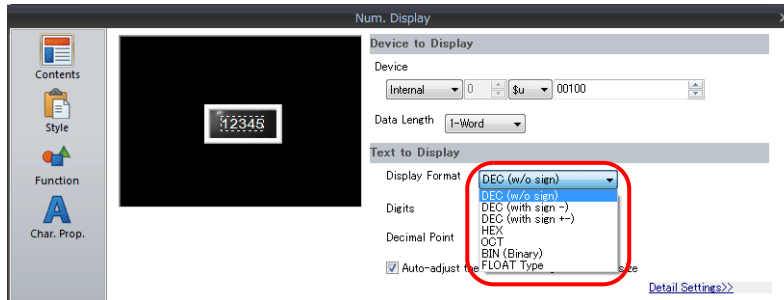

Option Button

- This button is used when there are two to four choices.

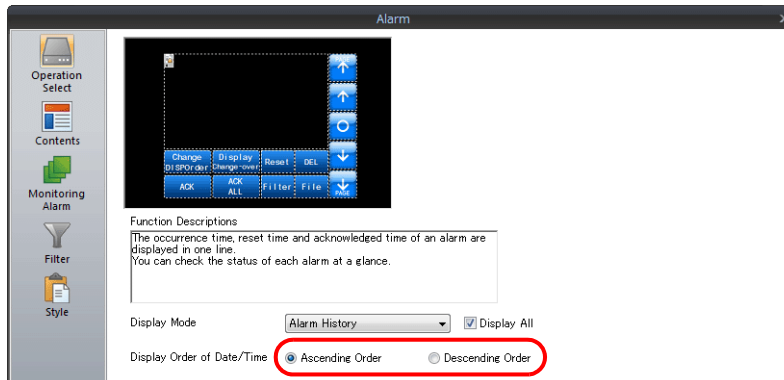

Numerical Data Entry: Box Type

- Change the value using the up/down arrow buttons.

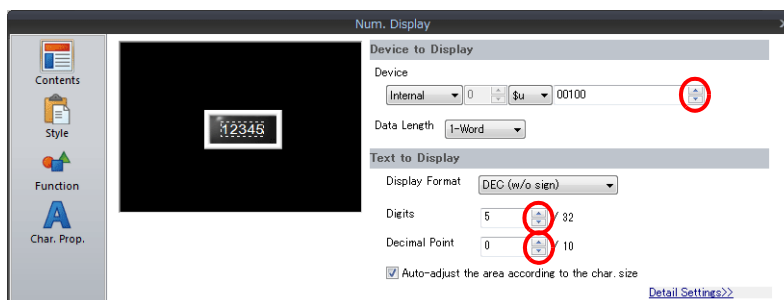

- A value can also be entered directly.

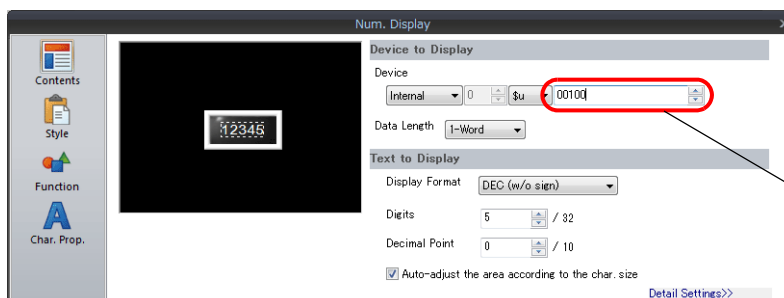

Enter the desired value directly.

Numerical Data Entry: Underlined Type

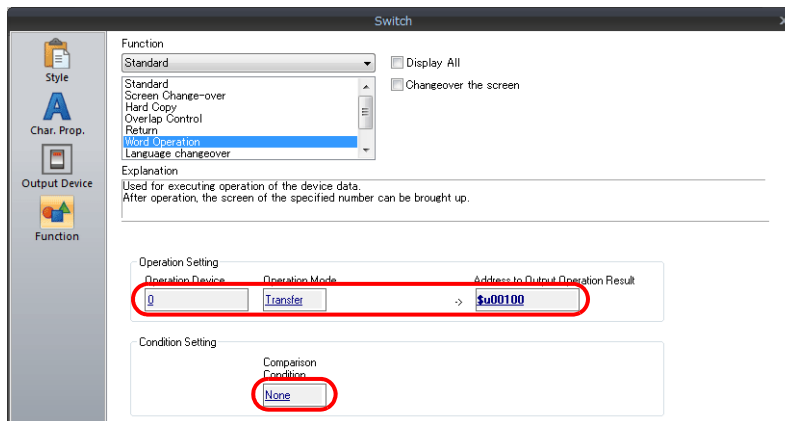

- Clicking the underlined data brings up the data entry menu. Enter the desired value in the data entry menu.

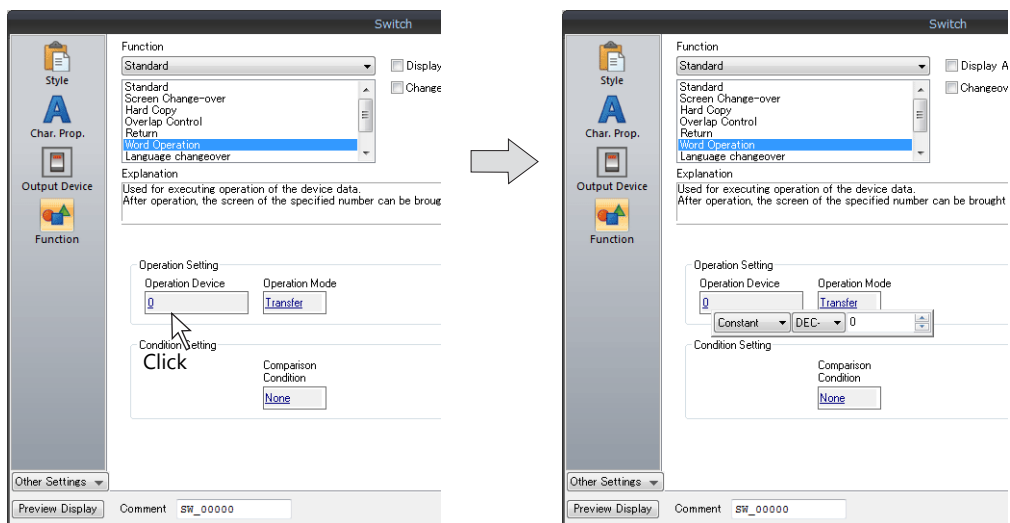

Checkbox

- Clicking the checkbox displays a check mark and enables the setting.

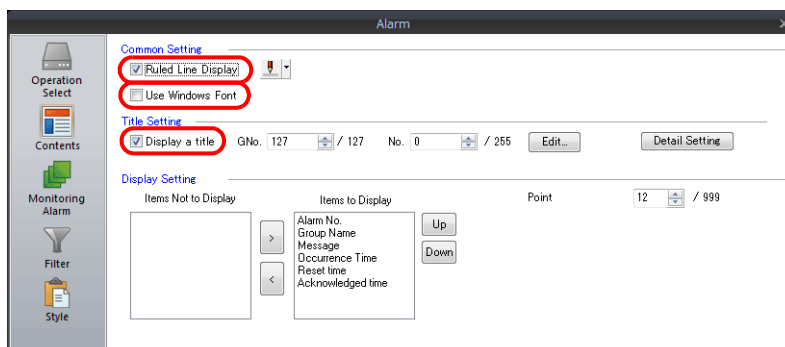

List Type

- Clicking an item displayed in the list highlights it. This indicates that the item is selected.

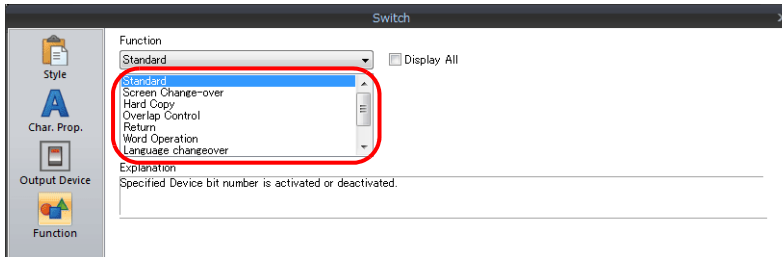

- If some options are hidden, they can be displayed using the scroll bar.

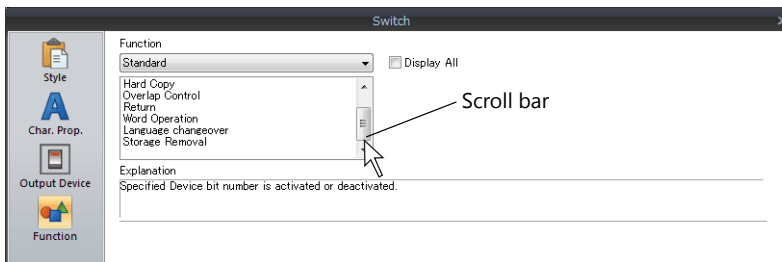

Command Buttons

- Clicking a command button moves to the next editing window or finishes the current editing task.

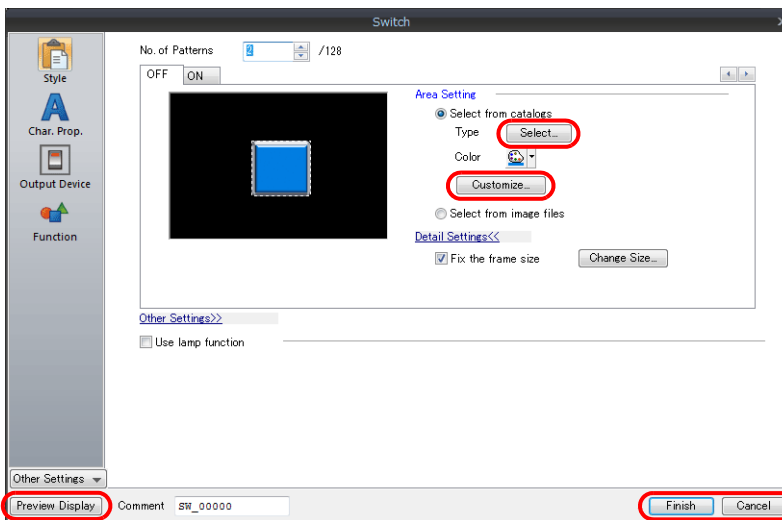

Detailed Settings >>

- Clicking this text displays additional settings.

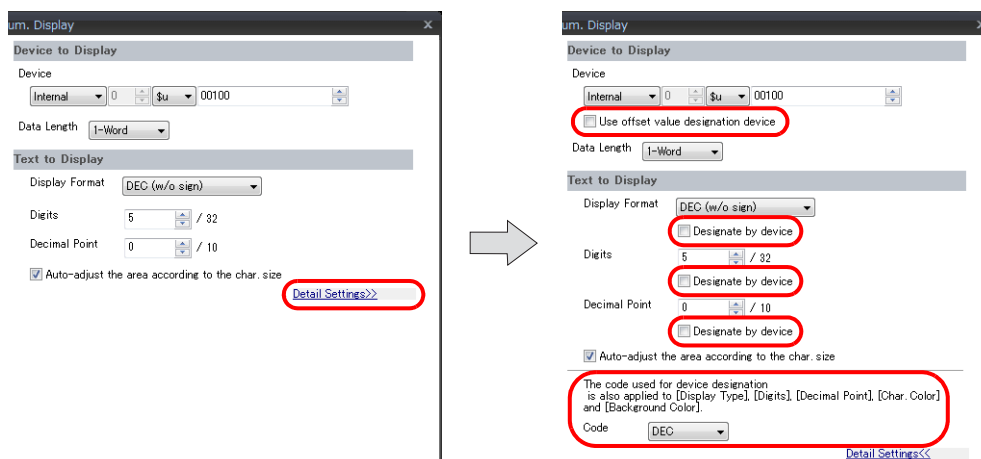

2.4.2 Device Memory Settings

There are three methods for specifying device memory such as PLC device memory and internal device memory. Select a method that facilitates configuration.

Changing the Specification Method

Right-click at the following location on a device memory setting to show the display selection menu for device memory. The specification method can be changed by selecting the desired display type.

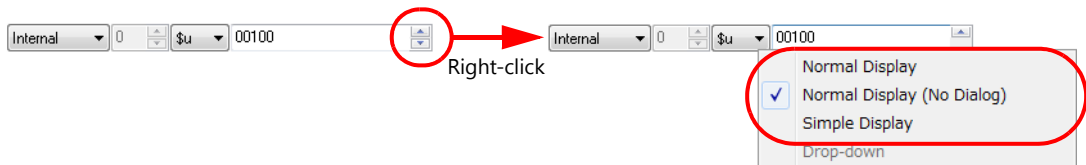

Device Memory Display Types and Specification Methods

Normal display

Clicking on a device memory setting item displays the [Device Input] window. Specify the device memory in this window.

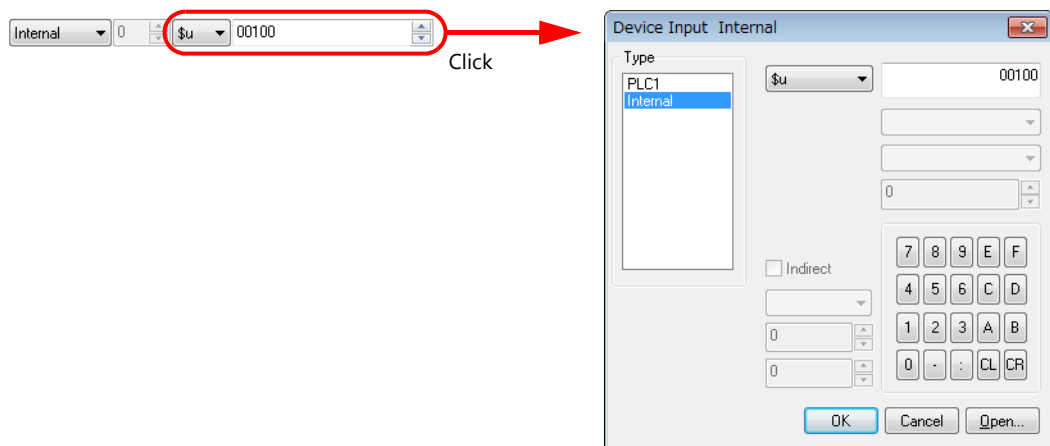

Normal display (no input window)

Directly specify the device memory using the device memory settings item. The [Device Input] window is not displayed.

- Selection method
 - 1) Select the device memory type and address type from the pull-down menu.



- 2) Change the value using the up/down arrow button next to the input field or directly enter the desired value into the field.

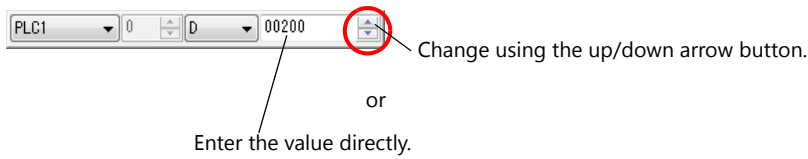

Simple display

A red keypad icon is displayed next to the device memory settings item. Clicking on the keypad icon displays the [Device Input] window. Specify the device memory in this window.

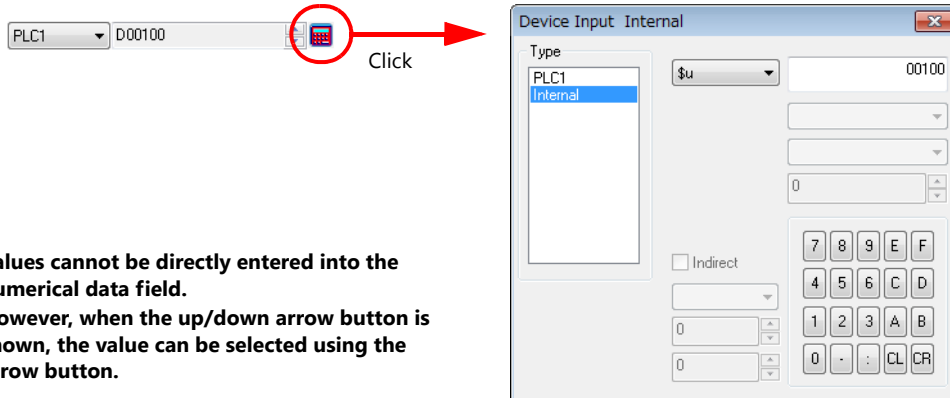

* Values cannot be directly entered into the numerical data field. However, when the up/down arrow button is shown, the value can be selected using the arrow button.

Types of Device Memory

PLC device memory

Set the device memory of connected PLCs.

E.g.: Mitsubishi [A Series Link] (1:1)

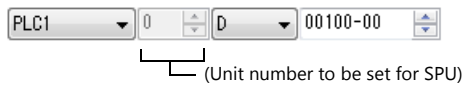

E.g.: Yokogawa [FA-M3] (1:1)

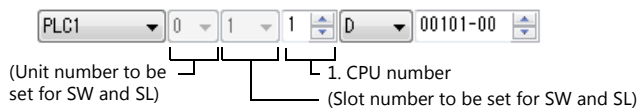

E.g.: Mitsubishi [A Series Link] (1:n)

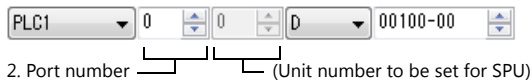

Item	Description
1. CPU number	This is displayed when Yokogawa [FA-M3] etc. is selected.
2. Port number	This is displayed when the connection mode is set to [1:n].

Internal device memory

Set the device memory area allocated on the V9 series unit.

Internal 0 \$u 00100

Item	Description
\$u	User device memory
\$L/\$LD	User device memory (non-volatile device memory)
\$T	User device memory (screen-specific device memory)
\$M	User device memory (macro device memory)
\$MC	User device memory (macro device memory in bytes)
\$C	User device memory (for component parts)
\$s	System device memory
\$P	System device memory (for 8-way communication)



For more information on the definition and range of internal device memory, refer to the V9 Series Reference Manual 1.

Address list

The address list becomes available when devices such as a temperature controller or inverter is used.

Click the calculator icon to display the [Device Input] window.

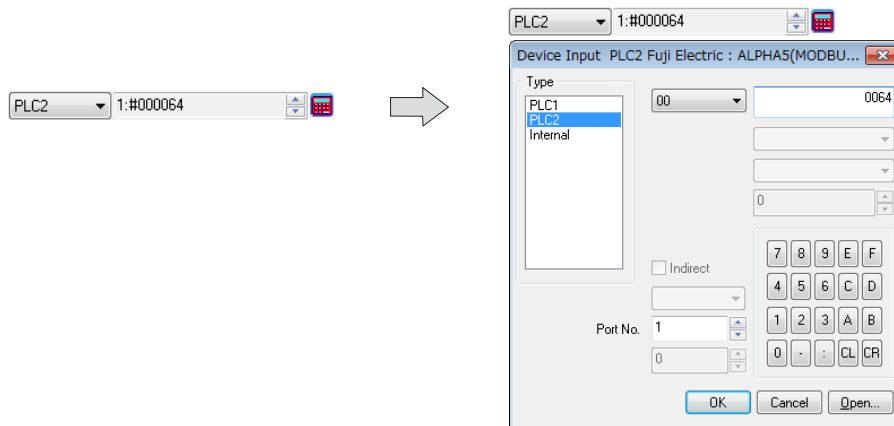

Clicking the [Open] button displays the address list of the selected temperature controller.

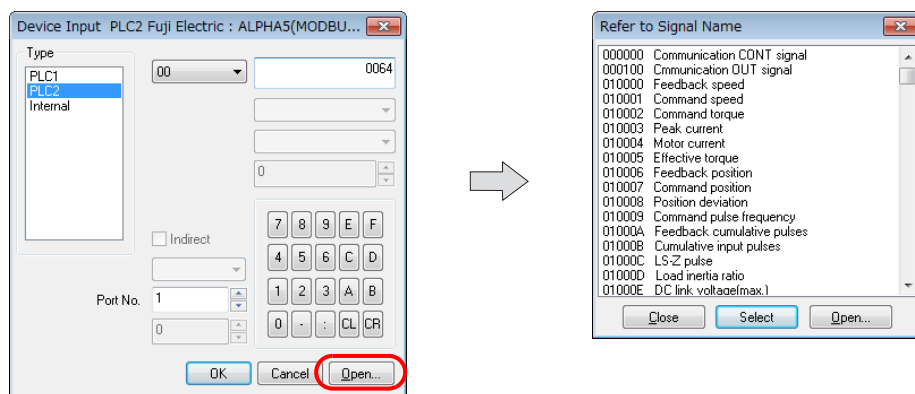

Select the desired address and click the [Select] button to select the memory address and return to the [Device Input] window.

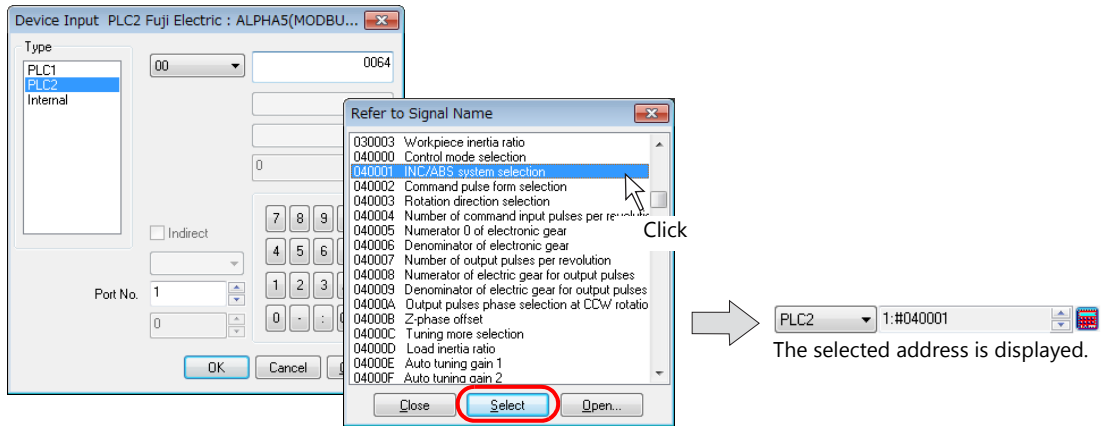

The selected address is displayed.

I/O device memory

This device memory is available when using communications that supports T-LINK I/O communications.

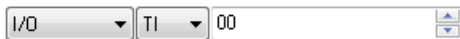

2.4.3 Color Settings

Color Type Setting

Select the color type by clicking [System Setting] → [Edit Model Selection] → [Color].

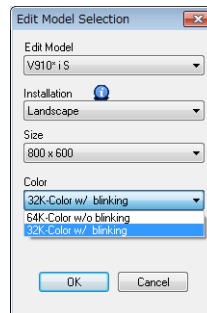

Color Type	Description
64K-Color w/o blinking	Setting of 65,536 colors is possible. Blinking cannot be specified.
32K-Color w/ blinking	Setting of 32,768 colors is possible. Blinking can be additionally specified.

Color Selection Procedure

1. Click the "▼" button on the right of the color change icon or the color change button.
A drop-down list for color selection is displayed.



2. Click the desired color in the pull-down menu.
The clicked color is applied as the color of the specified item(s) and/or the color change icon.

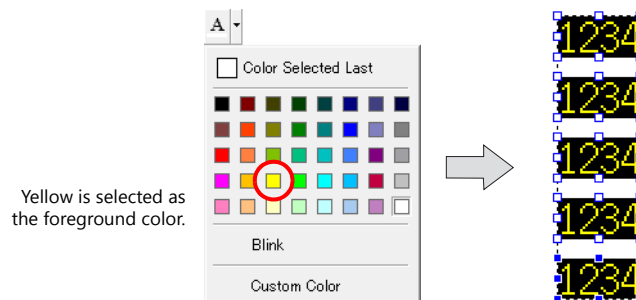

- If the desired color is not displayed in the pull-down menu, click [Custom Color].
The [Custom Color] window is displayed.

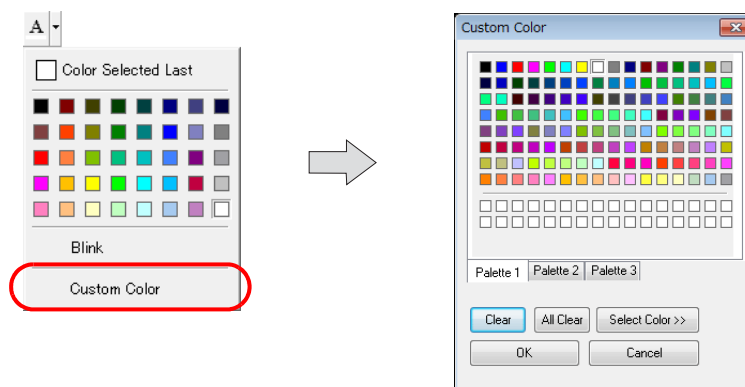

[Custom Color] Window

Select any color from a palette of 64k or 32k colors.

Clicking [Palette 1], [Palette 2], or [Palette 3] displays the corresponding color palette. Click the desired color and then click [OK] to display the graphic item in the selected color.

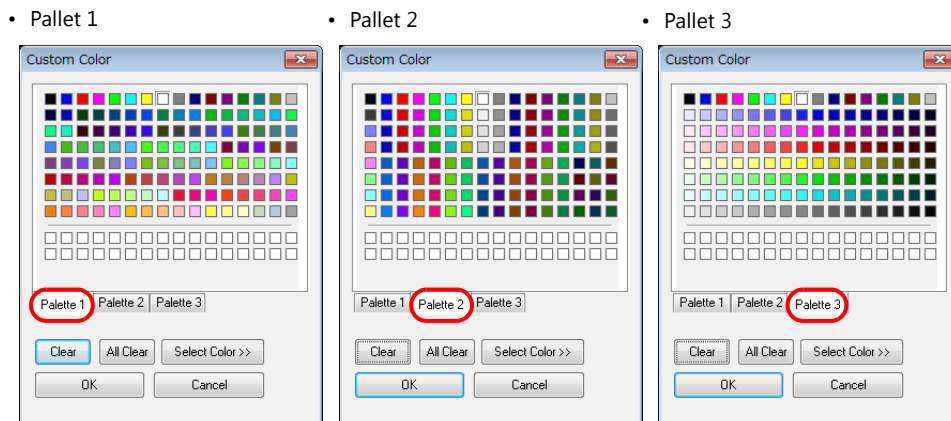

If none of these palettes include the desired color, click the [Select Color] button to enlarge the [Custom Color] window with a section of more detailed color settings.

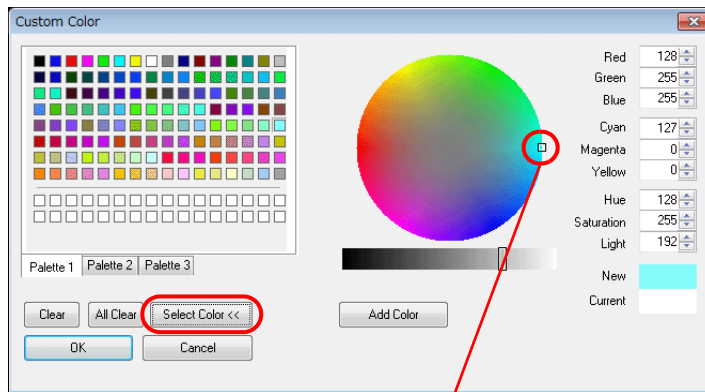

Click anywhere on the circle to display the color at the clicked point next to [New].

For further color adjustments, use the bar slider or change the values of each individual color component.

When the desired color has been created, click the [Add Color] button to register the new color and display it in the bottom two rows of the color palette, from the top left box in order.

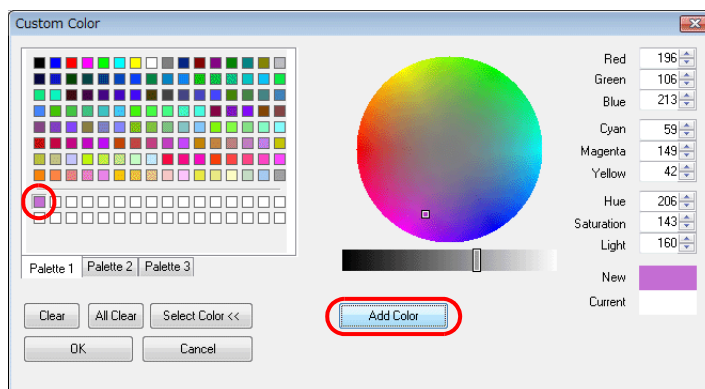

Blinking Setting



- Blinking is displayed using the screen's background color ([Screen Setting] → [Screen Setting]) and a specified color.
- Blinking can only be specified when [32K-Color w/ blinking] is selected for [Color] in the [Edit Model Selection] window.

Blinking setting procedure

1. Click the [▼] button on the right of the color change icon or the color change button.
2. Select [Blink] in the displayed color selection pull-down menu.
A check mark appears next to [Blink].

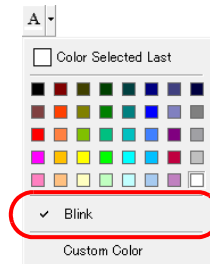

3. Click a color as desired.
The clicked color is applied as the color of the specified item(s) and/or the color change icon.
Also, "B" is displayed on the icon, indicating that the blinking setting has been made.

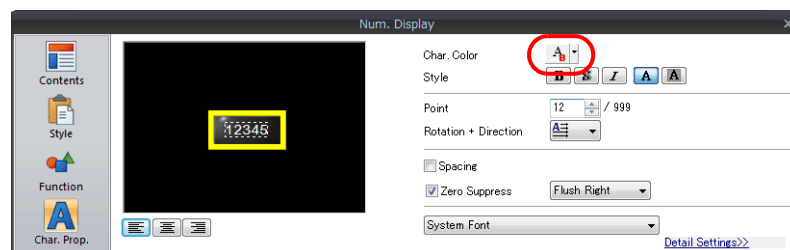

Blinking time setting

It is possible to change the blinking interval. Set as described below.

1. Select [System Setting] → [Unit Setting] → [Blink/Flash].
The [Unit Setting] window is displayed.

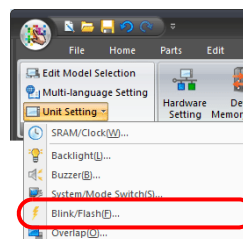

2. Set [OFF Time] and [ON Time] on the [Blink/Flash] tab.

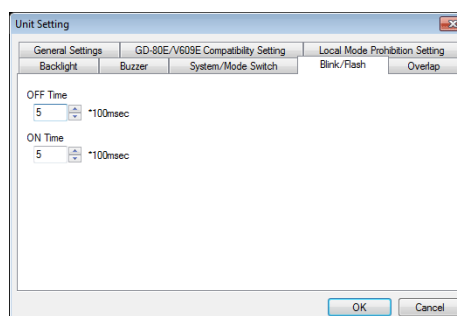

The specified blinking time is applied to the entire screen program file. The blinking time cannot be changed for individual items.

2.5 Configuring the Editing Environment

2.5.1 Changing the Background Color

1. Set the background color on the [Main] tab accessed by clicking [Screen Setting] → [Screen Setting].

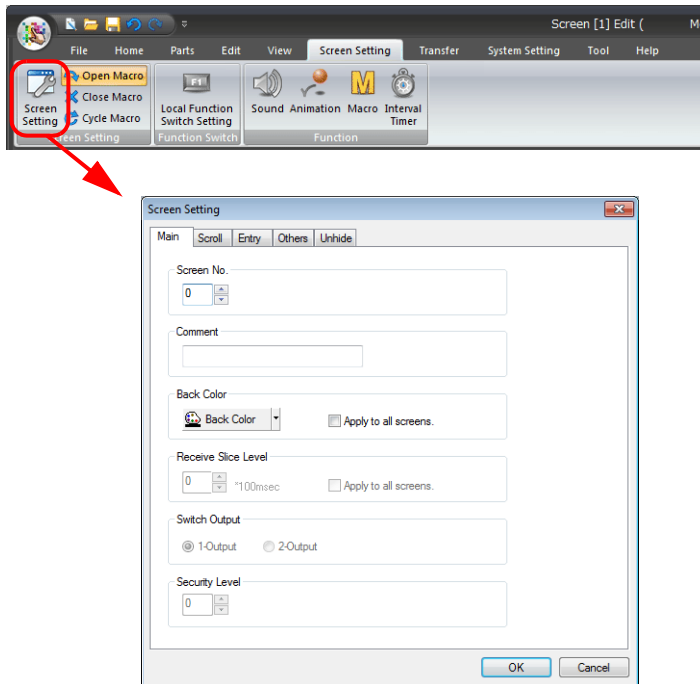

2. Click the [Back Color] button. Select the desired color in the displayed color selection pull-down menu.

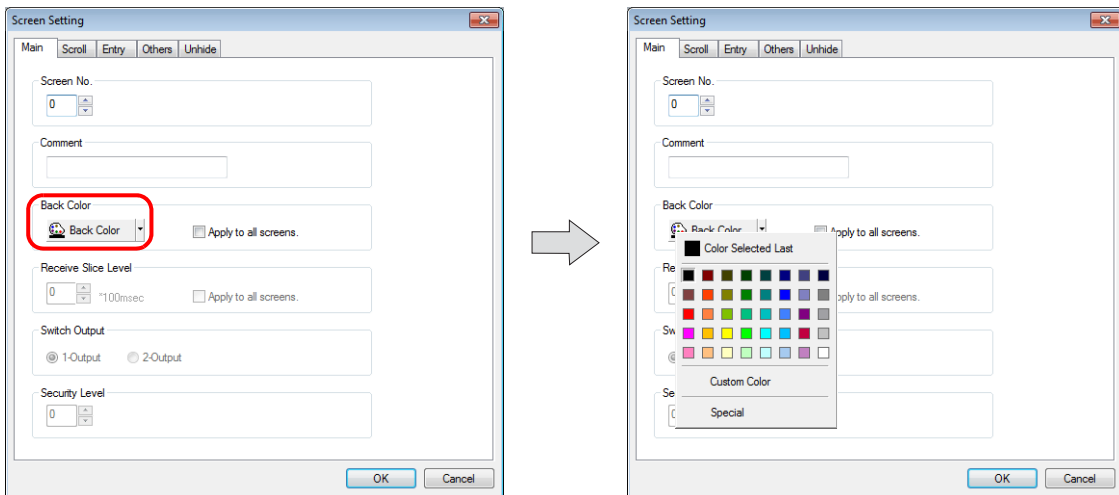

- The selected color is displayed on the [Back Color] button icon. Clicking [OK] changes the background color.

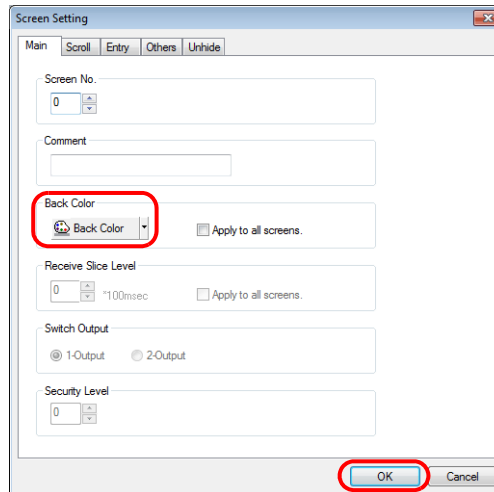

Click [Custom Color] to select a color that is not shown in the drop-down list. Other colors can be selected in the [Custom Color] window.

The diagram shows the 'Custom Color' window. A red arrow points from the 'Custom Color' button in the 'Screen Setting' dialog to the 'Custom Color' window. The 'Custom Color' window displays a color palette with three palettes (Palette 1, Palette 2, Palette 3) and buttons for 'Clear', 'All Clear', 'Select Color >>', 'OK', and 'Cancel'.

2.5.2 Grid Display

What Is the “Grid”?

The grid is used as a guide for placing graphics and parts. This is only displayed in the editor and not on the V9 series unit. The grid can be displayed by selecting the [View] → [Grid] checkbox.

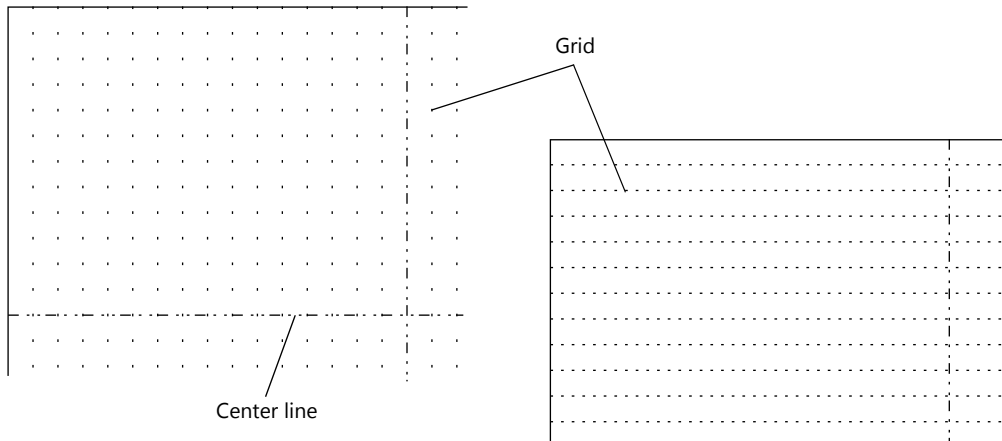

☺ In addition to the grid, center lines can also be shown or hidden. Select the [View] → [Center Line] checkbox to show the center lines and deselect the checkbox to hide the center lines.

Detailed Grid Settings

Grid settings can be set by clicking [View] → [Grid Setting] or by right-clicking on the screen → [Grid] → [Grid Setting].

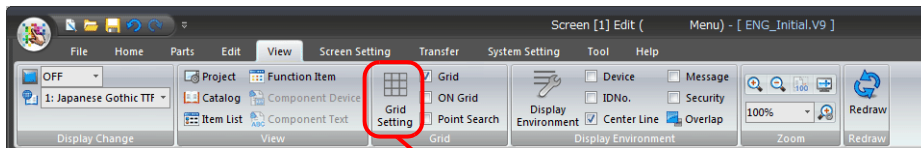

OR

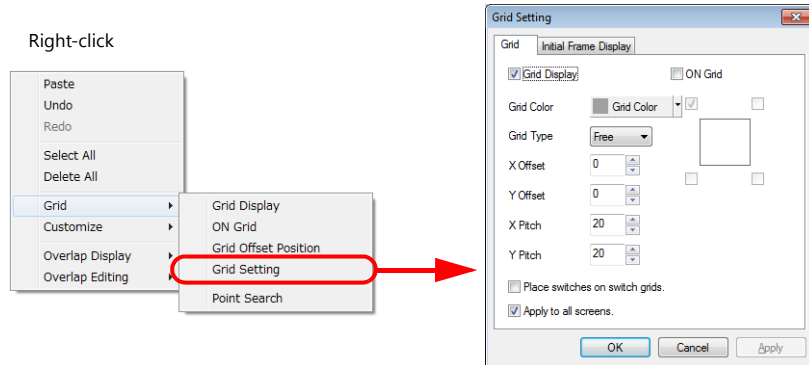

For more information on the setting items, refer to “4.2.3 Grid”.

2.5.3 Changing the Handle Color

The color of handles displayed when parts are selected can be changed.

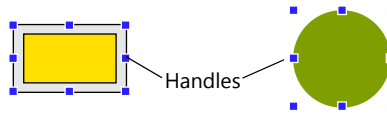

1. Click [View] → [Display Environment]. The [Display Environment] window is displayed.

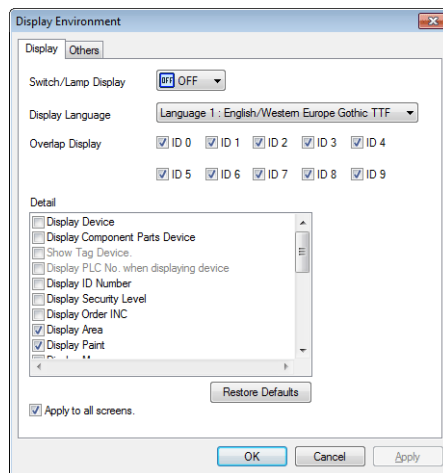
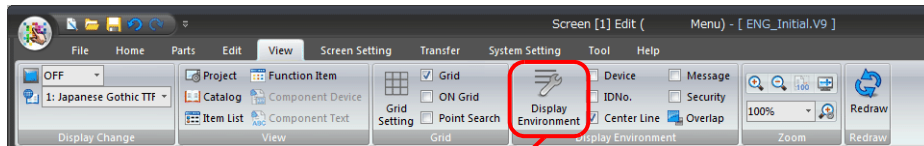

2. Change [Handle Color] on the [Others] tab and click [OK].

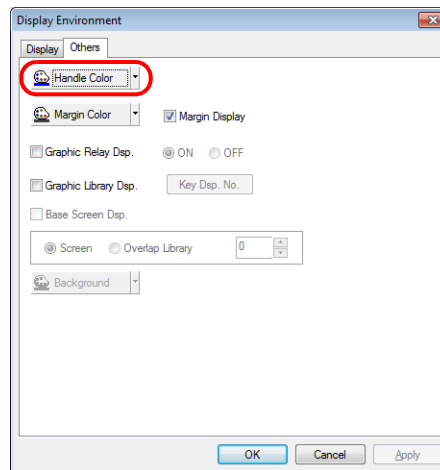

2.5.4 Changing the Margin Color

The color of the editing area periphery in the editor can be changed.

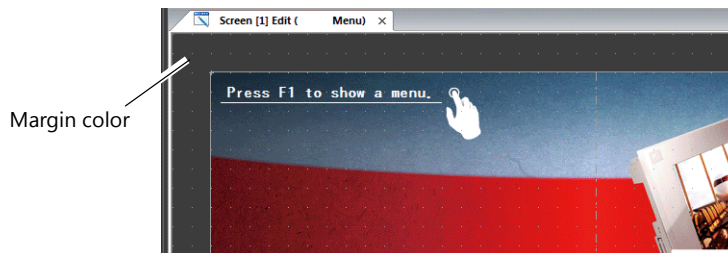

1. Click [View] → [Display Environment]. The [Display Environment] window is displayed.

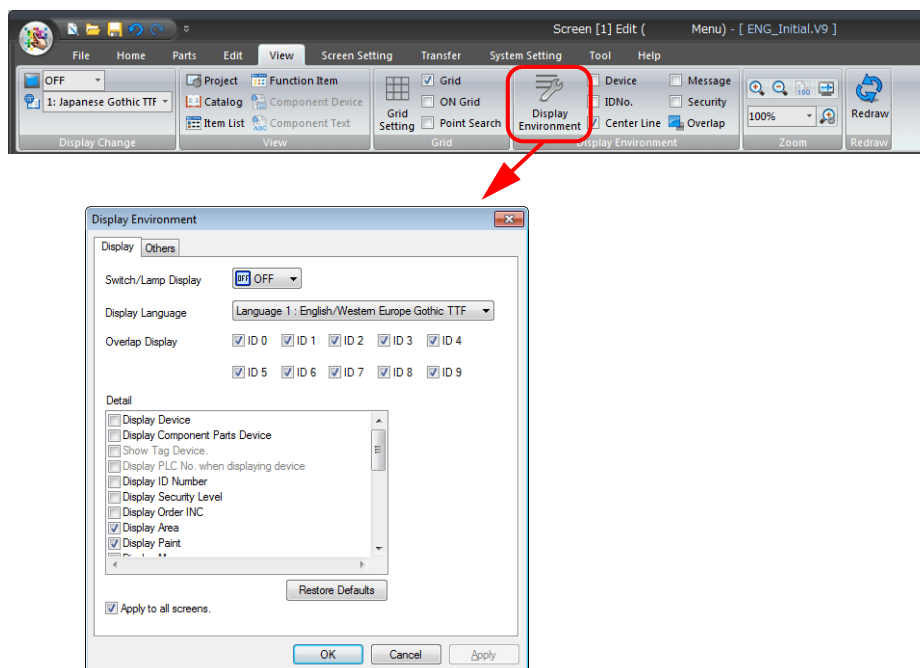

2. Change [Margin Color] on the [Others] tab and click [OK].

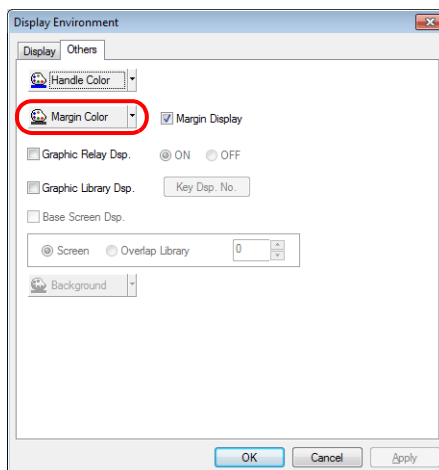

2.6 Basic Operations

2.6.1 Screen Switching Procedure

Switching Screens on the [Home] Menu

Previous screen/Next screen icons

Click on the [Previous Screen] and [Next Screen] icons to switch between displayed screens.
If the [Skip] checkbox is selected, unregistered screens are not displayed.

Previous screen Next screen

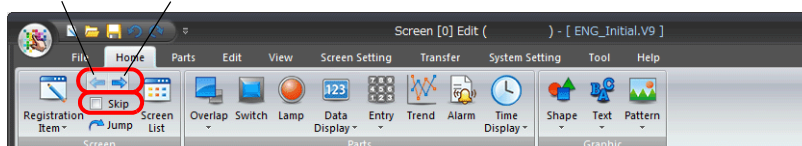

Jump

1. Click [Home] → [Jump].
A window for specifying a number is displayed.

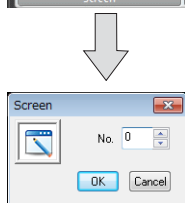
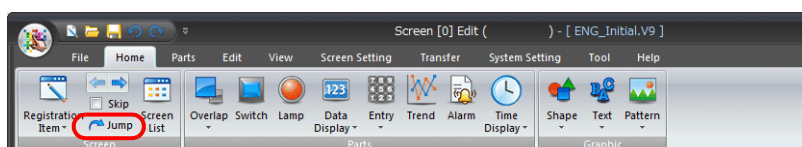

2. Specify the desired number and click [OK].
The corresponding screen appears.

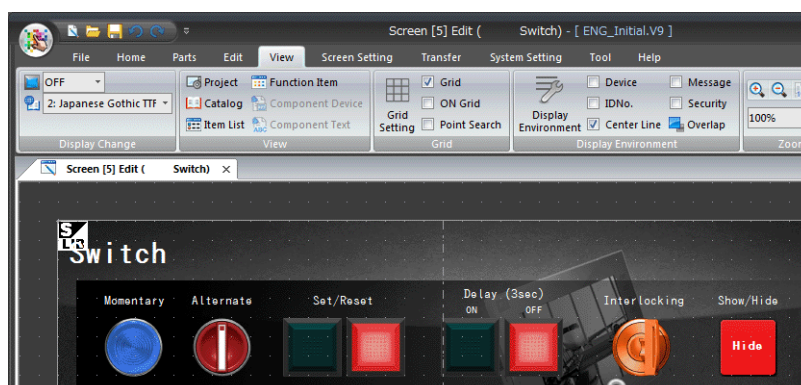
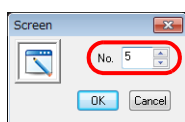

Selecting from the Screen List

1. Click [Home] → [Screen List].

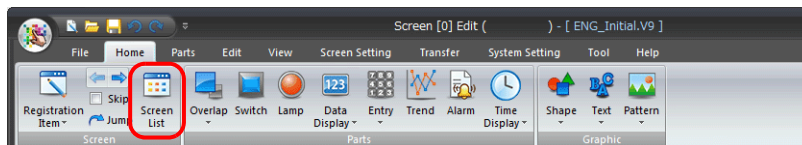

2. The [Screen List] tab window is displayed.

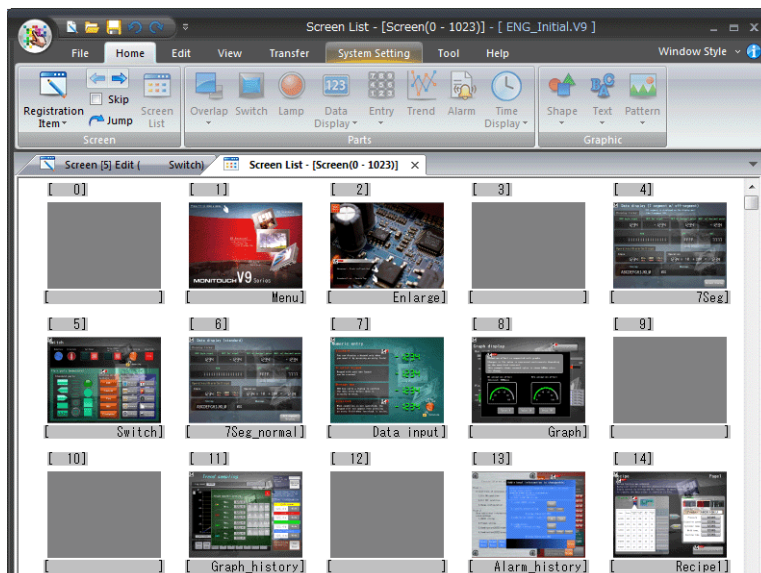

3. Double-click the number of the desired screen. The corresponding screen appears.

Display screen by double-clicking.

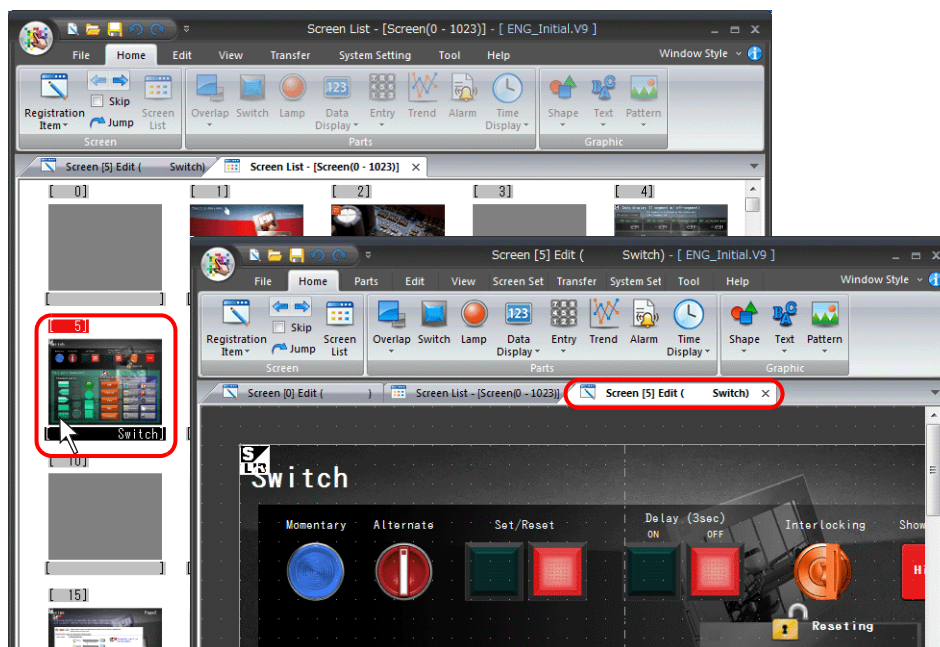

* The screen called by double-clicking is displayed in addition to the [Screen List] window and any screens which are already displayed.

Selecting from the Project List View Window

1. Click [View] → [Project].

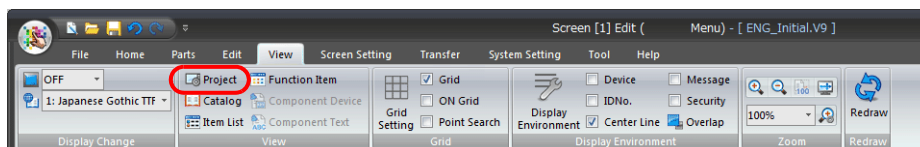

2. The project list view window is displayed.

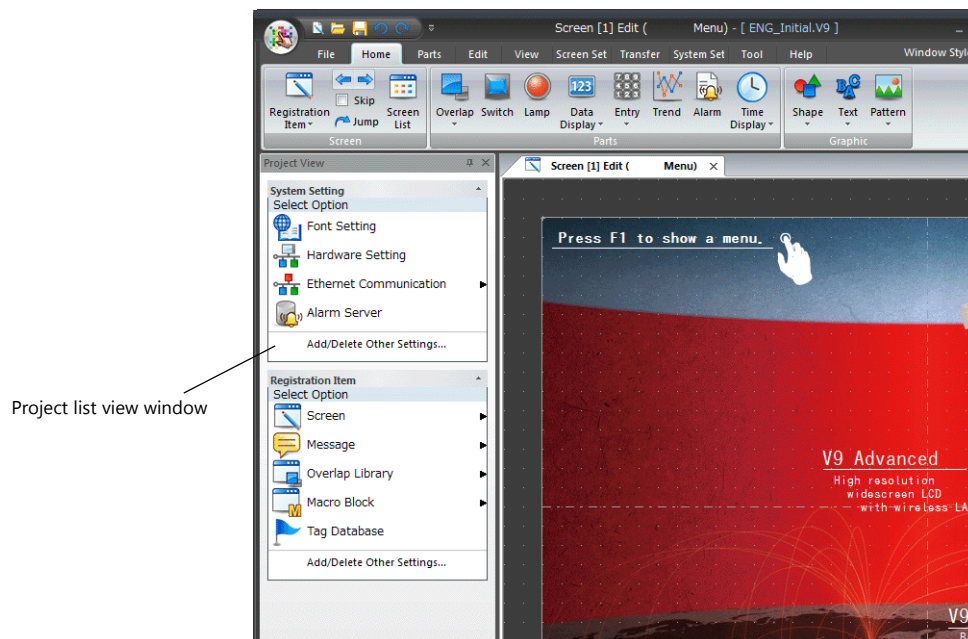

3. Double-click [Screen] under [Registration Item] to display the registered screens in the project list view window.

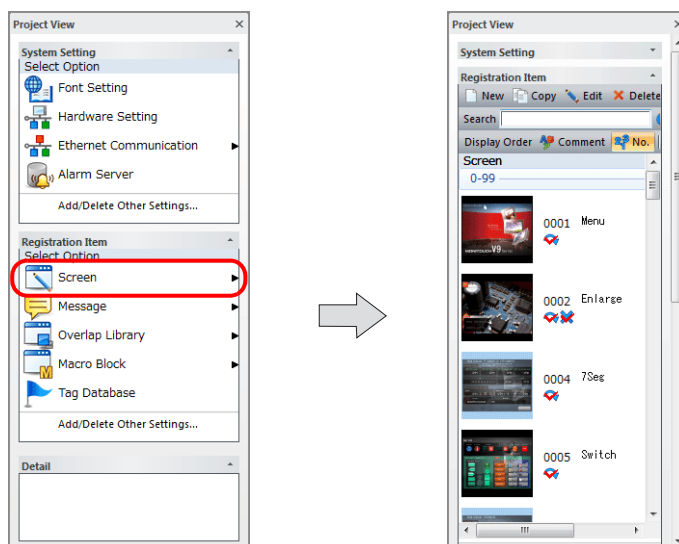

4. Double-click on the screen or select the screen and click [Edit] to display the corresponding screen.

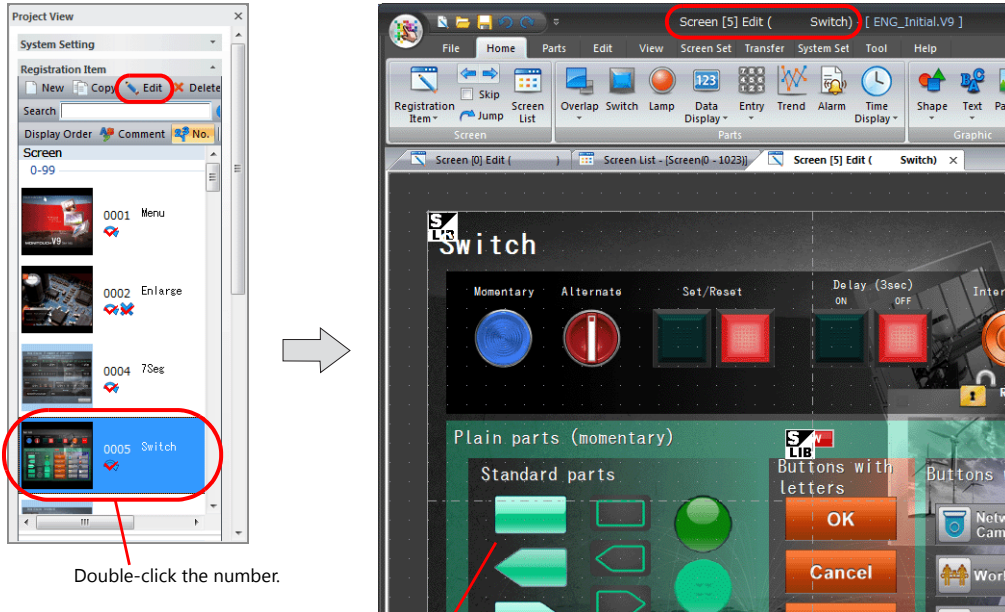

Double-click the number.

The corresponding screen (e.g. screen No. 4) is displayed.

*** The called screen is displayed in addition to any already displayed screens.**



2.6.2 Copying Screens

Copy Using the Screen List

1. Click [Home] → [Screen List] to display the [Screen List] window.

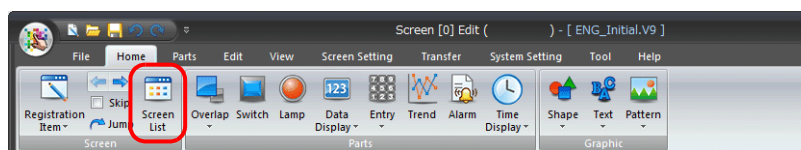

2. Click to select the copy source screen. (The number is highlighted in red.)

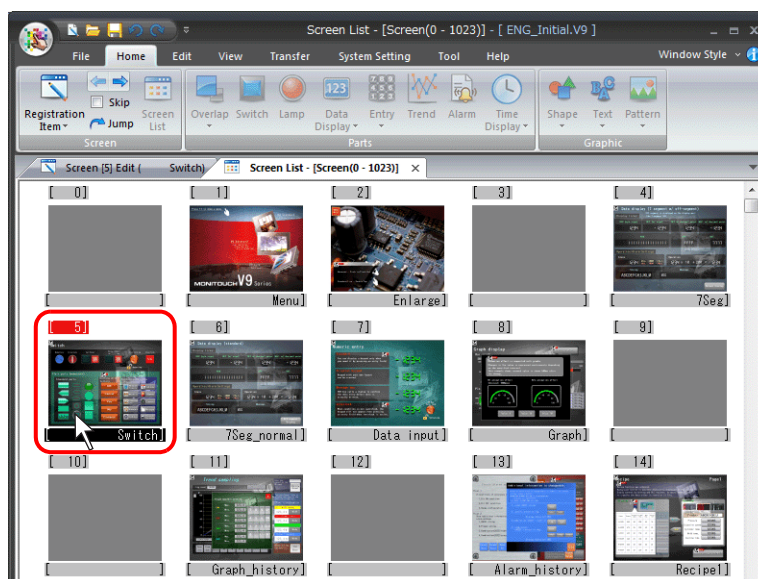

3. Drag the copy source screen to the copy destination number.
The copied screen is pasted to the copy destination.

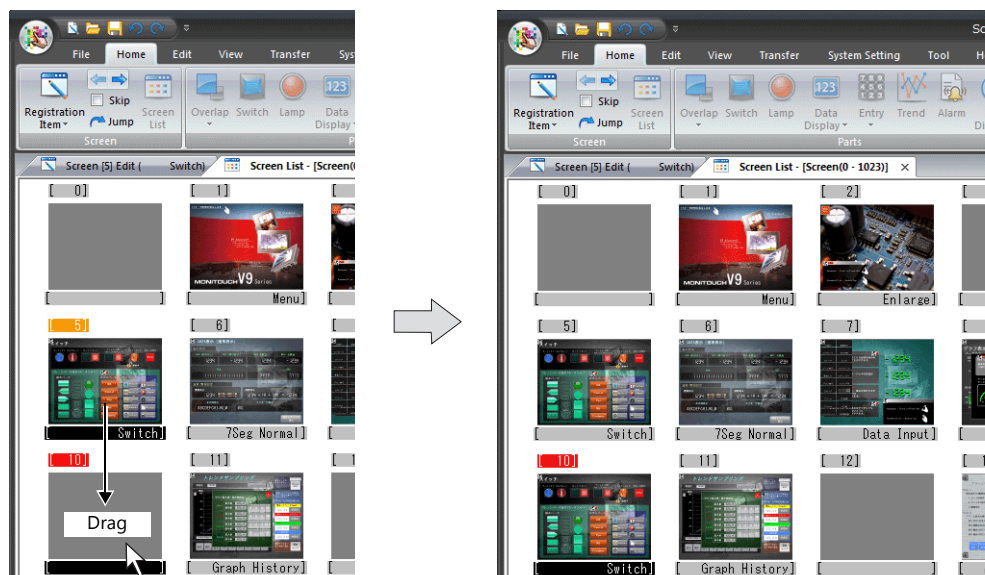



- In addition to dragging, screens can also be copied by right-clicking on a screen, selecting [Copy] with the copy source selected, clicking the copy destination, and then selecting [Paste] from the right-click menu.

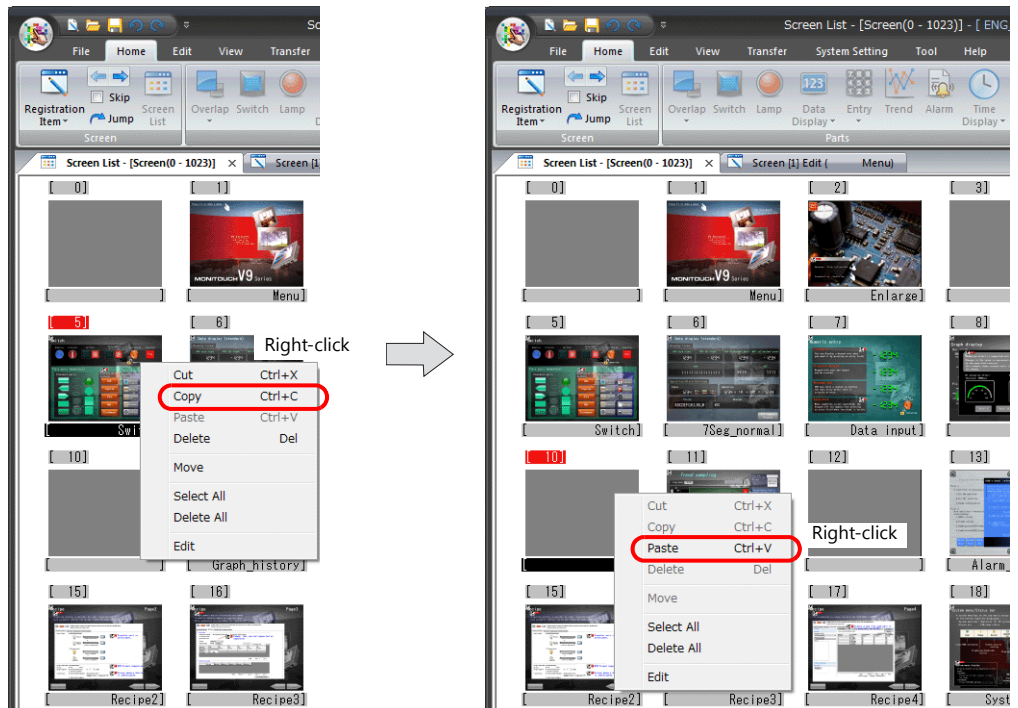

- When a screen already exists at the copy destination, an overwrite confirmation message appears. Click [OK] to overwrite the existing screen.

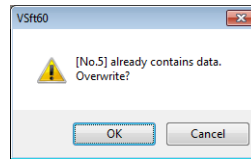

Copy Using the Project List View Window

1. Click [View] → [Project] to display the [Project View] window.

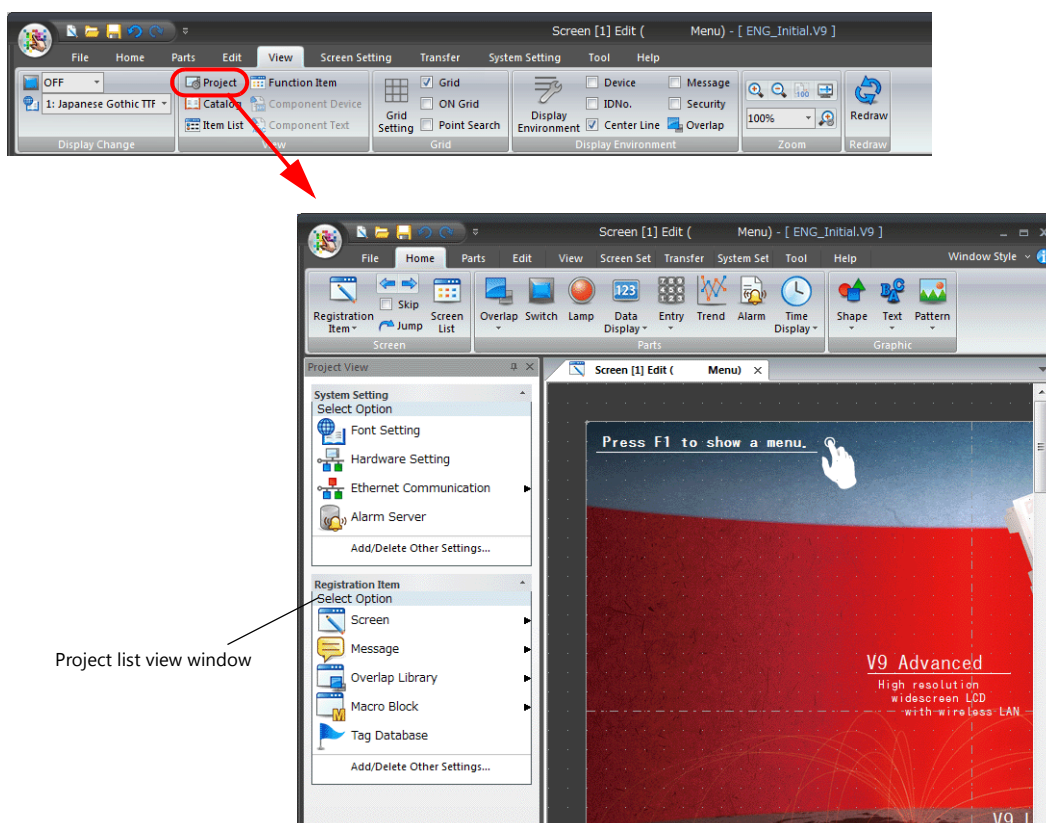

2. Double-click [Screen] under [Registration Item] to display the registered screens in the project list view window.

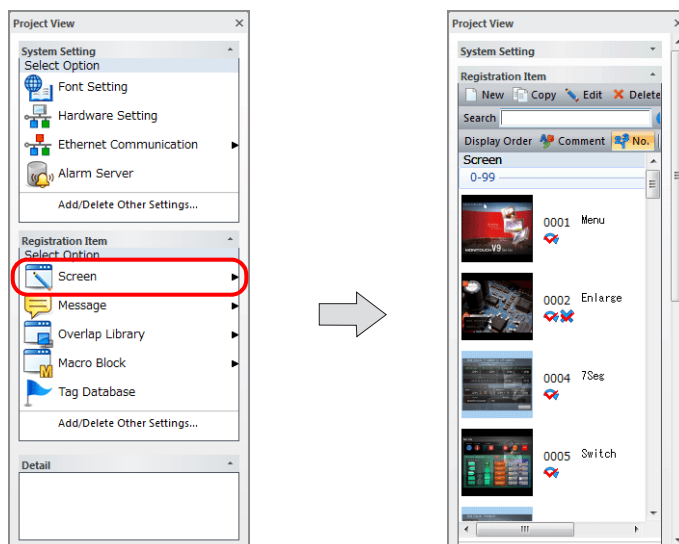

3. Select the screen to copy and click [Copy] to display the window for specifying the copy destination number.

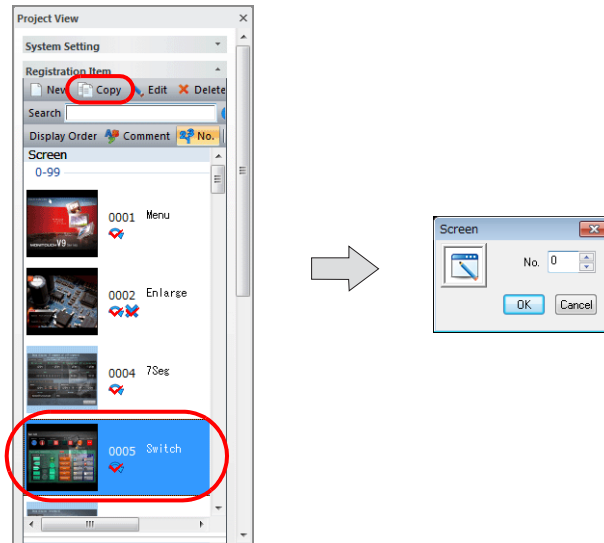

4. Specify the copy destination and click [OK] to paste the screen.

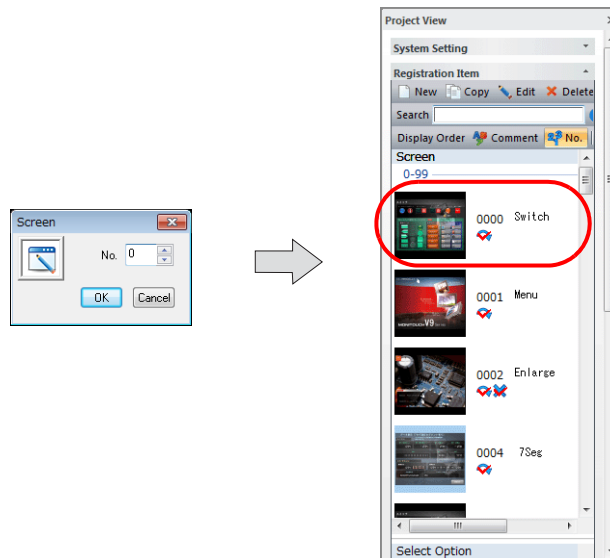

2.6.3 Moving Screens

There may be cases where you need to exchange or change the screen numbers of registered screens. Screen numbers can be easily changed by using unregistered screen numbers.

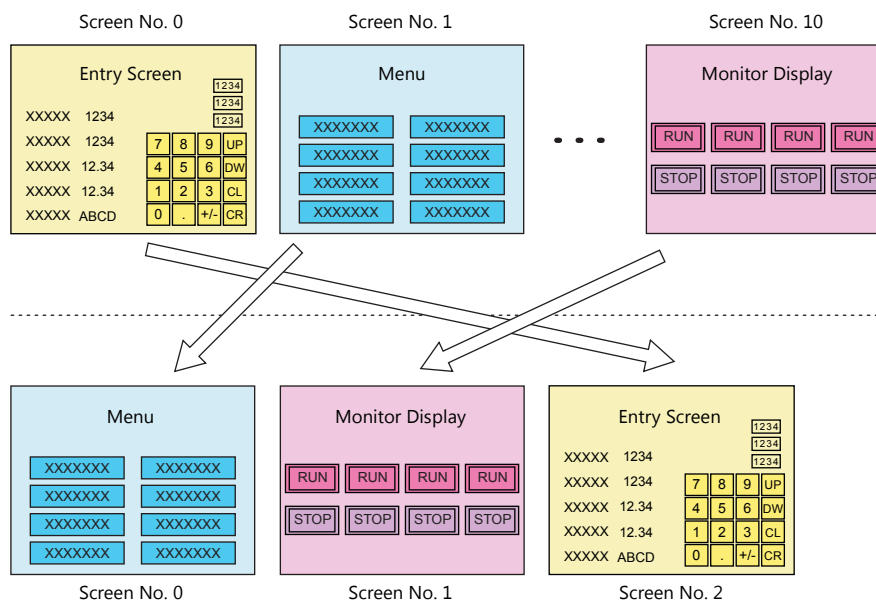

Move Using the Screen List

This section explains the procedure for moving screen number 2 to screen number 3.

1. Click [Home] → [Screen List] to display the [Screen List] window.

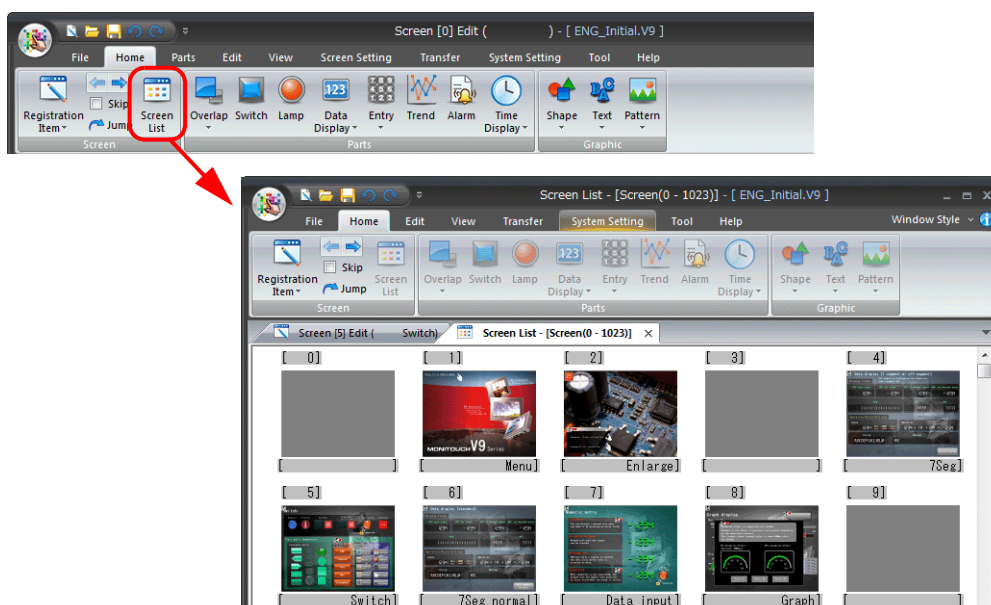

- Click screen number 2. (The number is highlighted in red.)
Right-click on the screen and select [Move].

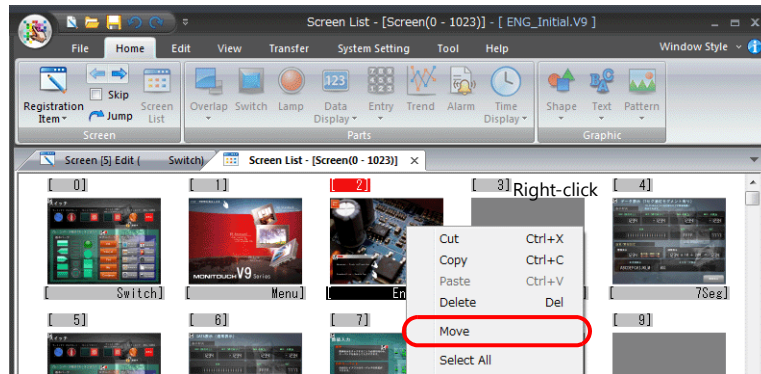

- A window for specifying the destination screen number for the selected screen is displayed. Enter the destination screen number and click [OK].

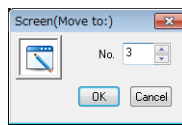

- Screen number 2 is moved to screen number 3.

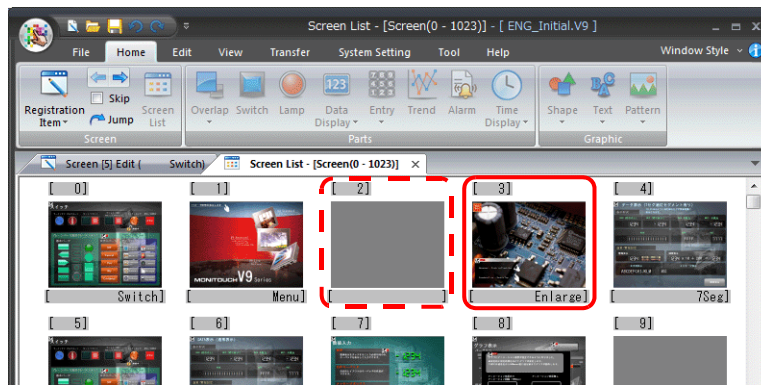

• Automatic Conversion of Functions

By using the following setting, switches for which [Function] is set to [Screen Change-over] in the screen program and [Switch to] is set to screen number 2 are all automatically changed to screen number 3.

Location of setting:

Select the [Remap Menu Switches (Screen/Screen Library/Overlap)] checkbox at [File] → [Property] → [Edit].

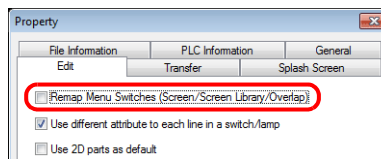

Details of change:

[Screen Change-over] switch



• Before move

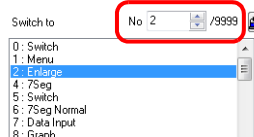

• After move

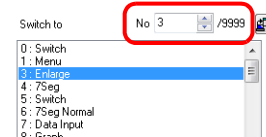

Move Using Screen Settings

This section explains the procedure for changing screen number 0 to the unused screen number 6.

1. Click [Screen Setting] → [Screen Setting] to display the [Screen Setting] window.

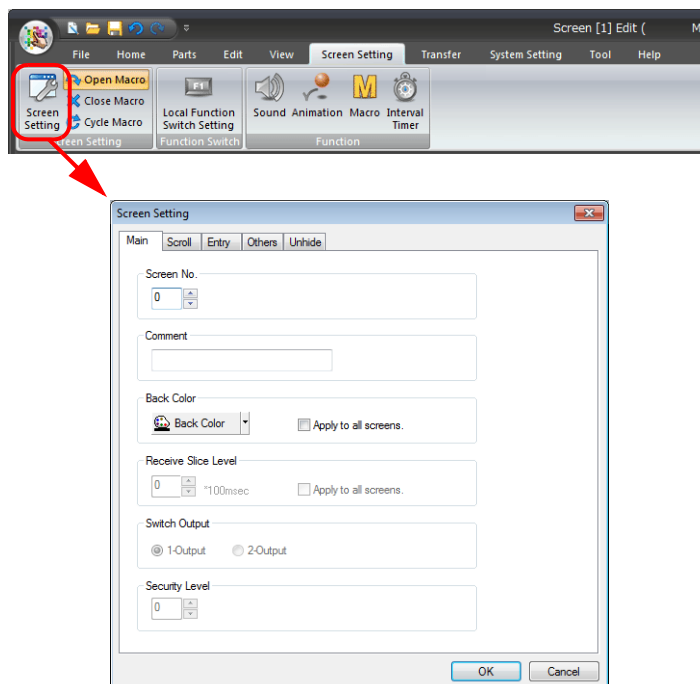

2. On the [Main] tab, change [Screen No.] to an unused number and click [OK].

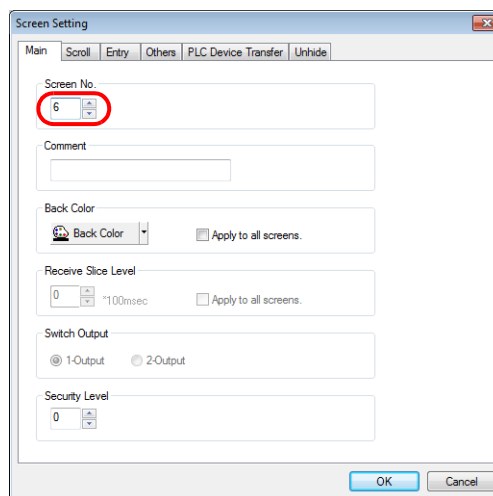

Numbers already in use cannot be specified. The following warning message is displayed if an existing number is specified.

E.g.: Specifying screen number 1 when screen number 1 already exists

- The number of the screen currently being edited is changed to the number specified in step 2.

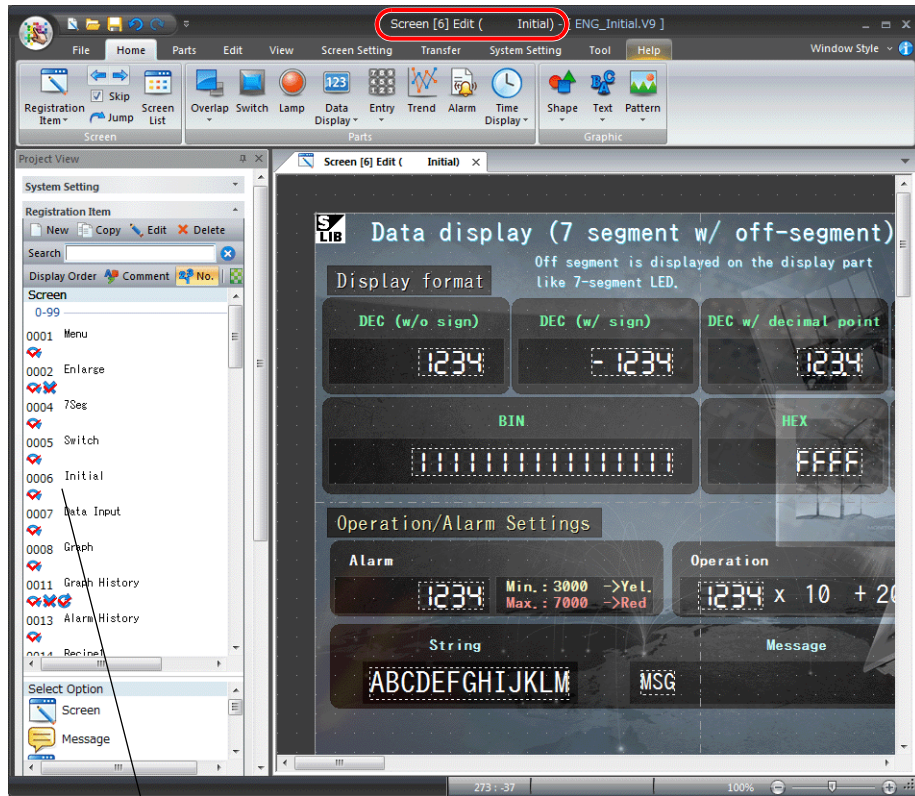

Screen number 0 changes to screen number 6.
(Screen number 0 disappears.)



- Automatic Conversion of Functions

Switches for which [Function] is set to [Screen Change-over] in the screen program and [Switch to] is set to screen number 0 can all be automatically changed to screen number 6.

For more information, refer to page 2-58.

2.6.4 Deleting Screens

Deleting Using the [Edit] Menu

1. Display the screen to be deleted.

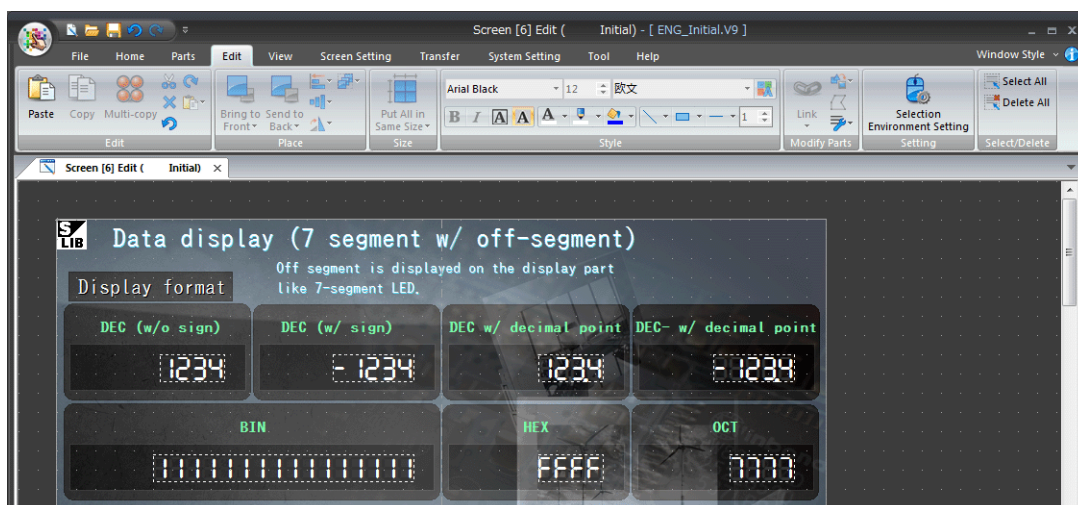

2. Click [Edit] → [Delete All].

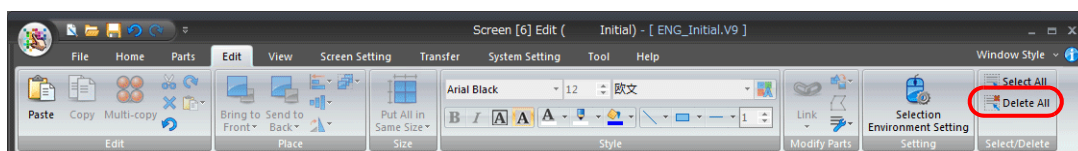

3. A confirmation message is displayed. Click [Yes].

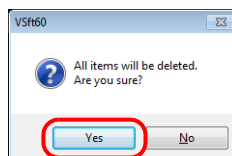

4. The screen that was displayed is deleted.

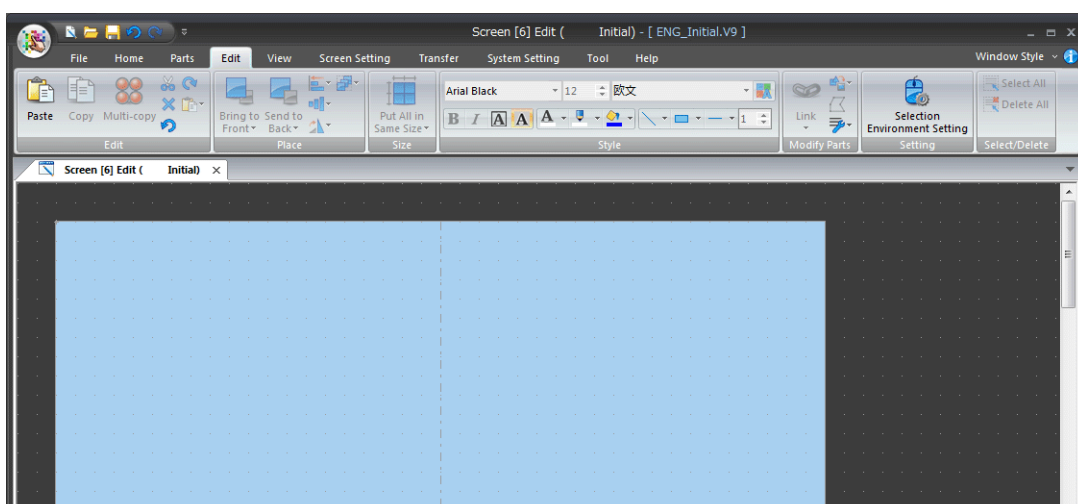

Delete Using the Screen List

1. Click [Home] → [Screen List] to display the [Screen List] window.

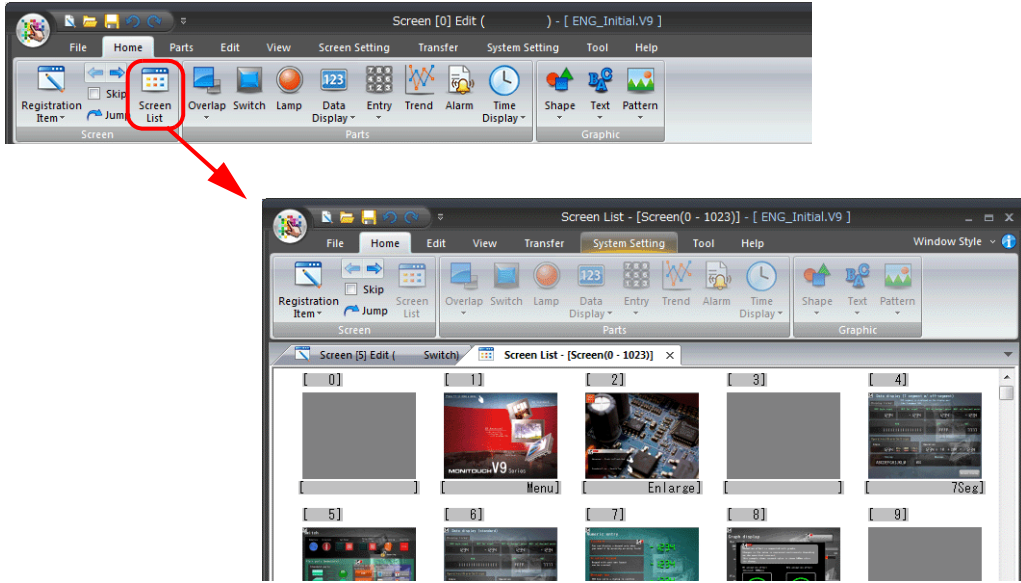

2. Click the screen to be deleted. (The number is highlighted in red.)
Right-click on the screen and select [Delete].

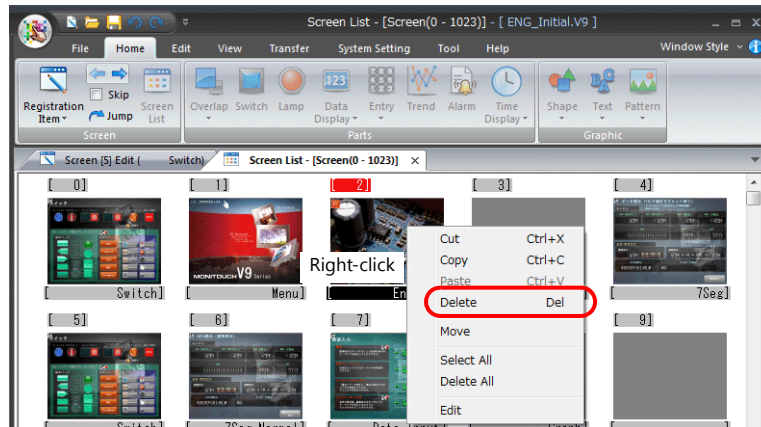

3. A confirmation message is displayed. Click [OK].



4. The selected screen is deleted.

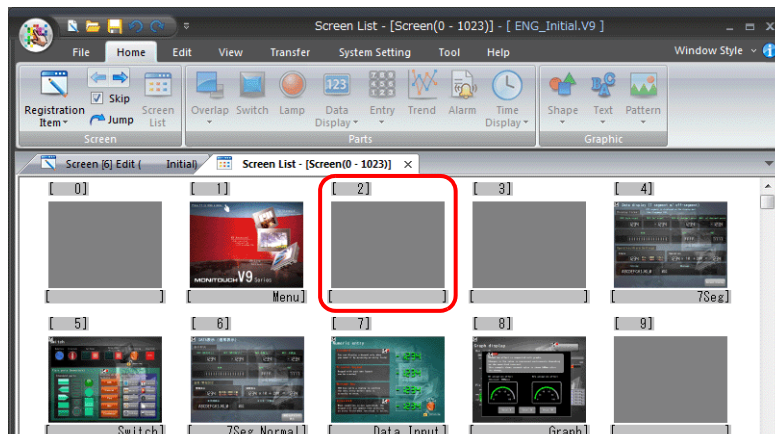

Delete Using the Project List View Window

1. Click [View] → [Project] to display the [Project View] window.

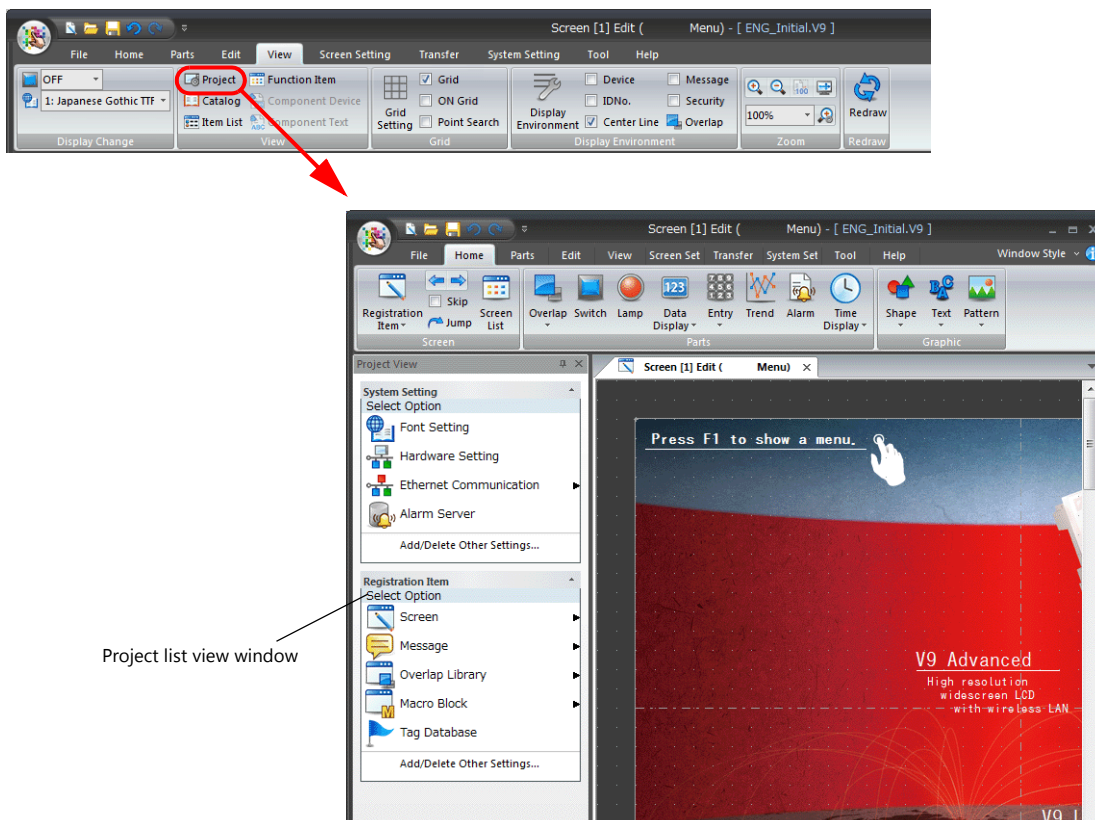

2. Double-click [Screen] under [Registration Item] to display the registered screens in the project list view window.

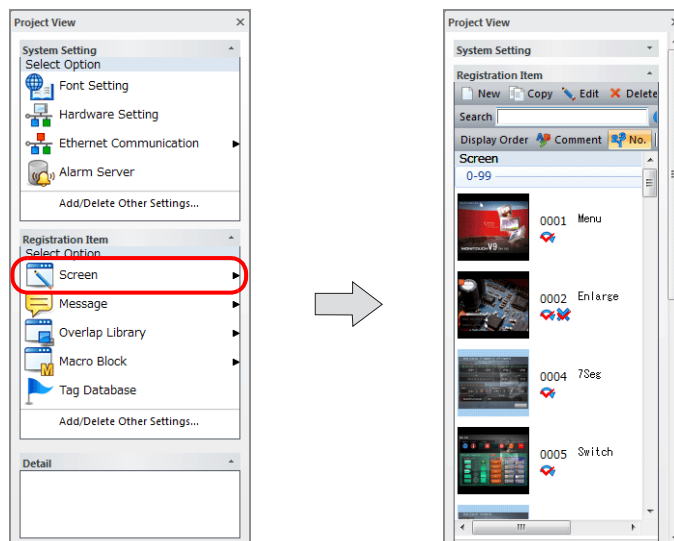

3. Select the screen to delete and click [Delete]. A confirmation message is displayed.

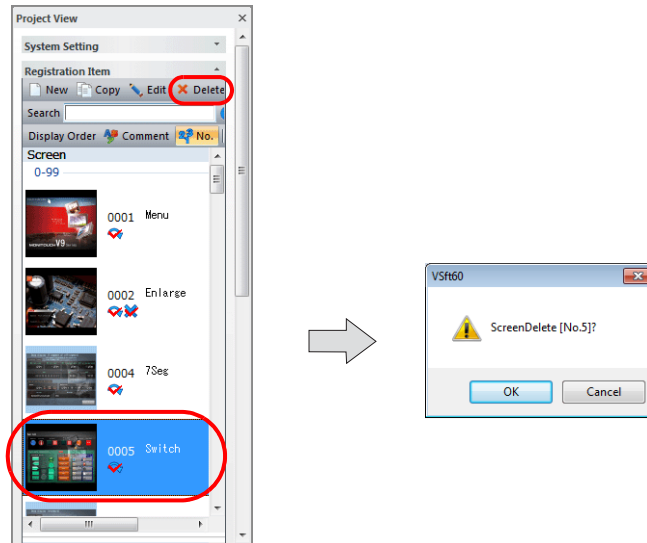

4. Click [OK] to delete the selected screen.

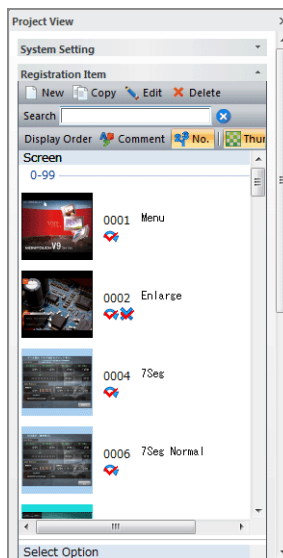

2.7 Saving Files

2.7.1 Saving by Overwriting

Click [File] → [Save] to overwrite the current file.

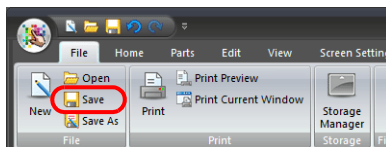

For a new screen program, the following dialog box is displayed. Click [Yes] to display the [Save screen program as.] window.

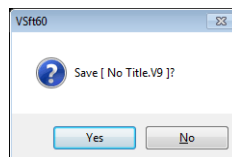

* Refer to the next section for details on the [Save screen program as.] window.

2.7.2 Saving by Specifying a Name

Click [File] → [Save As] to display the [Save screen program as.] window.

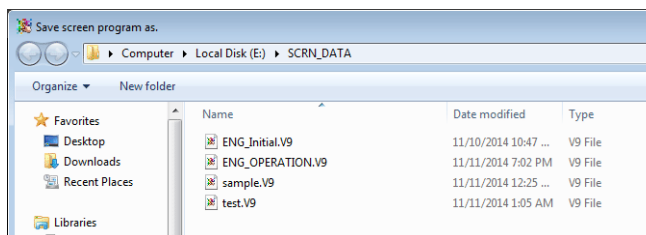
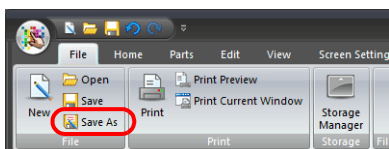

Enter a name into the [File name] field and click [Save] to create new files of this name.

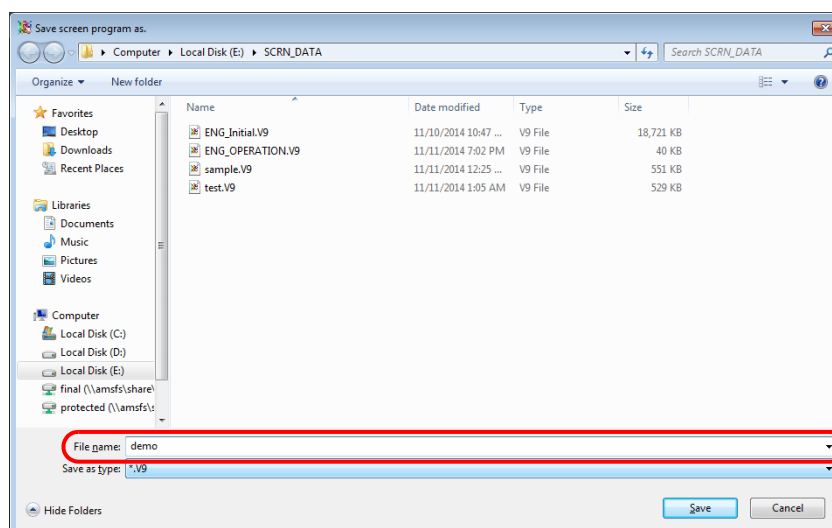

When a screen program is saved, files with the following extensions are created.

Extension	Description
*.V9	This is the V9 series screen program file.
*.env	This file stores the editing environment settings of V-SFT version 6 in use when the file is saved. (E.g.: grid settings)
*.bak	This is a backup file that stores the data of the previous time that the screen program was saved by overwriting.
*.txw	This file stores text registered using Windows fonts when using Windows fonts for character display parts.

2.8 File Comparison

Compare the programs of two screen program files and report the results.
 If necessary, program items that exist in the source file but do not exist in the target file can be copied in this window.

Operating Procedure

1. Select [Comparing].

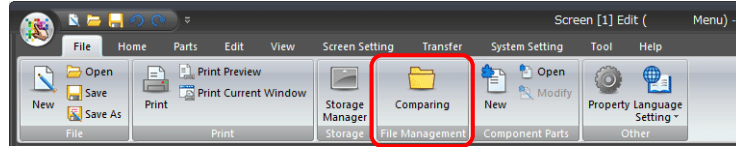

2. The [File Comparing] window is displayed.

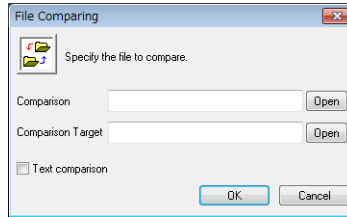

Specify the files to be compared using the [Open] buttons.

3. Select the [Text comparison] checkbox.

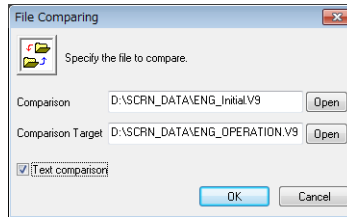

4. Click [OK] to start the file comparison. When any differences are found, the following tab window appears. Mismatches are indicated with a red check mark and red text. For more information on the results displayed in this window, refer to the next page.

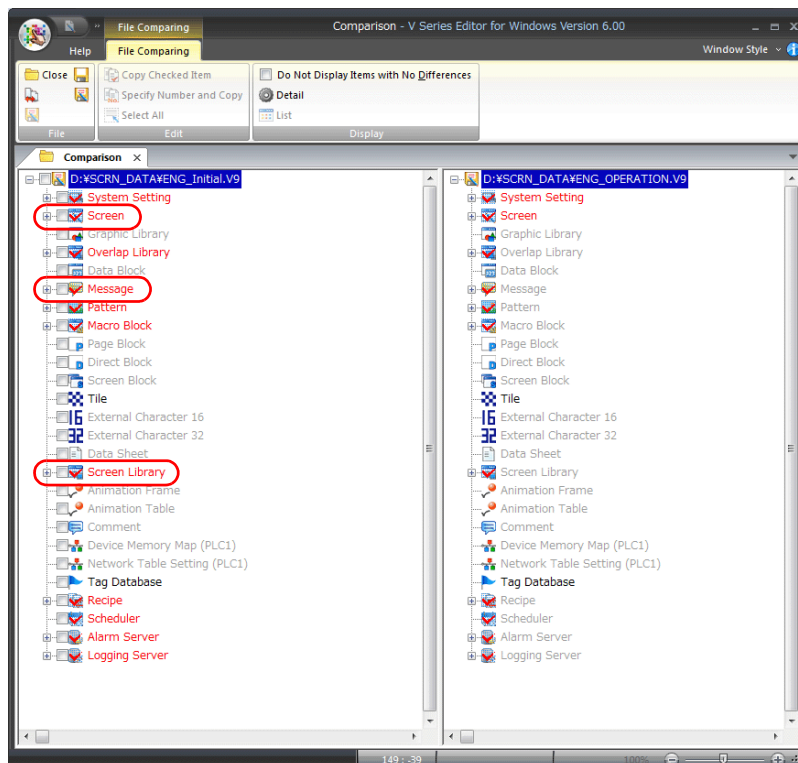



[Comparison] Tab Window

The [Comparison] tab window shows the program source for comparison (copy source) on the left and the program target (copy destination) on the right.

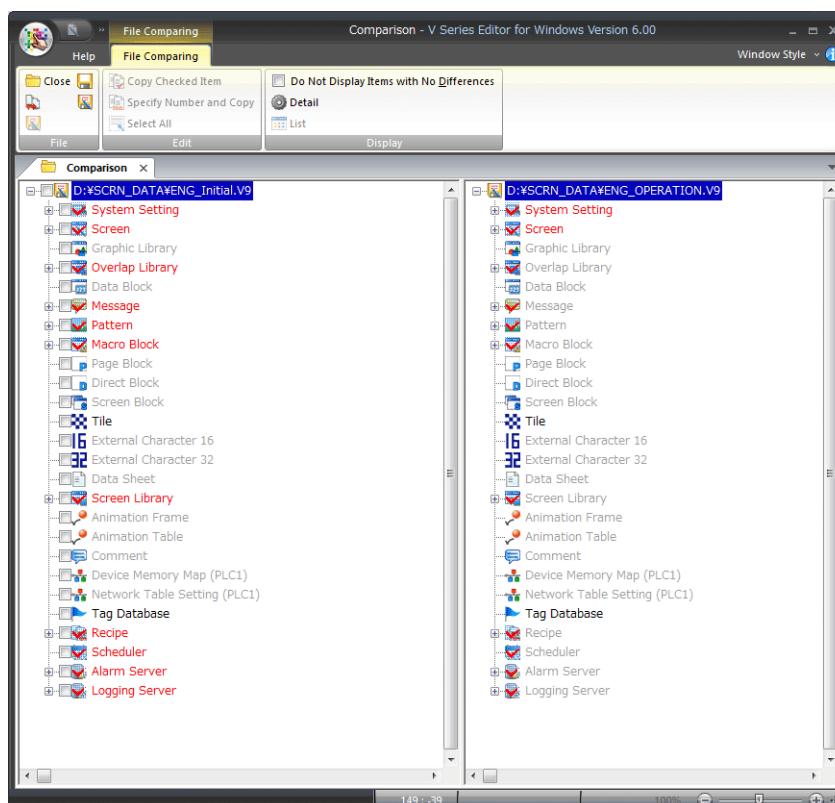

The text color and icon display varies according to the result of comparison.

Description	Color	Icon Display
The compared item exists in both files and the program content both match.	Black	Normal
The compared item exists in both files but the program content do not match.	Red	Checked
The compared item only exists in one of the files.	Not present: gray Present: red	Checked

File comparing menu

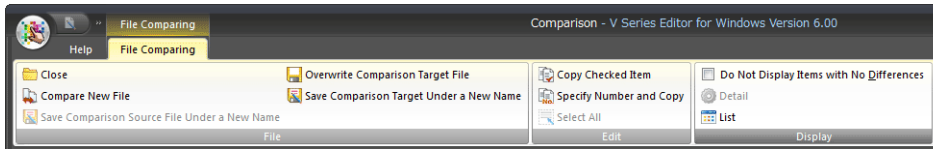

Item	Description	
File	Close	Close the comparison results.
	Compare New File	Select new files and perform a comparison.
	Save Comparison Source File Under a New Name	Save the comparison source file to a new file with a different filename.
	Overwrite Comparison Target File	Save the comparison target file to an existing file.
	Save Comparison Target Under a New Name	Save the comparison target file to a new file with a different filename.
Edit	Copy Checked Item	Copy the comparison source items with a selected checkbox to the comparison target.
	Specify Number and Copy	Specify the range of comparison source items and copy them to the comparison target.
	Select All	Select all items.
Display	Do Not Display Items with No Differences	Only display items whose program content does not match.
	Detail	Display comparison results as text in an easily understandable format.
	List	Display screen lists for both the comparison source and comparison target.

Procedure for Checking Content Details

Checking details in text format

1. Select the mismatched item and click [Detail] on the ribbon menu or right-click the mismatched item and select [Detail].

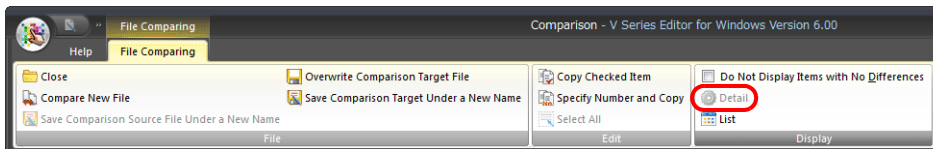

OR

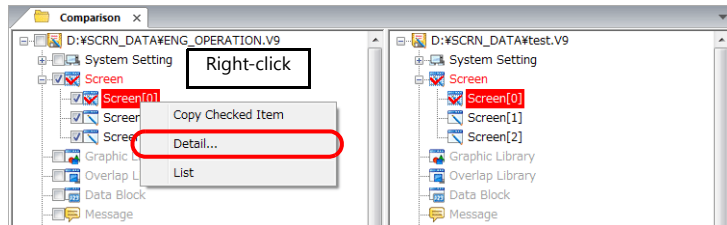

2. The following window is displayed in the editor. Mismatches are indicated with red text.

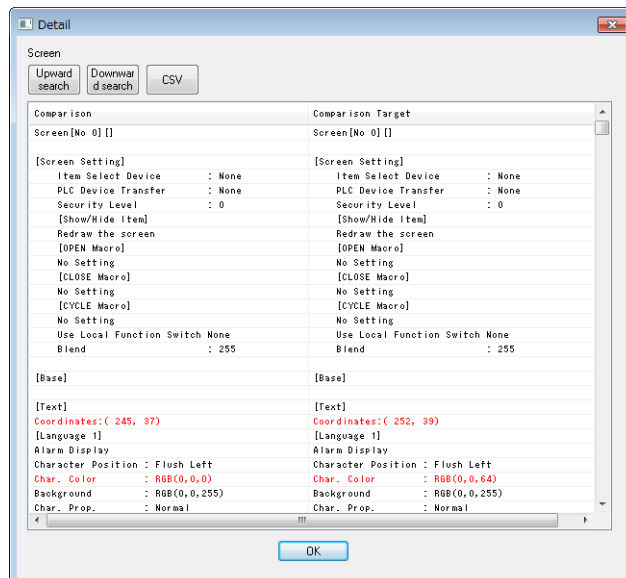

- Click [Upward search]/[Downward search] to search either up or down through mismatches. Click [CSV] to output the detailed content currently displayed to a CSV file.

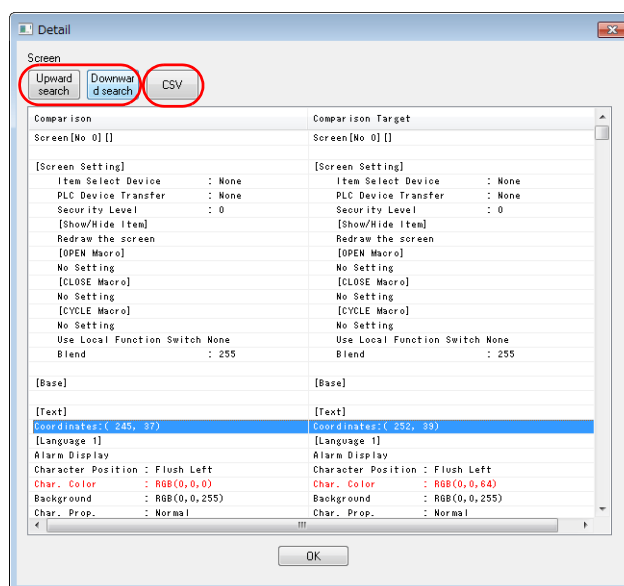

Checking using screen lists

If mismatches are found in the comparison results, screen lists can be displayed for checking.

- Right-click on a mismatched item and select [List] or click [List] on the ribbon menu.

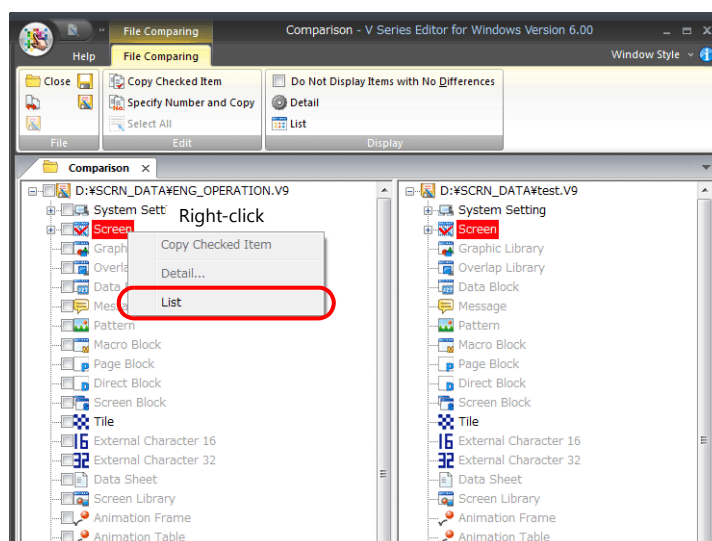

- A screen list is displayed for both the comparison source and comparison target in the editor.

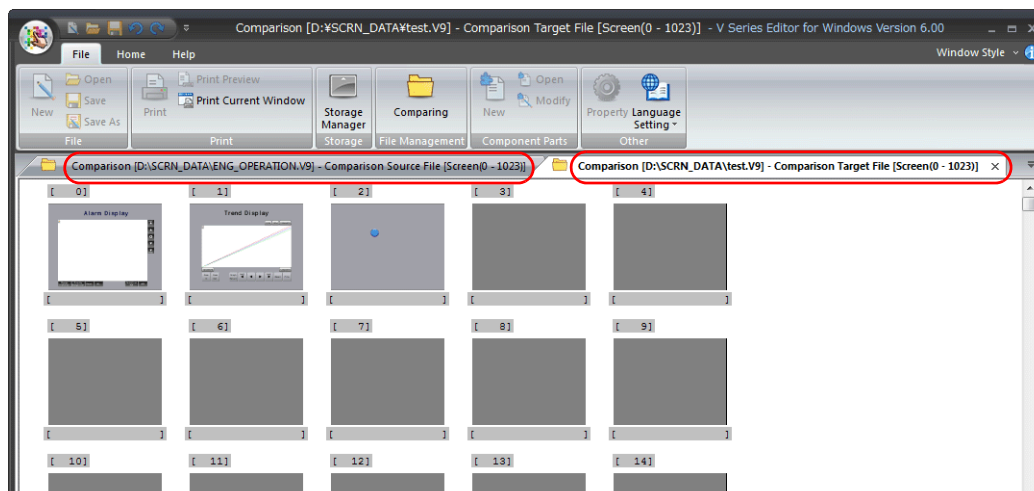

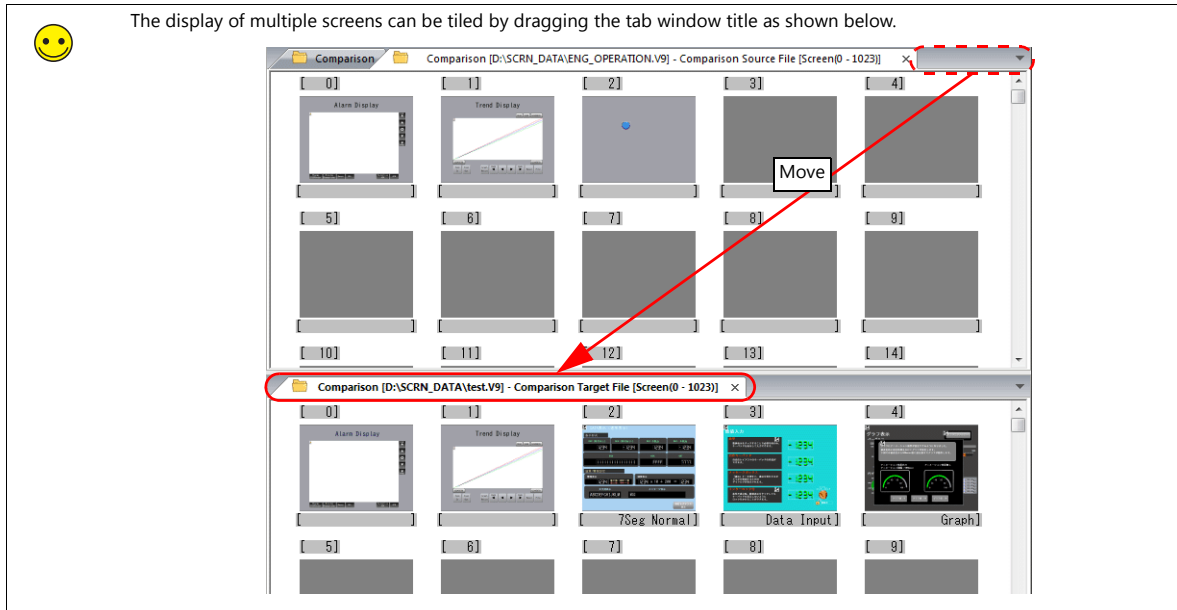

Procedure for Copying after Comparison

After performing a comparison, items in the program source for comparison (copy source) can be copied to the program target (copy destination). There are three methods for copying items.

Using icon checkboxes

The same number is assigned to the copy source and the copy destination. (Applicable to: All items)

1. Select the checkbox of the item to copy (in the comparison source).

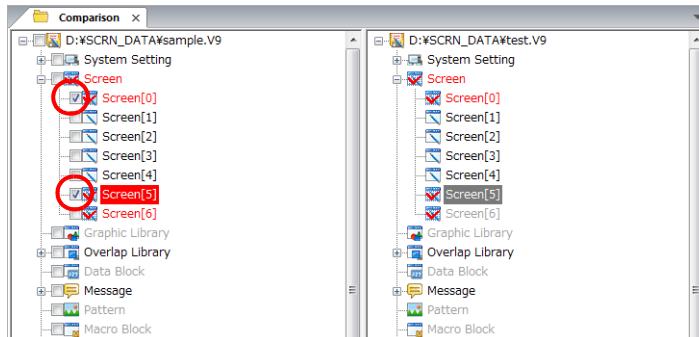

2. Right-click on the item with the selected checkbox and [Copy Checked Item] or click [Edit] → [Copy Checked Item].

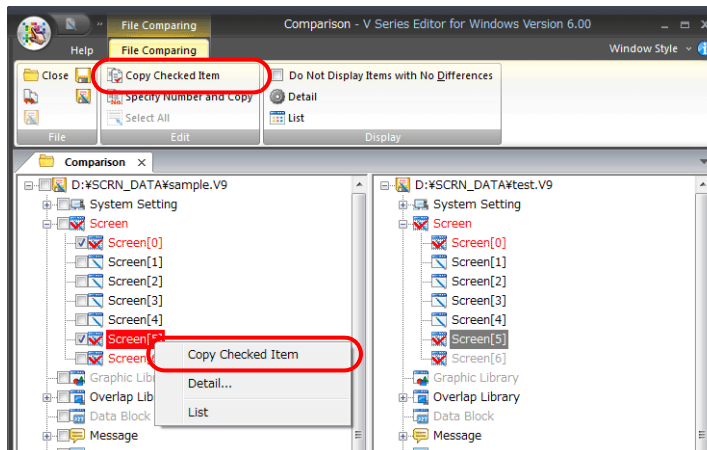

- The item with the selected checkbox is copied to the copy destination.

If the item already exists in the copy destination file, the following [Overwrite Confirmation] dialog box appears. Click [Yes] to overwrite the program item.

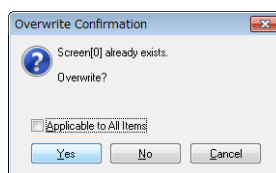

Copying by specifying a number

Multiple items can be copied at once by specifying the copy source range with numbers. (Applicable to: All items except for items included in [System Setting])

- Click to select the item in the copy source to copy.

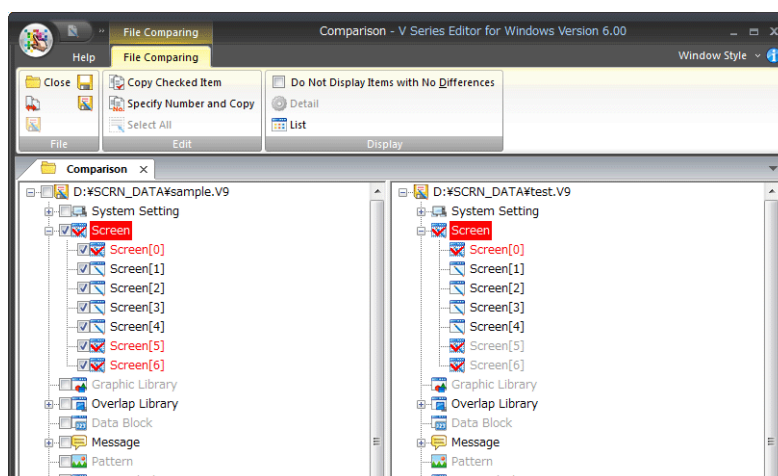

- Select [Edit] → [Specify Number and Copy].

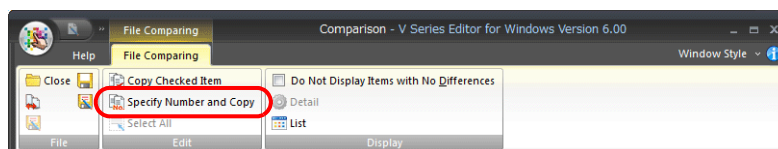

- The [Number Designation] window is displayed. Specify the desired numbers for [Copy Source No.] and [Copy Target No.] and then click [OK]. Copying is executed.

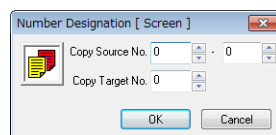

Dragging and dropping between screen lists

(Applicable to: screens, graphic libraries, overlap libraries, data blocks, data sheets, screen libraries, animation frames)

1. Right-click on the item in the copy source to copy and click [List] or click [List] on the ribbon menu.

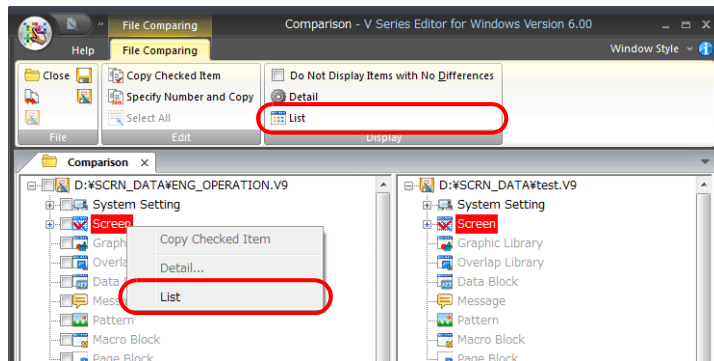

2. A screen list is displayed for both the comparison source and comparison target in the editor. The comparison source is the copy source and the comparison target is the copy destination.

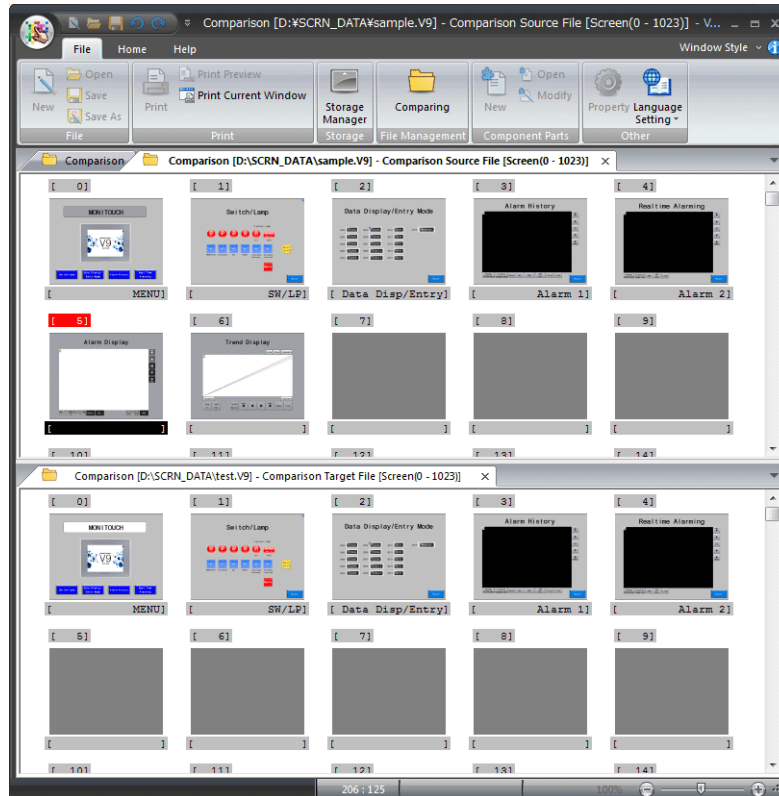

If necessary, scroll the tab windows so that the desired copy source number and copy destination number are in view.

- Click the screen to be copied in the copy source tab window.
The screen number is highlighted in red.

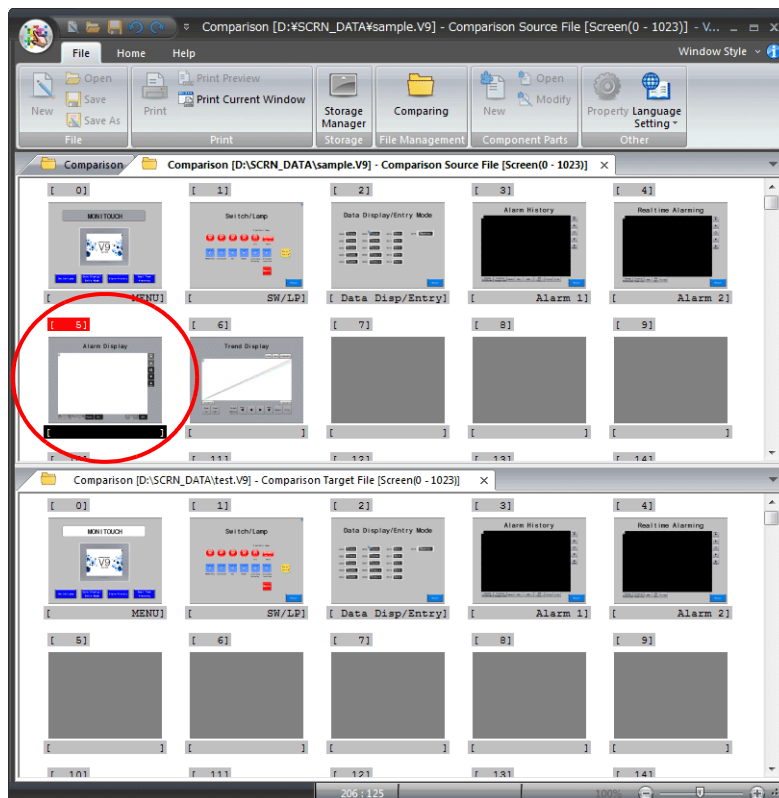

- Drag the screen selected in step 3 onto the desired copy destination screen.
Release the mouse button to copy the screen to the copy destination.

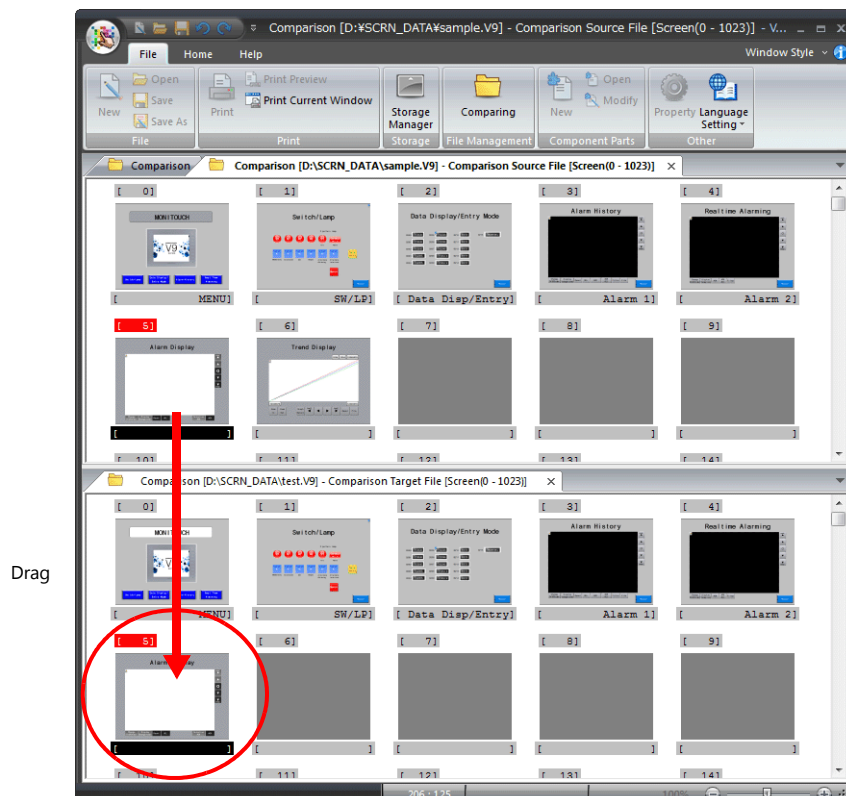

In the case of a screen, only the screen itself is copied. A pattern or graphic library that is used on the screen is not copied.

5. To copy consecutive screens, click to select the first number of the copy source screens.

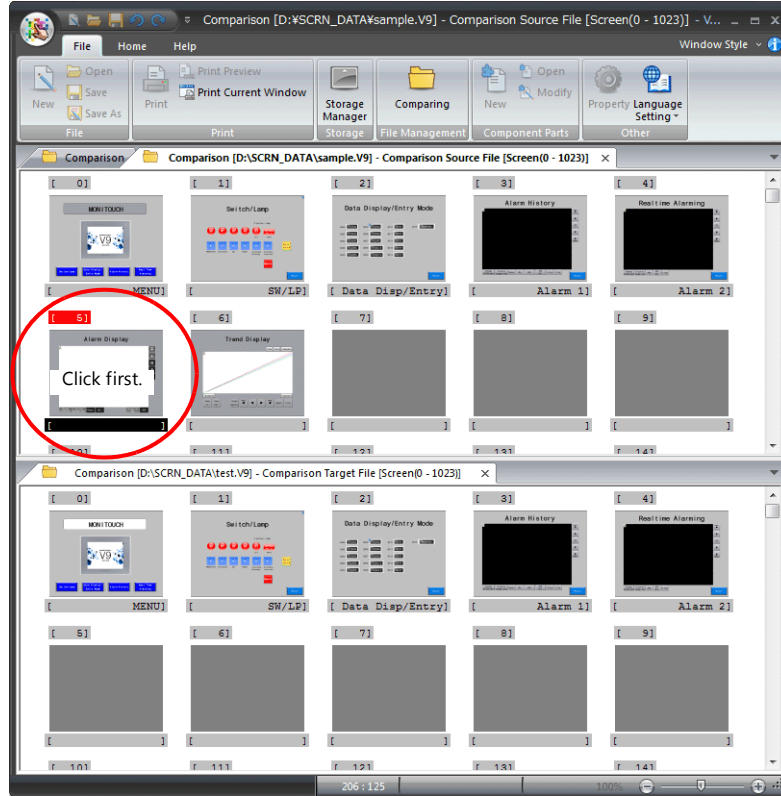

6. Click the last number of the copy source screens while holding down the [Shift] key. The screens from the first number to the last number are selected at once.

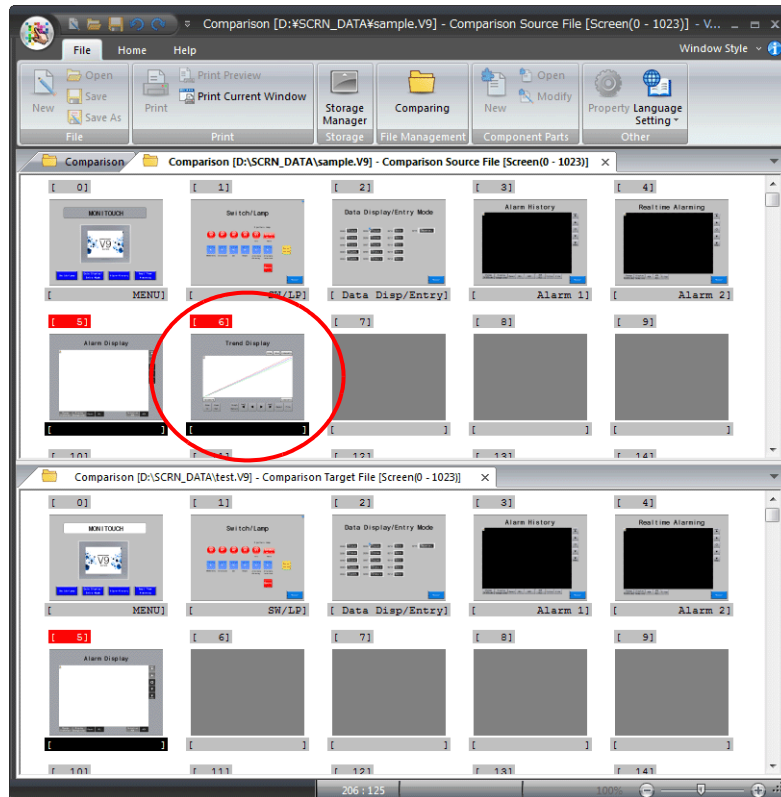

😊 Non-consecutive screens can be copied at once by clicking each screen for copying while holding down the [Ctrl] key.

7. Drag one of the selected screens to the copy destination tab window. Release the mouse button to copy all of the selected screens at once.

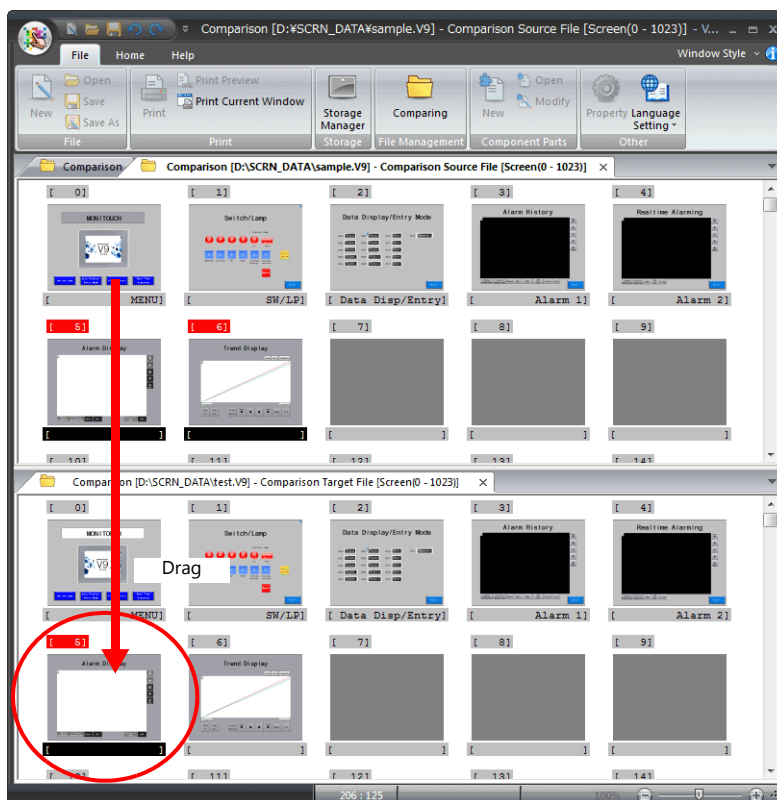

Even if non-consecutive screens are selected, their copies are placed sequentially in the destination file window.

Saving After Copying

Before closing the comparison window, select whether or not to save the copy destination screen program.

1. Click [Overwrite Comparison Target File] or [Save Comparison Target Under a New Name].

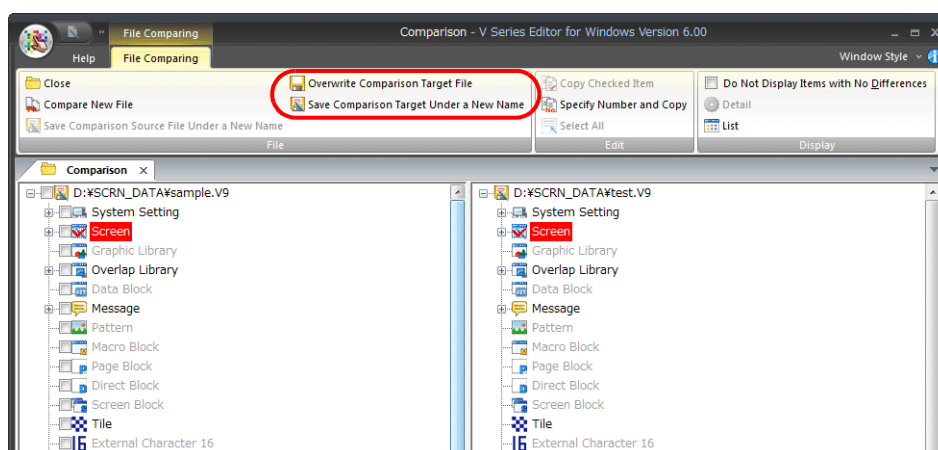

2. To discard any changes when closing the comparison window, click [No] in the following dialog box. The screen program files are closed without saving any changes.

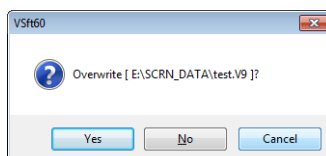

MEMO

MONITOUCH



3 Placing Parts

- 3.1 Parts Types and Limitations
- 3.2 Placement Procedure
- 3.3 Changing a Part After Placement
- 3.4 Placing and Setting Parts
- 3.5 Registering Function Items
- 3.6 Shape and Text Graphics
- 3.7 Component Parts

3.1 Parts Types and Limitations

3.1.1 Part Types

[Type] SP: single part, I: item which does not have an area, MP: combined parts

Part Name		Type
Overlap	Normal Overlap	SP
	Call-Overlap	I
	Multi-Overlap	I
Switch		SP
Lamp		SP
Data Display	Numerical Display	SP
	Character Display	SP
	Message Display	SP
	Table Data Display	SP
Entry		MP
Trend		Real time: SP History display: MP
Alarm		MP
Graph	Bar Graph	SP
	Pie Graph	SP
	Closed Area Graph	SP
	Panel Meter	SP
	Statistic Bar Graph	SP
	Statistic Pie Graph	SP
Time Display	Time Display	SP
	Calendar	SP
Image Display	Video/RGB Display	MP
	JPEG Display	MP
	Network Camera Display	MP
	Remote Desktop Display	MP
Graphic		MP
Message	Message	MP
	Comment	MP
Others	Recipe	MP
	Slider Switch	SP
	Data Block Area	MP
	Memo Pad	MP
Function Item	Sound	I
	Animation	MP
	Macro	I
	Interval Timer	I
Screen Library		*1

*1 The screen library type differs depending on the items registered in the screen library.

Part Files

The parts supplied by Hakko Electronics are registered to the screen program files in the following storage location.

- Storage location
C:\MONITOUCH\Common\Parts
- File types

Parts	Filename
Overlap	Parts_Ovlp_Cata.V9
Switch	Parts_Sw_Cata.V9
Lamp	Parts_Lp_Cata.V9
Numerical Display	Parts_NumDsp_Cata.V9
Character Display	Parts_CharDsp_Cata.V9
Message Display	Parts_MsgDsp_Cata.V9
Table Data Display	Parts_GridDsp_Cata.V9
Message	Parts_MessageMode_Cata.V9
Data Block Area	Parts_DataBlockArea_Cata.V9
Keypad	Parts_KeypadGp_Cata.V9
Bar Graph	Parts_BarGraph_Cata.V9
Pie Graph	Parts_PieGraph_Cata.V9
Panel Meter	Parts_PanelMeter_Cata.V9
Statistic Bar Graph	Parts_Stat_BarGraph_Cata.V9
Statistic Pie Graph	Parts_Stat_PieGraph_Cata.V9
Trend Parts	Parts_Trend_Cata.V9
	Parts_TrendArea_Cata.V9
	Parts_DataSamplingArea_Cata.V9
Closed Area Graph	Parts_ClosedAreaGraph_Cata.V9
Graphic Parts	Parts_Graphic_Cata.V9
Alarm Parts	Parts_AlarmDsp_Cata.V9
Time Display	Parts_DateDsp_Cata.V9
Calendar	Parts_CalenderDsp_Cata.V9
Memo Pad	Parts_MemoPad_Cata.V9
Memory Card	Parts_MemoryCard_Cata.V9
JPEG Display	Parts_JpegDsp_Cata.V9
Recipe	Parts_Recipe_Cata.V9
Comment Display	Parts_CommentItem_Cata.V9
Digital Switch	Parts_DigiSw_Cata.V9
Radio Button	Parts_RadioButton_Cata.V9
Network Camera	Parts_NetCamera_Cata.V9
Remote Desktop	Parts_RmtDeskTop_Cata.V9
Slider Switch	Parts_Slider_Cata.V9
	Parts_Slide_Cata.V9
	Parts_Rail_Cata.V9
Scroll Bar	Parts_ScrollBar_Cata.V9
Plate	Parts_Plate_Cata.V9

3.1.2 Limits on Maximum Number of Placeable Parts

The maximum number of parts permitted on one screen is determined depending on the type of parts. Limitations and the maximum number of the parts are listed below.

Part Name		Limit per ID	Limit per Base Screen/Overlap	Limit per Screen	
				V9101iW V9100iS V9080iS	V9100iC V9080iC
Overlap	Normal Overlap	-	-	10	
	Call-Overlap	-	-		
	Multi-Overlap	-	-		
Switch (*1)		None	None	4096 (*2)	
Lamp		None	None	4096 (*2)	
Data Display	Numerical Display	None	None	4096 (*2)	
	Character Display	None	None	4096 (*2)	
	Message Display	None	None	4096 (*2)	
	Table Data Display	1	256	2816	
Entry		1	1	11	
Trend		1	256	2816 (*3)	
Alarm		1	256	2816 (*3)	
Graph	Bar Graph	None	None	4096 (*2)	
	Pie Graph	None	None	4096 (*2)	
	Closed Area Graph	None	None	4096 (*2)	
	Panel Meter	None	None	4096 (*2)	
	Statistic Bar Graph	1	256	2816 (*3)	
	Statistic Pie Graph	1	256	2816 (*3)	
Time Display	Time Display	None	None	4096 (*2)	
	Calendar	1	256	2816 (*3)	
Image Display	Video/RGB Display	1	1	1	-
	JPEG Display	1	256	2816 (*3)	
	Network Camera Display	1	4	4	
	Remote Desktop Display	1	1	11	
Graphic		1	256	2816 (*3)	
Message	Message	1	256	2816 (*3)	
	Comment Display	1	256	2816 (*3)	
Others	Recipe	1	1	11	
	Slider Switch	None	None	4096 (*2)	
	Data Block Area	1	4	44	
	Memo Pad	1	1	1	
Function Item	Sound	1	256	2816 (*3)	-
	Animation	1	256	256	
	Macro	1	256	2816 (*3)	
	Interval Timer	1	256	2816 (*3)	
Screen Library		None	None	(*4)	

*1 Including slider switches and scroll bars

*2 The maximum total number of all parts that can be used on a single screen is 4096.

*3 Max. number placeable on base screen: $256 + (\text{max. number placeable on overlap} \times \text{max. number of overlaps})$
 $= 256 + (256 \times 10) = 2816$

*4 When a screen library is placed on the screen, the parts registered in the screen library are subject to the same item limit in the chart above.



There is no limit on the number of device memory addresses that perform reading on a single screen.

3.2 Placement Procedure

There are two methods for placing parts. This section explains each part placement procedure.

3.2.1 Placing Parts from the Ribbon Menu

Placement Procedure (E.g.: Switch)

1. Click [Home] or [Parts] → [Switch].

Moving the mouse to the editing tab window moves the part together with the mouse cursor.

- Home

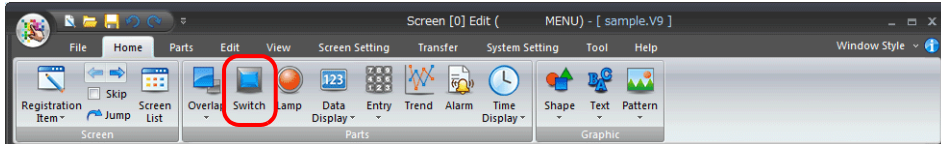

- Parts

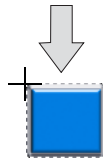
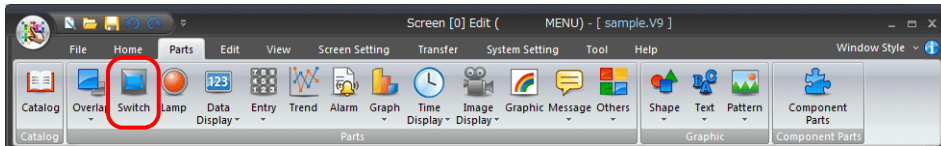

The part moves together with the mouse cursor.

* **The part displayed here is the default or the one which was changed or selected last.**

2. Click the left mouse button at an arbitrary position on the screen. The switch part selected in step 1. is placed on the screen.

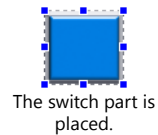

3.2.2 Placement from the [Catalog] View Window

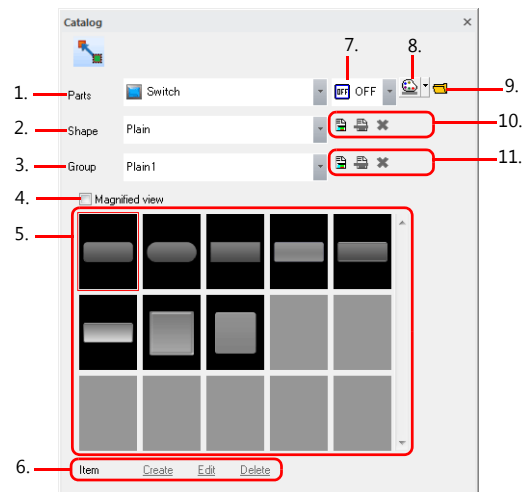

Item	Description
1. Parts	Click to display a pull-down menu. Select a part.
2. Shape	Click to display a pull-down menu. Select a shape.
3. Group	Click to display a pull-down menu. Select a group.
4. Magnified view	Magnify the display of parts shown in the catalog.
5. Part list	Displays parts according to the selected shape and group.
6. Item	This is enabled when creating a part using a PNG file. * For more information, refer to "11 Parts Editing".
7. Pattern change	This is only available for switch and lamp parts. The status display of the OFF, ON, or P3 onward patterns can be checked in the [Part Type Select] window.
8. Color palette	Select the display color of the part. * This is disabled for "Sign", "3D_128", "HA", and "Plate" shape parts.
9. Open file	Open a .V9 file.
10. Add custom shape	This is enabled when creating a part using a PNG file. For more information, refer to "11 Parts Editing".
11. Add custom group	

Placement Procedure (E.g.: Switch)

- Click [Parts] → [Catalog].
The [Catalog] view window is displayed.

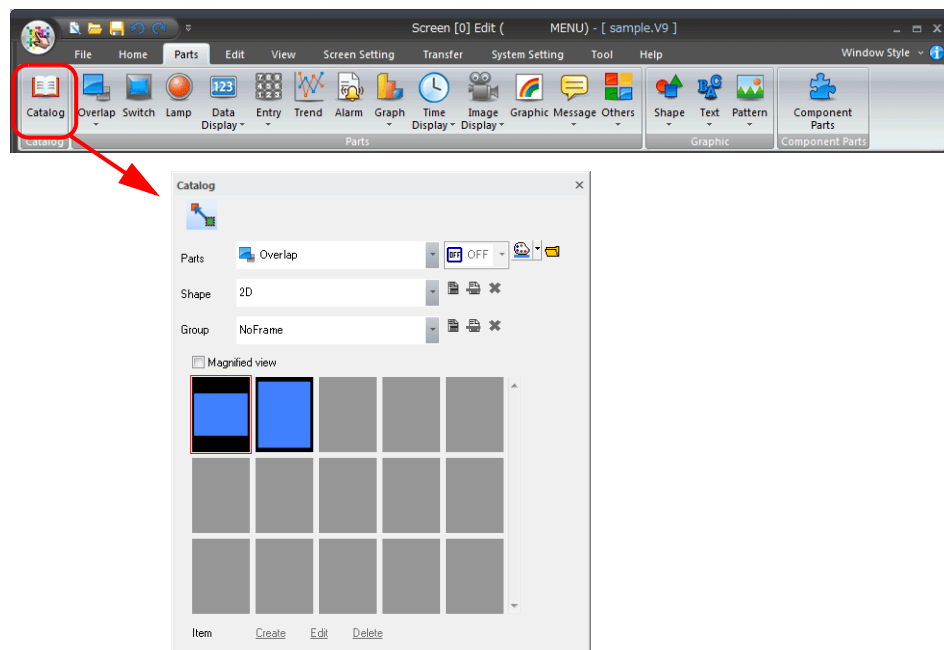

2. Select [Switch] for [Parts]. (If it is already selected, proceed to step 3.)

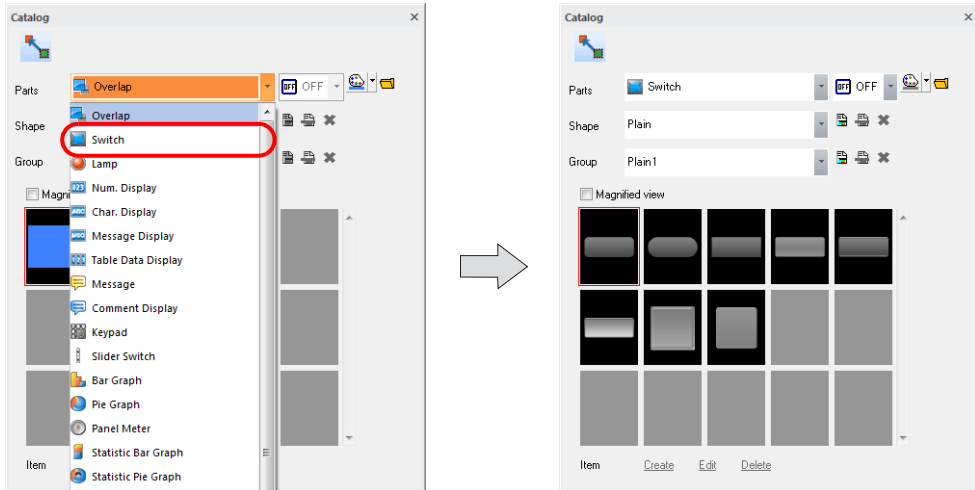

3. Change the switch list using [Shape] and [Group] and find the desired part in the switch part list.

• [Shape]

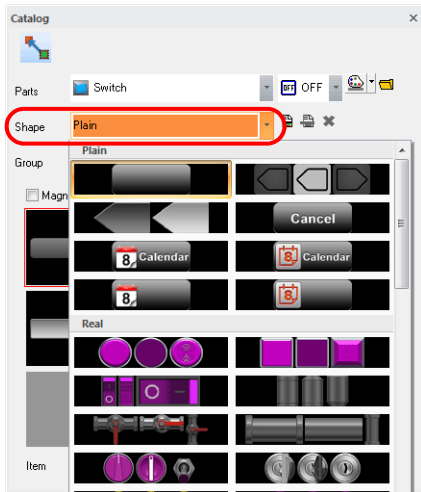

• [Group]

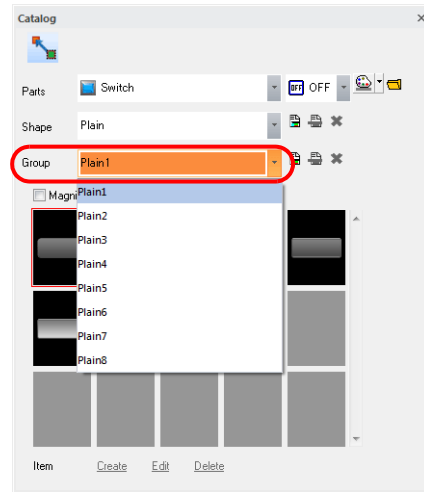

4. Select a switch and drag it onto the screen.
This places the switch part on the screen.

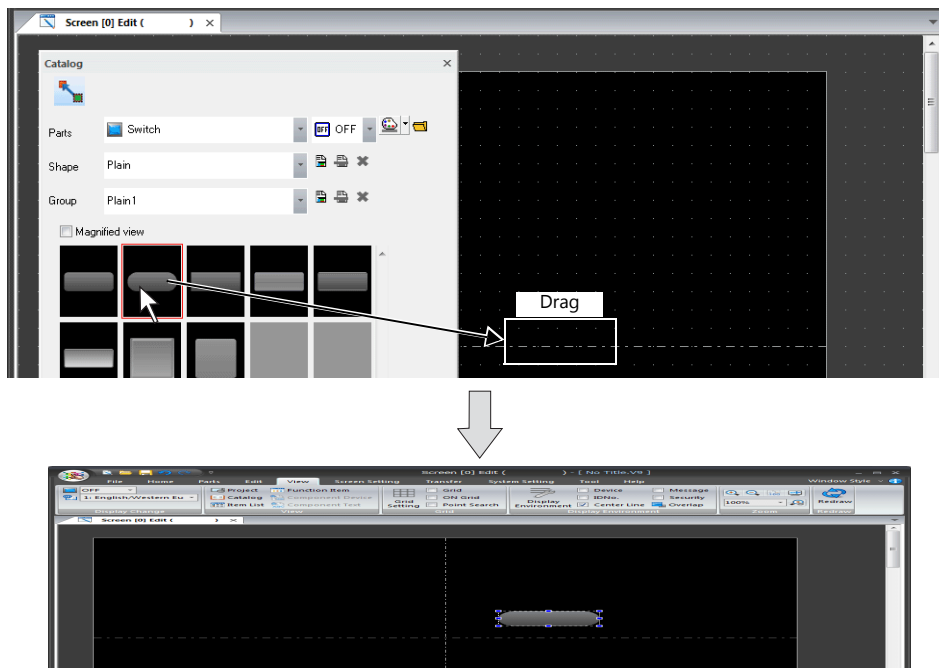

3.3 Changing a Part After Placement

3.3.1 Single Parts

Item Settings Window

The settings of parts placed on the screen can be changed or checked in the item settings window.

The settings in the item settings window vary depending on the item, however, the operation procedure is generally the same.

The item settings window is displayed by double-clicking on the relevant part.

Changing the Part Design

When changing the design of a placed part, operate the item settings window according to the following procedure. (E.g.: switch)

1. Double-click on the switch to display the [Switch] item settings window.

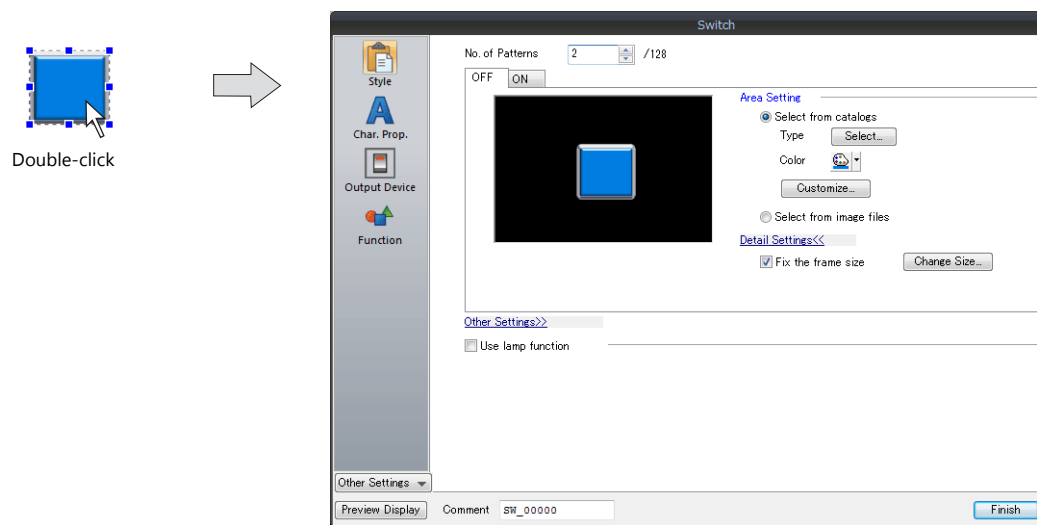

2. Open the [Style] settings and click [Select] located at [Area Setting] → [Select from catalogs] → [Type].

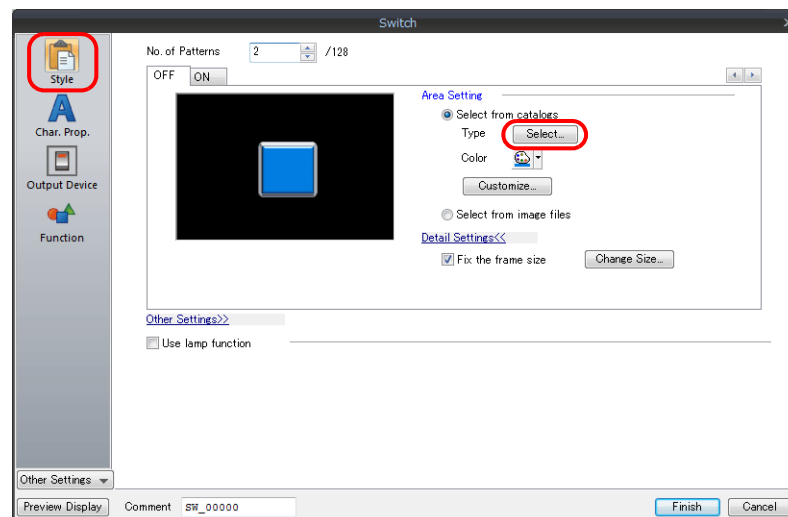

3. The [Part Type Select] window is displayed.

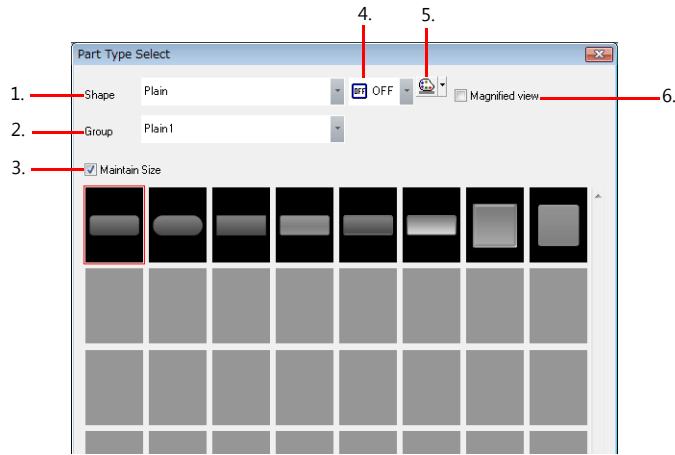

Item	Description
1. Shape	Click to display a pull-down menu. Select a shape.
2. Group	Click to display a pull-down menu. Select a group.
3. Maintain Size	Change the part design while maintaining the size and settings of the placed part. When unselected, parts are changed to the default size.
4. Pattern change	This is only available for switch and lamp parts. The status display of the OFF, ON, or P3 patterns can be checked in the [Part Type Select] window.
5. Color palette	Select the display color of the part. * This is disabled for "Sign", "3D_128", and "HA" shape parts.
6. Magnified view	Magnify the display of parts shown in the [Part Type Select] window.

Part shape	
Shape	Description
Plain	Parts that use smartphone-like images. (V9 only parts)
Real	Parts that use realistic images. (V8 compatible parts)
Sign	Parts that use symbol images. (V8 compatible parts)
3D/3D_128/HA	V7 series compatible parts.
2D	2D parts.

4. Select the desired part and click [OK].

The [Switch] item settings window is displayed. The selected part is displayed on the screen.

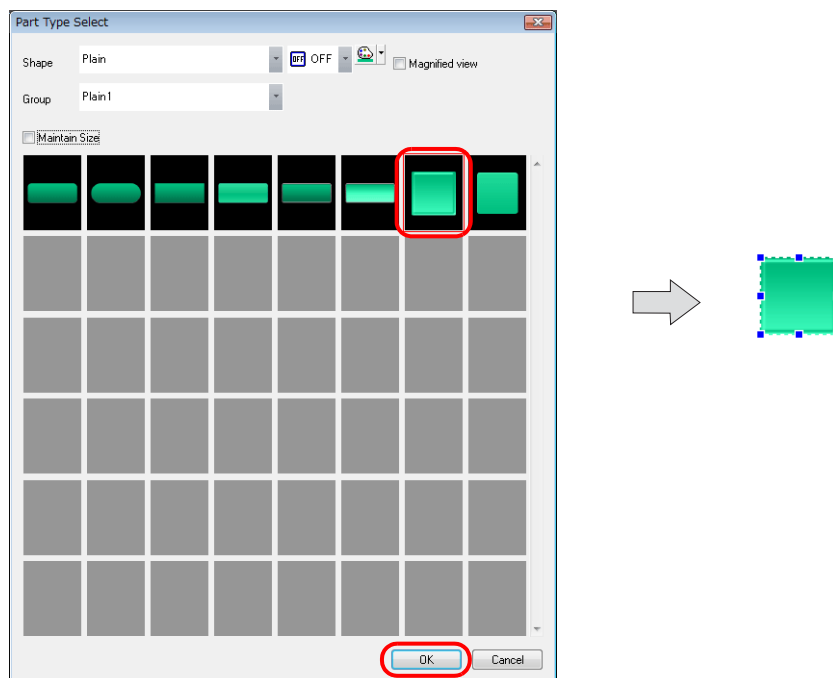

Changing the ON/OFF Design (Only for Switches and Lamps)

The design of the ON, OFF, P3 to P128 display patterns of switches and lamps can be changed by clicking [Customize] in the item settings window.

* Part shapes: Only available for "Plain", "Real", and "3D"

E.g.: Switch

1. Open the [Style] settings in the item settings window and click [Area Setting] → [Select from catalogs] → [Customize] on the [OFF] tab. The [Change the image] window is displayed.

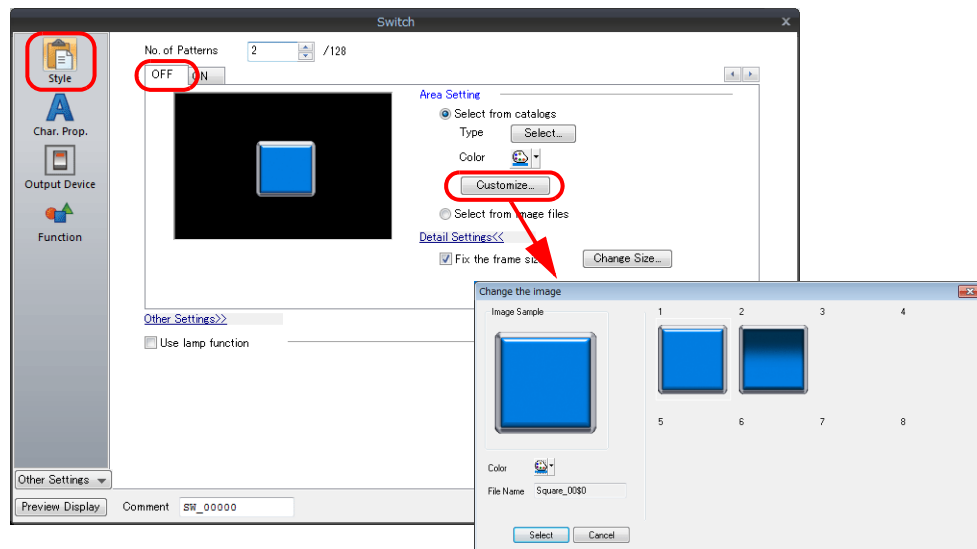

2. Select the design to display for the OFF pattern from the design list and click [Select].

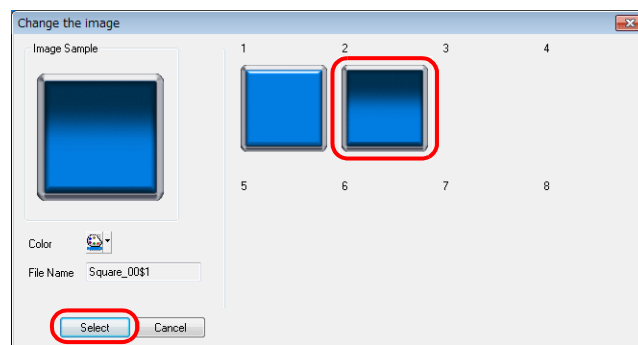

3. The OFF pattern design is changed.

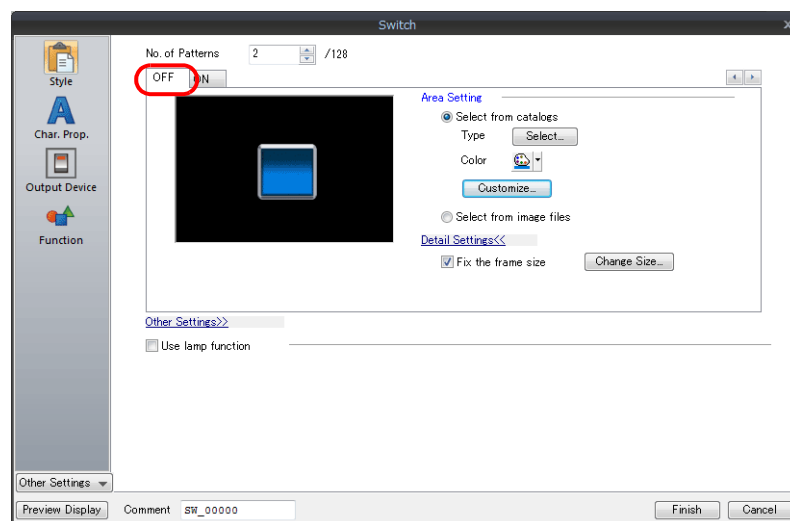

4. Select the design to display in the same manner for the ON and P3 to P128 patterns via [Customize].

Changing Coordinates and Size

The part position can be specified in the item settings window if it needs to be changed.

For items whose size can be changed with dot size specification, such as switches, lamps, graphs, boxes/circles, the part size can also be changed in the item view window.

E.g.: Rectangle

1. Click the rectangle part to display the [Box] item view window.

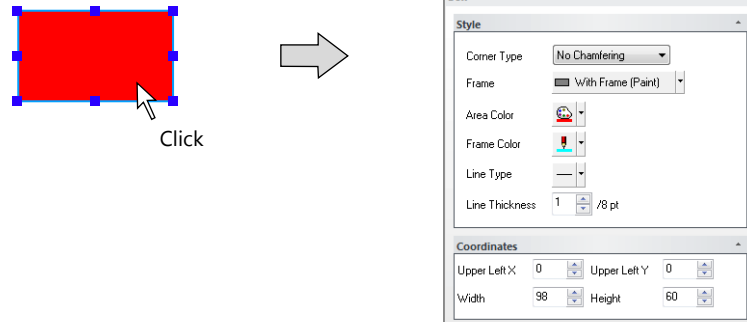

2. Specify the position and size in the [Coordinates] section.

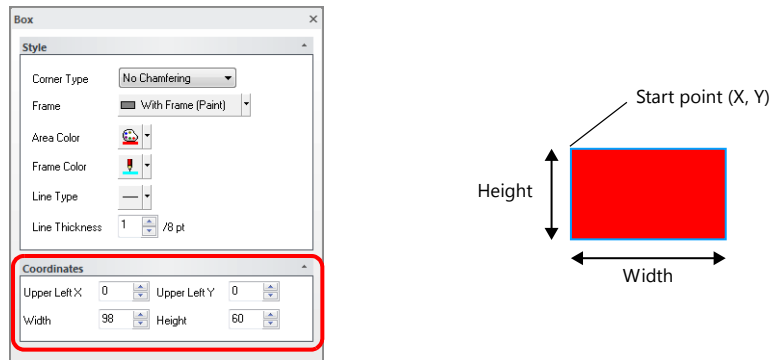

Item	Description
Upper Left X	Specify the X coordinate of the upper left of the rectangle.
Upper Left Y	Specify the Y coordinate of the upper left of the rectangle.
Width	Specify the width of the rectangle.
Height	Specify the height of the rectangle.

3. When an arbitrary value is specified, the rectangle on the screen is moved or transformed accordingly.

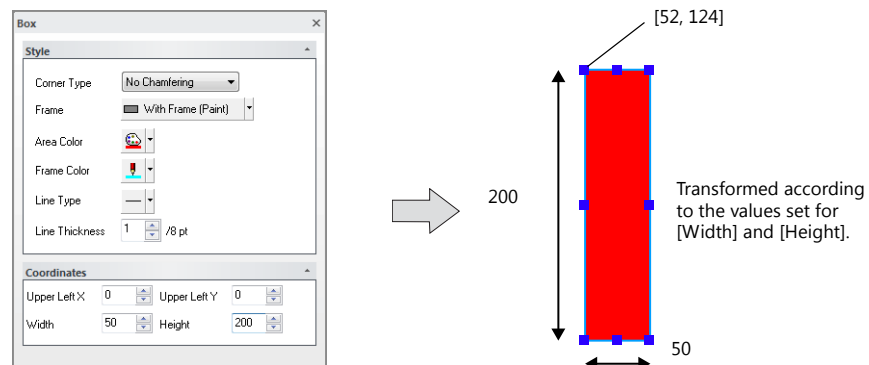

3.3.2 Linked Parts

What Are “Linked Parts”?

“Linked parts” are placed parts that comprise multiple items (for example, alarm parts, trend parts, etc.). These are called “linked parts.” Selecting linked parts displays the item settings window for the set of parts.

 If the parts display red handles when selected by clicking on them after placement, they are linked parts.

Example of Changing Part Settings (E.g.: Trend Parts)

This section explains the procedure for changing linked parts as shown below.

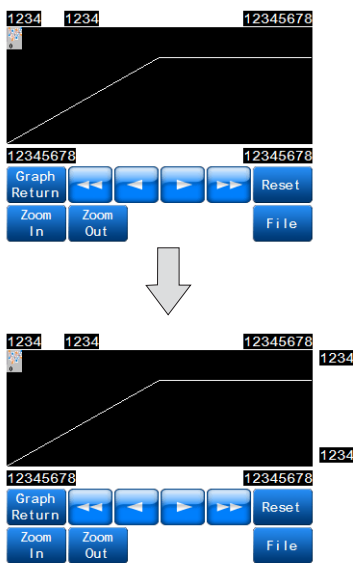

Adding and deleting parts

1. Double-click on the placed trend parts. The parts are enclosed with red handles and the item settings window is displayed.

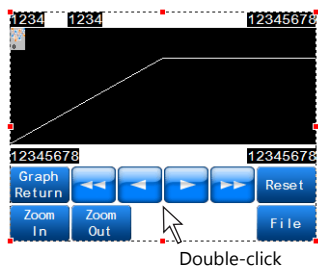

2. Open the [Style] settings.

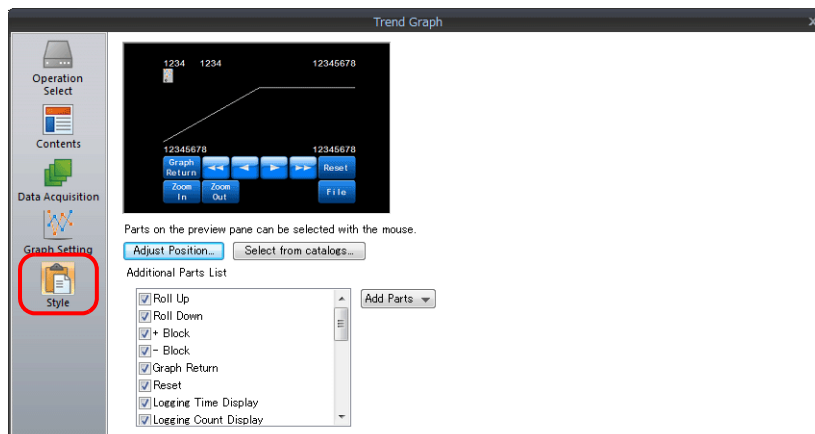

3. Deselect the [Zooming in] and [Zooming out] checkboxes in the [Additional Parts List].
The [Zoom In] and [Zoom Out] switches are deleted from the preview pane.

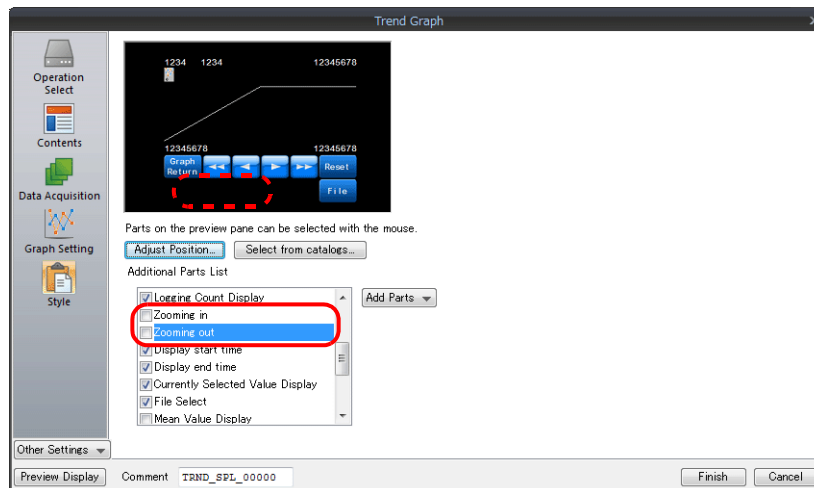

4. Select the [Max. Display] and [Min. Display] checkboxes in the [Additional Parts List].
Numerical displays with the [Function] setting set to [Max. Display] and [Min. Display] respectively are added in the preview pane.

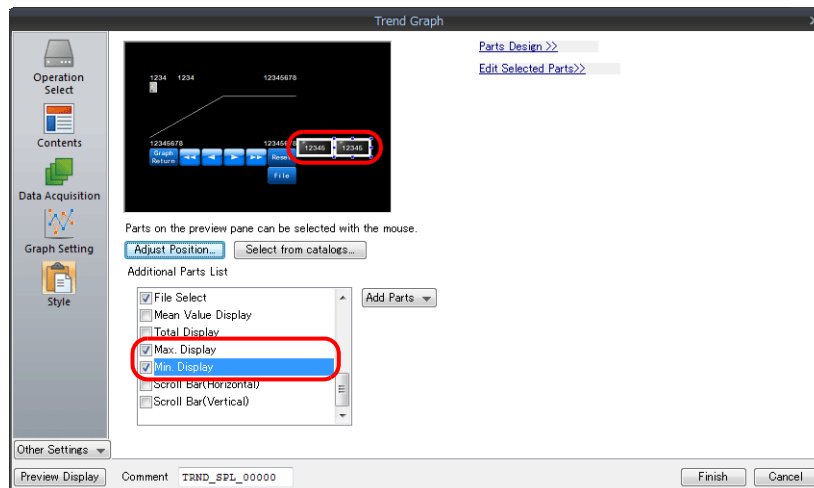

5. Configure settings such as the design and text properties of the numerical display parts in the [Parts Design] and [Edit Select Parts] areas.

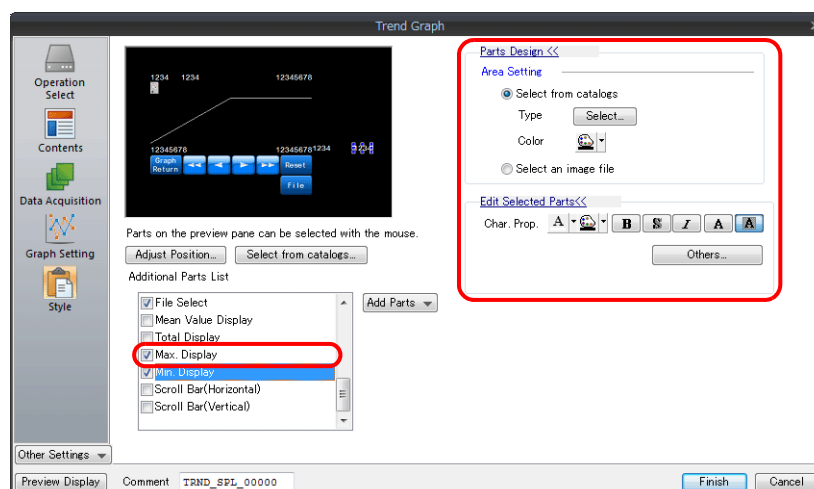

Changing the placement position and size of individual parts

1. Double-click on the placed alarm parts. The parts are enclosed with red handles and the item settings window is displayed.

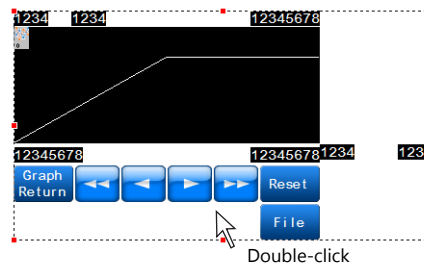

2. Click [Adjust Position] in the [Style] settings to display the position adjustment window.

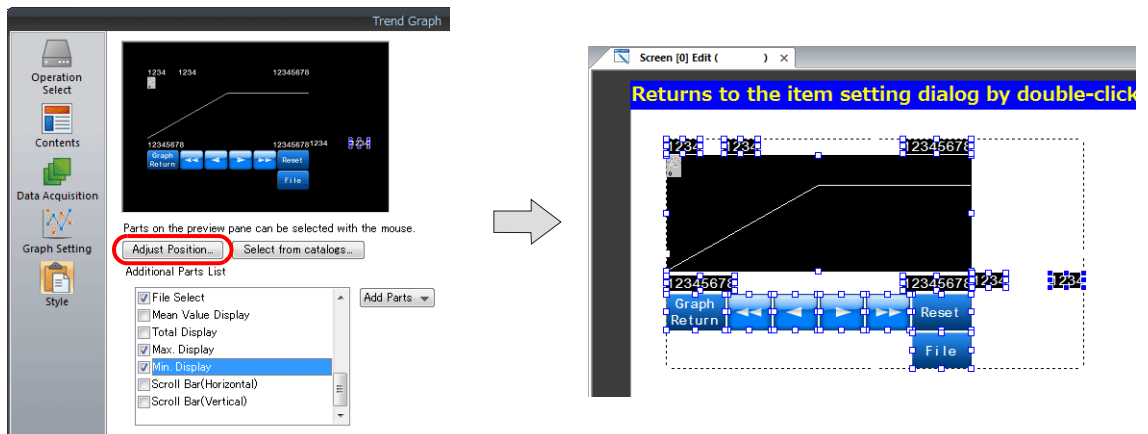

3. Select each part and adjust the size and placement position.

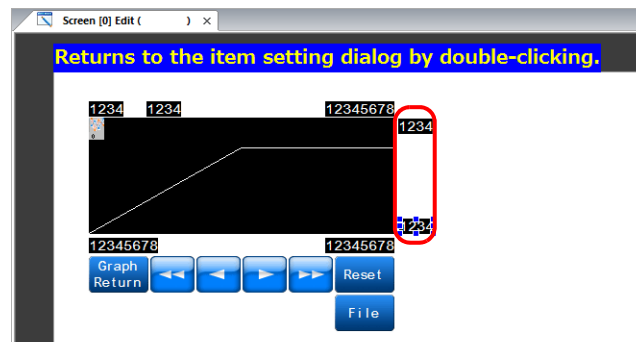

4. When the layout is complete, double-click on the position adjustment window. The item settings window is displayed.

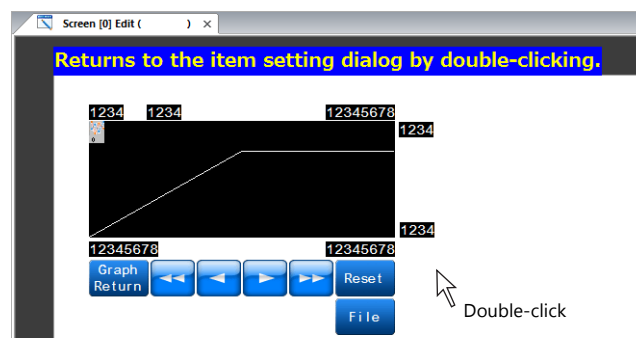

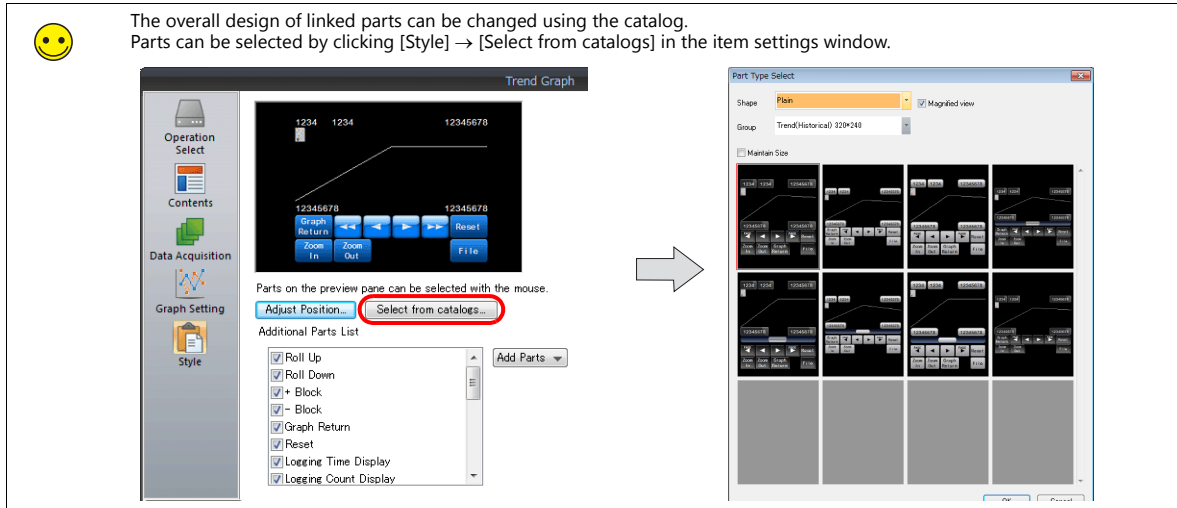

Removing links

1. Click to select the linked parts.

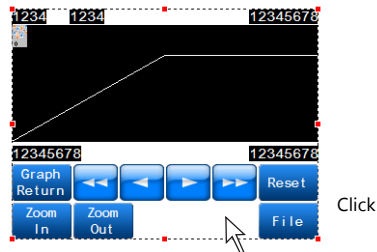

2. Click [Edit] → [Link] → [Link Cancel], or right-click and select [Link] → [Link Cancel]. The selected linked parts are separated into individual parts.

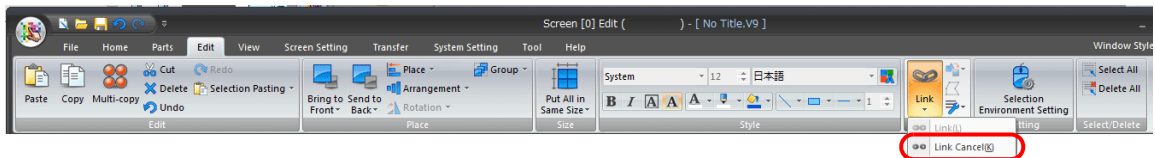

OR

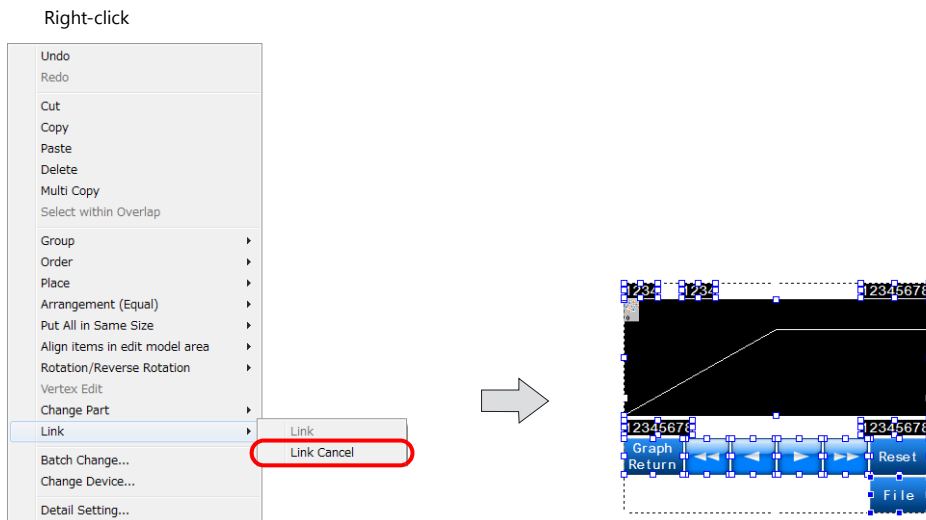

Linking parts

After linked parts are separated into individual parts, it is recommended to link them again after editing. Follow the procedure below to link parts.

1. Select the parts to be linked together.

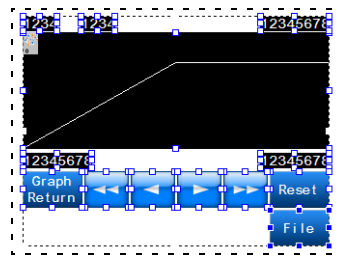

Drag the mouse to enclose all of the parts to be linked.



If it is difficult to select all of the parts at once, click the parts one by one while holding down the [Shift] key. Multiple parts can be selected.

2. Click [Edit] → [Link] → [Link], or right-click and select [Link] → [Link]. The selected parts are linked and red handles are displayed around the linked parts.

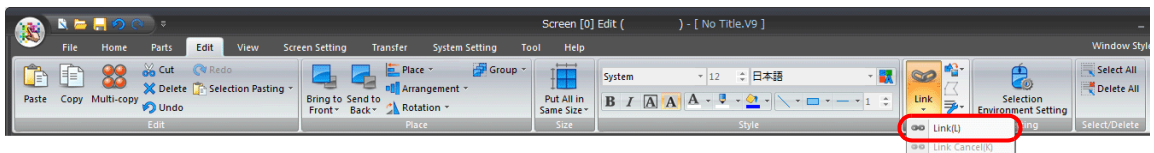

OR

Right-click

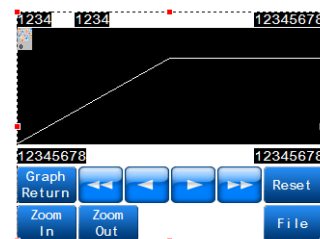
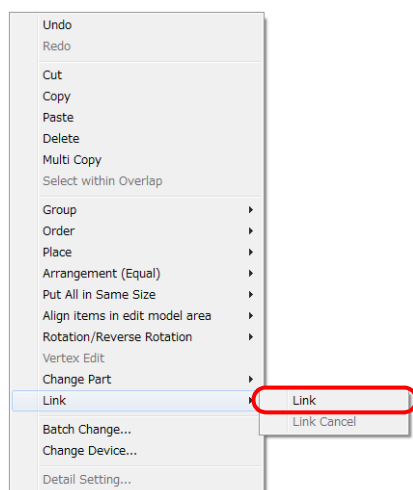

3.4 Placing and Setting Parts

3.4.1 Overlaps

Normal Overlap Display

Placement procedure

1. Click [Parts] → [Overlap] → [Normal Overlap] and move the mouse over the screen. A normal overlap display appears on the screen.

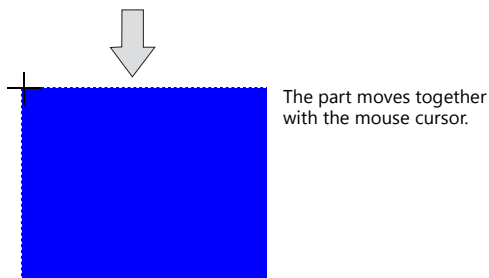
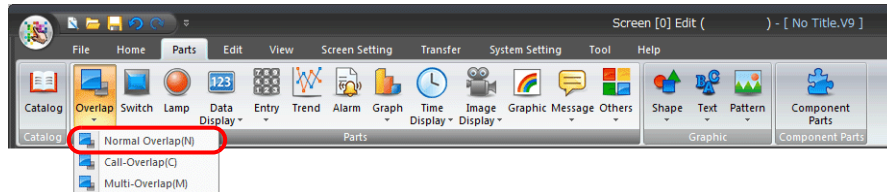

2. Click the left mouse button at the desired position. This places the normal overlap display on the screen. Double-click the placed normal overlap display to display the item settings window.

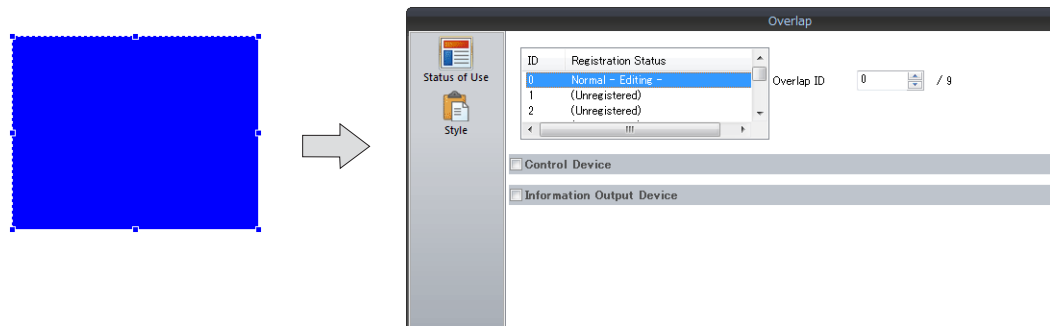

3. To change the design, click [Type] → [Select] in the [Style] settings.

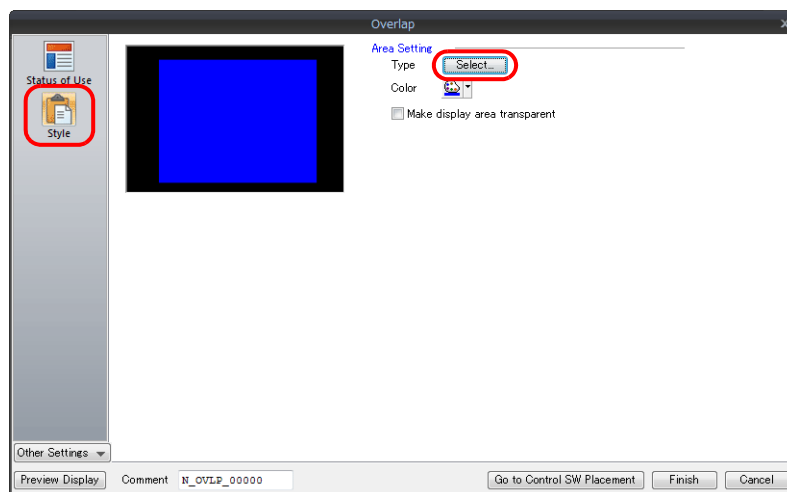

- The [Part Type Select] window is displayed.
Change the [Shape] and [Group] settings to find the desired design, select the design to use, and click [OK].
The [Style] settings are displayed again. It is also possible to change colors in the [Style] settings.

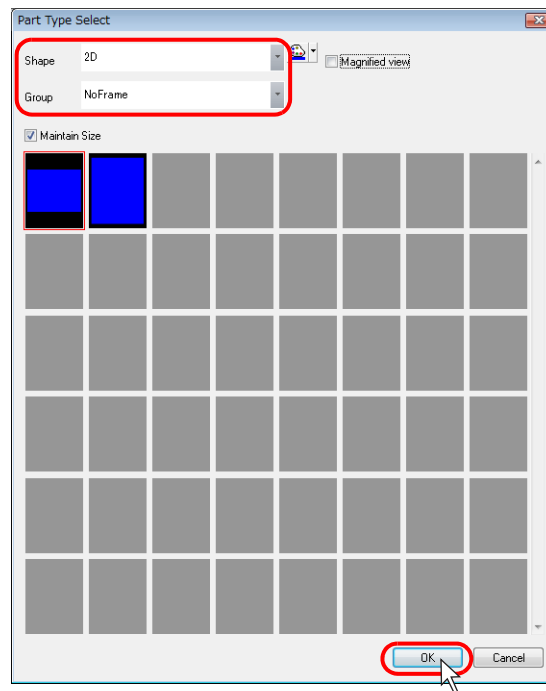

- When settings such as size require changing, they can be configured in the item settings window.

Placing items on overlap displays

This section explains the procedure for creating an overlap display that contains the following items.

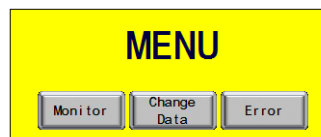

- Right-click on the screen in which the normal overlap display is placed.
* **Make sure that the normal overlap display is not selected when right-clicking on the screen.**

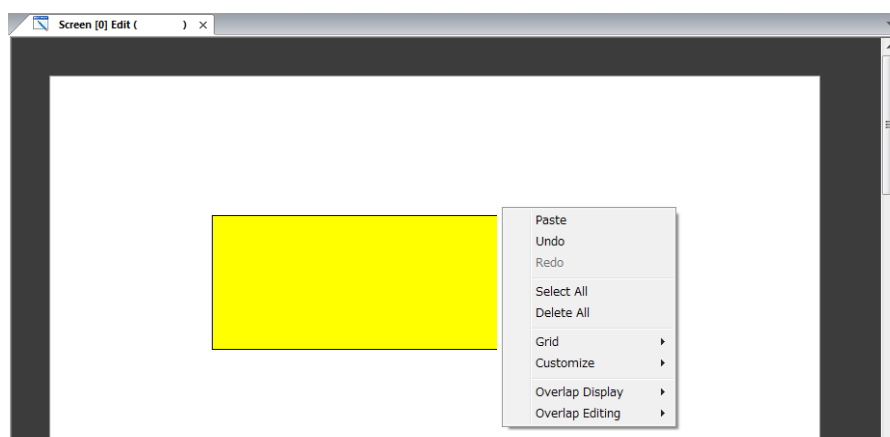

2. Click [Overlap Editing] → [ID 0].

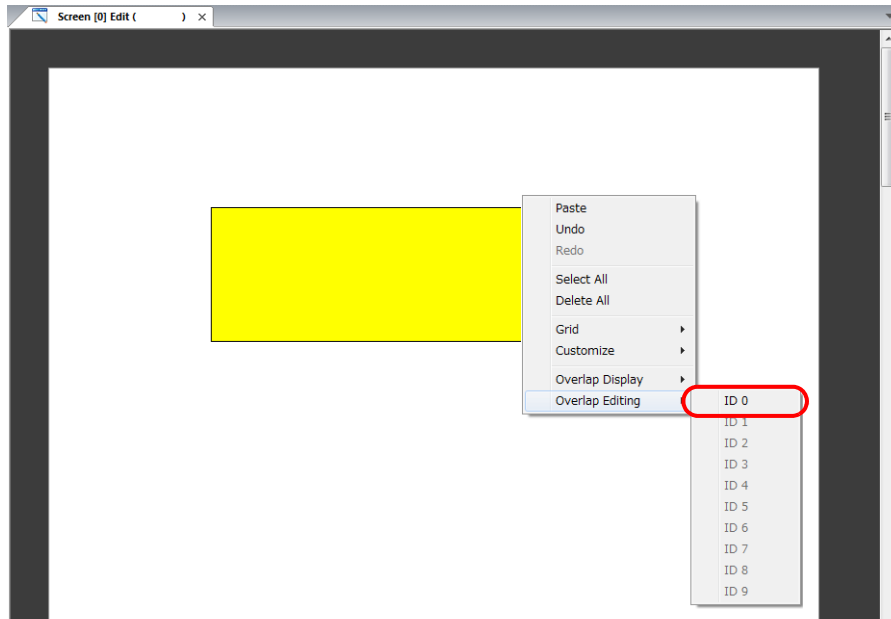

3. The [Screen Edit] tab window switches to the [Overlap Edit] tab window.

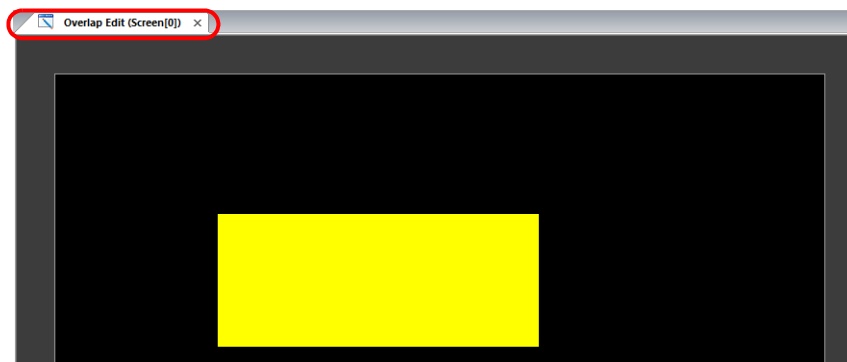

4. Click [Parts] → [Switch] and place a switch on the overlap display.

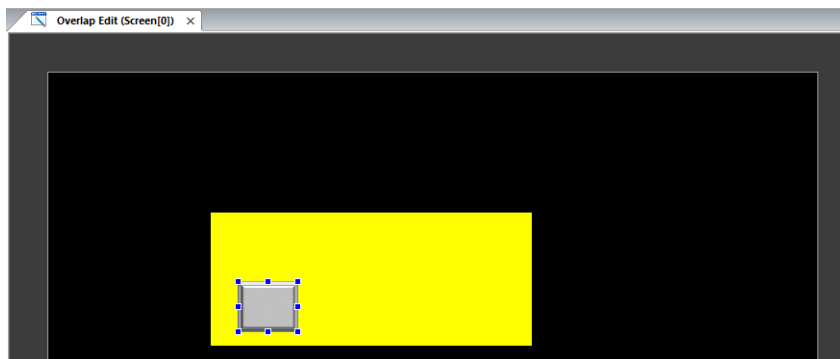

☺ Items can be placed without switching to the [Overlap Edit] tab window.

With the overlap display selected, click [Parts] → [Switch] and move the mouse cursor over the screen. When the cursor is located over the overlap display, click the left mouse button. This places the switch part on the overlap display.

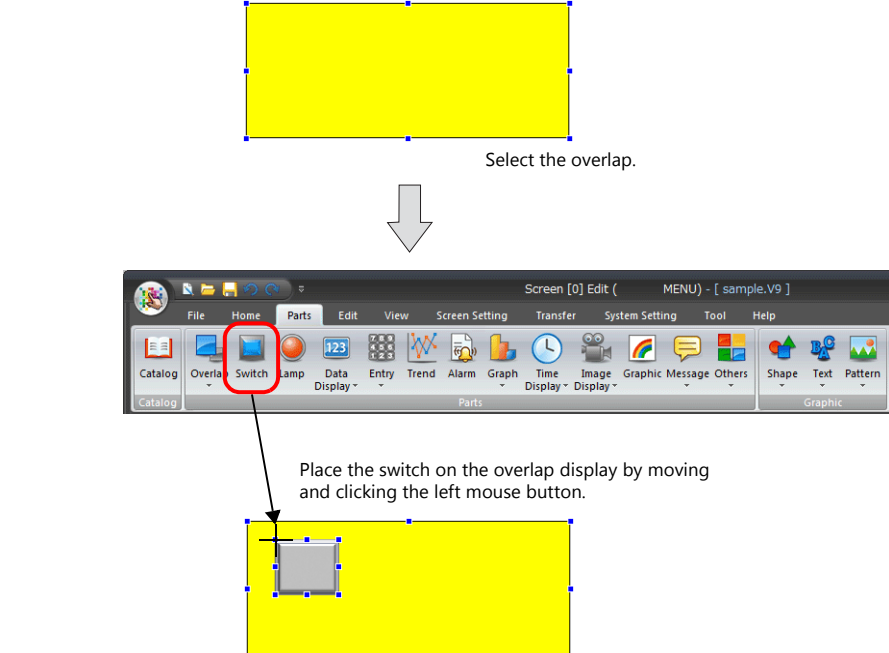

Select the overlap.

Place the switch on the overlap display by moving and clicking the left mouse button.

5. Make copies of the placed switch and enter text for each switch.





Multiple items can be selected without switching to the [Overlap Edit] tab window. There are two methods.

One method is selecting the overlap display and then clicking the parts one by one while holding down the [Shift] key.

The other method is clicking [Select within Overlap] on the right-click menu and enclosing the parts to be selected with the mouse within the overlap display area.

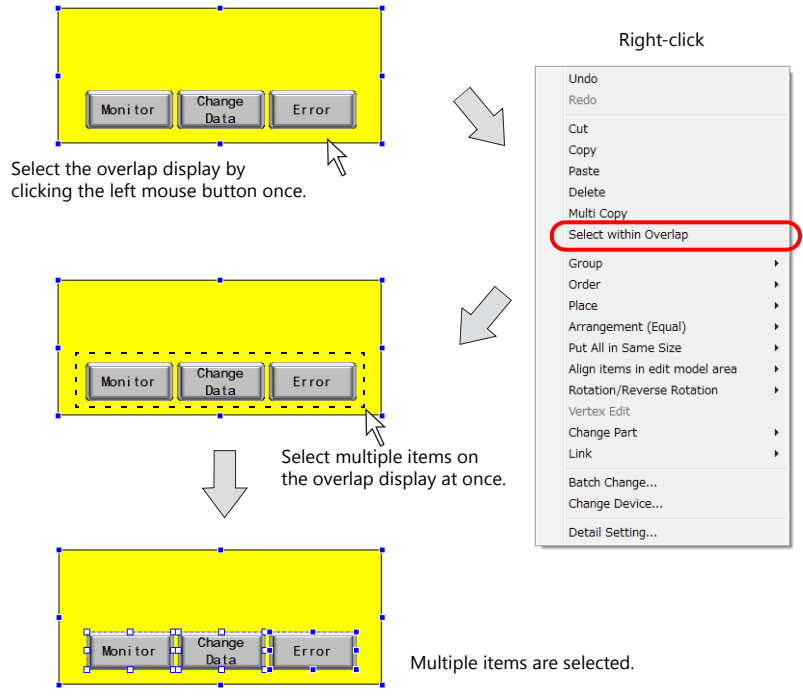

6. Next, create text as a drawing part on the overlap display.

7. Click [Parts] → [Text] → [Text] and draw a text entry box by dragging the mouse at the desired position on the overlap display.

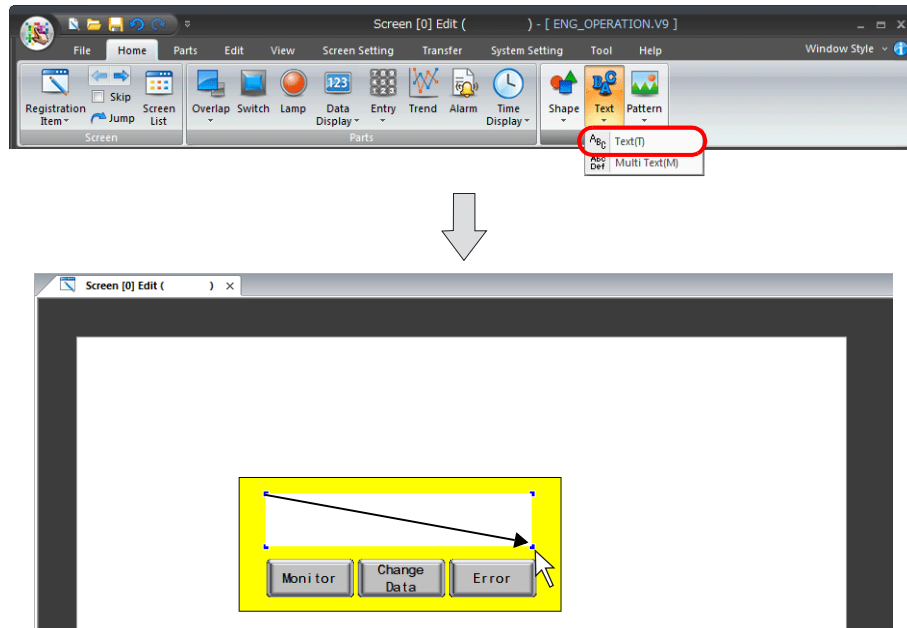

8. The cursor is displayed in the box drawn in step 7. Enter "Menu" and click a position outside the text box. The entered text is displayed on the screen.

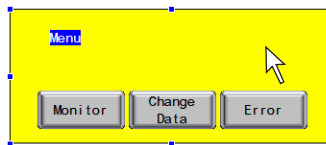

9. When changing the size or color, click (or double-click) the text to display the item view window and make the necessary changes.

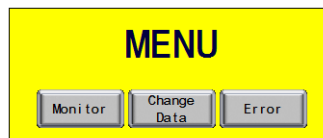

10. When editing is complete, right-click and select [Overlay Editing] → [ID 0]. This returns to the [Screen Edit] window.

This completes the overlap display editing procedure.

Multi-overlap (Call-overlap) Display

Placement procedure

The multi-overlap (or call-overlap) display is selected from the [Parts] menu or [Catalog] view window. The actual overlap display is edited in the overlap library.

1. Click [Parts] → [Overlap] → [Multi-overlap].
A [Multi-overlap] icon is displayed on the screen.

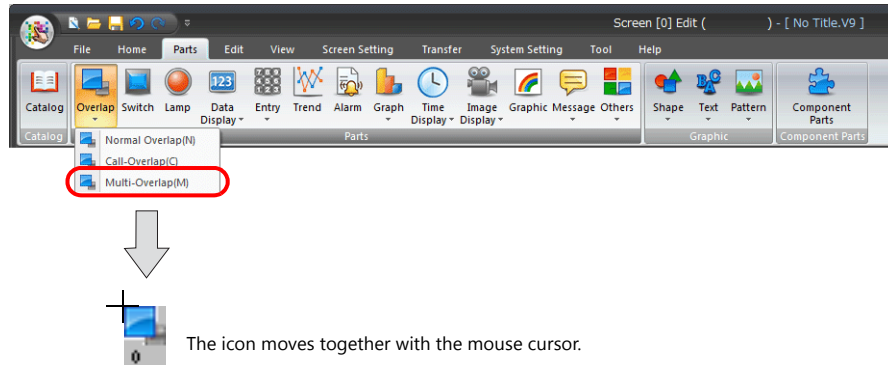

2. Click the left mouse button at the desired position. This places the multi-overlap icon on the screen.
Double-click the placed icon to display the item settings window.

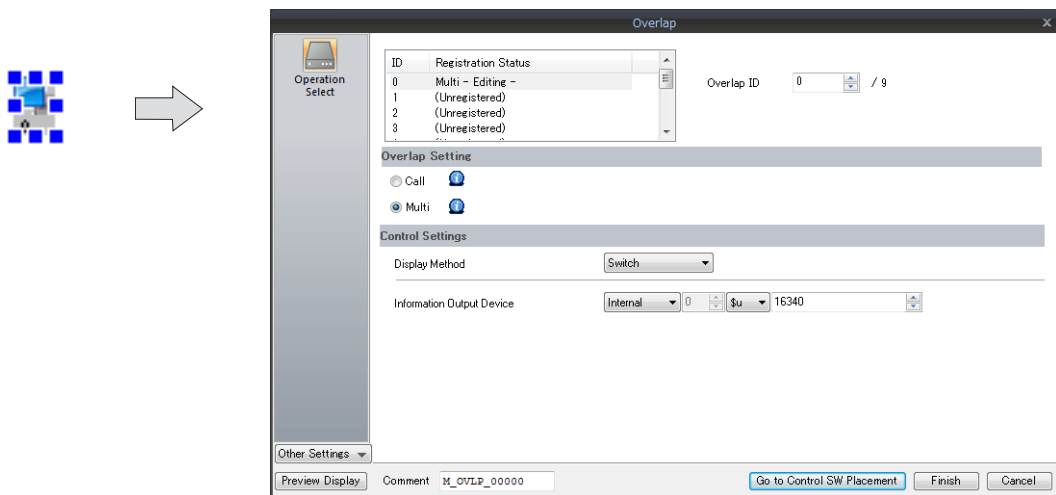

Overlap parts placement and editing

The multi-overlap display is placed or edited using the "overlap library."



For more information on the overlap library, refer to "6.4 Overlap Library" page 6-10.

3.4.2 Switches and Lamps

Placement procedure

1. Click [Parts] → [Switch] or [Lamp] (or drag the desired part from the [Catalog] view window).
Moving the mouse to the editing tab window moves the part together with the mouse cursor.

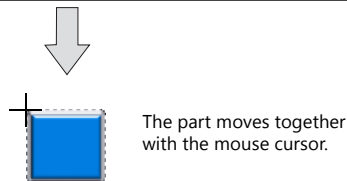
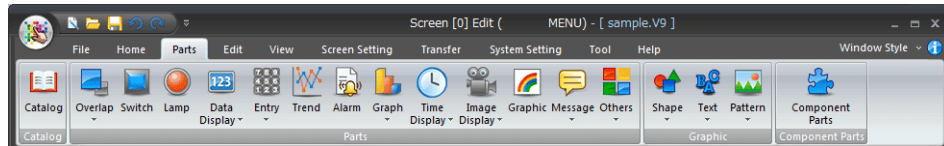

* The part displayed here is the default or the one which was changed or selected last.

2. Click the left mouse button at the desired position to place the switch or lamp.

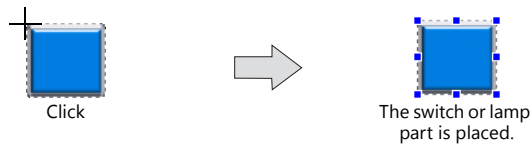

Setting method

Double-click the placed switch or lamp to display the item settings window.

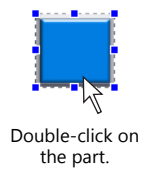

The item settings window is displayed ([Switch] in this example).

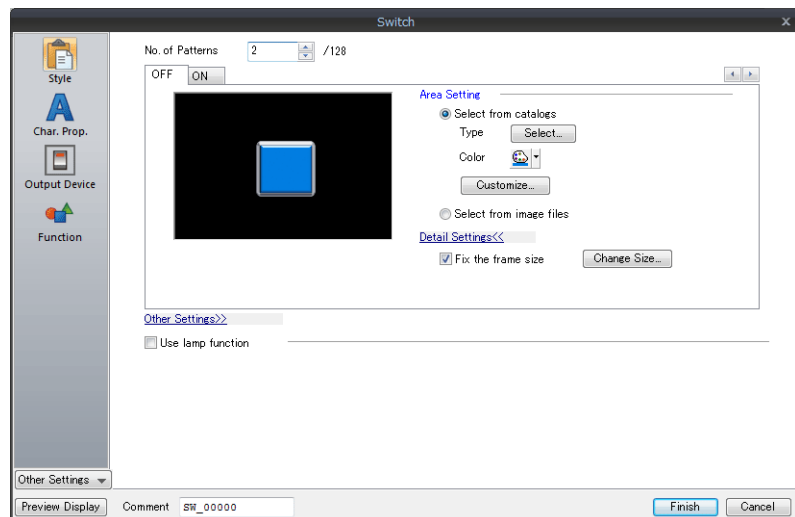

3.4.3 Data Display

Numerical Display, Character Display, and Message Display

Placement procedure

1. Click the item selected from [Parts] → [Data Display] (or drag an item from the [Catalog] view window).
Moving the mouse to the editing tab window moves the part together with the mouse cursor.

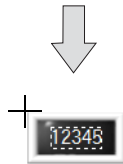
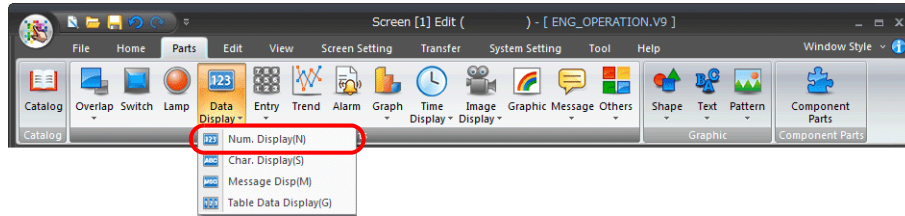

The part moves together with the mouse cursor.

* The part displayed here is the default or the one which was changed or selected last.

2. Click the left mouse button at an arbitrary position on the screen. This places the data display on the screen.



Click

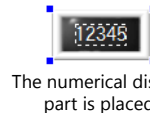

The numerical display part is placed.

Setting method

Double-click the placed data display to display the item settings window.

The item settings window is displayed ([Num. Display] in this example).

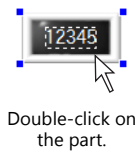

Double-click on the part.

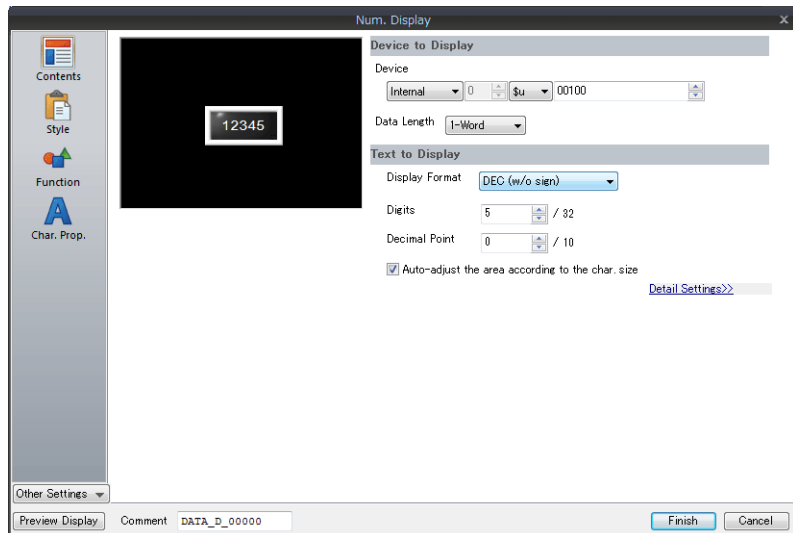
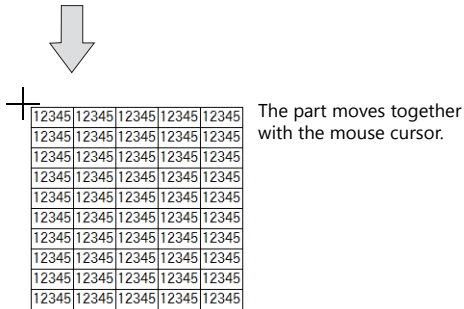
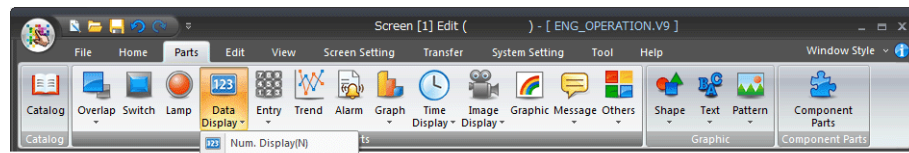

Table Data Display

Placement procedure

1. Click [Parts] → [Data Display] → [Table Data Display] (or drag the desired part from the [Catalog] view window).
Moving the mouse to the editing tab window moves the table data display part together with the mouse cursor.



* The part displayed here is the default part.

2. Click the left mouse button at an arbitrary position on the screen. The table data display part is placed.

Setting method

Double-click the placed table data display to display the item settings window.

Display the item settings window.

Click on the table data display.

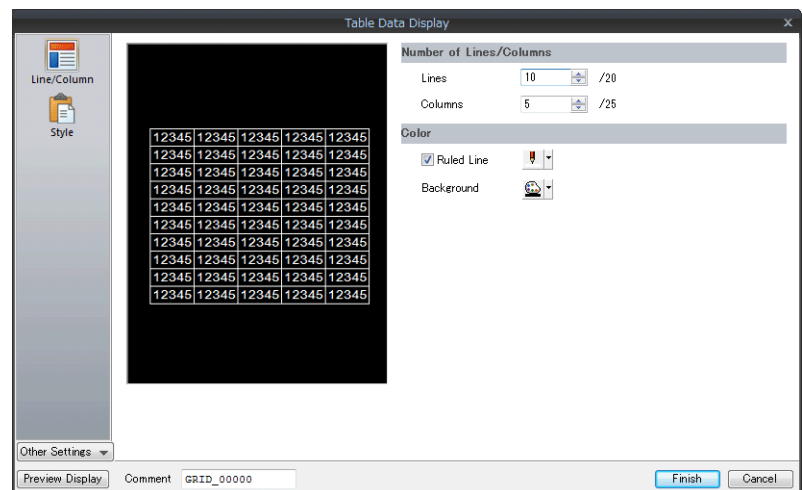
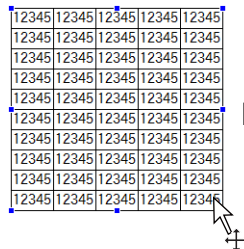

Setting and changing data

1. Click the table data display to select the part and show handles.

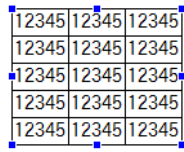

2. Right-click the mouse on the cell for editing to highlight the cell and display the right-click menu.

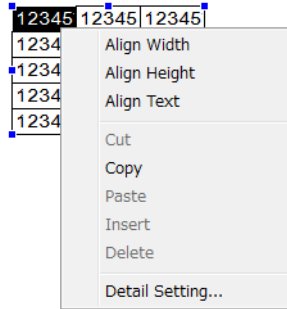

3. Select [Detail Setting] from the menu to display the [Table Data Display] item settings window. Under [Select a cell format], select the data display format from numerical display, character display, message display, and text.

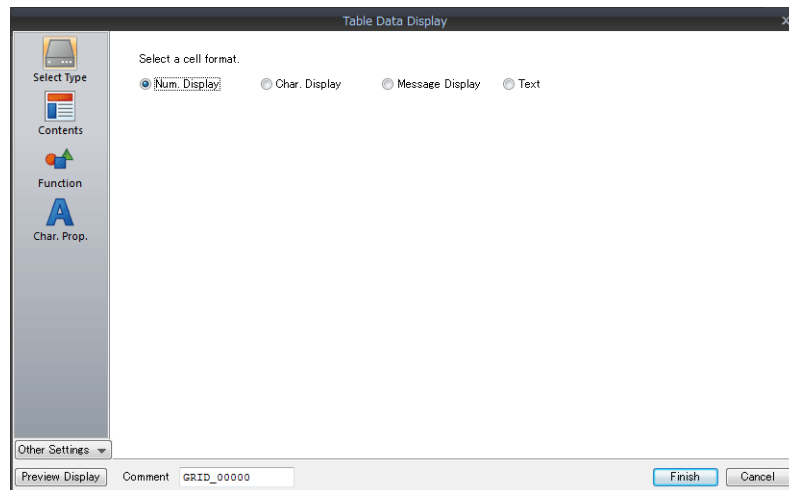

4. Set the [Contents] settings.

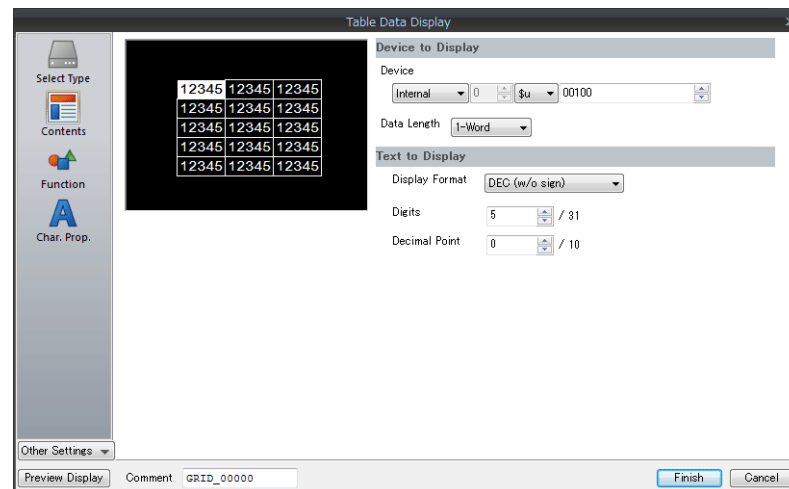

Changing the properties of multiple data cells

1. Click the table data display to select the part and show handles.

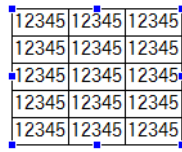

2. Right-click the mouse on the cell for editing to highlight the cell and display the right-click menu.

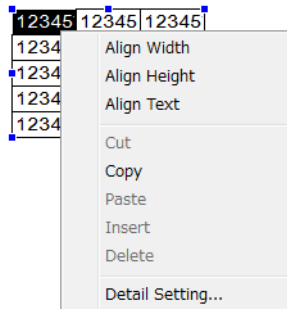

3. Select two or more cells by right-dragging. This highlights the selected data display area and displays the right-click menu.

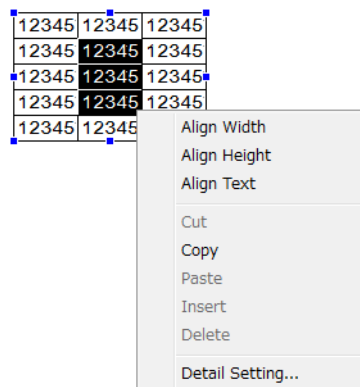

4. Select [Detail Setting] from the menu to display the [Table Data Display] item settings window.
Under [Select a cell format], select the data display format for the cells.
When multiple cells with differing data display formats are selected, the item settings window is displayed without anything selected for [Select a cell format].



When a setting is selected in the displayed item settings window, the data display format and properties are changed for all of the selected cells.
(When the [Incremental Direction] checkbox is not selected, the previous device memory setting is maintained.)

5. Set the [Contents] settings.

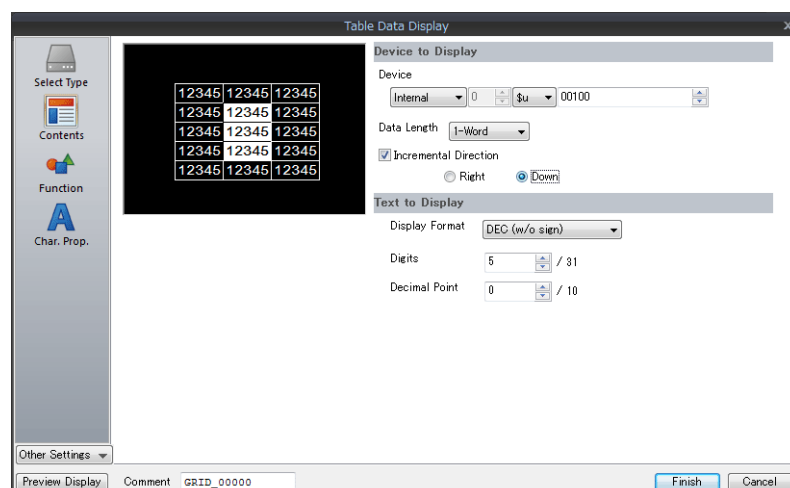

Changing the height and width of cells

- Changing the width

When changing the cell width, specify the border line to move using the top row of cells as shown below.

When the cursor changes to , drag the border line to adjust the cells to the desired width.

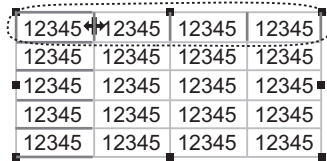

- Changing the height

When changing the cell height, specify the border line to move using the left column of cells as shown below.

When the cursor changes to , drag the border line to adjust the cells to the desired height.

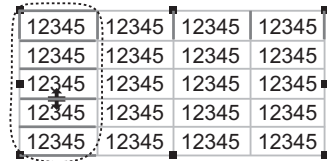

Right-click menu

When cells are selected in a table data display by right-clicking or right-dragging, a menu is displayed.

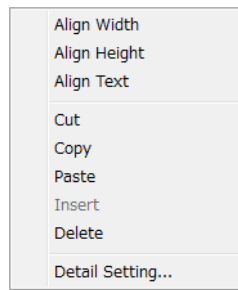

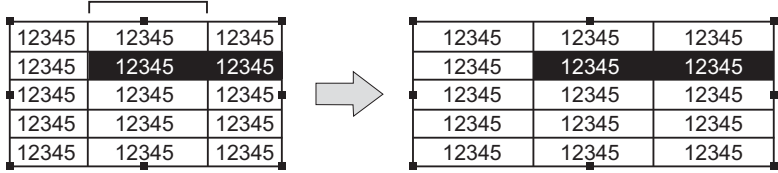
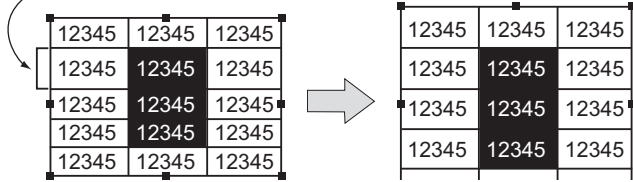
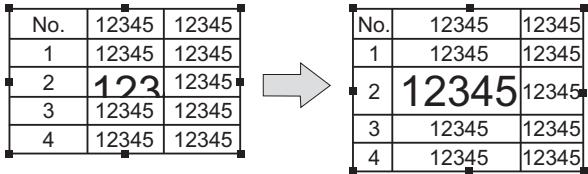
Item	Description
Align Width	<p>Adjust the width of all cells to the width of the top left cell among any selected cells.</p> <p>This width is applied to all cells.</p> 
Align Height	<p>Adjust the height of all cells to the height of the top left cell among any selected cells.</p> <p>This height is applied to all cells.</p> 
Align Text	<p>Adjust the cells in the table so that the largest data item fits into the cells.</p> 

Item	Description
Cut	This command is used for editing rows or columns.
Copy	Copy the selected items. [Paste] becomes active after this command is clicked.
Paste	When multiple columns or rows are pasted, the cell designated as the target is placed at the top of the pasted data. A data area larger than the table cannot be pasted.
Insert	This command is used for editing rows or columns. When rows are cut or copied (selected rows are highlighted), they are inserted above the specified row. When columns are cut or copied, they are inserted on the left of the specified column.
Delete	Delete any selected items on a row-by-row or column-by-column basis.
Detailed Setting	Display the item settings window for the data display.

 The [Cut], [Insert], and [Delete] commands are used for editing rows and columns.
E.g.: Insert

Copy

	No.1	No.2
1	12345	12345
2	12345	12345
3	12345	12345
4	12345	12345

Specify the destination for insertion.

	No.1	No.2
1	12345	12345
2	12345	12345
3	12345	12345
4	12345	12345

Insertion complete

	No.1	No.2	No.2
1	12345	12345	12345
2	12345	12345	12345
3	12345	12345	12345
4	12345	12345	12345

3.4.4 Entry

Placement procedure

1. Click [Parts] → [Entry] → [Keypad] or [Keyboard] (or drag a keypad from the [Catalog] view window).
Moving the mouse to the editing tab window moves the part together with the mouse cursor.
2. Click the left mouse button at an arbitrary position on the screen. This places the entry item on the screen.



* The part displayed here is the default or the one which was changed or selected last.

Setting method

Double-click the placed keypad to display the [Entry] item settings window.

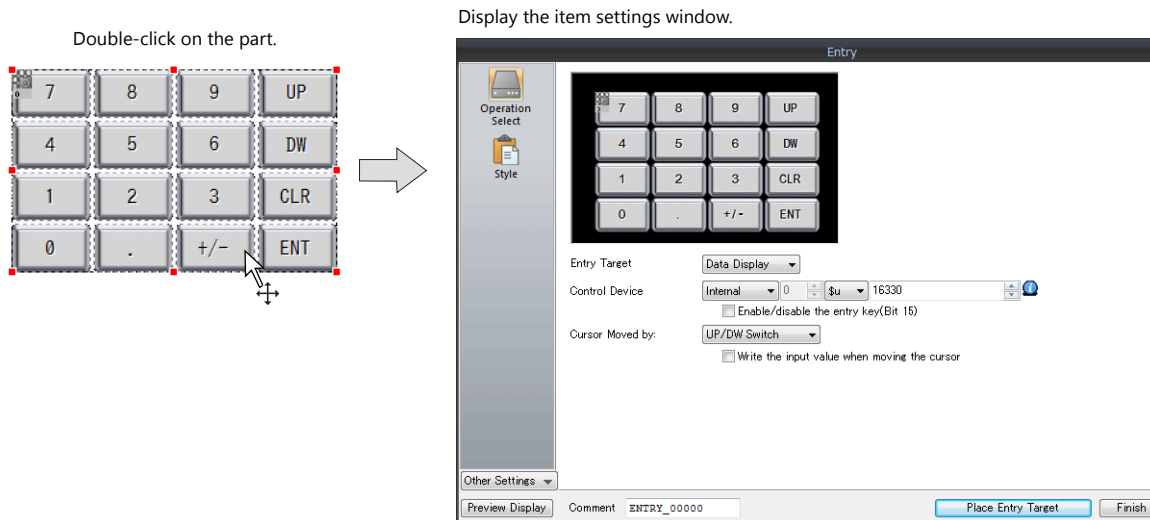

If you want to select the design of the keypad before placing it on the screen, it is recommended to use the [Catalog] view window as the method of placement.
For more information, refer to the next section.

Placing from the [Catalog] view window

1. Click [Parts] → [Catalog].
The [Catalog] view window is displayed.

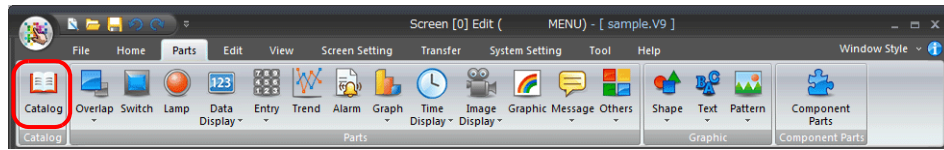

2. Select [Keypad] for [Parts].

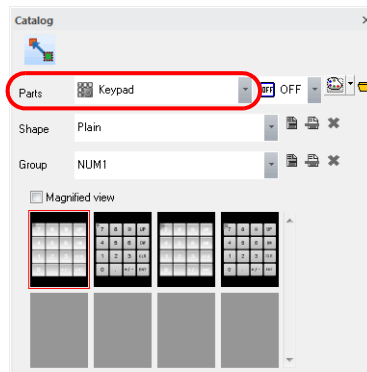

3. Change the [Shape] and [Group] settings and find the desired part in the part list.

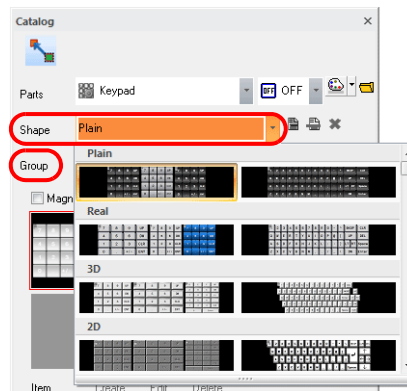

4. Select the desired keypad and drag it onto the screen.
This places the entry part on the screen.

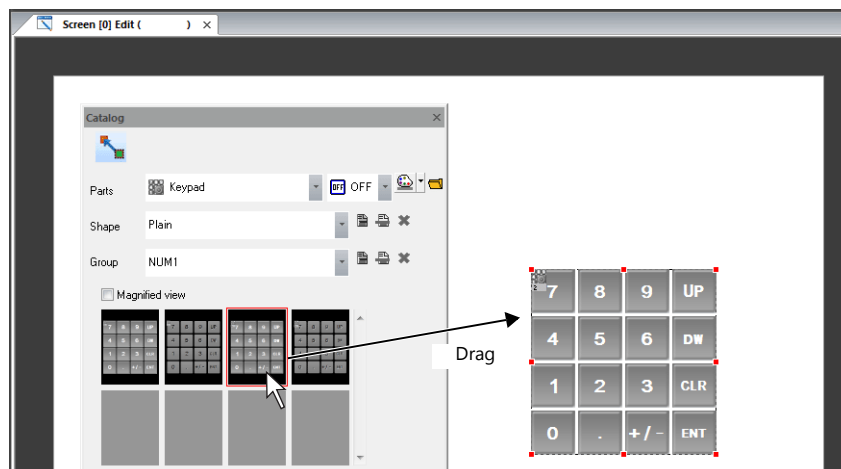

3.4.5 Trend

Placement procedure

1. Click [Parts] → [Trend] (or drag an item from the [Catalog] view window).
Moving the mouse to the editing tab window moves the part together with the mouse cursor.
2. Click the left mouse button at an arbitrary position on the screen. This places the trend part on the screen.

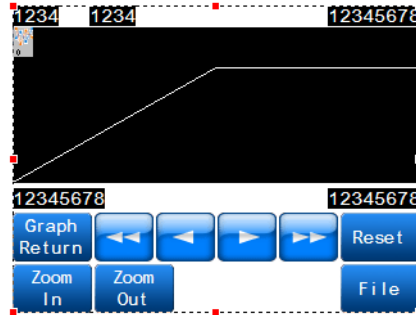

* The part displayed here is the default or the one which was changed or selected last.

Setting method

Double-click the placed trend part to display the item settings window.

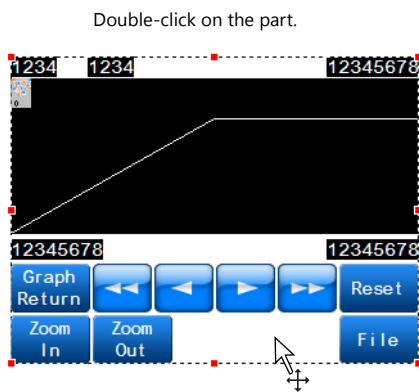

Display the item settings window.

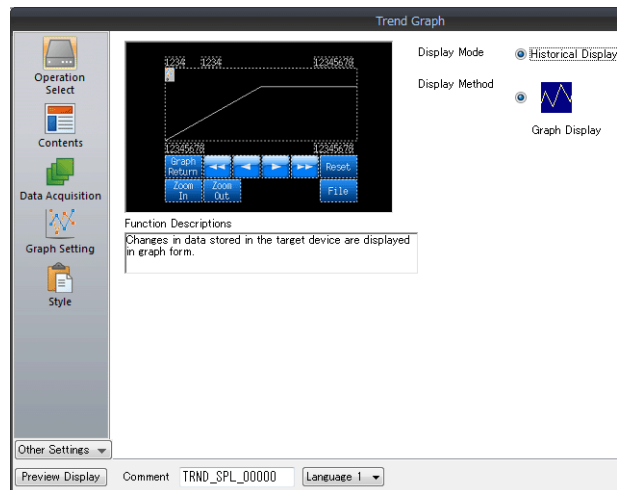

3.4.6 Alarm

Placement procedure

1. Click [Parts] → [Alarm] (or drag an item from the [Catalog] view window).
Moving the mouse to the editing tab window moves the part together with the mouse cursor.
2. Click the left mouse button at an arbitrary position on the screen. This places the alarm part on the screen.



* The part displayed here is the default or the one which was changed or selected last.

Setting method

Double-click the placed alarm part to display the item settings window.

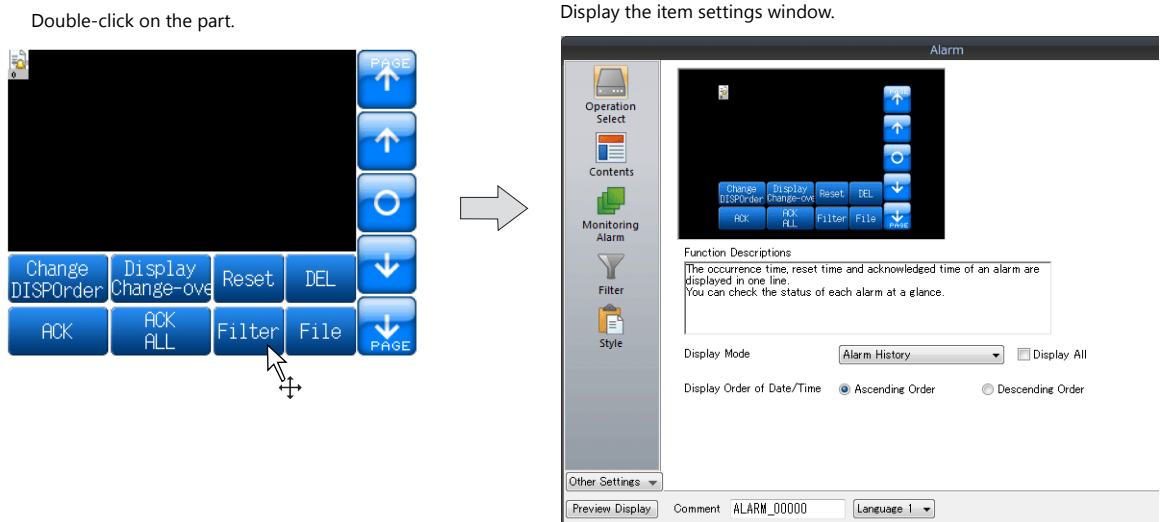

3.4.7 Graph

Placement procedure

1. Click [Parts] → [Graph] and select the desired item (or drag an item from the [Catalog] view window).
Moving the mouse to the editing tab window moves the part together with the mouse cursor.

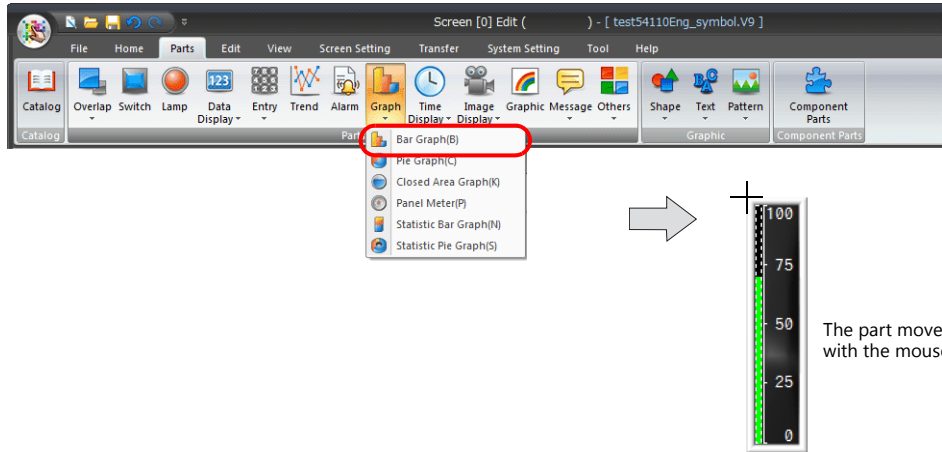

The part moves together with the mouse cursor.

* The part displayed here is the default or the one which was changed or selected last.

2. Click the left mouse button at an arbitrary position on the screen. This places the graph part.

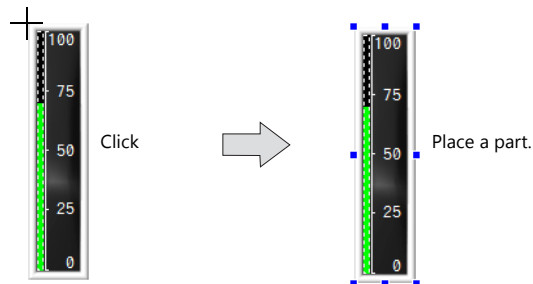

Setting method

Double-click the placed graph part to display the item settings window.

The item settings window is displayed ([Bar Graph] in this example).

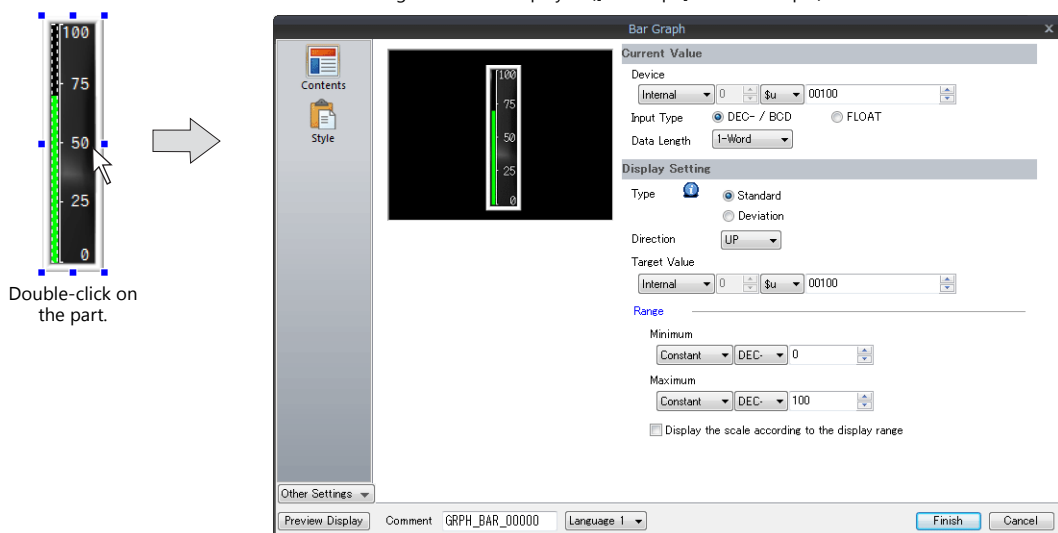

3.4.8 Time Display/Calendar

Placement procedure

1. Click [Parts] → [Time Display] and select [Time Display] or [Calendar] (or drag an item from the [Catalog] view window).
Moving the mouse to the editing tab window moves the part together with the mouse cursor.

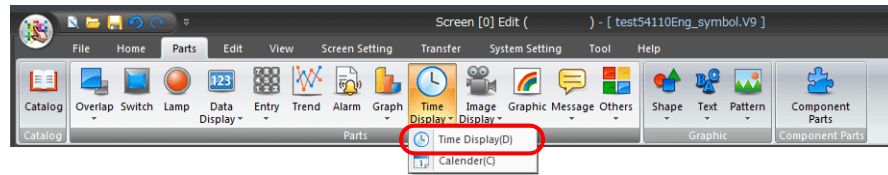

The part moves together with the mouse cursor.

YY/MM/DD hh:mm:ss

- * The part displayed here is the default or the one which was changed or selected last.

2. Click the left mouse button at an arbitrary position on the screen. This places the part on the screen.

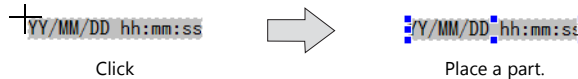

Setting method

Double-click the placed part to display the item settings window.

The item settings window is displayed ([Time Display] in this example).

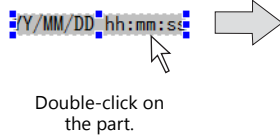

Double-click on the part.

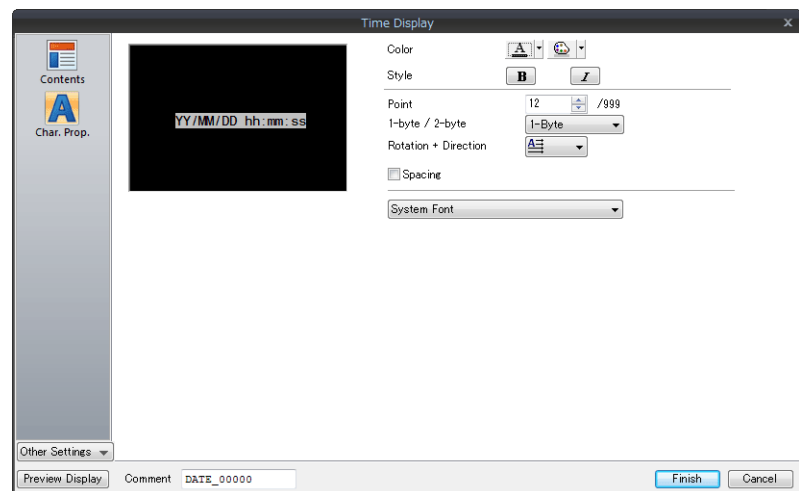

3.4.9 Video/RGB Display, JPEG Display, Network Camera Display, and Remote Desktop Display

Placement procedure

1. Click [Parts] → [Image Display] and select the desired part (or drag an item from the [Catalog] view window).
Moving the mouse to the editing tab window moves the part together with the mouse cursor.
* **The part displayed here is the default or the one which was changed or selected last.**
2. Click the left mouse button at an arbitrary position on the screen. This places the selected part on the screen.

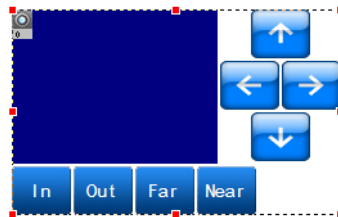

Setting method

Double-click the placed part to display the item settings window.

Double-click on the part.

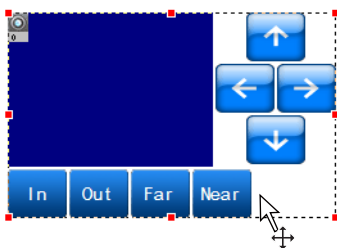

The item settings window is displayed ([Network Camera Display] in this example).

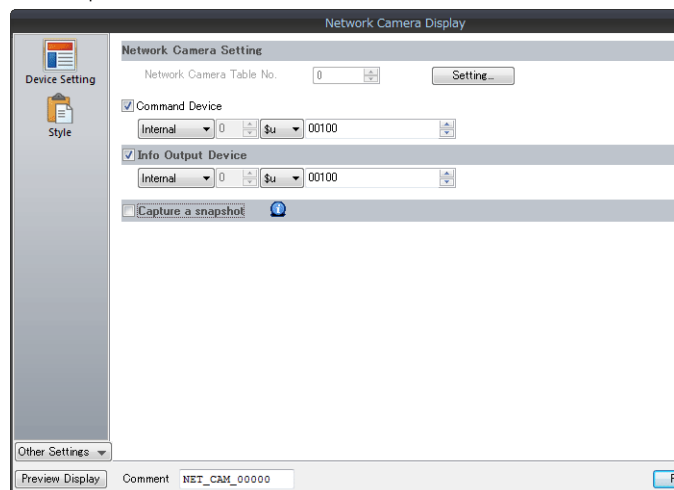

3.4.10 Graphic

Placement procedure

1. Click [Parts] → [Graphic] (or drag an item from the [Catalog] view window).
Moving the mouse to the editing tab window moves the part together with the mouse cursor.
* **The part displayed here is the default or the one which was changed or selected last.**
2. Click the left mouse button at an arbitrary position on the screen. This places the graphic part on the screen.

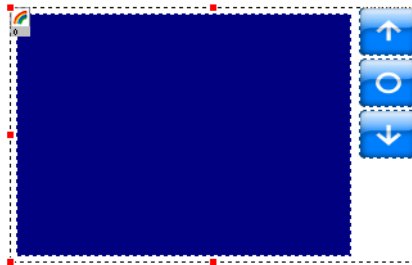

Setting method

Double-click the placed graphic part to display the item settings window.

Double-click on the part.

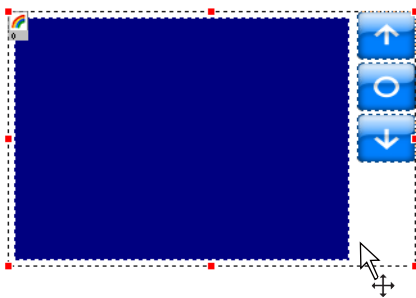

Display the item settings window.

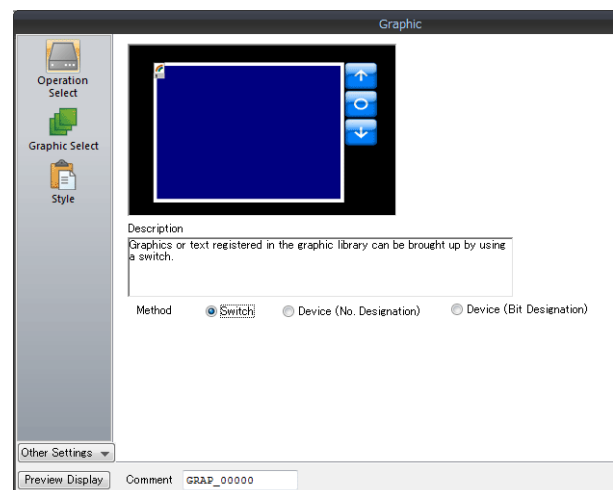

3.4.11 Message and Comment Displays

Placement procedure

- Click [Parts] → [Message] → [Message] or [Comment] (or drag an item from the [Catalog] view window).
Moving the mouse to the editing tab window moves the part together with the mouse cursor.
* **The part displayed here is the default or the one which was changed or selected last.**
- Click the left mouse button at an arbitrary position on the screen. This places the message display or comment display part on the screen.

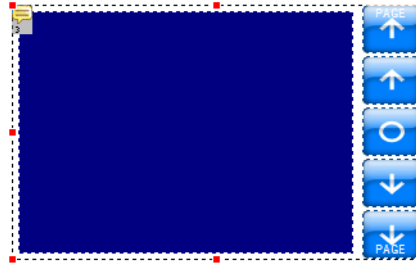

Setting method

Double-click the placed part to display the item settings window.

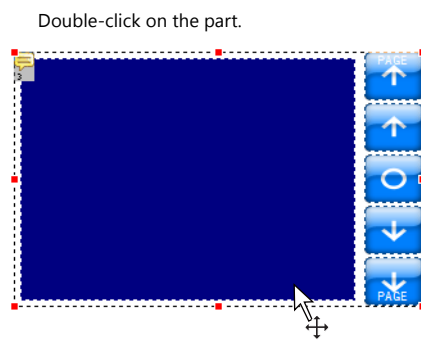

The item settings window is displayed ([Message] in this example).

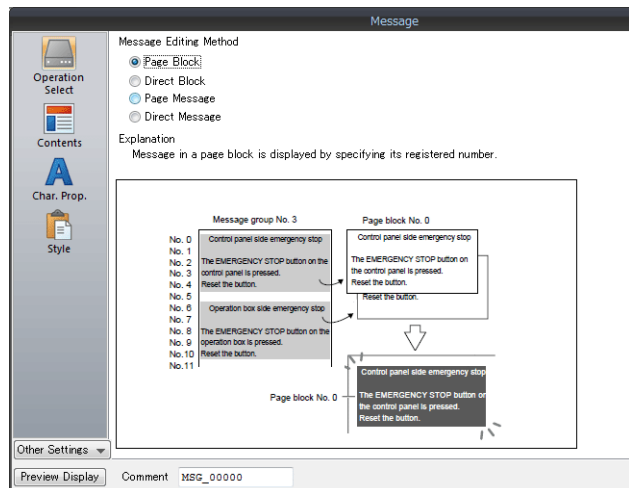

3.4.12 Recipe, Slider Switch, Data Block Area, Memory Card, and Memo Pad

Placement procedure

- Click [Parts] → [Other] and select the desired item (or drag an item from the [Catalog] view window).
Moving the mouse to the editing tab window moves the part together with the mouse cursor.
* **The part displayed here is the default or the one which was changed or selected last.**
- Click the left mouse button at an arbitrary position on the screen. This places the selected part on the screen.

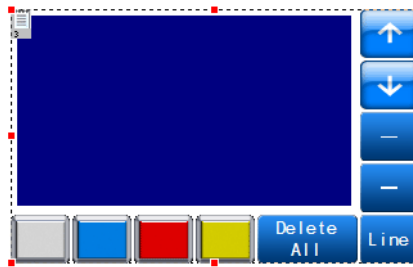

Setting method

Double-click the placed part to display the item settings window.

Double-click on the part.

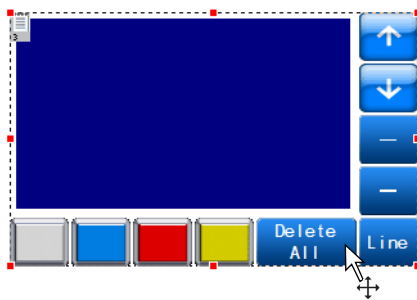

The item settings window is displayed ([Memo Pad] in this example).

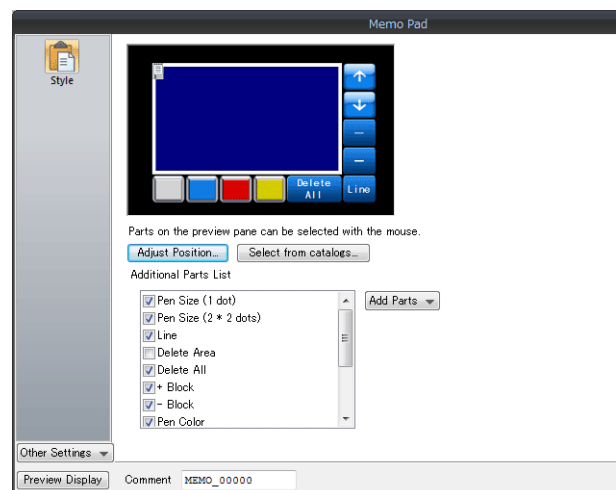

3.5 Registering Function Items

Function items comprise the four functions of sound, animation, macro, and interval timer. These items require registration to the screen on which they are to be used.

3.5.1 Sound

Registration Procedure

Registering from the [Screen Setting] menu

1. Click [Screen Setting] → [Sound] to display the item settings window.

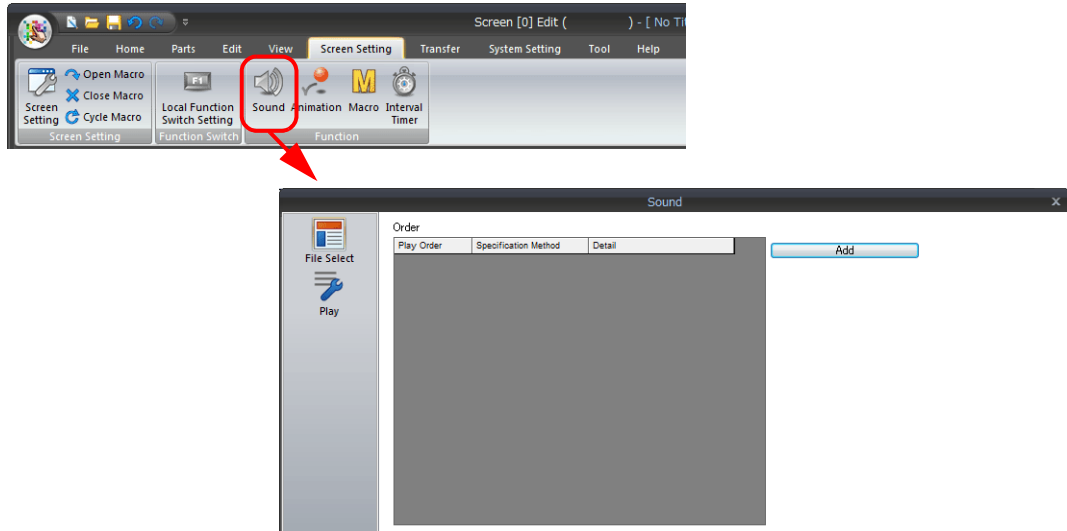

2. After configuring the required settings, click [Finish] to add the item to the [Function Item] view window.

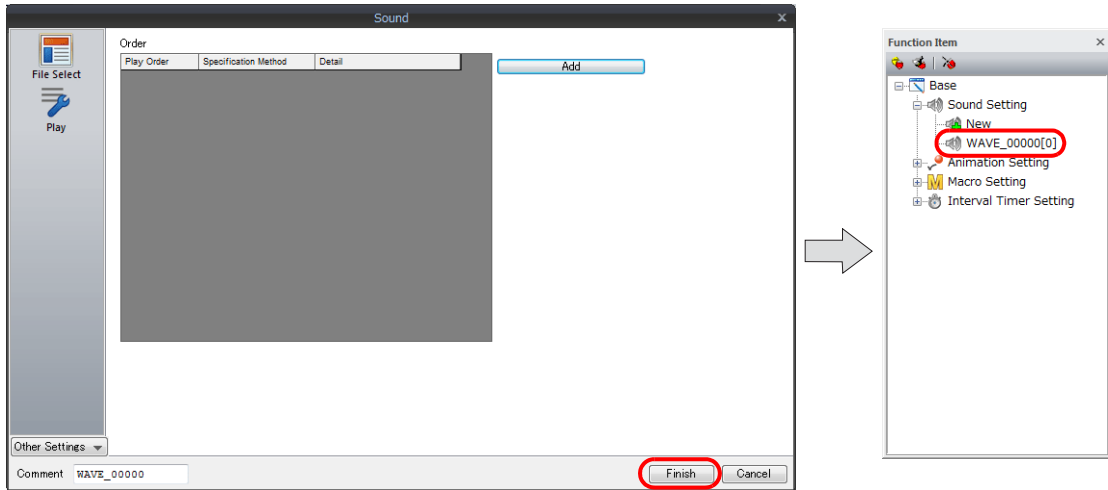

Registering from the [Function Item] view window

1. Click [View] → [Function Item] to display the [Function Item] view window.

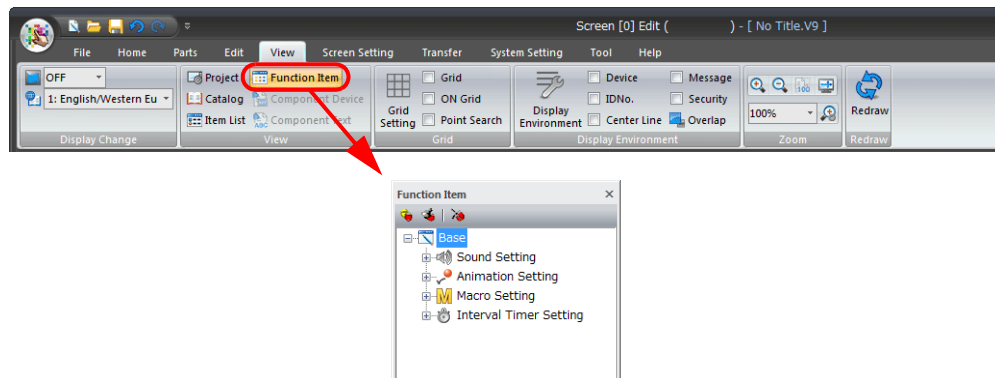

2. Click the [+] mark next to [Sound Setting] in the [Function Item] view window and double-click [New]. The item settings window is displayed.

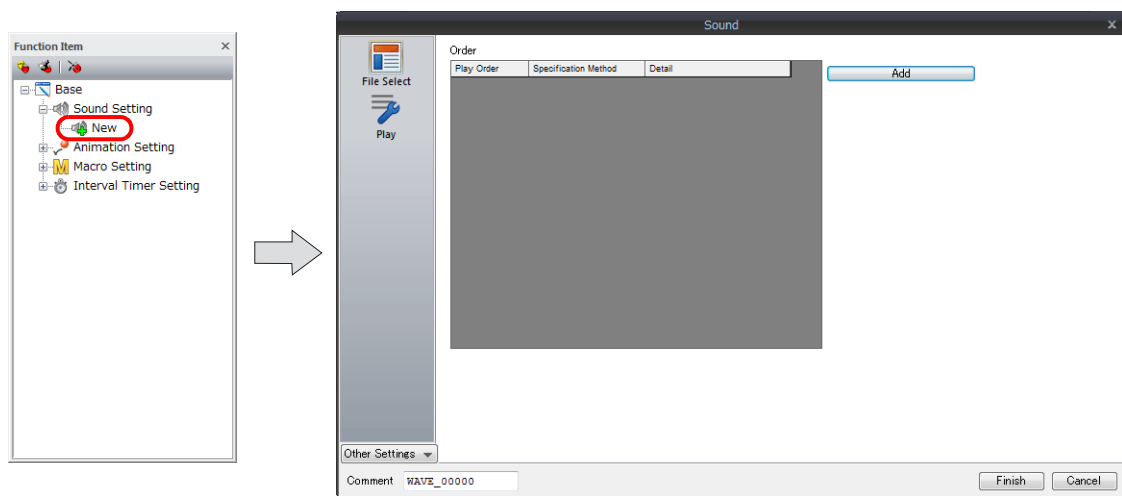

3. After configuring the required settings, click [Finish] to add the item to the [Function Item] view window.

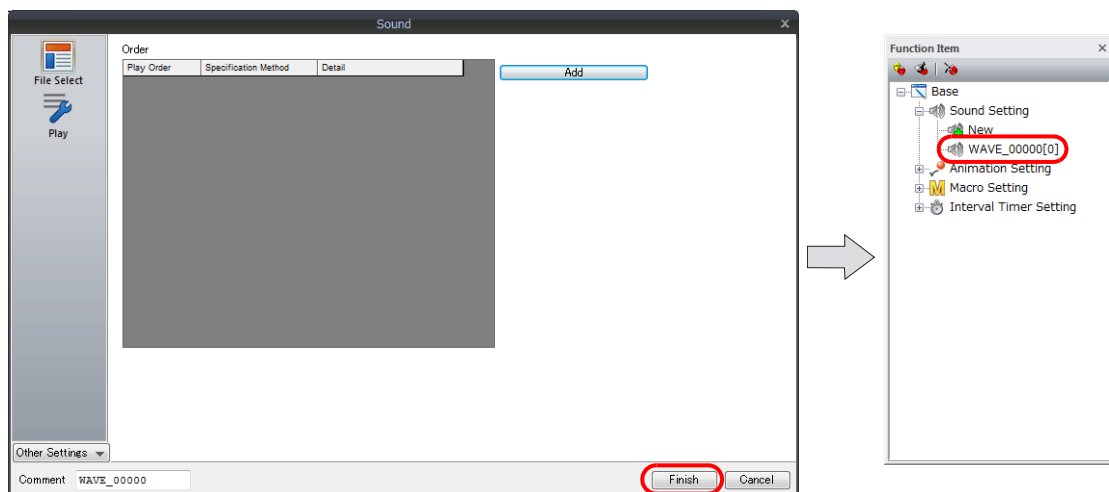

3.5.2 Animation

Registration Procedure

Registering from the [Screen Setting] menu

1. Click [Screen Setting] → [Animation] to display the item settings window.

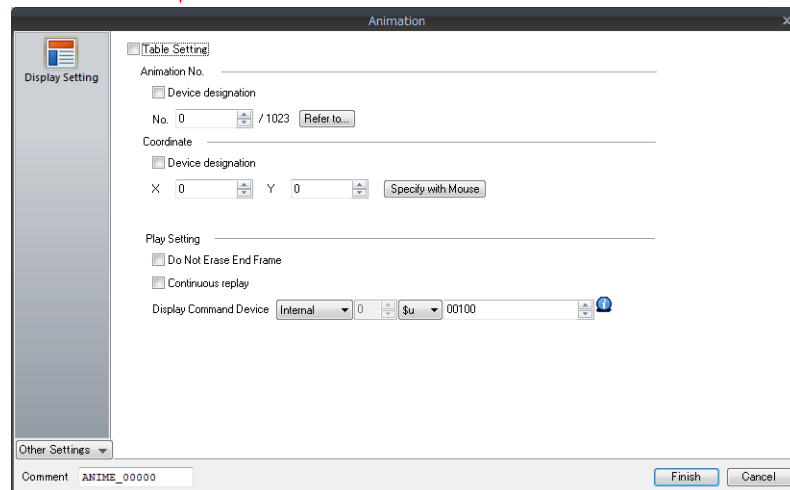
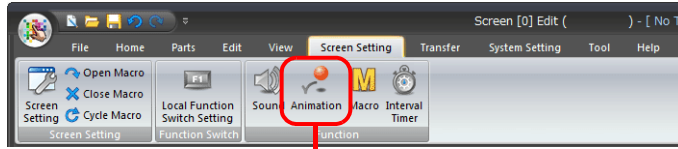

2. After configuring the required settings, click [Finish] to add the item to the [Function Item] view window.

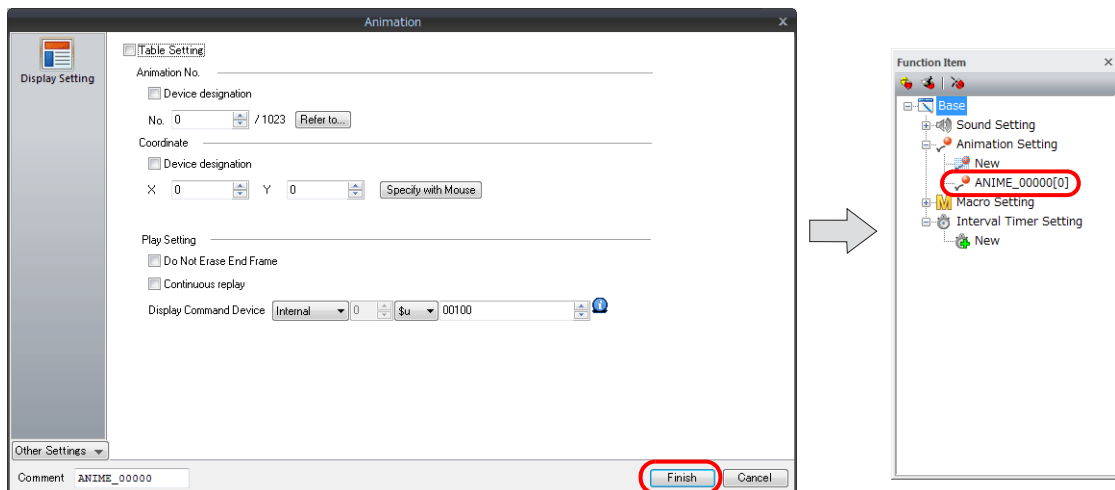

Registering from the [Function Item] view window

1. Click [View] → [Function Item] to display the [Function Item] view window.

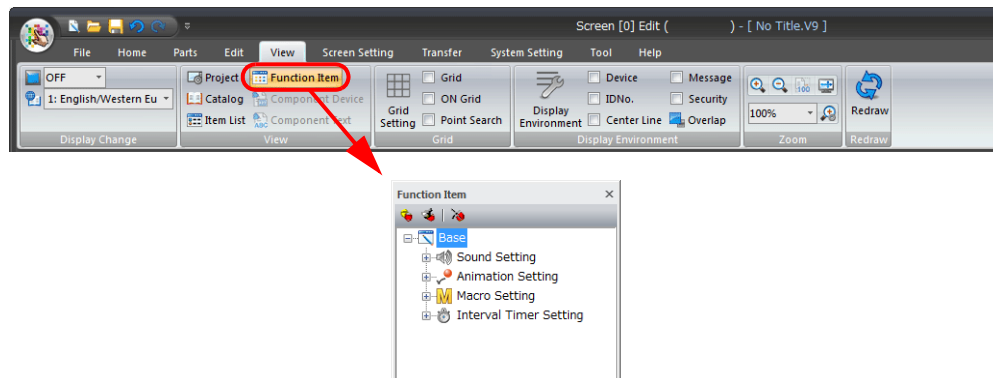

2. Click the [+] mark next to [Animation Setting] in the [Function Item] view window and double-click [New]. The item settings window is displayed.

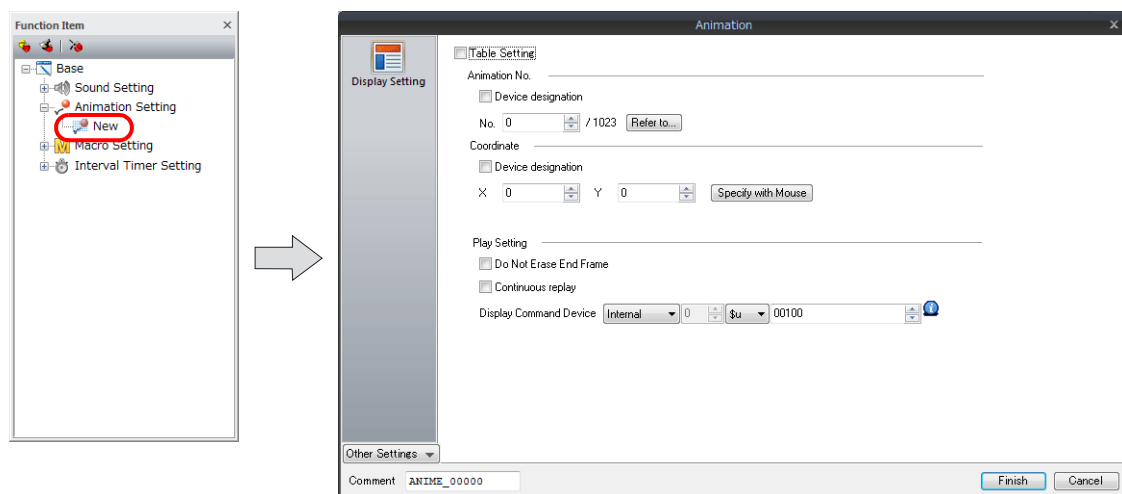

3. After configuring the required settings, click [Finish] to add the item to the [Function Item] view window.

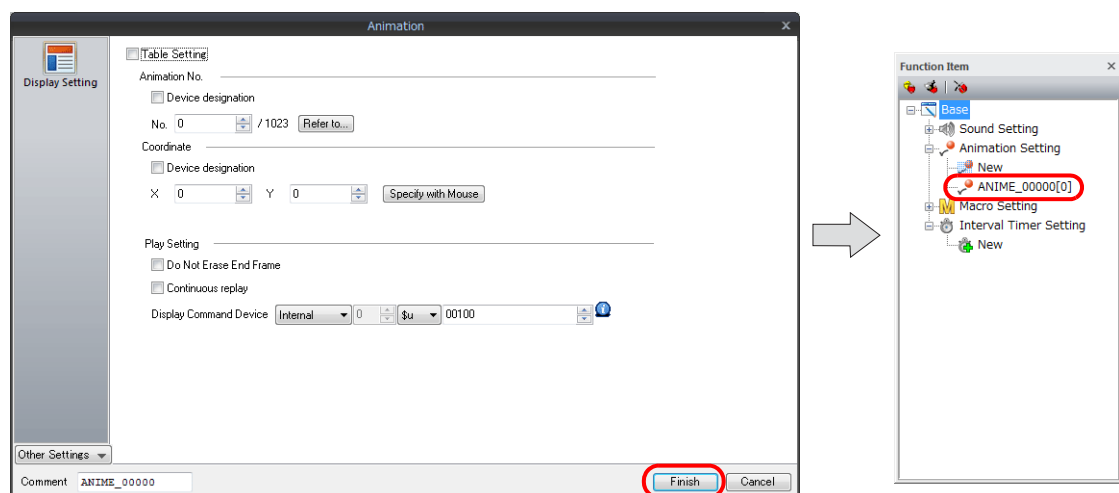

3.5.3 Macro

Registration Procedure

Registering from the [Screen Setting] menu

1. Click [Screen Setting] → [Macro] to display the item settings window.

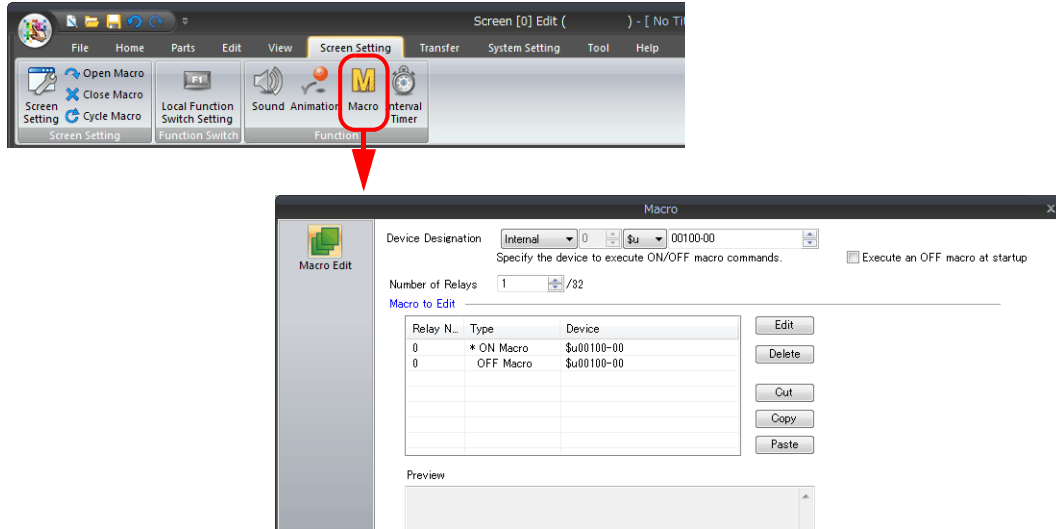

2. After configuring the required settings, click [Finish] to add the item to the [Function Item] view window.

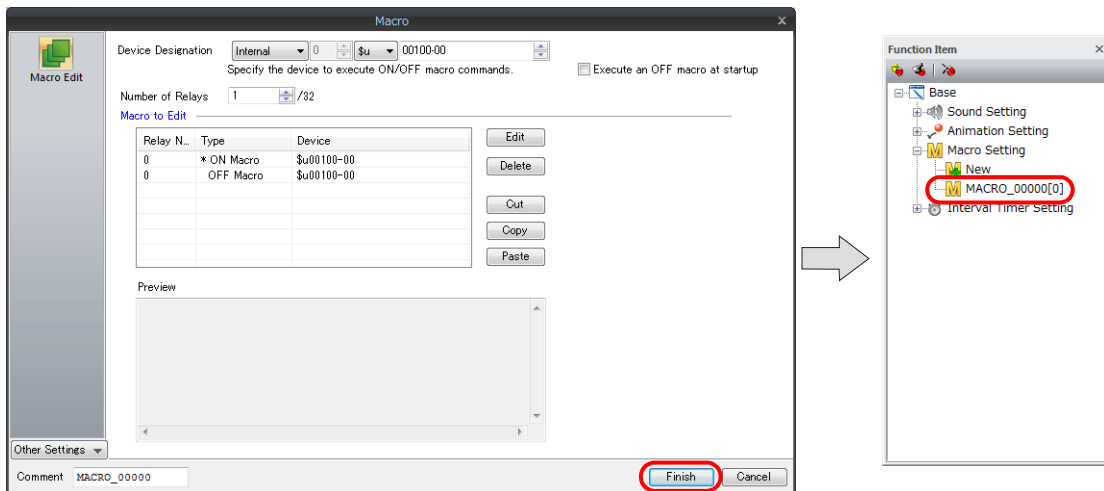

Registering from the [Function Item] view window

1. Click [View] → [Function Item] to display the [Function Item] view window.

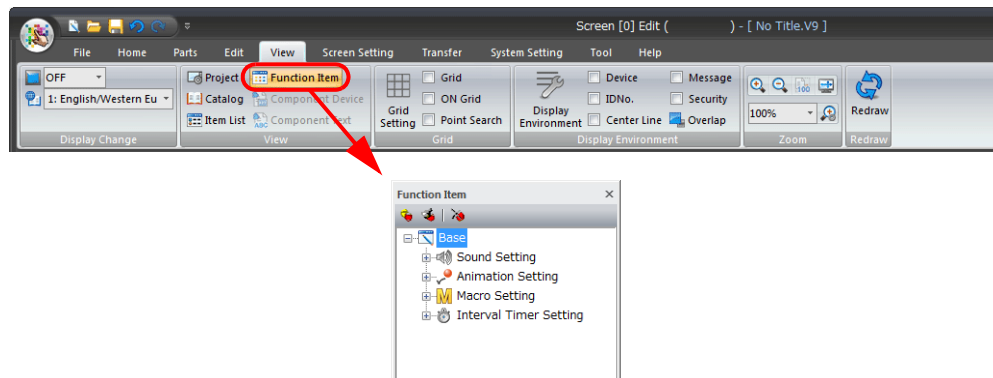

2. Click the [+] mark next to [Macro Setting] in the [Function Item] view window and double-click [New]. The item settings window is displayed.

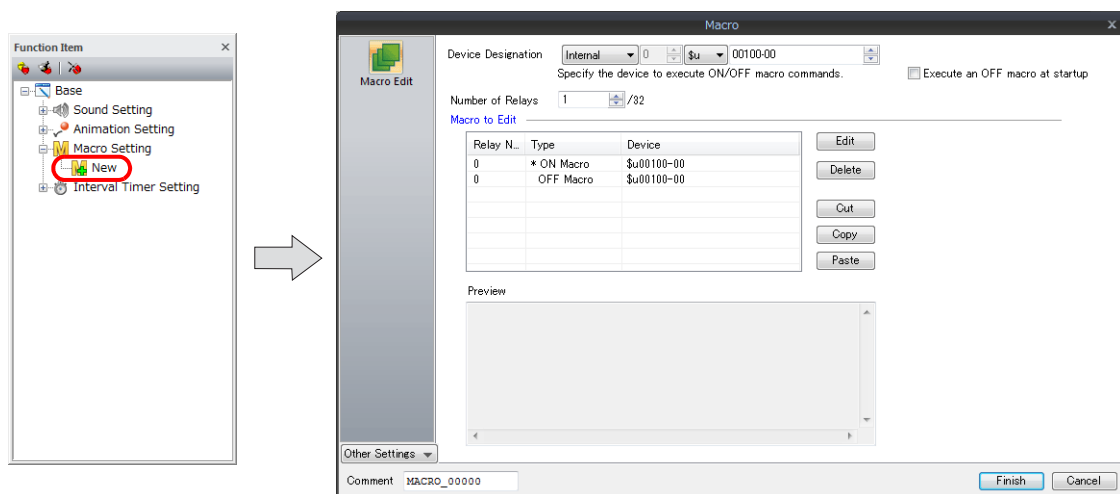

3. After configuring the required settings, click [Finish] to add the item to the [Function Item] view window.

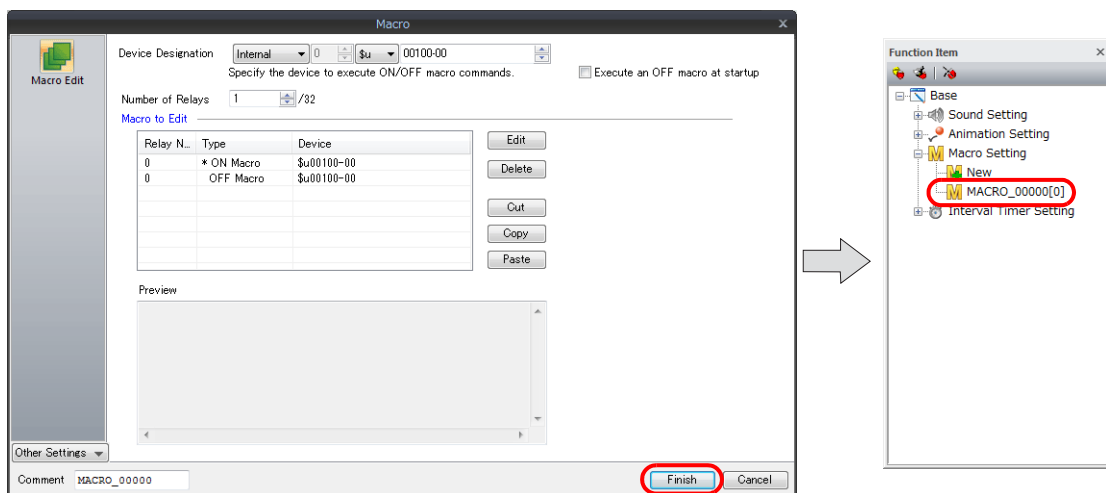

3.5.4 Interval Timer

Registration Procedure

Registering from the [Screen Setting] menu

1. Click [Screen Setting] → [Interval Timer] to display the item settings window.

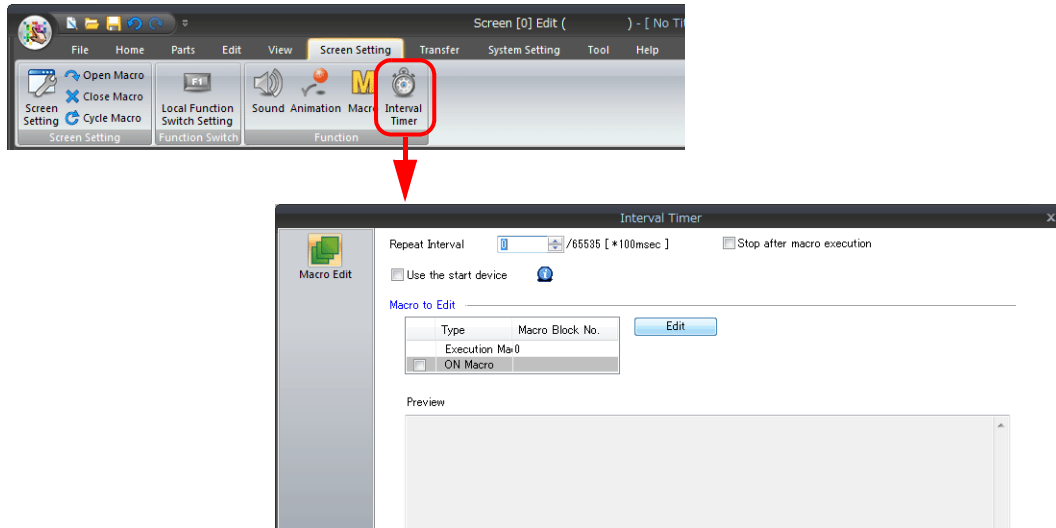

2. After configuring the required settings, click [Finish] to add the item to the [Function Item] view window.

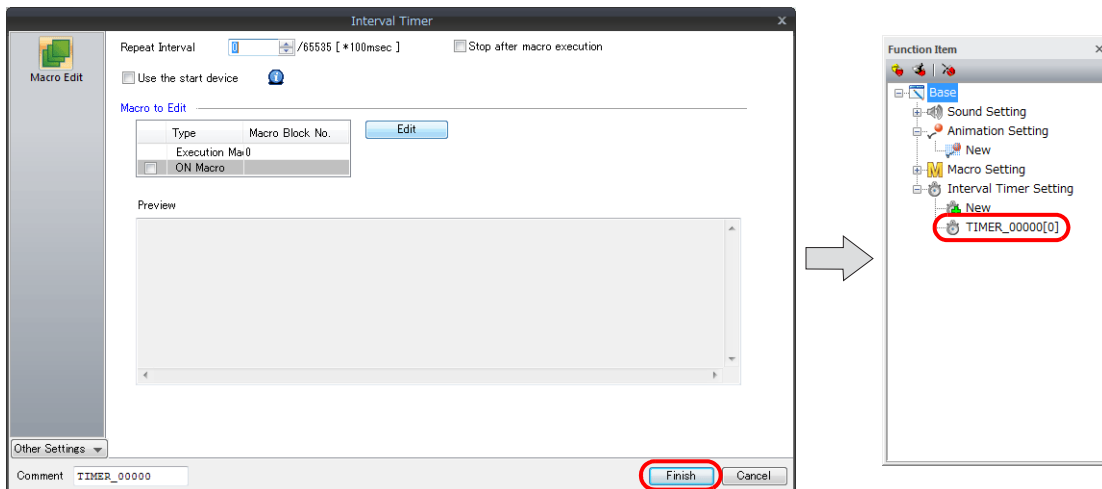

Registering from the [Function Item] view window

1. Click [View] → [Function Item] to display the [Function Item] view window.

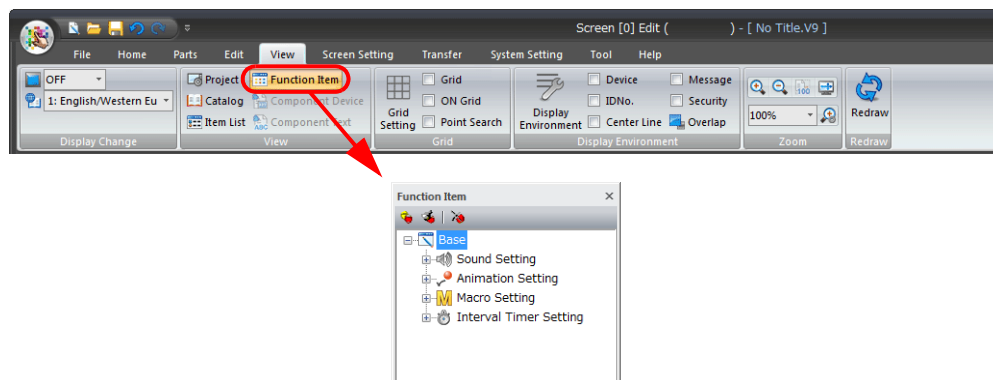

2. Click the [+] mark next to [Interval Timer Setting] in the [Function Item] view window and double-click [New]. The item settings window is displayed.

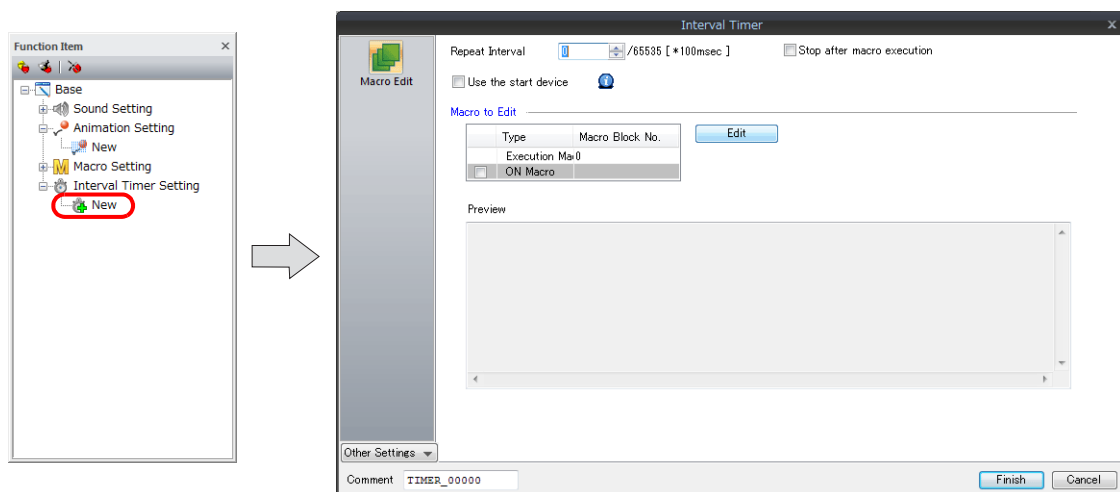

3. After configuring the required settings, click [Finish] to add the item to the [Function Item] view window.

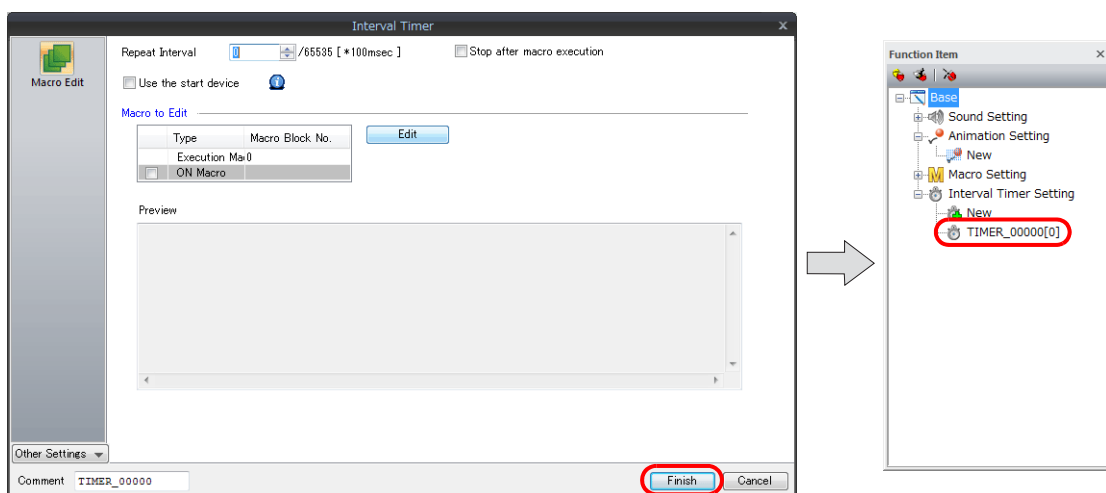

3.6 Shape and Text Graphics

3.6.1 Shape

Draw shapes such as lines and rectangles.

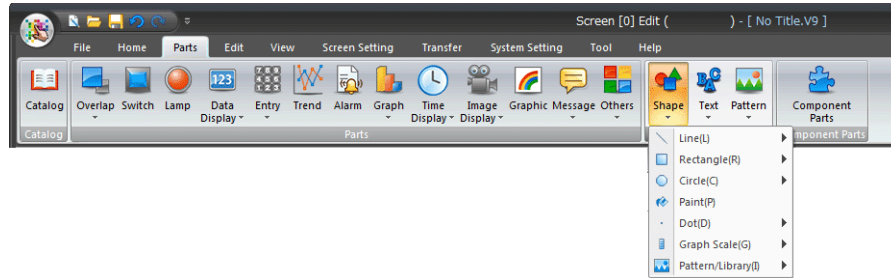

Line

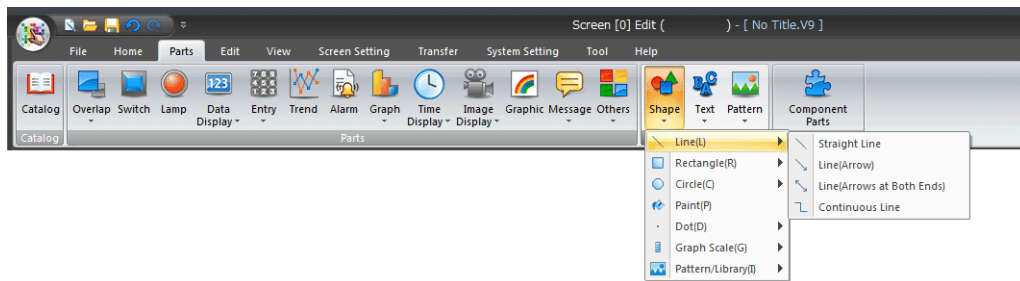

[Straight Line], [Line (Arrow)], and [Line (Arrows at Both Ends)]

1. Click [Parts] → [Shape] → [Line] and select the type of line to draw ([Straight Line], [Line (Arrow)], or [Line (Arrows at Both Ends)]).

The mouse cursor changes to a crosshair.

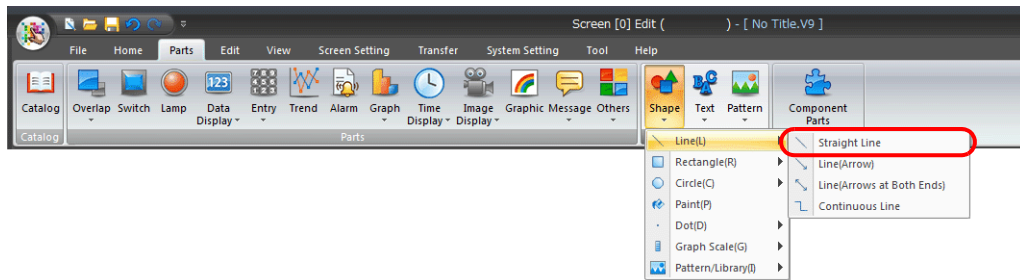

2. Drag from the start point to the end point on the screen to draw a line and display the item view window.



- Configure settings such as line color, line type, and arrow type (end processing) in the displayed item view window. Click ▼ next to each icon to display a list. Select a setting from each list.

• Color

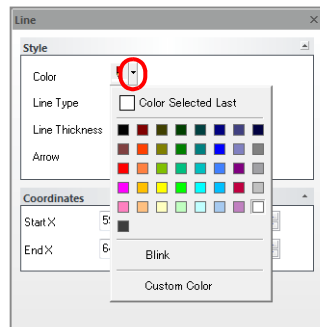

• Line type

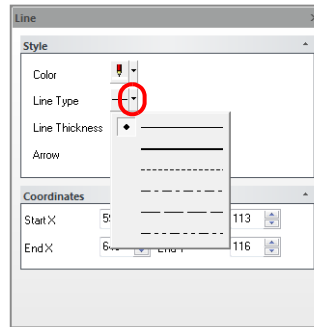

• Arrow

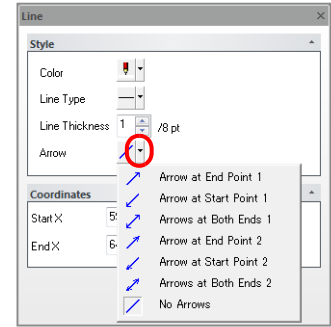

☹ Color, line type, and arrow (end processing) can also be set via [Edit] → [Style]. For more information, refer to "4.1.4 Style" page 4-9.

- To cancel the line drawing mode, right-click or click the left mouse button at any position on the screen. Additional lines can be drawn by dragging the mouse again without canceling the drawing mode.

☹ Drag the mouse while holding down the [Shift] key to facilitate drawing of horizontal and vertical lines.

[Continuous Line]

- Click [Parts] → [Shape] → [Line] and select [Continuous Line]. The mouse cursor changes to a crosshair.

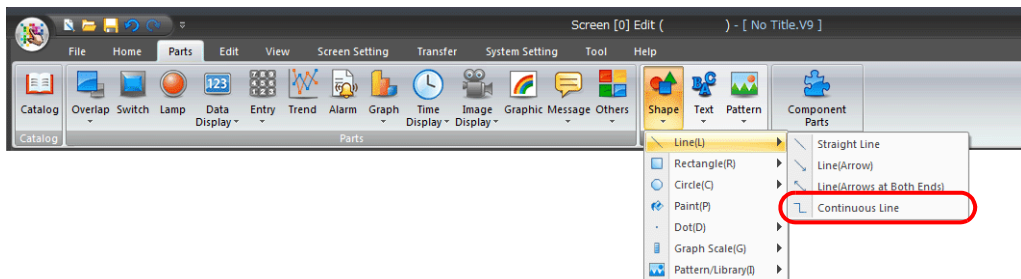

- Click the start point. Then click the first point. The first line is drawn.



- In the same manner, move the mouse to the second point and click.

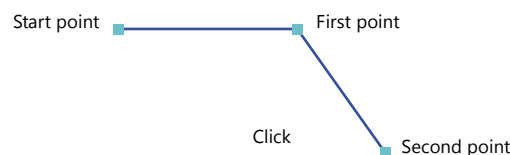

☹ To erase the drawn line, right-click the mouse.

- At the end point, double-click the left mouse button.
This completes drawing of the continuous line and displays the item view window.

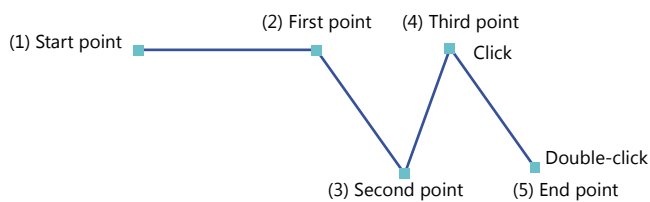

- Configure settings such as the color and type of the continuous line in the displayed item view window. Click ▼ next to each icon to display a list. Select a setting from each list. The coordinates of each point can also be specified under [Coordinates] in the item view window.

- Color

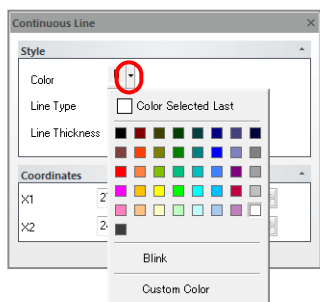

- Line type

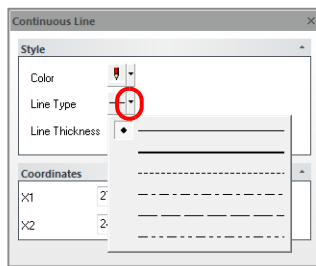

- Coordinates

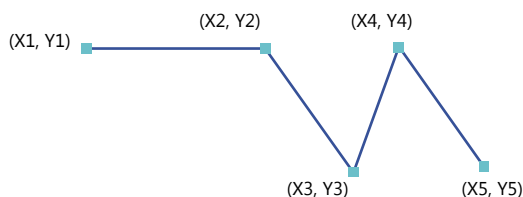
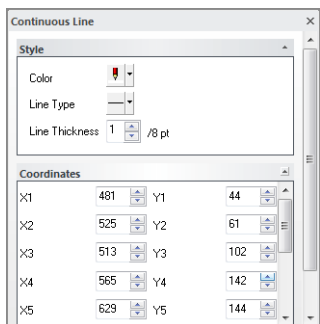



- Changing the color and line type**
 Color and line type can also be set via [Edit] → [Style]. For more information, refer to “4.1.4 Style” page 4-9.

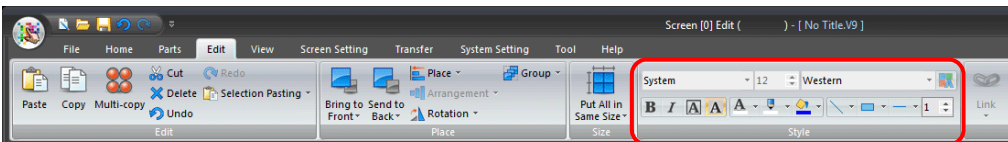

- [Vertex Edit]**
 Use the [Vertex Edit] command to change the position of individual points after drawing.
 Select the drawn continuous line and click [Edit] → [Vertex Edit] in the [Modify Parts] settings.
 A handle is displayed on each point of the continuous line.
 Drag on the handles to change their positions.

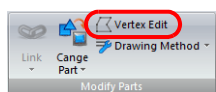

Drag this.

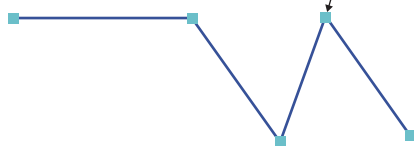

The points become movable.

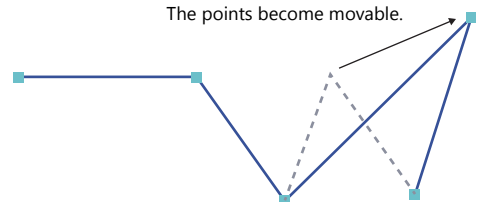

- To cancel the continuous line drawing mode, right-click or double-click the left mouse button. Additional continuous lines can be drawn by dragging the mouse again without canceling the drawing mode.

Rectangle

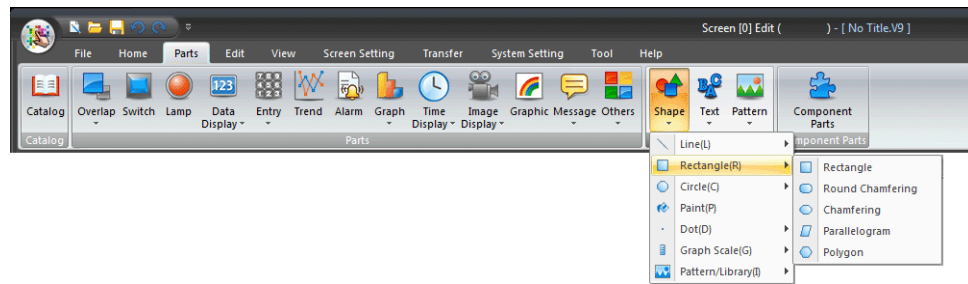

[Rectangle], [Round Chamfering], and [Chamfering]

1. Click [Parts] → [Shape] → [Rectangle] and select the type of rectangle to draw ([Rectangle], [Round Chamfering], or [Chamfering]).

The mouse cursor changes to a crosshair.

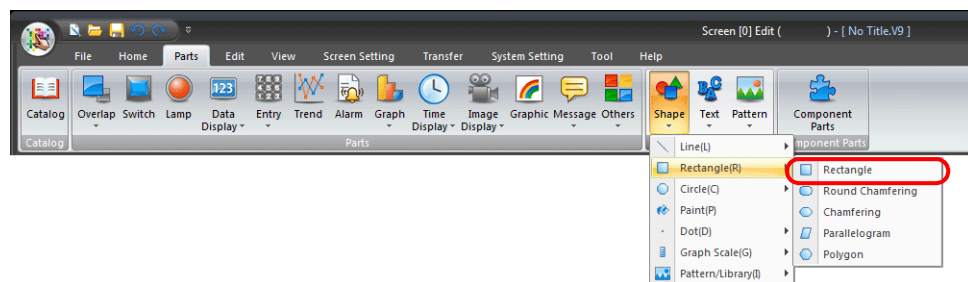

2. Drag from the start point to the end point on the screen using the mouse. This draws a rectangle and displays the item view window.

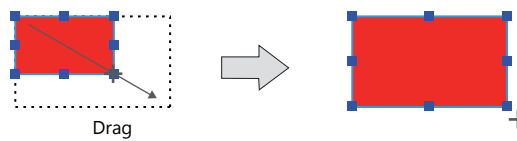

A rectangle can be drawn from any corner.
A square can be drawn by dragging the mouse while holding down the [Shift] key.

3. Set the style (corner type, frame, area color, frame color, and line type) of the rectangle in the item view window. Click ▼ next to each menu to display a list. Select a setting from each list.

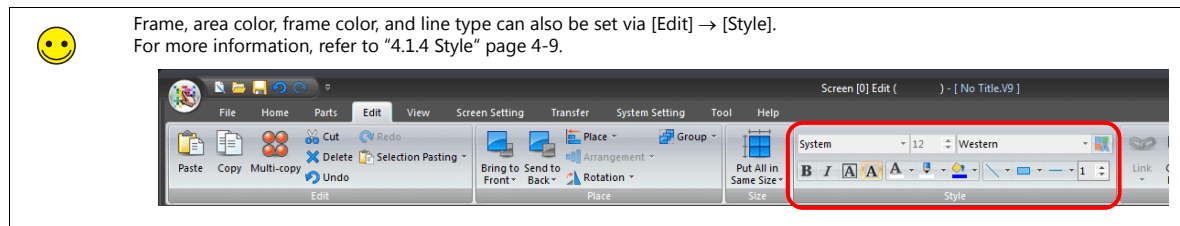
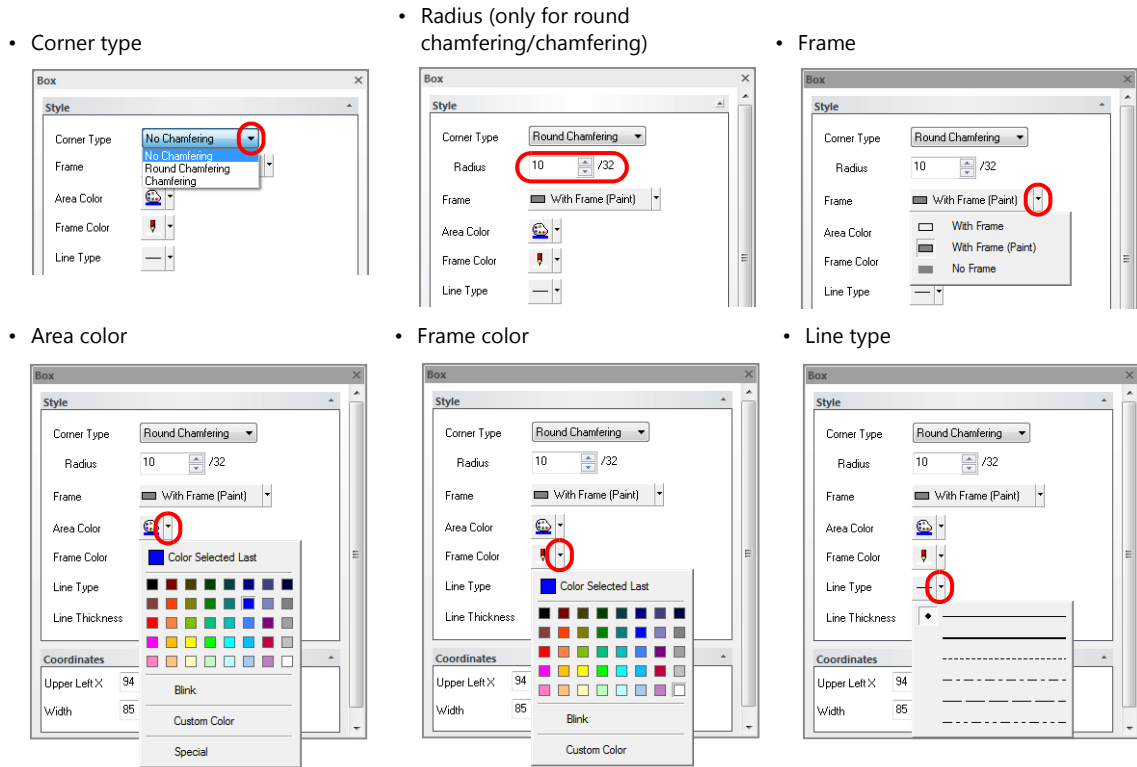

4. To cancel the rectangle drawing mode, right-click or click the left mouse button at any position on the screen. Additional rectangles can be drawn by dragging the mouse again without canceling the drawing mode.

Selecting a tile pattern

Tiling can be specified using [Area Color] when [With Frame (Paint)] or [No Frame] is selected. A maximum of 16 tiles can be used. Eight tiles are registered as default.

- Area color

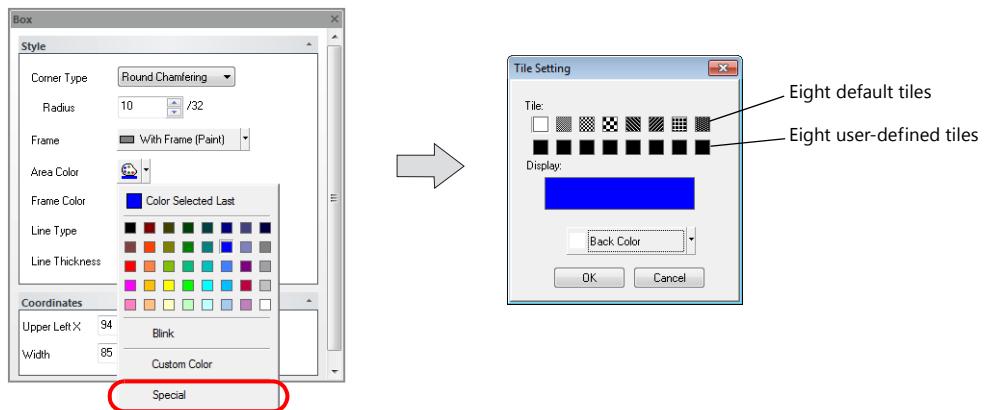

An additional eight tiles can be registered by the user. For the procedure of registering user-defined tiles, refer to “6.17 Tile” page 6-69.

When the leftmost tile is selected, the area is painted with the color set for [Area Color].
 When any other tile is selected, the area is painted in the colors set for [Area Color] and [Back Color].

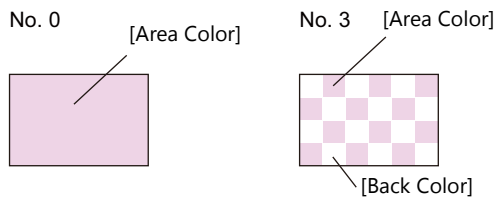

- Setting example
 Select the desired tile under [Tile] in the [Tile Setting] window.
 The tile is displayed with the current [Area Color] and [Back Color] settings.
 Change the background color by clicking [Back Color] to create the desired tile pattern.

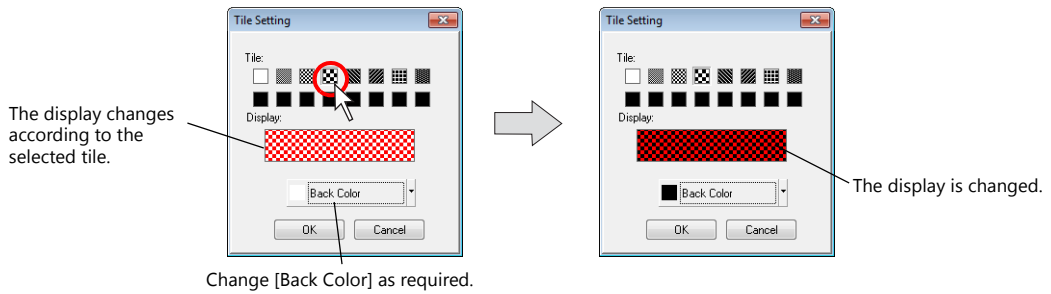

When the settings are complete, click [OK]. The [Area Color] setting is applied to the tile pattern.

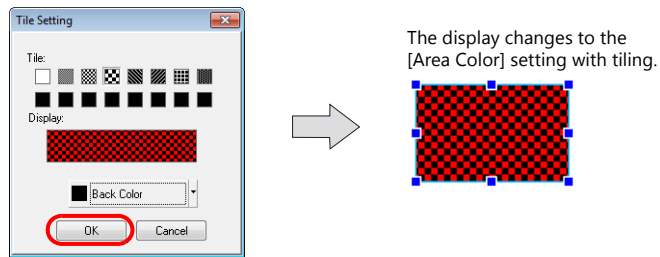

Notes on [Round Chamfering] and [Chamfering]

A chamfered rectangle is created by transforming the corners of a rectangle.

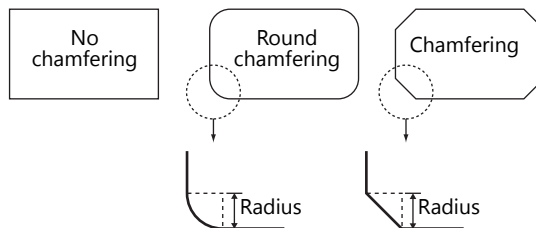

- When [Round Chamfering] and [With Frame (Paint)] are selected, XOR display cannot be used. For example, if [With Frame (Paint)] is specified when [Round Chamfering] is selected in a graphic function, it cannot be displayed on the V9 series unit. For more information on XOR display, refer to "11 Graphics and Animation" in the V9 Series Reference Manual 1.

Parallelogram

- Click [Parts] → [Shape] → [Rectangle] and select [Parallelogram].
The mouse cursor changes to a crosshair.

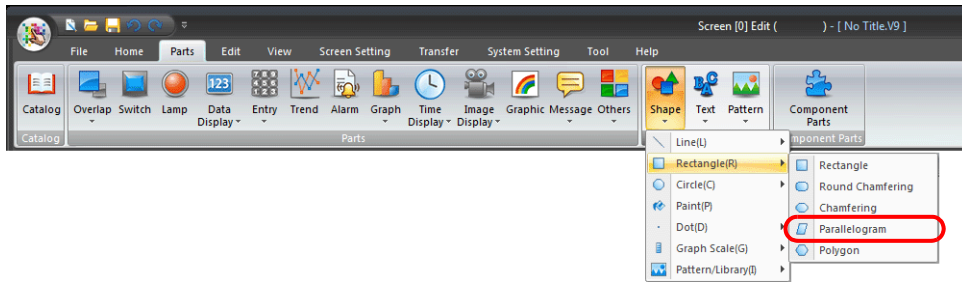

- Drag the mouse from the start point to the end point of the first edge.

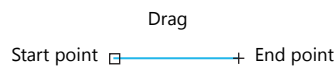

- Move the mouse from the end point of the first edge to the position of the parallel edge.

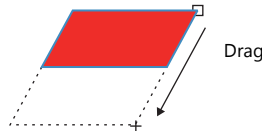

- Clicking the left mouse button draws a parallelogram and displays the item view window.



- Set the style (frame, area color, and frame color) of the parallelogram in the item view window.
Click ▼ next to each menu to display a list. Select a setting from each list.
The size can be changed using the point coordinates.

• Frame

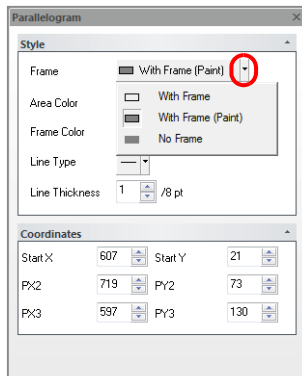

• Area color

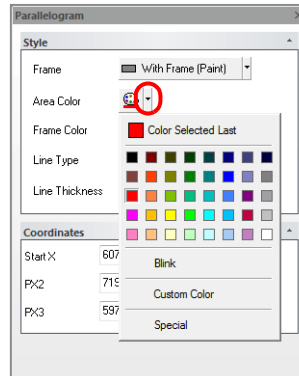

• Frame color

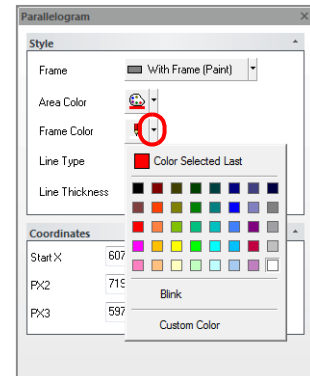

• Coordinates

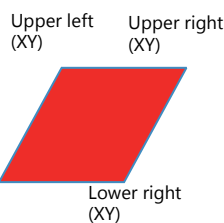
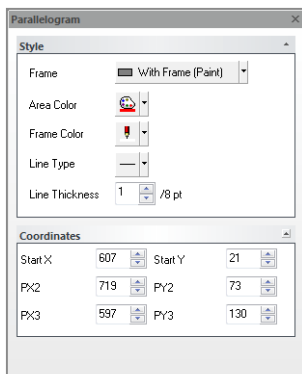

When the coordinates of a single point are changed, the coordinates of the other points are also changed to maintain the parallelogram shape.

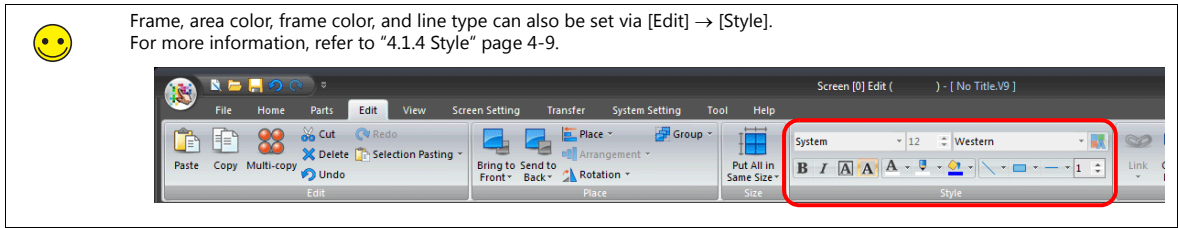

- To cancel the parallelogram drawing mode, right-click or click the left mouse button at any position on the screen. Additional parallelograms can be drawn by dragging the mouse again without canceling the drawing mode.

Polygon

- Select the drawing method.

Click [Edit] → [Modify Parts] → [Drawing Method] → [Polygon] to select the desired drawing method.

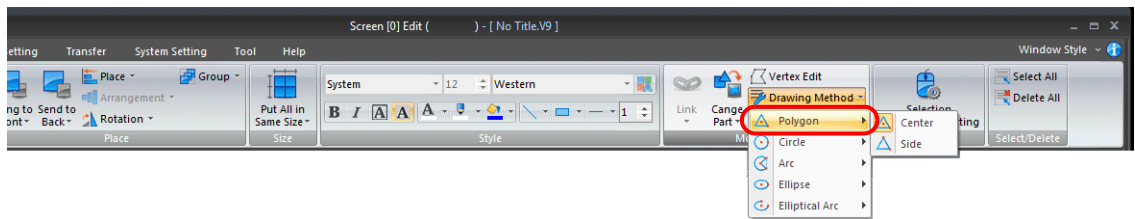

Center:
Drag from the center
to a corner.

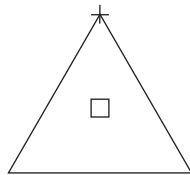

Side:
Drag from the start point to
the end point of one side.

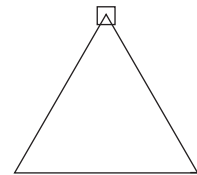

□: Start point
+ : End point

For this example, select [Center].

- Click [Parts] → [Shape] → [Rectangle] and select [Polygon].
The mouse cursor changes to a crosshair.

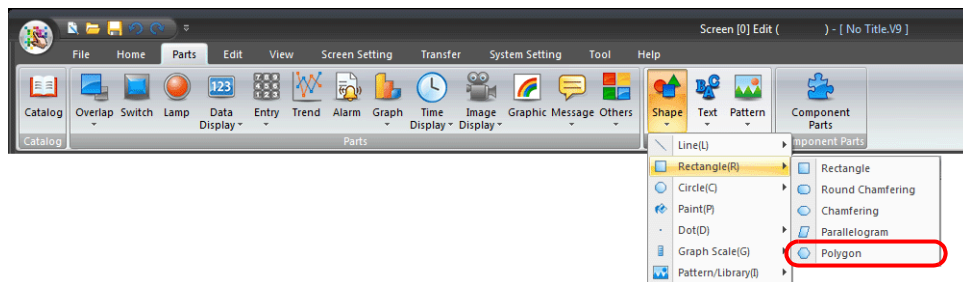

- Drag the mouse from the center to a corner to draw a polygon and display the item view window.

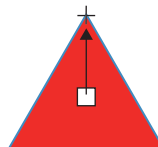

- Set the style (number of corners, frame, area color, and frame color) of the polygon in the item view window. Click ▼ next to each menu to display a list. Select a setting from each list. The placement position, size, and rotation angle can be changed using the point coordinates.

- Number of corners

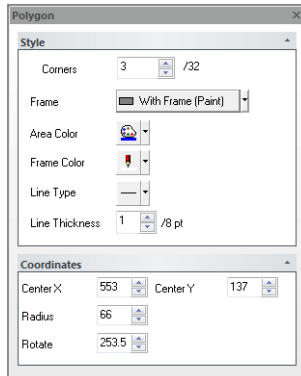

- Frame

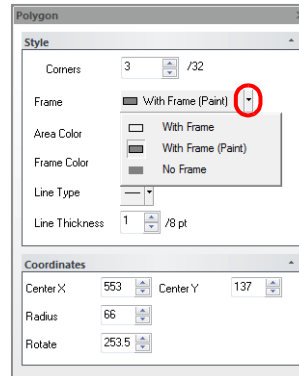

- Area color

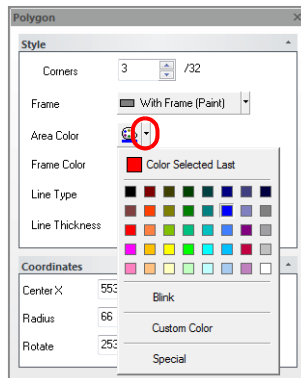

- Frame color

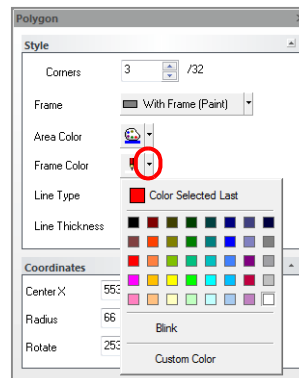

☹️ Frame, area color, and frame color can also be set via [Edit] → [Style]. For more information, refer to "4.1.4 Style" page 4-9.

- To cancel the polygon drawing mode, right-click or double-click the left mouse button. Additional polygons can be drawn by dragging the mouse again without canceling the drawing mode.

☹️

- [Vertex Edit]
 - Use the [Vertex Edit] command to change the angular position or radius of the polygon after drawing.
 - Click the drawn polygon to select it and then right-click and select [Vertex Edit].

Select and right-click.

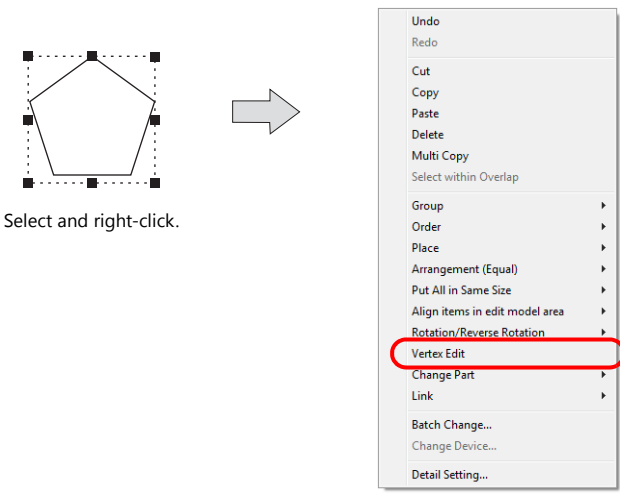

The right-click menu is displayed.

Handles are shown at the vertices of the polygon. Dragging each handle allows you to move the polygon or change the radius.

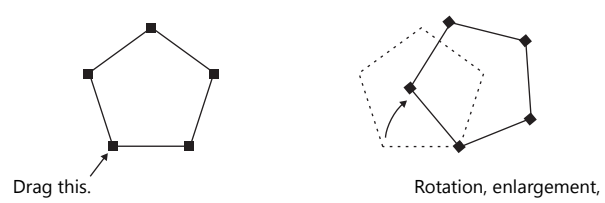

Drag this.

Rotation, enlargement,

Circle

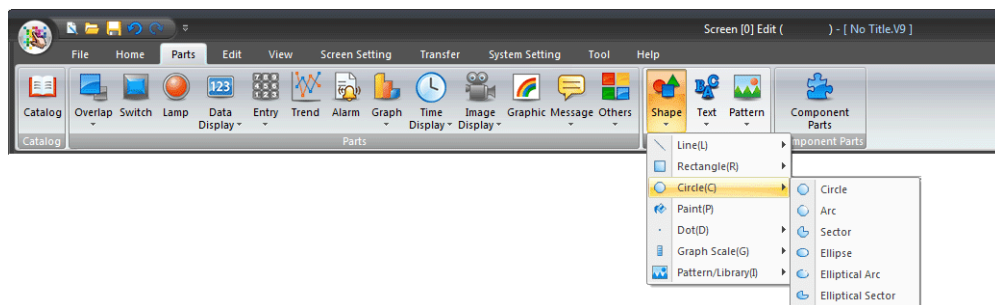

[Circle]

1. Select the drawing method.

Click [Edit] → [Modify Parts] → [Drawing Method] → [Circle] to select the desired drawing method.

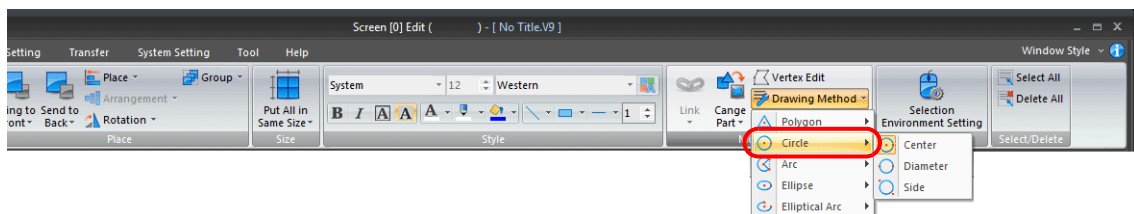

Center:
Drag from the center to specify the radius.

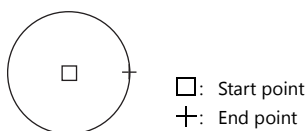

Diameter:
Drag from one side to the other to specify the diameter.

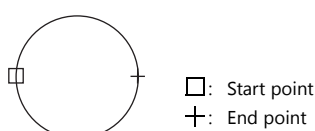

Side:
Drag from the start point to the end point of a box in which a circle is drawn.

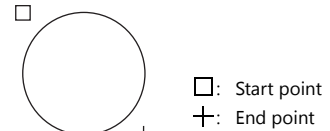

For this example, select [Center].

- Click [Parts] → [Shape] → [Circle] and select [Circle].
The mouse cursor changes to a crosshair.

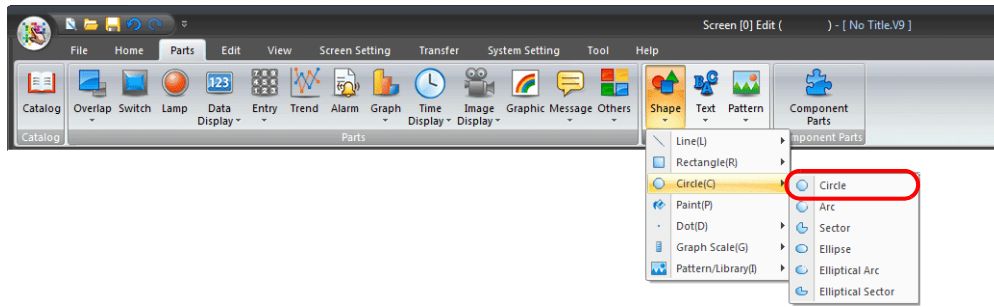

- Drag the mouse from the center to the desired radius size to draw a circle and display the item view window.

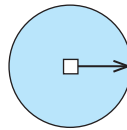

- Set the style (frame, area color, and frame color) of the circle in the item view window.
Click ▼ next to each menu to display a list. Select a setting from each list.
The placement position and size can be changed using the point coordinates.

- Frame

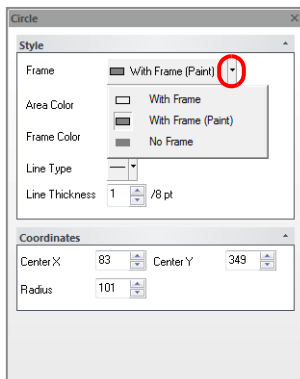

- Area color

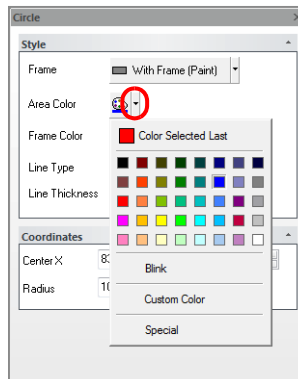

- Frame color

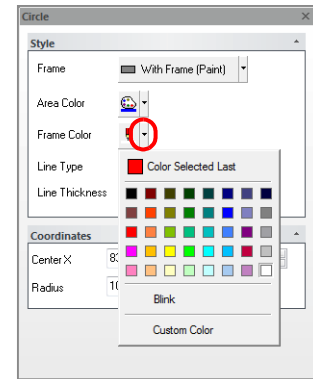

☺ Frame, area color, and frame color can also be set via [Edit] → [Style].
For more information, refer to "4.1.4 Style" page 4-9.

- To cancel the circle drawing mode, right-click or double-click the left mouse button.
Additional circles can be drawn by dragging the mouse again without canceling the drawing mode.

[Arc] and [Sector]

Drawing method: [Center]

1. Select the drawing method.

Click [Edit] → [Modify Parts] → [Drawing Method] → [Arc] and select [Center] as the drawing method.

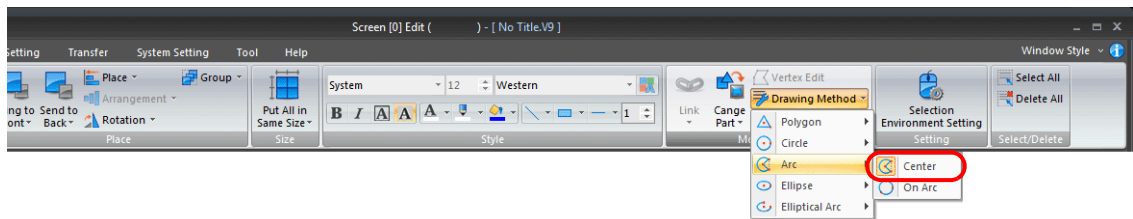

2. Click [Parts] → [Shape] → [Circle] and select [Arc] or [Sector].

The mouse cursor changes to a crosshair.

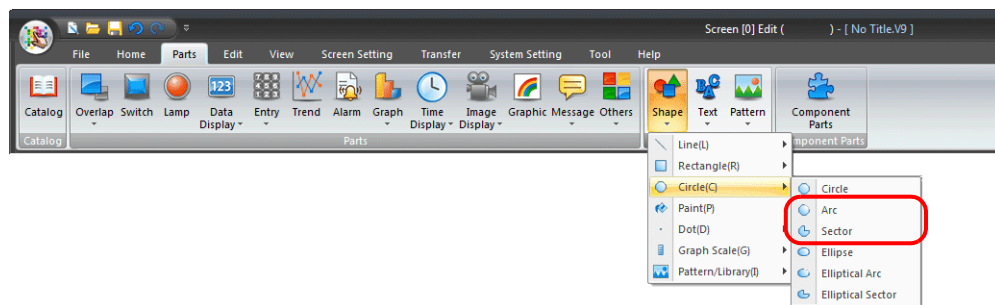

3. Drag from the center to the desired radius.

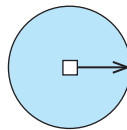

4. A line is displayed when you stop dragging. Click the mouse at the start point of the arc or sector.
5. Move the cursor along the arc or sector to the end point of the arc or sector. Move the cursor clockwise to select the section to remove, or counter-clockwise to draw the section to remain as the shape.

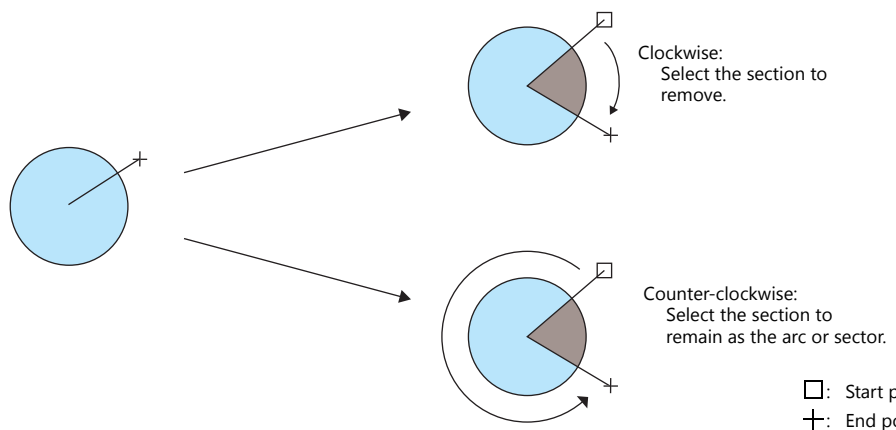

6. Click to accept the section that remains as the arc or sector and display the item view window.

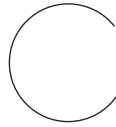

7. Set the style of the arc or sector in the item view window.

- Arc: Frame color, line type
- Sector: Frame, area color, frame color

Click ▼ next to each menu to display a list. Select a setting from each list. The placement position and size can be changed using the point coordinates.

• Arc

• Frame color

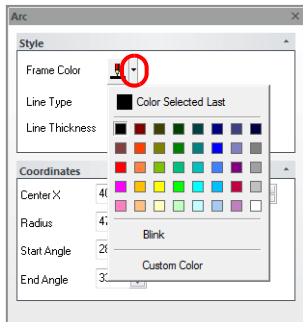

• Line type

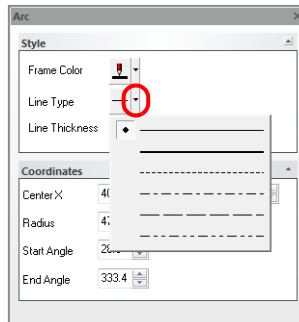

• Sector

• Frame

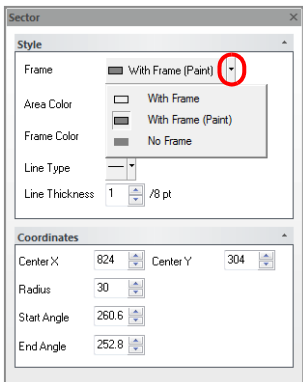

• Area color

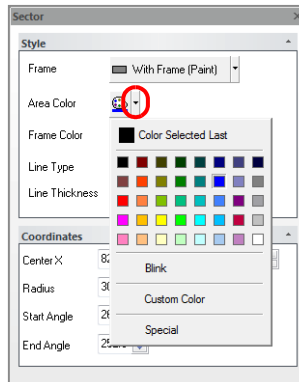

• Frame color

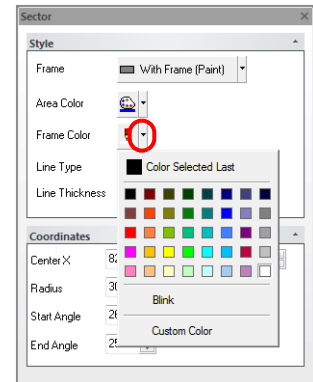

☹ Line type, frame, area color, and frame color can also be set via [Edit] → [Style]. For more information, refer to “4.1.4 Style” page 4-9.

8. To cancel the arc/sector drawing mode, right-click or double-click the left mouse button.

Additional arcs or sectors can be drawn by dragging the mouse again without canceling the drawing mode.

Drawing method: [On Arc]

1. Select the drawing method.

Click [Edit] → [Modify Parts] → [Drawing Method] → [Arc] and select [On Arc] as the drawing method.

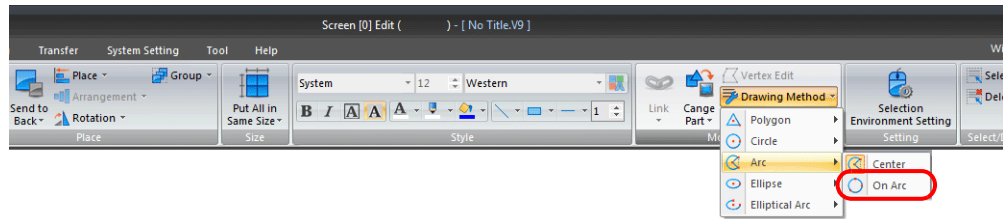

2. Click [Parts] → [Shape] → [Circle] and select [Arc] or [Sector].

The mouse cursor changes to a crosshair.

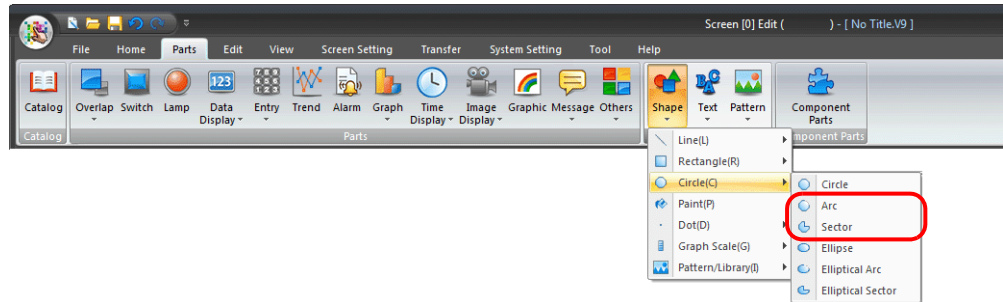

3. Drag the mouse from the start point to the end point.

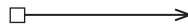

4. When the mouse is released, the arc or sector is displayed. Next, click a position to draw the desired arc or sector and display the item view window.

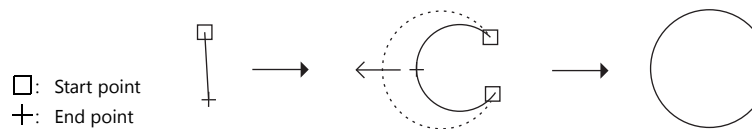

5. Set the style of the arc or sector in the item view window.

- Arc: Frame color, line type
- Sector: Frame, area color, frame color

Click ▼ next to each menu to display a list. Select a setting from each list.

The placement position and size can be changed using the point coordinates.

6. To cancel the arc/sector drawing mode, right-click or double-click the left mouse button.

Additional arcs or sectors can be drawn by dragging the mouse again without canceling the drawing mode.

[Ellipse]

1. Select the drawing method.
Click [Edit] → [Modify Parts] → [Drawing Method] → [Ellipse] to select the desired drawing method.

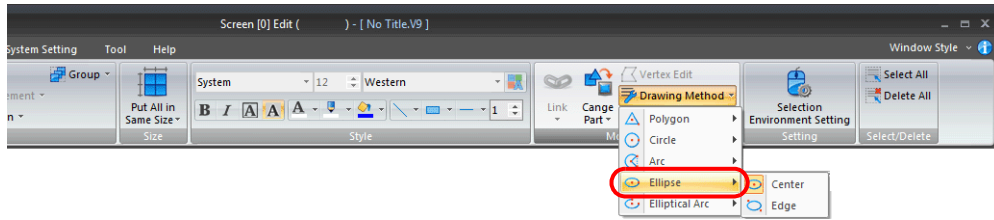

Center:
Drag from the center to specify the major radius.

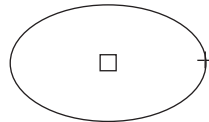

Edge:
Drag from the start point to the end point of a box in which an ellipse is drawn.

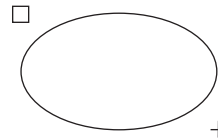

□: Start point
+: End point

For this example, select [Center].

2. Click [Parts] → [Shape] → [Circle] and select [Ellipse].
The mouse cursor changes to a crosshair.

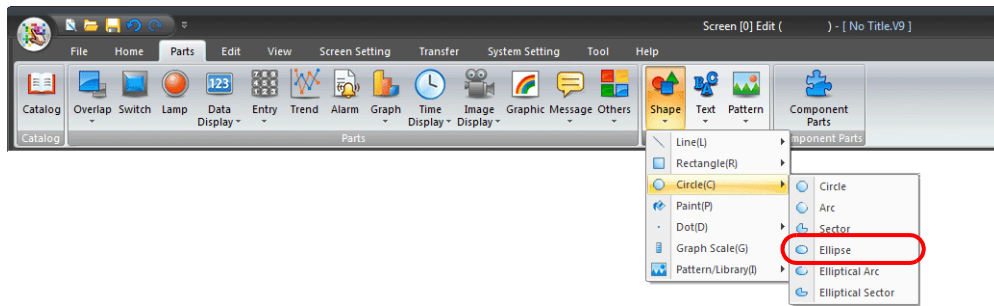

3. Drag the mouse from the center to the desired radius size to draw an ellipse and display the item view window.

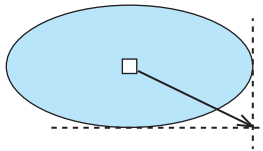

4. Set the style (frame, area color, and frame color) of the ellipse in the item view window.
Click ▼ next to each menu to display a list. Select a setting from each list.
The placement position and size can be changed using the point coordinates.

• Frame

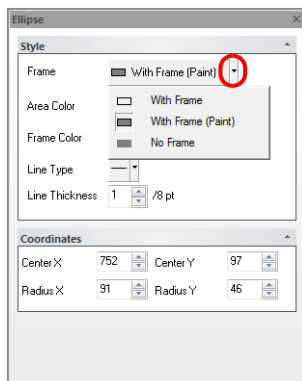

• Area color

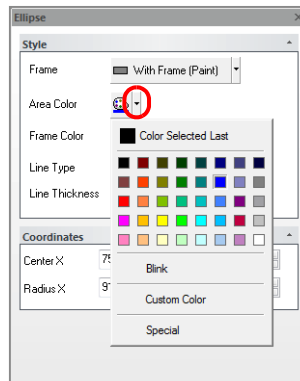

• Frame color

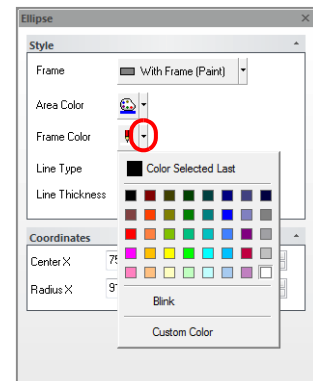

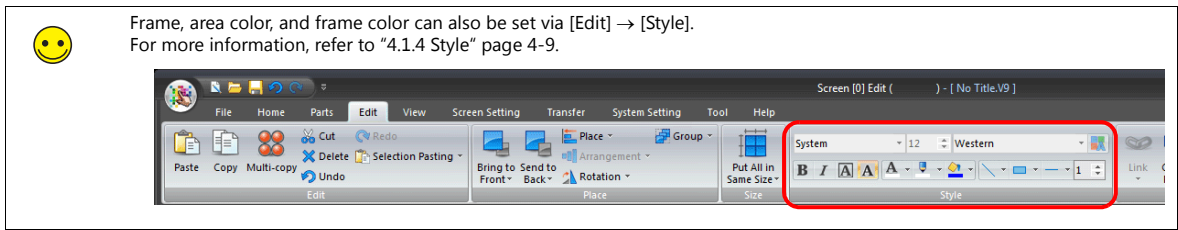

- To cancel the ellipse drawing mode, right-click or double-click the left mouse button.
Additional ellipses can be drawn by dragging the mouse again without canceling the drawing mode.

[Elliptical Arc]/[Elliptical Sector]

Drawing method: [Center]

- Select the drawing method.
Click [Edit] → [Modify Parts] → [Drawing Method] → [Elliptical Arc] and select [Center] as the drawing method.

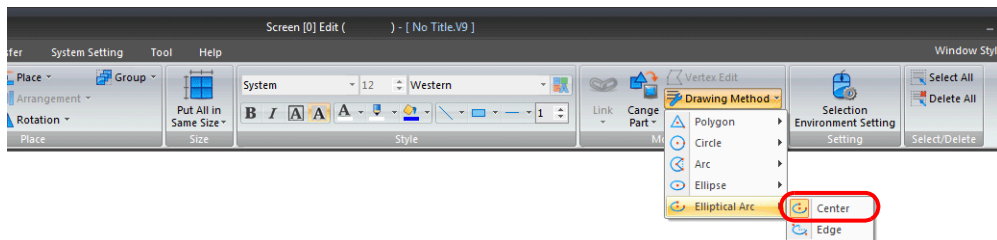

- Click [Parts] → [Shape] → [Circle] and select [Elliptical Arc] or [Elliptical Sector].
The mouse cursor changes to a crosshair.

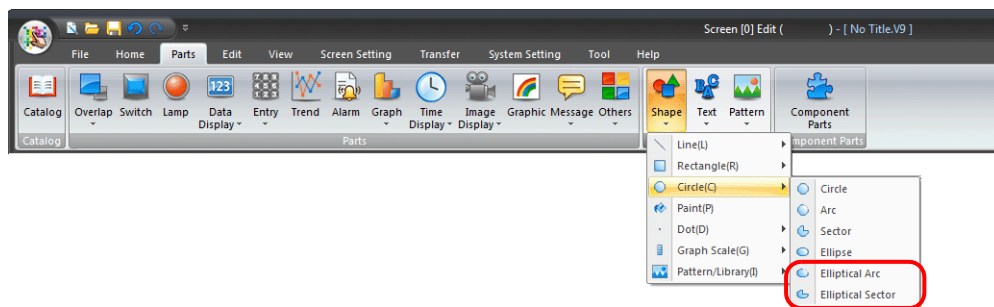

- Drag from the center to the desired radius.

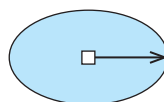

- A line is displayed when you stop dragging. Click the mouse at the start point of the elliptical arc or elliptical sector.
- Move the cursor along the elliptical arc or elliptical sector to the end point and click. Move the cursor clockwise to select the section to remove, or counter-clockwise to draw the section to remain as the shape.

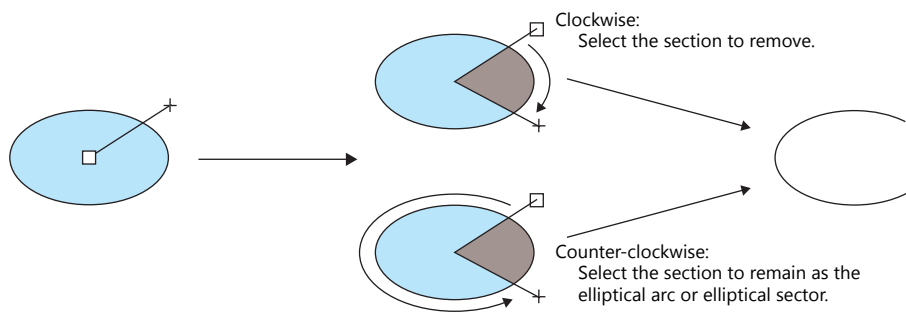

□: Start point
+: End point

6. Accepting the part displays the item view window.
Set the style of the elliptical arc or elliptical sector in the item view window.
Click ▼ next to each menu to display a list. Select a setting from each list.
The placement position and size can be changed using the point coordinates.

- Frame color

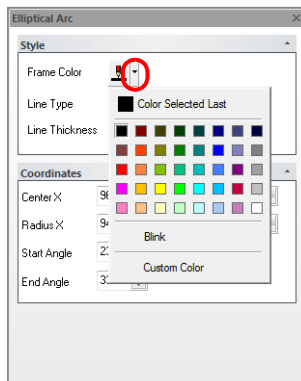

- Line type

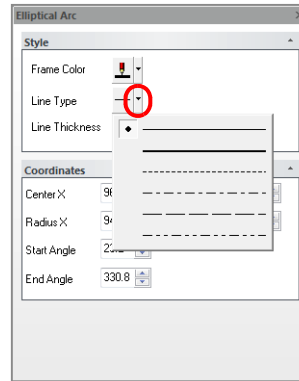

Line type, frame, area color, and frame color can also be set via [Edit] → [Style].
For more information, refer to "4.1.4 Style" page 4-9.

7. To cancel the elliptical arc/elliptical sector drawing mode, right-click or double-click the left mouse button.
Additional elliptical arcs or elliptical sectors can be drawn by dragging the mouse again without canceling the drawing mode.

Drawing method: [Edge]

1. Select the drawing method.

Click [Edit] → [Modify Parts] → [Drawing Method] → [Elliptical Arc] and select [Edge] as the drawing method.

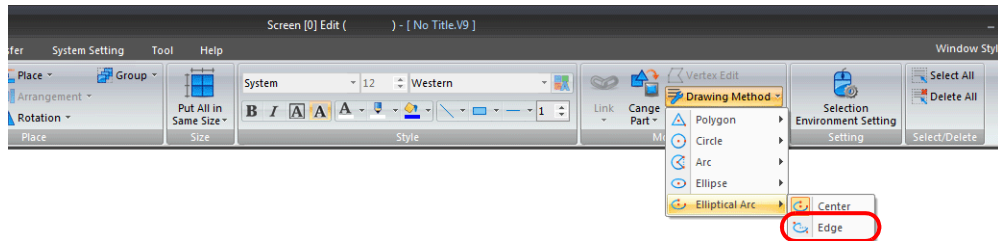

2. Click [Parts] → [Shape] → [Circle] and select [Elliptical Arc] or [Elliptical Sector].

The mouse cursor changes to a crosshair.

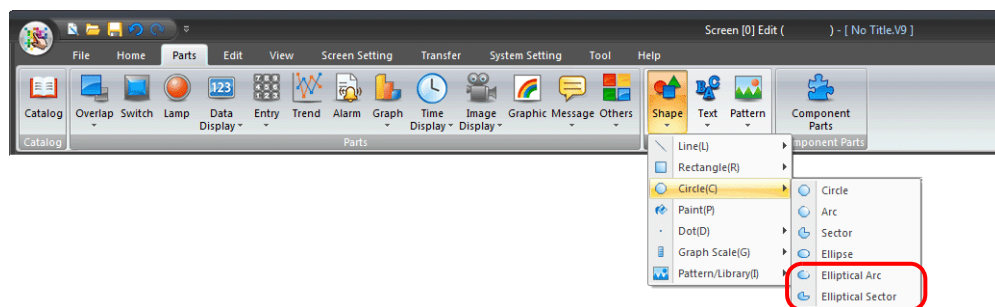

3. Drag the mouse from the start point to the end point.

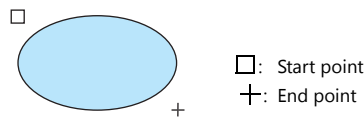

4. A line is displayed when you stop dragging. Click the mouse at the start point of the elliptical arc or elliptical sector.

5. Move the cursor along the elliptical arc or elliptical sector to the end point and click. Move the cursor clockwise to select the section to remove, or counter-clockwise to draw the section to remain as the shape.

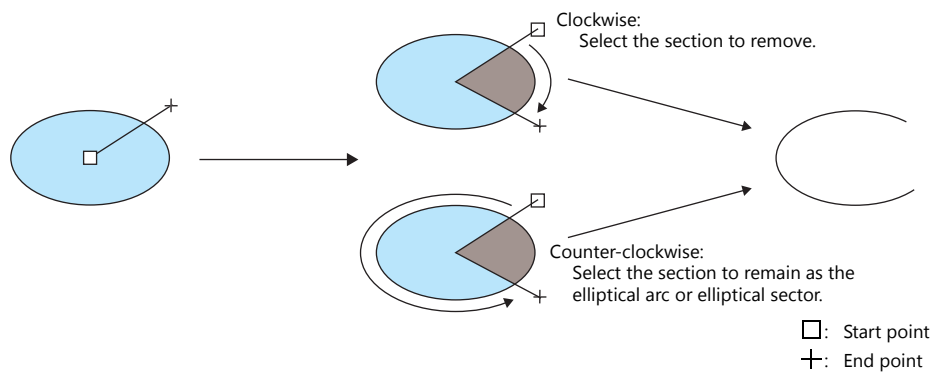

6. Accepting the part displays the item view window. Set the style of the elliptical arc or elliptical sector in the item view window.

- Elliptical arc: Frame color, line type
 - Elliptical sector: Frame, area color, frame color
- Click ▼ next to each menu to display a list. Select a setting from each list. The placement position and size can be changed using the point coordinates.

7. To cancel the elliptical arc/elliptical sector drawing mode, right-click or double-click the left mouse button. Additional elliptical arcs or elliptical sectors can be drawn by dragging the mouse again without canceling the drawing mode.

Paint

Use this command to paint an enclosed area.

Paint procedure

1. Draw an enclosed area in advance.



2. Select the paint color via [Edit] → [Style] → [Paint Color] icon.

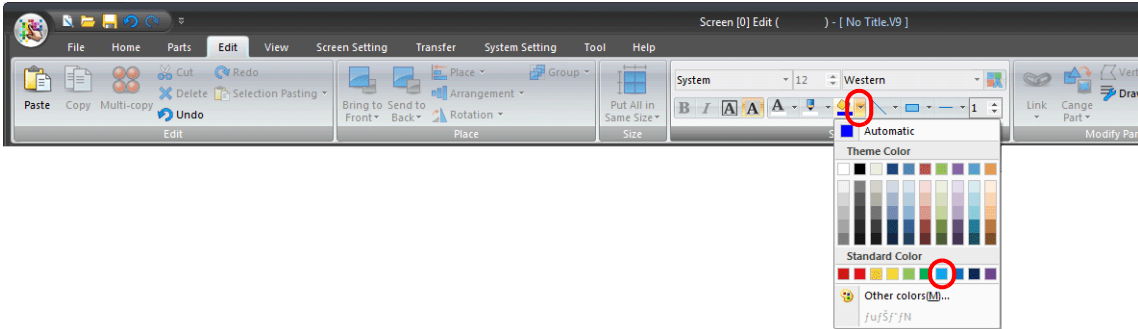

3. Click [Parts] → [Shape] → [Paint] to change the mouse cursor to a paint icon.

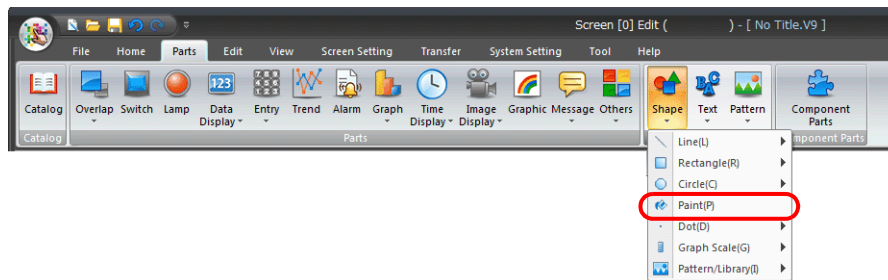

4. Click within the enclosed area to paint the area in the selected color.

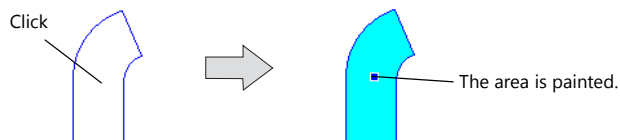

5. To cancel the painting mode, right-click or click the [Select] icon. Additional painting can be performed by clicking the mouse again without canceling the painting mode.

Checking the painting position

When the position where painting was executed cannot be checked or you wish to delete a painted area, this can be easily checked by temporarily canceling the paint display.

1. Click [View] → [Display Environment].
Deselect the [Display Paint] checkbox in the [Detail] list and click [OK].

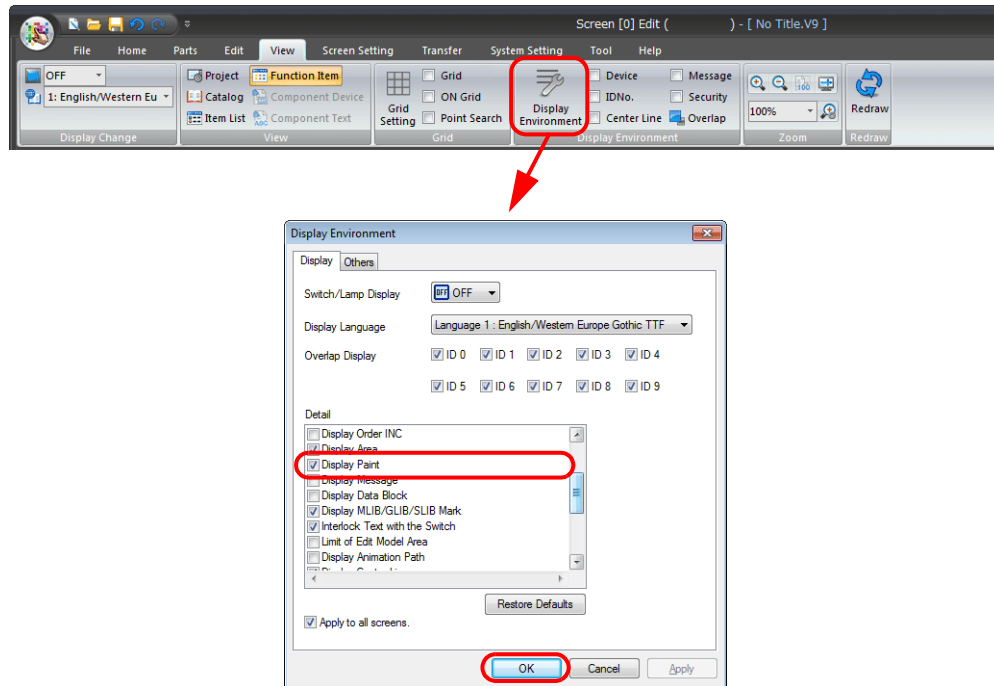

2. The paint display is removed from the screen and the position where painting was executed is indicated with a "×" mark.



3. Click or double-click on the "×" mark to display the [Paint] item view window.

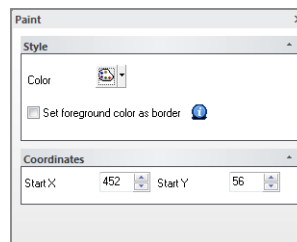
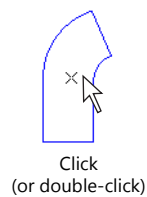

Paint properties

Click or double-click the position where painting was executed ("X" mark on the previous page) to display the [Paint] item view window.

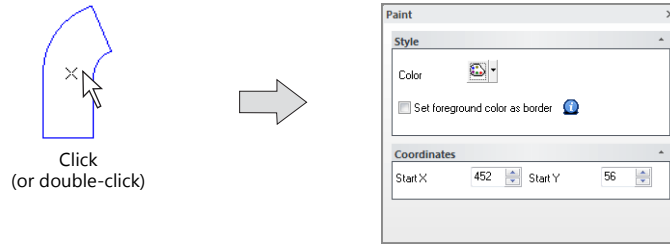

Set foreground color as border

- Checkbox unselected

Areas enclosed in a color different from the color selected for [Foreground] can be painted.

Painting is possible even if the foreground color is different from the boundary color.

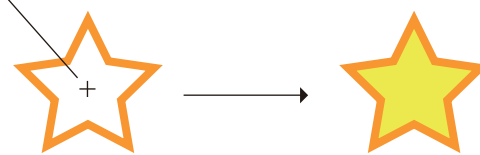

- Checkbox selected

Only areas enclosed in the same color as the color selected for [Foreground] can be painted.

Painting is possible in the same color as the boundary color.

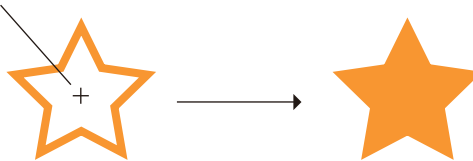

E.g.: If drawing an elliptical sector on a line and painting the enclosed area, it is painted as shown below.

Paint a graphic drawn in the following order.

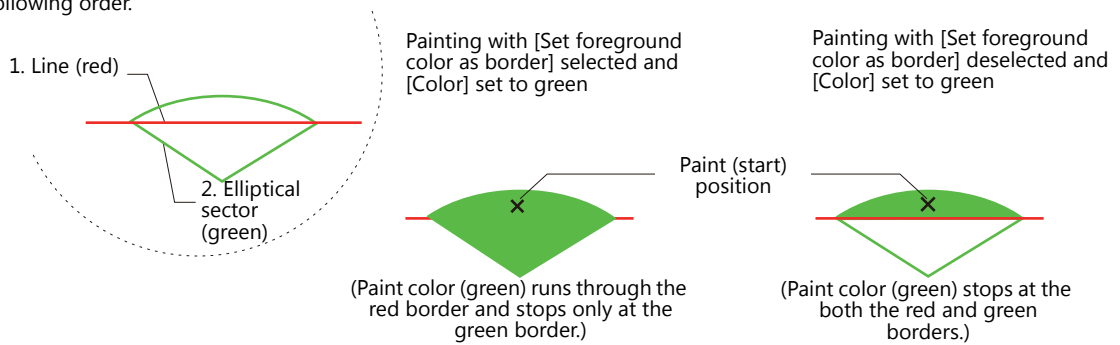

Dot

Drawing method

1. Click the ▼ mark next to the [Line Color/Frame Color] icon located at [Edit] → [Style].
Select the desired color from the displayed color list.

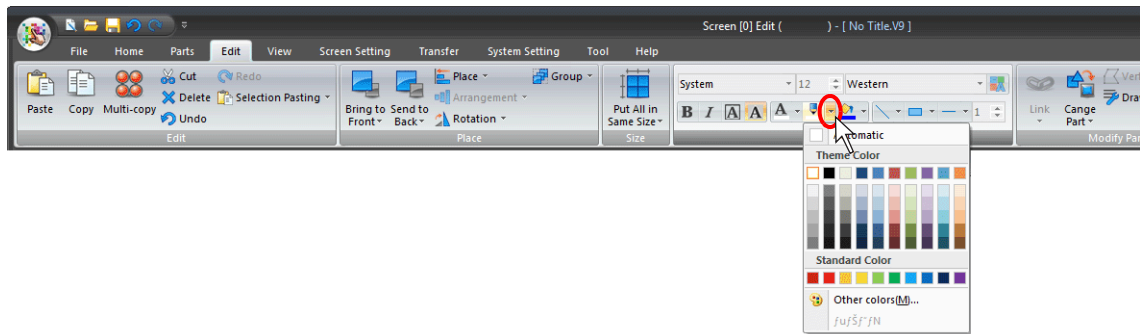

2. Click [Parts] → [Shape] → [Dot] and select the desired dot size. The mouse cursor changes to a crosshair.

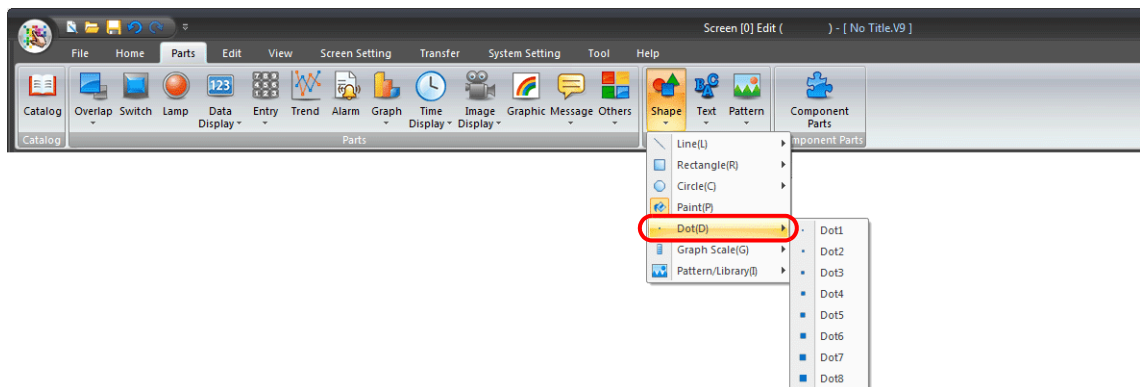

3. Click on the screen.
A dot is drawn in the color selected in step 1 and at the size selected in step 2.
4. To cancel the dot drawing mode, right-click or click the [Select] icon. Additional dots can be drawn by clicking the mouse again without canceling the painting mode.

Scale

[Bar Graph Scale]

1. Click [Parts] → [Shape] → [Graph Scale] → [Bar Graph Scale]. The mouse cursor changes to a crosshair.

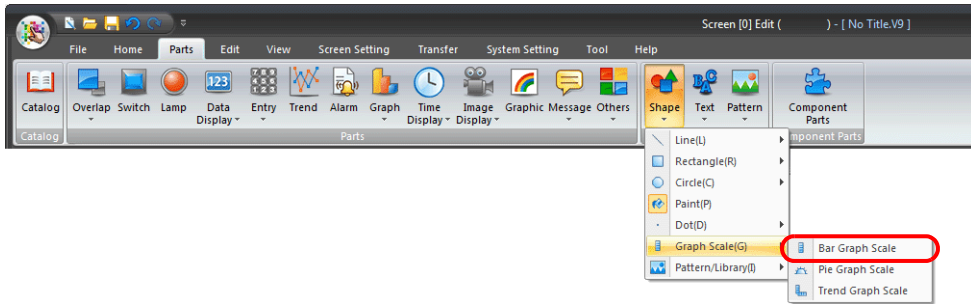

2. Drag the mouse from the start point to the end. This draws a scale and displays the item view window.



3. Settings including color, divisions, and line length can be changed in the item view window.

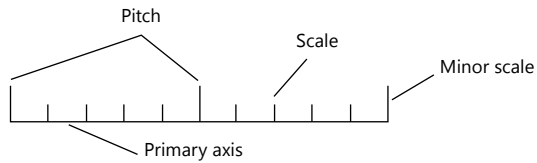
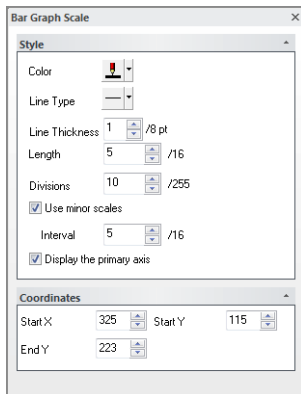

	Item	Description
Style	Color	Select the color of the scale.
	Length	Set the scale length.
	Divisions	Set the number of divisions of the scale.
	Use minor scales	Display a minor scale at the specified interval.
	Interval	Specify the interval to display the minor scales.
	Display the primary axis	Select this checkbox to display the primary axis.
Coordinates	Start X	Specify the X coordinate of the start point.
	Start Y	Specify the Y coordinate of the start point.
	End X/End Y	Specify the X coordinate of the end point on horizontal scales. Specify the Y coordinate of the end point on vertical scales.

4. To cancel the scale drawing mode, right-click or double-click the left mouse button. Additional scales can be drawn by dragging the mouse again without canceling the drawing mode.

[Pie Graph Scale]

Drawing method

1. Click [Edit] → [Drawing Method] → [Arc] and select a drawing method.

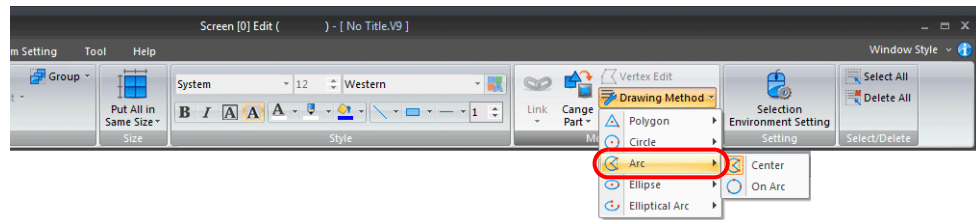

For this example, select [Center].

2. Click [Parts] → [Shape] → [Graph Scale] → [Pie Graph Scale]. The mouse cursor changes to a crosshair.

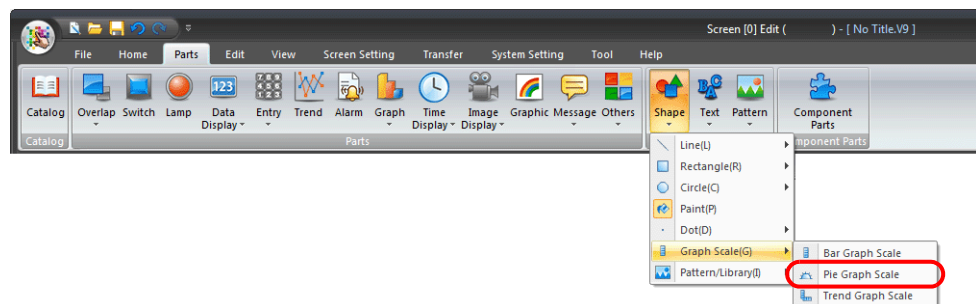

3. Drag from the center to the desired radius.
4. A line is displayed when you stop dragging. Click the mouse at the start point of the arc. Move the cursor along the arc to the end point of the arc. Move the cursor clockwise to select the section to remove, or counter-clockwise to draw the section to remain as the scale. Click to accept the shape.

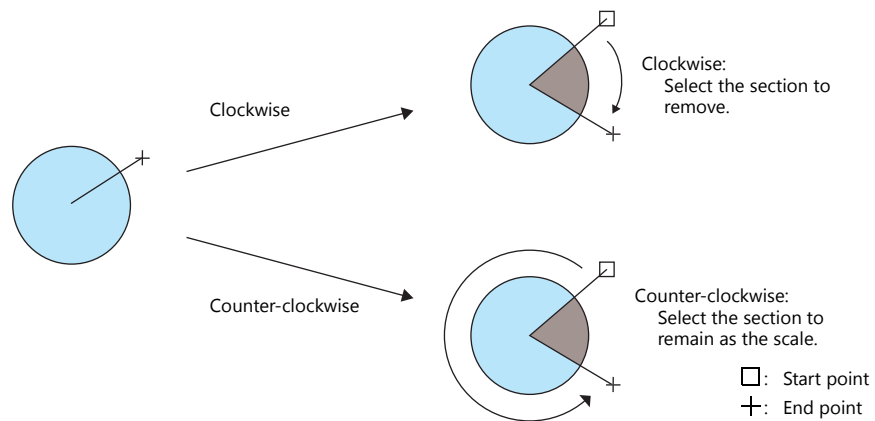

5. The pie graph scale is drawn and the item view window is displayed.

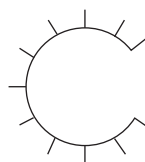

6. Settings including color, divisions, and line length can be changed in the item view window.

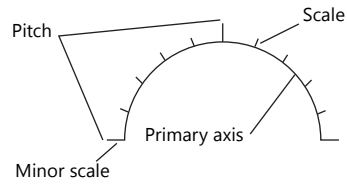
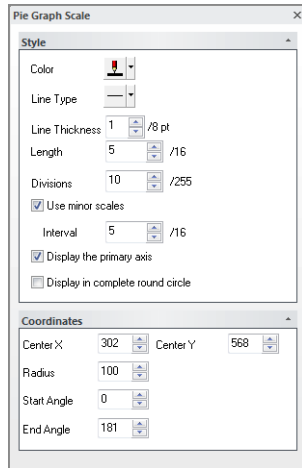

[Display the primary axis] checkbox selected

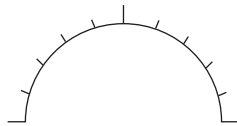

[Display the primary axis] checkbox unselected



Item		Description
Style	Color	Select the color of the scale.
	Length	Set the scale length.
	Divisions	Set the number of divisions of the scale.
	Use minor scales	Display a minor scale at the specified interval.
	Interval	Specify the interval to display the minor scales.
	Display the primary axis	Select this checkbox to display the primary axis.
	Display in complete round circle	Select this checkbox to display the scale as a complete circle.
Coordinates	Center X	Specify the X coordinate of the center.
	Center Y	Specify the Y coordinate of the center.
	Radius	Set the radius length.
	Start Angle	Specify the position of the start angle.
	End Angle	Specify the position of the end angle.

7. To cancel the scale drawing mode, right-click or double-click the left mouse button. Additional scales can be drawn by dragging the mouse again without canceling the drawing mode.

[Trend Graph Scale]

1. Click [Parts] → [Shape] → [Graph Scale] → [Trend Graph Scale]. The mouse cursor changes to a crosshair.

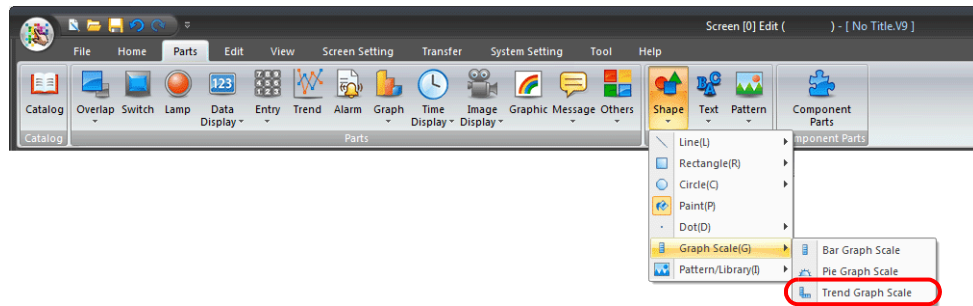

2. Drag the mouse from the start point to the end point in the same way as drawing a rectangle. The trend graph scale is drawn.

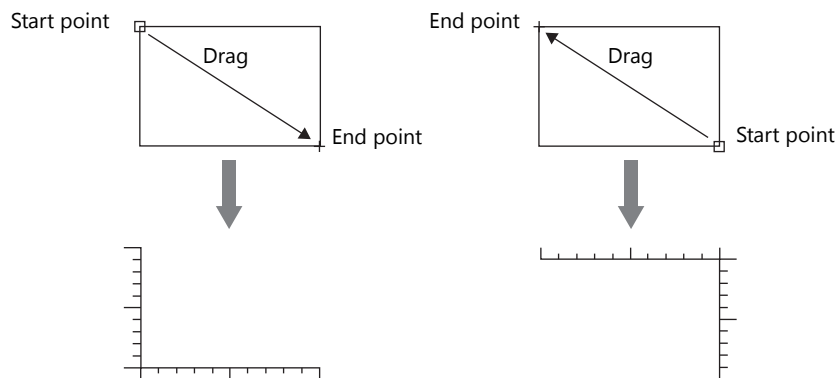

3. Settings including color, divisions, and line length can be changed in the item view window.

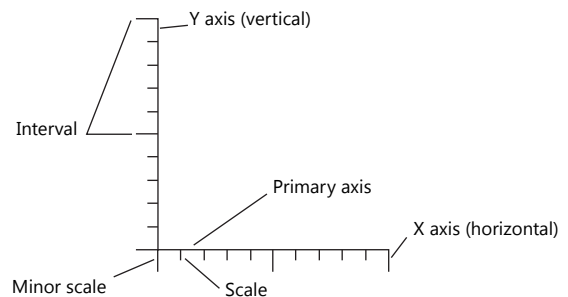
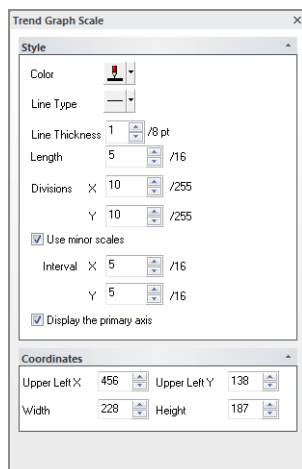

Item		Description
Style	Color	Select the color of the scale.
	Length	Set the scale length.
	Divisions X	Set the number of divisions of the scale on the X axis.
	Divisions Y	Set the number of divisions of the scale on the Y axis.
	Use minor scales	Display a minor scale at the specified interval.
	Interval X	Specify the interval to display the minor scales on the X axis.
	Interval Y	Specify the interval to display the minor scales on the Y axis.
	Display the primary axis	Select this checkbox to display the primary axis.
Coordinates	Upper Left X	Specify the X coordinate of the upper left position.
	Upper Left Y	Specify the Y coordinate of the upper left position.
	Width	Specify the width.
	Height	Specify the height.

4. To cancel the scale drawing mode, right-click or double-click the left mouse button. Additional scales can be drawn by dragging the mouse again without canceling the drawing mode.

Library

[Pattern]

Use this command to place a pattern registered in the pattern editing area on the screen.
For multi-language screens, pattern numbers are selectable on a language basis.



For more information on pattern registration and the pattern editing area, refer to “6.13 Pattern” page 6-48.

Placing a pattern

1. Click [Parts] → [Shape] → [Pattern/Library] → [Pattern]. The [Pattern List] window is displayed.

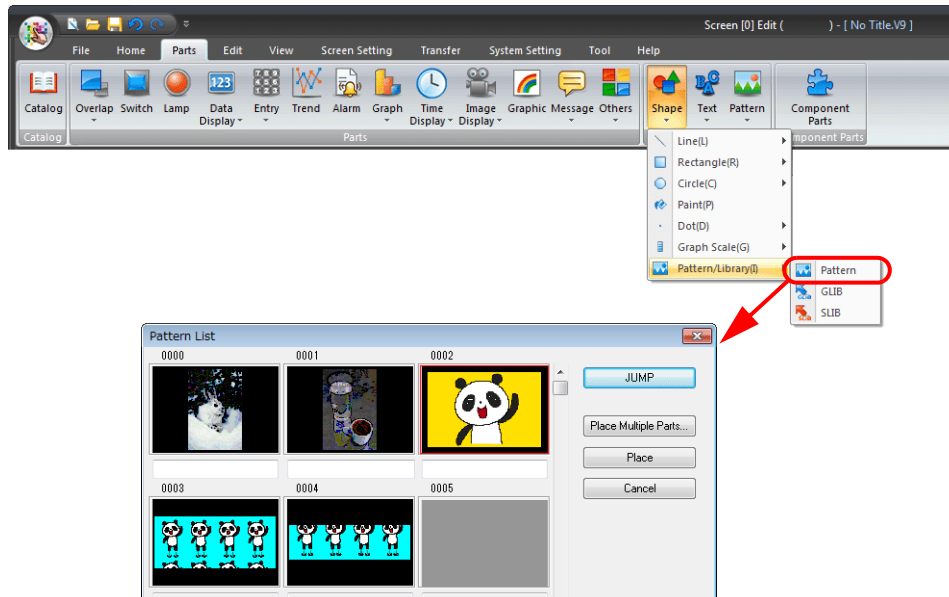

2. Click to select the desired pattern in the [Pattern List] window.

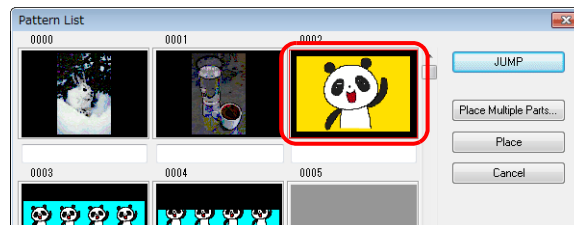

Click the [JUMP] button to jump to a specific pattern.

3. Click [Place]. The selected pattern is displayed together with the mouse cursor.



4. Click the left mouse button → at the desired position to place the pattern.

Placing multiple patterns consecutively

This is useful when placing split-registered patterns in alignment.

- Click the [Place Multiple Patterns] button in the [Pattern List] window.
The [Multiple Patterns] window is displayed.

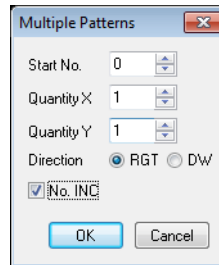

Item	Description
Start No.	Specify the top pattern number to be placed.
Quantity X/Y	Specify the quantity of patterns along the X axis and Y axis.
Direction (RGT/DW)	Select the direction to align patterns in multi-placement.
No. INC	Selected: Place patterns while incrementing the registered pattern number by one in sequence from the start number. Unselected: Copy and place the same pattern.

- Configure the following settings and click [OK].

[Start No.]: 3
[Quantity X]: 1
[Quantity Y]: 2
[Direction]: DW
[No. INC]: Selected

The selected pattern is displayed together with the mouse cursor.

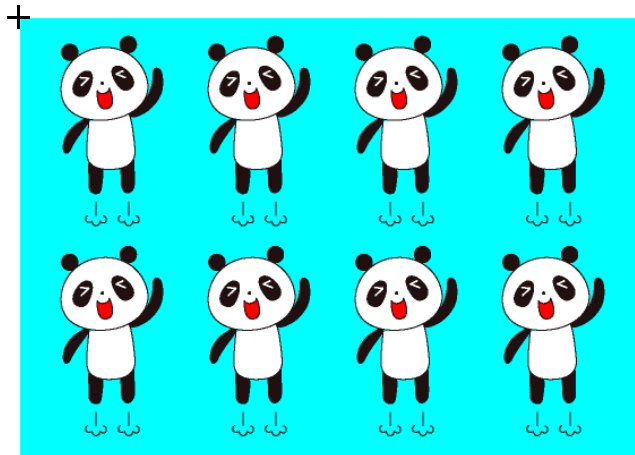

- Click the mouse at the desired position to place multiple patterns in alignment.

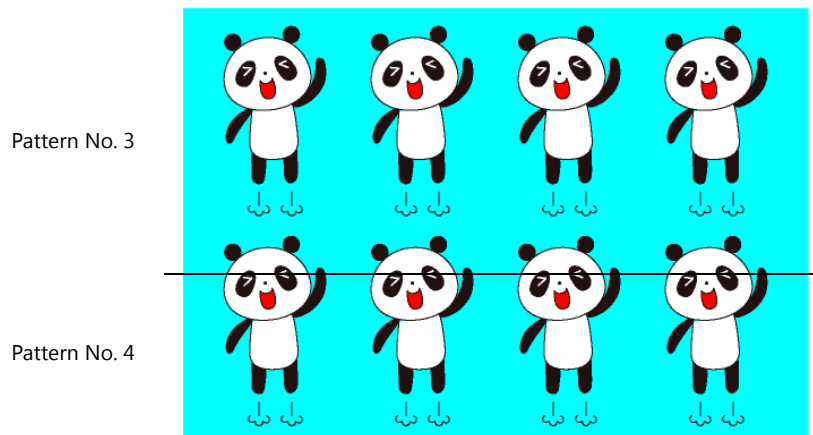

Graphic library (GLIB)

Use this command to place a graphic registered in the graphic library on the screen.

 For more information on graphic registration and the graphic library, refer to "6.6 Graphic Library" page 6-23.

1. Click [Parts] → [Shape] → [Pattern/Library] → [GLIB].
The [Graphic Library Group List] window is displayed.

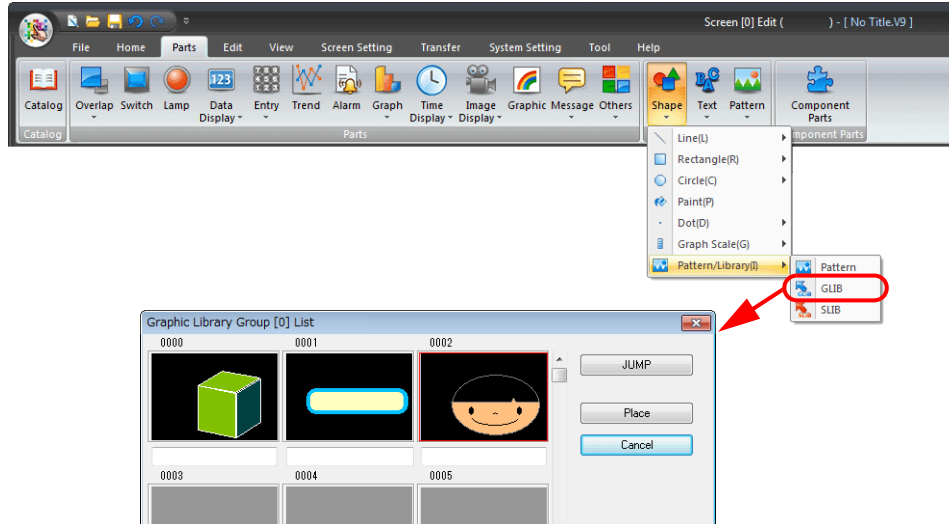

2. Click to select the desired graphic.

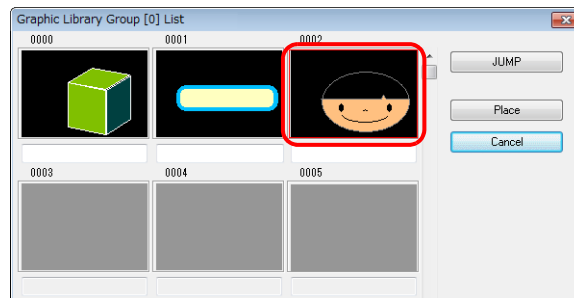

 Click the [JUMP] button to jump to a specific graphic.

3. Click [Place].
The graphic and graphic library icon is displayed together with the mouse cursor.

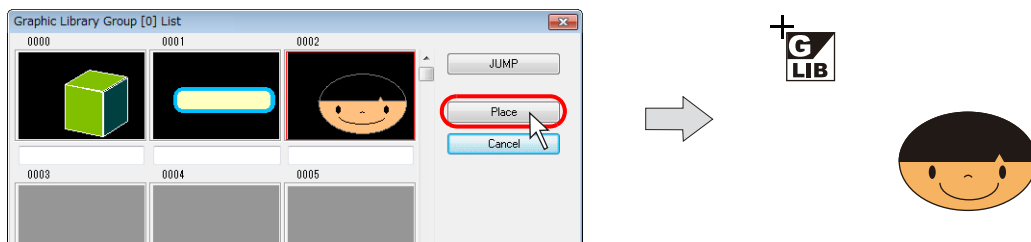

4. Click the mouse at the desired position to place the graphic with the [GLIB] mark at the clicked position.



The reference position of placing a graphic is the "offset" position on the graphic library. For more information on "offset," refer to page 6-24.

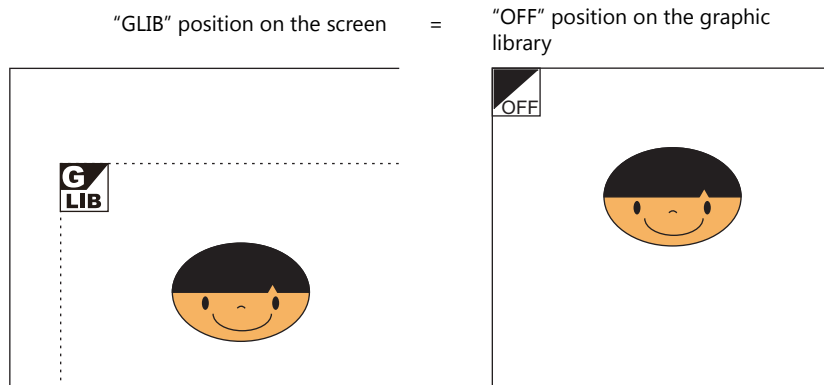

To call a graphic that is called with the graphic call command using another graphic call command (nesting), a maximum of eight nests is possible.

Screen library (SLIB)

Use this command to place a screen registered in the screen library on the screen.

 For more information on the screen library, refer to "6.5 Screen Library" page 6-16.

1. Click [Parts] → [Shape] → [Pattern/Library] → [SLIB].
The [Screen Library List] window is displayed.

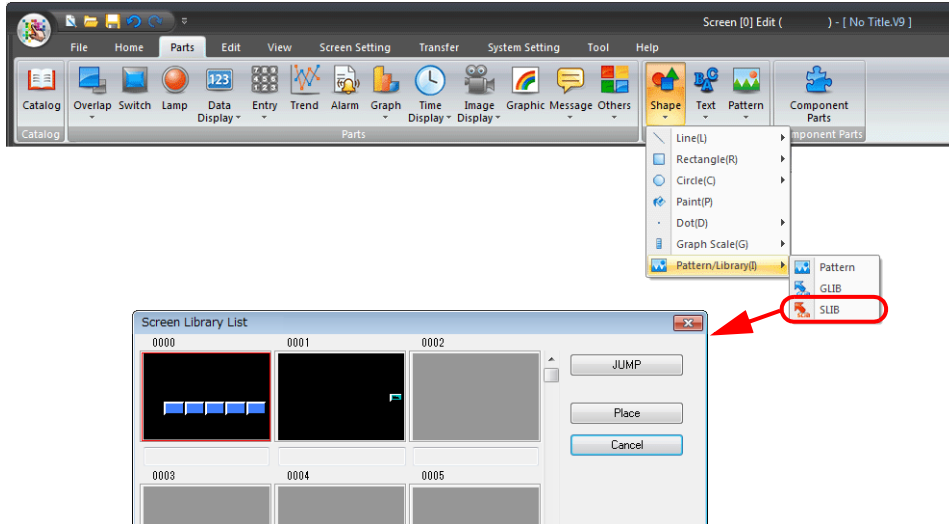

2. Click the desired library.

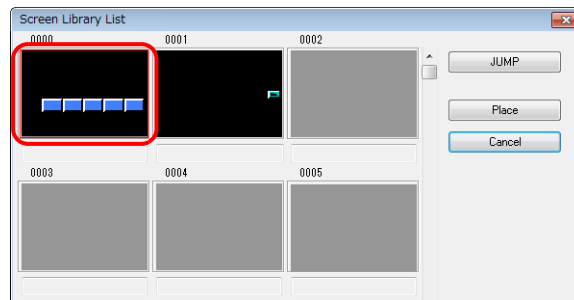

 Click the [JUMP] button to jump to a specific library.

3. Click [Place].
The library item and screen library icon is displayed together with the mouse cursor.

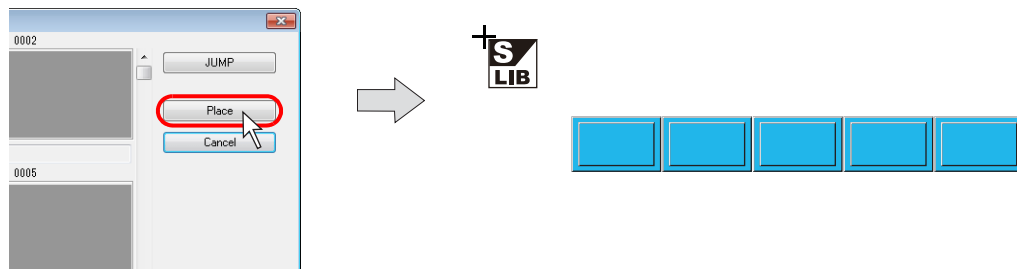

4. Click the mouse at the desired position to place the screen library with the [SLIB] mark at the clicked position.

 The reference position of placing a screen is the "offset" position on the screen library. For more information on "offset," refer to page 6-18.

"SLIB" position on the screen = "OFF" position on the screen library

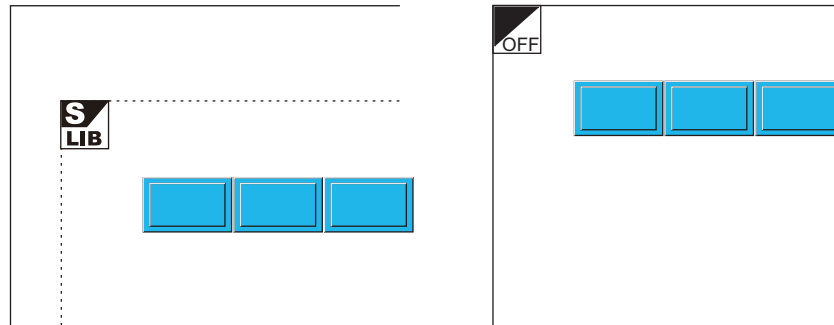

Item view window

The [Screen Library] view window is displayed by clicking the [SLIB] mark or by selecting the [SLIB] mark and then selecting [Detail Setting] from the right-click menu.

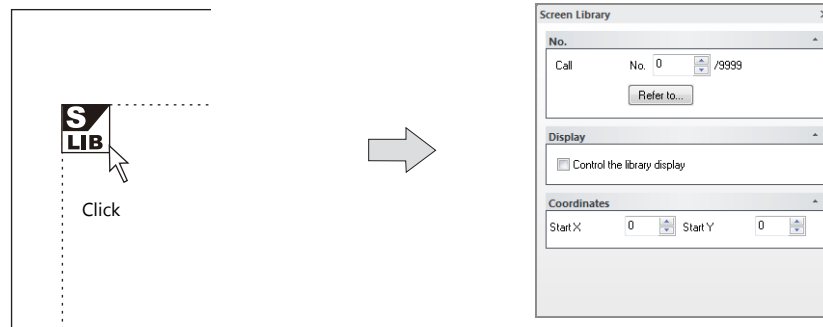

Item		Description
No.	Call	Specify the library number to display on the screen. Click [Refer to] to select from the screen library list.
Display	Control the library display	Select this checkbox to use control device memory. * When using control device memory, the display can be changed by performing a screen redraw after display is specified using the device memory. There are two methods of redrawing the screen: Method 1: Switch the screen. Method 2: Execute the RESET_SCRN macro command. (For more information, refer to the V9 Series Macro Reference Manual.)
	Control Device	Specify the control device memory. For more information, refer to "Screen Library Device Memory Specification" page 6-20.
	Control Format	<ul style="list-style-type: none"> Switch between shown and hidden states using bit ON/OFF operation: The library is shown when the control device memory bit is ON and hidden when the bit is OFF. Show by exchanging the library number: The library is shown by specifying the library number to display using the control device memory.
Coordinates	Start X	Specify the X coordinate of the upper left of [SLIB].
	Start Y	Specify the Y coordinate of the upper left of [SLIB].

*** Start X and Y points of the screen library**

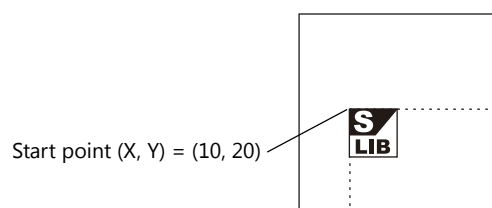

3.6.2 Text

Text and Multi Text

Placement procedure

1. Click [Parts] → [Text] → [Text] or [Multi Text].
The mouse cursor changes to a crosshair.

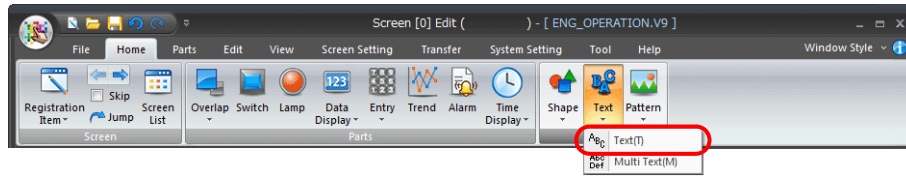

* When registering multiple lines of text, use [Multi Text].

2. Drag the mouse from the start point to the end point on the screen.
The specified area and a blinking cursor are displayed on screen.

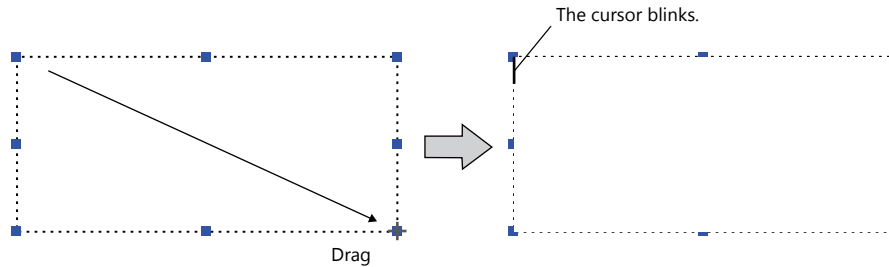

3. Enter text.
(The text is displayed with provisional attributes at this time. The text attributes are updated after performing step 4.)



4. Click the mouse at any position other than the text.
The text entered in step 3. is displayed.

MENU



5. Change the text properties in the item view window.

Item view window

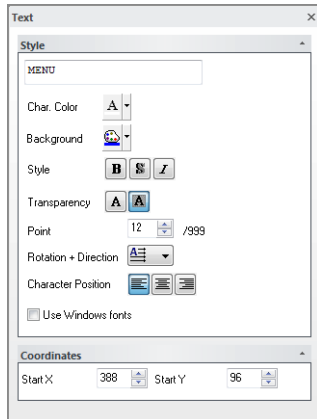

Click (or double-click) on the [Text] item to display the [Text] view window shown below.

- [Text]

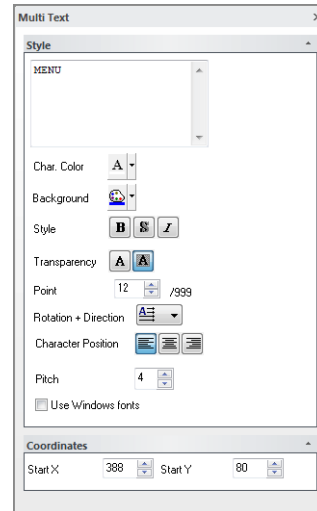

- [Multi-text]

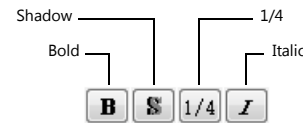

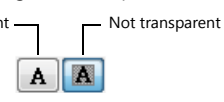
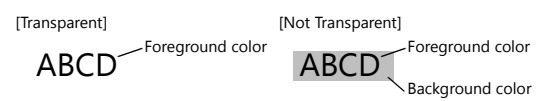
Item	Description
	Text field Enter text.
	Char. Color Set the text color.
	Background When [Transparency] is set to [Not Transparent], set the background color. 
Style	Select [Bold], [Shadow], [1/4] ^{*1} or [Italic] typeface for the text.   ^{*1} [1/4] can only be set when a bitmap font is specified in the font settings. This is only available for one-byte alphanumeric characters.
	Transparency Select whether to make the text background transparent.  

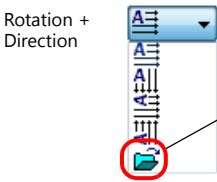
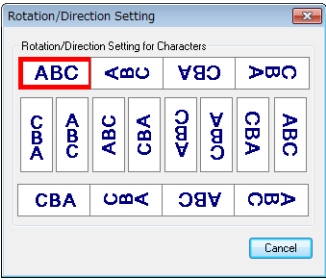
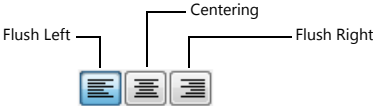
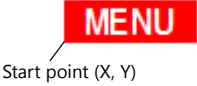
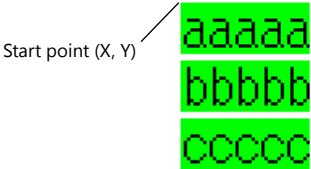
Item	Description																											
	<p>Specify the point size for the text.</p> <p>* When a bitmap font is specified in the font settings, specify an enlargement factor. The following table shows the relationship between character size and enlargement factor.</p> <table border="1" data-bbox="657 315 1329 613"> <thead> <tr> <th>Enlargement Factor</th> <th>One-byte (W × H dots)</th> <th>Two-byte (W × H dots)</th> </tr> </thead> <tbody> <tr><td>1</td><td>8 × 16</td><td>16 × 16</td></tr> <tr><td>2</td><td>16 × 32</td><td>32 × 32</td></tr> <tr><td>3</td><td>24 × 48</td><td>48 × 48</td></tr> <tr><td>4</td><td>32 × 64</td><td>64 × 64</td></tr> <tr><td>5</td><td>40 × 80</td><td>80 × 80</td></tr> <tr><td>6</td><td>48 × 96</td><td>96 × 96</td></tr> <tr><td>7</td><td>56 × 112</td><td>112 × 112</td></tr> <tr><td>8</td><td>64 × 128</td><td>128 × 128</td></tr> </tbody> </table>	Enlargement Factor	One-byte (W × H dots)	Two-byte (W × H dots)	1	8 × 16	16 × 16	2	16 × 32	32 × 32	3	24 × 48	48 × 48	4	32 × 64	64 × 64	5	40 × 80	80 × 80	6	48 × 96	96 × 96	7	56 × 112	112 × 112	8	64 × 128	128 × 128
Enlargement Factor	One-byte (W × H dots)	Two-byte (W × H dots)																										
1	8 × 16	16 × 16																										
2	16 × 32	32 × 32																										
3	24 × 48	48 × 48																										
4	32 × 64	64 × 64																										
5	40 × 80	80 × 80																										
6	48 × 96	96 × 96																										
7	56 × 112	112 × 112																										
8	64 × 128	128 × 128																										
Style	<p>Set the combination of text rotation and direction. Four combinations are displayed in the drop-down menu.</p>  <p>Click this icon to see other options.</p> <p>When selecting an option other than the above, click the icon at the bottom. The [Rotation/Direction Setting] window that allows selection from all options is displayed.</p> 																											
Character Position	<p>Select a position with which characters are aligned.</p> 																											
Pitch	<p>This setting is only available when using multi-text. Specify the desired line spacing. The maximum number of lines also changes depending on this setting.</p>																											
Use Windows fonts	<p>Select this checkbox to use a Windows font. For more information on Windows fonts, refer to "10.4 Windows Font" page 10-11.</p>																											
Coordinates	<ul style="list-style-type: none"> Text Specify the X and Y coordinates at the lower left corner of the item in dots.  <ul style="list-style-type: none"> Multi-text Specify the X and Y coordinates at the upper left corner of the item in dots. 																											
Language	<p>Interface Language This setting is available when creating a multi-language screen program. Change the display language using the pull-down menu. For more information, refer to "9 Language Changeover" in the V9 Series Reference Manual 2.</p> <p>Set coordinates for each language This setting is available when editing a multi-language screen program. The positions of text can be moved individually for each display language.</p>																											

3.6.3 Pattern

Import and place image data on the screen.

Picture

Import image data as a picture part and place the part on the screen.

Importable image files	<ul style="list-style-type: none"> • Bitmap files (*.bmp) • JPEG files (*.jpg / *.jpeg) • PNG files (*.png) • GIF files (*.gif)
------------------------	---

Placement procedure

1. Click [Parts] → [Pattern] → [Picture].
The [Open Image File] window is displayed.

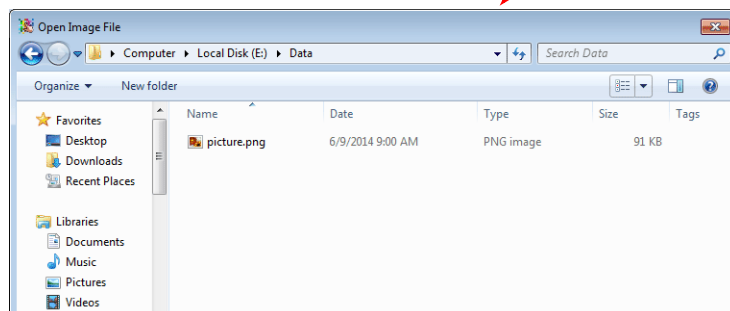
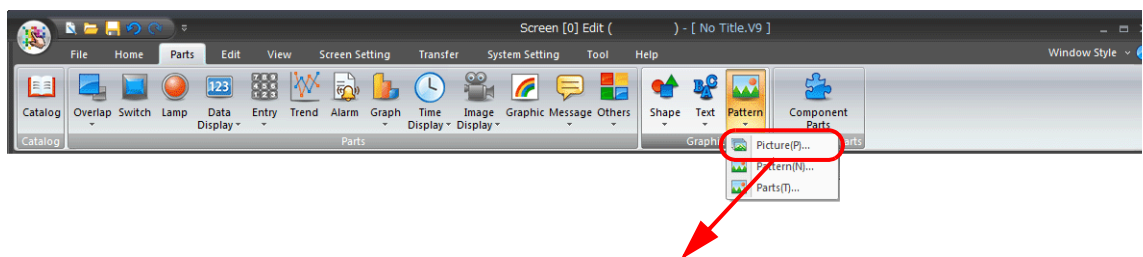

2. Select the file to import and click [Open].

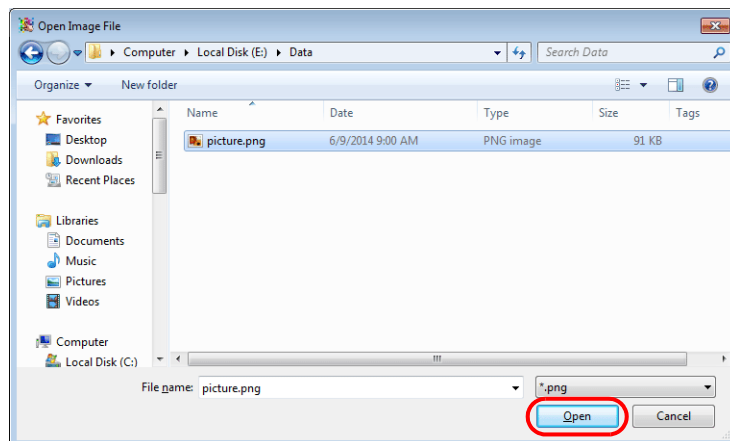

- The selected image is displayed as a picture part together with a crosshair. Click the desired position to place the picture part.

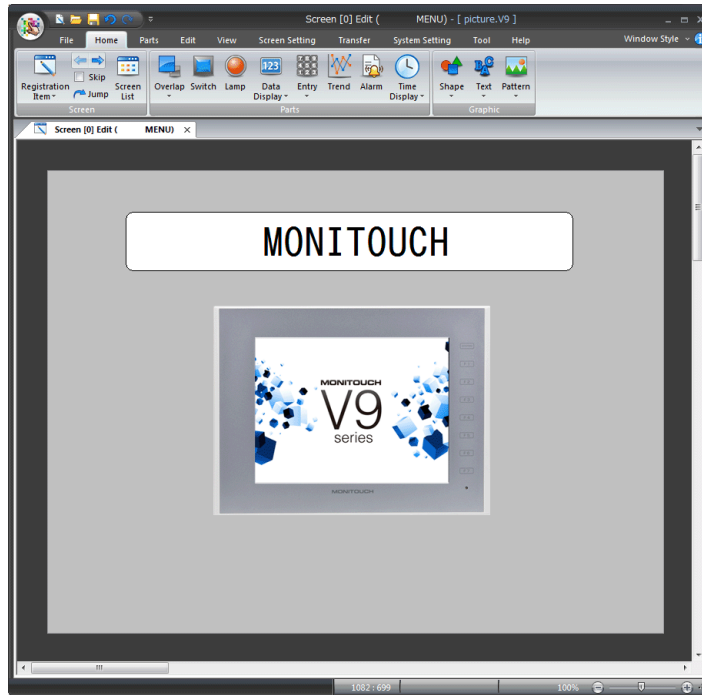

Item view window

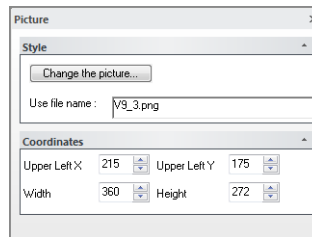

Item		Description
Style	Change the picture	Click to change the image. The [Open Image File] window is displayed.
	Use file name	The currently selected file name is displayed.
Coordinates	Upper Left X	Specify the X coordinate of the upper left of the image.
	Upper Left Y	Specify the Y coordinate of the upper left of the image.
	Width	Specify the width of the picture part.
	Height	Specify the height of the picture part.
Language	Interface Language	This setting is available when creating a multi-language screen program. Change the display language using the pull-down menu. For more information, refer to "9 Language Changeover" in the V9 Series Reference Manual 2.
	Set coordinates for each language	This setting is available when editing a multi-language screen program. The positions of parts can be moved individually for each display language.
	Set picture for each language	This setting is available when editing a multi-language screen program. The image file to display can be changed depending on the display language.

 The selected image is stored in "*.png" file format at the following location.

- Storage location
C:\MONITOUCH\User\Picture

Pattern

Import image data into the pattern area and place it on the screen as a pattern part.

Importable image files	<ul style="list-style-type: none"> • Bitmap files (*.bmp) • JPEG files (*.jpg / *.jpeg)
------------------------	---

Placement procedure

1. Click [Parts] → [Pattern] → [Pattern].
The [Open Image File] window is displayed.

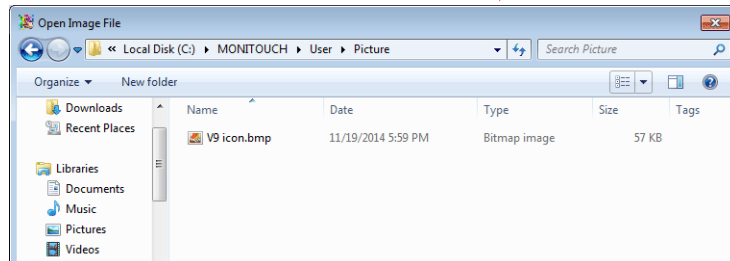
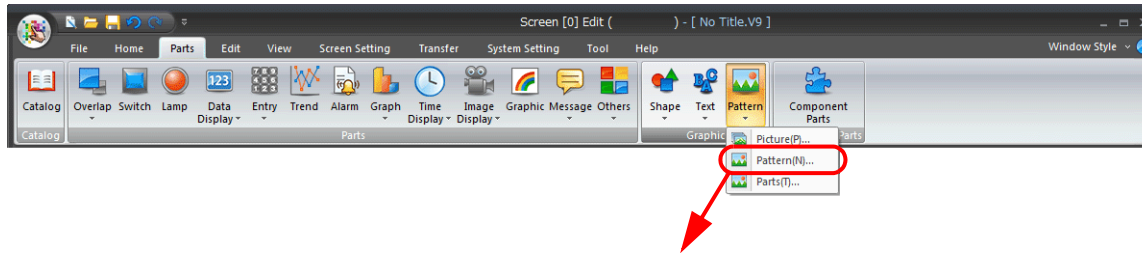

2. Select the file to import and click [Open].

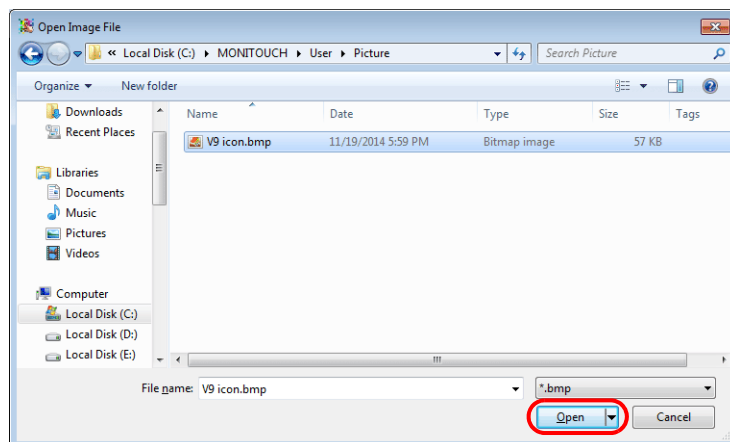

3. The following window is displayed. Configure the required settings and click [Place].



For more information on each setting, refer to " Dialog box displayed during image import" page 3-87.

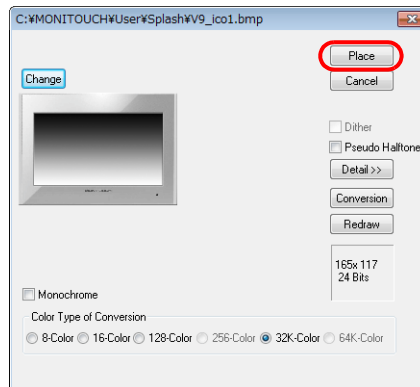

4. The selected image is displayed as a pattern part together with a crosshair. Click the desired position to place the pattern part.

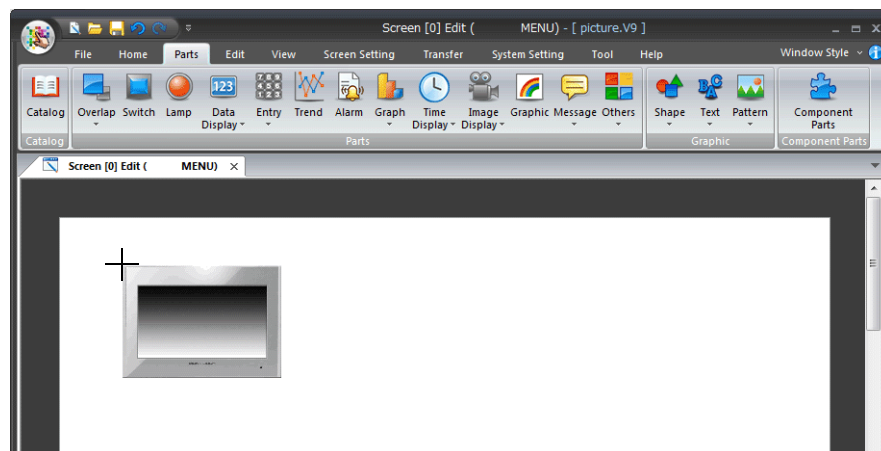

 The image is imported to [Home] → [Registration Item] → [Pattern].

Dialog box displayed during image import

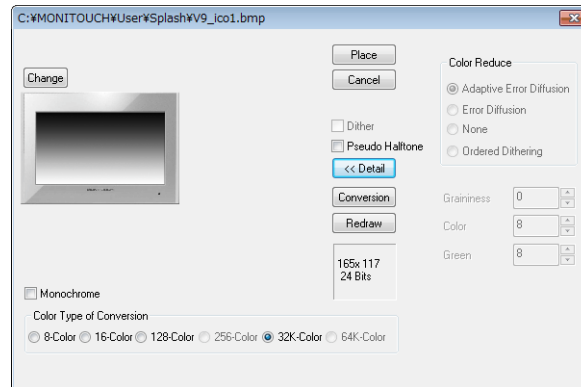

Item	Description																	
Place	Import the displayed image as a pattern and place it on the screen.																	
Cancel	Cancel image importing.																	
Dither	Select this checkbox to perform color correction to make the colors of the image closer to the original. The option is unavailable when [64K-Color] or [32K-Color] is selected for [Color Type of Conversion].																	
Pseudo Halftone	Select this checkbox to enable the [Detail] settings.																	
Detail	Click to display the following settings.																	
	<table border="1"> <thead> <tr> <th>Item</th> <th>Description</th> </tr> </thead> <tbody> <tr> <td rowspan="4">Color Reduce</td> <td>Adaptive Error Diffusion</td> <td>Perform error diffusion adapted to each individual part of the image. This function places more of an emphasis on image smoothness than the [Error Diffusion] setting below.</td> </tr> <tr> <td>Error Diffusion</td> <td>If a color in the source image is not included in the color pallet, two bits in similar colors are placed alternately so as to reproduce the color.</td> </tr> <tr> <td>None</td> <td>A pallet similar to the source image color is selected.</td> </tr> <tr> <td>Ordered Dithering</td> <td>The error diffusion pattern is made closer to a regular pattern as opposed to a random pattern.</td> </tr> <tr> <td>Graininess</td> <td>Specify a level of graininess. The smaller the entered value, the lower the graininess becomes.</td> </tr> <tr> <td>Color</td> <td>Assign priority to brightness or color depiction. When the specified number gets smaller, brightness takes priority over color.</td> </tr> <tr> <td>Green</td> <td>Assign priority to blue-green-based color or red-yellow-based color depiction. When the specified number gets smaller, green-based color takes priority over other colors.</td> </tr> </tbody> </table>	Item	Description	Color Reduce	Adaptive Error Diffusion	Perform error diffusion adapted to each individual part of the image. This function places more of an emphasis on image smoothness than the [Error Diffusion] setting below.	Error Diffusion	If a color in the source image is not included in the color pallet, two bits in similar colors are placed alternately so as to reproduce the color.	None	A pallet similar to the source image color is selected.	Ordered Dithering	The error diffusion pattern is made closer to a regular pattern as opposed to a random pattern.	Graininess	Specify a level of graininess. The smaller the entered value, the lower the graininess becomes.	Color	Assign priority to brightness or color depiction. When the specified number gets smaller, brightness takes priority over color.	Green	Assign priority to blue-green-based color or red-yellow-based color depiction. When the specified number gets smaller, green-based color takes priority over other colors.
	Item	Description																
	Color Reduce	Adaptive Error Diffusion	Perform error diffusion adapted to each individual part of the image. This function places more of an emphasis on image smoothness than the [Error Diffusion] setting below.															
		Error Diffusion	If a color in the source image is not included in the color pallet, two bits in similar colors are placed alternately so as to reproduce the color.															
		None	A pallet similar to the source image color is selected.															
		Ordered Dithering	The error diffusion pattern is made closer to a regular pattern as opposed to a random pattern.															
Graininess	Specify a level of graininess. The smaller the entered value, the lower the graininess becomes.																	
Color	Assign priority to brightness or color depiction. When the specified number gets smaller, brightness takes priority over color.																	
Green	Assign priority to blue-green-based color or red-yellow-based color depiction. When the specified number gets smaller, green-based color takes priority over other colors.																	
Conversion	Click (depress) to display a preview of the image when placed on the screen.																	
Redraw	If any settings, such as [Dither] or [Pseudo Halftone], are changed while the [Conversion] button is depressed, changes to the image can be previewed by clicking this button.																	
Monochrome	Select this checkbox to degrade image quality to 8-tone monochrome. This reduces the data size of the pattern.																	

Item view window

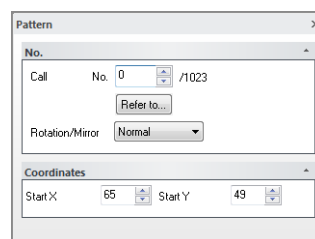

Item	Description	
No.	Call	Specify the pattern number to display. Click [Refer to] to display the pattern list.
Coordinates	Start X	Specify the X coordinate of the upper left of the pattern image.
	Start Y	Specify the Y coordinate of the upper left of the pattern image.
Language	Interface Language	This setting is available when creating a multi-language screen program. Change the display language using the pull-down menu. For more information, refer to "9 Language Changeover" in the V9 Series Reference Manual 2.

Parts

Import an image file to create parts such as switches and lamps.



Convert to
lamp part

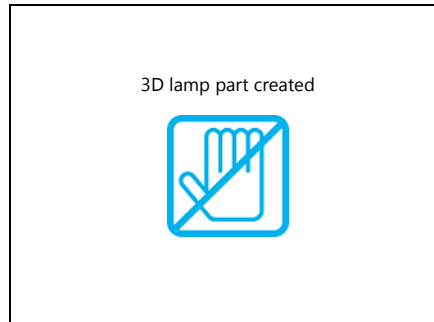

Importable image files	<ul style="list-style-type: none"> • PNG files (*.png) • Bitmap files (*.bmp)
------------------------	---

Applicable items

3D part conversion is available with the following items:

Switch
Lamp
Numerical Display
Character Display
Message Display
Graphs
Statistic graphs
Closed Area Graph
Calendar

Placement procedure

1. Click [Parts] → [Pattern] → [Parts] to display the [Image List] window.
"C:\MONITOUCH\User\Parts\" is displayed for [Displayed Image Directory].

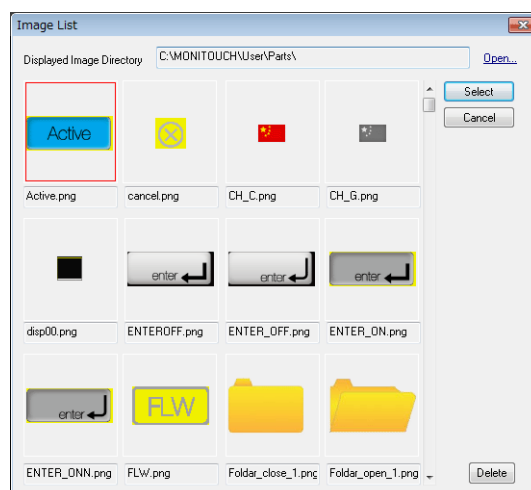

2. Select an image file.

If the desired image file is not displayed in the list, click [Open] and select the required file from the folder in which it is stored.

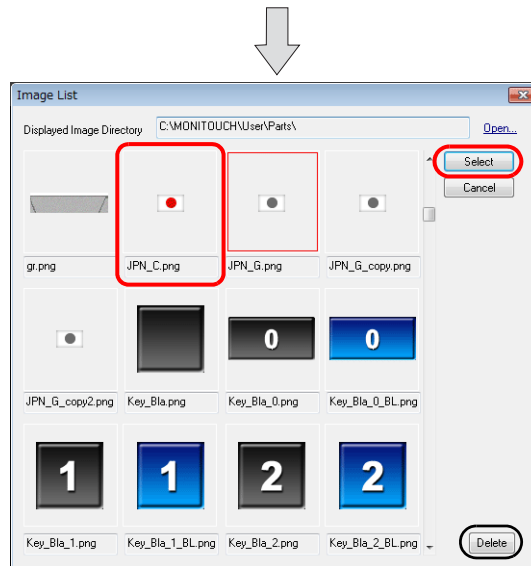
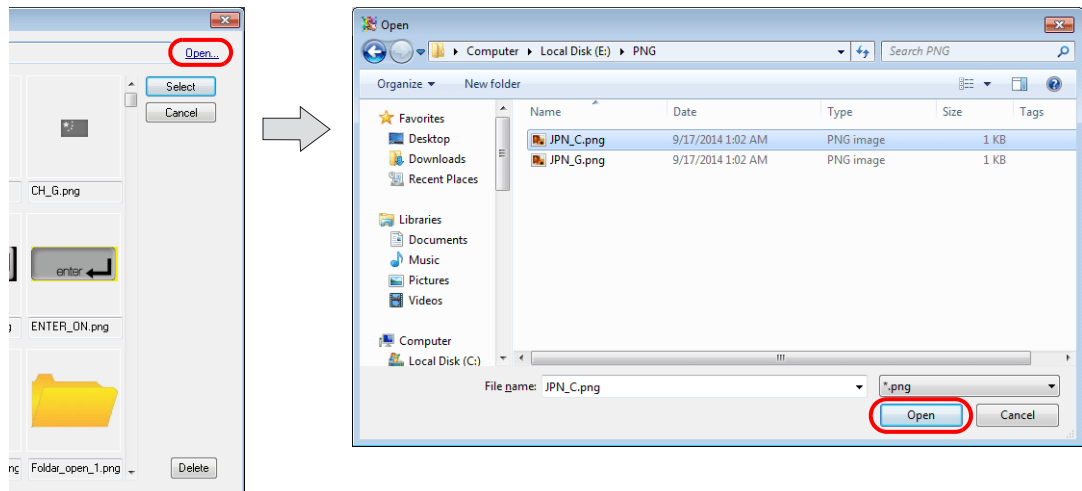

[Delete] button:
Delete the image from "C:\MONITOUCH\User\Parts\".

3. Click [Select]. The following window is displayed.

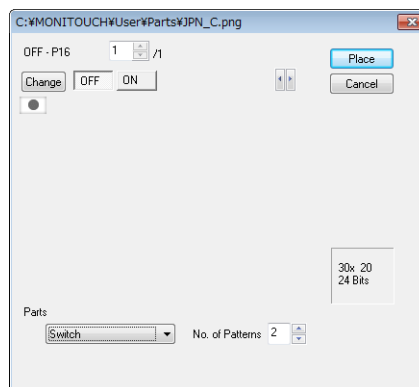

4. Select the part type. For this example, select [Switch].

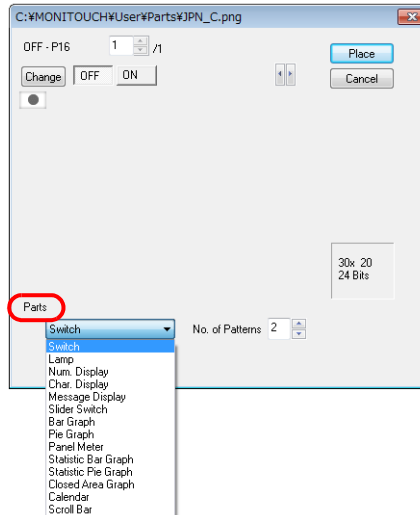

5. Specify the number for [No. of Patterns]. For this example, select "2".

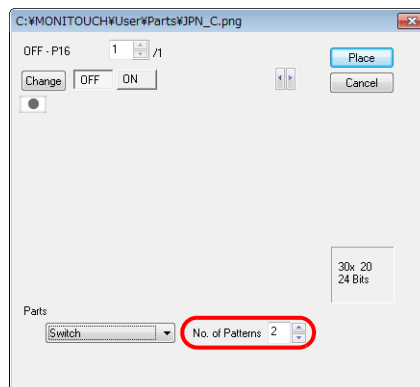

In the case of [Switch] and [Lamp] parts, select as many images as the number set for [No. of Patterns]. Select not only the image for [OFF] but also the image for [ON]. (If not selected, the same image selected for [OFF] is also used for [ON].)

6. Click the [ON] button.

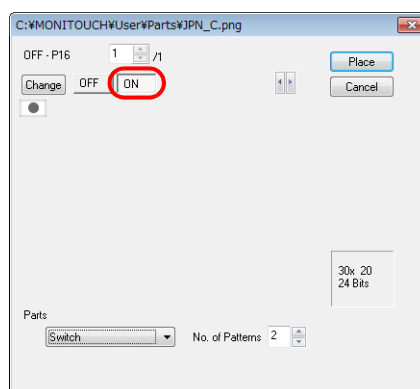

7. Click the [Change] button to display the [Image List] window again.
Select an image for [ON] and click [Select].

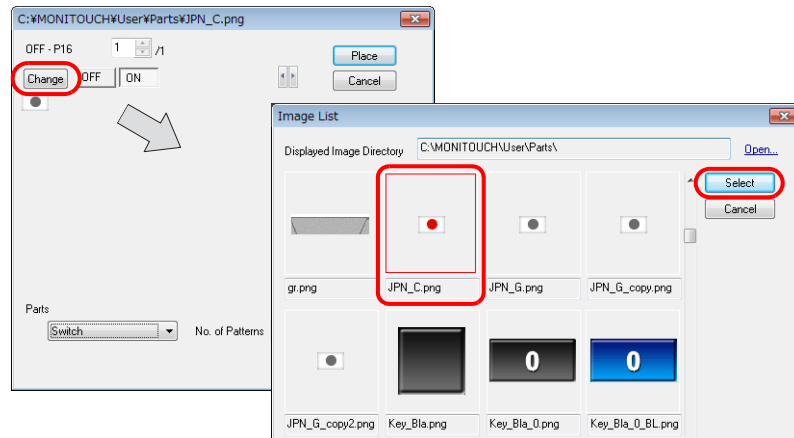

8. Once images for [OFF] and [ON] are selected, click [Place].
The selected image converted to a switch part is displayed together with a crosshair. Click the mouse button at the desired position to place the switch part on the screen.

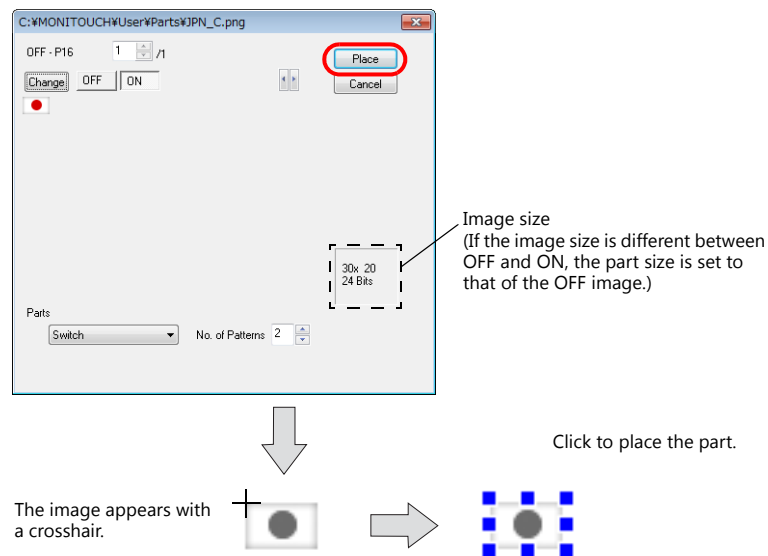

☹ To change the image placed as a part, click [Select from image files] → [Select] in the [Style] settings of the item settings window of the placed part and change the image file.

The diagram illustrates the steps to change an image in a part's settings. It begins with a part icon (a grid of blue squares with a central grey circle). An arrow points to the 'Switch' settings window. In this window, the 'Area Setting' section has 'Select from image files' selected. A red circle highlights the 'Select...' button next to 'JPN_G.png'. Below this, an arrow points to a file explorer window. The file explorer shows the path 'Local Disk (C:) > MONITOUCH > User > Parts'. A table of files is displayed, with 'JPN_G.png' selected. The 'File name' field at the bottom contains 'JPN_G.png' and the file type is set to 'PNG Files (*.png)'. The 'Open' button is visible.

Name	Date	Type	Size	Tags
GR_C.png	11/13/2014 1:01 AM	PNG image	2 KB	
GR_H.png	11/13/2014 1:01 AM	PNG image	1 KB	
GR_I.png	11/13/2014 1:01 AM	PNG image	1 KB	
GR_M.png	11/13/2014 1:01 AM	PNG image	2 KB	
GR_N.png	11/13/2014 1:01 AM	PNG image	2 KB	
GR_O.png	11/13/2014 1:01 AM	PNG image	2 KB	
GR_T.png	11/13/2014 1:01 AM	PNG image	1 KB	
GR_U.png	11/13/2014 1:01 AM	PNG image	1 KB	
JPN_C.png	11/13/2014 1:02 AM	PNG image	1 KB	
JPN_G.png	11/13/2014 1:02 AM	PNG image	1 KB	
Key_Bla.png	11/13/2014 1:01 AM	PNG image	1 KB	

3.6.4 Changing the Properties of Drawing Parts

The properties of drawing parts can be changed in each corresponding item view window.

Displaying the Item View Window

Display by clicking

By default, the corresponding item view window is displayed by clicking on a drawing item.

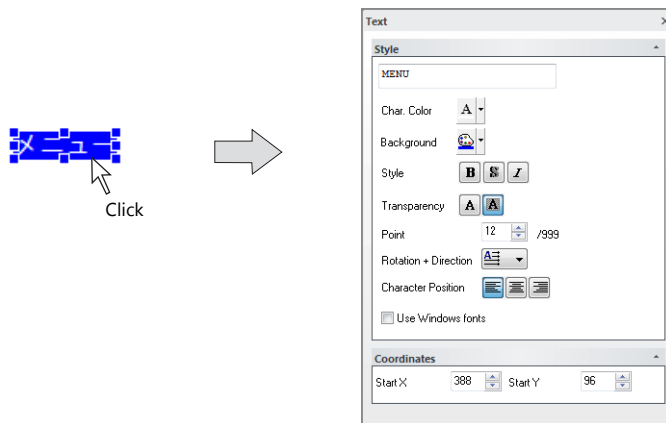

For more information on operating the item view window, refer to "2.3.6 View Windows" (page 2-31).

Display by double-clicking

It is also possible to set the editor to display the item view window by double-clicking on drawing items. Click [File] → [Property] → [General] tab and select the [Prohibit Item View Display by Single Click] checkbox.

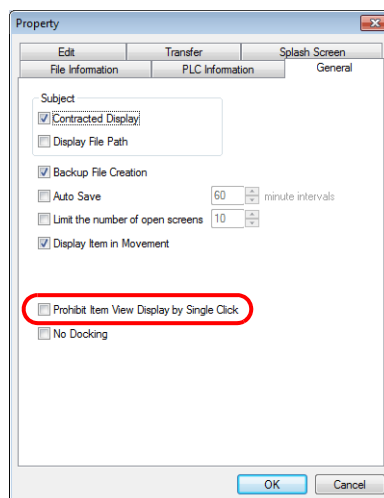

This requires the user to double-click the mouse instead of single clicking to display an item view window.

Examples of Item View Windows

Straight line

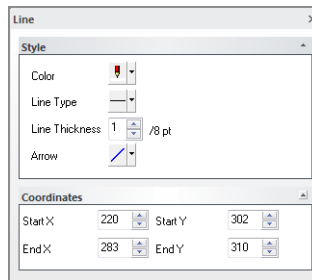

Rectangle

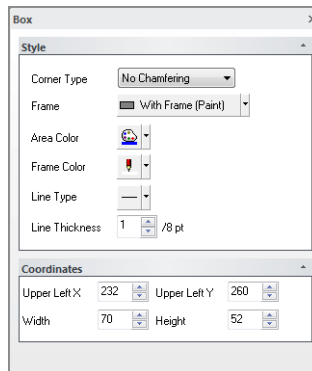

Text

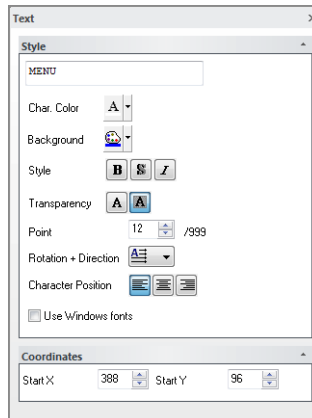

3.7 Component Parts

3.7.1 Overview

A component part is a single part that consists of multiple components (functions). Component parts can be placed in new files and existing files.

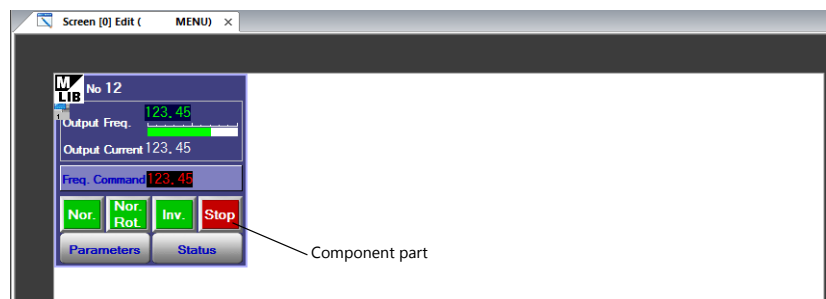

3.7.2 Placement Procedure

1. Click [Parts] → [Component Parts].

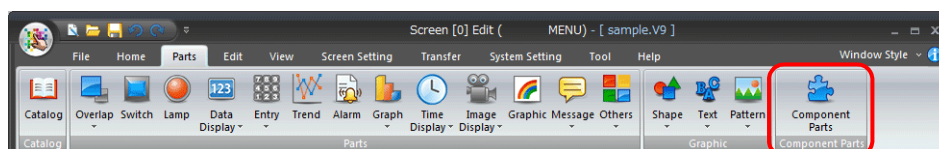

2. The [Select a part] window is displayed. Select the folder that contains the part to place and double-click or click [Select]

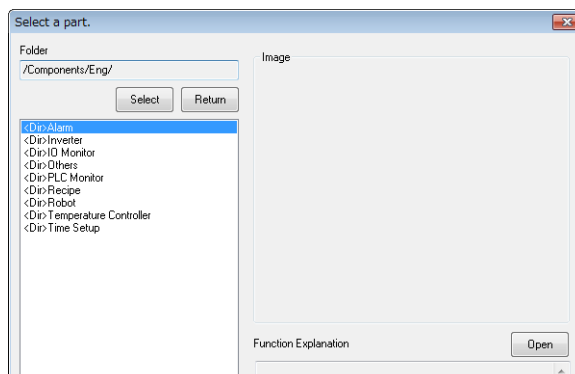

3. A list of component part filenames is displayed. Select the part to place and click [Place].

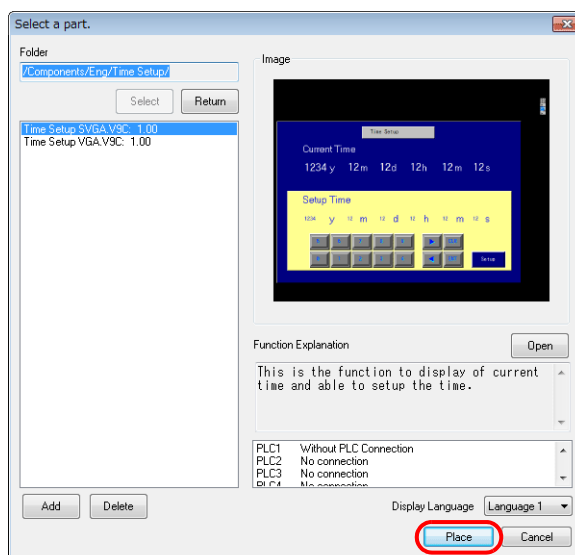

- The mouse cursor changes to a crosshair and the selected part is displayed together with the crosshair. Click a position to place the part.

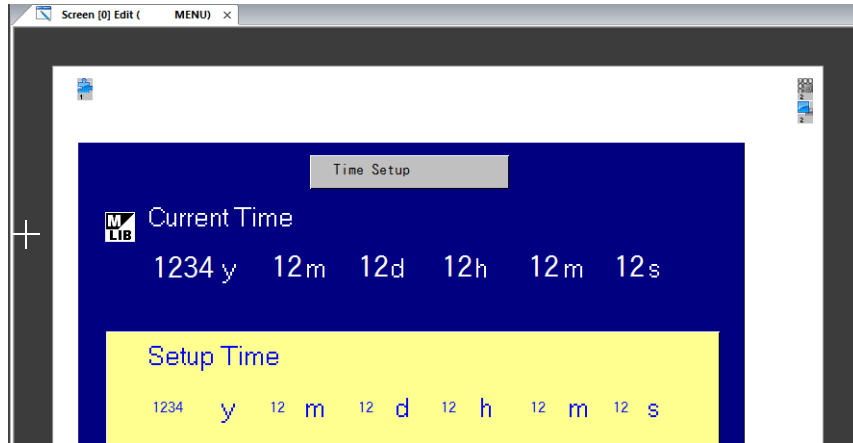

- Referencing operation manuals
Click [Open] in the [Select a part] window to display an [Open] window for opening the operation manual (PDF file) of each component part.

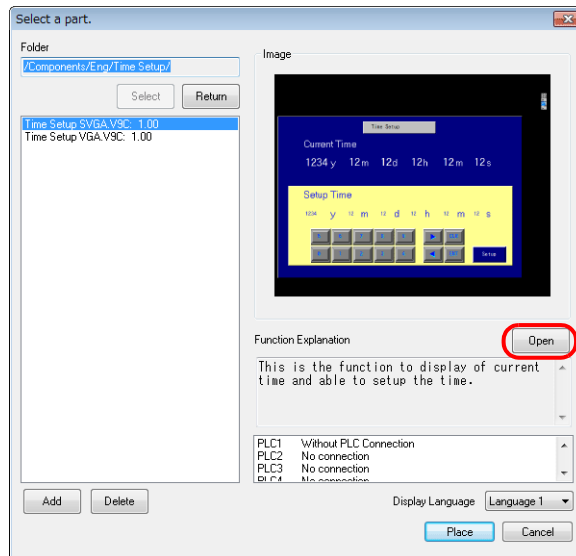

- Storage location of operation manuals
In separate part folders located under "C:\MONITOUCH\Common\Parts\Components\Eng"

3.7.3 Settings

Double-click the placed part to display the item settings window.



For more information on part settings, refer to the operation manual of the corresponding part.

- Storage location of operation manuals
In separate part folders located under "C:\MONITOUCH\Common\Parts\Components\Eng"

4 Useful Editing and View Menus

- 4.1 Edit Menu
- 4.2 View Menu
- 4.3 Screen Setting Menu

4.1 Edit Menu

4.1.1 Edit

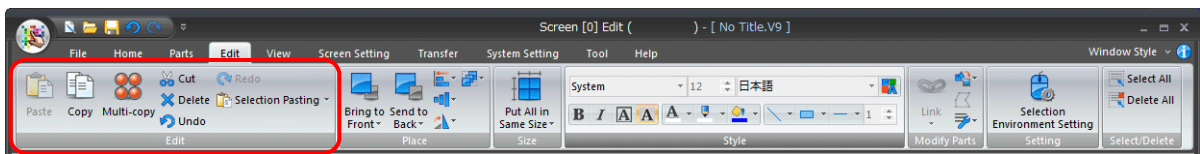

Item	Description	Refer to
Paste	Paste the item on the clipboard to the screen.	-
Copy	Copy the selected item to the clipboard.	-
Multi-copy	Create multiple copies of a selected item at once.	page 4-1
Cut	Cut the selected item and move it to the clipboard.	-
Delete	Delete the selected item.	-
Undo	Restore the screen to the state before the last action was performed.	-
Redo	This command becomes available when [Undo] is performed. Click this button to restore the screen to the state before [Undo] was executed.	-
Selection Pasting	Selection Pasting	page 4-4
	Undo Selection Pasting	
	This command becomes active after selection pasting is executed. Click to restore the screen to the state before [Selection Pasting] was executed.	

Multi-copy

Multiple copies of a part can be created at once.

After selecting a part, click [Multi-copy]. The [Multi Copy] window is displayed.

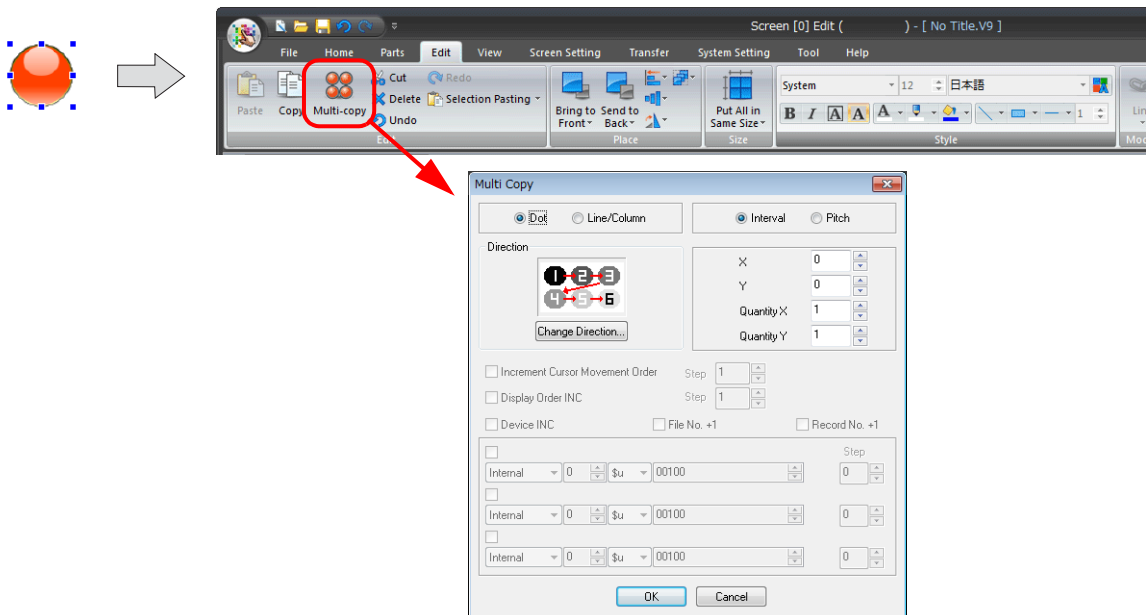

Item	Description
Dot Line/Column	Select whether to place copied parts on the screen according to the position specified by dots or by lines/columns. For more information on the line and column setting, refer to page 4-27.

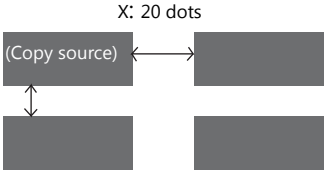
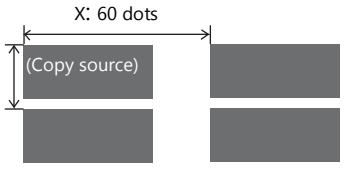
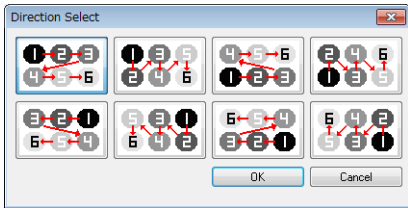
Item	Description
Interval/Pitch	<p>Select whether to place copied parts on the screen according to the position specified by a pitch or interval.</p> <p>Interval X: 20 Y: 10 Quantity X: 2 Quantity Y: 2 Y: 10 dots</p>  <p>Pitch X: 60 Y: 20 Quantity X: 2 Quantity Y: 2 Y: 20 dots</p> 
X/Y	Specify the distance along the X and Y directions for placing copied parts. The unit for these values depends on whether [Dots] or [Line/Column] is selected.
Quantity X/Quantity Y	Specify the number of required copies, including the copy source counted as "1".
Direction	<p>When the [Increment Cursor Movement Order] and [Display Order INC] checkboxes (described below) are selected, the increment order of [Cursor Order INC] and [the device memory] configured for the part is used. When changing the direction, click [Change Direction]. The [Direction Select] window is displayed. Select the desired direction and click [OK] to change to the selected direction.</p> 
Increment Cursor Movement Order	This setting is available when making multiple copies of a data display part for which [Cursor Order INC] is set. To increment the [Cursor Order INC] setting of copies to be made, select this checkbox. The value of [Step] can be set as an auxiliary setting.
Display Order INC	This setting is available when making multiple copies of a switch/lamp part for which [Function] is set to [Mode] or [Recipe Display]. Select this checkbox to increment the [Display Order] setting for the number of copies to be made. The value of [Step] can be set as an auxiliary setting.
Device INC	This setting is available when using a switch, lamp, or data part as the copy source. Specify the device memory of the copy source as the first device memory to allocate consecutive device memory addresses for the number of copies. The following [Device] and [Step] settings become available.
Device memory addresses	Specify the top device memory of the copy source.
Step	Specify the increment (in words or bits) when increasing the device memory consecutively. When [Step] is set to "1", copying is performed by allocating device memory addresses incremented by one word or bit. When [Step] is set to "2", copying is performed by allocating device memory addresses incremented by two words or bits.
File No. +1 Record No. +1	These settings are available when [Memory Card] device memory is selected as the target device memory. Select these checkboxes to increment the file and record numbers.

Setting example

This section provides the procedure to make five copies of a lamp part and place them horizontally using the multiple copy function.

1. Select a lamp and click [Edit] → [Multi-copy].
The [Multi Copy] window is displayed.

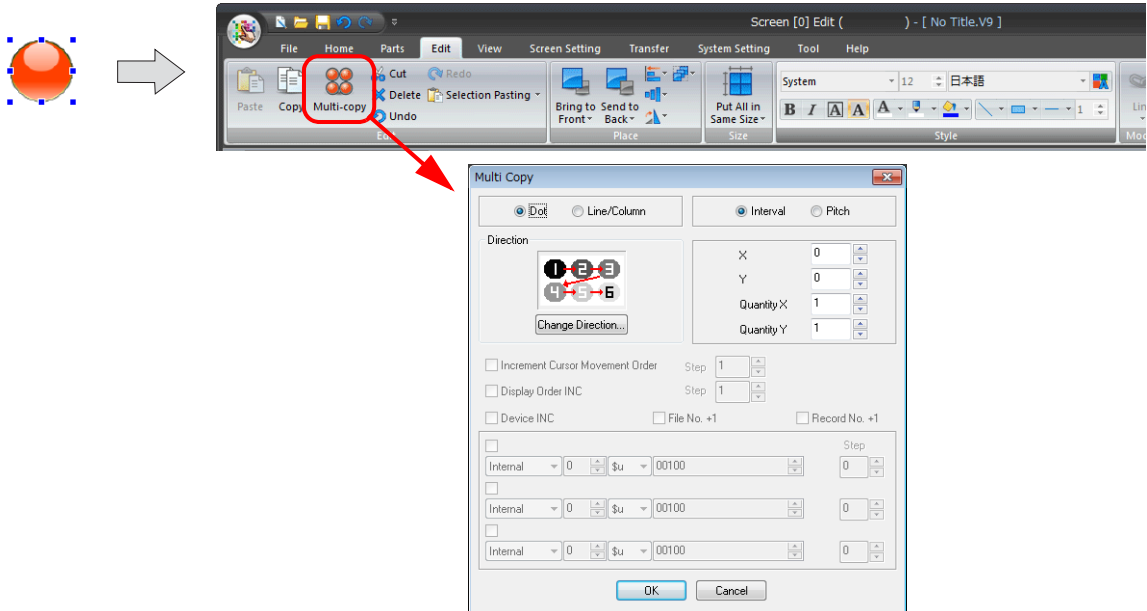

2. Configure the following settings and click [OK].

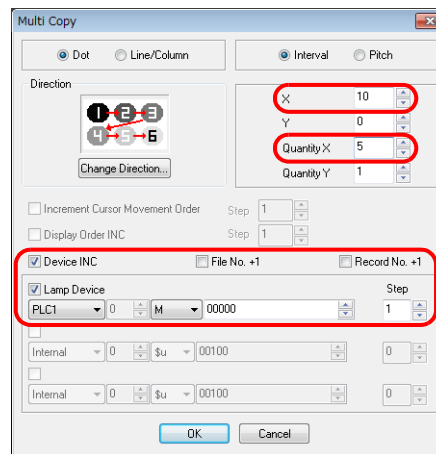

3. Five copied lamps are horizontally placed.

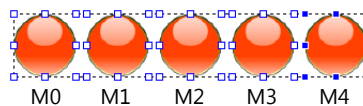

The available settings in the [Multi Copy] window vary depending on the selected parts.
This example only shows the settings for the lamp part.

Selection Pasting

Items selected on one screen can be pasted to multiple screens at the same time. Follow the steps described below.

1. Click items on the screen or drag the mouse to select multiple parts.
2. Click [Edit] → [Selection Pasting].

The following window is displayed.

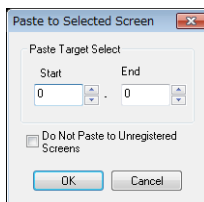

Item	Description
Paste Target Select (Start/End)	Specify the screen numbers to paste the selected item.
Do Not Paste to Unregistered Screens	Select this checkbox when not pasting to unregistered screens. Deselect this checkbox when pasting to unregistered screens.

3. Click [OK]. The paste operation is performed.



If a paste operation is performed on a layer (such as an overlap) where the number of items per screen is limited and the number reaches the limit, the error message "No more Overlap can be registered." is displayed.



Click [Edit] → [Undo Selection Pasting] to cancel any operations performed using the [Paste to Selected Screen] window.

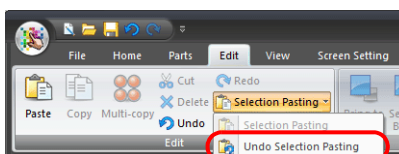

4.1.2 Place

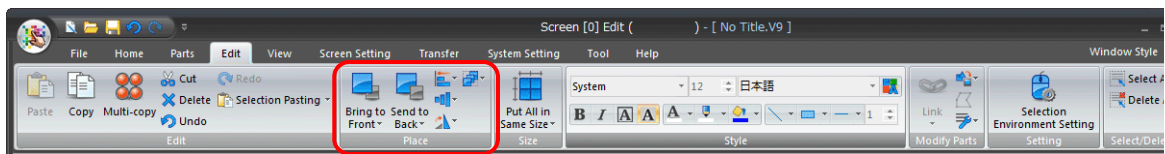



Item		Description	Refer to
Bring to Front	Bring to Front	Move the selected item one layer into the foreground.	-
	Bring to Top	Move the selected item to the top layer of the foreground.	
Send to Back	Send to Back	Move the selected item one layer into the background.	-
	Send to Bottom	Move the selected item to the bottom layer of the background.	
Place	Left End	Arrange items to the left edge of the reference item.	page 4-6
	Horizontal Center	Arrange items to the position of the horizontal center of the reference item.	
	Right End	Arrange items to the right edge of the reference item.	
	Upper End	Arrange items to the top edge of the reference item.	
	Vertical Center	Arrange items to the position of the vertical center of the reference item.	
	Lower End	Arrange items to the bottom edge of the reference item.	
	Align left and right center of the window	Move items to the position of the horizontal center of the window.	
	Align top and bottom center of the window	Move items to the position of the vertical center of the window.	
Arrangement	Horizontal Align (Regular Spacing)	Align items horizontally at equal intervals.	page 4-7
	Horizontal Align (Specified)	Align items horizontally at a specified interval.	
	Vertical Align (Regular Spacing)	Align items vertically at equal intervals.	
	Vertical Align (Specified)	Align items vertically at a specified interval.	
	Switch/lamp Centering	Center the text on switches and lamps.	
Rotate	Rotate 90 degrees CW	Rotate the selected item 90 degrees in the clockwise direction.	-
	Rotate 90 degrees CCW	Rotate the selected item 90 degrees in the counter-clockwise direction.	
	Vertical Flip	Flip the selected item vertically.	
	Horizontal Flip	Flip the selected item horizontally.	
Group	Group	Select multiple items at the same time and then click this command to group them.	-
	Ungroup	Select a grouped item and then click this command to ungroup the items it contains.	

Place (E.g. Left End)

This section explains the procedure for aligning five randomly placed boxes with the leftmost box.

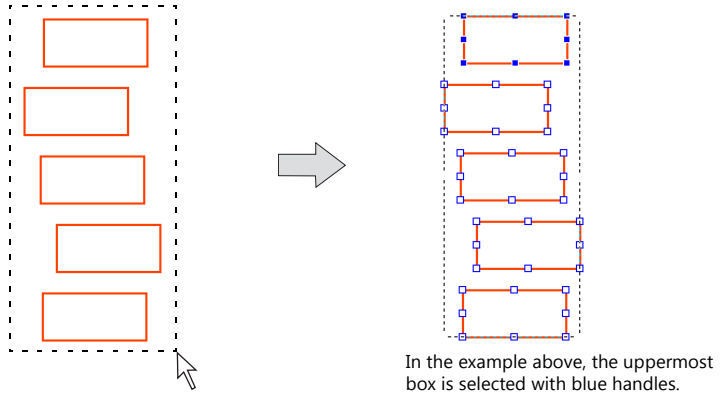
1. Select the five boxes randomly placed at one time.
The reference item for alignment is selected with blue handles.



 When multiple items are selected, the most recently created or placed item is displayed with blue handles.

*** When the leftmost box is displayed with blue handles, proceed to step 3.**

2. Designate the leftmost box as the reference by changing the handle color of the leftmost box to blue. Click the leftmost box while holding down the [Ctrl] key.
The handles of the leftmost box turn blue.

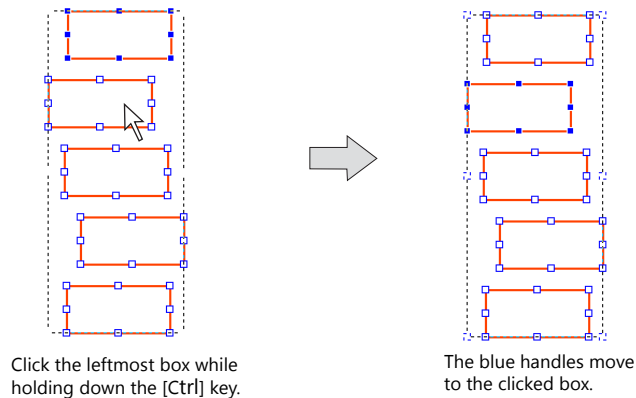

3. Click [Edit] → [Place] → [Left End].
All of the boxes are left-aligned with reference to the box with blue handles.

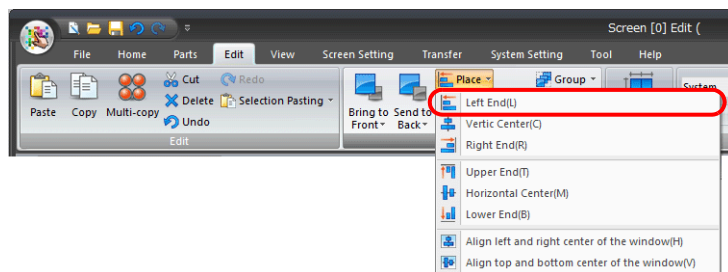

Arrangement (E.g.: Vertical Align)

This section explains the procedure for vertically arranging numerical data display parts at equal intervals.

1. Select the five numerical data display parts placed as shown below at once.

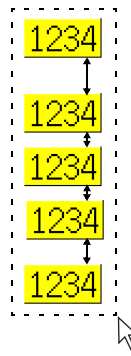

2. Click [Edit] → [Arrangement] → [Vertical Align (Regular Spacing)].

The numerical data display parts are arranged at equal intervals within the selected area.

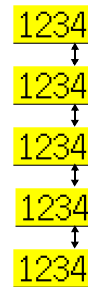
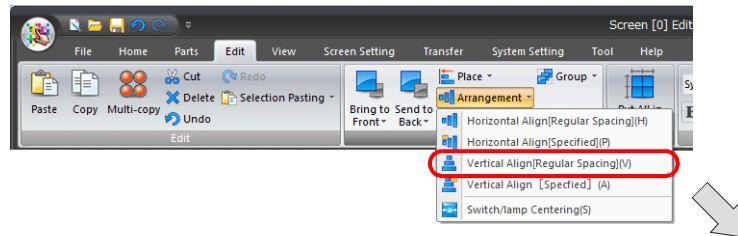

To arrange parts equally at a specified interval instead of within the range of the selected area, click [Vertical Align (Specified)]. (Specify the pitch size.)

[Vertical Align (Regular Spacing)]

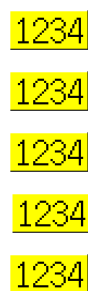

Arranged at equal intervals within the selected area

[Vertical Align (Specified)]

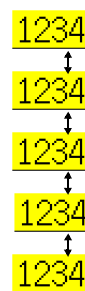

Arranged equally at the specified interval

4.1.3 Size

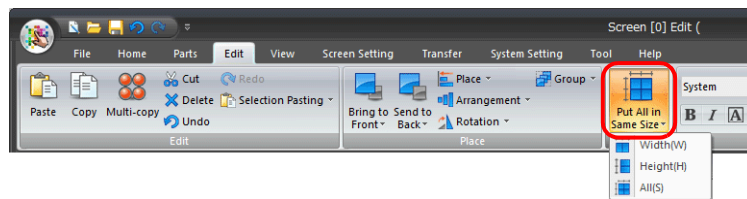

Item		Description	Refer to
Put All in Same Size	Width	Match the width of items to the reference item.	page 4-8
	Height	Match the height of items to the reference item.	
	All	Match the overall size of items to the reference item.	

Setting Example

As an example, this section explains how to resize parts to the same width.

1. Select all of the placed parts at once. The reference item for alignment is selected with blue handles.



2. Click [Edit] → [Put All in Same Size] → [Width]. All of the parts change to the width of the part enclosed with blue handles.

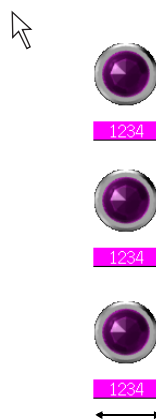

4.1.4 Style

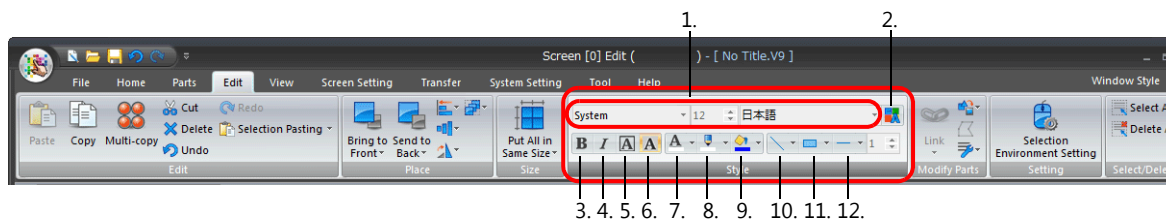

	Item	Description	Refer to
1	Font Name	This setting is available when selecting Windows font text. Change the font.	-
	Points	This setting is available when selecting Windows font text. Change the text point size.	-
	Character Set	This setting is available when selecting Windows font text. Select the character set of the font.	-
2	Windows Font	Add Windows font properties.	-
3	Bold	Change the text to bold face.	-
4	Italic	Change the text to italic face.	-
5	Transparent	Set the background color of text to transparent.	-
6	Not Transparent	Display the text background color.	-
7	Character Color	Change the text color. Click the ▼ icon to select a color.	-
8	Line Color/Frame Color	Change the line color and frame color. Click the ▼ icon to select a color.	-
9	Paint Color/Back Color	Change the paint color and background color. Click the ▼ icon to select a color.	-
10	Arrow Type	Select the line end shape. Click the ▼ icon to select a shape.	page 4-9
11	Line Type	Select the line type. Click the ▼ icon to select a type.	page 4-9
12	Frame Type	Select the frame type of rectangles and circular parts. ▼ Click the icon to select the type.	page 4-10

Arrow Type

Select a type from the following.

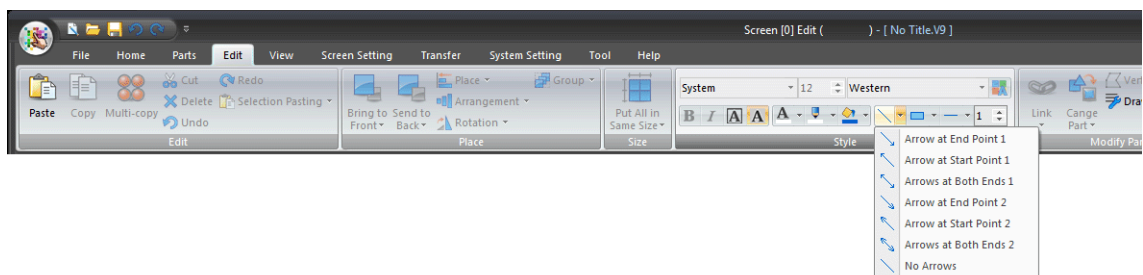

Line Type

Select a type from the following. These can be selected for lines, rectangles, and circular parts.

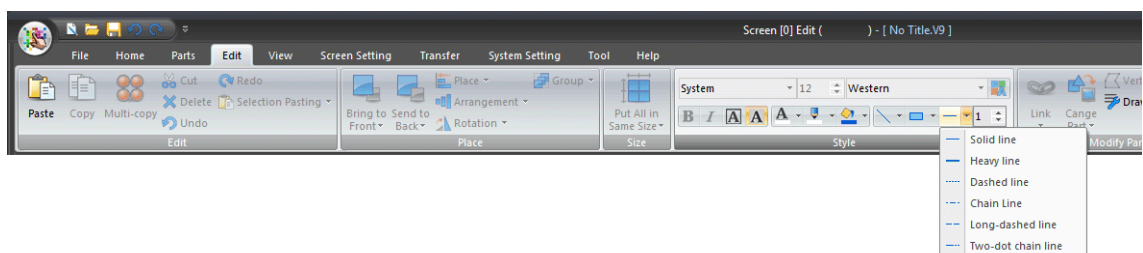

- [Heavy line] cannot be used with parts other than lines and rectangles.
- The line type is fixed to [Solid line] for the following parts. Chamfered rectangles (round chamfering, chamfering) as well as parallelograms, polygons, circles, sectors, ellipses with [With Frame (Paint)] specified

Frame Type

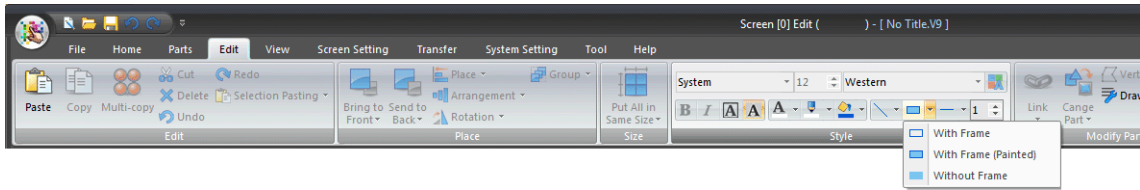

Item	Description
With Frame	Frame only type. The area within the frame is transparent.
With Frame (Painted)	The area inside of the frame is painted for this type.
Without Frame	Area only type without a frame.

4.1.5 Modify Parts

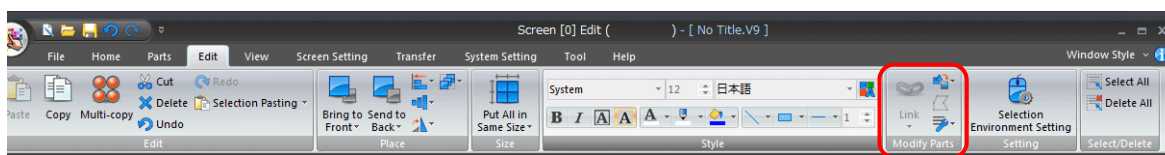

Item		Description	Refer to
Link	Link	Link or cancel the link between selected parts.	page 3-14
	Link Cancel		
Modify Parts	Change to Switch	Change a graphic part into a switch part.	page 4-11
	Change to Lamp	Change a graphic part into a lamp part.	
	Change to Multi-Text	Change a text part into a multi-text part.	
	Modify Part	Change the design of drawn parts by editing them yourself.	page 11-10
	Frame Auto Fit	Reset the frame of a part.	
	Different Start and End Angles	This command is available for round graphs other than circles. Use this command to change placed parts.	
	Same Start and End Angles	Change non-circle round graphs to circles. Use this command to change placed parts.	
	Symmetrical Start/End Angles	This command is available for round graphs other than circles. Use this command to change placed parts.	
	With Internal Circle	Change the display of a circle graph to a doughnut shape. Use this command to change placed parts.	
	Paint Position Setting	This command is available for closed area graphs. Use this command to change placed parts.	
Fit Area to Graphic	This command is available for closed area graphs. Use this command to change placed parts.		
Vertex Edit		This command is available for continuous line and polygon parts. The position of each point can be changed on continuous lines. The angular position and radius can be changed for polygons.	page 3-50
Drawing Method	Polygon	Select the drawing method for polygons.	page 3-55
	Circle	Select the drawing method for circles.	page 3-57
	Arc	Select the drawing method for arcs.	page 3-59
	Ellipse	Select the drawing method for ellipses.	page 3-62
	Elliptical Arc	Select the drawing method for elliptical arcs.	page 3-63

Change to Switch / Change to Lamp

Drawing items can be easily changed to a switch or lamp part. In addition, changing a switch part to a lamp part or vice versa is possible.

As an example, this section explains how to change a circle into a lamp part.

1. Click on a circle.

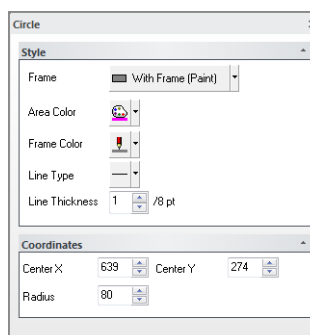
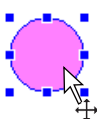

2. Click [Edit] → [Change Part] → [Change to Lamp].

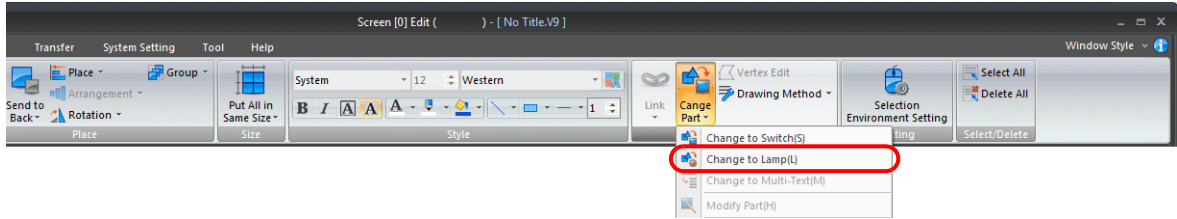

3. The circle becomes a lamp part.

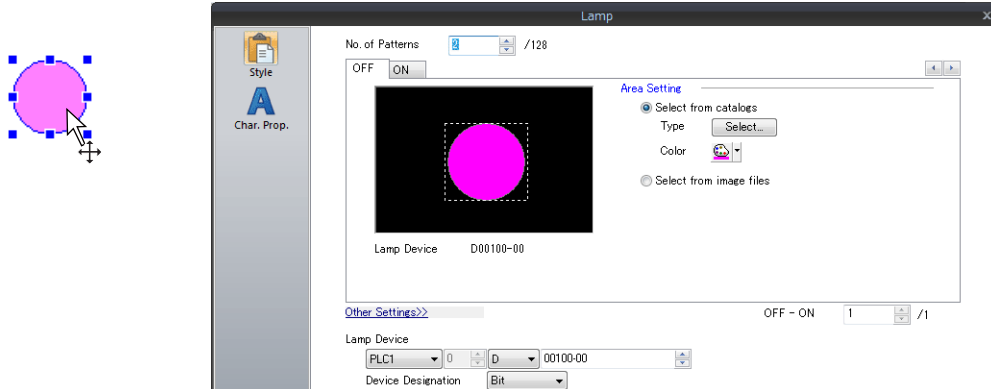

☹️ These commands only create the ON and OFF patterns of switch and lamp parts. For a switch or lamp with three or more patterns (available for three or more notches), the additional patterns must be created separately. For more information on the editing procedure for OFF, ON, and P3 and subsequent patterns, refer to “11.3 Changing Placed Parts” page 11-10.

Change to Multi-Text

Change a text part into a multi-text part.

1. Click on the placed text part.



2. Click [Edit] → [Change Part] → [Change to Multi-Text].

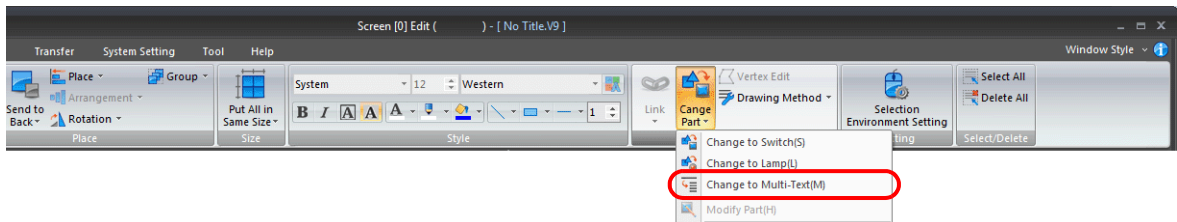

3. The selected text part changes into a multi-text part.

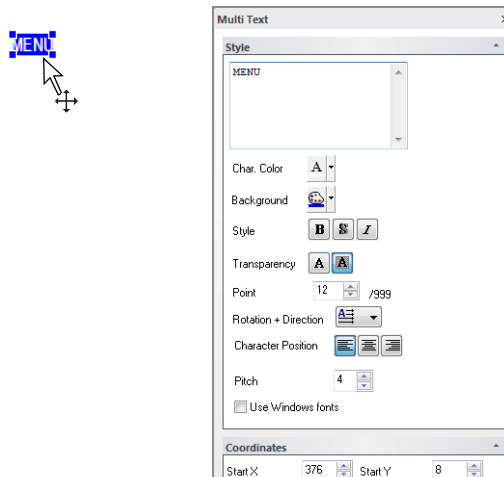

Modify Part

Use this icon to change the design of a placed part by editing it yourself.

1. Click to select a placed part and then click [Edit] → [Change Part] → [Modify Part] as shown below.

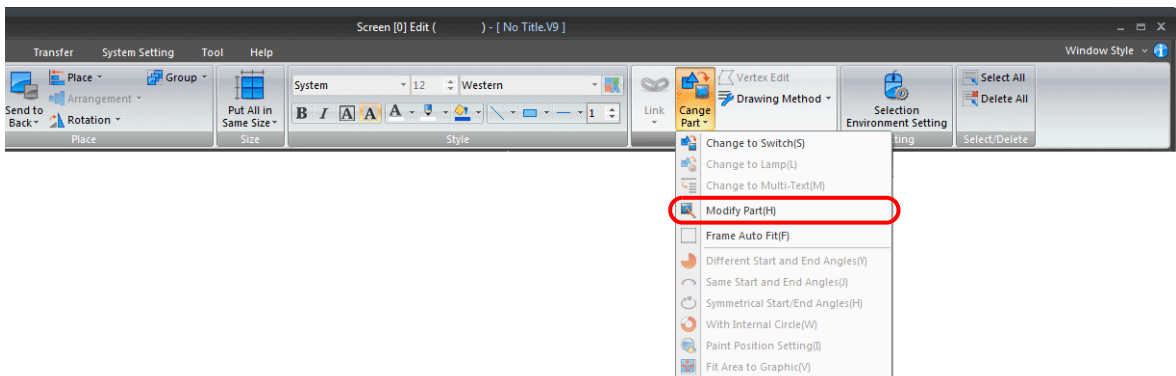

2. The [Modify Part] tab window is displayed.
Use drawing items and other tools to change the part to a suitable design.

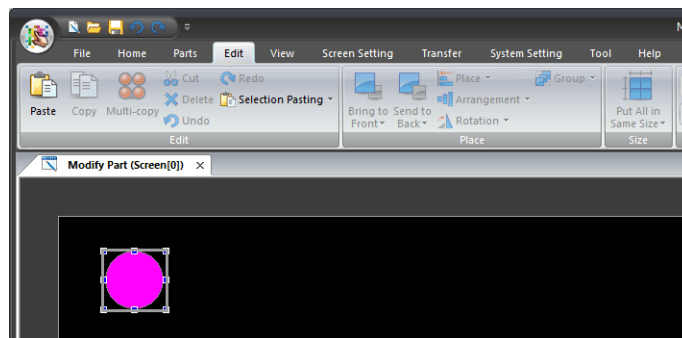

When modifying a switch or lamp part, click [View] → [ON] and [OFF] to change the status display and edit each pattern.

3. Once part editing is complete, click [Edit] → [Change Part] → [Frame Auto Fit] to reset the part frame.

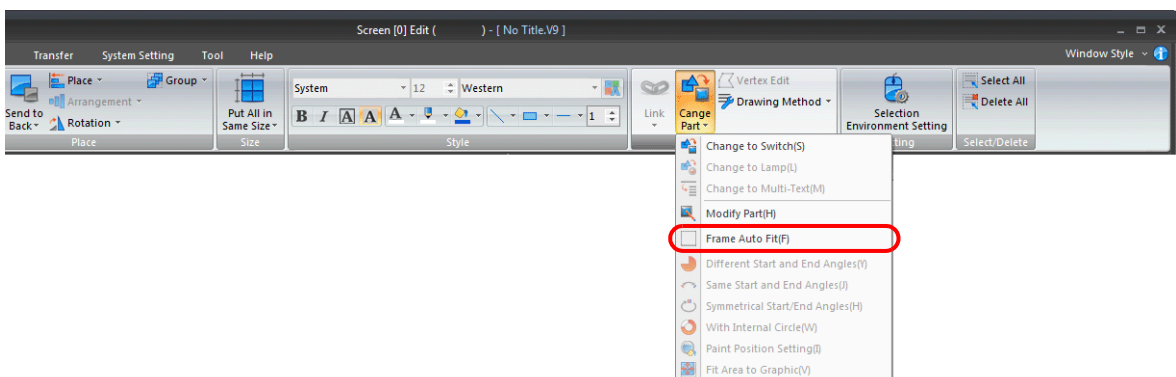

4. When editing is complete, click the [X] mark on the [Modify Part] tab window title or click the [Modify Part] icon again. The previous screen reappears.



For more information on editing each type of part, refer to "11.3.4 Editing Parts" page 11-13.

4.1.6 Selection Environment Setting

Restrictions can be placed on the items that can be selected with the mouse.

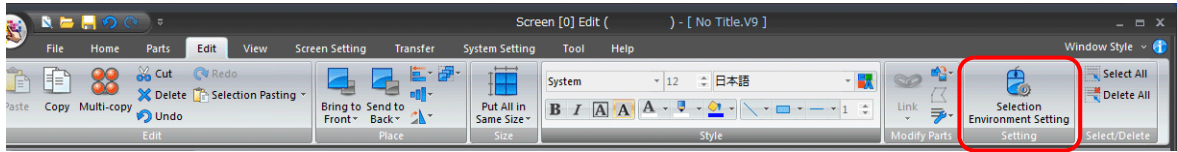

Settings

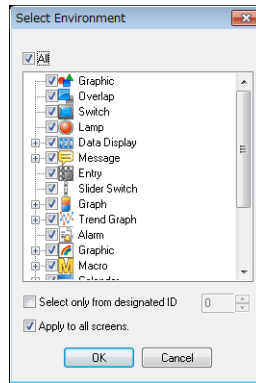

Item	Description
All	Selected: All items can be selected with the mouse. Unselected: Only the items with a selected checkbox can be selected.
Checkbox items	Only items with a selected checkbox can be selected with the mouse. Multiple checkboxes can be selected.
Select only from designated ID	Select this checkbox to specify an ID. Only items with the specified ID can be selected with the mouse.
Apply to all screens	Select this checkbox and click [OK] to specify the items that can be selected with the mouse on all screens.

4.1.7 Select/Delete

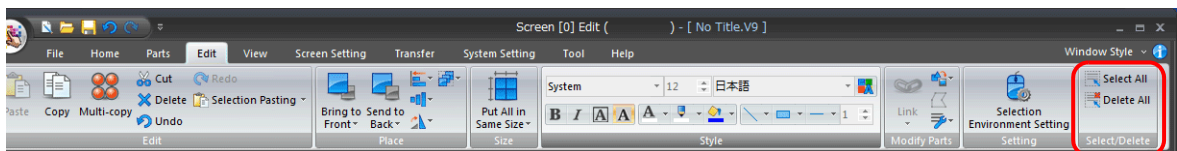

Item	Description
Select All	Select all displayed parts on the screen.
Delete All	Delete all displayed parts on the screen. Clicking this command displays the following dialog box. <div data-bbox="836 1615 1069 1771" data-label="Image"> </div> Click [Yes] to delete all of the displayed items from the screen.

4.1.8 Right-click Menu

The right-click menu is registered with frequently used editing and display tools.

Menu Display When No Items are Selected

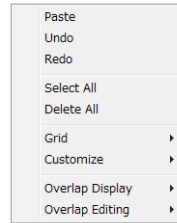

Item	Description	Refer to
Paste	Paste the item on the clipboard to the screen.	-
Undo	Restore the screen to the state before the last action was performed.	-
Redo	This command becomes available when [Undo] is performed. Click this button to restore the screen to the state before [Undo] was executed.	-
Select All	Select all of the placed items displayed on the screen.	page 4-14
Delete All	Delete all of the items displayed on the screen.	
Grid	Change the grid display settings.	page 4-26
Customize	Change settings such as center line display and device memory display.	page 4-28
Overlap Display	Show or hide overlaps.	
Overlap Editing	Enter overlap editing mode.	

Menu Display When Items are Selected

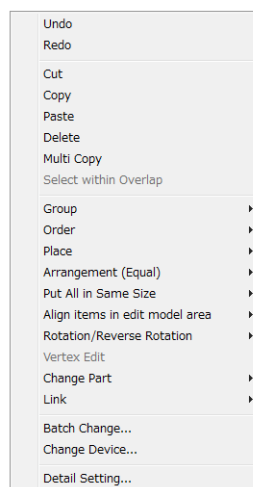

Item	Description	Refer to
Undo	Restore the screen to the state before the last action was performed.	-
Redo	This command becomes available when [Undo] is performed. Click this button to restore the screen to the state before [Undo] was executed.	-
Cut	Cut the selected item and move it to the clipboard.	-
Copy	Copy the selected item to the clipboard.	-
Paste	Paste the item on the clipboard to the screen.	-
Delete	Delete the selected item.	-
Multi Copy	Create multiple copies of the selected item at once.	page 4-1
Select within Overlap	Use this command to select multiple items on an overlap by dragging the mouse.	page 3-19
Group	Click this command to group multiple items that are selected at the same time. To cancel the grouping, select the grouped items and click [Ungroup].	-
Order	Displays the four sub-menu commands of [Bring to Front], [Send to Back], [Bring to Top], and [Send to Bottom]. The selected item on the screen is moved according to the selected command.	-
Place	Align the placement position of selected items.	page 4-5
Arrangement (Equal)	Arrange the selected items.	

Item	Description	Refer to
Put All in Same Size	Match the size of selected items.	page 4-8
Align items in edit model area	Place the selected items along the vertical center or horizontal center of the editing area.	page 4-5
Rotation/Reverse Rotation	Displays the four sub-menu commands of [Rotate 90 degrees CCW], [Rotate 90 degrees CW], [Horizontal Flip], and [Vertical Flip]. The selected item is rotated or flipped according to the selected command. (This command only applies to drawing items, except for text).	-
Vertex Edit	This command is available for continuous line and polygon parts. The position of each point can be changed on continuous lines. The angular position and radius can be changed for polygons.	page 3-57
Change Part	Change the selected part. Displays the sub-menu commands of [Change to Switch], [Change to Lamp], [Change to Multi-Text], [Modify Part], and [Frame Auto Fit].	page 4-11
Link	Link or cancel the link between selected parts.	page 3-14
Batch Change	Perform a batch change of properties, such as text, line color, and text size, of multiple selected items.	page 4-16
Change Device	Perform a batch change of device memory addresses set to multiple selected items.	page 5-30
Detailed Setting	Perform a batch change of function and device memory settings of multiple selected parts of the same type.	page 4-17

Batch Change

Perform a batch change of properties, such as text, line color, and text size, of multiple selected drawing parts.

Setting method

Select multiple parts and right-click → [Batch Change].
The [Batch Change] window is displayed.

[Char. Prop.]

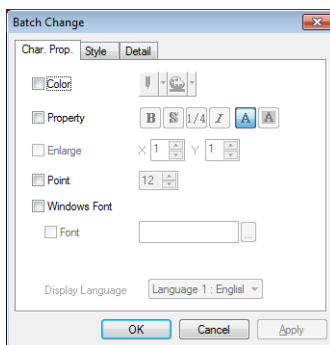

Item	Description
Color	Select the color and background color of text.
Property	Set text properties such as text thickness, shadow, italics, and transparency.
Enlarge	Change the size of text. This setting is available when using a bitmap font.
Point	Change the size of text. This setting is available when using a TrueType font or Windows font.
Windows Font	Select this checkbox to allow changing of the Windows font. Windows font changes are possible on a language basis by switching the interface language on the screen.

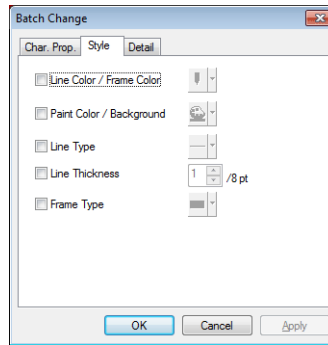
[Style]

Item	Description
Line Color/Frame Color	Select the line and frame color of the drawing items.
Paint Color/Background	Select the paint and background color of the drawing items.
Line Type	Select the line type of the drawing items.
Frame Type	Select the frame type of the drawing items.

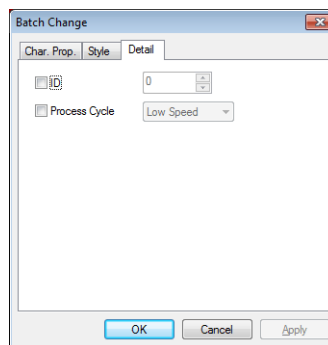
[Detail]

Item	Description
ID	Change the ID number of the graphic items.
Process Cycle	Change the process cycle.

Detail Setting

Perform a batch change of function and device memory settings when multiple parts, such as switches, are selected. The part types that can undergo batch changes are listed below.

Switches, lamps, data displays (numerical display, character display, message display), graphs (bar graph, pie graph, closed area graph, panel meter, statistic bar graph, statistic pie graph)

Setting method

Select multiple parts and right-click → [Detail Setting].

When multiple switches are selected, the following window is displayed.

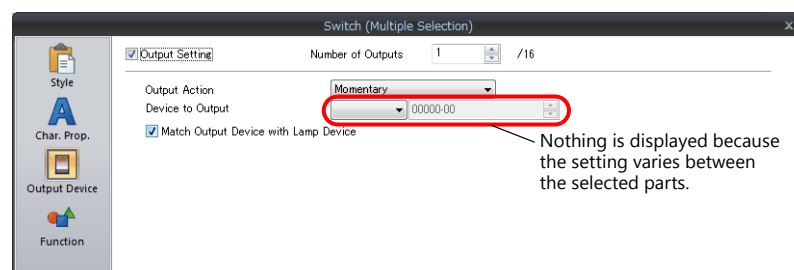

4.2 View Menu

4.2.1 Display Change

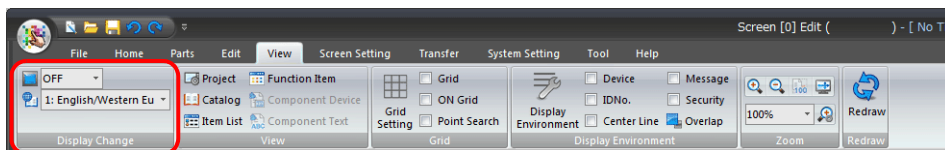

Item	Description
State Change	Change the display status of switch and lamp parts (OFF/ON/P3, etc.)
Language Display	Change the display language using the pull-down menu.

4.2.2 View

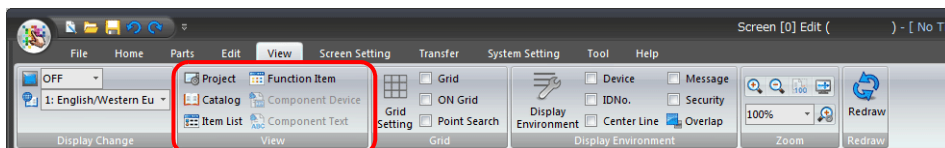

Item	Description	Refer to
Project	Show or hide the [Project] view window.	page 4-18
Catalog	Show or hide the [Catalog] view window.	page 4-20
Item List	Show or hide the [Item List] view window.	page 4-21
Function Item	Show or hide the [Function Item] view window.	page 4-24
Component Device	This command is available when editing component parts. Show or hide the component device view window.	page 11-42
Component Text	This command is available when editing component parts. Show or hide the component text view window.	page 11-45

[Project View] Window

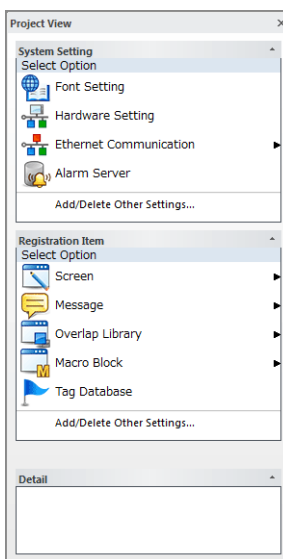

Item	Description
System Setting	Displays the system setting items.
Registration Item	Displays the registered item settings.
Add/Delete Other Settings	Add items that are not displayed to the project list view window. Click to display a menu. Select the checkbox of items to display in the view window. Deselecting checkboxes removes the corresponding items from the view window.
Detail	Displays details on the selected item.

Example: Hardware Setting

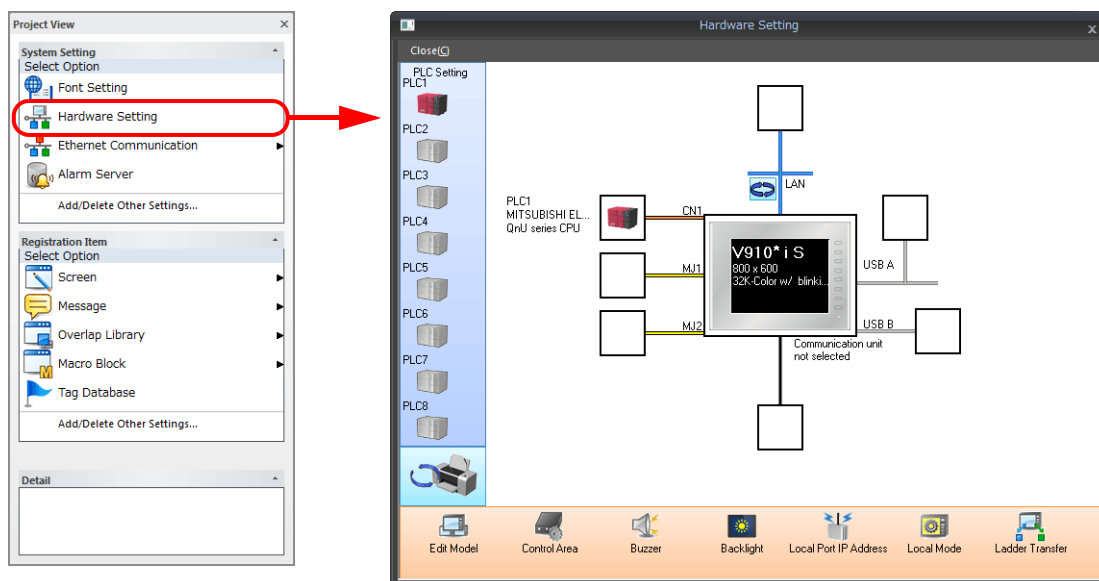

Double-click to display the [Hardware Setting] window.

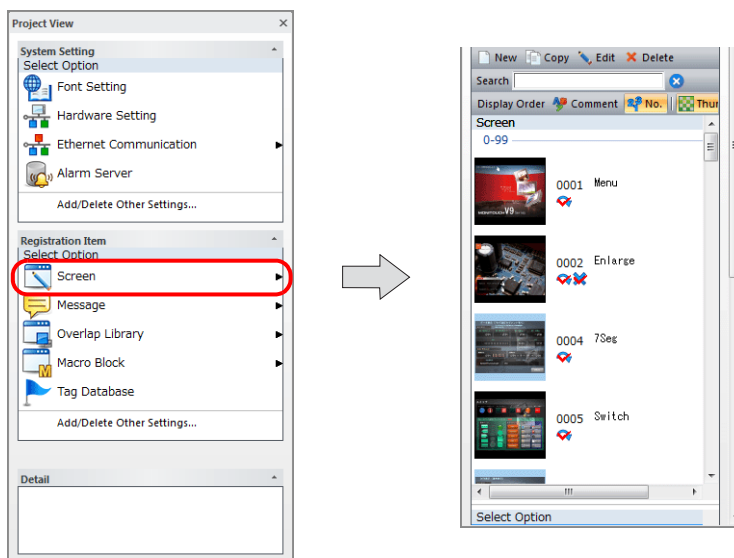

Example: Screen

Double-click to display the screen menu in the project list view window with a list of registered screens.



Item	Description	
New	Click to create a new screen.	
Copy	Select a screen from the list and click [Copy] to copy the screen.	
Edit	Select a screen from the list and click [Edit] to display the selected screen.	
Delete	Select a screen from the list and click [Delete] to delete the selected screen.	
Search	Find screens by searching the screen comments.	
Display Order	Comment	Display the list in the order of comments.
	No.	Display the list in the order of screen numbers.
Thumbnail Display	Click to display a list of thumbnail images (button ON state). Click again to cancel the thumbnail display (button OFF state).	
Screen	Displays a list of screens. The set status of comments and macros is displayed for each screen. Double-click on a screen to display it. * The following symbols are displayed when screen macros are registered.  : Open Macro  : Close Macro  : Cycle Macro	

Catalog View Window

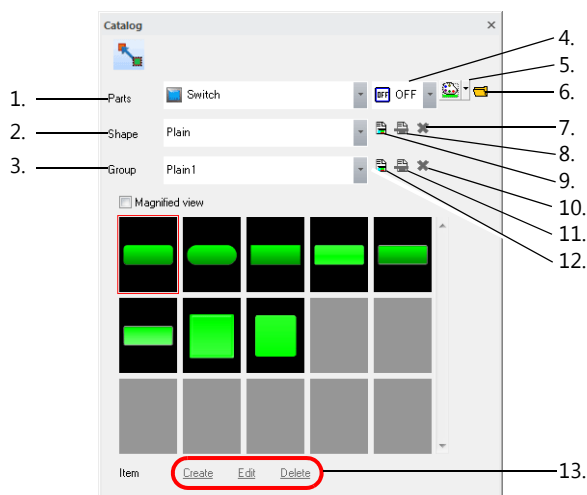

Item	Description	Refer to	
1	Parts	Select the type of part to place.	-
2	Shape	Select the part shape.	-
3	Group	Select a part group.	-
4	Pattern change	Change the display state of switches and lamps.	-
5	Color selection	Change the part color.	-
6	Open file	Click to select a screen program file (*.V9/*.V8). If the desired parts are unavailable, parts can be imported from other screen programs.	-
7	Register custom shape	Select this button to create new parts.	page 11-6
8	Change shape name	Register the shape name of new parts.	
9	Delete selected shape	Delete the selected shape.	
10	Register custom group	Select this button to create a custom group when creating new parts.	
11	Change group name	Register a group name for a custom group.	
12	Delete group	Delete the selected custom group.	
13	Create	This command can be selected when a custom shape is registered. Click to display the [Change the image] window.	
	Edit	This command can be selected when a custom shape is registered. Edit the selected part.	
	Delete	This command can be selected when a custom shape is registered. Deletes the selected part.	

Item List

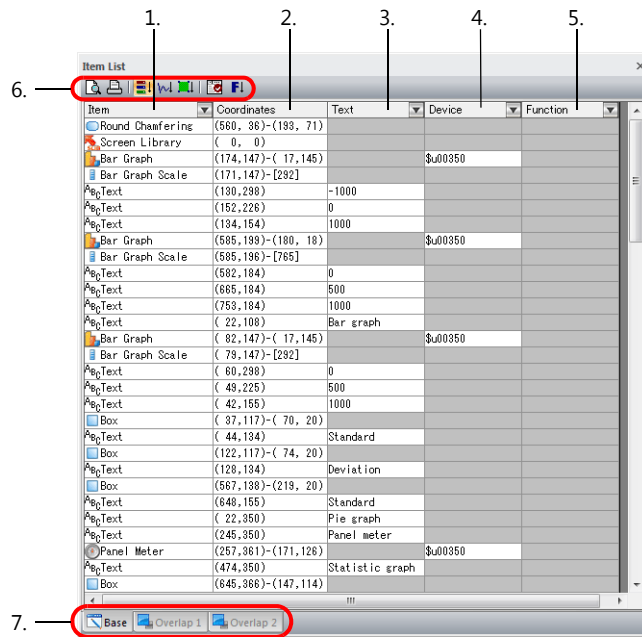

Item	Description
1	Item
2	Coordinates
3	Text
4	Device
5	Function
6	Icon menu
7	Tabs

Items for which the item show/hide function is not set to "show" are displayed in green, yellow, or light blue. Items set to "show" are displayed in white.

- Yellow: security level
- Light blue: hidden
- Green: device memory designation

Icon menu



Item	Description
1	Print Preview
2	Print Current Window
3	By Registration
4	By Graphic
5	Selected Item
6	Display Setting
7	By Function

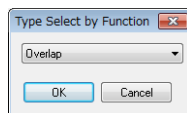

Operation Method

Changing text

The text assigned to items can be changed in the [Text] column in the item list.

Switch and lamps

1. Double-click the [Text] cell of the target text or multi-text item.

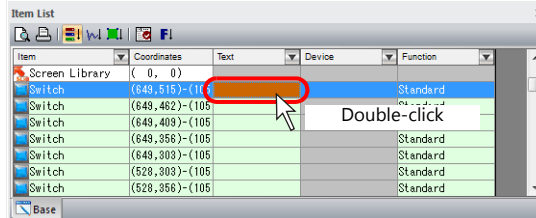

2. Text entry is enabled. Enter text as desired.

The maximum number of characters per line varies depending on the size of the target switch or lamp.

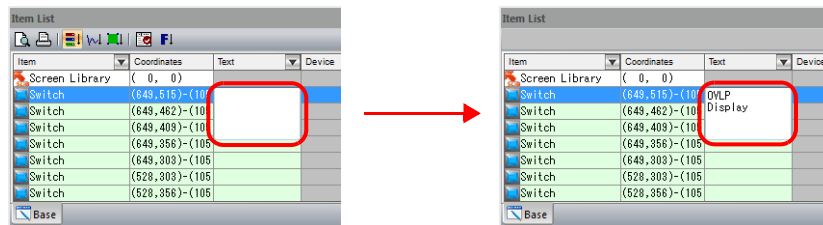

Text and multi-text

1. Double-click the [Text] cell of the target text or multi-text item.

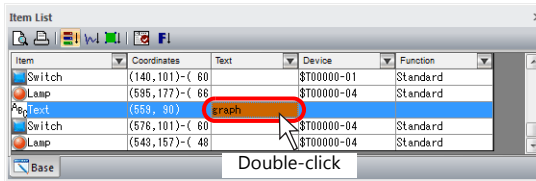

2. Text entry is enabled. Enter text as desired.

Text

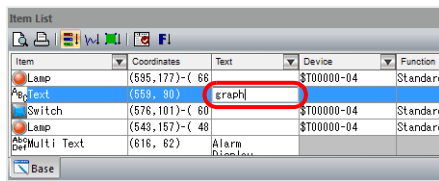

Multi-text

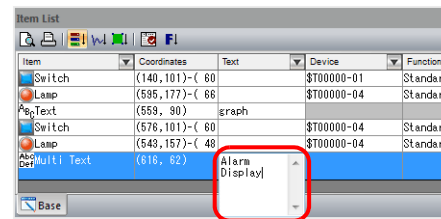

Changing Device Memory

The device memory assigned to items can be changed in the [Device] column in the item list.

1. Double-click the [Device] cell of the target item.

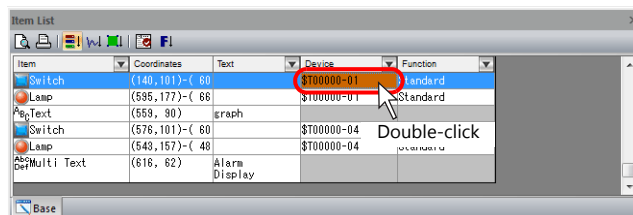

2. The device memory setting fields are displayed. Change the device memory values as required.

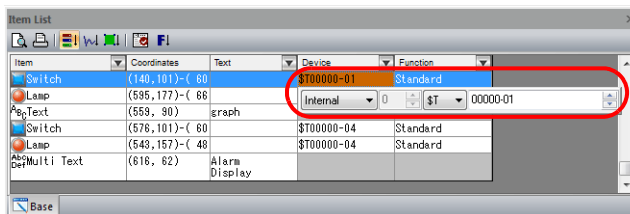

Only the output device memory can be set for switches.

Changing Coordinates

The coordinates of items can be changed in the [Coordinates] column in the item list.

1. Double-click the [Coordinates] cell of the target item.

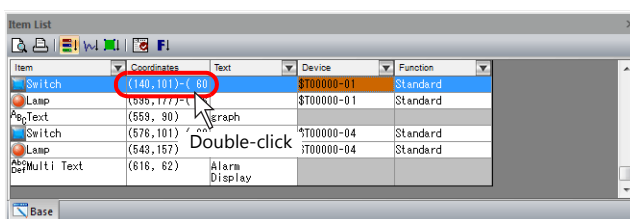

2. The coordinate setting fields are displayed. Change the coordinates as required.

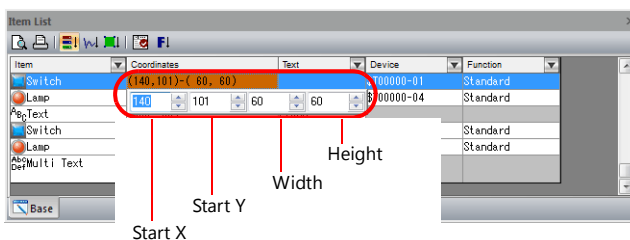

The coordinate setting fields vary depending on item type.

- Example:
- Switch and lamp: start point X, start point Y, width, and height
 - Numerical display: start point X and start point Y
 - Line: start point X, start point Y, end point X, and end point Y

Displaying the Item Settings Window

Changes to item settings, except for [Text], [Device], and [Coordinates], can be performed in the item settings window.

1. Double-click the [Item] or [Function] cell of the desired item or click [Detail Setting] in the right-click menu of the item.

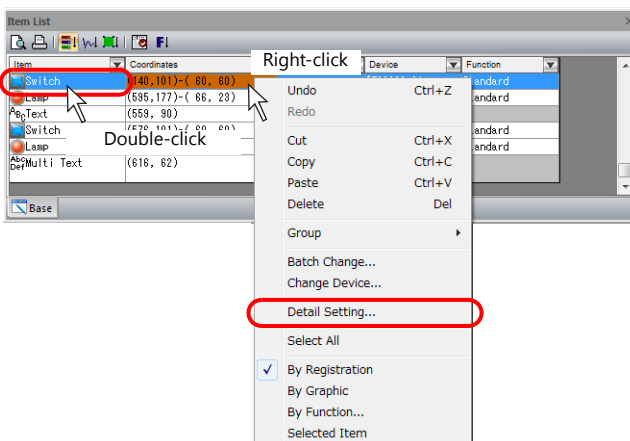

2. The item settings window is displayed. Change the settings.

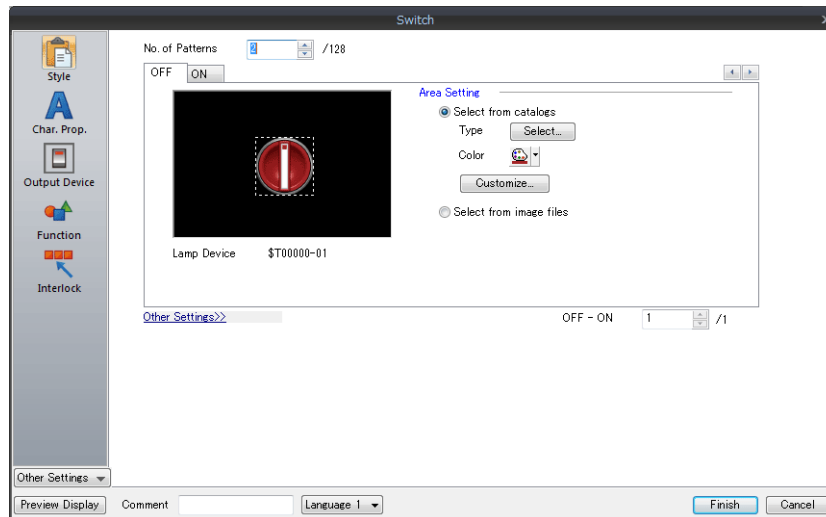

[Function Item] View Window

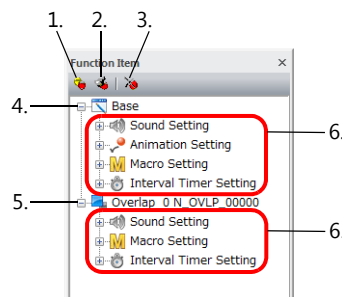

Item	Description	
1	Copy	Copy the selected setting.
2	Paste	Paste the selected setting.
3	Delete	Delete the selected setting.
4	Base	Display settings registered to the base screen.
5	Overlap	Display settings registered to overlaps.
6	Sound Setting	Display the registration state of sound settings.
	Animation Setting	Display the registration state of animation settings.
	Macro Setting	Display the registration state of macro settings.
	Interval Timer Setting	Display the registration state of interval timer settings.

Operation method

This section explains how to operate the function item view window using the sound settings as an example.

Creating a new setting

1. Click the [+] mark next to [Sound Setting] and then double-click [New].

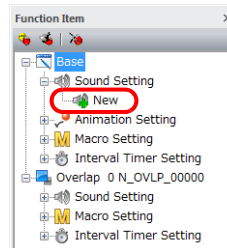

2. An item settings window is displayed. Configure the required settings and click [Finish].

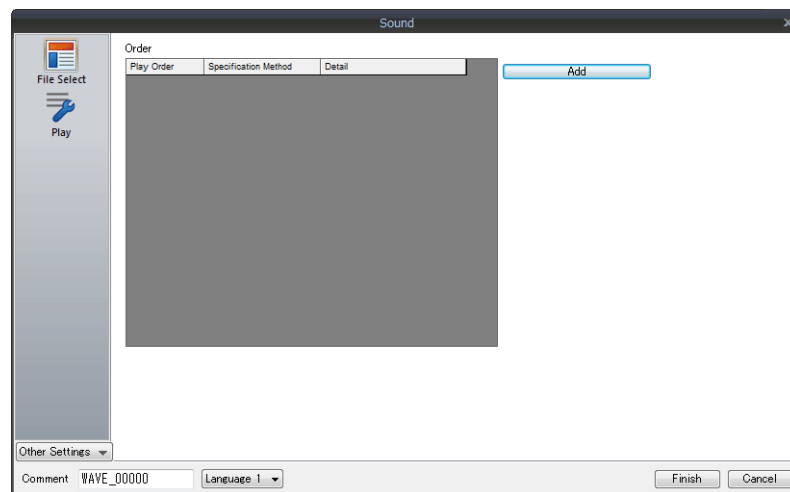

3. Settings are added under [Sound Setting] in the [Function Item] view window.

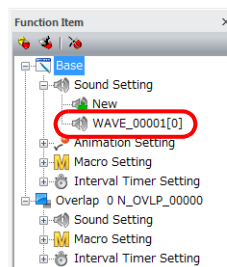

Copying and pasting settings

1. Select the item to copy and click the copy icon.

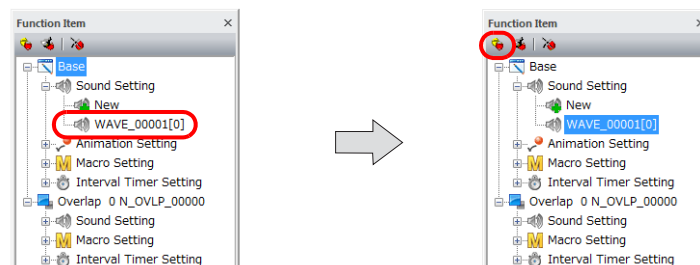

2. Click the paste icon to paste the selected item.

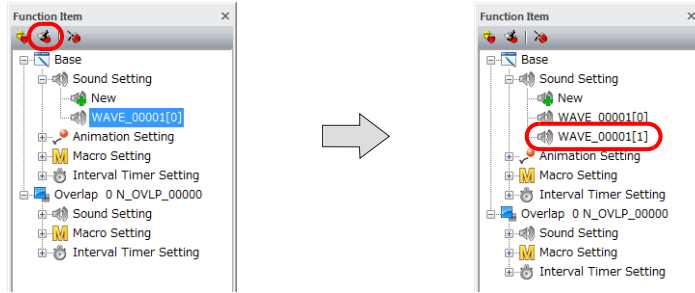

4.2.3 Grid

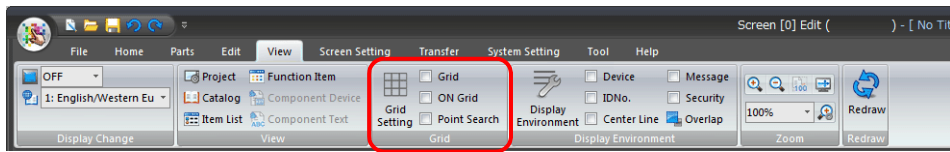

Item	Description	Refer to
Grid Setting	Display the [Grid Setting] window. Configure settings such as grid color and grid interval.	page 4-26
Grid	Select this checkbox to display a grid.	-
ON Grid	Select this checkbox to snap parts to the grid when moving or changing parts. * Overlap displays do not snap to the grid.	-
Point Search	Select this checkbox to assign the handle closest to the dragged point of each item as the reference point.	-

[Grid Setting] Window

[Grid] tab

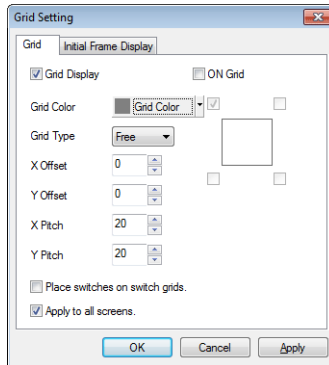

Item	Description
Grid Display	Select this checkbox to display a grid. Deselecting this checkbox clears the grid from the screen.
ON Grid	Select this checkbox to snap parts to the grid when moving or changing parts. (Note that overlap displays do not snap to the grid.) The following setting becomes available when the [ON Grid] checkbox is selected. Set where parts snap to the grid when parts are moved. <div style="display: flex; align-items: center;"> <div style="margin-right: 10px;"> <input checked="" type="checkbox"/> ON Grid <input checked="" type="checkbox"/> </div> <div> Parts snap to the upper left area of the grid. </div> </div>
Grid Color	Select the grid color.

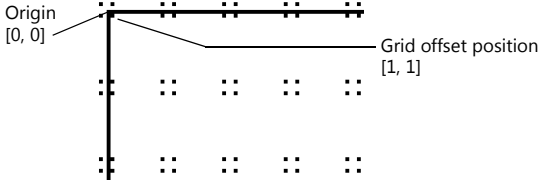
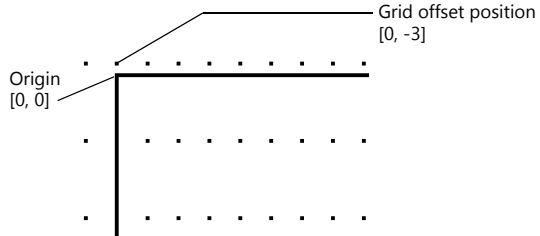
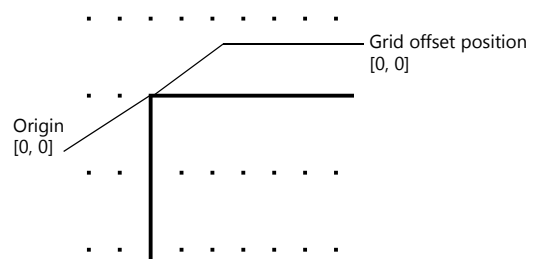
Item	Description
Grid Type (Free/Switch/1-Byte/Mode)	<p>Select the grid type.</p> <p>[Free] Freely set a grid.</p> <p>[Switch] This grid is used for the matrix type switch. The grid is based on the unit: 16 × 20 dots (the minimum unit of switches: 14 × 18 dots plus spaces: 2 × 2 dots). The reference point is placed at the coordinates (1, 1).</p>  <p>[1-Byte] The grid is based on the unit: 8 × 20 (the unit of one-byte characters: 8 × 16 dots plus four Y-axis dots). The reference point is placed at coordinates (0, -3).</p>  <p>[Mode] The mode grid is equivalent to the one-byte character grid, but its offset position differs. The mode grid is based on the unit: 8 × 20 dots. The reference point is placed at the origin (0, 0). Lines and columns are used to indicate item positions. *1</p> 
X Offset *2 Y Offset	<p>These settings are available when [Free] is selected for [Grid Type]. Specify the offset coordinates. The offset coordinate can be specified or changed via right-click → [Grid] → [Grid Offset Position].</p>
X Pitch *2 Y Pitch	<p>These settings are available when [Free] is selected for [Grid Type]. Specify each pitch.</p>
Place switches on switch grids.	<p>Select this checkbox to move or change switches based on the switch grid, irrespective of the grid setting.</p>
Apply to all screens	<p>Select this checkbox to apply the grid settings to all screen editing windows.</p>

*1 Lines and columns

Lines and columns are the units used for the display coordinates of overlap displays, grid (when [Grid Type] is [Mode]), and the placement interval of items when performing a multi-copy operation.

1 column = 8 dots

1 line = 20 dots

*2 Relationship between "offset" and "pitch"

As an example, the following grids are displayed for the respective settings when [Grid Type] is set to [Free].

Ex. 1)
[X Offset]: 0
[Y Offset]: 0
[X Pitch]: 20
[Y Pitch]: 20

Ex. 2)
[X Offset]: 10
[Y Offset]: 10
[X Pitch]: 20
[Y Pitch]: 20

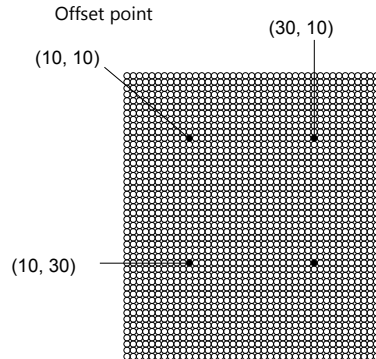
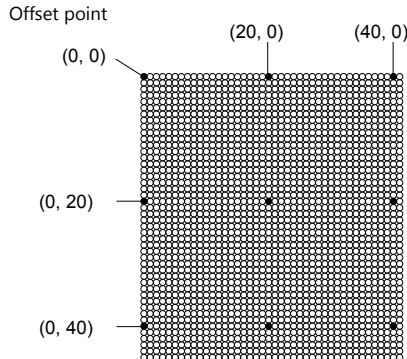

[Initial Frame Display] tab

The settings on this tab are available when using the function for enlarging the screen size. The display frame color of the initial display area in the screen configuration software can be changed.

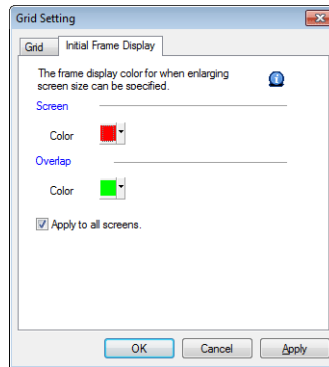

Item	Description
Screen	This setting is available when using an enlarged screen. Set the frame color of the initial display area.
Overlap	This setting is available using an enlarged overlap. Set the frame color of the initial display area.
Apply to all screens	Select this checkbox to apply the settings to all screen editing windows.



For more information on the screen size enlargement function, refer to V9 Series Reference Manual 2.

4.2.4 Display Environment

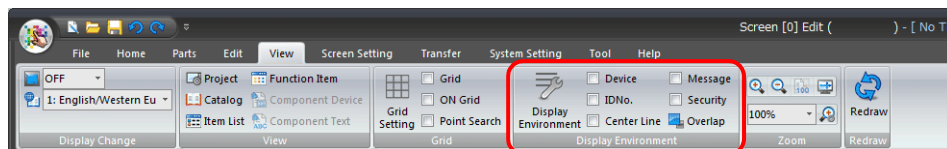

Item	Description	Refer to
Display Environment	Display the [Display Environment] window. Configure the display environment for screen configuration.	page 4-29
Device	Select this checkbox to display device memory addresses on items placed on the screen.	page 4-29
IDNo.	Select this checkbox to display ID numbers on items placed on the screen.	page 4-30
Center Line	Select this checkbox to display center lines.	-
Message	Select this checkbox to display the messages set for parts such as alarm parts on the editing screen.	-
Security	Select this checkbox to display security levels on placed items.	page 4-30

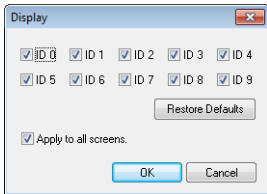
Item	Description	Refer to
Overlap	<p>Click this command to display the following overlap display window.</p>  <p>Select the required overlap ID checkboxes and click [OK] to display the overlaps with selected checkboxes on the screen.</p>	-



Display Environment Settings

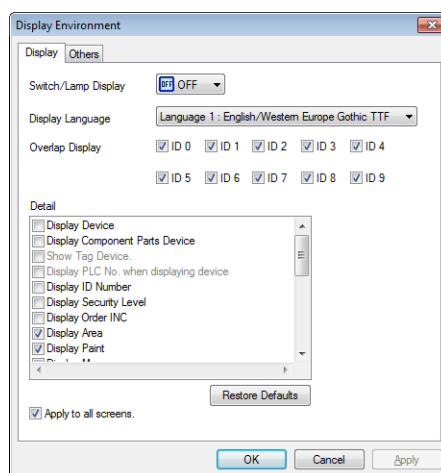

The screen display environment can be configured all at once.

Click [View] → [Display Environment]. The [Display Environment] window is displayed.

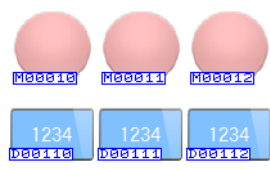
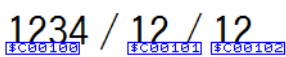

[Display] tab

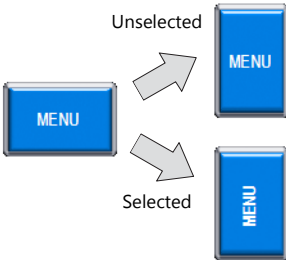
Item	Description
Switch/Lamp Display	Change the display status of switch and lamp parts (OFF/ON/P3, etc.)
Display Language	This setting is available when using the language selection function. Select the display language from languages 1 to 16.
Overlap Display	Select the ID checkboxes corresponding to the overlaps to display on the screen.
Detail	<p>Display Device</p> <p>Select this checkbox to display the device memory set for each item.</p>  <p>Display Component Parts Device</p> <p>Select this checkbox to display the device memory set for each item in component parts.</p>  <p>Show Tag Device</p> <p>This setting is available when the [Display Device] checkbox is selected. When tags are used for device memory addresses, the tag and corresponding device memory is displayed.</p> 

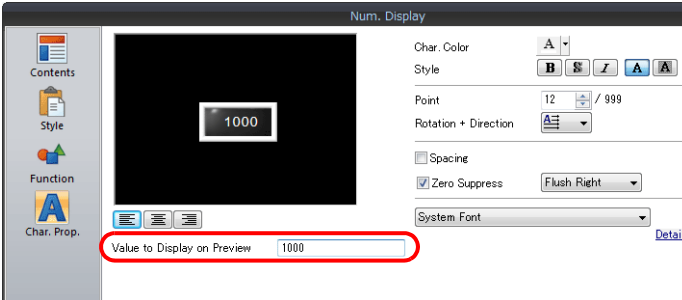
Item	Description
Detail	<p>Select this checkbox to rotate text on switch and lamp parts in the same direction when these parts are rotated.</p> 
Switch: Display macro symbol	<p>Select this checkbox to display a symbol on switches that are configured with macros.</p> 
Switch: Display the screen switch-over symbol	<p>Select this checkbox to display a symbol on switches whose [Function] setting is [Screen Change-over].</p> 
Display for the editor	<p>Select this checkbox to allow the preview value displayed in the [Char. Prop.] settings of data display parts to be changed. Example: Numerical display</p> 
Apply to all screens	<p>Deselect this checkbox to only apply the configured display environment settings to the current screen. Select this checkbox to apply the configured display environment settings to all screens.</p>

[Others] Tab

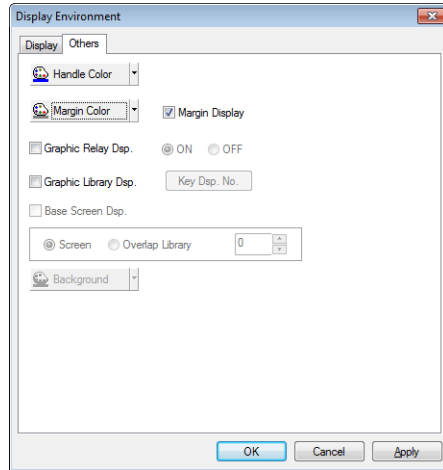

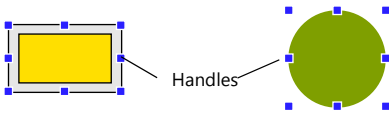
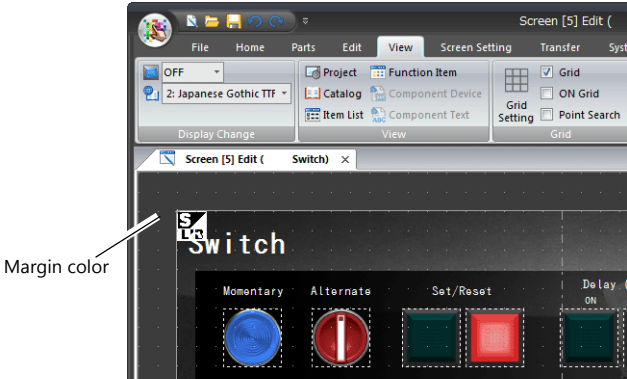
Item	Description
Handle Color	Select the color of handles shown around selected items. 
Margin Color	Select the background color around the editing area. 

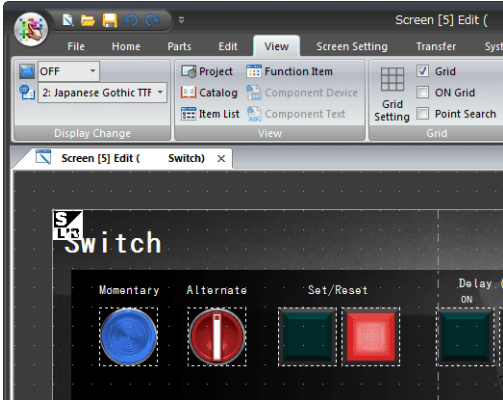
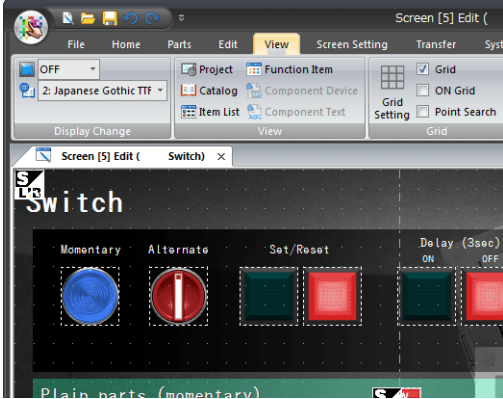
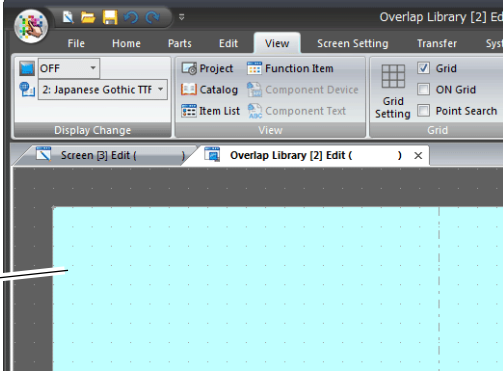
Item	Description
<p>Margin Display</p>	<p>Select this checkbox to display the space (margin) at the left and the upper side of the editing area with the color set for [Margin Color]. The margin area disappears if this checkbox is deselected.</p> <p>Selected</p>  <p>Unselected</p> 
<p>Graphic Relay Dsp.</p>	<p>This setting is only available when the switching method of graphic parts is set to device memory (bit designation). Select this checkbox to check the ON/OFF status in the graphic relay display.</p>
<p>Graphic Library Dsp.</p>	<p>This setting is available when an entry mode part or graphic part is set. For entry mode parts, graphics can be displayed provided that the [Graphic] checkbox is selected in the [Detail] settings of the item settings window. When the [Graphic] checkbox is selected, graphics registered in the graphic library can be displayed on character entry keys. For graphic parts, graphics can be displayed on the screen provided that [Internal] is set for [Designate].</p>
<p>Base Screen Dsp.</p>	<p>This setting is available during editing of a graphic library, overlap library, or data block. Select this checkbox to display a screen or overlap library on the editing window.</p>
<p>Background</p>	<p>Select the background color of the editing area. (This is settable for areas excluding the screen editing tab window.)</p> 

4.2.5 Zoom

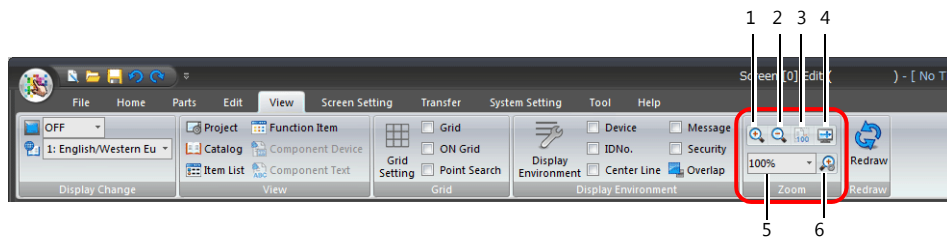

Item	Description	
1	Zoom In	Click to enlarge the display.
2	Zoom Out	Click to reduce the display.
3	100%	Display the screen at 100% magnification.
4	Fit in Display Area	Display the screen at a magnification that fits the screen within the current display range of the editor.
5	Scaling Display	Displays the current magnification. Click to change the magnification.
6	Zoom	Click to display the [Enlargement Factor Designation] window. <div data-bbox="826 741 1059 936" data-label="Image"> </div> <p>Specify an enlargement factor and click [OK] to change the display magnification.</p>

4.2.6 Redraw

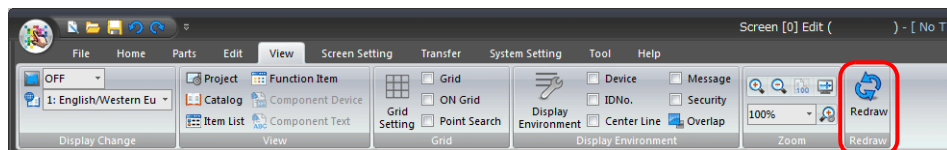

Redraw the displayed screen.

4.3 Screen Setting Menu

Register screen-specific settings.

This section explains the [Screen Setting] window.

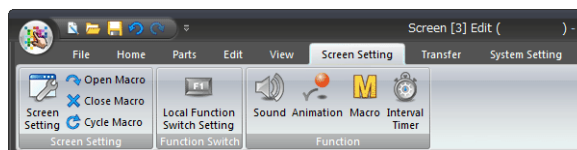

- For more information on the open macro, close macro, and cycle macro, refer to the V9 Series Macro Reference Manual.
- For more information on local function switch settings, refer to the V9 Series Reference Manual 1.
- For more information on the function items of sound, animation, macros, and interval timers, refer to "3.5 Registering Function Items" page 3-40.

4.3.1 [Screen Setting] Window

[Main] Tab

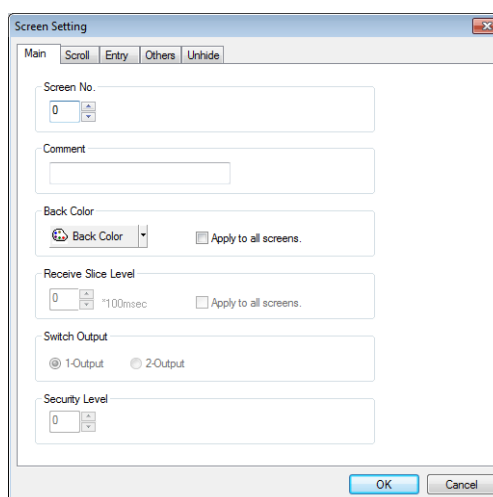

Item	Description
Screen No.	Change the displayed screen number.
Comment	Register a comment to the displayed screen.
Back Color	Select the background color of the displayed screen.
Security Level	Set the security level of the displayed screen. * For more information, refer to V9 Series Reference Manual 2.

[Scroll] Tab

Configure the settings on this tab when enlarging the screen size.



For more information, refer to V9 Series Reference Manual 2.

[Entry] Tab

Configure the settings on this tab when using [Input Cursor Movement Control Device] when setting numerical data entry/character data entry parts.



For more information, refer to V9 Series Reference Manual 1.

[Others] Tab

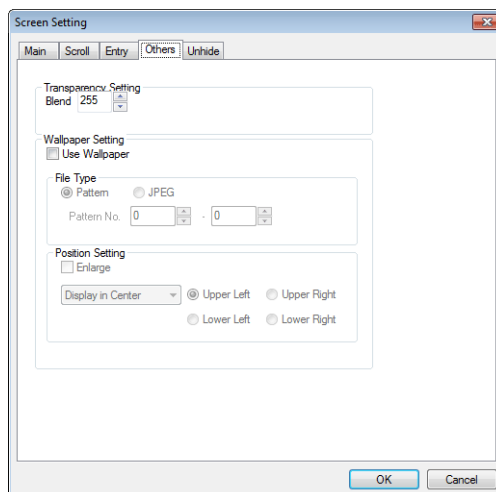

Item	Description	
Transparency Setting	Blend	Configure this setting when using the transparency display function for overlap displays. * For more information, refer to V9 Series Reference Manual 1.
Wallpaper Setting	Use Wallpaper	A bitmap file or JPEG file can be used as wallpaper on the screen currently being edited. Select this checkbox to enable the [File Type] and [Position Setting] settings.
	File Type	Select a file type. <ul style="list-style-type: none"> When [Pattern] is selected: Set a value for [Pattern No.] (0 to 1023). The bitmap file or JPEG file to be used as wallpaper is imported into the screen program file and handled as a pattern. When [JPEG] is selected: Specify the name (using 64 or less one-byte alphanumeric characters) of the JPEG file to be used as wallpaper.
	Position Setting	<ul style="list-style-type: none"> [Enlarge] This setting is only available when [Pattern] is selected for [File Type]. Select this checkbox to enlarge the selected file under equal magnification and place it with respect to the upper left corner of the screen. Deselect this checkbox to enable the following settings. [Display in Center]/[Tile]/[Display in the Corner] Place the specified file at the specified position. When [Display in the Corner] is selected, select either [Upper Left], [Upper Right], [Lower Left], or [Lower Right].



For more information on the procedure for storing JPEG files on a storage device or other information about JPEG files, refer to "1.1 JPEG Display" in V9 Series Reference Manual 2.

[PLC Device Transfer] Tab



This tab cannot be displayed when [Universal Serial] or [Without PLC Connection] is selected for PLC 1 to PLC 8 in the [Device Connection Setting] window.

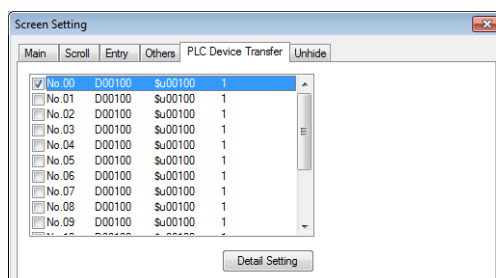

When mainly using PLC device memory for macros and directly using PLC device memory for macro commands, the display speed slows down when read operations are performed on the PLC device memory.

To avoid this, copy device memory necessary for each cycle to the internal device memory and execute macro commands in the internal memory. This process can reduce the amount of slow down.

Use these settings to specify the copy source and copy destination for internal device memory for each screen.

[Unhide] Tab

When using the show/hide function, set the screen operation when using the multi-language selection function.

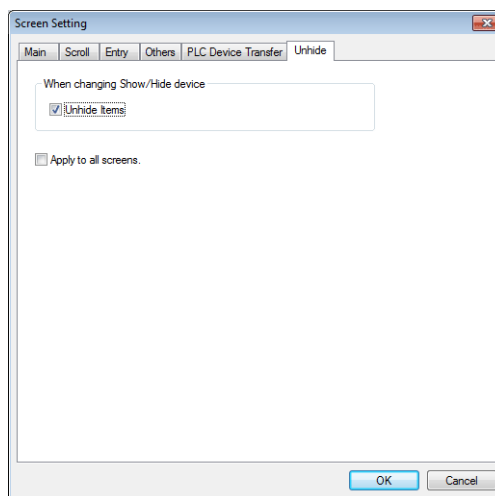

For more information on each setting, refer to V9 Series Reference Manual 2.

MEMO

MONITOUCH



5 Tools

- 5.1 Tool Menu
- 5.2 Error Check
- 5.3 List of Memory Use
- 5.4 Search
- 5.5 Batch Change
- 5.6 Others

5.1 Tool Menu

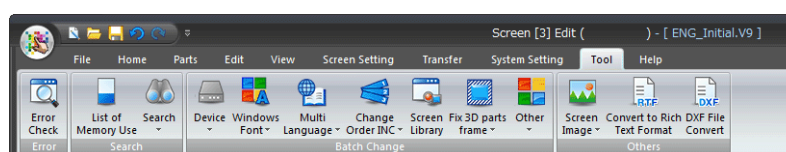

	Item	Description	Refer to
Error	Error Check	Perform an error check on the screen program currently being edited.	page 5-2
Search	List of Memory Use	Display the available capacity of the screen program currently being edited.	page 5-3
	Search	Search device memory addresses, tag usage, text, Windows fonts, and macro commands.	page 5-7
Batch Change	Device	Perform a batch change of device memory addresses.	page 5-30
	Windows Font	Perform a batch change of Windows fonts.	
	Multi Language	Perform a batch change of properties such as language switching and text color.	
	Change Order INC	Perform a batch change of cursor movement order numbers.	
	Screen Library	Perform a batch change of screen libraries.	
Other	Screen Image	Capture an image of the displayed screen. Select from the three commands of saving as a pattern image, copying to the clipboard, and saving to an image file.	page 5-56
	Convert to Rich Text Format	Convert an image of the screen program currently being edited to a rich text format file.	
	DXF File Convert	Import a DXF file into the screen program currently being edited.	

5.2 Error Check

The entire file of the screen program currently being edited can be checked for errors, and if any errors are found, the causes and remedies are displayed.

5.2.1 Display Method

Click [Tool] → [Error Check]. The [Error Check] window is displayed.

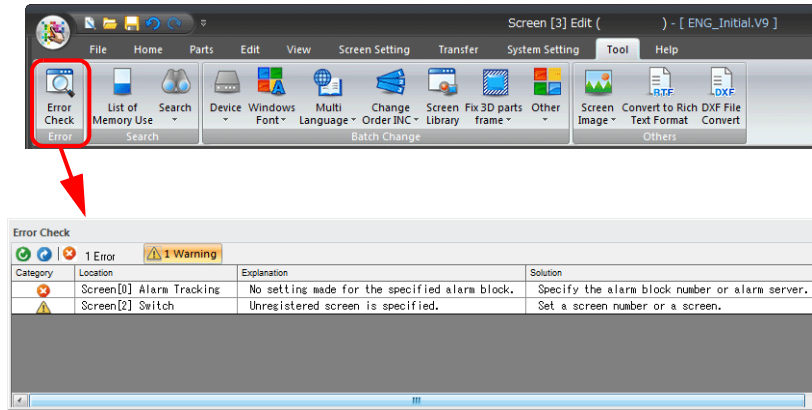

* Double-click an error item to jump to the location of the error.

5.2.2 Error Types

Category	Description
	Error When transferred to the unit, this type of error will prevent the screen program from operating.
	Warning A warning does not have any effect on screen program operation. This is a comparatively low-grade error.

5.2.3 Icon Menu

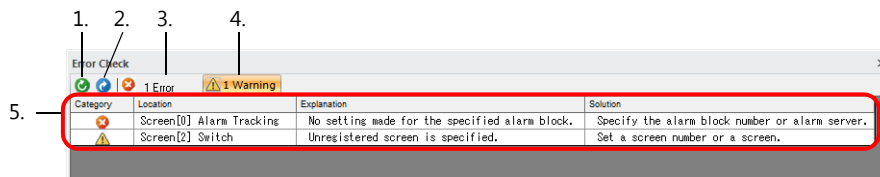

Item	Description
1	Refresh Click this icon to display the latest error information.
2	Jump to error item Select an error item and click this icon to jump to the error location in the screen program.
3	Number of errors Displays the current number of errors.
4	Number of warnings Displays the current number of warnings. Click this icon to show or hide warnings in the error list.
5	Error list Displays a list of errors. The location, description, and remedy for each error is displayed. Double-click an item to jump to the location of the error.

5.3 List of Memory Use

This tab window displays information including the registration state of each registered item and remaining memory for the entire file of the screen program currently being edited.

5.3.1 Display Method

Click [Tool] → [List of Memory Use]. The [List of Memory Use] tab window is displayed.

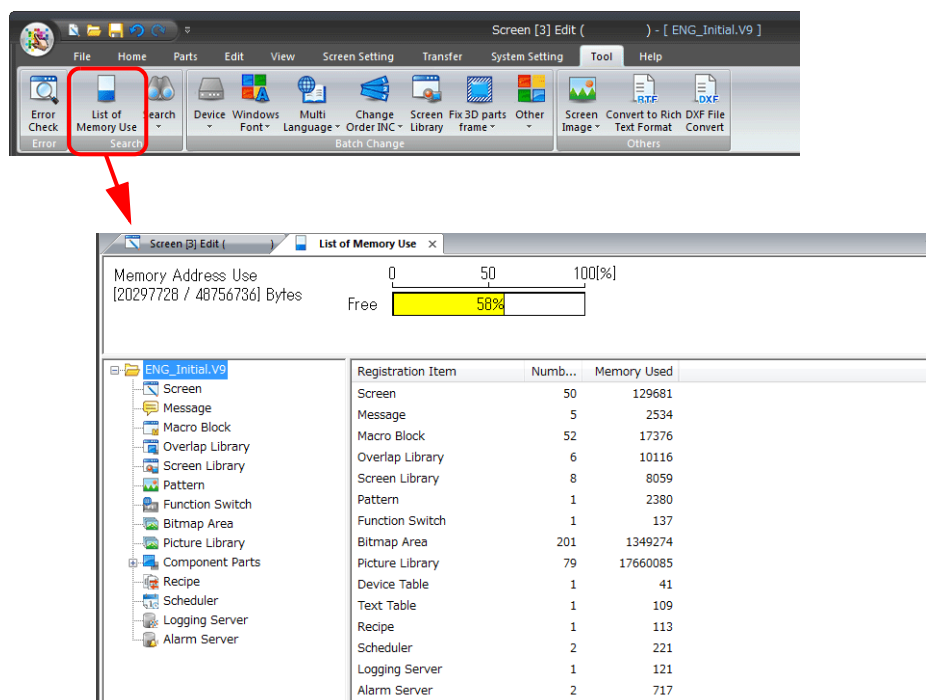

- [Memory Uses] is expressed in bytes.
- [Bitmap Area]
This refers to bitmap data used when placing 3D parts or custom parts.

5.3.2 Checking Registration Details of Registered Items

1. Click the box of a registered item in the left pane of the [List of Memory Use] tab window, or double-click the registered item in the right pane of the tab window.

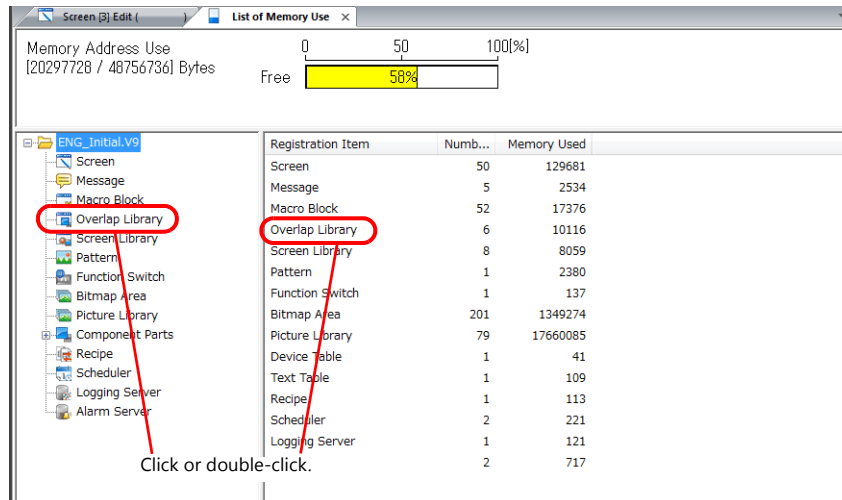

2. A list of registered items is displayed.

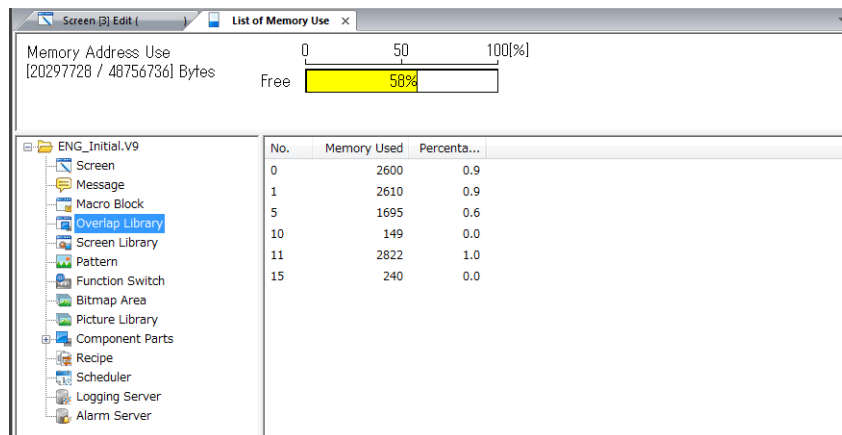

3. To return the tab window to the overall display of memory use, click the filename of the screen program displayed at the top left corner.

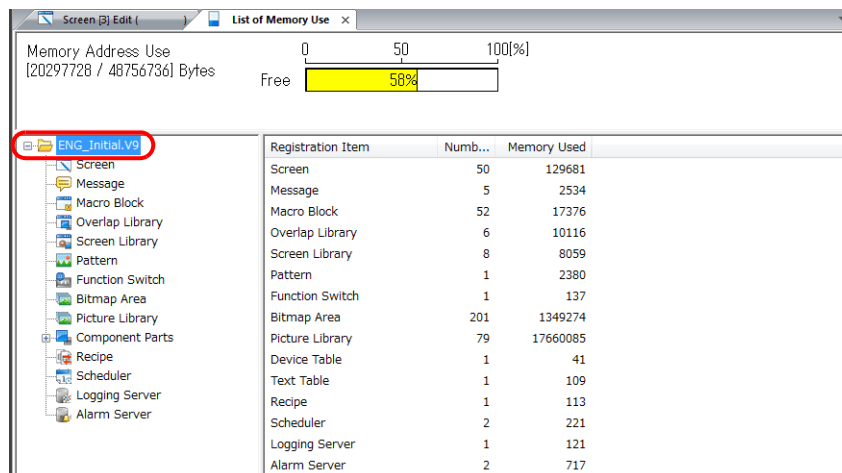

5.3.3 3D Bitmap Area List

Overview

3D parts (including real parts), such as switches and lamps, currently used in the screen program can be displayed in the 3D bitmap area list. In this list, the location of each 3D part can also be checked.

This list is useful for keeping track of 3D part locations so that the screen program size can be reduced as required.

3D bitmap area list

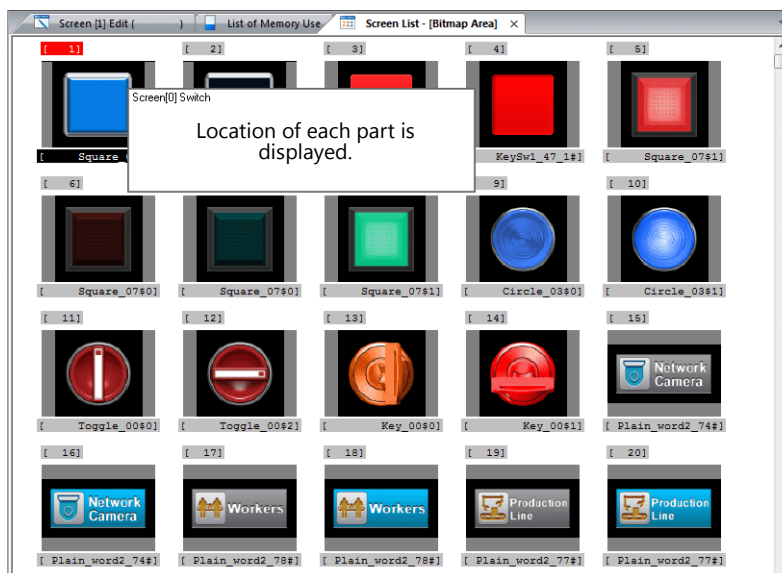

Parts

- Plain parts
- Real parts
- Sign parts
- 3D parts
- 3D_128 parts
- HA parts

Display Method

1. Click [Tool] → [List of Memory Use] to display the [List of Memory Use] tab window.
2. Click [Display] on the right and then [3D Bitmap Area List] to display the [Screen List [Bitmap Area]] tab window.

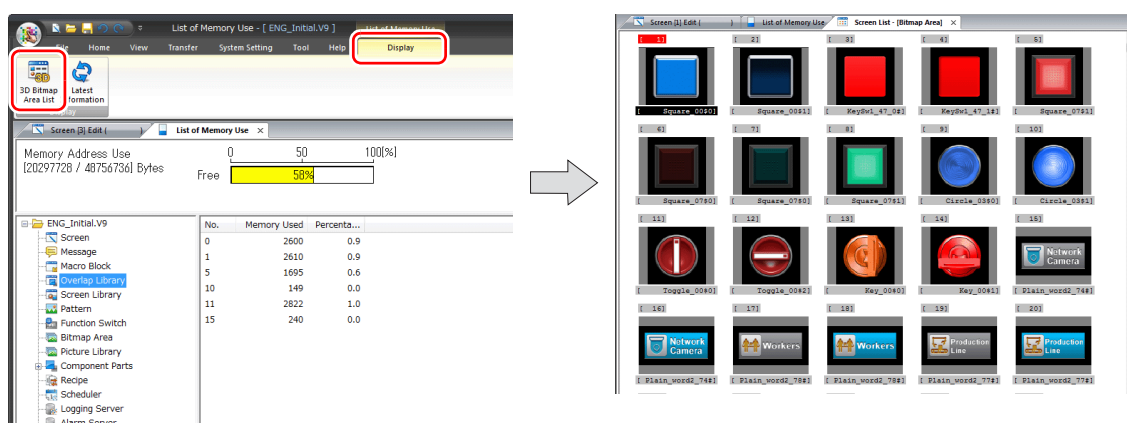

Checking Locations of Use

This section describes how to check the locations of currently used 3D parts.

1. Select a 3D part in the [Screen List [Bitmap Area]] tab window and click [Display Used Point] from the right-click menu. The locations of use are displayed.

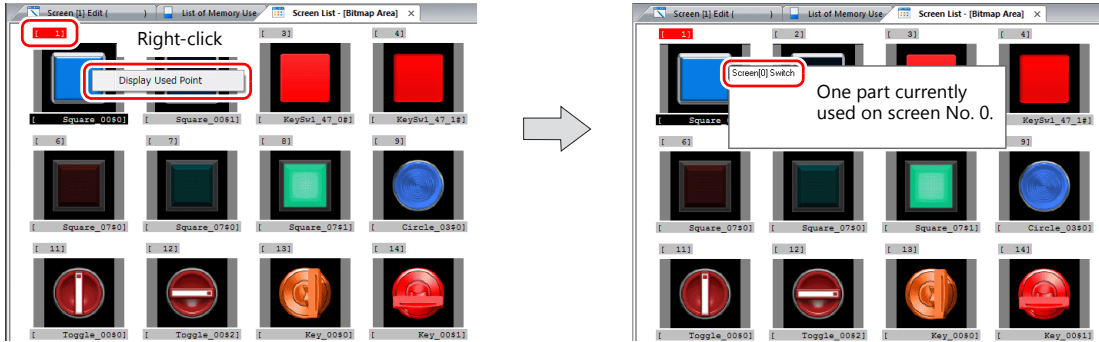

2. Place the cursor on the listed part and double-click on it. The relevant screen where the selected part is placed appears.

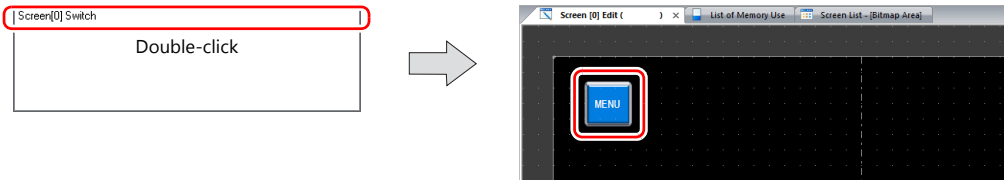

Checking Part Sizes

1. Click [Tool] → [List of Memory Use] → [Bitmap Area] to display the memory usage list.

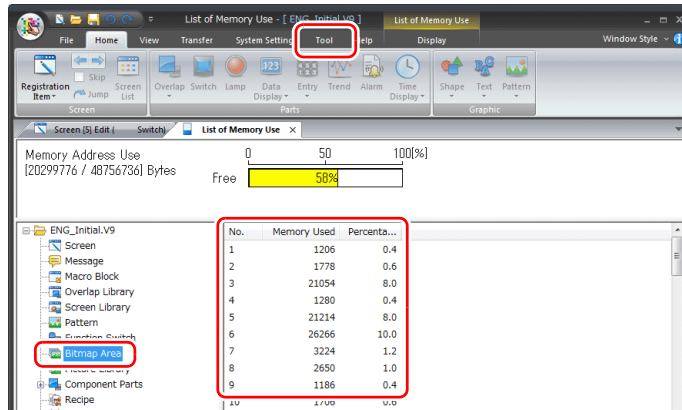

2. Check the sizes by referring to the numbers in the [Screen List [Bitmap Area]] tab window and the [Bitmap Area] numbers in the [List of Memory Use] tab window.

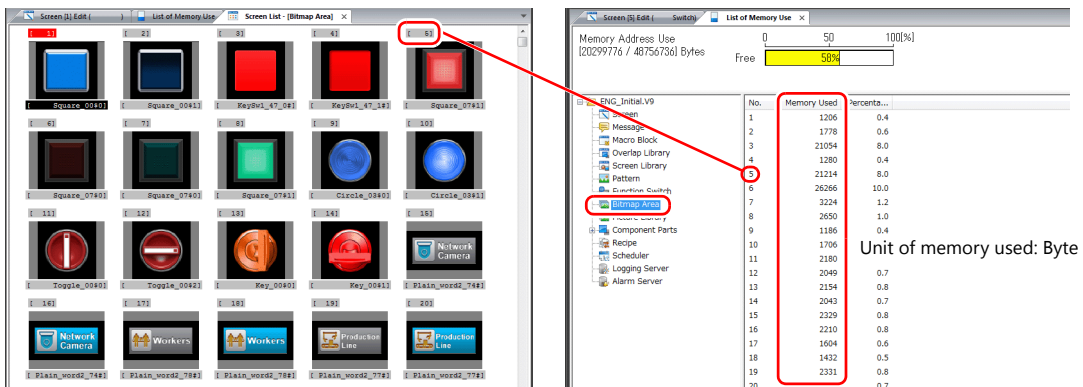

Notes

In the case of a switch or lamp part, the 3D bitmap area list is created per pattern.
 In the case of a 2-pattern lamp (ON and OFF), the OFF pattern is registered to No. 1 and the ON pattern is registered to No. 2.
 Also, a different sized part is registered in another number even if the design is the same.

5.4 Search

Device memory addresses, tag usage, text, Windows fonts, and macro commands can be searched. The cross-reference command is used to search where registered items are located on screens.

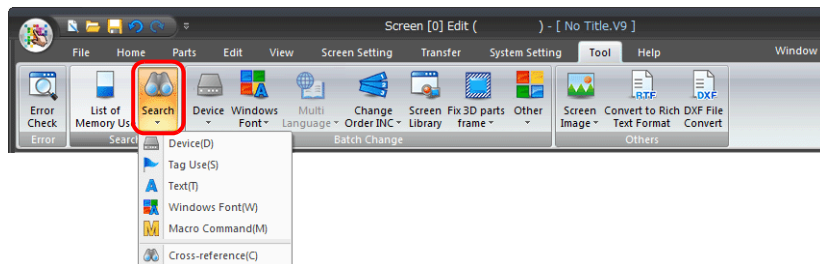

5.4.1 Device Memory Addresses

Search the device memory addresses used in the entire file and check the locations of use.

Search Method

Searching using cross-referencing

1. Click [Tool] → [Search] → [Device]. The [Device Address Use] window is displayed.

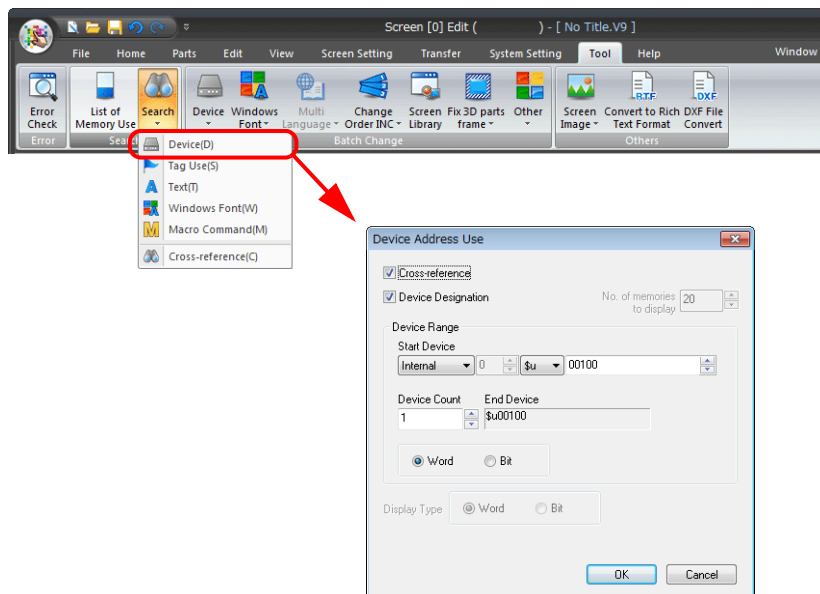

2. Select the [Cross-reference] and [Device Designation] checkboxes and specify the device memory range for searching.

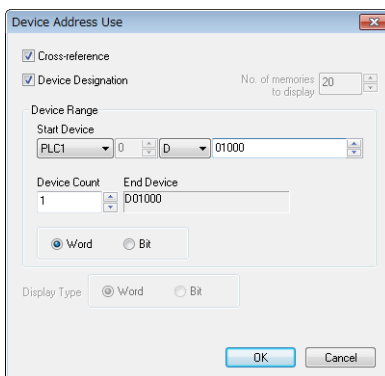

3. Click [OK] to display a tab window that shows the usage status of device memory addresses in the specified range.

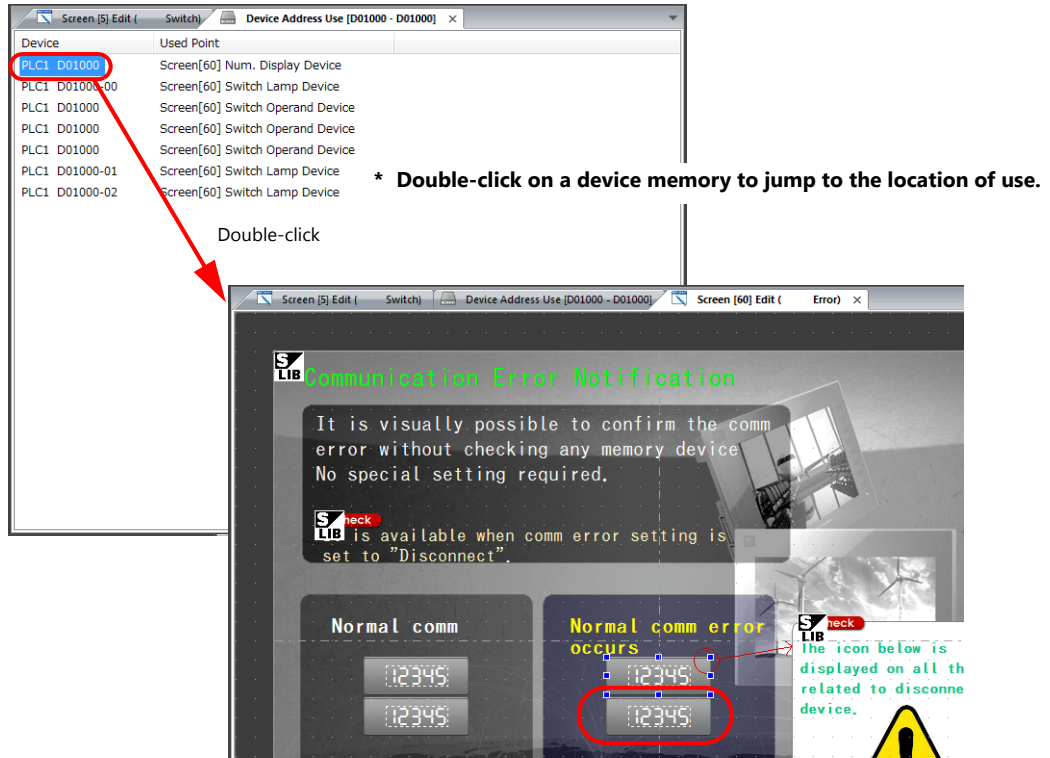

- Searching all device memory addresses used in a screen program
Searching of all device memory addresses can be performed by deselecting the [Device Designation] checkbox in the [Device Address Use] window and clicking [OK].

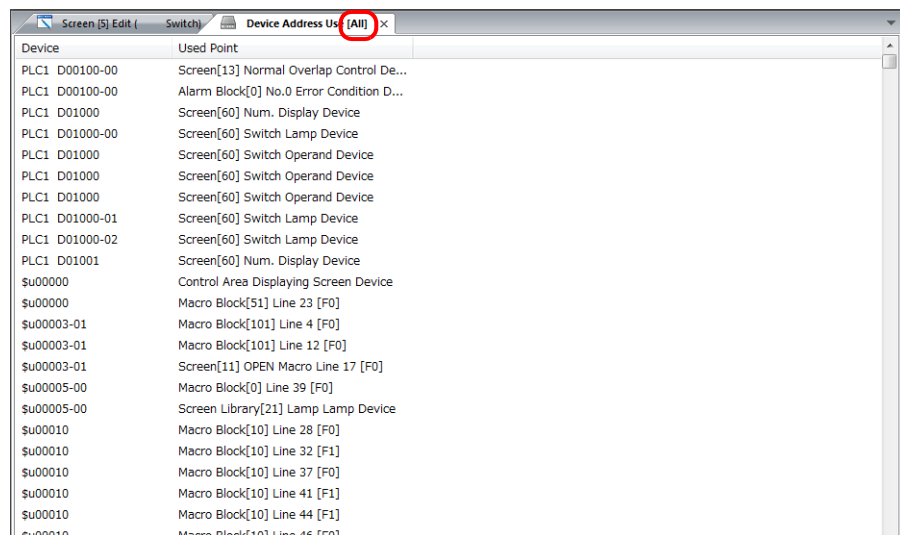
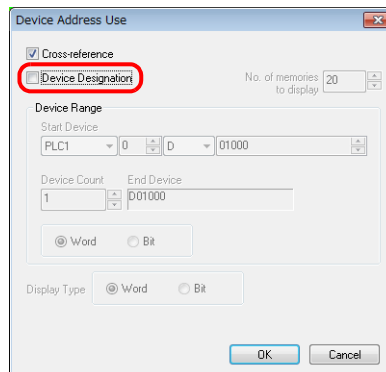

Searching without using cross-referencing

1. Click [Tool] → [Search] → [Device]. The [Device Address Use] window is displayed.

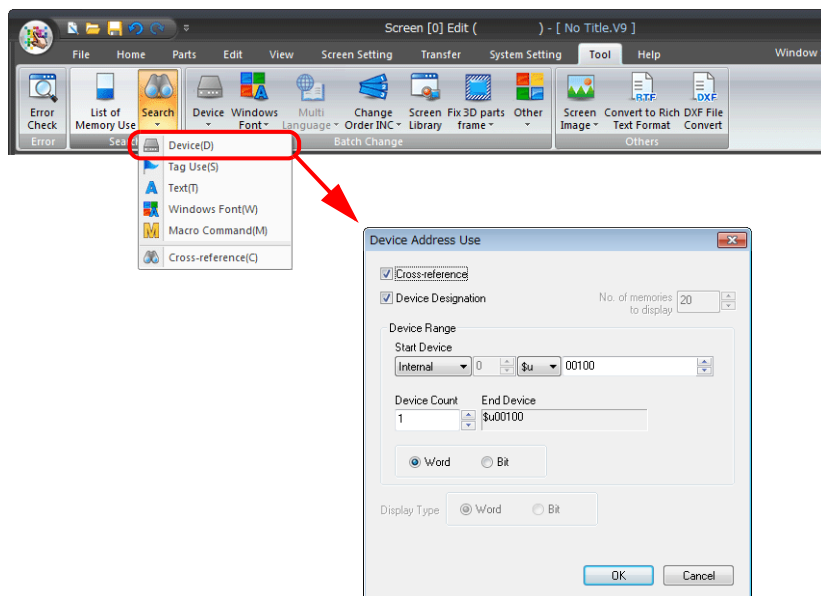

2. Deselect the [Cross-reference] checkbox.
The [No. of memories to display] setting becomes active. Select the desired number.
Also, specify the range of device memory addresses in the [Device Range] area.

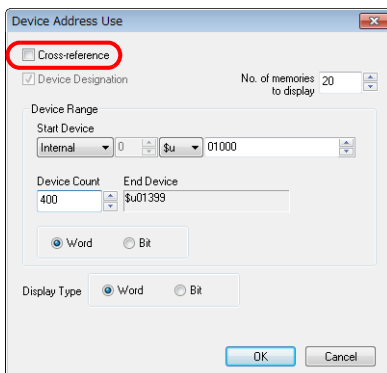

3. Click [OK].
A list of device memory addresses within the specified range is displayed in the [Device Address Use] tab window.

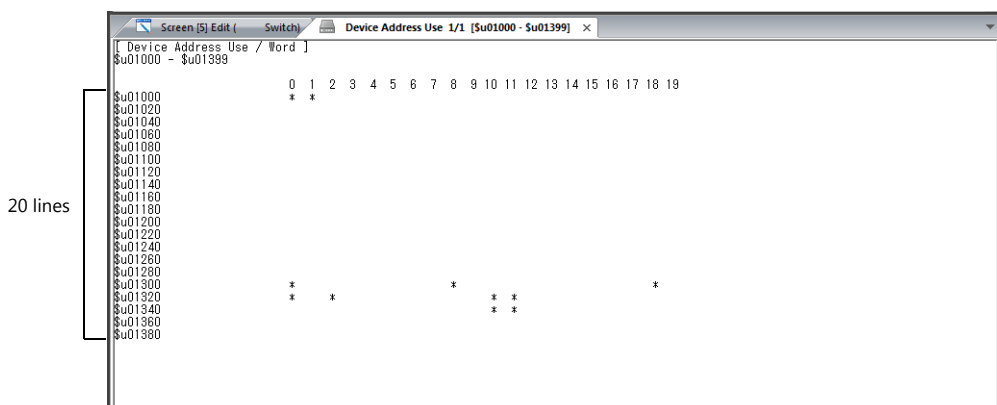

[View] Menu

When the [Device Address Use] tab window is displayed, a [Display] menu is added to the ribbon menu.

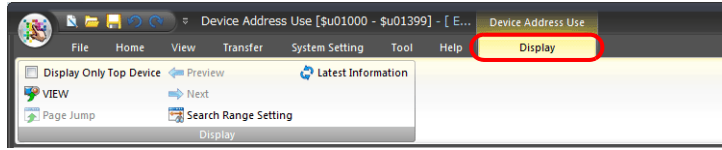

Item	Description
Display Only Top Device	This setting is available when searching using cross-referencing. Selecting this checkbox when items are specified automatically with consecutive device memory addresses, such as trend parts (real time) and parameters of graphic parts, will only display the top device memory address.
VIEW	This setting is available when searching using cross-referencing. Jump to the location of use of the selected device memory.
Page Jump	This setting is available when cross-referencing is not used. Jump to the page that displays the specified device memory.
Preview	This setting is available when cross-referencing is not used. Move to the previous page.
Next	This setting is available when cross-referencing is not used. Move to the next page.
Search Range Setting	Click to perform a new device memory search. The [Device Address Use] window is displayed.
Latest Information	Update the [Device Address Use] window with the latest information.

[Display] menu operations are also accessible from the right-click menu.

- When cross-referencing is used
 - Display Only Top Device
 - VIEW
 - Search Range Setting...
 - Latest Information
- When cross-referencing is not used
 - VIEW
 - Page Jump...
 - Preview
 - Next
 - Search Range Setting...
 - Latest Information

5.4.2 Tag Usage

The tag usage status of the entire screen program can be searched and the total word count registered in the [Tag Database Edit] window can be checked.

Displaying the [Tag Use] View Window

1. Click [Tool] → [Search] → [Tag Use]. The [Tag Use] view window is displayed.

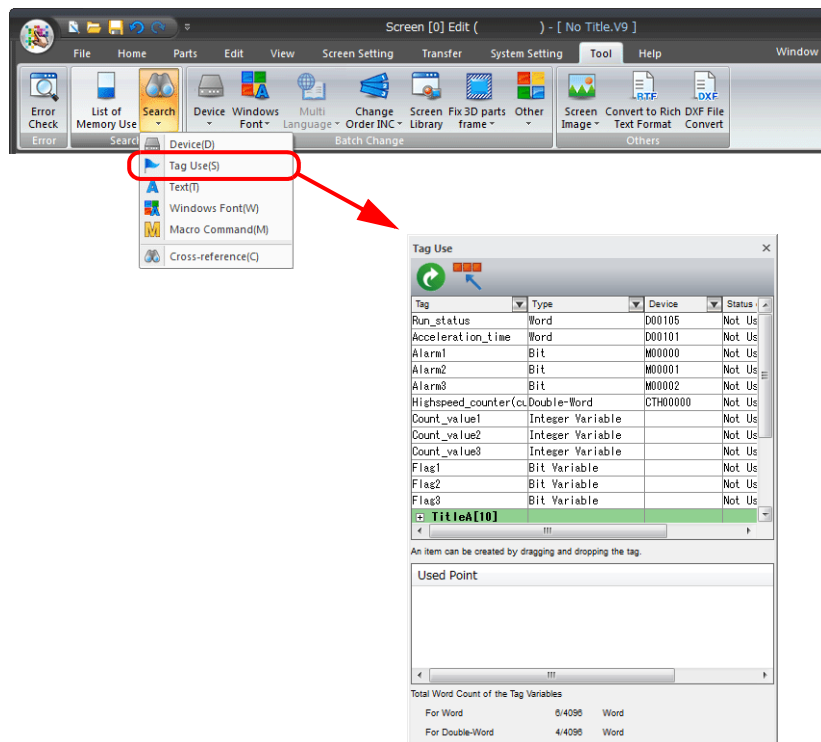

Tag Use View Window

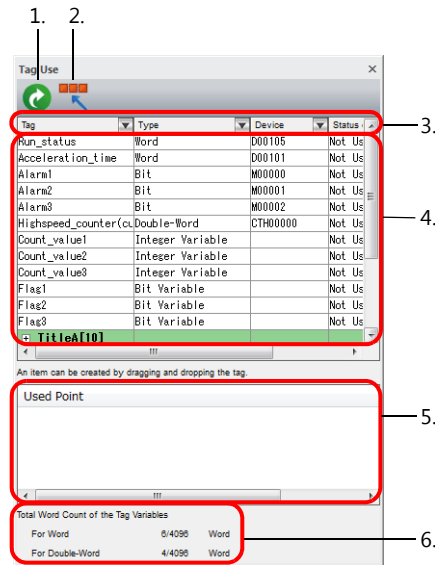

Item	Description
1 Refresh	Update to the latest state.
2 Jump to the [Tag Database Edit] window	Click this icon when a tag is selected in the tag usage list (4) to jump to the registered location in the [Tag Database Edit] window. Click this icon when a location of use (5) is selected to jump to the screen where the tag is used.
3 Filters	Click each ▼ button to display a filter menu. A filter can be applied to each item for displaying the list. <div style="text-align: center; margin: 10px 0;"> </div> <ul style="list-style-type: none"> • Ascending Order Display the items in the tag usage list in ascending order. • Descending Order Display the items in the tag usage list in descending order. • Clear Clear the filter. • Text search Perform a text search on a name and display only the corresponding items in the display item selection. • Display item selection Select the items to display in the tag usage list.
4 Tag usage list	Displays a list of used tags.
5 Used Point	Selecting a tag in the list displays the location of use of the tag. Double-click on the location of use to jump to the screen where the tag is used.
6 Total Word Count of the Tag Variables	Displays the status of the variable area. Max. 4096 words for single and double words * If the occupied word count exceeds the maximum value, the value is displayed in red. Set a value smaller than the maximum.

Operation Method

To search for the position where a tag is used

This section describes the procedure for searching for the tag "Alarm 1" used in the screen program.

1. Click [▼] next to the [Tag] item to display a filter menu.

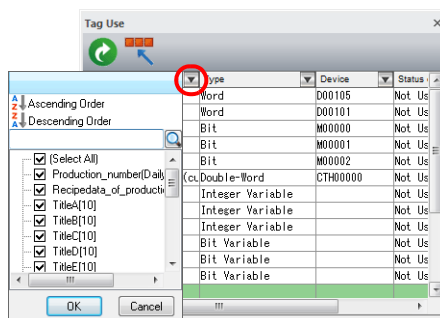

2. Enter "Alarm" in the text search field and click the [🔍] icon.

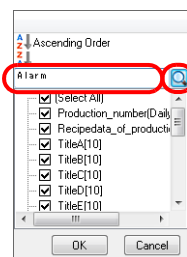

3. All tags that include "Alarm" are displayed in the search results. Select the checkbox of the items to display and click [OK].

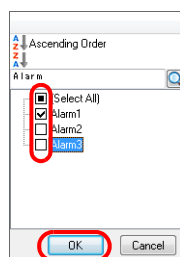

4. A tag usage list of corresponding tags is displayed.

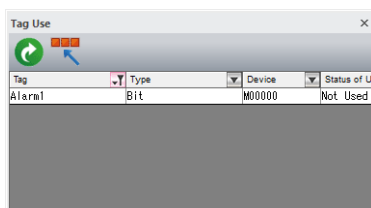

Selecting a tag in the tag usage list displays the location of use of the selected tag in the [Used Point] field. Double-click on an item displayed in the [Used Point] field to jump to the location of use.

To check the status of use

This section describes the procedure for searching only for tags currently in use in the screen program file.

1. Click [▼] next to the [Status of Use] item to display the filter menu.

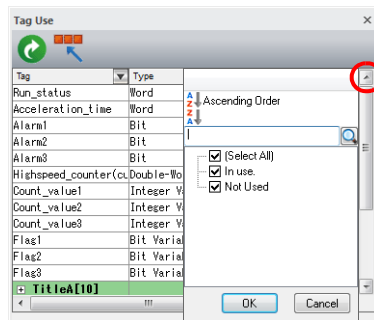

2. Select only the [In use] checkbox and click [OK].

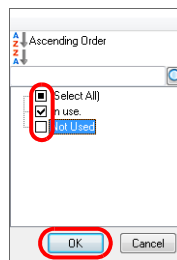

3. A tag usage list of the tags in use is displayed.

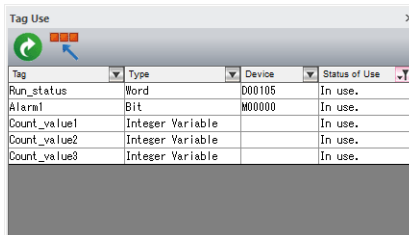

☺ Selecting a tag in the tag usage list displays the location of use of the selected tag in the [Used Point] field. Double-click on an item displayed in the [Used Point] field to jump to the location of use.

5.4.3 Text

- When changing the registered names of parts such as text, switches, or lamps, the [Search] and [Replacement] functions can be used to find locations of use and replace text as required.
- Case-sensitivity and the search range can be set as search conditions.
These functions should help improve work efficiency and avoid correction omissions.

Display Method

Click [Tool] → [Search] → [Text] to display the [Text Search and Replacement] view window.

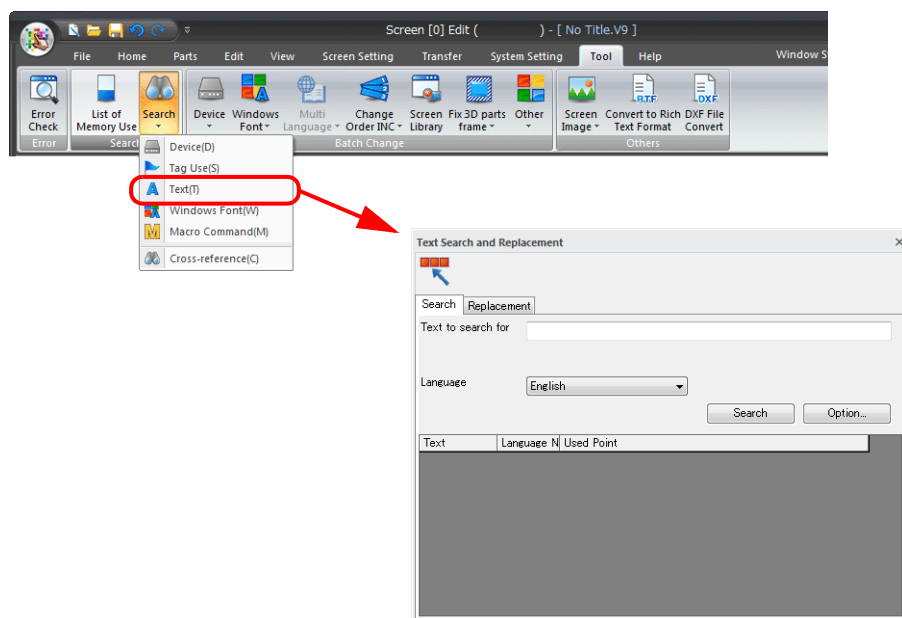

Text Search and Replacement View Window

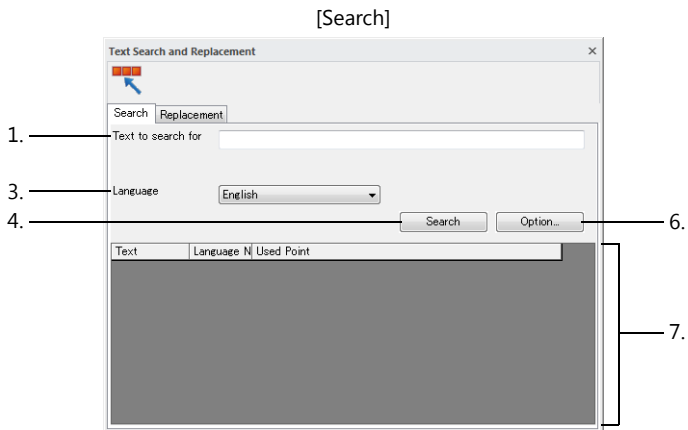
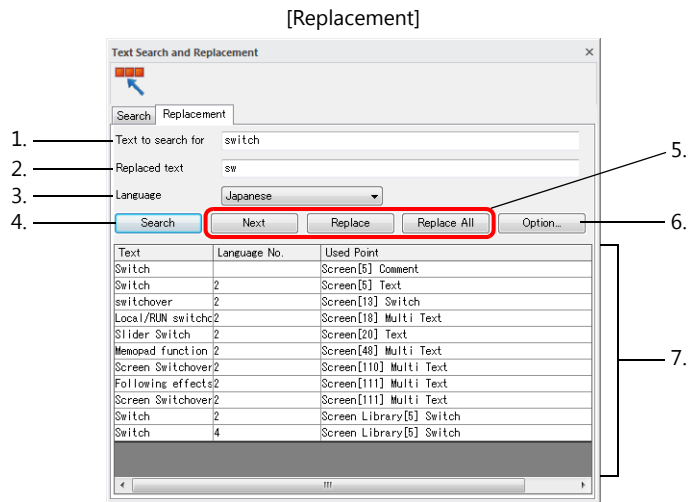

Item	Description
1	Text to search for Enter the text to search for. Within 256 one-byte characters
2	Replaced text Enter the replacement text. Within 256 one-byte characters When replacing text, always execute a search for the text beforehand.
3	Language Select a language according to the text entered for [Text to search for] and [Replaced text].
4	Search Execute a search.
5	Next Replace Replace All These are only available when performing text replacement. These buttons can be selected after clicking [Search]. [Next] This button executes no replacement and moves the line selection to the next line. (Lines where text has been replaced (blue colored) are skipped.) [Replace] This button replaces the text in the selected line and then moves the line selection to the next line. The lines where text has been replaced turn blue. [Replace All] This button replaces the text of all search results in the list. When replacement is complete, the following dialog box is displayed. <div style="border: 1px solid gray; padding: 5px; width: fit-content; margin: 10px auto;"> <p style="text-align: center;">v5ft60</p> <p style="text-align: center;">All text has been replaced.</p> <p style="text-align: center;">OK</p> </div>
6	Option Display the [Option Setting] window. Specify the search range and any conditions. For more information, refer to "[Option Setting] window" page 5-17.
7	Search result list Displays the search/replacement results in a list. Text that has been replaced is displayed in blue. Double-click on a selected line to jump to the screen of the selected location and display the set location.

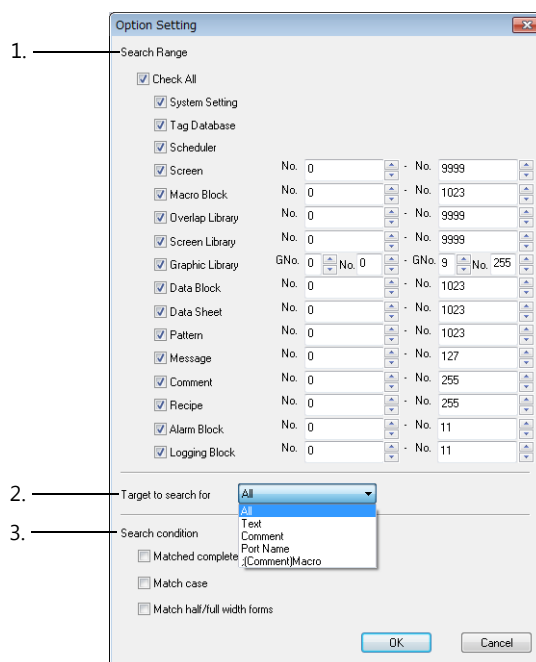
[Option Setting] window

Item	Description
1	Search Range Select the range used to search for text. Default: [Check All]
2	Target to search for Select the items to target in the text search. [All] All text registered in the file [Text] Text [*] registered in drawing parts, multi-text, switches, lamps, and the message editor [Comment] Text [*] registered in comments for screens and macro blocks [Port Name] Text registered for the port name of the Ethernet network table and Modbus extended format [: (Comment) Macro] Text registered after ";" characters in the macro editor
3	Search condition [Matched completely] Selected: Only search for complete matches of the text. Unselected: Search for partial matches of the text. [Match case] Selected: Searching is case-sensitive. Unselected: Searching is not case-sensitive. [Match half/full width forms] Selected: Searching discriminates between one-byte and two-byte characters. Unselected: Searching does not discriminate between one-byte and two-byte characters.

*** Search target details**

- [Target to search for]: Text

Item	Detail
Items	Text, multi-text, switch/lamp text, numerical display/character display comments, table data display text, text in [Display days of the week] calendar settings
Macros	Text in double-quotation marks (" ") specified using the CHAR/STRING macro command
Registration items	Text in [Message]/[Comment] editors, [Tag] comments
System settings	Comment, table name, write/read/search condition column name of [MES Setting] tab window, computer name of [Remote Desktop table Setting] tab window
Folder names Filenames	[System Setting] → [Storage Setting] access folder name, folder name/filename of switches with [Function] set to [Folder Select] or [File Select], filename of sound/JPEG parts, JPEG filename at [Screen Setting] → [Screen Setting] → [Others]

- [Target to search for]: Comment

Details
Screens, graphics libraries, overlap libraries, screen libraries, data blocks, patterns, data sheets (including extended data sheets) <ul style="list-style-type: none"> • Location of settings: [Home] → [Screen List]
Macro block, device memory map <ul style="list-style-type: none"> • Location of settings: [Edit] → [Comment]

Operating Procedure

Search

This section explains how to find where the text “Switch” is used.

1. Click [Tool] → [Search] → [Text] to display the [Text Search and Replacement] view window.
Display the [Search] tab.

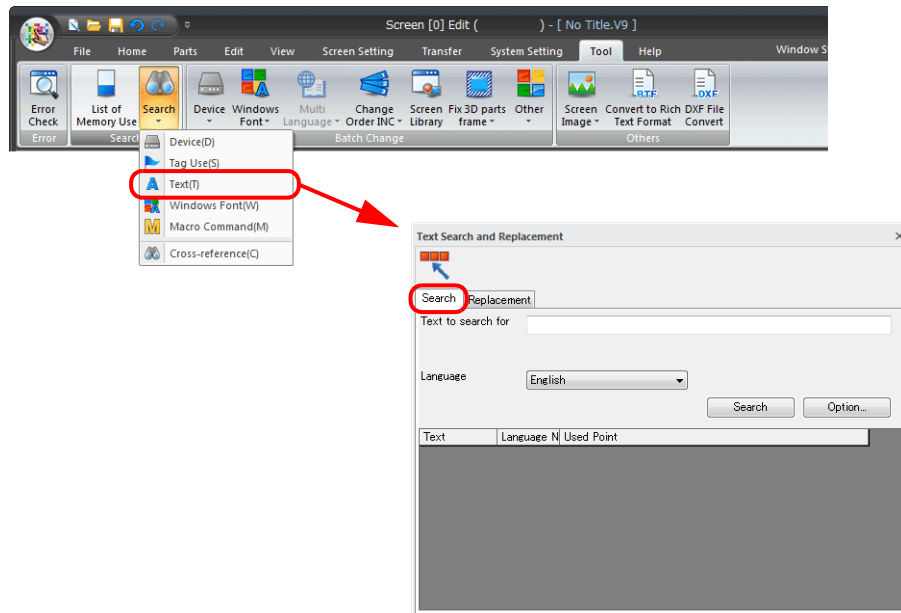

2. Enter “switch” for [Text to search for] and click [Search].

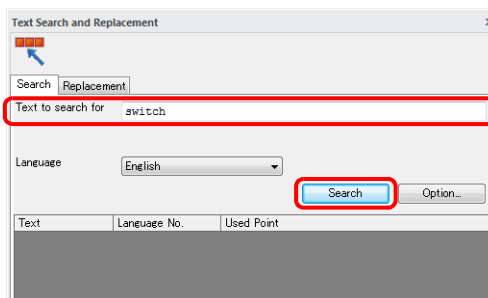

3. The search result list shows the occurrences of the text “switch”.*

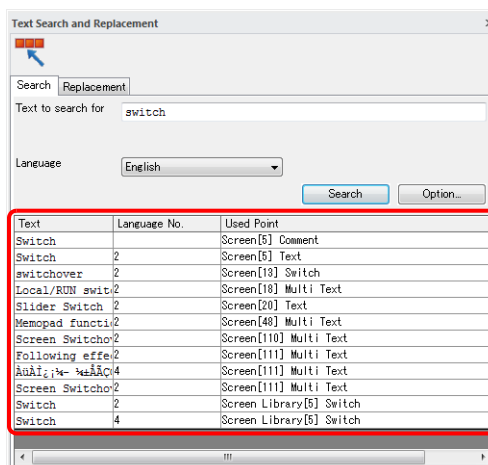

* When nothing is found, “None / No occurrence.” appears.

- Double-click on the line in the list selected with the cursor. This jumps to the selected item. To further refine the search conditions, proceed to step 5.

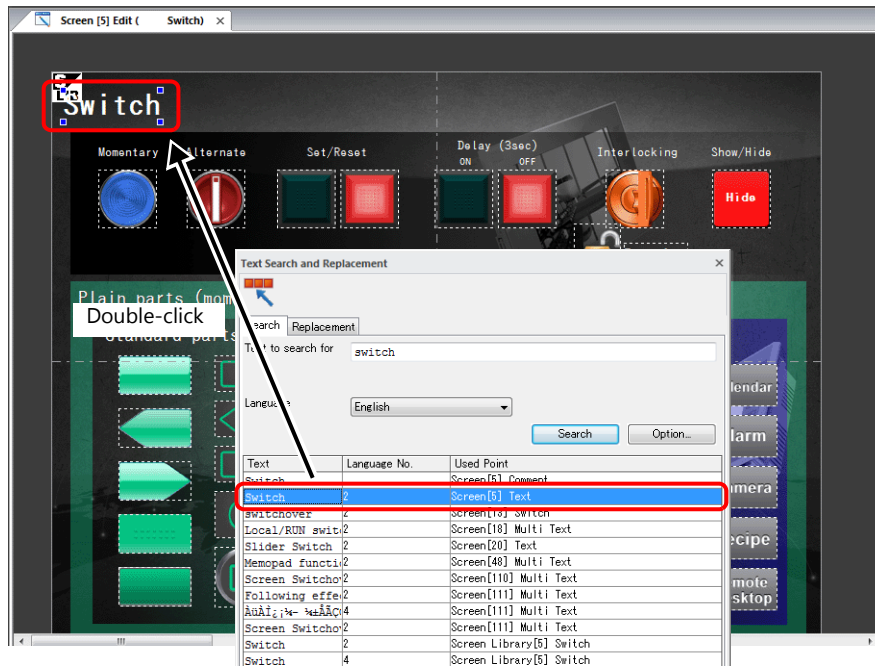

- The following steps are explained on the condition that the [Matched completely] checkbox is selected for [Search condition].

Click [Option] to display the [Option Setting] window.
Configure the following settings.

- [Search Range]: Check All selected
- [Target to search for]: All

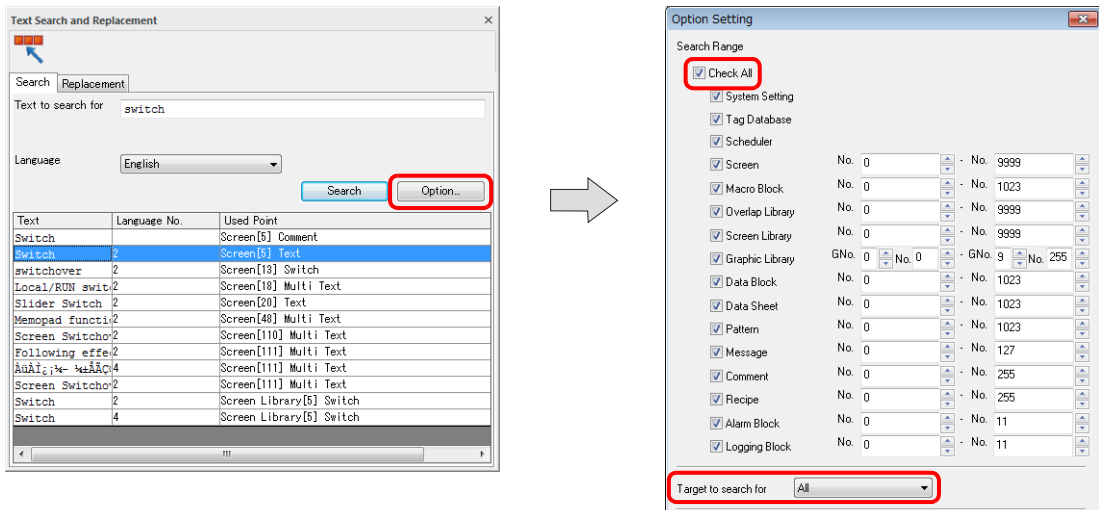

- Select the [Matched completely] checkbox under [Search condition] and click [OK].

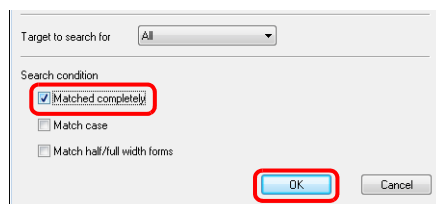

7. The search result list only shows a list of the locations where the text "switch" is used.

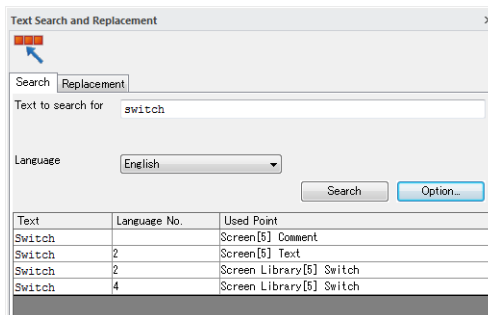

This completes the search procedure.

Replacement

This section explains how to replace all occurrences of the text "switch" with "SW".

1. Click [Tool] → [Search] → [Text] to display the [Text Search and Replacement] view window, and click the [Replacement] tab.

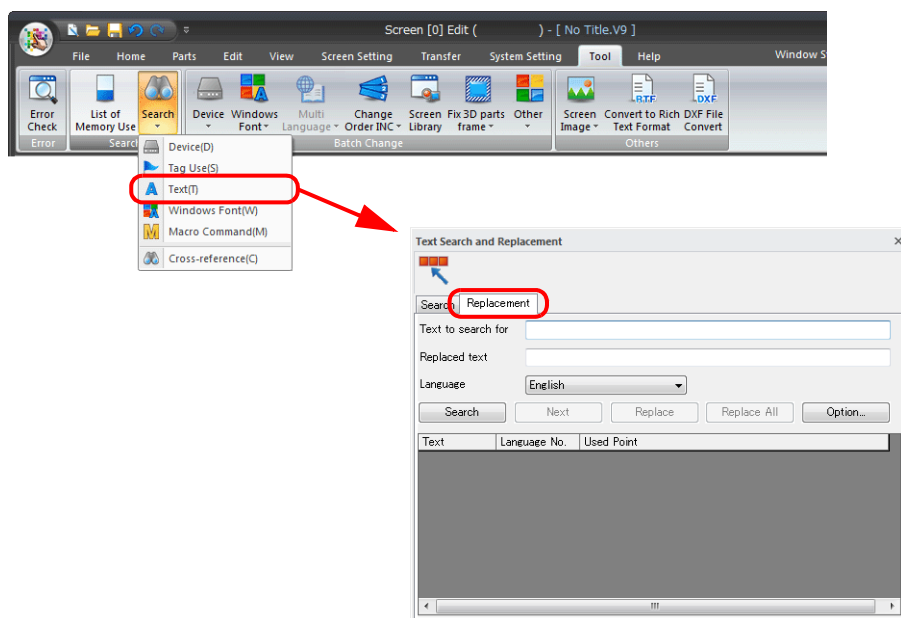

2. Enter "switch" for [Text to search for] and click [Search].

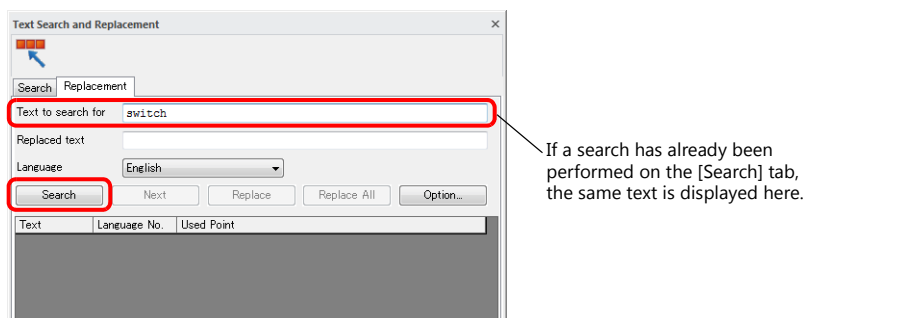

If a search has already been performed on the [Search] tab, the same text is displayed here.

- * **A search must be performed before attempting replacement.**
- Click [Option] to display the [Option Setting] window and set the search conditions.**
- Configure the following settings to search all content.**
 - [Search Range]: Check All selected
 - [Target to search for]: All
 - [Search condition]: All unselected

- The search result list shows the occurrences of the text "switch". *
Enter "SW" for [Replaced text].

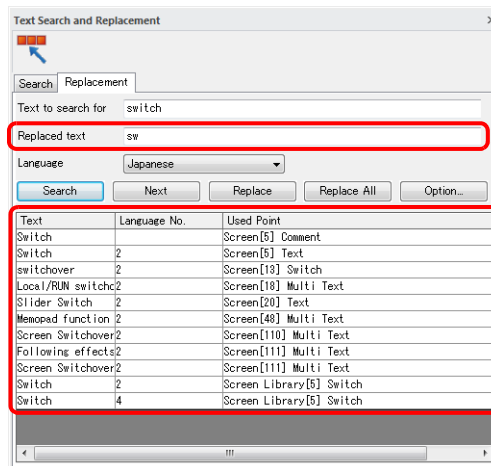

* When nothing is found, "None / No occurrence." appears.

- Click [Replace] or [Replace All] to perform replacement.

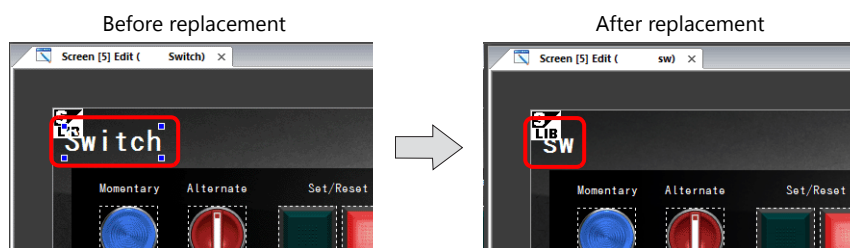
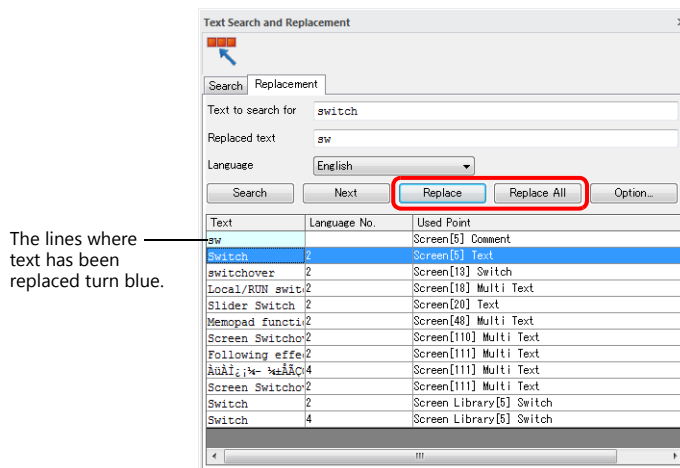

This completes the replacement procedure.

5.4.4 Windows Font

Display a list of names of Windows fonts used in the screen program.



For more information, refer to "10.4 Windows Font" page 10-11.

5.4.5 Macro Command

Searching macro commands

Searching for specified macro commands is possible. The function for searching for multiple macro commands at once will save editing time.

Display Method

Click [Tool] → [Search] → [Macro Command]. The [Macro Command Search] view window is displayed.

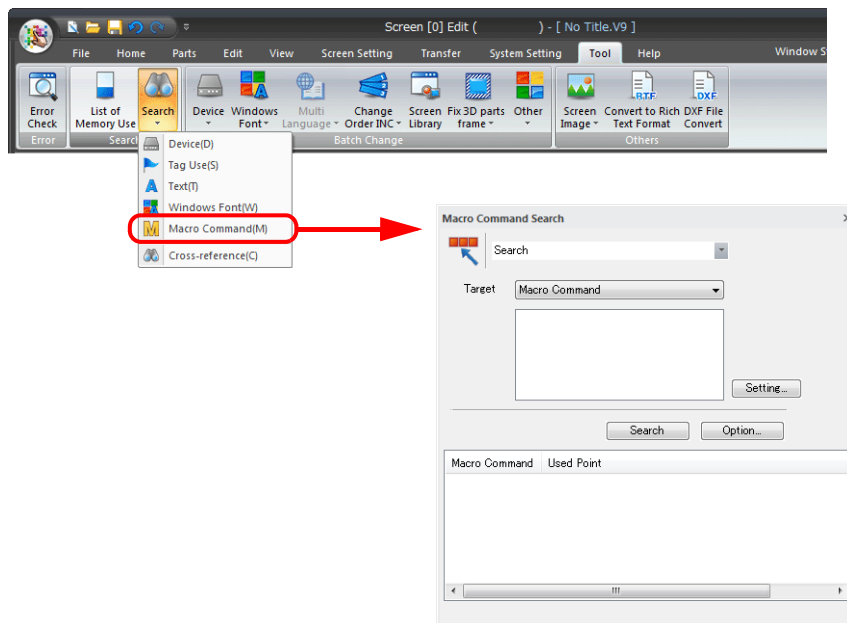

Setting Items

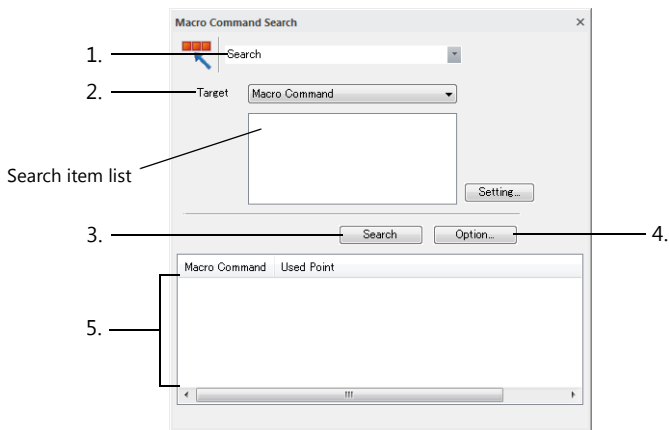

Item	Description
1	<p>Function selection</p> <p>[Search] Search the screen program for the specified macro command and display the results in a list.</p> <p>[Cross-reference] Search the screen program for the item specified for [Target] and display the results in a list. * For more information on cross-referencing, refer to "5.4.6 Cross-reference" page 5-27.</p>

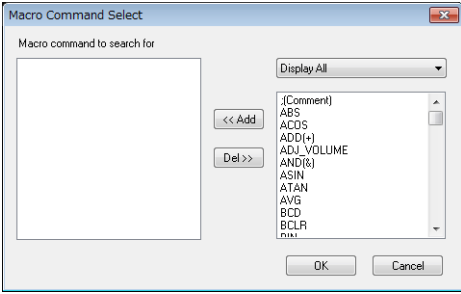
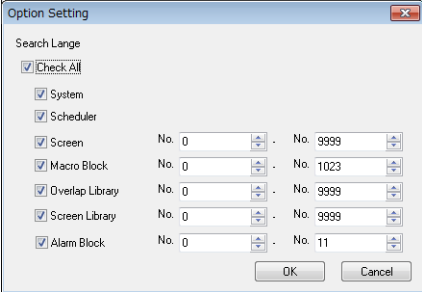
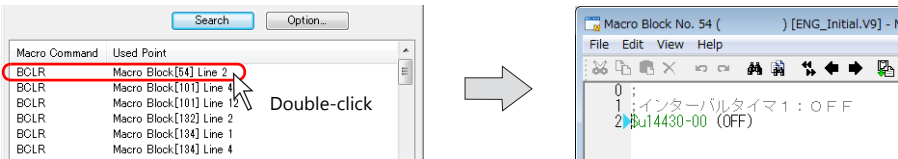
Item	Description														
2 Target	<p>Register the macro command(s) to search for. Click [Setting] to display the [Macro Command Select] window.</p>  <ul style="list-style-type: none"> • [Add] Use this button to add macro command(s) selected from the list to the [Macro command to search for] list. • [Del] Delete the selected macro command(s) from the [Macro command to search for] list. 														
3 Search	<p>Start the search and display the search results.</p>														
4 Option	<p>Display the [Option Setting] window. Specify the search range.</p> 														
5 Search result list	<p>Displays macro commands and locations of use in a list. Double-click on an item to jump to the location of use.</p>  <table border="1" data-bbox="507 1122 932 1279"> <thead> <tr> <th>Macro Command</th> <th>Used Point</th> </tr> </thead> <tbody> <tr> <td>BCLR</td> <td>Macro Block[54] Line 2</td> </tr> <tr> <td>BCLR</td> <td>Macro Block[101] Line 4</td> </tr> <tr> <td>BCLR</td> <td>Macro Block[101] Line 2</td> </tr> <tr> <td>BCLR</td> <td>Macro Block[182] Line 2</td> </tr> <tr> <td>BCLR</td> <td>Macro Block[184] Line 1</td> </tr> <tr> <td>BCLR</td> <td>Macro Block[184] Line 4</td> </tr> </tbody> </table>	Macro Command	Used Point	BCLR	Macro Block[54] Line 2	BCLR	Macro Block[101] Line 4	BCLR	Macro Block[101] Line 2	BCLR	Macro Block[182] Line 2	BCLR	Macro Block[184] Line 1	BCLR	Macro Block[184] Line 4
Macro Command	Used Point														
BCLR	Macro Block[54] Line 2														
BCLR	Macro Block[101] Line 4														
BCLR	Macro Block[101] Line 2														
BCLR	Macro Block[182] Line 2														
BCLR	Macro Block[184] Line 1														
BCLR	Macro Block[184] Line 4														

Operating Procedure

This section explains how to locate the areas where the macro commands "BSET" and "BCLR" (bit setting and resetting) are used.

1. Click [Tool] → [Search] → [Macro Command] to display the [Macro Command Search] view window.
2. Click [Setting] to display the [Macro Command Select] window.

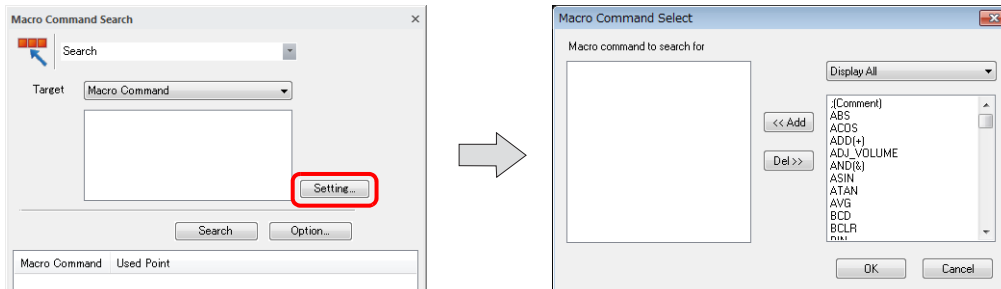

3. Select the [Bit Operation] category, select the [BCLR] and [BSET] macro commands and click the [Add] button. Check that the commands are added to the [Macro command to search for] list and click [OK]. (20 maximum)

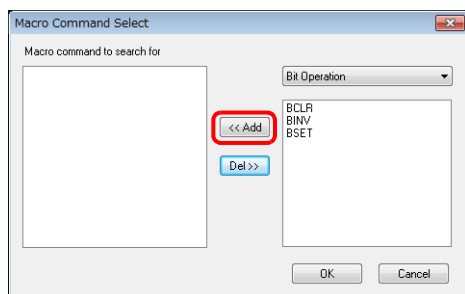

Multiple macro commands are selectable. (logical OR)

- Consecutive selection by dragging the mouse
- Random selection using the [Ctrl] key and clicking

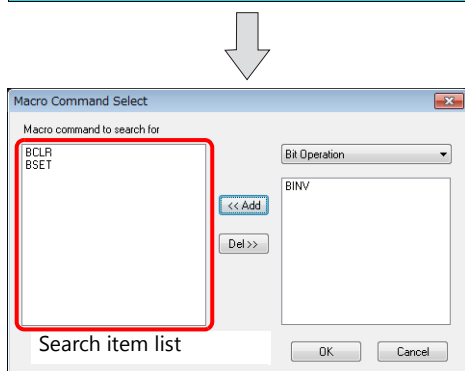

* A maximum of 20 commands can be registered as the macro commands to search for.

4. The target commands are displayed in the [Macro Command Search] view window.

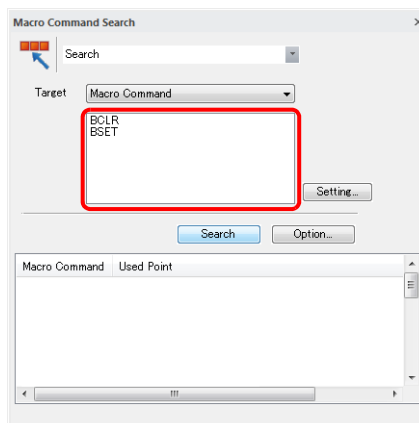

5. Specify the search range.

Click [Option] to display the search range settings.

Select the [Check All] checkbox, specify the search range numbers for each item, and click [OK].

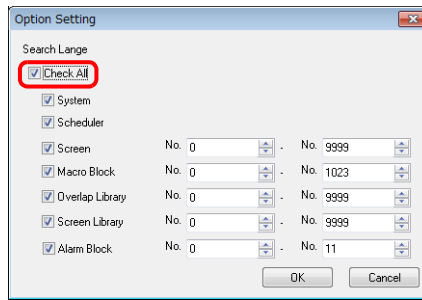

6. Click [Search].

The search result list shows the locations where the macro commands "BSET" and "BCLR" are used in a list.

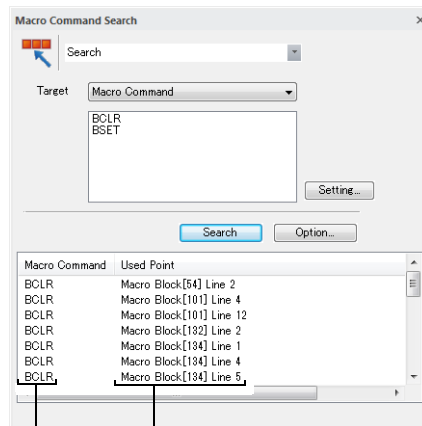

Macro command names

Where the macro commands shown on the left are used

* When nothing is found, "None / No occurrence." appears.

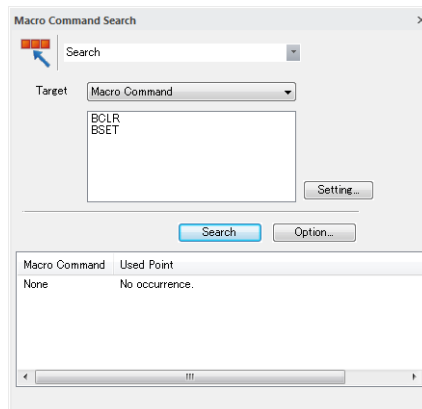

7. Double-click an item in the search result list. This jumps to the selected item.

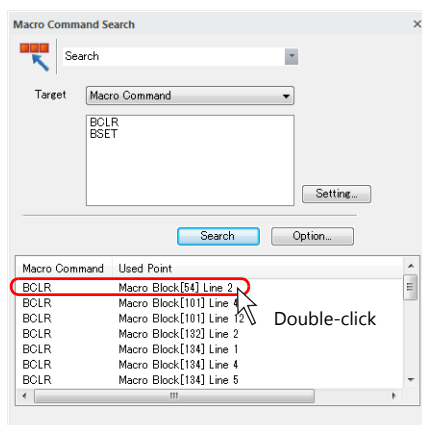

Double-click

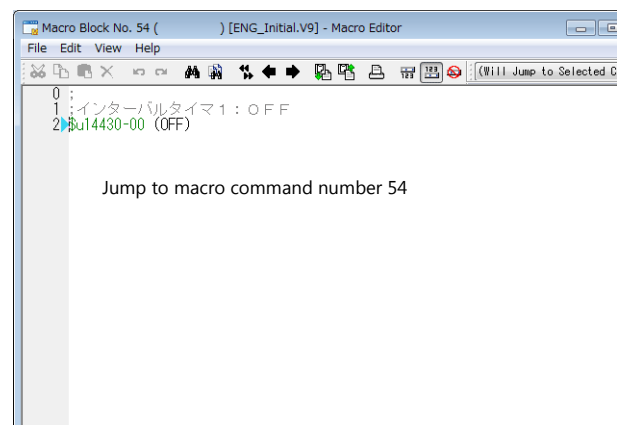

This completes the search procedure.

5.4.6 Cross-reference

Locations set in screens, macro blocks, overlap libraries, and screen libraries can be searched for.

Display Method

Click [Tool] → [Search] → [Cross-reference]. The [Cross-reference] view window is displayed.

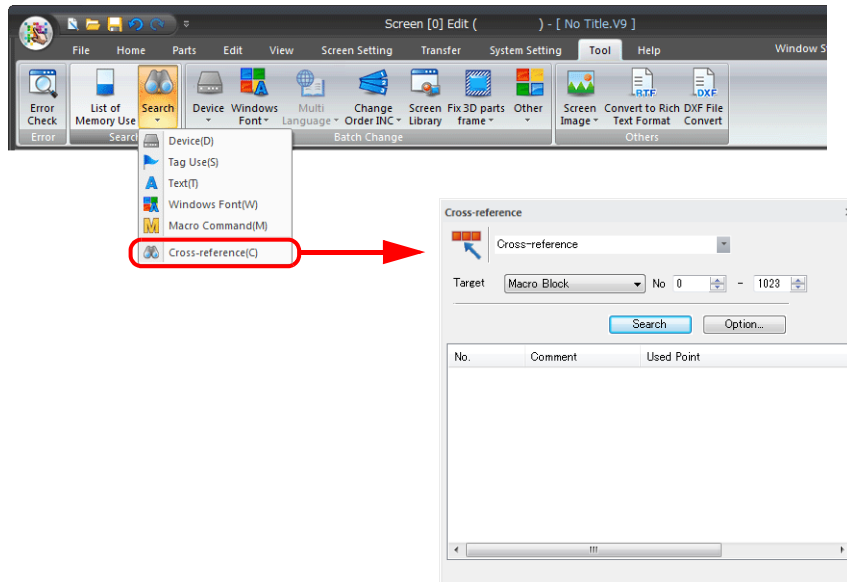

Setting Items

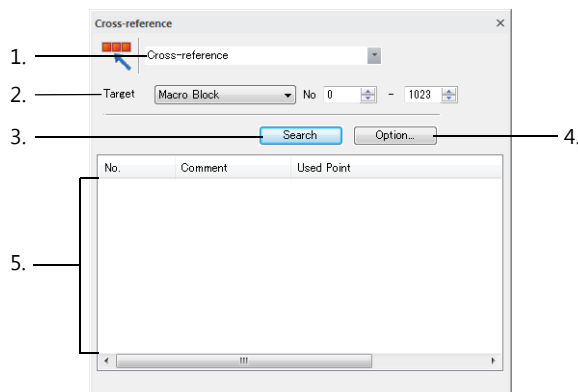

Item	Description
1	<p>Function selection</p> <p>[Cross-reference] Search the screen program for the item specified for [Target] and display the results in a list.</p> <p>[Search] Search the screen program for the specified macro command and display the results in a list. * For more information on searching for macro commands, refer to "5.4.5 Macro Command" page 5-23.</p>
2	<p>Target</p> <p>Specify the type of item and range to search.</p> <ul style="list-style-type: none"> • [Macro Block] • [Screen] • [Overlap Library] • [Screen Library]
3	<p>Search</p> <p>Start the search and display the search results.</p>

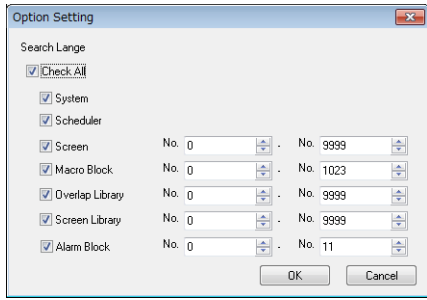
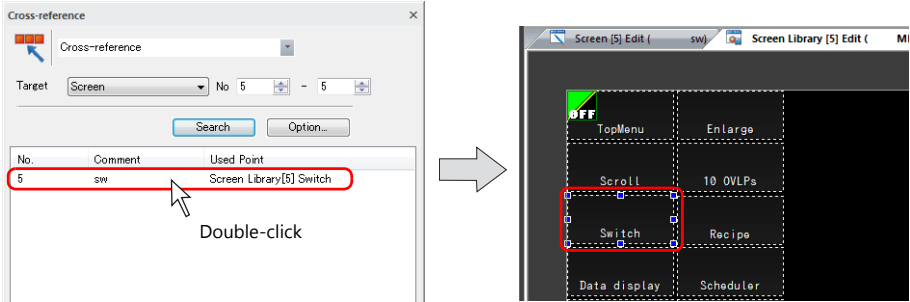
Item	Description
4	Display the [Option Setting] window. Specify the search range. 
5	Displays a list of locations of use. Double-click on an item to jump to the location of use. 

Operating Procedure

This section explains how to find where macro blocks are used.

1. Click [Tool] → [Search] → [Cross-reference] to display the [Cross-reference] view window.
2. Select [Macro Block] for [Target] and specify a range.

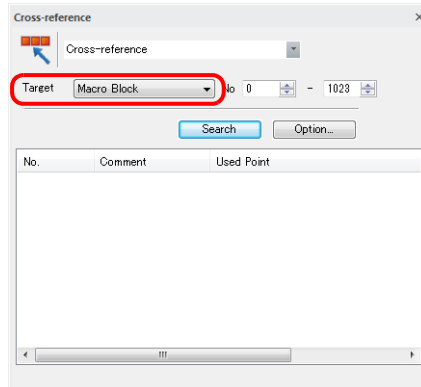

3. Specify the search range.
 Click [Option] to display the search range settings.
 Select the [Check All] checkbox, specify the search range numbers for each item, and click [OK].

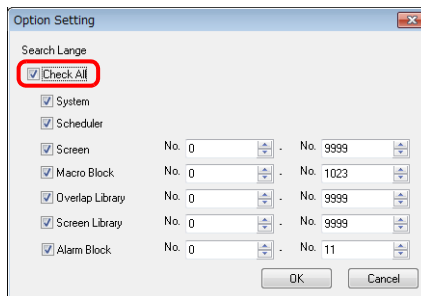

4. Click [Search].

The search result list shows the locations where macro blocks are used in a list.

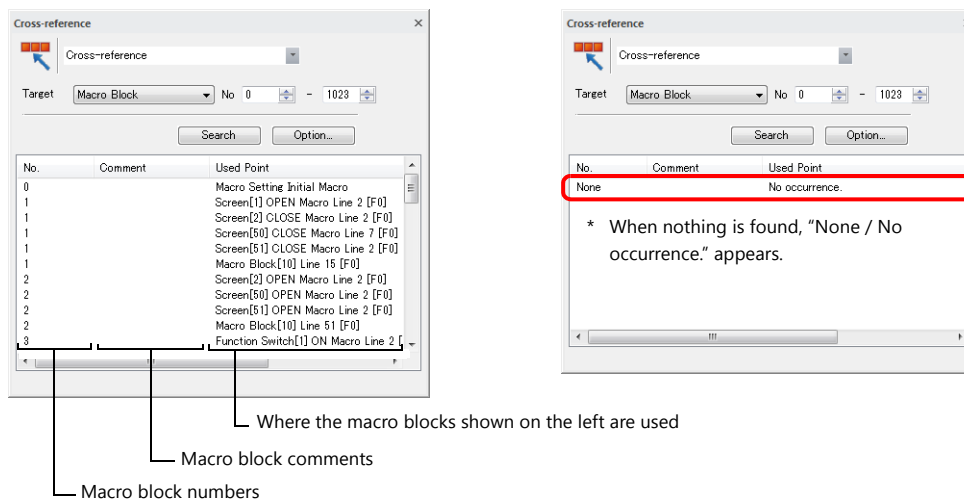

5. Double-click an item in the search result list. This jumps to the selected item.

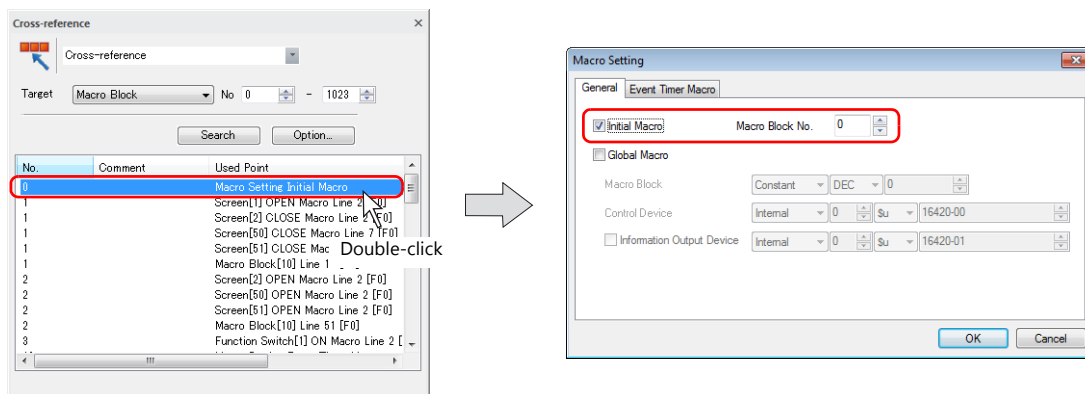

This completes the search procedure.

5.5 Batch Change

5.5.1 Device Memory Addresses

Changing All Device Memory Addresses

Device memory addresses allocated to the file currently being edited can be changed all at once. Up to 10 different device memory ranges can be defined.

Operating procedure

1. Click [Tool] → [Device] → [Batch Change].
The [Batch Change Device] window is displayed.

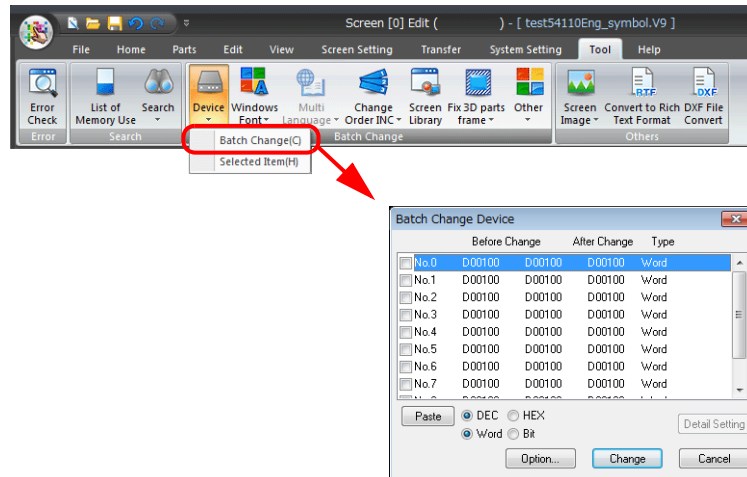

2. Select the [No.] checkboxes of the desired numbers.
The [Detail Setting] button becomes enabled.

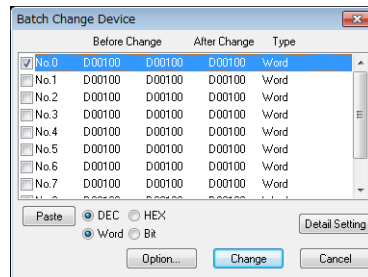

3. Click the [Detail Setting] button. The [Device Setting] window is displayed.

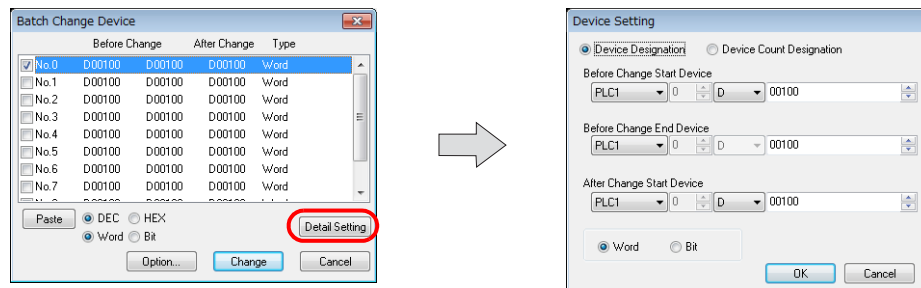

4. First, select [Bit] or [Word]. Changes to device memory is performed in units of bits or words as selected.
5. Enter the top address of the device memory addresses to be changed for [Before Change Start Device]. Likewise, enter the last address of the device memory addresses to be changed for [Before Change End Device].
6. Enter the desired top address after change for [After Change Start Device] in the same manner.
7. When the settings are complete, click [OK]. The [Batch Change Device] window is displayed again.
8. Click [Option] and select the items whose memory addresses should be changed.
For more information, refer to the next section.
9. Click [Change] to perform a batch change of the specified memory addresses.

Option settings

Clicking the [Option] button in the [Batch Change Device] window displays the following [Change Item Select] window.

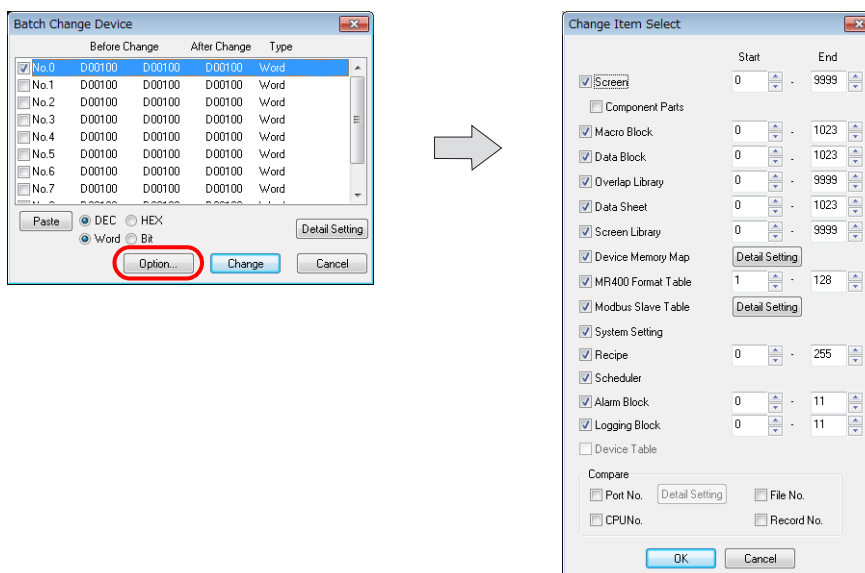

Item	Description
Screen Component Parts Macro Block Data Block Overlap Library Data Sheet Screen Library Device Memory Map MR400 Format Table Modbus Slave Table System Setting Recipe Scheduler Alarm Block Logging Block	Select the checkboxes of the items targeted for device memory change. To specify the range of device memory addresses, enter values for [Start] and [End].
Device Table	This option is used for component parts.
Port No.	This option is valid when [1:n] (multi-drop) is selected for [Connection Mode]. Select this checkbox to include the port numbers of PLC 1 to PLC 8 in targets for device memory change.
CPUNo	Select this checkbox when a CPU number is set for the connected device.
File No. Record No.	Select these checkboxes to include memory card addresses in targets for memory change.

Changing Device Memory of Selected Items Only

Device memory addresses of the selected screen items in the file currently being edited can be changed simultaneously.

Operating procedure

1. Select the items for device memory change on the screen using the mouse.
2. Click [Tool] → [Device] → [Selected Item], or click [Change Device] in the right-click menu.

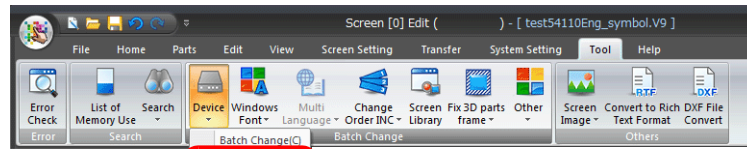

Or
right-click menu

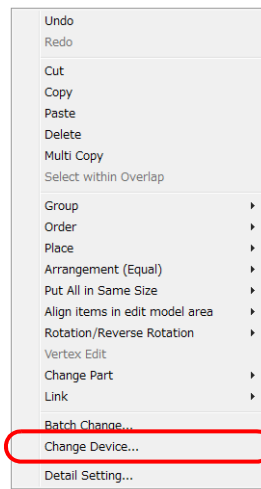

3. The [Batch Change Device] window is displayed. The device memory addresses assigned to the selected items automatically appear in the window.

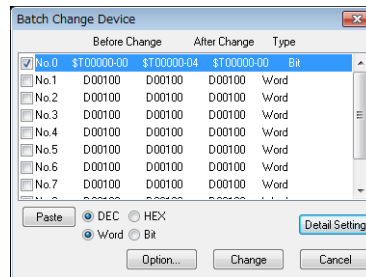

4. Select the [No.] checkboxes of the desired numbers. The [Detail Setting] button becomes enabled.
5. Click the [Detail Setting] button. The [Device Setting] window is displayed.
6. First, select [Bit] or [Word]. Changes to device memory is performed in units of bits or words as selected.
7. Enter the top address of the device memory addresses to be changed for [Before Change Start Device]. Likewise, enter the last address of the device memory addresses to be changed for [Before Change End Device].
8. Enter the desired top address after change for [After Change Start Device] in the same manner.
9. When the settings are complete, click [OK]. The [Batch Change Device] window is displayed again.
10. Click [Option] and select the items whose memory addresses should be changed.
For more information, refer to the next section.
11. Click [Change] to perform a batch change of the specified memory addresses.

Option settings

Clicking the [Option] button in the [Batch Memory Change] dialog brings up the following [Change Item Select] dialog.

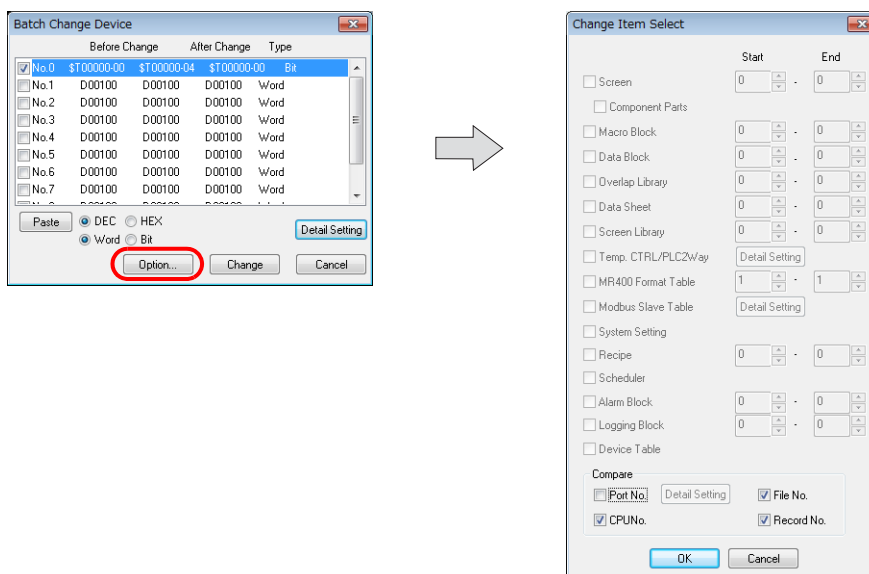

Item	Description
Port No.	This option is valid when [1:n] (multi-drop) is selected for [Connection Mode]. Select this checkbox to include the port numbers of PLC 1 to PLC 8 in targets for device memory change.
CPU No	Select this checkbox when a CPU number is set for the connected device.
File No. Record No.	Select these checkboxes to include memory card addresses in targets for memory change.

5.5.2 Windows Font

Utilize this menu when using Windows fonts.

For more information, refer to "10.4.5 Change All Windows Fonts" page 10-17.

5.5.3 Multi Language

Multi Language Batch Change

Properties of items placed on multi-language screens are readily changeable in a batch. This method of batch change can be implemented on a language basis for languages 1 to 16 used on multi-language screens.

Example: Changing the properties of the text on switches
Language 2: English/Western Europe

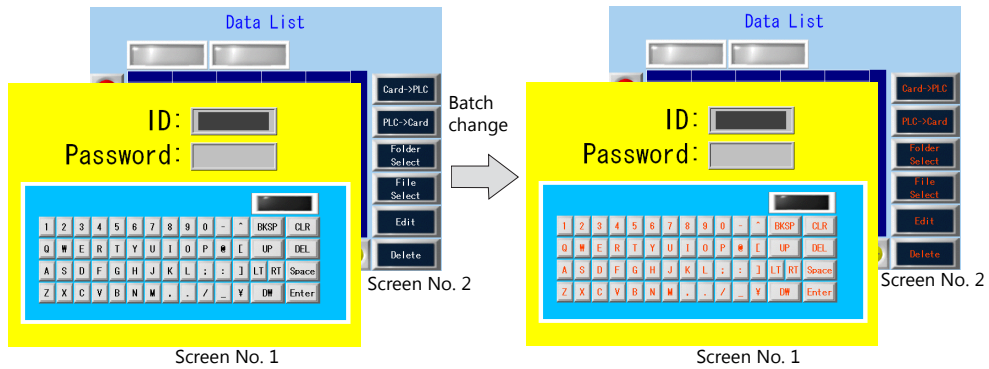

Location of settings

Click [Tool] → [Multi Language] → [Multi Language Batch Change]. The [Multi Language Batch Change] window is displayed.

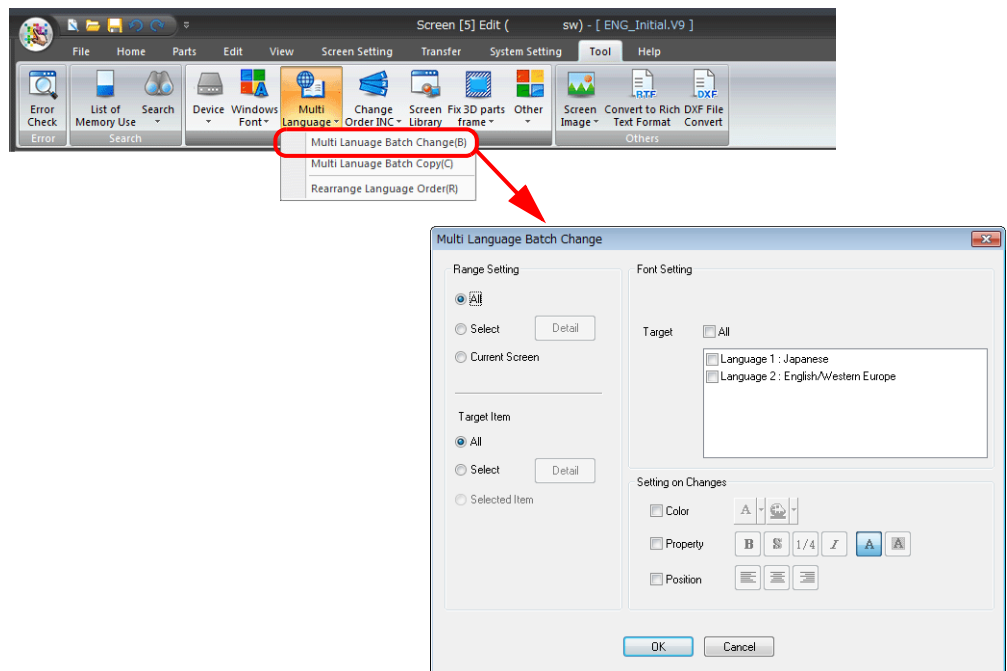

Setting items

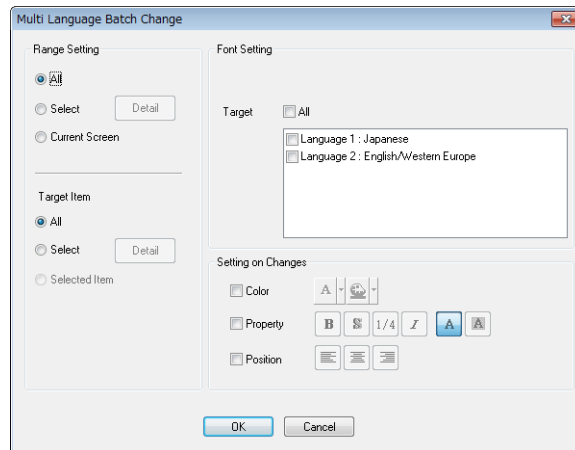

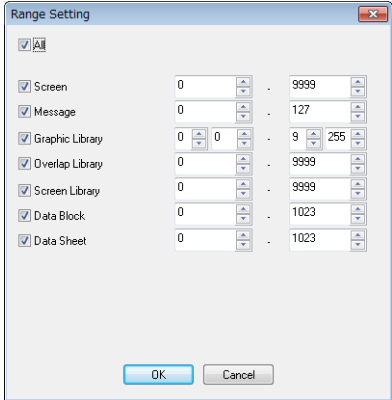
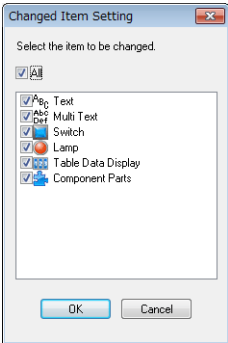
Item	Description
Range Setting	<p>Specify the range for multi-language batch change.</p> <ul style="list-style-type: none"> • [All] Perform changes to all screens. • [Select] Use the [Detail] button to display the [Range Setting] window. Specify the range for changing.  <ul style="list-style-type: none"> • [Current Screen] Only perform changes on the currently displayed screen.
Target Item	<p>Specify the target items for multi-language batch change.</p> <ul style="list-style-type: none"> • [All] Perform changes on all items. • [Select] Use the [Detail] button to display the [Changed Item Setting] window. Select the items targeted for changing.  <ul style="list-style-type: none"> • [Selected Item] Only perform changes on the currently selected item.
Font Setting	<p>Target</p> <p>Select the target languages for performing the multi-language batch change.</p> <ul style="list-style-type: none"> • [All] Perform changes to all languages. • Language 1 to 16 Only perform changes to the languages with a selected checkbox.

Item	Description
Setting on Changes	Set the change details. <ul style="list-style-type: none"><li data-bbox="571 226 847 275">• [Color] Set the text color to change to.<li data-bbox="571 275 890 324">• [Property] Set the text properties to change to.<li data-bbox="571 324 890 374">• [Position] Set the text alignment to change to.

Setting procedure

The procedure is explained with an example shown below.

Switches on screen No. 1 and 2 in language 2

Text color: White, black Text color: Orange
Text properties: Standard Text properties: Boldface

1. Open a multi-language screen program.
Click [Tool] → [Multi Language] → [Multi Language Batch Change].
The [Multi Language Batch Change] window is displayed.
2. Batch change in this example targets the properties of the switches on screen No. 1 and 2. Go to the [Range Setting] area in the window, select the [Select] radio button, and click the [Detail] button. In the [Range Setting] window that is displayed, select the [Screen] checkbox and specify screen No. 1 and 2 as the range. Also go to the [Target Item] area, select the [Select] radio button, and click the [Detail] button. In the [Changed Item Setting] window that is displayed, select the [Switch] checkbox.

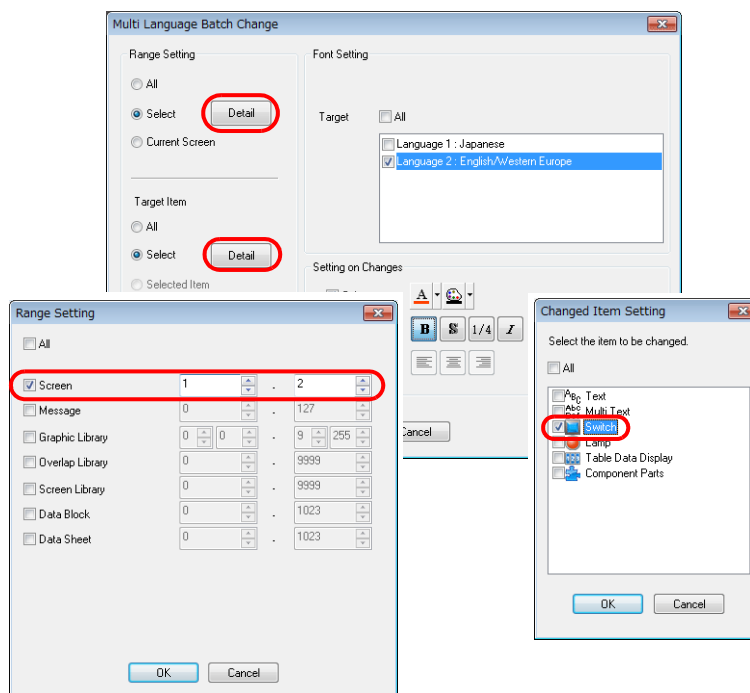

3. Go to the [Setting on Changes] area. Select the [Color] checkbox and select orange. Also, select the [Property] checkbox and select boldface.

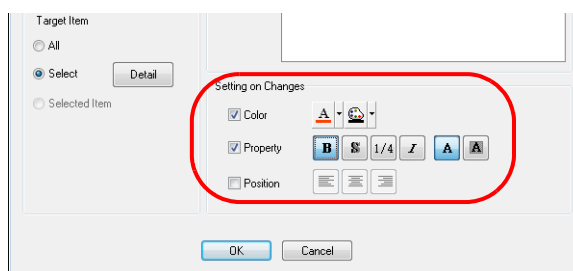

4. Review the settings and then click [OK].
The following dialog box is displayed.

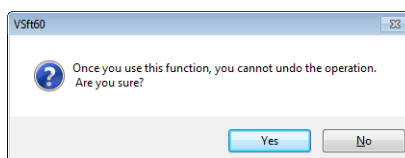

If you wish to proceed, click [Yes].
The settings are updated.

Multi Language Batch Copy

For multi-language screens, if there are locations where exactly the same text as language 1 is to be used, such as text on keypads and item numbers, they can be easily copied at once by using this function.

Example: Copying the text and characters on switches in a batch
 Language 1: Japanese 32
 Language 2: English/Western Europe

- Before copying



- After copying

Batch copy



Location of settings

Click [Tool] → [Multi Language] → [Multi Language Batch Copy]. The [Multi Language Batch Copy] window is displayed.

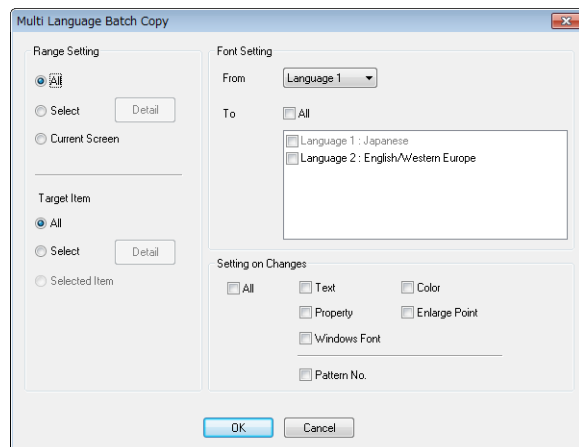
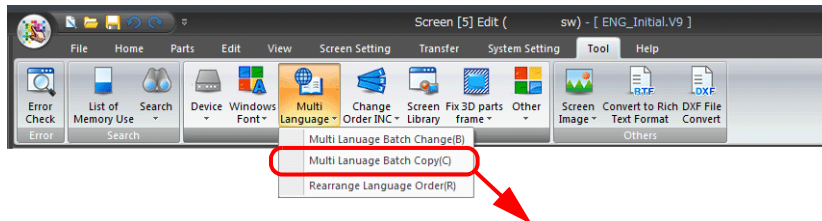

Setting items

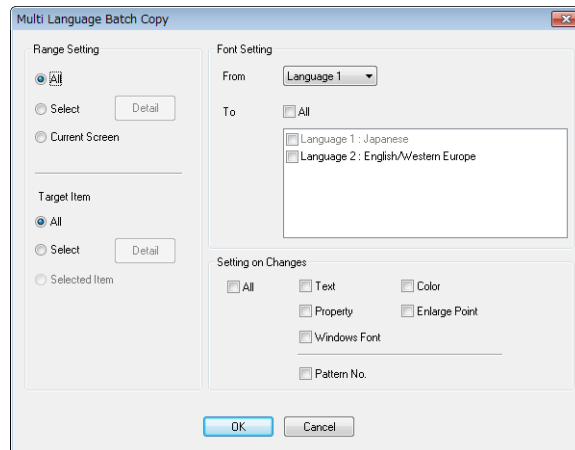

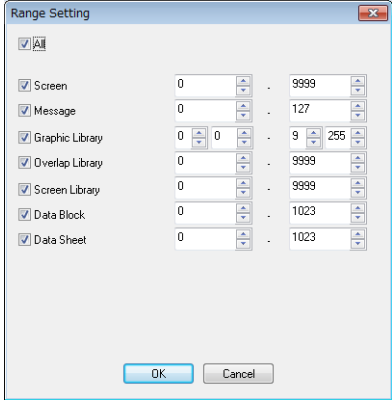
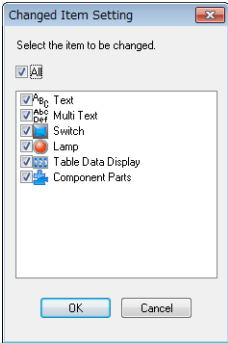
Item	Description	
Range Setting	<p>Specify the range for multi-language batch copy.</p> <ul style="list-style-type: none"> [All] Perform copying on all screens. [Select] Use the [Detail] button to display the [Range Setting] window. Specify the range for copying.  <ul style="list-style-type: none"> [Current Screen] Only perform changes on the currently displayed screen. 	
Target Item	<p>Specify the target items for multi-language batch copy.</p> <ul style="list-style-type: none"> [All] Perform copying on all items. [Select] Use the [Detail] button to display the [Changed Item Setting] window. Select the items targeted for changing.  <ul style="list-style-type: none"> [Selected Item] Only perform copying on the currently selected item. 	
Font Setting	From	Specify the copy source language.
	To	<p>Specify the copy target language.</p> <ul style="list-style-type: none"> [All] Perform copying to all languages. Language 1 to 16 Only perform copying to the languages with a selected checkbox.

Item	Description
Setting on Changes	Select the content to be copied. <ul style="list-style-type: none">• Text• Color• Property• Enlarge Point• Windows Font• Pattern No.

Setting procedure

The procedure is explained with an example in which the text and the characters on the switches placed on a screen in language 1 are copied to another screen in language 2.

1. Open a multi-language screen program.
Click [Tool] → [Multi Language] → [Multi Language Batch Copy].
The [Multi Language Batch Copy] window is displayed.
2. Batch copy in this example targets all the text and switches in language 1. Go to the [Range Setting] area in the window and select the [All] radio button. Go to the [Target Item] area, select the [Select] radio button, and click the [Detail] button. In the [Changed Item Setting] window that is displayed, select the [Text] and [Switch] checkboxes.

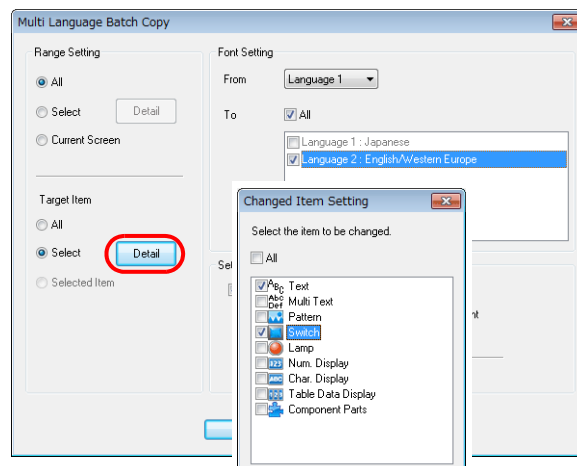

3. Go to the [Font Setting] area in the [Multi Language Batch Copy] window. Select [Language 1] for [From] and [Language 2] for [To].

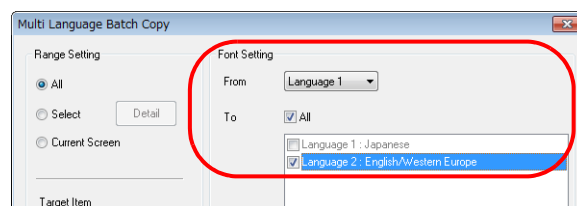

4. Batch copy in this example targets all properties. Go to the [Setting on Changes] area and select the [All] radio button.

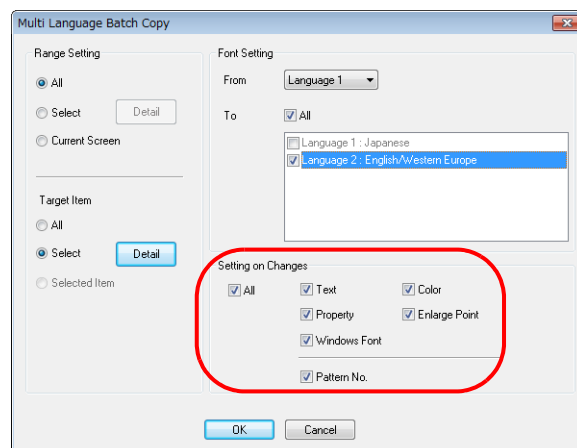

5. Review the settings and then click [OK].
The following dialog box is displayed.

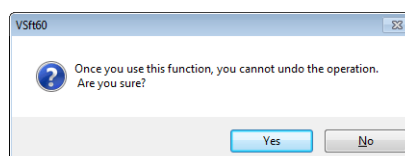

If you wish to proceed, click [Yes].
The settings are updated.

Rearrange Language Order

The order of languages 1 to 16 on multi-language screen programs can be switched easily using this command.

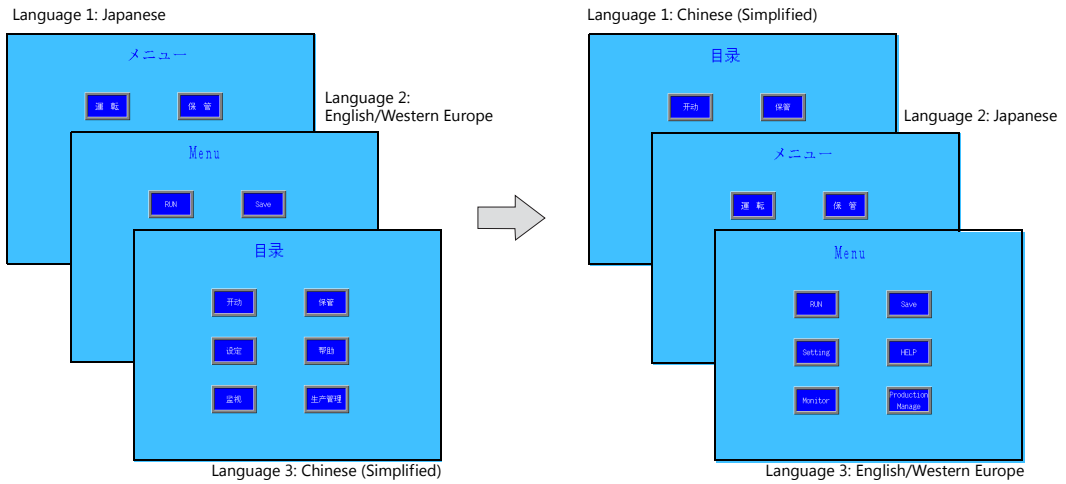

Location of settings

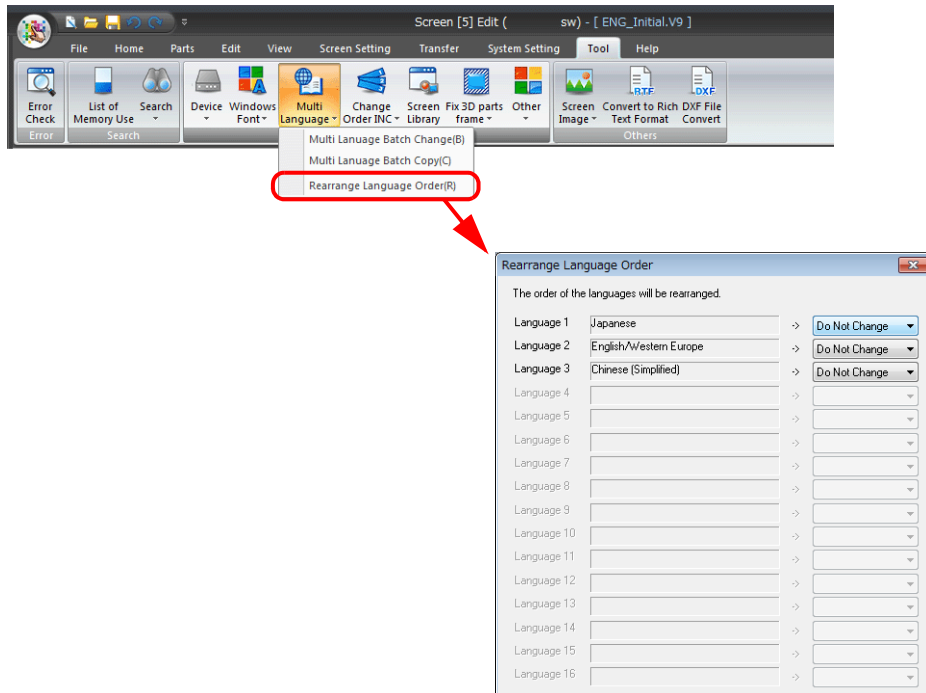

Setting items

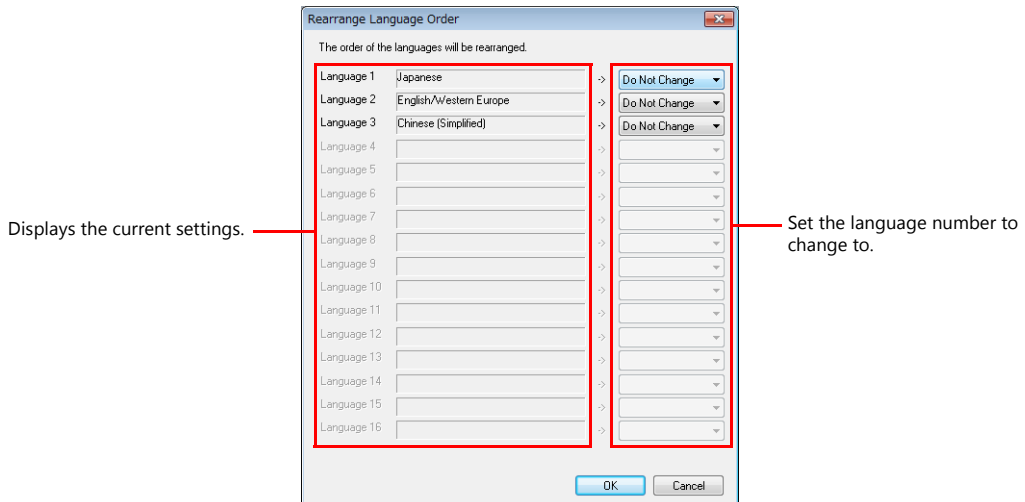

Setting procedure

The procedure is explained with the settings shown below as an example.

Language 1: Japanese → Language 1: Chinese (Simplified)
 Language 2: English/Western Europe → Language 2: Japanese
 Language 3: Chinese (Simplified) → Language 3: English/Western Europe

1. Open a multi-language screen program.
 Click [Tool] → [Multi Language] → [Rearrange Language Order].
 The [Rearrange Language Order] window is displayed.
2. Select [Language 2] in the [Language 1] pull-down menu so that the language 1 setting of [Japanese (Gothic) TTF] is changed to language 2.

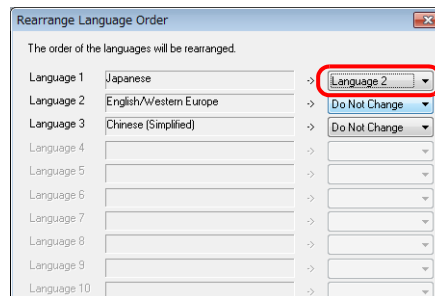

3. Select [Language 3] in the [Language 2] pull-down menu so that the language 2 setting of [English/Western Europe Gothic TTF] is changed to language 3.

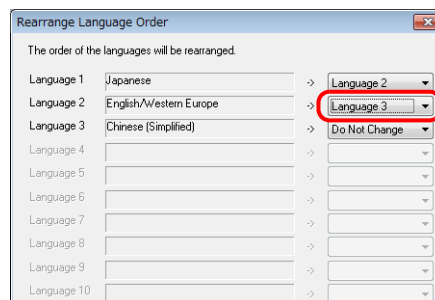

4. Select [Language 1] in the [Language 3] pull-down menu so that the language 3 setting of [Chinese (Simplified) TTF] is changed to language 1.

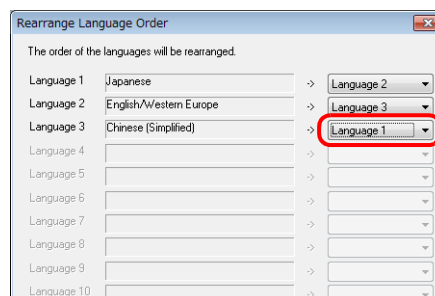

5. Review the settings and then click [OK].
 The following dialog box is displayed.

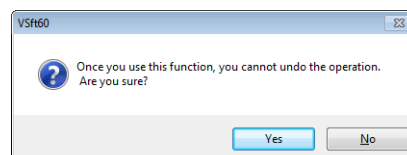

If you wish to proceed, click [Yes].
 The selected languages are rearranged and displayed.

5.5.4 Change Order INC

When numerical data or character display parts in entry mode are placed on the screen, the cursor will move to these parts according to the selection order allocated to the parts. If these display parts have the same cursor movement order number, the cursor movement order depends on the sequence of part placement during screen configuration.

With the cursor order increment batch change command explained in this section, the cursor movement order numbers of display parts can be changed in a batch according to the order of coordinates (or placement). Cursor movement order batch change is also possible according to the order of mouse clicking.

Example: Change the cursor movement which is out of order to descending order.

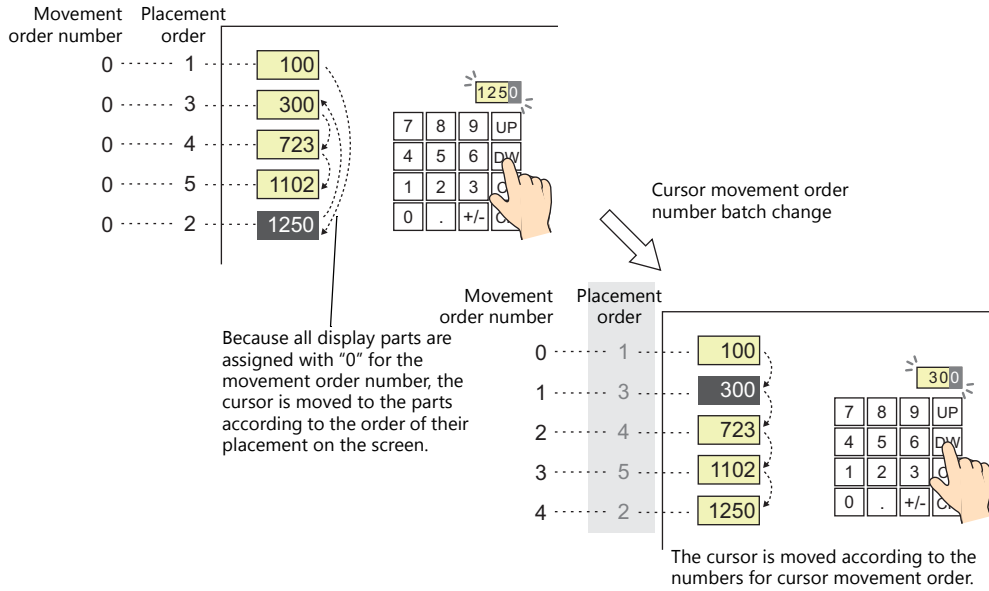

- Order of coordinates "↓"

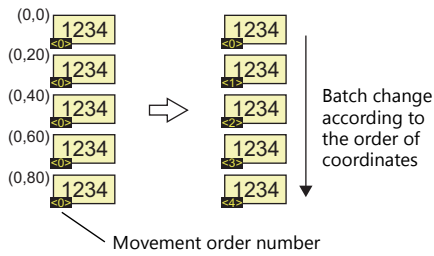

- Order specified with mouse

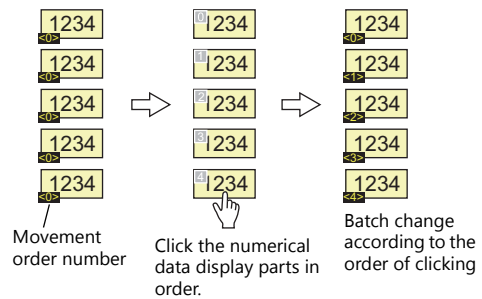

* Movement order numbers can be set to the order of placement. For more information on the procedure, refer to "[Automatic Allocation]: [Placement Order]" (page 5-49).

Target Items

- Numerical data display (Function: Entry Target)
- Character display (Function: Entry Target)

Location of Settings

Click [Tool] → [Change Order INC] → [Batch Change] or [Selected Item].

If there is no numerical data or character display part (of which [Function: Entry Target]), the message "Target item is not registered." appears.

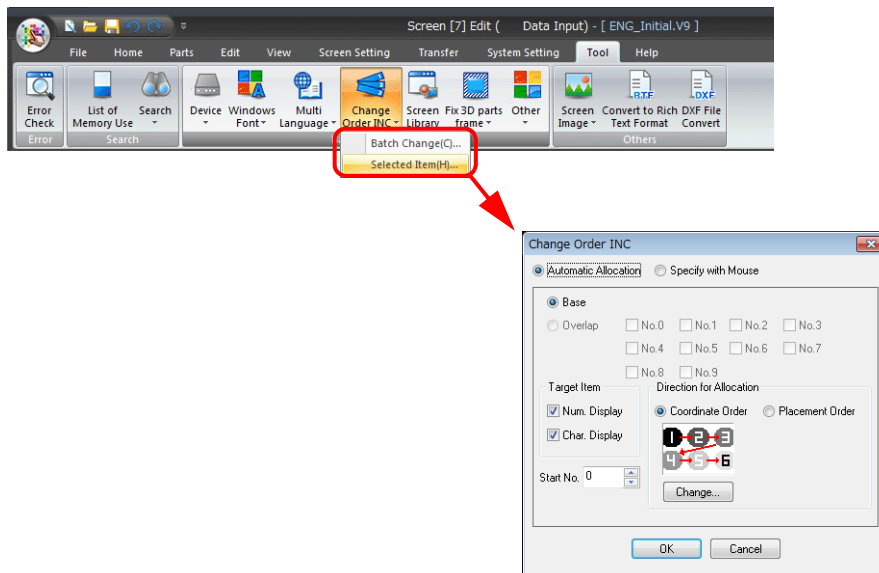

- * To see the cursor movement order numbers currently set for the display parts, click [View] → [Display Environment] → [Display]. On the [Display] tab, select the [Display Order INC] checkbox. **Cursor movement order numbers are displayed in yellow at the bottom-left corners of the individual display parts.**

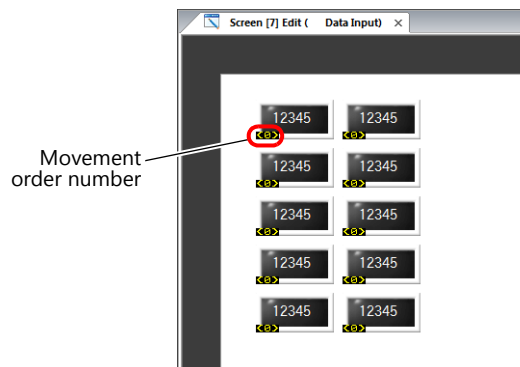
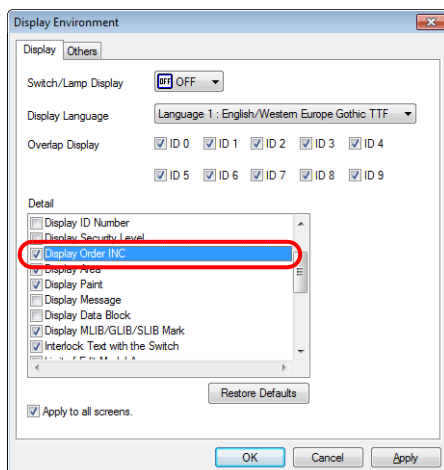

Setting Items

[Change Order INC] window

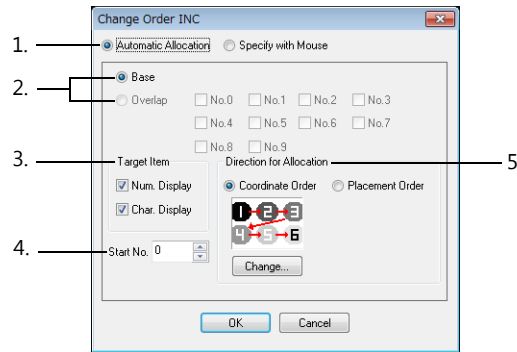

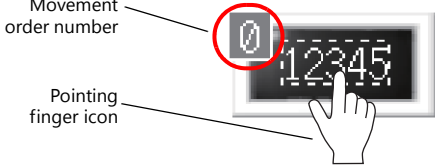
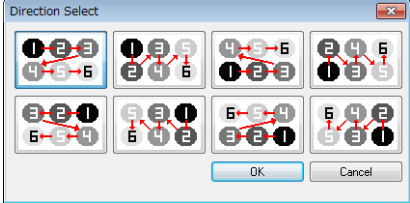
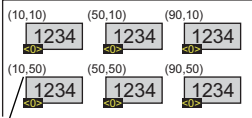
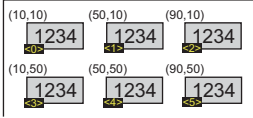
Item	Description
1	<p>[Automatic Allocation] Select this option when changing the movement order numbers in a batch according to [Direction for Allocation] explained in "5."</p> <p>[Specify with Mouse] Select this option when changing the movement order numbers according to the order in which the display parts are clicked with the mouse. The window for movement order number setting is displayed for [Specify with Mouse]. In the window, pointing to a numerical data or character display part ([Function: Entry Target]) with the mouse changes the cursor pointer to a pointing finger icon.</p> 
2	<p>[Base] Display parts placed on the screen currently being edited are targeted for movement order change.</p> <p>[Overlap] Display parts placed on the overlap of the checked ID are targeted for movement order change.</p>
3	<p>Target Item Num. Display/Char. Display</p> <p>Select the type of target item.</p>
4	<p>Start No.</p> <p>Specify the first number of the movement order. Order numbers starting from the number specified here will be allocated.</p>
5	<p>Direction for Allocation</p> <p>This setting is available when [Automatic Allocation] ("1") is selected.</p> <p>[Coordinate Order] The movement order number is determined based on the top-left coordinates of the display parts. A different direction can be selected using the [Change] button.</p>  <p>Example: Start No. 0, Direction → (to the right)</p> <div style="display: flex; justify-content: space-around; align-items: flex-start;"> <div style="text-align: center;"> <p>Before change</p>  </div> <div style="text-align: center;"> <p>After change</p>  </div> </div> <p>Top-left x and y coordinates of the display part</p> <p>[Placement Order] Movement order is determined based on the order in which display parts were placed on the screen.</p>

Order Change Procedure

[Automatic Allocation]: [Coordinate Order]

The procedure is explained with the settings shown below as an example.

- Target item: Numerical display
- Direction: Downward (↓)
- Cursor movement order start number: 5

1. Select five numerical data display parts for cursor movement order change.

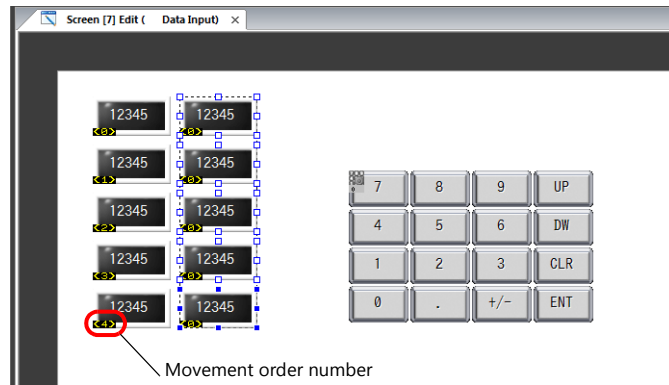

2. Click [Tool] → [Change Order INC].
3. Click [Selected Item].
4. The [Change Order INC] window is displayed. Configure the following settings.

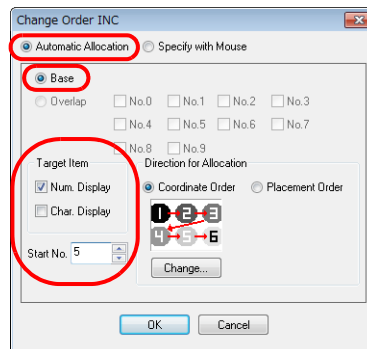

5. Select [Coordinate Order] for [Direction for Allocation]. Click [Change] to display the [Direction Select] window and select the downward direction "↓".

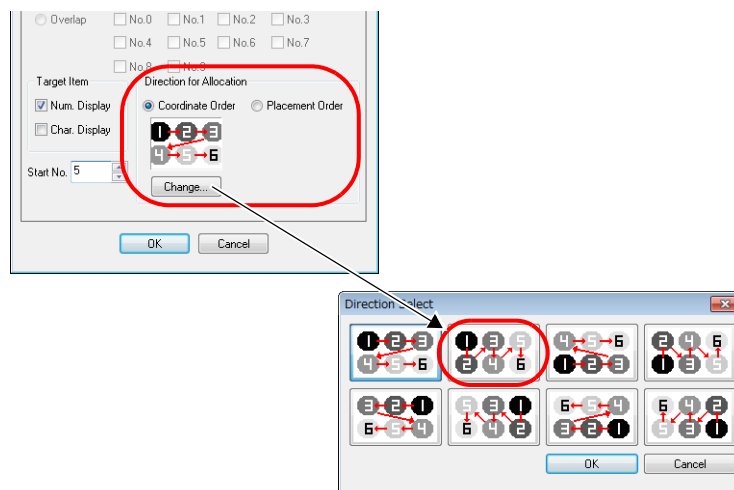

6. Review the settings and then click [OK].

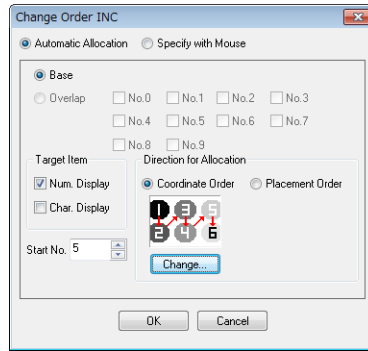

7. Cursor movement order numbers are allocated to the display parts based on the order of coordinates.

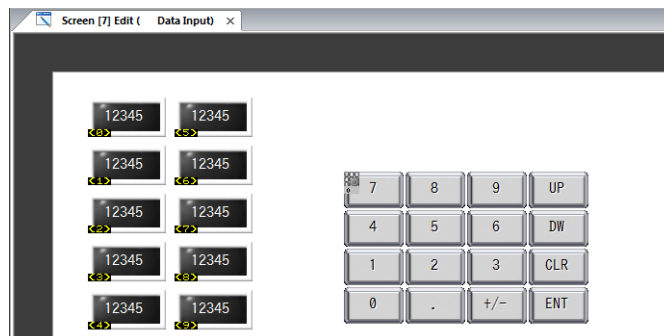

[Automatic Allocation]: [Placement Order]

The procedure is explained with the settings shown below as an example.

- Target item: Numerical display
- Cursor movement order start number: 5

1. Select five numerical data display parts for cursor movement order change.

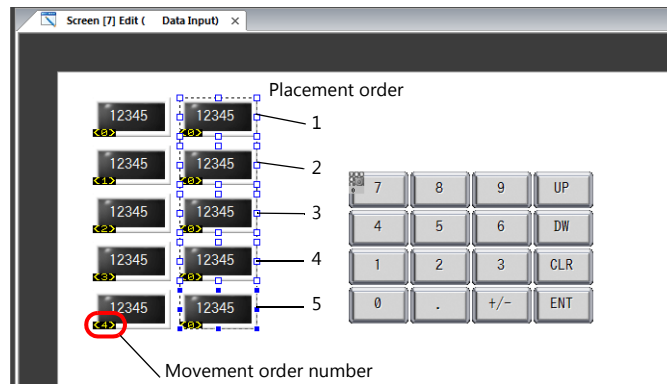

2. Click [Tool] → [Change Order INC].
3. Click [Selected Item].
4. The [Change Order INC] window is displayed.
Configure the following settings.

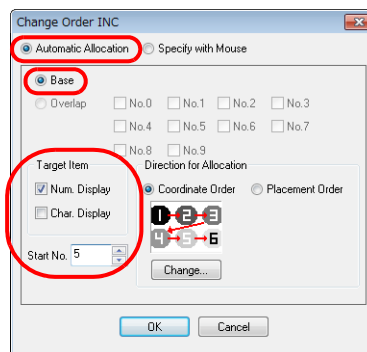

5. Select [Placement Order] for [Direction for Allocation].

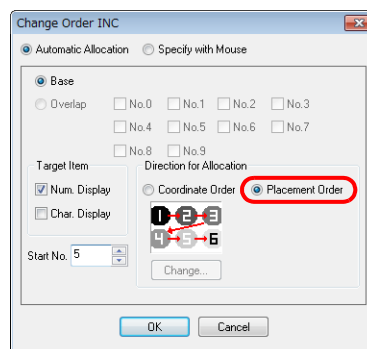

6. Review the settings and then click [OK].
7. Cursor movement order numbers are allocated to the display parts based on the order of placement.



[Specify with Mouse]

The procedure is explained with the settings shown below as an example.

- Target item: Numerical display
- Cursor movement order start number: 5

1. Select five numerical data display parts for cursor movement order change.

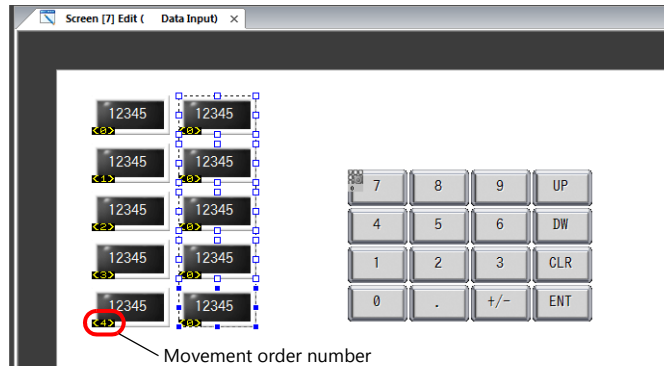

2. Click [Tool] → [Change Order INC].
3. Click [Selected Item].
4. The [Change Order INC] window is displayed. Configure the following settings.

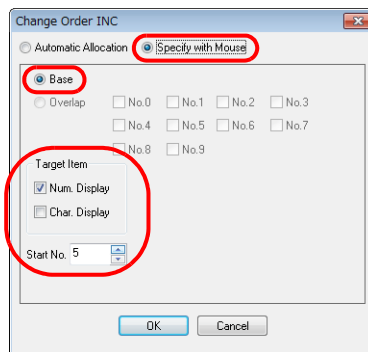

5. Review the settings and then click [OK].
6. A confirmation dialog box is displayed. Click [OK].

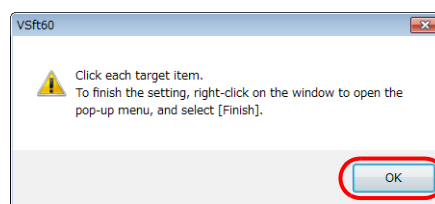

7. The following window is displayed. *
Movement order numbers appear at the top-left corners of the numerical data display parts (of which [Function: Entry Target]). Click the numerical data display parts one by one to set their movement order numbers. Once a movement order number has been set at the top-left corner of a data display part, the number turns yellow.

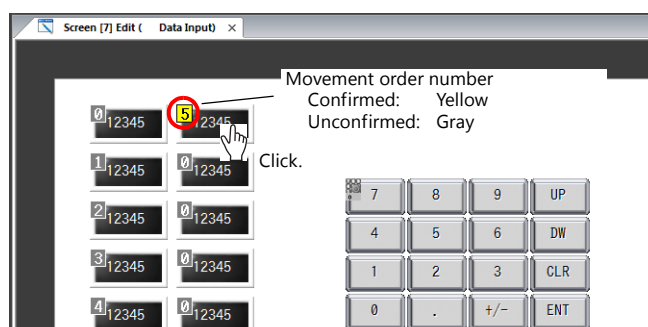

* This mode is provided solely for setting cursor movement order numbers of display parts. To exit, select [Finish] or [Cancel] from the right-click menu.

8. When changing the start number of the movement order, select [Change Start No.] from the right-click menu. Set a number for [Start No.] and click [OK].

Now order numbers starting from the newly specified number are allocated. *

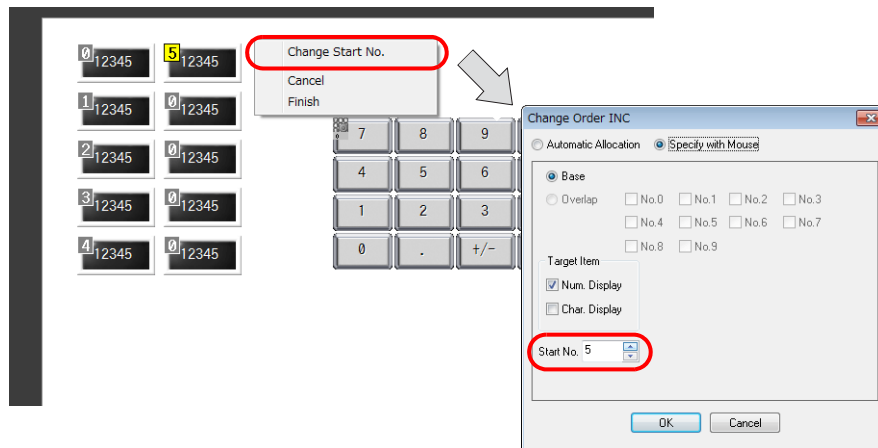

- * Even if the top-left numbers are confirmed (in yellow), changing the [Start No.] restores the numbers starting from [Start No.] to the unconfirmed status (in gray).

Example: When [Start No. 6] is specified

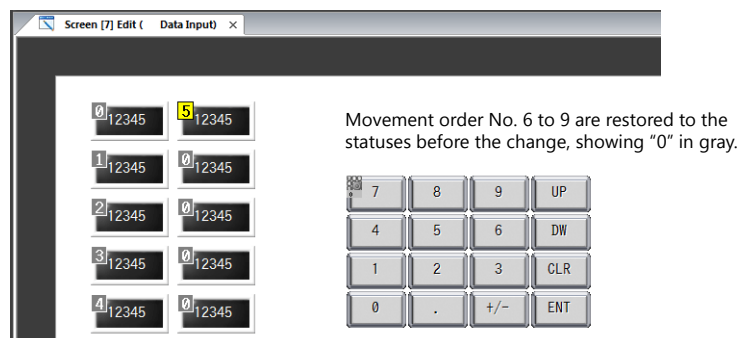

To completely reset the cursor movement order numbers, click [Cancel] on the right-click menu. Perform the previous steps again from step 1.

9. To accept the movement order settings made, click [Finish] on the right-click menu. (To cancel the changes, click [Cancel].)

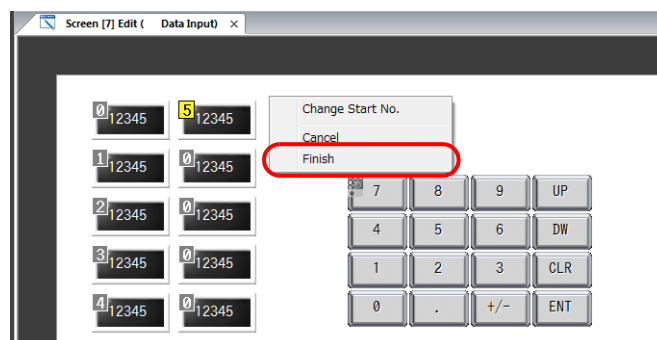

10. Cursor movement order numbers are allocated to the display parts.

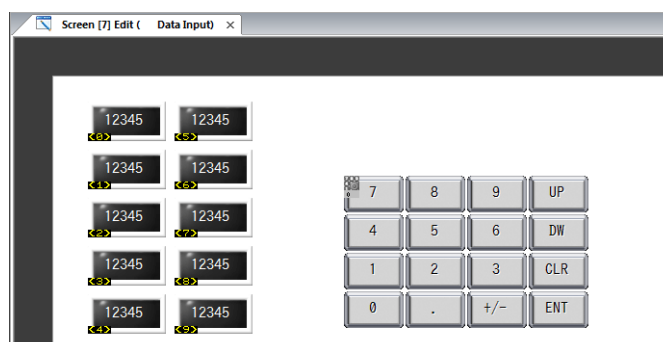

5.5.5 Screen Library

Perform a batch change of the numbers of screen libraries placed on the screen.

Example: Batch change screen library numbers 0 through 10 to numbers 100 onwards

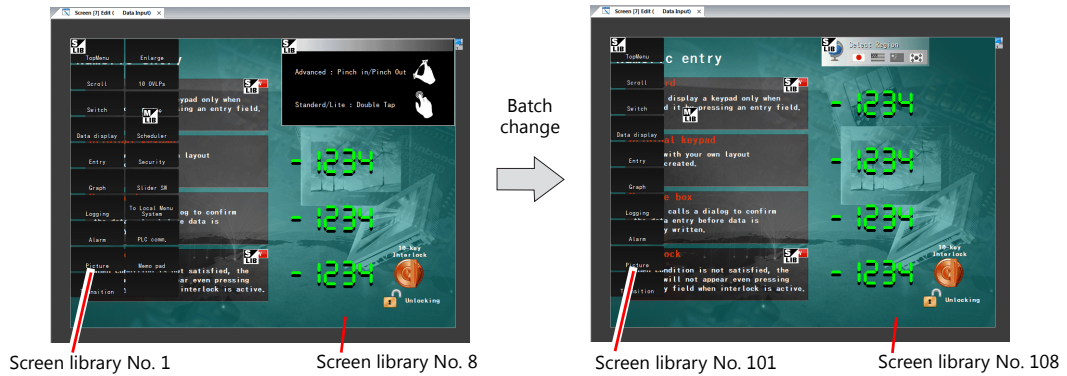

Setting Method

1. Click [Tool] → [Screen Library] to display the [Screen Library Batch Change] window.

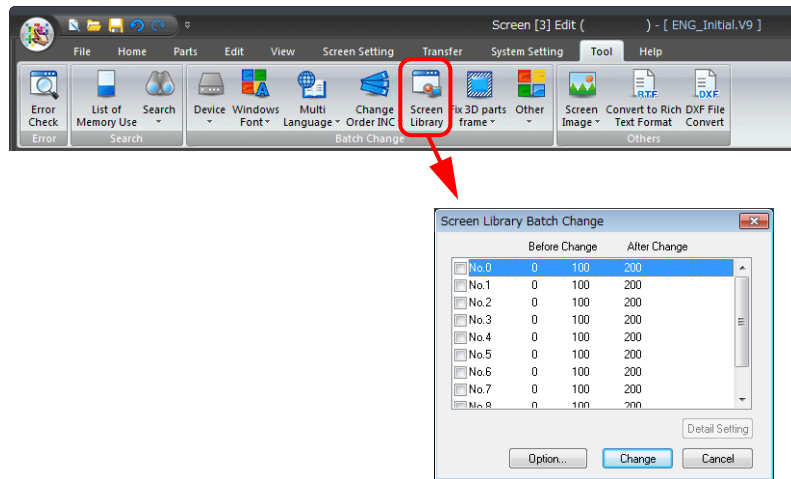

2. Select the [No.] checkboxes of the desired numbers. The [Detail Setting] button becomes enabled.
3. Click the [Detail Setting] button. The [Detail Setting] window is displayed.

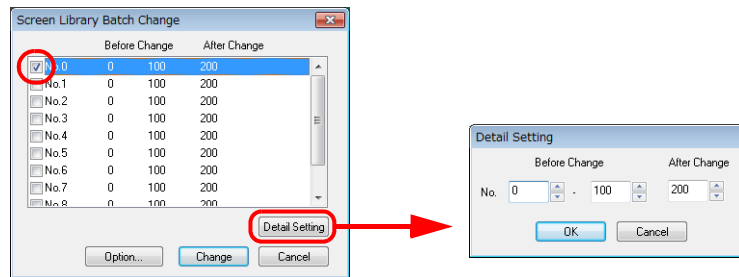

4. Enter the first number and last number to be changed for [Before Change].
Enter the first number after the change for [After Change] in the same manner.

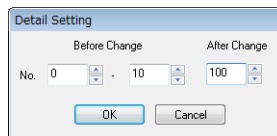

5. When the settings are complete, click [OK]. The [Screen Library Batch Change] window is displayed again.

6. Click [Option] and select the items whose numbers should be changed.

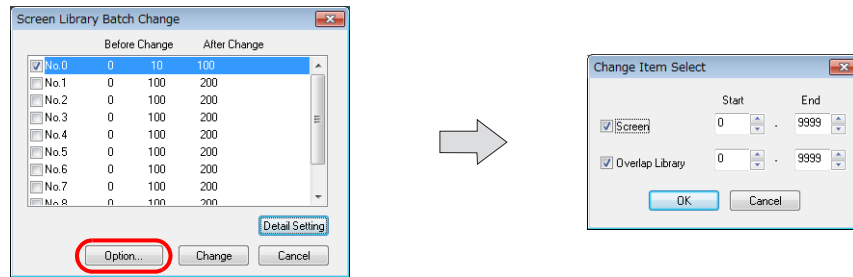

Item	Description
Screen	Select the checkboxes of the items targeted for number change. To specify the range, enter numbers for [Start] and [End].
Overlap Library	

7. Click [Change] to perform a batch change of screen library numbers.

This completes the procedure.

5.5.6 Fix 3D Parts Frame

When using 3D parts, they can be enlarged and reduced while maintaining a fixed frame size. The frame size of multiple parts can be set at once by performing a batch change using [Fix 3D parts frame].

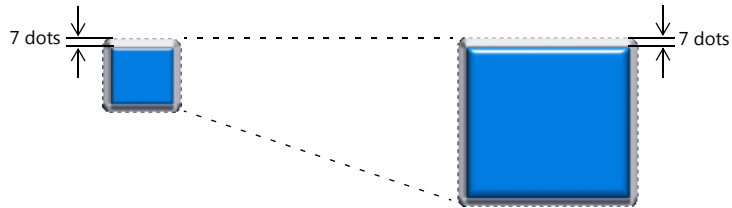

 **Target parts**
 Switches, lamps, numerical data displays, character displays, message displays, slider switches, bar graphs, pie graphs, panel meters, statistic pie graphs, calendars, and scroll bars with [Shape] set to [Real] or [3D] and [Group] set to [Square].

Setting Method

1. Click [Tool] → [Fix 3D parts frame] → [Change All], [Current Window], or [Selected Item]. The [Set Selected] window is displayed.

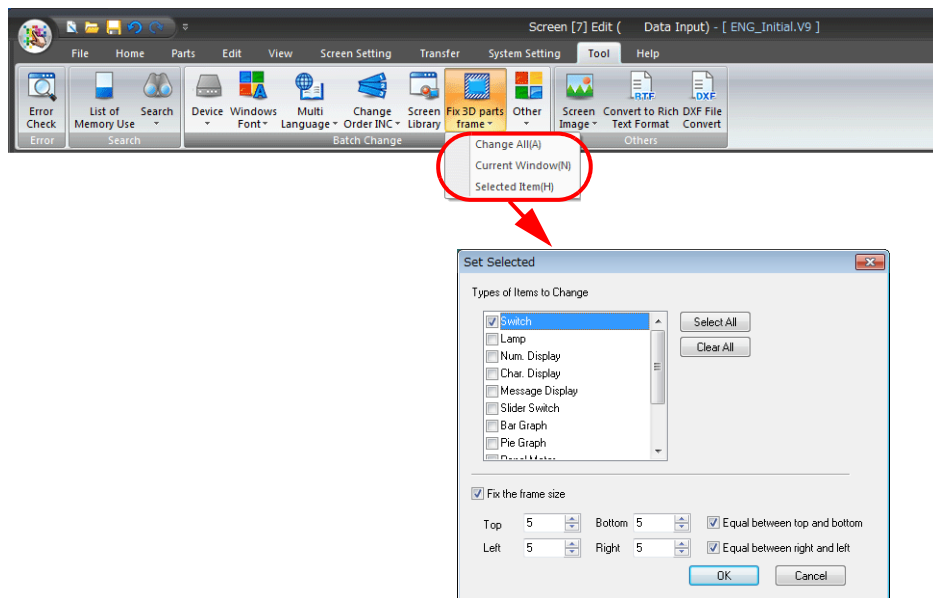

2. Select the items for changing under [Types of Items to Change]. Select the [Fix the frame size] checkbox and set the frame size.

Example: Selected items
 [Types of Items to Change]: Switch
 [Fix the frame size]: Selected, [Top]: 5, [Bottom]: 5, [Left]: 5, [Right]: 5,

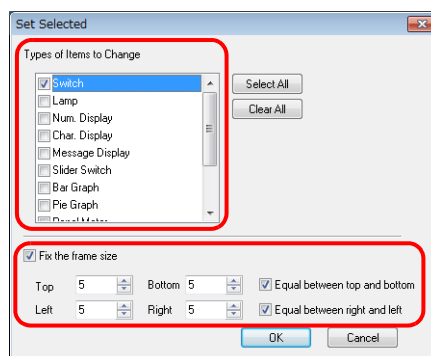

3. Click [OK]. The frame sizes all change at once.

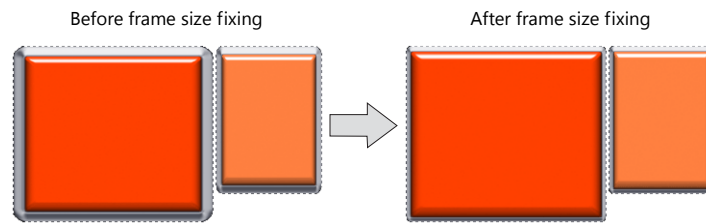

5.6 Others

5.6.1 Screen Image

Output a image of the screen being edited.

- Save as Pattern Image
Output a screen image to [Home] → [Registration Item] → [Pattern]. This allows placement of the screen image as a pattern part.
- Copy to Clipboard
Copy a screen image to the clipboard of the PC.
- Save in Image File
Save a screen image as a JPEG or bitmap file.

Save as Pattern Image

The following items can be registered as patterns:

- Screen
- Graphic Library
- Multi-Overlap
- Data Block
- Screen Library

Operation method

1. Open the screen to use as a pattern and click [Tool] → [Screen Image] → [Save as Pattern Image].
The [Output Setting] window is displayed.

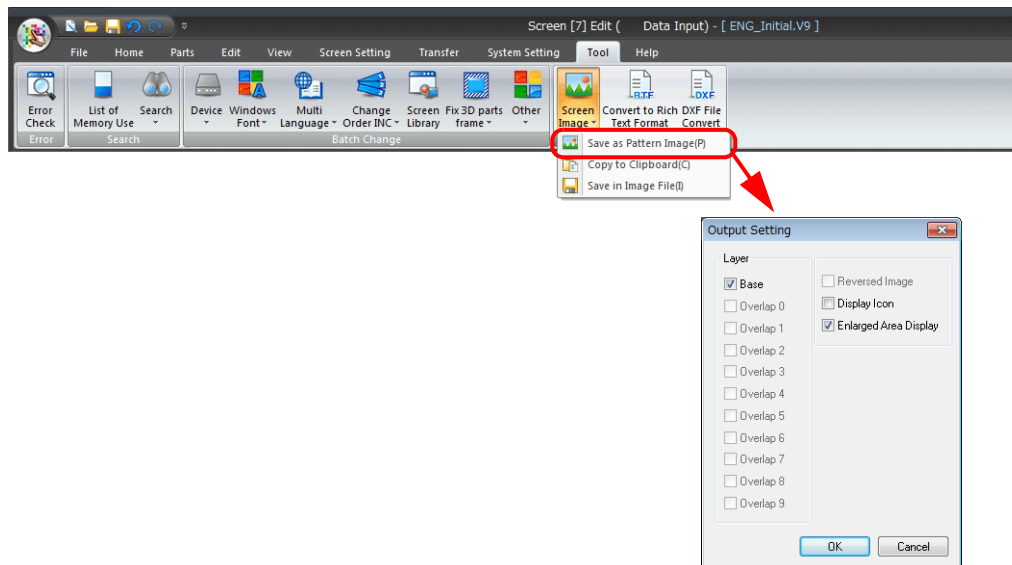

2. Select the output layers and click [OK].

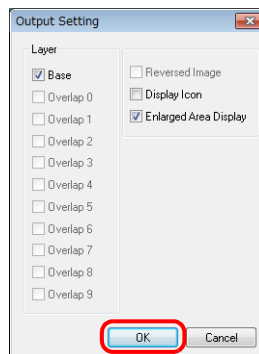

Item	Description
Layer	Select the layers on the screen to output as image data. <ul style="list-style-type: none"> • Base screen • Overlaps 0 to 9
Display Icon	Select this checkbox to output image data with part icons shown.

Item	Description
Enlarged Area Display	Select this checkbox to output enlarged size image data when the screen size is enlarged.

3. The [Change Size] window is displayed.

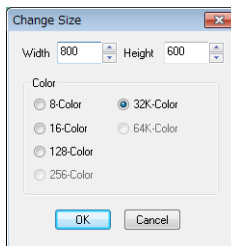

Item	Description
Width/Height	Specify the size of the pattern. The maximum permissible size is equivalent to the screen size.
Color	Select the number of colors to use for the pattern by clicking the relevant option under [Color].

4. Click [OK].

The message "Will Register in No. x" appears.

If the registration destination is correct, click [Yes]. To change the destination, click [No].

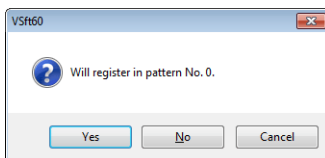

5. Clicking [No] displays the [Bitmap Import Number Designation] window. Specify the desired number.

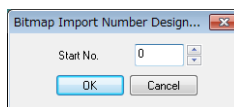

6. A pattern is output.

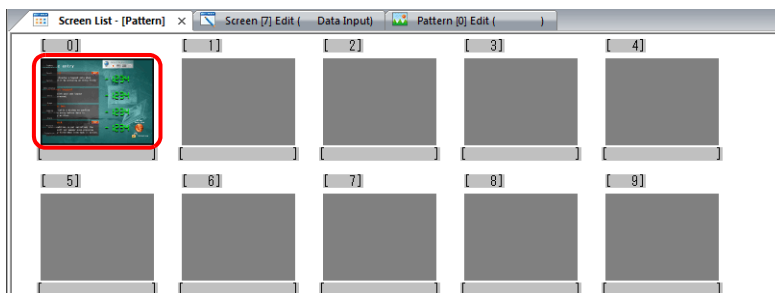

Copy to Clipboard

Operation method

1. Open the screen to copy and click [Tool] → [Screen Image] → [Copy to Clipboard].

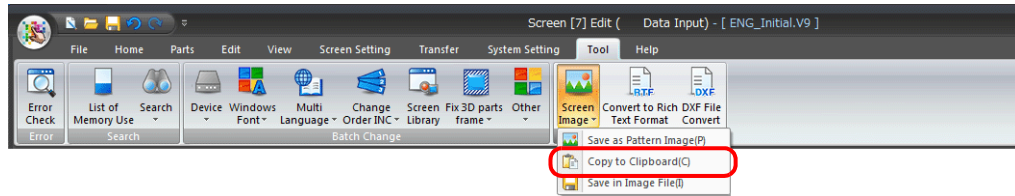

2. Select the layers to output and click [OK].

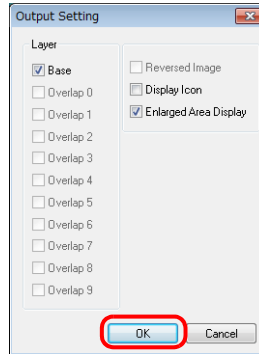

Item	Description
Layer	Select the layers on the screen to output as image data. <ul style="list-style-type: none"> • Base screen • Overlaps 0 to 9
Reversed Image	Select this checkbox to invert the tone of the image data to output.
Display Icon	Select this checkbox to output image data with part icons shown.
Enlarged Area Display	Select this checkbox to output enlarged size image data when the screen size is enlarged.

3. The screen is copied to the clipboard. The data copied to the clipboard can be pasted into applications such as Excel.

Pasting the copied image in other application software

This section describes the procedure for pasting copied images into other application software. (Example: Procedure for pasting into Microsoft Office Word)

1. Start up the Word software.
2. Move the cursor to the position to place the copied image in Word.

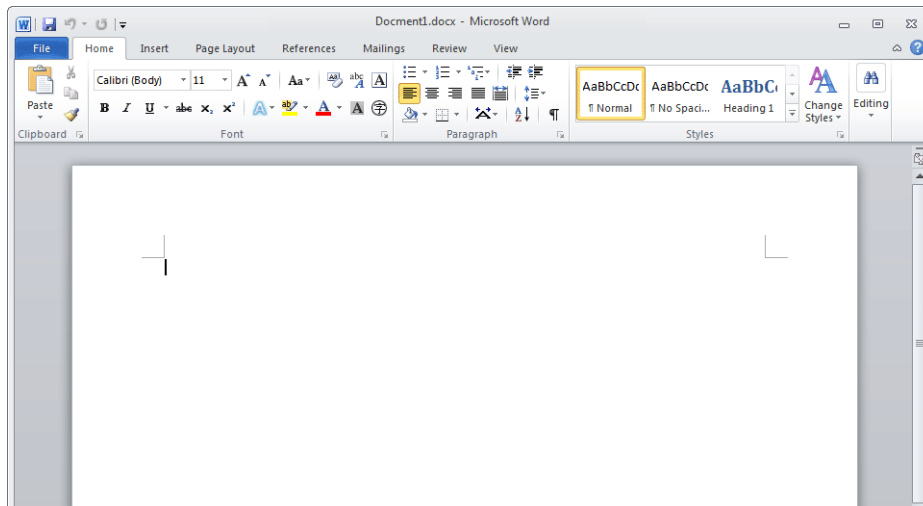

3. Click [Home] → [Paste].

The copied image on the clipboard is pasted in the Word document.

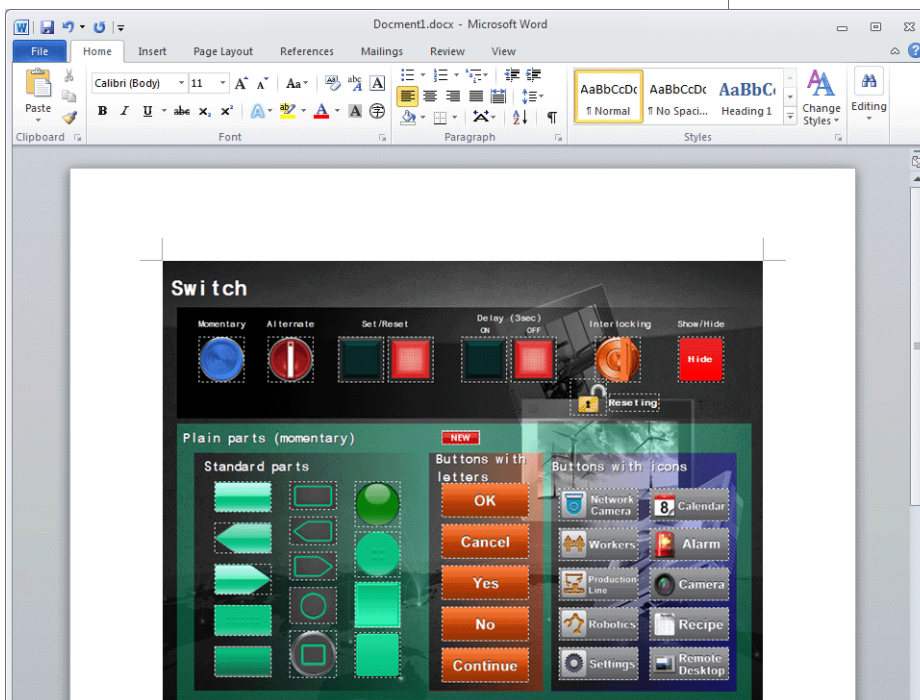
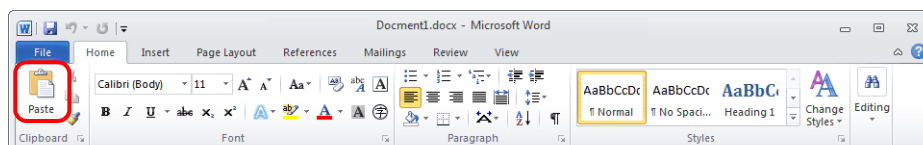

Save in Image File

Saving format

Item	Description
File Type	JPEG files (*.jpg), bitmap file (*.bmp)

Saving target

Screens, overlap libraries, screen libraries, data sheets, and data blocks

Operation method

1. Open the screen to output and click [Tool] → [Screen Image] → [Save in Image File].
The [Output Range Setting] window is displayed.

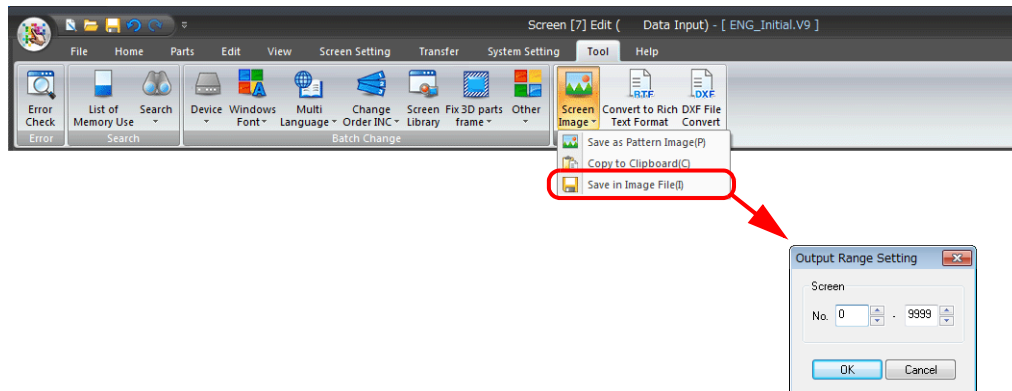

2. Set the saving range and click [OK] to display the [Select Image File to be Saved] window.

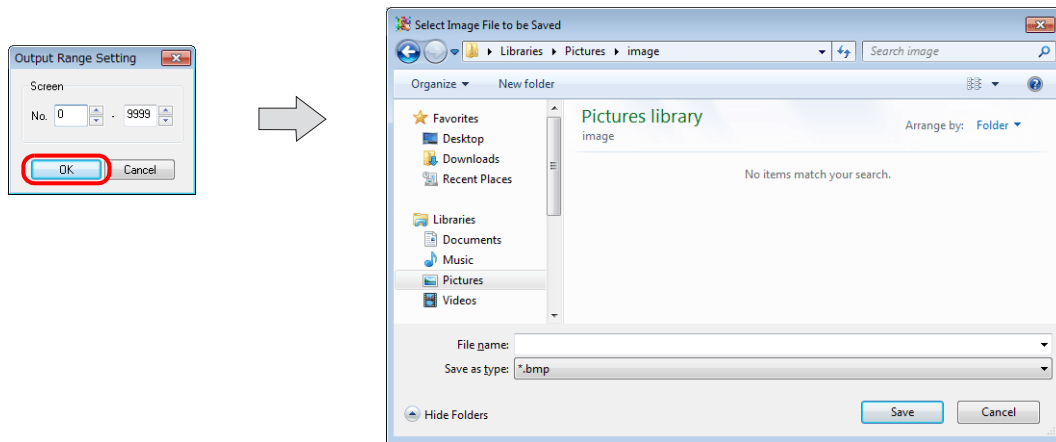

3. Select the file type, specify a filename, and save the file.

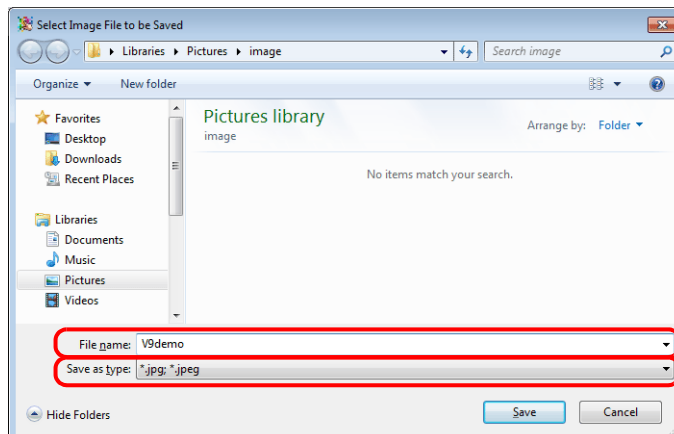

4. The [Output Setting] window is displayed. Select the output layers and click [OK].

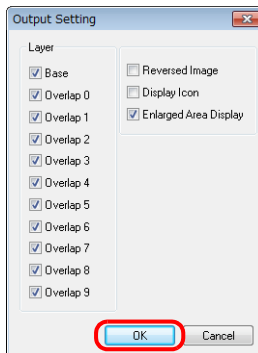

Item	Description
Layer	Select the layers on the screen to output as image data. <ul style="list-style-type: none"> • Base screen • Overlaps 0 to 9
Reversed Image	Select this checkbox to invert the tone of the image data to output.
Display Icon	Select this checkbox to output image data with part icons shown.
Enlarged Area Display	Select this checkbox to output enlarged size image data when the screen size is enlarged.

5. An image file is saved to the save destination specified in step 3.

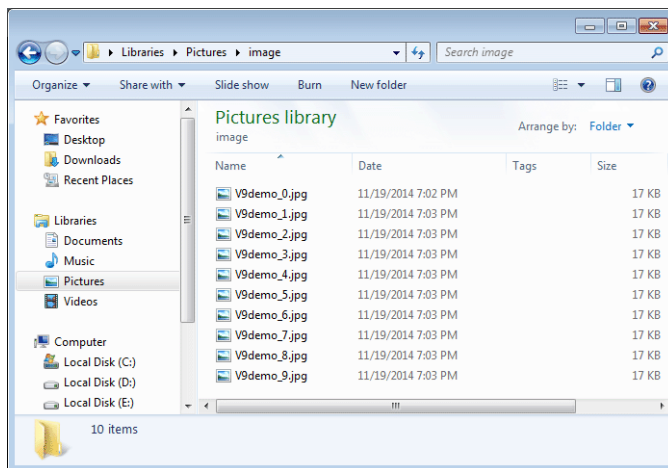

5.6.2 Convert to Rich Text Format

The contents of the screen program file can be converted to a rich text file (with extension “*.rtf”) likewise printing from the editor.

This function makes it possible to check screen settings or screen previews without wasting paper. Necessary data can be selected and printed out.

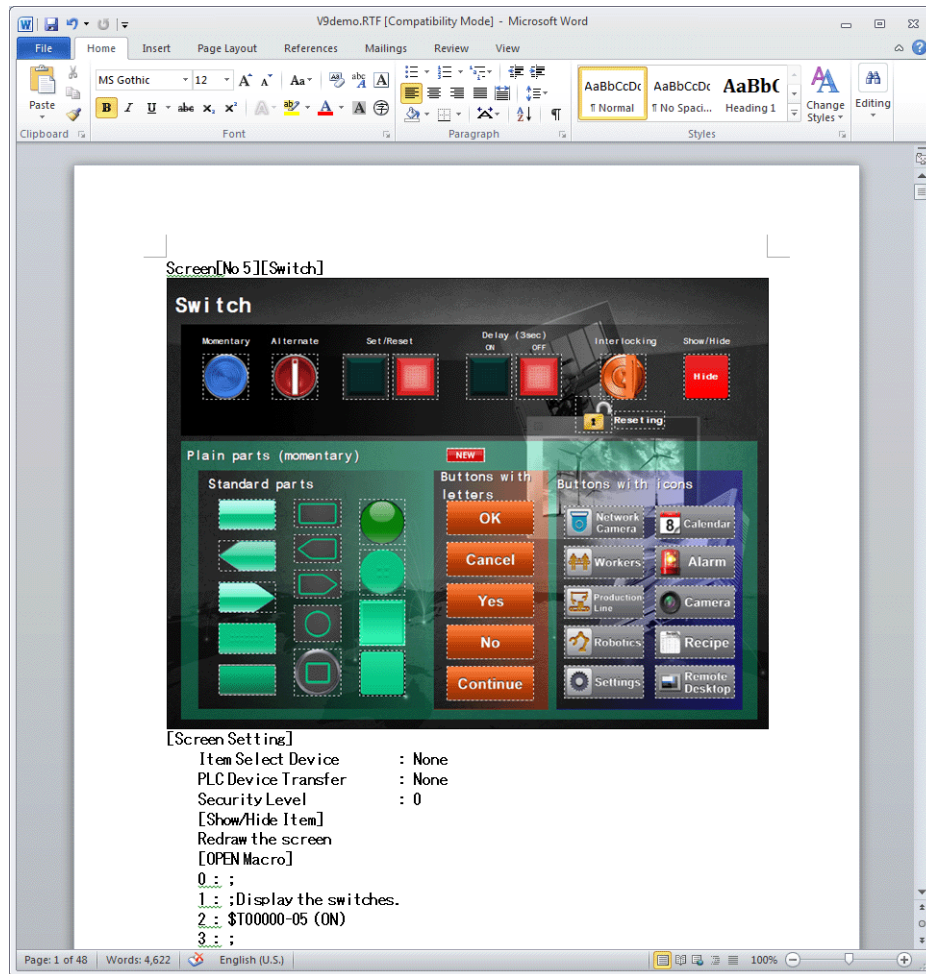

Operating Procedure

1. Click [Tool] → [Convert to Rich Text Format].
The [Rich Text Setting] window is displayed.

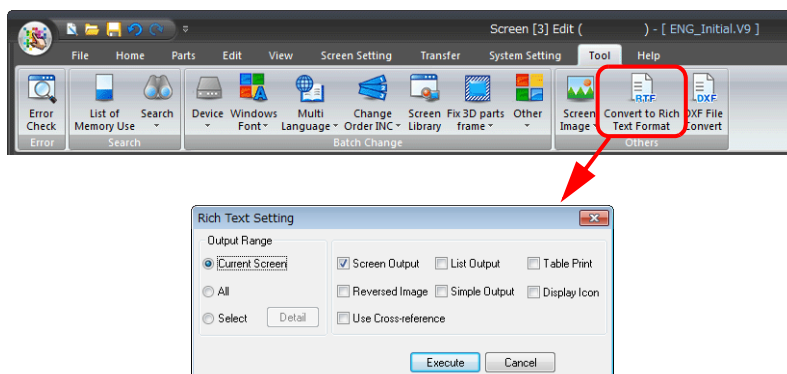

The setting items are almost the same as those in the [Print] window, which is selected from the [File] menu. For more information, refer to "9.2.2 Print Settings" page 9-2.

2. When the settings are complete, click [Execute].
The following window is displayed.

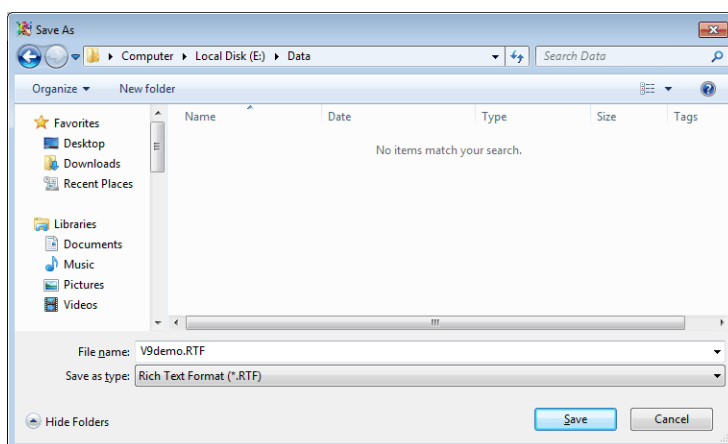

3. Specify a filename and save the file to the desired destination in rich text format.
4. The rich text file saved in step 3 can be opened in applications such as Word.



The file size of the rich text file created by the editor is much larger because it is not compressed. To reduce the size, open the Rich Text file in Word, and save it as the normal document file (e.g. [*.doc]) using the [Save As] command.

5.6.3 DXF File Convert

A DXF file can be imported into a screen program file as drawing data.

Operating Procedure

1. Select [Tool] → [DXF File Convert].
The [DXF File Select] window is displayed.

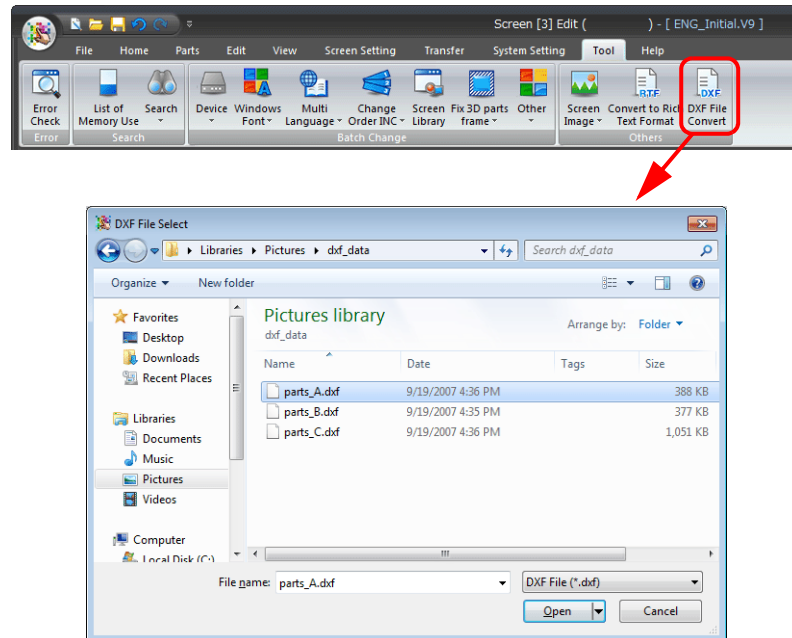

2. Select the DXF file to import and click [Open].
The [Conversion Settings] window is displayed.

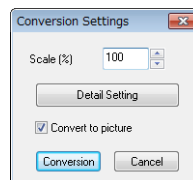

3. Specify the scaling factor. The available range is 10 to 250%.
4. Click [Detail Setting] and select conditions for importing.
For more information on settings, refer to " [Detail Setting] options" on the next page.

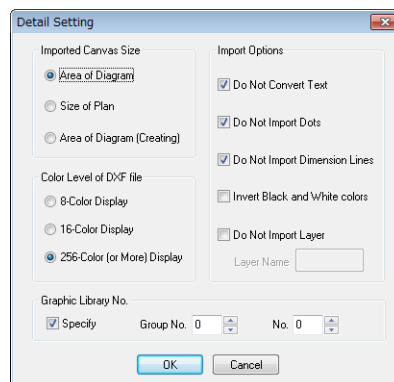

5. Click [Conversion].
A crosshair is displayed with a dotted square.
Clicking any location on a screen shows the converted DXF file as a grouped drawing.



Figures are converted into drawings in the V-SFT editor. The drawings are grouped. The displayed color depends on the original DXF file.
For more information, refer to the next section.

[Detail Setting] options

The following settings are displayed in the window.

Item		Description
Imported Canvas Size	Area of Diagram	Only areas containing figures are imported.
	Size of Plan	Figures are imported at their original size in the DXF file.
	Area of Diagram (Creating)	If the figures could not be read by the above methods, V-SFT sets an area and the data within the area is imported.
Display (Color Level of DXF File)	8-Color Display	Select the option specified for DXF file creation.
	16-Color Display	
	256-color (or More) Display	
Import Options	Do Not Convert Text	Select whether or not to convert text in the DXF file. (1 character is converted into 16 × 16 dots.)
	Do Not Import Dots	Select whether or not to ignore drawing dots.
	Do Not Import Dimension Lines	Select whether or not to ignore dimension lines in the DXF file.
	Invert Black and White Colors	Select whether or not to invert to black-on-white. (When a file is imported into the V-SFT editor, white-on-black or some other color line is used for display as default.)
	Do Not Import Layer	Select whether or not to convert specific layers. Specify the name instead of the number of a layer to not convert.
Graphic Library No.	Specify	When blocks are used in a DXF file, they will be registered to the graphic library. Select this option to specify the graphic library number to which the blocks are registered.

MEMO

MONITOUCH

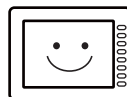

6 Registration Items

- 6.1 Overview
- 6.2 Screen
- 6.3 Message
- 6.4 Overlap Library
- 6.5 Screen Library
- 6.6 Graphic Library
- 6.7 Multi-language
- 6.8 Macro Block
- 6.9 Tag Database
- 6.10 Data Sheet
- 6.11 Comment
- 6.12 Animation
- 6.13 Pattern
- 6.14 Data Block
- 6.15 Page Block
- 6.16 Direct Block
- 6.17 Tile

6.1 Overview

6.1.1 Outline of Registration Items

V9-series screen program files are created based on areas called screens.

Parts and drawing items can be placed on screens.

Meanwhile, data items or graphics, the contents of which will vary according to circumstance, cannot be placed on screens. Thus, these items are registered in separate areas.

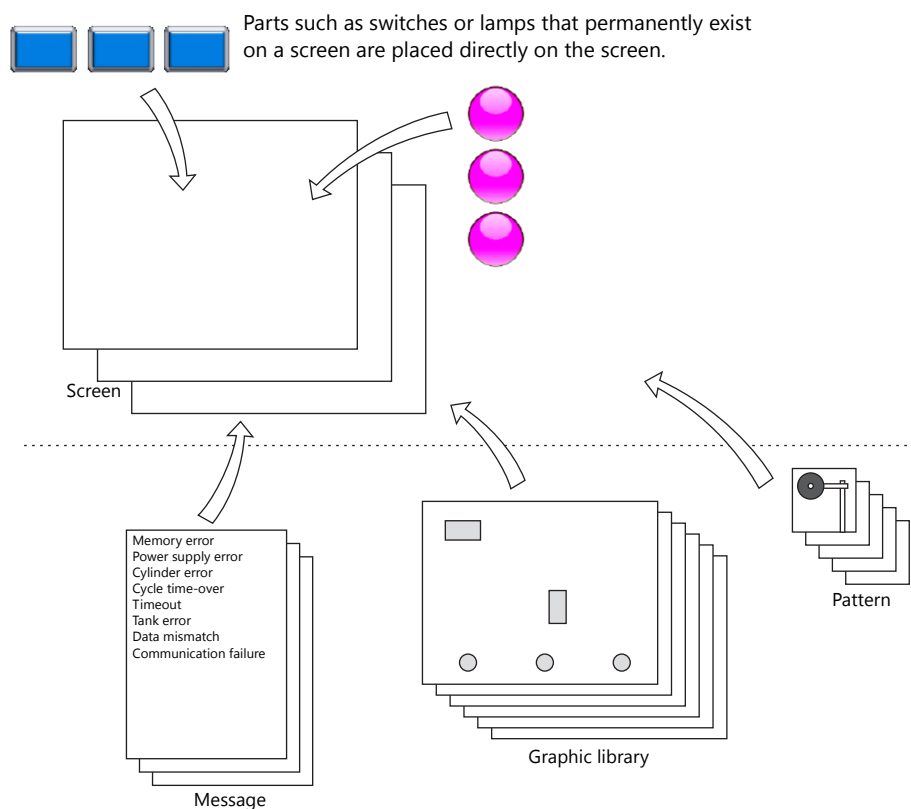

Items that will vary according to circumstance are registered in separate areas.

All of these areas are called registration items. When editing these areas, select from [Home] → [Registration Item].

6.1.2 Types of Registration Items

The following table indicates the types of registration items and their functions.

Registration item	Function	Refer to
Screen	–	page 6-3
Message	Used for alarms and message displays	page 6-4
Overlap Library	Used for overlaps	page 6-10
Screen Library	Used for screens and overlaps	page 6-16
Graphic Library	Used for graphic functions	page 6-23
Multi-language	Used for changing the language used on the screen	page 6-33
Macro Block	Used for macros	page 6-33
Tag Database	Used for device memory specification of parts	page 6-33
Data Sheet	Used for data sheets	page 6-34
Comment	Used for comment display	page 6-38
Animation	Used for animation	page 6-44
Pattern	Used for drawing operations on screens, in graphic libraries, etc.	page 6-48
Data Block	Used for data block areas	page 6-60
Page Block	Used in messages	page 6-64
Direct Block	Used in messages	page 6-66
Tile	Used for drawing operations	page 6-69

6.2 Screen

A screen is displayed in the editing window opened at start-up of the editor software.

6.2.1 Calling a Screen

To display a different screen from the current screen or while a different registration item window is opened, click [Home] → [Registration Item] and select [Screen].

(Alternatively, you can call one from the [Registration Item] menu in the project list view window.)

The [Screen] window is displayed. Specify the screen number to open and click [OK].

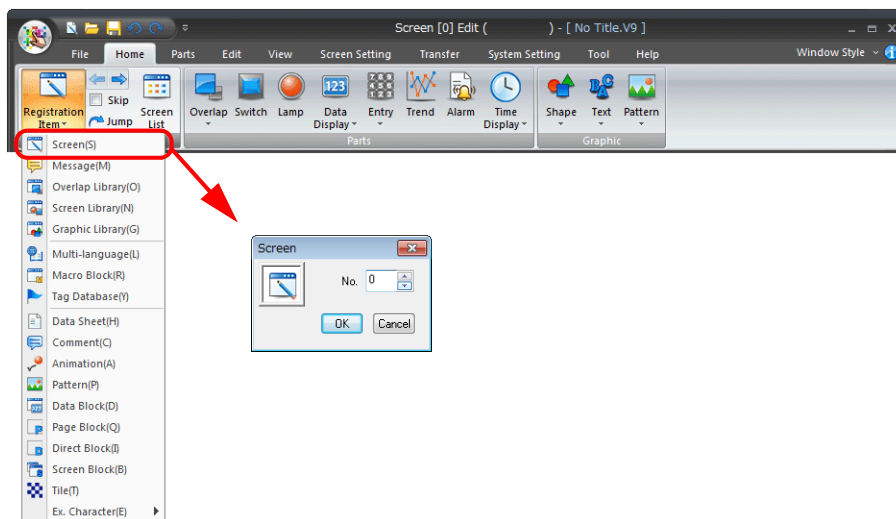

6.2.2 Editing Procedure



For more information on the screen editing environment, including placement limitations on the number of parts that can be placed on screens, refer to "3.1 Parts Types and Limitations" page 3-1.

6.3 Message

It is possible to register text as desired in the message editing area.
 Register the text to use for functions where displayed messages differ according to status, such as alarm parts.

6.3.1 Message Structure

There are 128 groups of editing areas.
 Up to 256 lines of messages can be registered in each group. Accordingly, a maximum of 32768 lines can be registered in total.
 Each line can contain up to 127 characters.

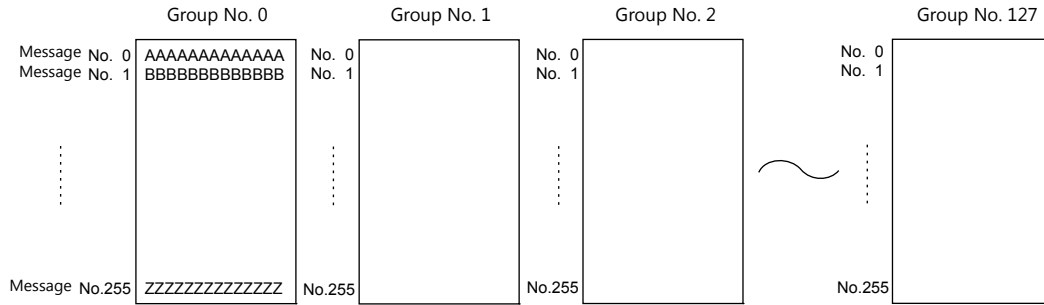

Relationship between Group Numbers and Absolute Addresses

Each message is given a group address (message group number and line number) as well as an absolute address (line number only).

Ordinary Addresses (groups)		Absolute Addresses	
Group No.	Message No.	Group No.	Message No.
0	00000 to 00255	(None)	00000 to 00255
1	00000 to 00255		00256 to 00511
2	00000 to 00255		00512 to 00767
3	00000 to 00255		00768 to 01023
4	00000 to 00255		01024 to 01279
5	00000 to 00255		01280 to 01535
:	:		:
:	:		:
126	00000 to 00255		32256 to 32511
127	00000 to 00255		32512 to 32767



How to check absolute addresses

You can check absolute addresses in the [Message Edit] window.
 Click [Display] → [Display Absolute Address as Line Number]. The field showing line numbers switches to show absolute addresses.

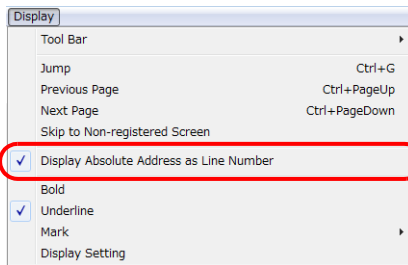

Example: Group No. 1

[Display Absolute Address as Line Number]: Unselected

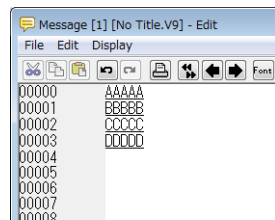

[Display Absolute Address as Line Number]: Selected

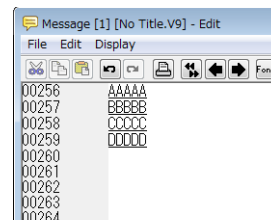

6.3.2 Calling a Message

Click [Home] → [Registration Item] → [Message].

The [Message] window is displayed. Specify the message group number to open and click [OK].

(Alternatively, you can call one from the [Registration Item] menu in the project list view window.)

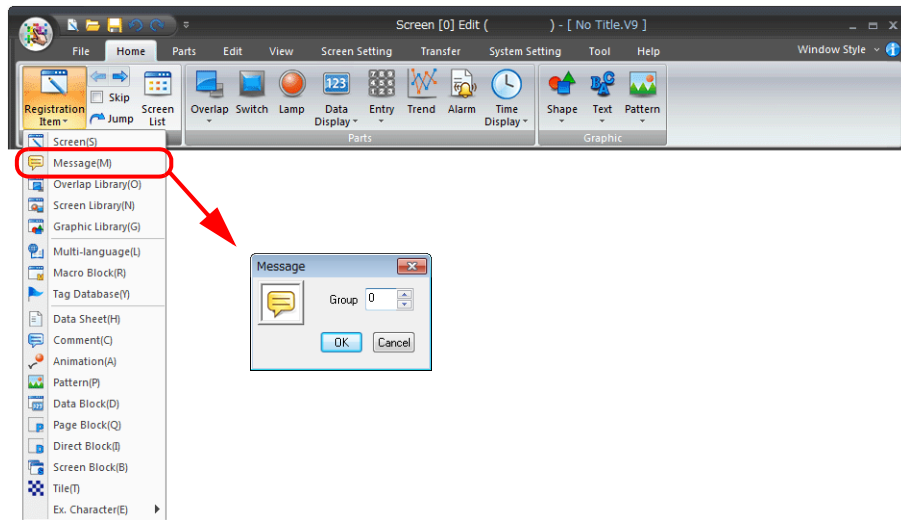

Message Edit Window

The following window is displayed.

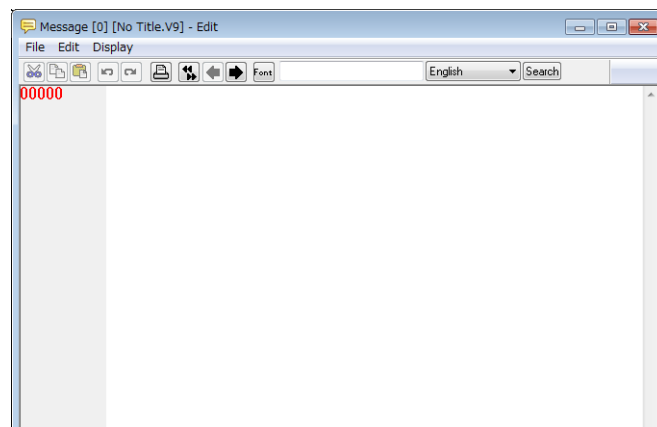

6.3.3 Message Editing

Message text is entered in same way as general text input.

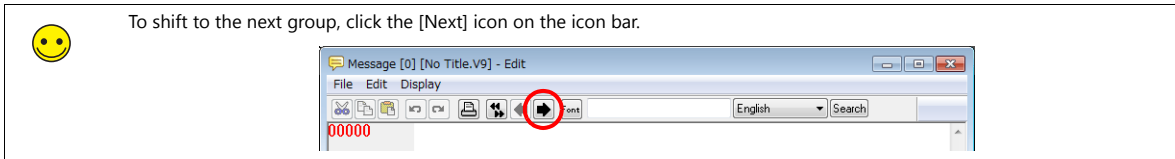

Text Properties (Windows Font)

Text properties (Windows font) can be changed on a message line basis.

1. Place the mouse cursor on the message line for setting text properties.
2. Right-click and select [Char. Prop.]. The [Char. Prop.] window is displayed.

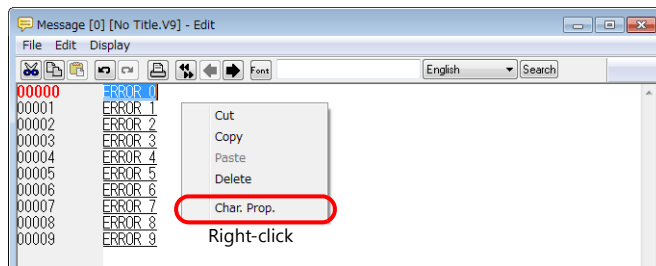

3. Select the [Windows Font] checkbox to set the color and point size.

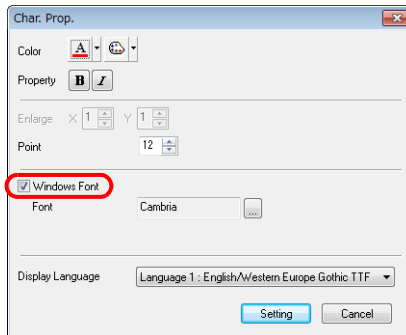

4. Click [Setting] to update the text with the settings made in the window.

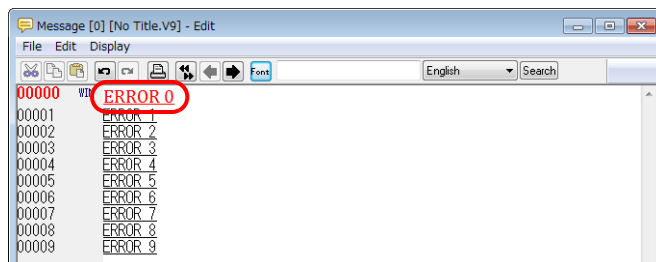

Copying and Pasting Messages

- Specify the copy source messages by dragging the mouse. The selected messages are highlighted.

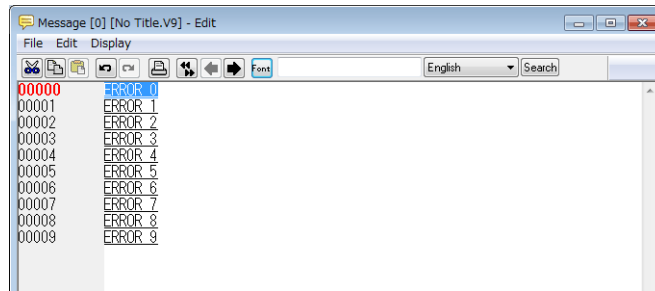

To select all messages in the group, click [Select All] from the [Edit] menu.

- Select [Copy] from the [Edit] menu or the right-click menu, or click the [Copy] icon on the edit toolbar. The messages are copied to the Windows clipboard.

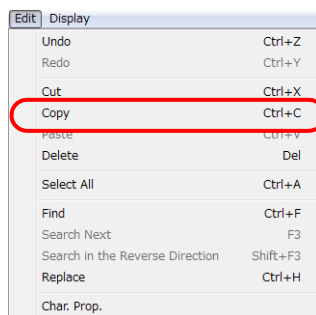

OR

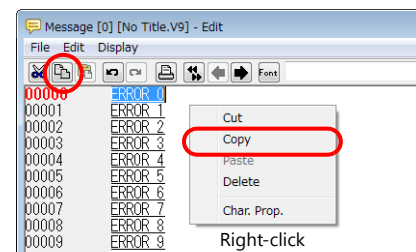

- Move the cursor to the copy destination. Select [Paste] from the [Edit] menu or the right-click menu, or click the [Paste] icon on the edit toolbar.

The specified messages are copied to the position.

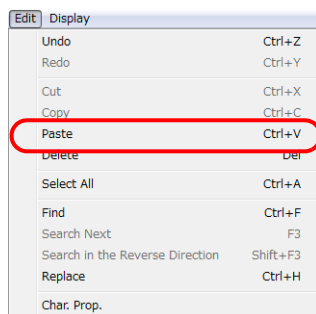

OR

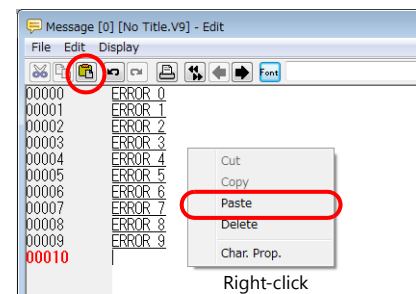

The [Paste] command inserts messages into the specified position so that the following lines move down accordingly.

Deleting Messages

- Specify messages to be deleted by dragging the mouse. The selected messages are highlighted.

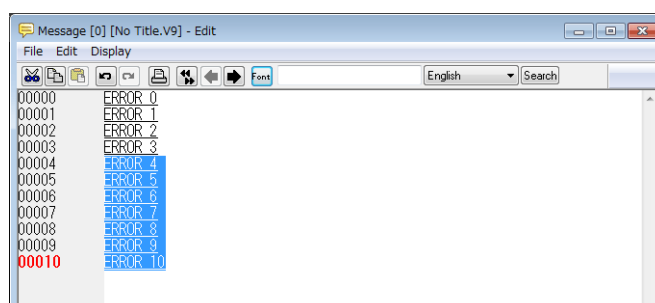

2. Select [Delete] from the [Edit] menu or the right-click menu.
(Or press the [Delete] key on the keyboard.) The specified messages are deleted.

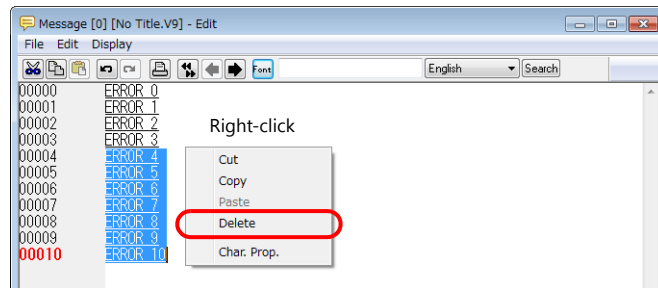

Message Search and Replacement

Searching for or replacing messages is possible.

Search

1. In the [Message Edit] window, check the position of the mouse cursor.
2. Click [Find] on the [Edit] menu.
The [Find] window is displayed.

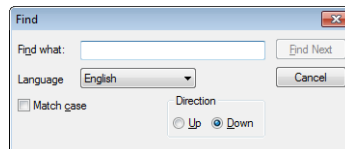

3. Enter the string to search for into the [Find what] field.
4. Set [Language] according to the language used for message editing.
(Search is performed based on the character codes corresponding to the [Language] setting.)
5. Select an option for [Direction].
Select [Up] when searching the window upward from the cursor position. Select [Down] when searching the window downward from the cursor position.
6. Check [Match case] to make a distinction between upper-case and lower-case letters during searching messages.
7. Clicking [Find Next] starts searching the window in the selected direction.

Replacement

1. In the [Message Edit] window, check the position of the mouse cursor.
2. Click [Replace] on the [Edit] menu.
The [Replace] window is displayed.

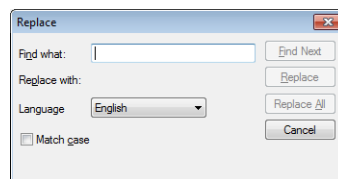

3. Enter the desired strings respectively into the [Find what] and [Replace with] fields.
4. Set [Language] according to the language used for message editing.
(Search and replacement are performed based on the character codes corresponding to the [Language] setting.)
5. Check [Match case] to make a distinction between upper-case and lower-case letters during searching messages.
6. Clicking [Find Next] starts searching the window downward from the cursor position.
When [Replace] is clicked, the string for [Find what], if found during searching downward from the cursor position, is replaced with the string for [Replace with], and search continues. From the second and subsequent search, the selected string is replaced and searching continues to the next string.
When [Replace All] is clicked, all the strings for [Find what], if found during searching downward from the cursor position, are replaced with the string for [Replace with].

6.3.4 Display Environment of the Message Editing Window

The [Display] menu contains display settings for messages.

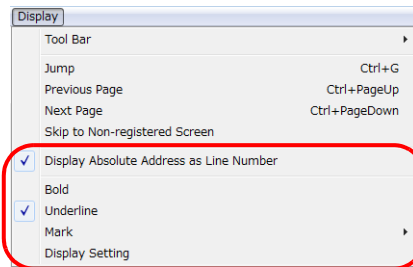

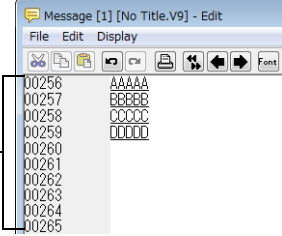
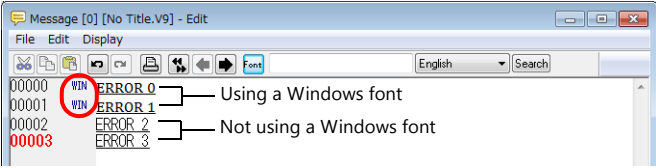
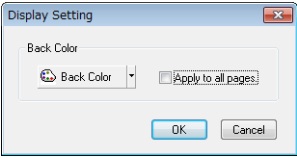
Item	Description
Display Absolute Address as Line Number	<p>When this setting is unselected, the line numbers (0 to 255) in each group are displayed on the left of the window. When selected, absolute addresses are displayed instead on the left. For more information on absolute addresses, refer to page 6-4.</p>  <p>Absolute addresses</p>
Bold	<p>When this setting is selected, message characters are displayed in bold typeface likewise when the [Bold] option is selected on screens.</p>
Underline	<p>Since all characters and spaces are underlined, this setting is useful to check at a glance if there is anything input in message lines.</p>
Mark	<p>When using Windows fonts, display a mark that indicates whether Windows fonts are used. For more information on Windows fonts (text properties), refer to page 6-6.</p> 
Display Setting	<p>Click to display the following window. The background color of the message editing window can be changed.</p> 

6.4 Overlap Library

This is an area where overlap displays are registered.

6.4.1 Overlap Library Structure

Up to 4000 overlap libraries can be registered between numbers 0 to 9999.
One overlap display part is registered per editing window.

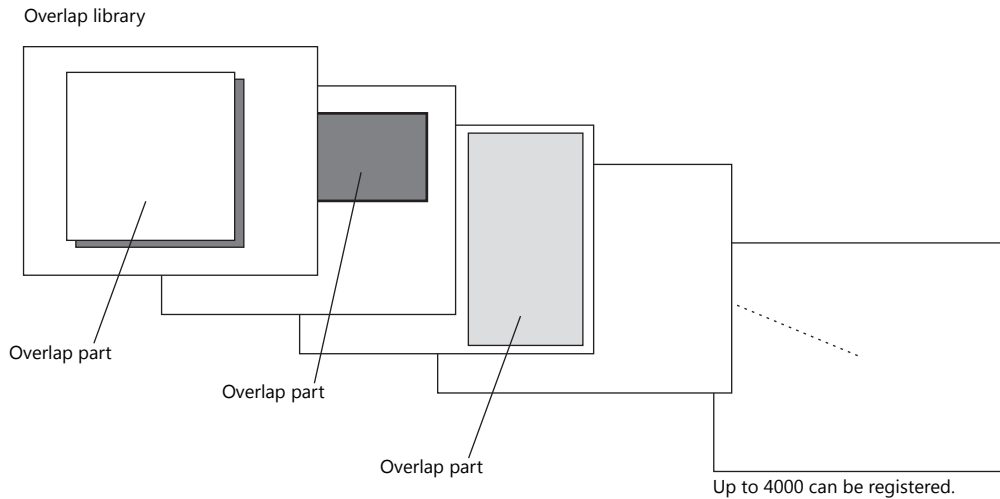

6.4.2 Calling an Overlap Library

Click [Home] → [Registration Item] → [Overlap Library].

The [Overlap Library] window is displayed. Specify the number of the overlap library to open and click [OK].
(Alternatively, you can call one from the [Overlap Library] menu in the project list view window.)

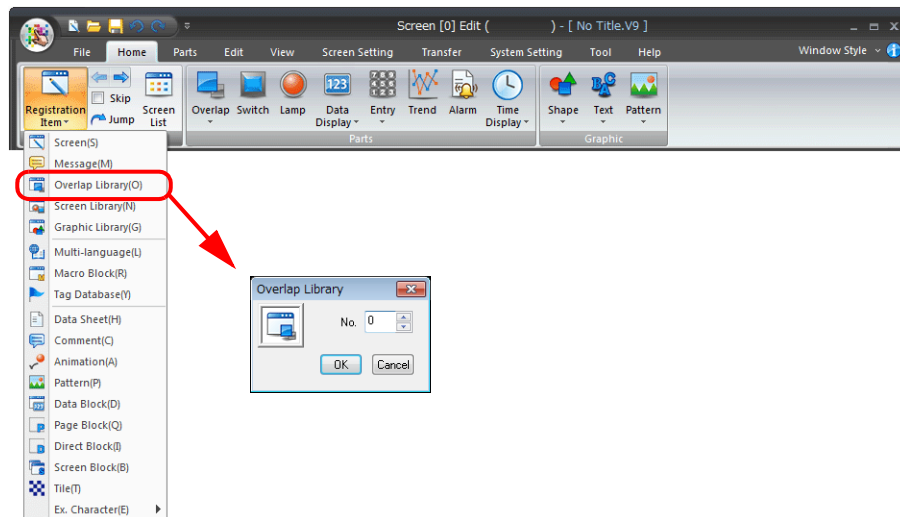

6.4.3 Editing an Overlap Library

Placing an Overlap

1. Click [Parts] → [Overlap] → [Normal Overlap].

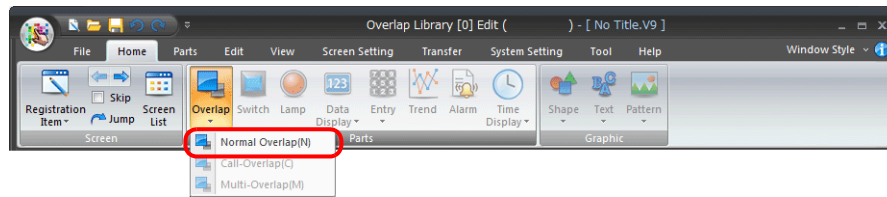

2. A crosshair and the overlap display part are displayed on the screen.



3. Click the mouse at an arbitrary position. The overlap is placed.
Double-click to display the following item settings window.

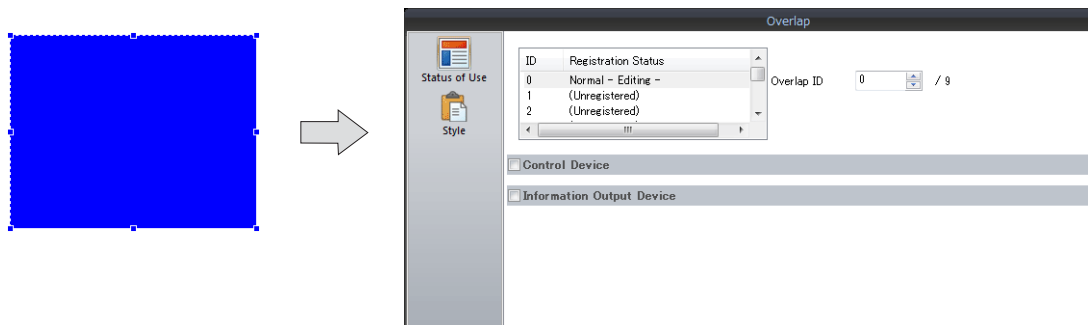

For more information on setting items, refer to "Chapter 2 Overlap" in V9 Series Reference Manual 1.

Item Placement on Overlap Display

For item placement on an overlap display, you may start the procedure from either of the following:

Method 1: Select the overlap.

Method 2: Display the [Overlap Edit] window.

Method 1: Select the overlap.

Click [Parts] → [Switch] and move the mouse cursor onto the screen.

Click the mouse on the overlap display. This places the switch part on the overlap display.

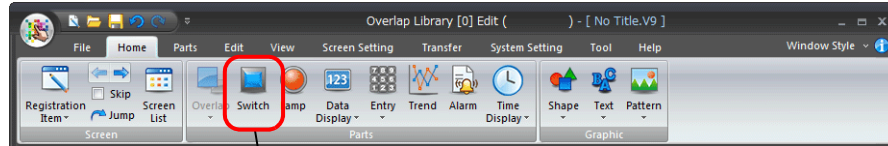

Place the switch on the overlap display by moving and clicking the left mouse button.

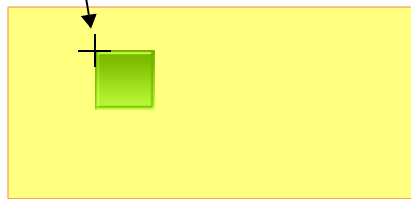

For more information on other placement or editing procedures, refer to page 3-17.

Method 2: Display the [Overlap Edit] window.

1. Right-click on the screen in which the normal overlap display is placed.

* **Make sure that the normal overlap display is not selected when right-clicking on the screen.**

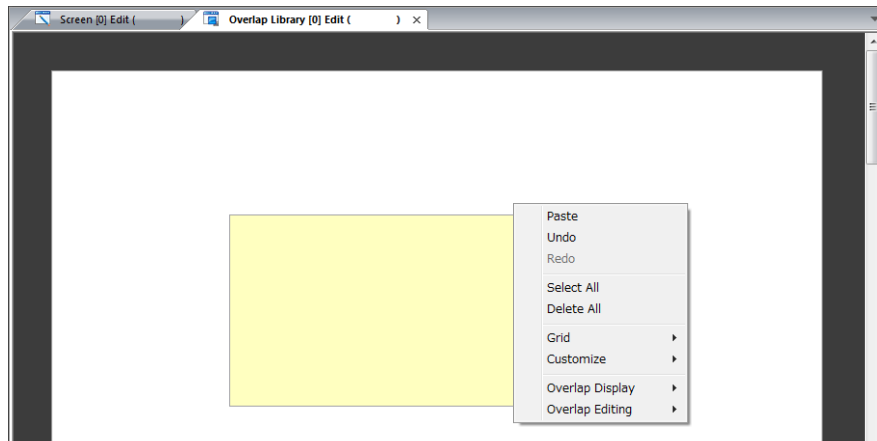

2. Click [Overlap Editing] → [ID 0].

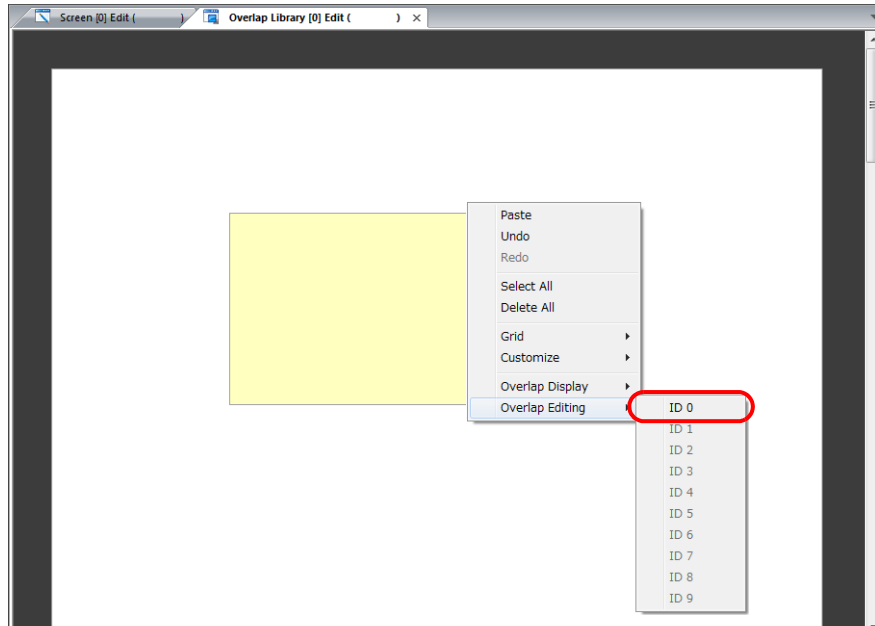

3. The [Overlap Library Edit] tab window switches to the [Overlap Edit] tab window.



4. Click [Parts] → [Switch] and place a switch on the overlap display.

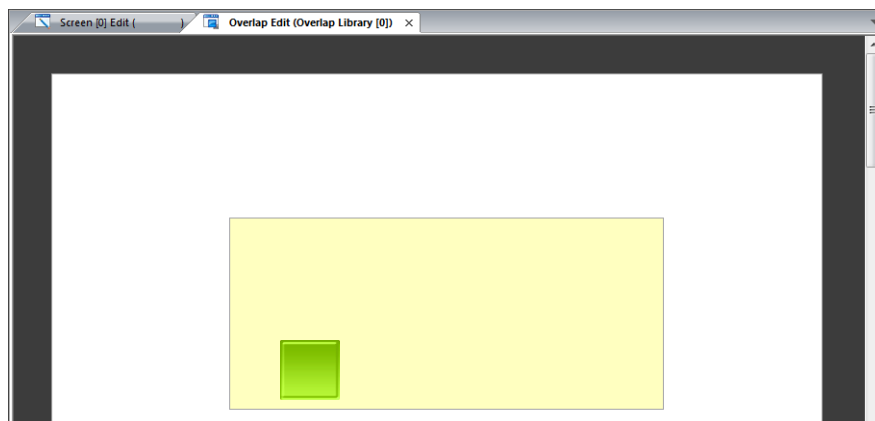

6.4.4 Other Settings

Make the following settings as desired for the overlap library.

Base Screen Display

During overlap library editing, a screen can be placed behind the overlap to check how the screen will actually look when displayed.

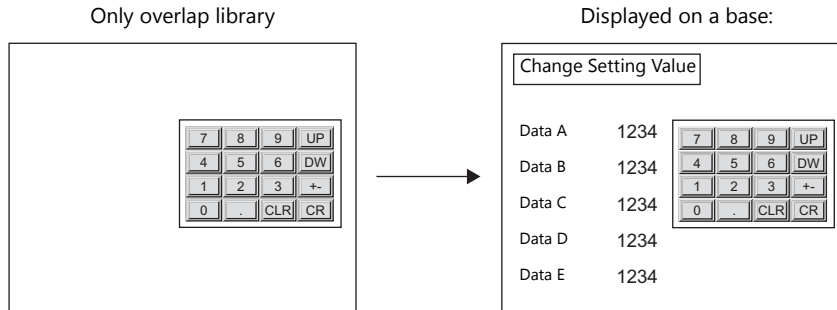

Click [View] → [Display Environment].

The [Display Environment] window is displayed. Display the [Others] tab.

Select the [Base Screen Dsp.] checkbox to enable [Screen]. Specify the destination screen to switch to.

Click [OK] to display the selected screen as the background.

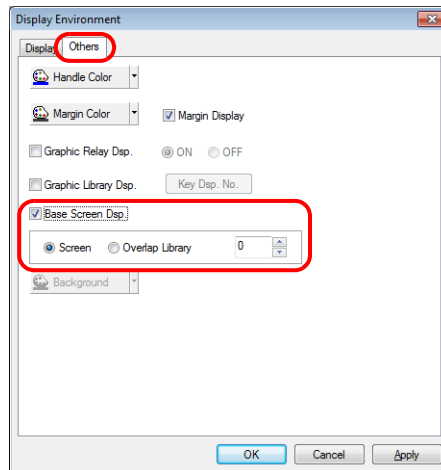
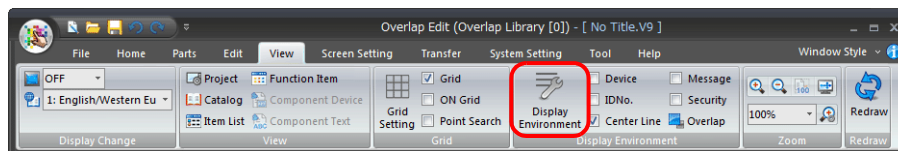

Macro Settings

An OPEN macro and CLOSE macro can be set for the overlap display parts registered in the overlap library. These macros can be executed when the registered overlap part is displayed (OPEN macro) on or erased (CLOSE macro) from the screen.



A macro is a function that executes computational processing for user programs using V-series commands. For details on macro commands, refer to the V9 Series Macro Reference Manual.



- If a registered overlap library is set as a call-overlap on the screen, these macro settings become invalid. Set the overlap as a multi-overlap on the screen when enabling the macro settings.
- If you delete an overlap library that includes a macro setting, be sure to delete the macro as well. Failure to delete the macro will cause an error during error check and an error will occur also on the V9 series unit.

Macro setting commands

Select [Screen Setting] → [Open Macro Edit] or [Close Macro Edit].

The corresponding macro editing window is displayed.

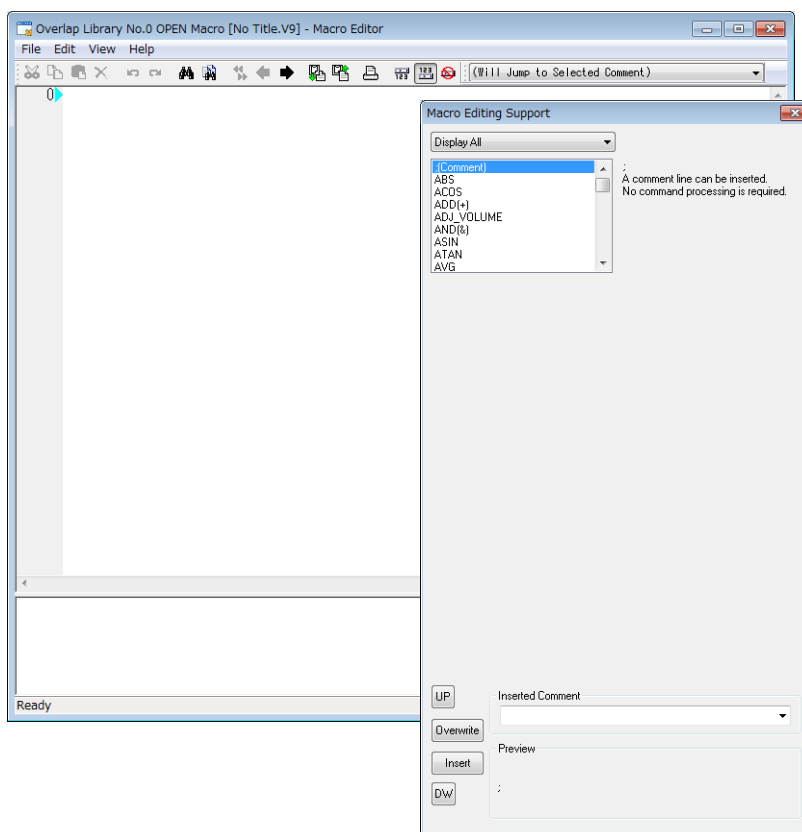
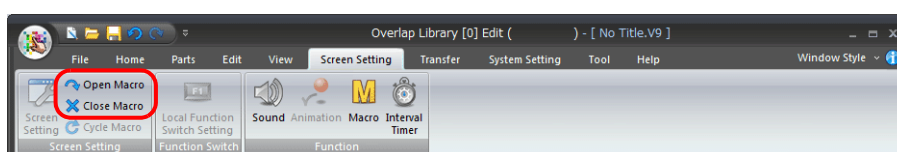

Macro editing and deleting



For more information, refer to "Chapter 2 Edit" in the V9 Series Macro Reference Manual.

6.5 Screen Library

6.5.1 Outline of Screen Library

If there are parts such as switches, lamps, entry parts, time display which are to be used across multiple screens, such parts can be registered in a screen library and then placed on base screens and overlaps, thereby facilitating screen configuration procedures.

Screen libraries are useful also in the following points.

Saving of Screen Memory Space

In the example below, a calendar part is registered in screen library No. 0 and the screen library is placed on three screens. Instead of directly registering calendar parts to the three screens, the use of a screen library reduces the amount of memory used.

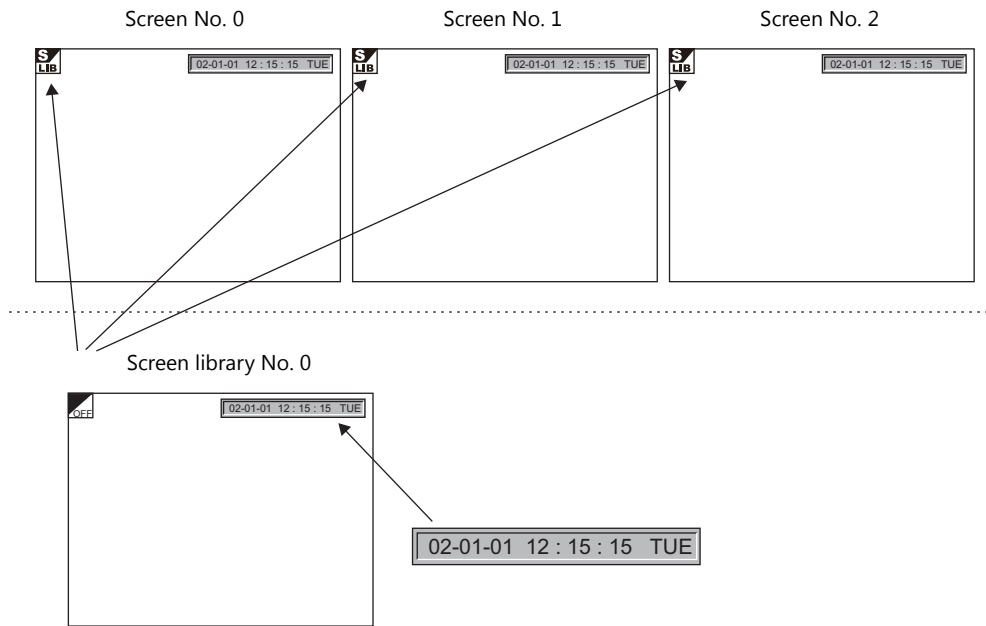

Screen Parts Management Through Screen Library

If a part registered in a screen library is replaced after it has been placed on screens, only replace it in the screen library. The parts on the screens are also replaced simultaneously.

When the calendar part in screen library No. 0 has been replaced, the parts on screen No. 0 to 2 are also replaced.

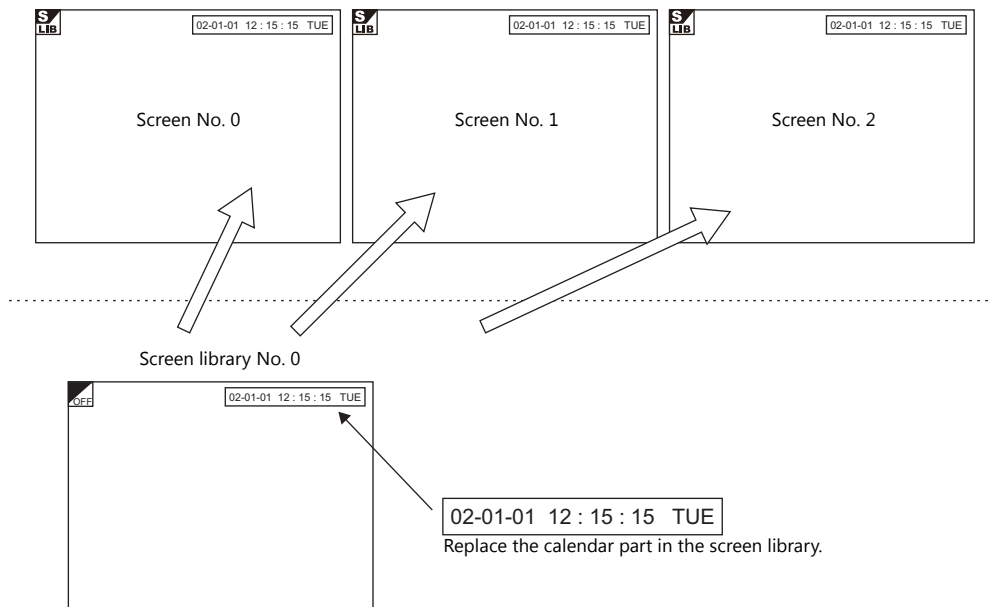

6.5.2 Screen Library Structure

Up to 4000 screen libraries can be registered between numbers 0 to 9999.
There is no limit on the memory capacity per screen library.

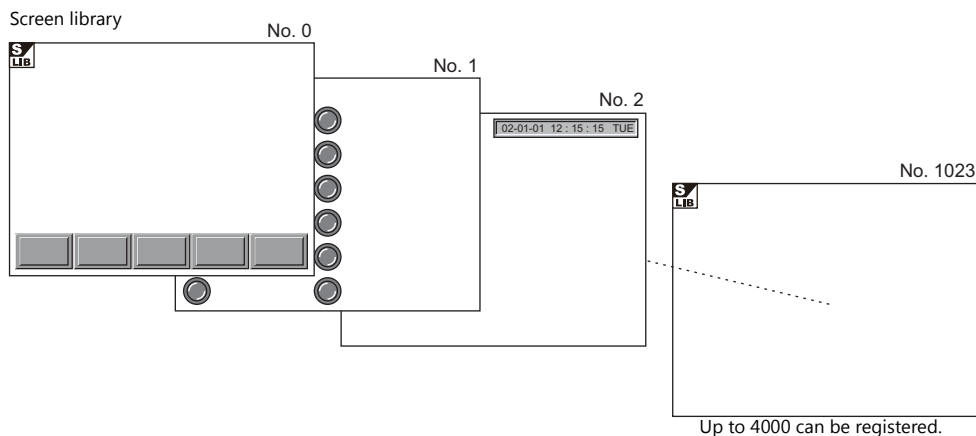

6.5.3 Calling a Screen Library

Click [Home] → [Registration Item] → [Screen Library].
The [Screen Library] window is displayed. Specify the screen library number to open and click [OK].
(Alternatively, you can call it from the [Registration Item] menu in the project list view window.)

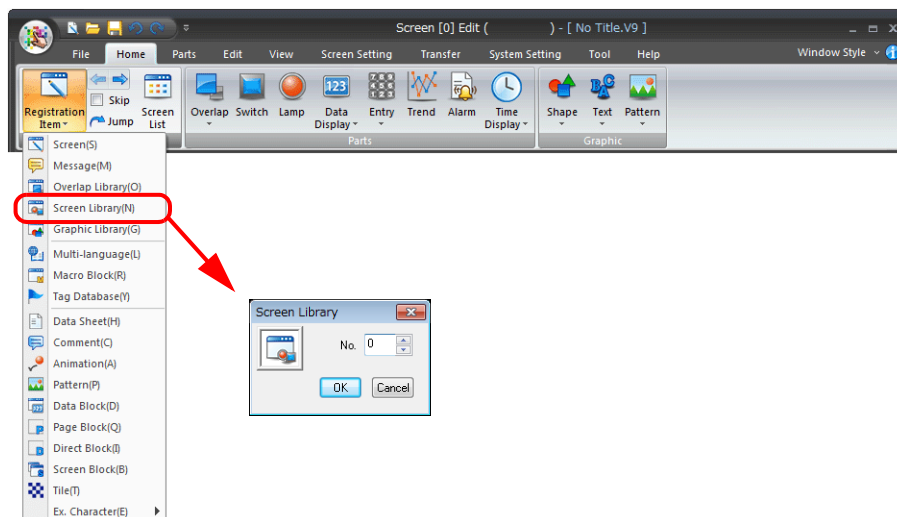

6.5.4 Screen Library Editing

Most parts that can be used on screens can be used in screen libraries as well. Parts can be placed and drawing operations performed in the same manner as on screens.

Notes on Editing

- The functions below are not available for screen libraries though they can be used on screens.
 - Overlap
 - OPEN/CLOSE/CYCLE macro
 - Local Function Switch Setting
 - Screen Library
- When placing a screen library on the screen, check that the number of parts to be placed do not exceed the limit. Depending on the part type, only one part can be registered per ID. When placing a screen library containing such a part on screens, make sure that the same ID number is not used for multiple parts. To avoid a problem like the one described above, ID numbers that are not generally used (such as 100 and higher) should be allocated for parts in screen libraries. (Also take care not to use identical ID numbers in different screen libraries if possible.)
- There are cases in which only one part (entry mode) can be used on one sheet, or only one part (memo pad) can be used on one screen. Take the above note into consideration when placing a screen library containing such a part on the base screen or the overlap display.



For more information on placement limitations of screen parts, refer to "3.1 Parts Types and Limitations" page 3-1.

Offset Position Setting

Every screen in the screen library has a reference position called an offset. When a registered screen library is called to the screen, it is placed based on the offset position.

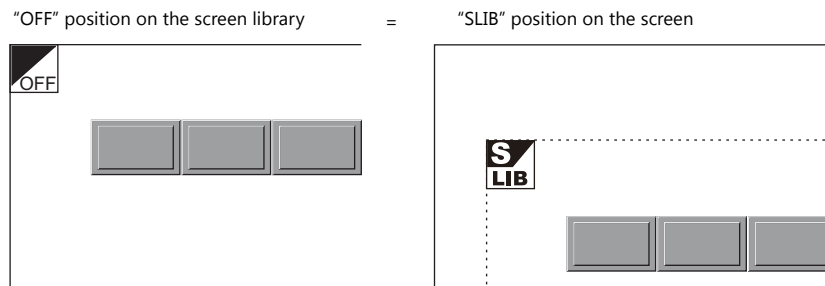

Screen library shows the offset position with an "OFF" mark.

Changing an offset position

Every screen library has an offset position at coordinates X, Y (0, 0) as default. To change the position, follow the procedure below.

- An [Edit] menu is added to the right end of the ribbon menu when the [Screen Library Edit] tab window is displayed. Click [Offset Position Setting].

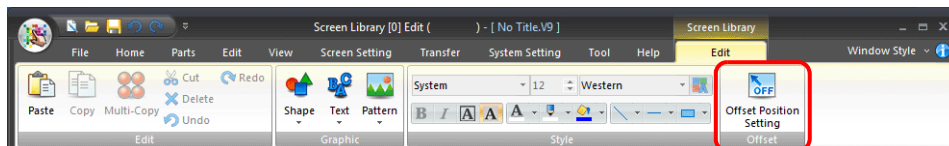

- A crosshair marked with "OFF" appears.



3. Click the left mouse button at an arbitrary position on the screen. The [OFF] offset mark is displayed at that location.

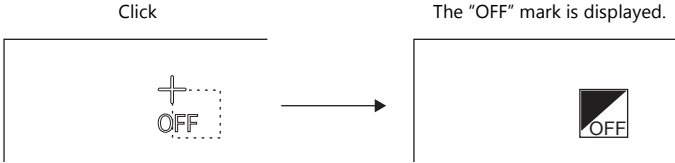

 Changes made to the offset position prior to registering a screen library are invalid. Set an offset position after registering a screen library.

Placing a Screen Library

A registered screen library can be placed on the screen. Click [Parts] → [Shape] → [Pattern/Library] → [SLIB] and place the part.

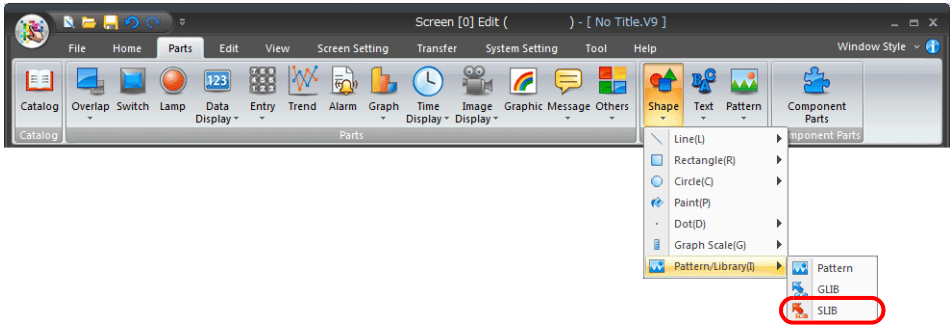

 For more information, refer to "Screen library (SLIB)" in "3 Placing Parts" page 3-78.

Changing Numbers After Screen Library Placement

The library number of screen libraries can be changed after placement.

1. Click the [SLIB] mark of the screen library number to change, right-click and select [Detail Setting].
The item view window is displayed.
* Double-click the [SLIB] mark to jump to the screen library editing window.
2. Select the screen library to change with [Call No.] or the [Refer to] button.

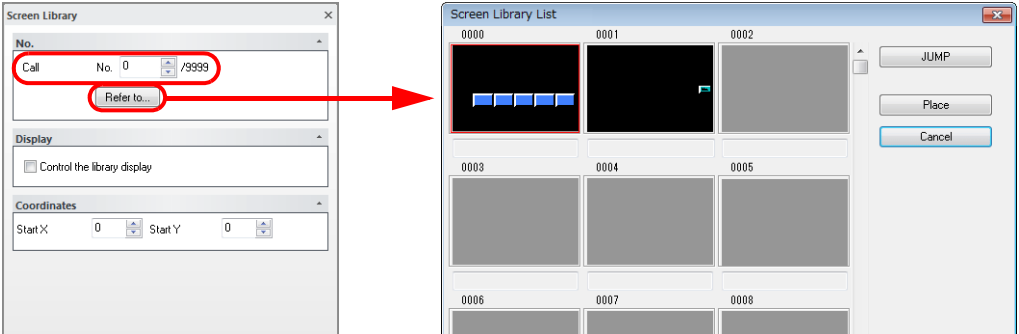

Screen Library Device Memory Specification

The display of screen libraries can be toggled using device memory.

- * **When performing device memory control of screen libraries, the display can be changed when the screen is redrawn.**

There are two methods of redrawing the screen:

Method 1: Switch the screen.

Method 2: Execute the "SYS(RESET_SCRN)" macro command. (For more information, refer to the V9 Series Macro Reference Manual.)

1. Click the [SLIB] mark of the screen library to control by device memory, right-click and select [Detail Setting].
The item view window is displayed.
* Double-click the [SLIB] mark to jump to the screen library editing window.
2. Select the [Control the library display] checkbox.
For more information on the setting items, refer to the next section.

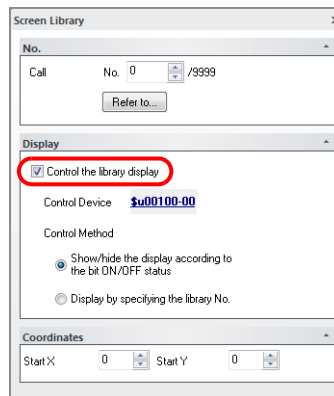

[Display] area

Item	Description
Control Device	Set the device memory for controlling the screen library.
Control Method	<p>Select the device memory control method to use.</p> <p>[Show/hide the display according to the bit ON/OFF status] Show and hide the screen library specified for [Call]. Control device ON: Show Control device OFF: Hide</p> <p>[Display by specifying the library No.] Display the screen library number specified by the control device memory (word specification).</p>

6.5.5 Screen Library Environment Settings

Environment settings for screen libraries are also performed via [View] → [Display Environment]. Therefore, this section explains the display environment settings that are different from those in screen editing.

[Base Screen Dsp.] ([Others] tab)

While editing a screen library, a screen or overlap library can be placed in the background to check how the screen will actually look when displayed.

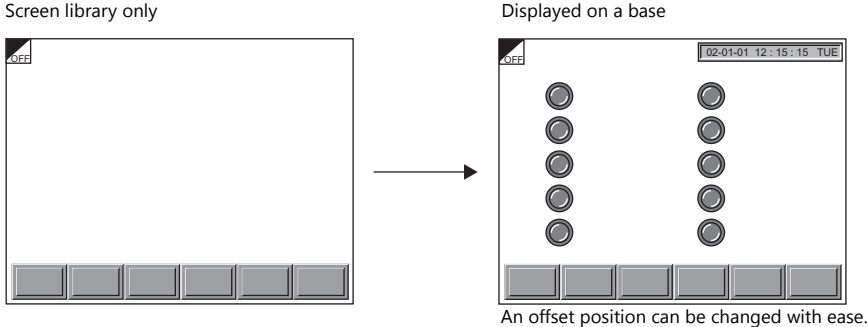

Click [View] → [Display Environment].
The [Display Environment] window is displayed. Display the [Others] tab.
Select the [Base Screen Dsp.] checkbox to enable [Screen]. Select either one and specify the desired number.
Click [OK] to display the selected screen as the background.

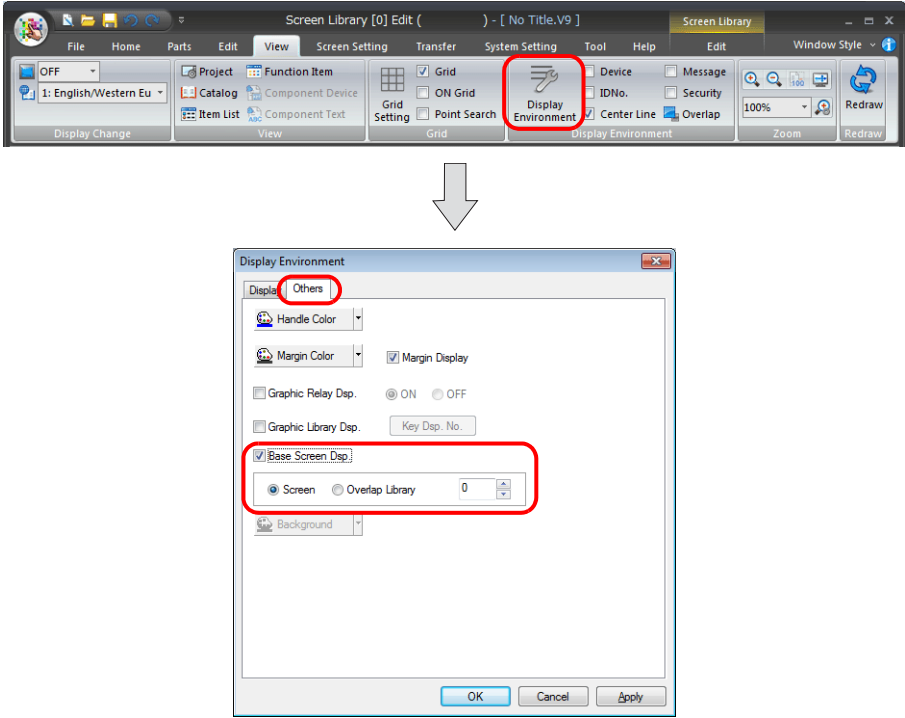

[Background] ([Others] tab)

It is possible to change the background color of a screen library.



When the screen library is called, its background setting is ignored and thus only the registered graphic is recognized as a target.

Click [View] → [Display Environment].

The [Display Environment] window is displayed. Display the [Others] tab.

Select the desired background color and click [OK].

The screen library is shown on the background colored as specified.

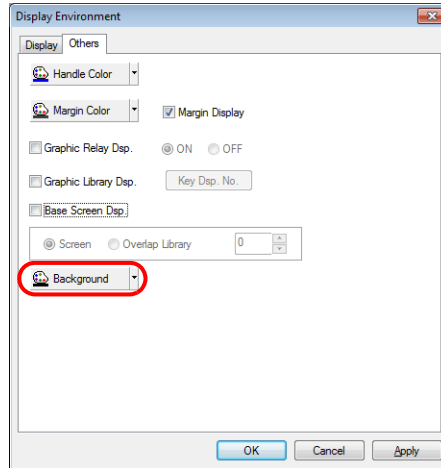

After a screen library is placed on a screen or overlap, the [SLIB] mark can be hidden.

Click [View] → [Display Environment].

The [Display Environment] window is displayed. Display the [Display] tab.

Deselect the [Display MLIB/GLIB/SLIB Mark] checkbox. Click [OK] and the [SLIB] mark becomes hidden.

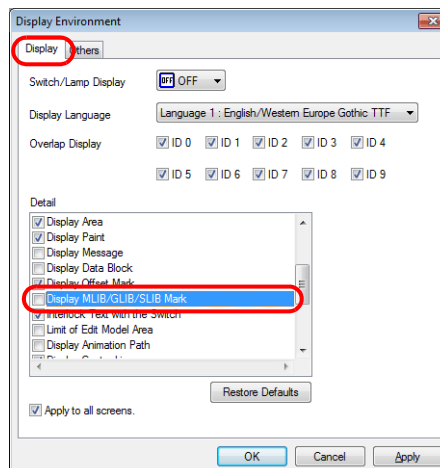
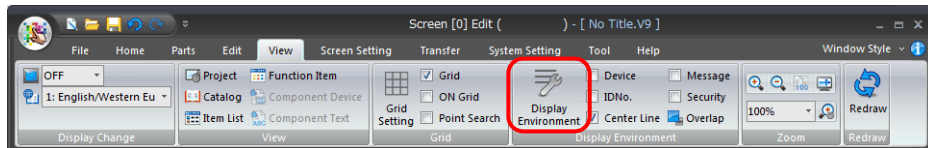

6.6 Graphic Library

Graphics or numerical data displays that will be displayed by bit setting (ON) are registered in the graphic library.

6.6.1 Graphic Library Structure

A graphic library screen and a screen are the same in size.

A total of 2,560 graphic library screens are divided into 10 groups for registration.

Therefore, one graphic library group is capable of storing 256 screens.

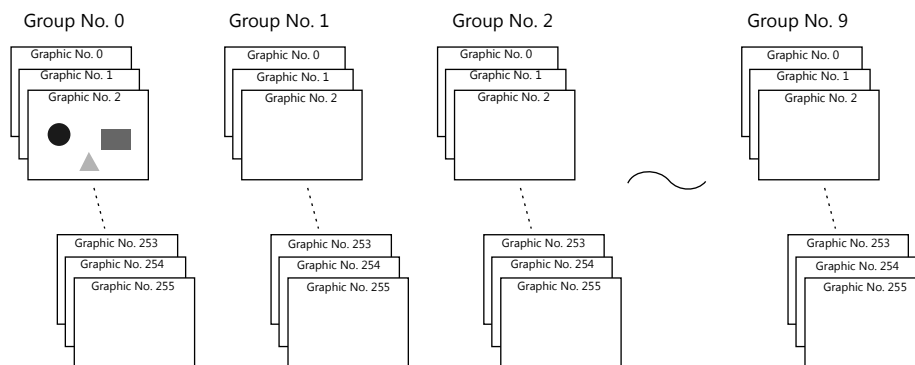

6.6.2 Calling the Graphic Library

Click [Home] → [Registration Item] → [Graphic Library].

The [Graphic Library] window is displayed. Specify the graphic library group number to open and the desired graphic number and click [OK].

(Alternatively, you can call one from the [Registration Item] menu in the project list view window.)

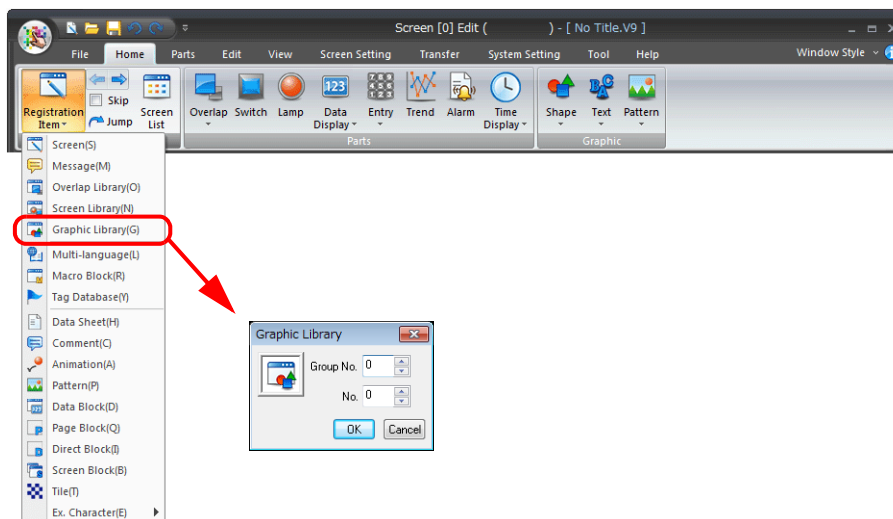

6.6.3 Graphic Library Editing



Only drawing items can be registered in the graphic library
Items such as parts cannot be registered. (Only data displays can be registered.)

An [Edit] menu is added to the right end of the ribbon menu when the [Graphic Library Edit] tab window is displayed. This menu is shown below.

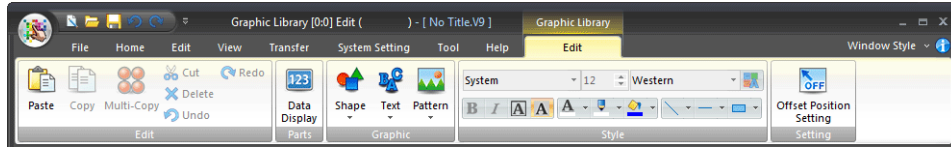

Except for the points below, the editing procedure is the same as the procedure for screens.



For more information, refer to "3.6 Shape and Text Graphics" page 3-48.

This section explains the drawing item editing procedures specific to the graphic library.

Offset Position Setting

Outline of offset position

Every graphic library screen in the graphic library has a reference position called an offset. When a registered graphic library is called to the screen, it is placed based on the offset position.

Example: Placement position of the graphic library on a screen = "OFF" position in the graphic library

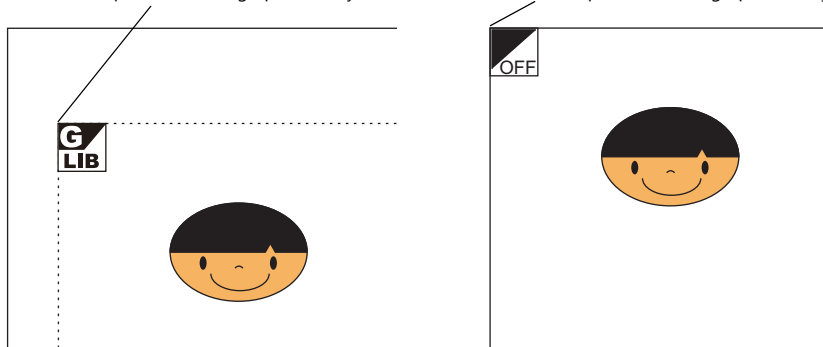

An offset position of the graphic library is shown with an "OFF" mark.

Changing an offset position

Every graphic library has an offset position at coordinates X, Y (0, 0) as default. To change the position, follow the procedure below.

1. An [Edit] menu is added to the right end of the ribbon menu when the [Graphic Library Edit] tab window is displayed. Click [Offset Position Setting].

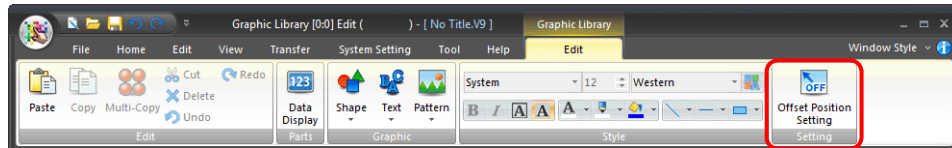

2. A crosshair marked with "OFF" appears.



3. Click the left mouse button at an arbitrary position on the screen. The [OFF] offset mark is displayed at that location.

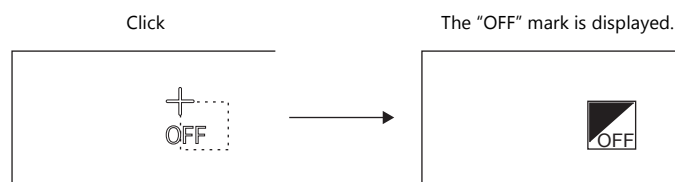

Changes made to the offset position prior to registering a graphic are invalid. Set an offset position after registering a graphic.

Parameter Settings

Outline of parameters

Of the graphic items registered to a graphic library, there may be items which move or transform on screen. Data display parts (explained later) may be registered as well. Device memory must be allocated for such movement and display operations. These device memory are called "parameters."



Simply setting parameters in the graphic library will not move, transform, or change graphics. Be sure to set the [Valid parameter No.] in the settings window of the graphic part placed on the screen.

Example: When [Operation Select] is set to [Device (Bit Designation)]

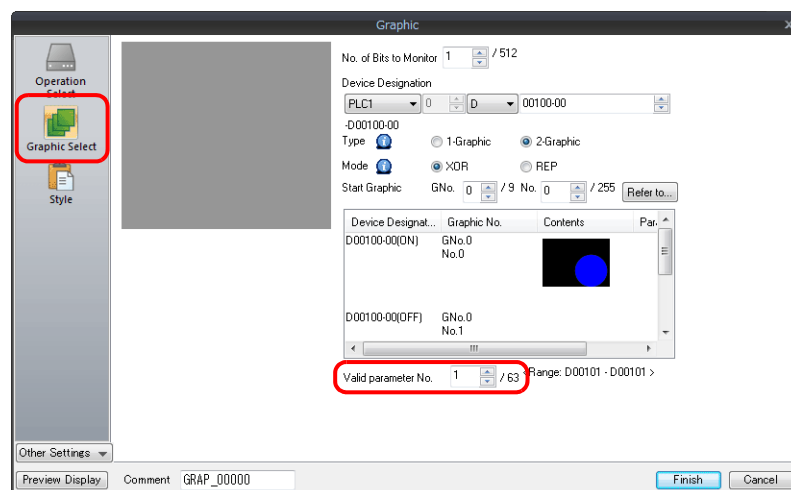

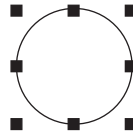

Parameter setting procedure

1. Click on a drawing item in the graphic library to select it.

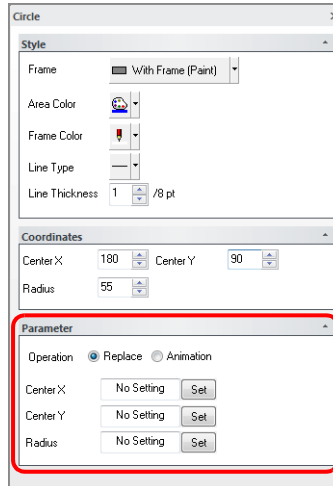

2. The item view window is displayed. Configure the [Parameter] area settings. For more information on the setting items, refer to the next section.



 The [Parameter] settings differ depending on the type of selected item. For more information, refer to page 6-29.

[Parameter] area

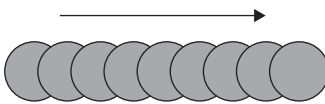
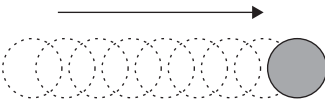
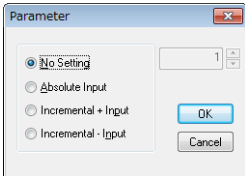
Item	Description
<p>Operation</p>	<p>When moving, transforming, or changing graphics, the new one is placed over the previous one, or the previous one is cleared before the new one is placed on the screen. Select either method.</p> <p>[Replace] Overwrite the previous state. The previous state will remain.</p>  <p>* Enabled when there is no display area and [System Setting] → [Unit Setting] → [General Setting] → [Retain the previous picture in graphic mode (V8 compatible)] is selected.</p> <p>[Animation] Only the new graphic is placed on the screen.</p> 
<p>Set (For each option)</p>	<p>Clicking the [Set] button for each setting displays the [Parameter] window.</p>  <p>Refer to the following description for details.</p>

• [Parameter] window

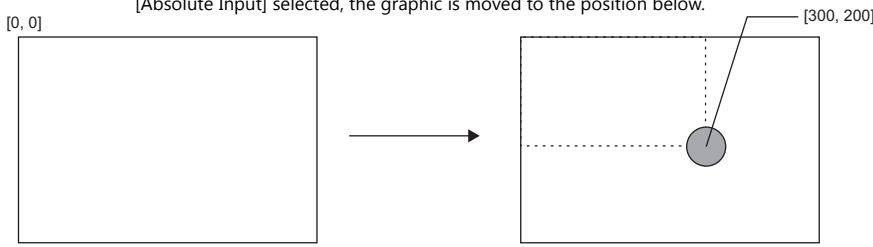
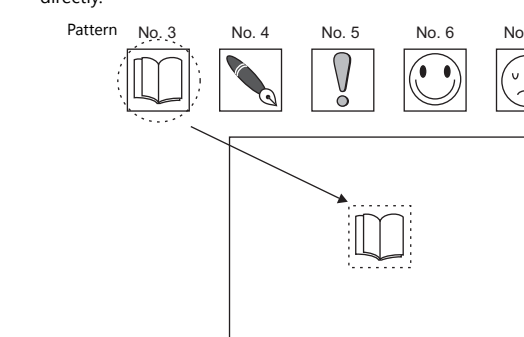
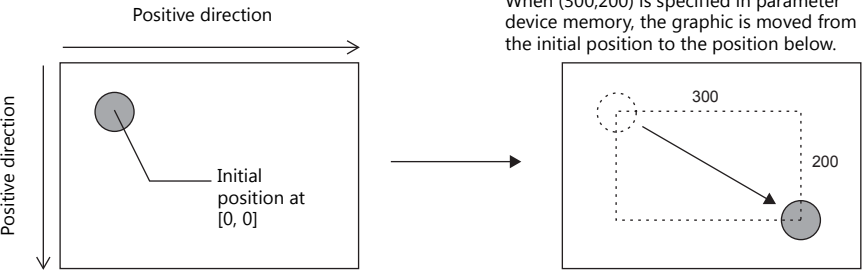
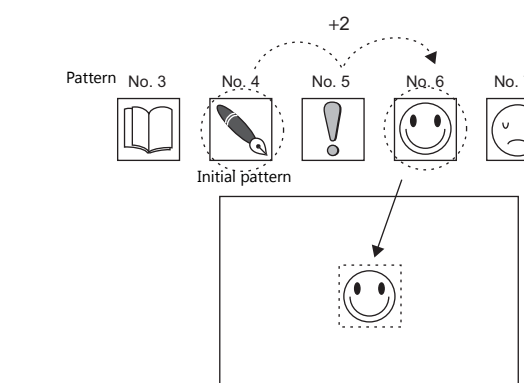
Item	Description
No Setting	Do not secure a device memory for the parameter.
Absolute Input	<p>Specify the parameter value using absolute coordinates.</p> <ul style="list-style-type: none"> When specifying coordinates The following shows an example when target coordinate values are specified in a device memory where the coordinates of the top left corner of the screen are [0, 0] and the coordinates of the bottom right corner are [639, 479] (for 640 × 480 dots). When (300, 200) is specified in parameter device memory with [Absolute Input] selected, the graphic is moved to the position below.  <ul style="list-style-type: none"> When specifying numbers (only when using patterns and graphic libraries) Specify a registered pattern number or a graphic number (from 0 to 2599) in the graphic library directly.  <p>If "3" is specified for the parameter device memory, pattern number 3 is displayed.</p>
Incremental + Input	<p>Specify parameter values in incremental coordinates in the positive direction.</p> <ul style="list-style-type: none"> When specifying coordinates Based on a graphic position regarded as (0, 0), specifying a positive coordinate value in device memory moves it in the positive direction and specifying a negative coordinate value moves it in the negative direction.  <p>When (300,200) is specified in parameter device memory, the graphic is moved from the initial position to the position below.</p> <ul style="list-style-type: none"> When specifying numbers (only when using patterns and graphic libraries) Based on a placed pattern or graphic number regarded as "0," specifying a positive value in device memory calls a pattern or a graphic of a greater number, and specifying a negative value calls a pattern or a graphic of a smaller number.  <p>When the initial pattern number is "4" and "2" is specified for the parameter device memory, pattern number 6 is displayed.</p>

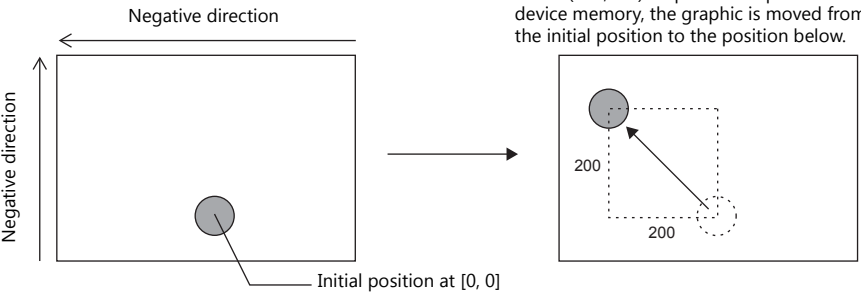
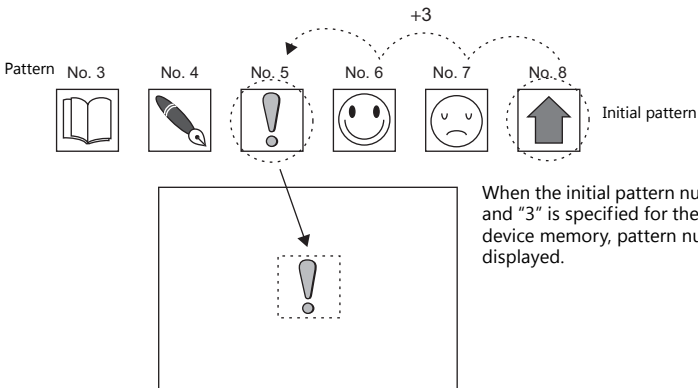
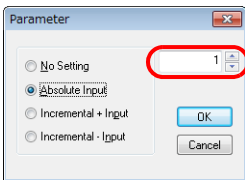
Item	Description																																																																																																							
Incremental - Input	<p>Specify parameter values in incremental coordinates in the negative direction.</p> <ul style="list-style-type: none"> When specifying coordinates Based on a placed graphic position regarded as (0, 0), specifying a positive coordinate value in device memory moves it in the negative direction and specifying a negative coordinate value moves it in the positive direction.  <p>When (200,200) is specified in parameter device memory, the graphic is moved from the initial position to the position below.</p> <ul style="list-style-type: none"> When specifying numbers (Only when using patterns and graphic calls) Based on a placed pattern or graphic number regarded as "0," specifying a positive value calls a pattern or a graphic of a smaller number, and specifying a negative value calls a pattern or a graphic of a greater number.  <p>When the initial pattern number is "8" and "3" is specified for the parameter device memory, pattern number 5 is displayed.</p>																																																																																																							
No.	<p>When using parameters, be sure to set a parameter number in the [Parameter] window.</p>  <p>Parameter numbers are assigned consecutively from the command device memory of graphic parts.</p> <p>Example: [Device Designation]: D200, [Type]: 1-Graphic, [Start Graphic]: GNo. 1, No. 4, [No. of Bits to Monitor]: 20, [Valid parameter No.]: 4</p> <table border="1" data-bbox="662 1541 1189 1724"> <tr><td>D200</td><td>For graphic relay operation (16 relays)</td></tr> <tr><td>D201</td><td>For graphic relay operation (4 relays)</td></tr> <tr><td>D202</td><td>For parameter No. 1</td></tr> <tr><td>D203</td><td>For parameter No. 2</td></tr> <tr><td>D204</td><td>For parameter No. 3</td></tr> <tr><td>D205</td><td>For parameter No. 4</td></tr> </table> <p>Total of 20 = [No. of Bits to Monitor]</p> <table border="1" data-bbox="574 1758 1380 1892"> <tr> <td></td> <td>MSB</td> <td>15</td><td>14</td><td>13</td><td>12</td><td>11</td><td>10</td><td>09</td><td>08</td><td>07</td><td>06</td><td>05</td><td>04</td><td>03</td><td>02</td><td>01</td><td>00</td> <td>LSB</td> </tr> <tr> <td>D200 bit No.</td> <td></td> <td>15</td><td>14</td><td>13</td><td>12</td><td>11</td><td>10</td><td>09</td><td>08</td><td>07</td><td>06</td><td>05</td><td>04</td><td>03</td><td>02</td><td>01</td><td>00</td> <td></td> </tr> <tr> <td>Group No. 1 graphic No. (Bit ON)</td> <td></td> <td>19</td><td>18</td><td>17</td><td>16</td><td>15</td><td>14</td><td>13</td><td>12</td><td>11</td><td>10</td><td>9</td><td>8</td><td>7</td><td>6</td><td>5</td><td>4</td> <td></td> </tr> </table> <p>16 bits for monitoring</p> <table border="1" data-bbox="550 1948 1380 2049"> <tr> <td>Bit No. of D201</td> <td>15</td><td>14</td><td>13</td><td>12</td><td>11</td><td>10</td><td>09</td><td>08</td><td>07</td><td>06</td><td>05</td><td>04</td><td>03</td><td>02</td><td>01</td><td>00</td> </tr> <tr> <td>Group No. 1 graphic No. (Bit ON)</td> <td></td><td></td><td></td><td></td><td></td><td></td><td></td><td></td><td></td><td></td><td></td><td></td><td>23</td><td>22</td><td>21</td><td>20</td> </tr> </table> <p>Because [No. of Bits to Monitor] is 20, 20 graphics are assigned to 16 bits in D200 and 4 bits in D201.</p> <p>4 bits for monitoring</p>	D200	For graphic relay operation (16 relays)	D201	For graphic relay operation (4 relays)	D202	For parameter No. 1	D203	For parameter No. 2	D204	For parameter No. 3	D205	For parameter No. 4		MSB	15	14	13	12	11	10	09	08	07	06	05	04	03	02	01	00	LSB	D200 bit No.		15	14	13	12	11	10	09	08	07	06	05	04	03	02	01	00		Group No. 1 graphic No. (Bit ON)		19	18	17	16	15	14	13	12	11	10	9	8	7	6	5	4		Bit No. of D201	15	14	13	12	11	10	09	08	07	06	05	04	03	02	01	00	Group No. 1 graphic No. (Bit ON)													23	22	21	20
D200	For graphic relay operation (16 relays)																																																																																																							
D201	For graphic relay operation (4 relays)																																																																																																							
D202	For parameter No. 1																																																																																																							
D203	For parameter No. 2																																																																																																							
D204	For parameter No. 3																																																																																																							
D205	For parameter No. 4																																																																																																							
	MSB	15	14	13	12	11	10	09	08	07	06	05	04	03	02	01	00	LSB																																																																																						
D200 bit No.		15	14	13	12	11	10	09	08	07	06	05	04	03	02	01	00																																																																																							
Group No. 1 graphic No. (Bit ON)		19	18	17	16	15	14	13	12	11	10	9	8	7	6	5	4																																																																																							
Bit No. of D201	15	14	13	12	11	10	09	08	07	06	05	04	03	02	01	00																																																																																								
Group No. 1 graphic No. (Bit ON)													23	22	21	20																																																																																								

Parameter setting items

Parameters can be set for the following drawing items and parts.

Graphic	Item Specified by Parameter	See Example
Straight Line	Start point X, start point Y, end point X, and end point Y	
Continuous Line	Point 0 (to n) X, point 0 (to n) Y	1
Rectangle	Start point X, start point Y, end point X, and end point Y	
Parallelogram	Upper left X, upper left Y, upper right X, upper right Y, lower right X, lower right Y	2
Polygon	Center X, center Y, radius, start angle, number of corners	
Circle	Center X, center Y, radius	
Arc, sector	Center X, center Y, radius, start angle, end angle	
Ellipse, elliptical arc, elliptical sector	Center X, center Y, radius X, radius Y	
Text	Start point X, start point Y (coordinates at the bottom left of the first character)	
Multi-text	Start point X, start point Y (coordinates at the top left of the first character)	
Pattern	Start point X, start point Y (coordinates of top left corner), (pattern) number	3
Paint	Start X, start Y	4
Graphic Library	Start X, start Y, (library) number	
Dot	Start X, start Y	
Data Display	Parameters (for display), start X, start Y (coordinates at the bottom left of the first character)	*1

*1 For information on data display parameters, refer to page 6-32.

1. Continuous line (point 0 (to n) X, Y)

If a continuous line is drawn as shown below, there are seven points at which parameters can be set.

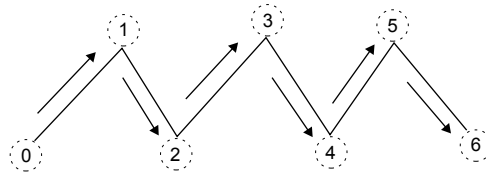

2. Parallelogram

- Upper right X

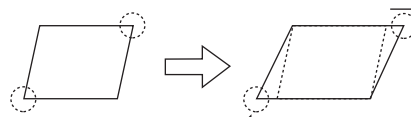

- Upper right Y

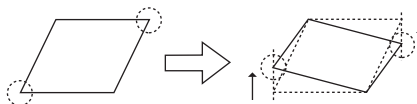

- Lower right X

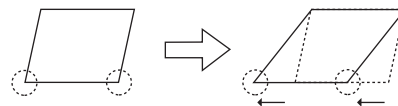

- Lower right Y

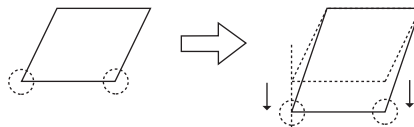

3. Pattern

- Start point

The start point is the top left corner of the pattern, as shown below.

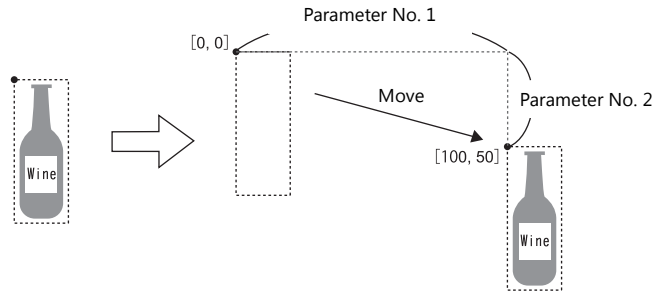

- (Pattern) No.

Set the parameters for the numbers to change the picture by specifying a number.

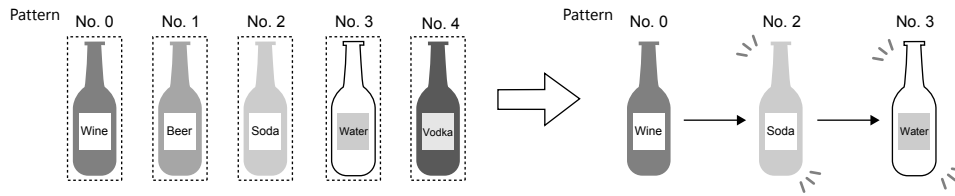

4. Paint (start point)

The coordinates of the paint start point can be changed using a parameter device memory.

Note that drawing is performed using REP instead of XOR so the previous paint display (e.g. circle) will remain.

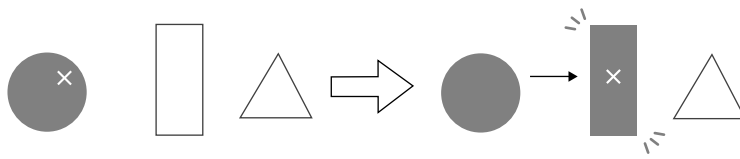

Data Display

Outline of data display in the graphic library

In the graphic library, it is possible to use a function similar to data display parts as used on the screen. One device memory is always assigned for parameters for the purpose of displaying and changing data display values.

Data display on graphic libraries can be used as shown below.

- Showing/deleting a data display through bit setting (ON)/resetting (OFF)



- Moving a data display on the screen (by parameter setting)

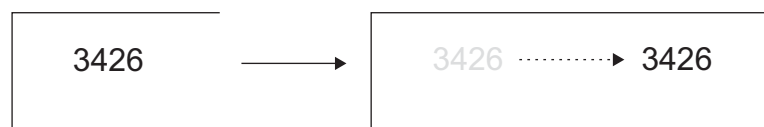

- Showing variations in data (by parameter setting)

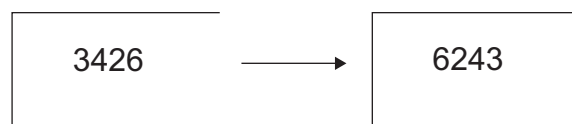

Data display placement procedure

- An [Edit] menu is added to the right end of the ribbon menu when a graphic library is opened. Click the [Data Display] icon. Dragging the mouse to the screen shows a data display with a crosshair.

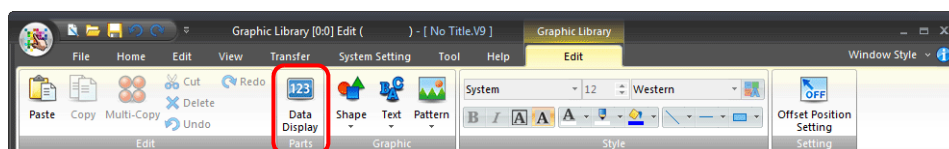

1234

Displayed with a crosshair

- The item view window for the placed data display is displayed on the screen. (If the view window does not appear, double-click the data display.)

Data display setting procedure

Click (or double-click) the placed data display.
The [Data Display] item view window is displayed.

Click or double-click.

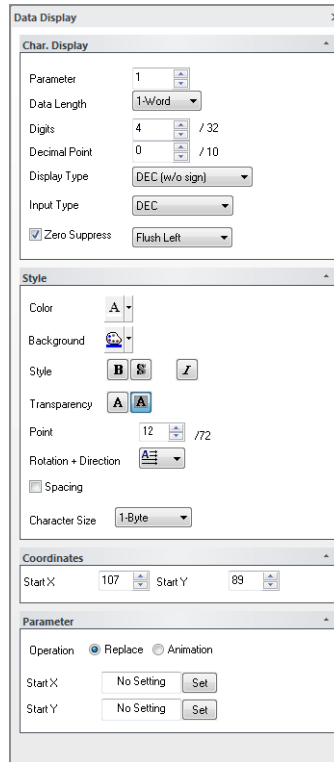

- [Char. Display] area

Item	Description																
Parameter	Set the parameter number for the data display. For more information on parameter numbers, refer to page 6-28.																
Display Type	<table border="1"> <tr><td>DEC (w/o sign)</td><td></td></tr> <tr><td>DEC (with sign -)</td><td></td></tr> <tr><td>DEC (with sign +-)</td><td></td></tr> <tr><td>HEX</td><td></td></tr> <tr><td>OCT</td><td></td></tr> <tr><td>BIN (Binary)</td><td></td></tr> <tr><td>CHAR</td><td>Character display</td></tr> <tr><td>MSG</td><td>Message display</td></tr> </table>	DEC (w/o sign)		DEC (with sign -)		DEC (with sign +-)		HEX		OCT		BIN (Binary)		CHAR	Character display	MSG	Message display
DEC (w/o sign)																	
DEC (with sign -)																	
DEC (with sign +-)																	
HEX																	
OCT																	
BIN (Binary)																	
CHAR	Character display																
MSG	Message display																

- [Parameter] area

This area is used to make settings for moving the data display and showing data variations.

Item	Description
Operation	<p>When moving or changing the data display, the new one is placed over the previous one, or the previous one is cleared before the new one is placed on the screen. Select either method.</p> <ul style="list-style-type: none"> • [Replace] Overwrite the previous state. The previous state will remain. * Enabled when there is no display area and [System Setting] → [Unit Setting] → [General Setting] → [Retain the previous picture in graphic mode (V8 compatible)] is selected. • [Animation] Only the new graphic is placed on the screen.
Set (For each option)	Clicking the [Set] button for each setting displays the [Parameter] window. For more information, refer to page 6-27.

6.6.4 Graphic Library Environment Settings

Graphic library environment settings are the same as for screen libraries.



For more information, refer to "Screen Library Environment Settings" (page 6-21).

6.7 Multi-language

This area is provided for the use of the language selection function.



For more information, refer to "9 Language Changeover" in V9 Series Reference Manual 2.

6.8 Macro Block

Macro programs are registered in macro blocks.

Macro blocks are executed by CALL commands in event timer macros or other macro programs.



For details on macros, refer to the V9 Series Macro Reference Manual.

6.8.1 Macro Block Structure

A maximum of 1,024 macro blocks can be registered.

A maximum of 1,024 lines can be set for one macro block.

6.8.2 Calling a Macro Block

Select [Macro Block] from the [Registration Item] menu.

The [Macro Block] window is displayed. Specify the macro block number to open and click [OK].

(Alternatively, you can call one from the [Registration Item] menu in the project list view window.)

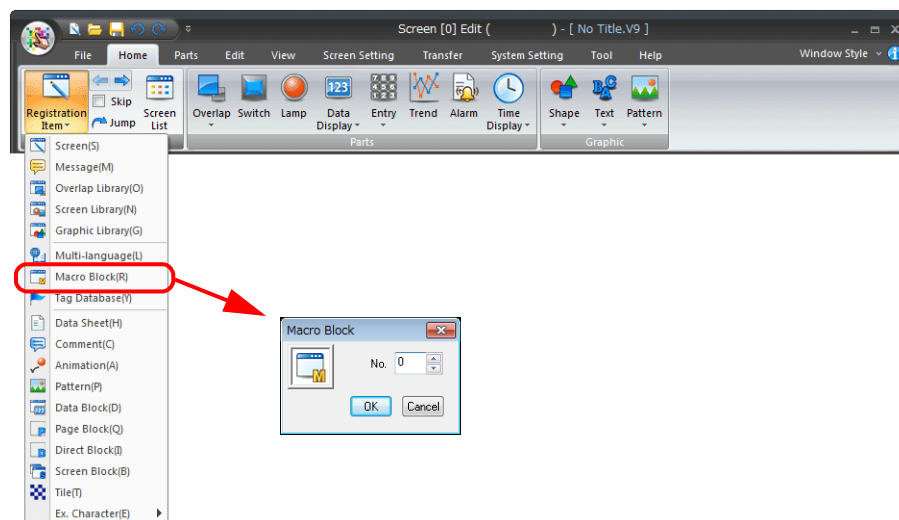

6.8.3 Macro Block Editing



For more information on macro editing, refer to "Chapter 2 Edit" in the V9 Series Macro Reference Manual.

6.9 Tag Database

This area is used to assign names (tags) to PLC device memory or internal device memory (\$u, \$L, etc.) used on the V9 series unit.



For more information, refer to "10 Tag" in V9 Series Reference Manual 2.

6.10 Data Sheet

When data sheet screens have been registered, data in the format of data sheets can be printed out from the V9 series unit by means of the data sheet function.

6.10.1 Data Sheet Structure

A maximum of 1,024 data sheets can be registered.

Make settings for a data sheet including the size and orientation in the [Data Sheet Page Setting] window. For more information on the [Data Sheet Page Setting] window, refer to the next page.

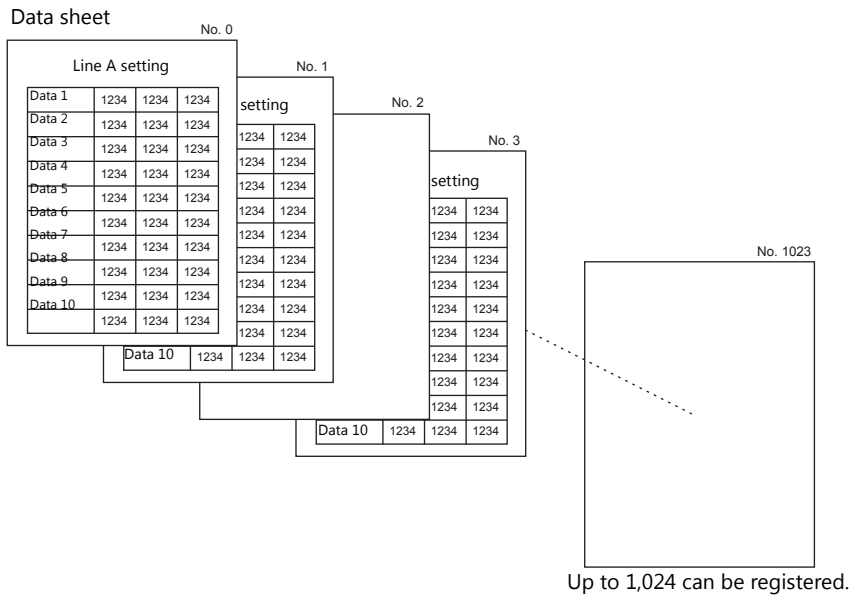

6.10.2 Calling a Data Sheet

Click [Home] → [Registration Item] → [Data Sheet].

The [Data Sheet] window is displayed. Specify the data sheet number to open and click [OK].

(Alternatively, you can call one from the [Registration Item] menu in the project list view window.)

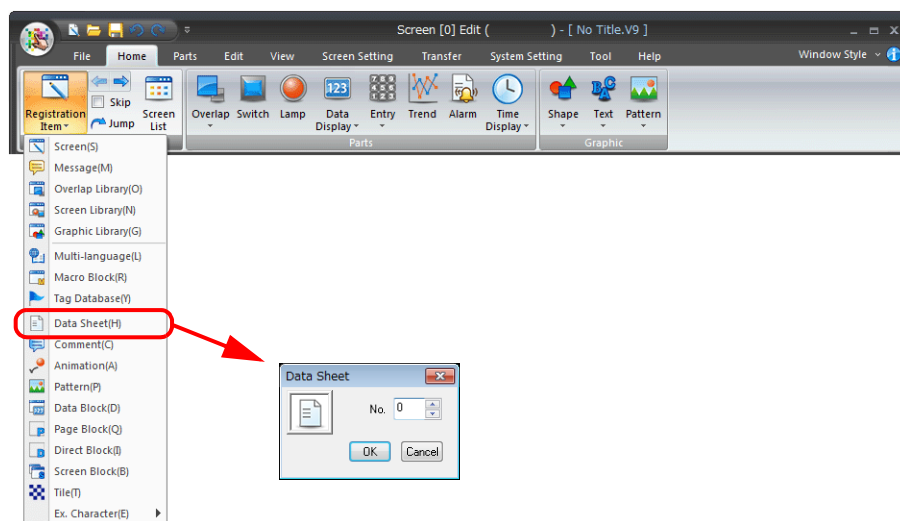

6.10.3 Data Sheet Editing

An [Edit] menu is added to the right end of the ribbon menu when the [Data Sheet Edit] tab window is displayed. Edit the data sheet using the items on this [Edit] menu.

Data Sheet Setting

Set the size and number of characters and lines of the data sheet. Click [Data Sheet Setting] to display the [Data Sheet Setting] window.

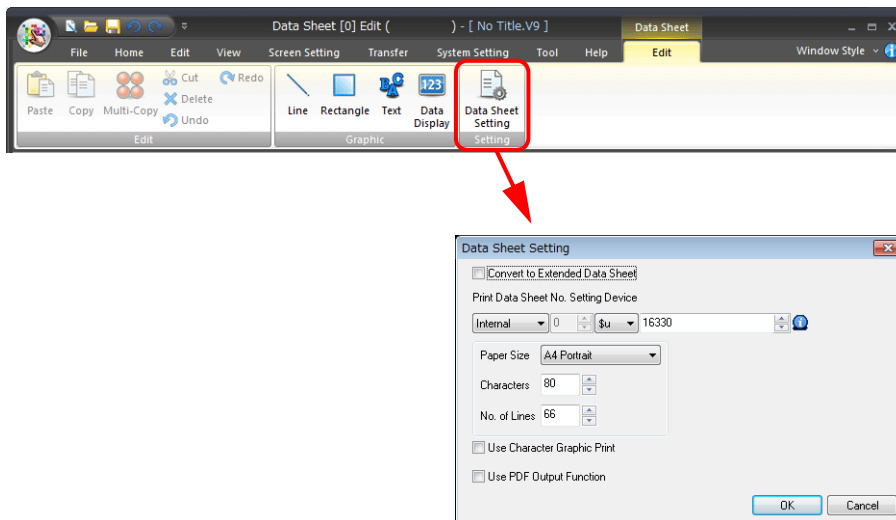

Item	Description
Paper Size (A4 Portrait, A4 Landscape, 15-Inch Landscape, User Designation)	Select a paper size. The numbers of characters and lines are set according to the selected size. Printed images are always in portrait orientation.
Characters (16 to 152)	Specify the number of characters per line on a data sheet page.
No. of Lines (2 - 152)	Specify the number of lines per data sheet page.

For other settings, refer to "16 Print" in V9 Series Reference Manual 1.

Graphics

Items usable on data sheets vary depending on whether the [Convert to Extended Data Sheet] checkbox is selected.

- [Convert to Extended Data Sheet]: Unselected
- [Convert to Extended Data Sheet]: Selected

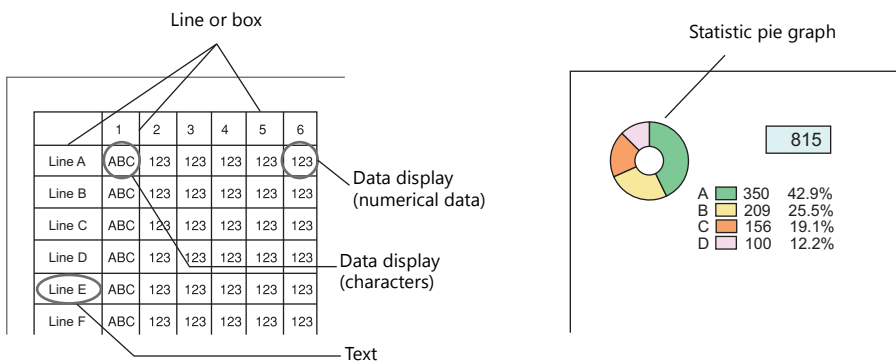

Item	[Convert to Extended Data Sheet]: Unselected	[Convert to Extended Data Sheet]: Selected (EPSON ESC/P-R and PictBridge only)
Drawing parts	Straight Line Rectangle Text	Line/Continuous Line Rectangle/Circle Text/Multi Text Dot Paint Scale Pattern

Item	[Convert to Extended Data Sheet]: Unselected	[Convert to Extended Data Sheet]: Selected (EPSON ESC/P-R and PictBridge only)
Parts	Numerical Display Character Display	Lamp Numerical Display Character Display Message Display Bar Graph Pie Graph Panel Meter Statistic Bar Graph Statistic Pie Graph Time Display/Calendar

[Convert to Extended Data Sheet]: Unselected

- Straight Line
Straight lines can be drawn by dragging.



It is possible to draw lines only horizontally or vertically. Line type settings, diagonal lines, and continuous lines are not available.

- Rectangle
Only rectangles without painting can be drawn.
- Text
When [Text] is clicked and then the mouse is clicked on or dragged to the screen, the text entry area is created on the screen.
To make changes to the properties after entering text, perform changes in the [Text] view window.
Text enlargement is limited to X: 1 × Y: 1.
Only when [Enlarge X] is checked, the X size is doubled.

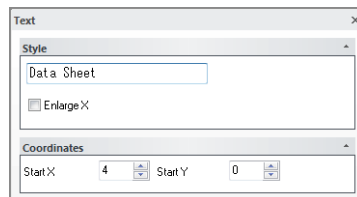

- Data Display
Clicking (or double-clicking) the data display part placed by clicking the [Data Display] icon displays the [Data Display] view window shown below.

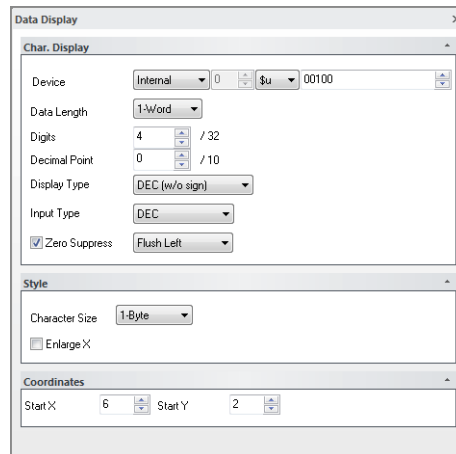

Character enlargement is limited to X: 1 × Y: 1.
Only when [Enlarge X] is checked, the X size is doubled.



Displaying a calendar part

A calendar display can be set on a data sheet using a numerical data display. The calendar data is stored in system memory addresses \$s160 to 166. By placing the calendar data with numerical data display on a data sheet, the calendar is also printed out at the time of data sheet printing.

Grid settings

On data sheets, graphics, texts, and data display parts can be placed based on a fixed grid. Texts and data displays are placed along grid dots. Lines and boxes are placed on spaces between grid dots. A grid color and whether or not to show a grid can be selected in the [Grid Setting] window.

Click [View] → [Grid] → [Grid Setting].
The [Grid Setting] window is displayed.

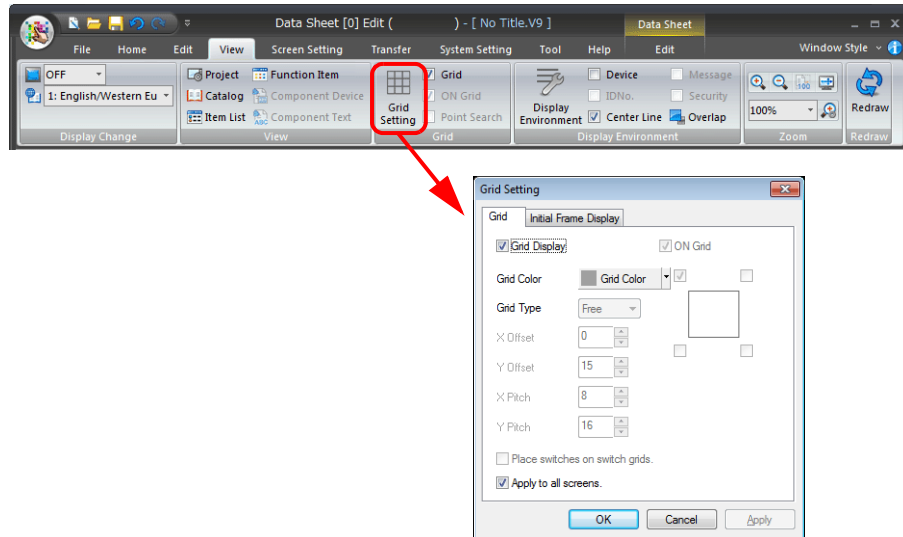

[Convert to Extended Data Sheet]: Selected

The placement method and settings are the same as for graphics on screens. For more information, refer to “3 Placing Parts”.

6.11 Comment

Text consisting of multiple lines can be registered with an allocated comment number and can be called by bit setting or designation of the number.

This function is called comment display and a "comment" refers to an area where text is registered.

The color and size of text can arbitrarily be set on a comment-by-comment basis.

6.11.1 Comment Structure

There are 256 comment groups. A maximum of 128 comments can be registered with one group (127 comments maximum with group No. 0). Accordingly, a maximum of 32767 comments can be registered in total.

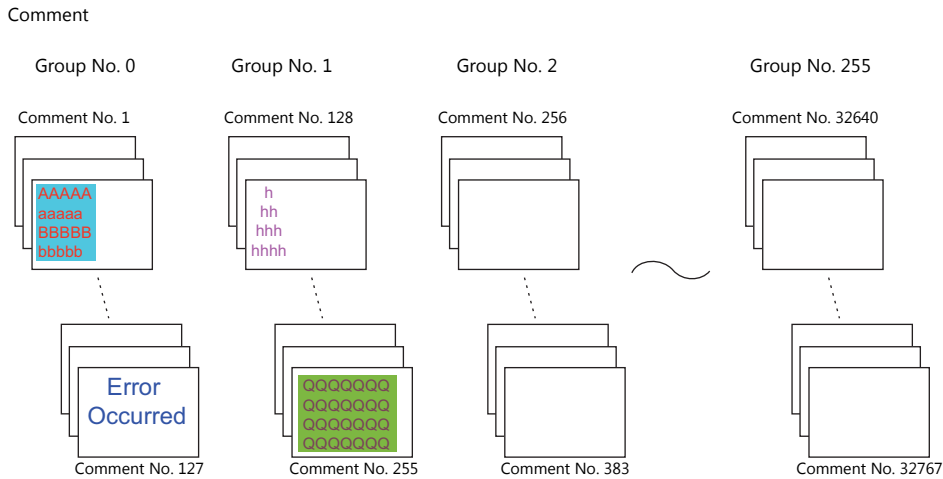

Limitations on Comments

Note the following limitations.

Item	Description
Available characters per line (1-byte)	Max. 127
Available characters per comment (1-byte)	Max. 1024
Available comments	32767 comments

6.11.2 Calling a Comment

Click [Home] → [Registration Item] → [Comment].

The [Comment] window is displayed. Specify the comment group number to open and click [OK].

(Alternatively, you can call one from the [Registration Item] menu in the project list view window.)

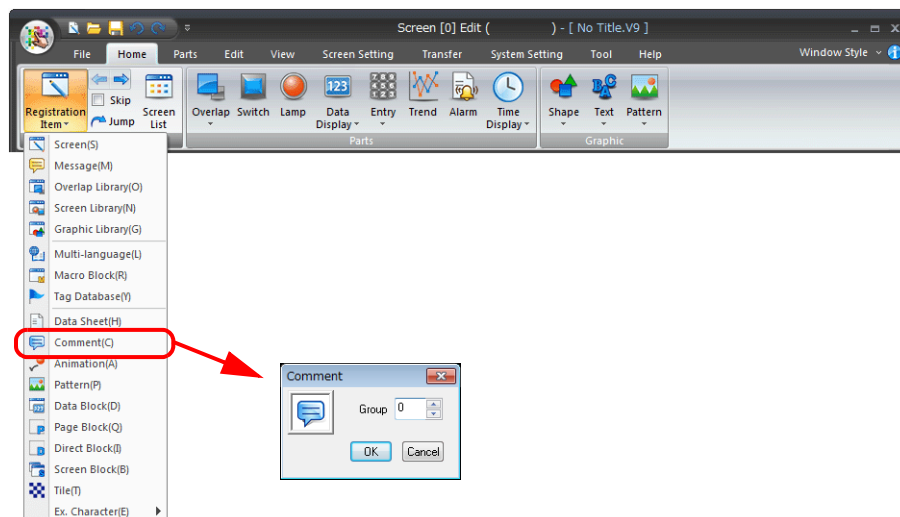

6.11.3 Editing a Comment

Entering a Comment

1. In the [Comment Edit] window, start from No.1 for entering a comment.
Enter the text of the comment just as you type characters normally.

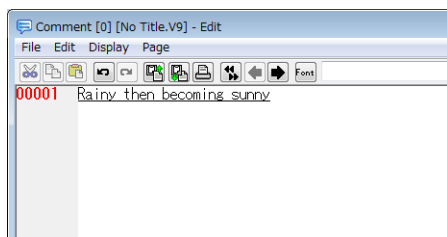

2. To go to comment No. 2, press the [Enter] key.
When entering two or more lines in comment No. 1, hold down the [Alt] key and press the [Enter] key.

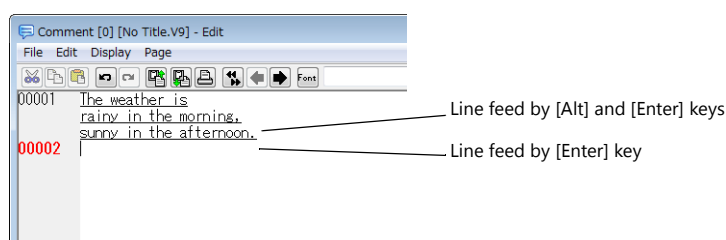

Contrary to the above, the [Enter] key can be used to go to the next line at the same comment number, and the [Alt] and [Enter] keys can be used to go to the next comment number.

To achieve this, click [Page] → [Change Line Feed Operation].

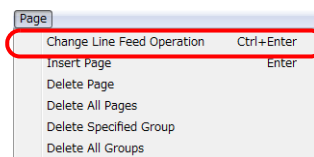

You can see whether or not [Change Line Feed Operation] is checked also on the status bar.

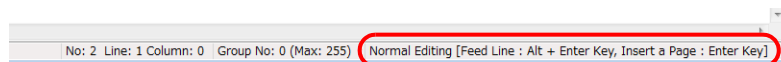

Text Properties

Text properties can be changed on a comment number basis.

1. Move the cursor to the comment for property setting.
2. Right-click and select [Char. Prop.]. The [Char. Prop.] window is displayed.

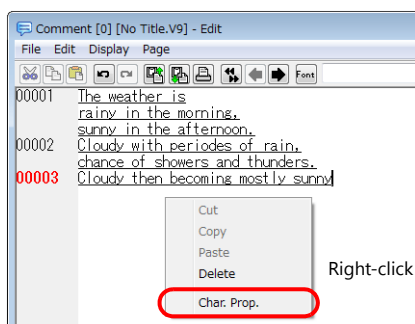

3. In the window, set the options of [Color], [Enlarge], [Windows Font], etc. as necessary.
4. Click [Setting] to update the text with the settings made in the window.
 - * **The text properties you set cannot be previewed in the [Comment Edit] window (only the color is previewed) unless [Windows Font] is set.**
 - When necessary, preview the text properties in the [Screen Edit] window or on the V9 series unit.**

 To shift to the next group, click the [Next] icon on the icon bar.

Deleting a Comment

1. Move the cursor to the comment to be deleted.

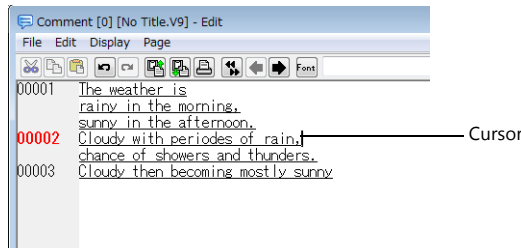

2. Click [Page] → [Delete Page].

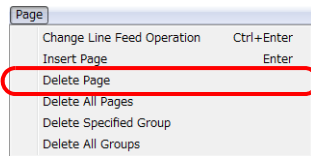

3. The following window is displayed.

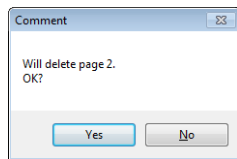

4. When [Yes] is clicked, the corresponding comment is deleted and any subsequent comments are moved up.

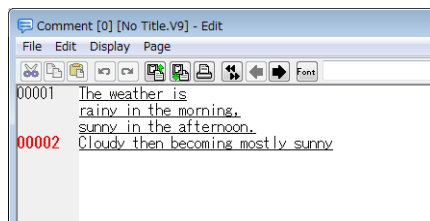

Comment Import and Export

Text registered as comments can be exported, and text can be imported from another data source as well.

- Two formats, TXT and CSV, are supported.
- Once text is imported, undoing is not possible.
- If a text import is executed to a multi-language screen program, the text is imported to the language number you are currently editing.

Comment import and export procedure

1. In the [Comment Edit] window, click [File] → [Import] or [Export].
2. Either an [Open] or [Save As] window is displayed.

For [Save as type], choose [Text File (*.txt)] or [CSV File (*.csv)]. Then open the desired file, or name and save the file.

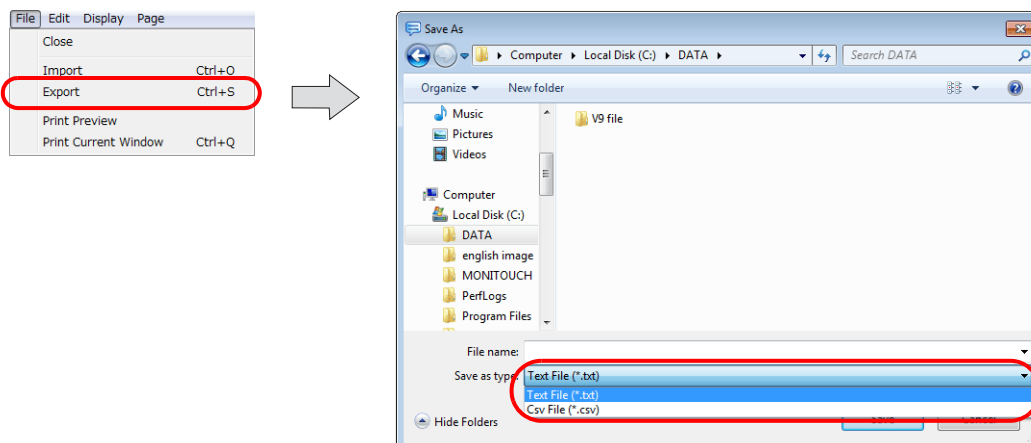

About TXT format

One comment in the TXT format uses at least three lines (for the comment number, comment text, and text properties). The format consists of:

- Comment number (1 to 32767): //
- Comment text: "(text)"
- Text properties

The items of text properties are delimited by commas:

Foreground color, background color, typeface, italic, transparency, start position, rotation, size X, size Y

Foreground color	Hexadecimal RGB value starting with 0x
Background color	Hexadecimal RGB value starting with 0x
Typeface	0: normal, 1: 1/4, 2: bold, 3: shadow
Italic	0: no, 1: yes
Transparency	0: no, 1: yes
Start position	0: flush left, 1: center, 2: flush right Only "0": flush left is available at the present.
Rotate	0: →, 1: ↑, 2: ↓
Size X	When TrueType fonts and Windows fonts are in use, "0" is specified. When bitmap fonts are in use, an enlargement factor in the horizontal direction (1 to 8) is specified.
Size Y	When TrueType fonts and Windows fonts are in use, the point size is specified. When bitmap fonts are in use, an enlargement factor in the vertical direction (1 to 8) is specified.

The following is an example of comments exported in TXT format.

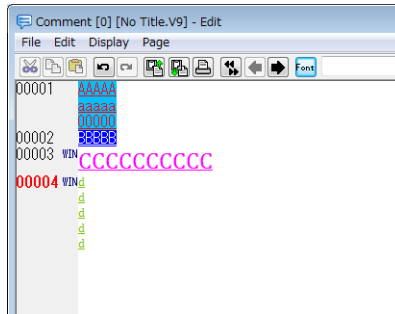

TXT format

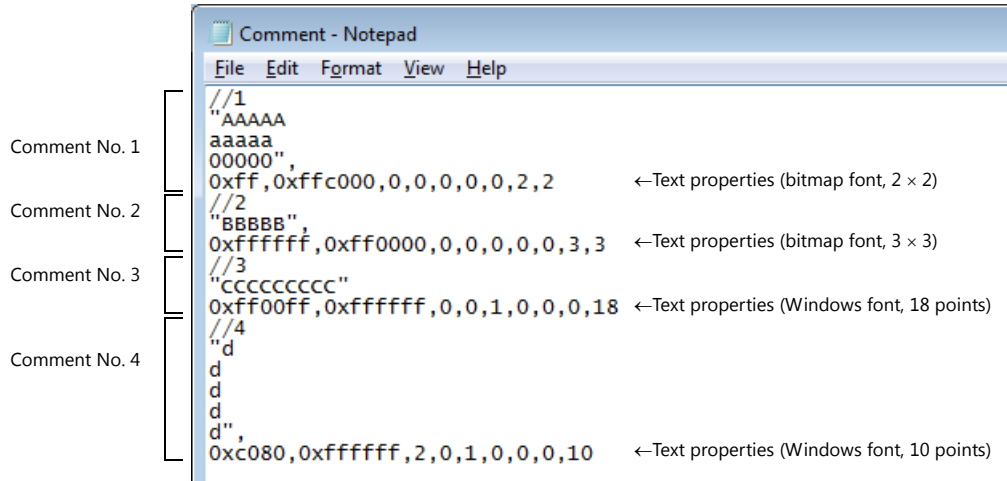

About CSV format

The format consists of:

Comment number, comment text, foreground color, background color, typeface, italic, transparency, start position, rotation, size X, size Y

For more information on the format, refer to the TXT format section.

The following is an example of comments exported in the CSV format.

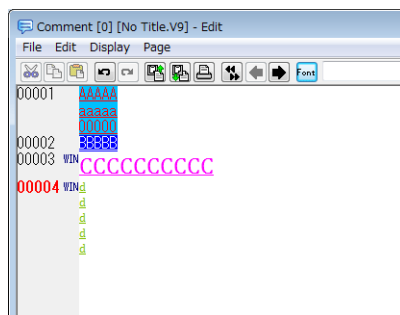

CSV format

	A	B	C	D	E	F	G	H	I	J	K	L
1	1	AAAAA aaaaa 00000	ff	ffc000	0	0	0	0	0	2	2	
2	2	BBBBB	ffffff	ff0000	0	0	0	0	0	3	3	
3	3	CCCCCCC WIN	ff00ff	ffffff	0	0	1	0	0	0	18	
4	4	d d d d	c080	ffffff	2	0	1	0	0	0	10	
5												
6												
7												
8												
9												
10												

6.11.4 [Page] Menu

The [Page] menu is a menu specific to comment editing.

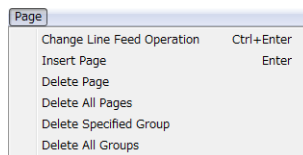

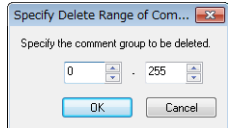
Item	Description
Change Line Feed Operation	<p>Unselected: [Enter] key: Used to newly insert the next comment number [Alt] and [Enter] keys: Used to insert lines in the same comment</p> <p>Selected: [Enter] key: Used to insert lines in the same comment [Alt] and [Enter] keys: Used to newly insert the next comment number</p>
Insert Page	Insert an additional new comment after the comment number where the cursor is currently located.
Delete Page	Deletes the comment specified by the cursor.
Delete All Pages	Delete all comments registered in the displayed group.
Delete Specified Group	<p>Click to display the [Specify Delete Range of Comment] window.</p>  <p>Select the range of groups for deletion and click [OK] to delete all the comments in the specified groups.</p>
Delete All Groups	Delete all registered comments.

6.12 Animation

This area is provided for the use of the animation function.
Graphics for animation are registered.

6.12.1 Animation Function Structure

There are [Animation] and [Frame] areas within the animation function. Graphics are registered in [Frame] areas and the frames to be used are selected in [Animation] areas.

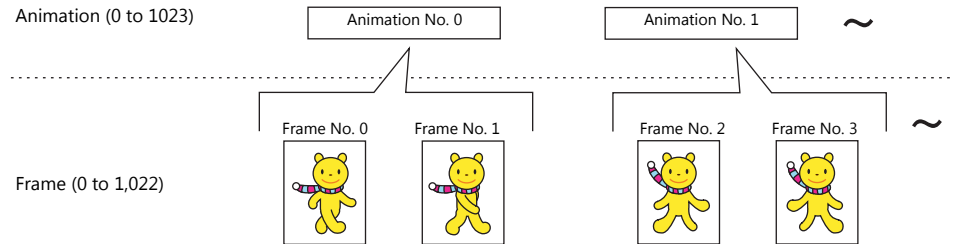

A maximum of 1,024 animation settings from No. 0 to No. 1,023 can be registered.
For these animation settings, a maximum of 1,023 frames from No. 0 to No. 1,022 can be registered.

6.12.2 Calling an Animation

Click [Home] → [Registration Item] → [Animation].

The [Animation] tab window is displayed.

(Alternatively, you can call one from the [Registration Item] menu in the project list view window.)

On this tab window, settings necessary for “animations” and “frames” can be made.

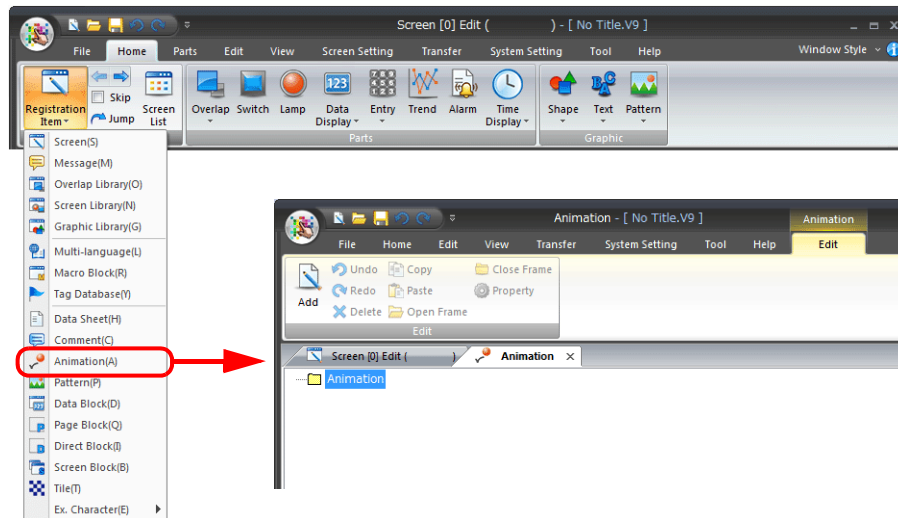

6.12.3 Animation Editing

In the [Animation VIEW] window, the number of frames and animation speed are set, and the actual animated image can be checked.

1. Right-click [Animation] and click [Add].
2. The [Animation VIEW] window is displayed.
Start setting from animation No. 0.

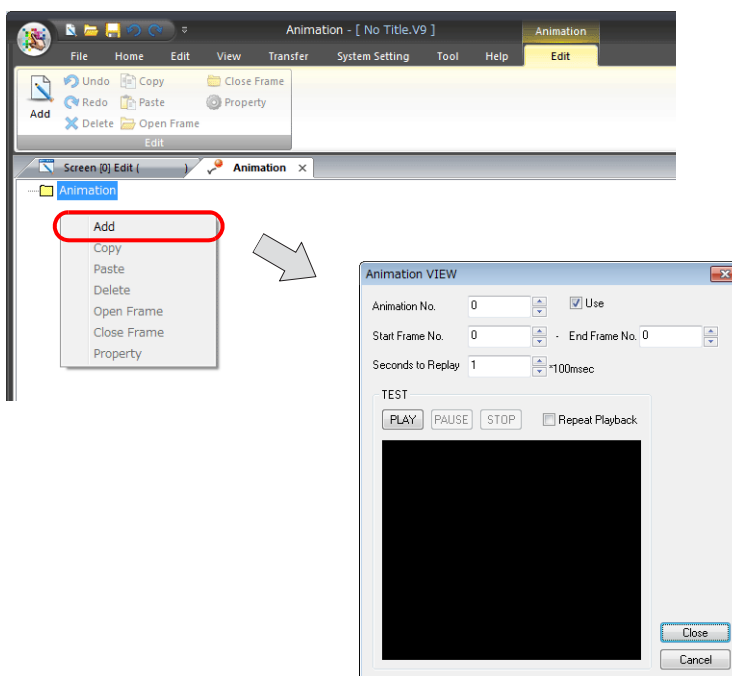

Item	Description
Animation No. (0 to 1023)	Displays the animation number currently being edited. The animation number can be changed by clicking the up/down arrow buttons. The number can also be entered directly without using the buttons.
Use	A selected checkbox denotes that the animation number has been set. To clear the setting, deselect the checkbox.
Start Frame No. and End Frame No. (0 to 1022)	Specify the number (range) of frames to be used for this animation.
Seconds to Replay (×100 msec)	Set the switching cycle (speed) to switch and display the frames specified from [Start Frame No.] to [End Frame No.].
[TEST] area [PLAY] [PAUSE] [STOP] [Repeat Playback]	When the frames have been registered, the actual motion of the animation can be checked.

3. When the settings are complete, click the [Close] button.
The [Animation] tab window is active again.

4. Sub-folders are displayed for the animation number configured in step 2.

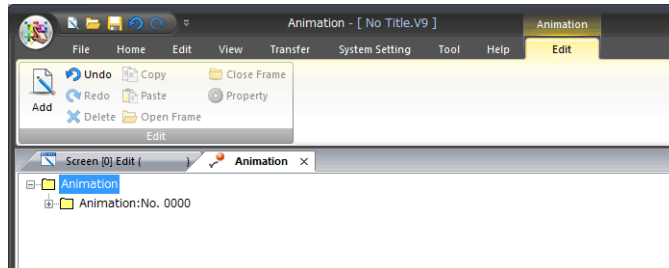

5. To display the [Animation VIEW] window again, right-click the relevant [Animation No. xxxx] folder and click [Property].

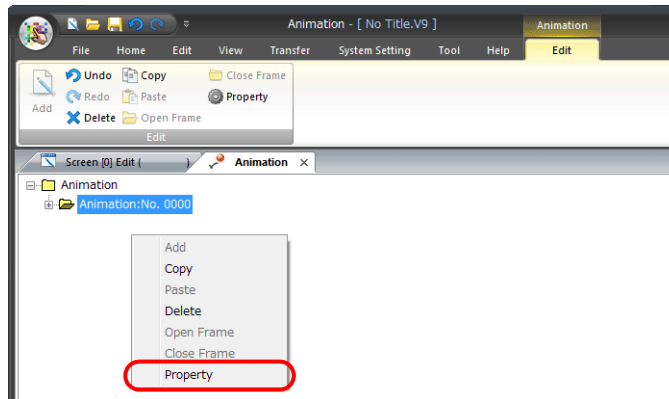

6. Double-clicking a folder shown as [Animation No. xxxx] displays [Frame No. xxxx] folders according to the configurations in step 2.

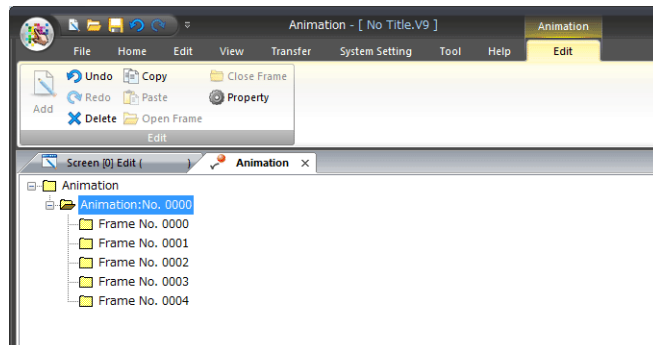

6.12.4 Frame Editing

In the [Animation] tab window, double-click the desired [Frame No. xxxx] under an [Animation No. xxxx] folder. The [Frame Edit] tab window is displayed.

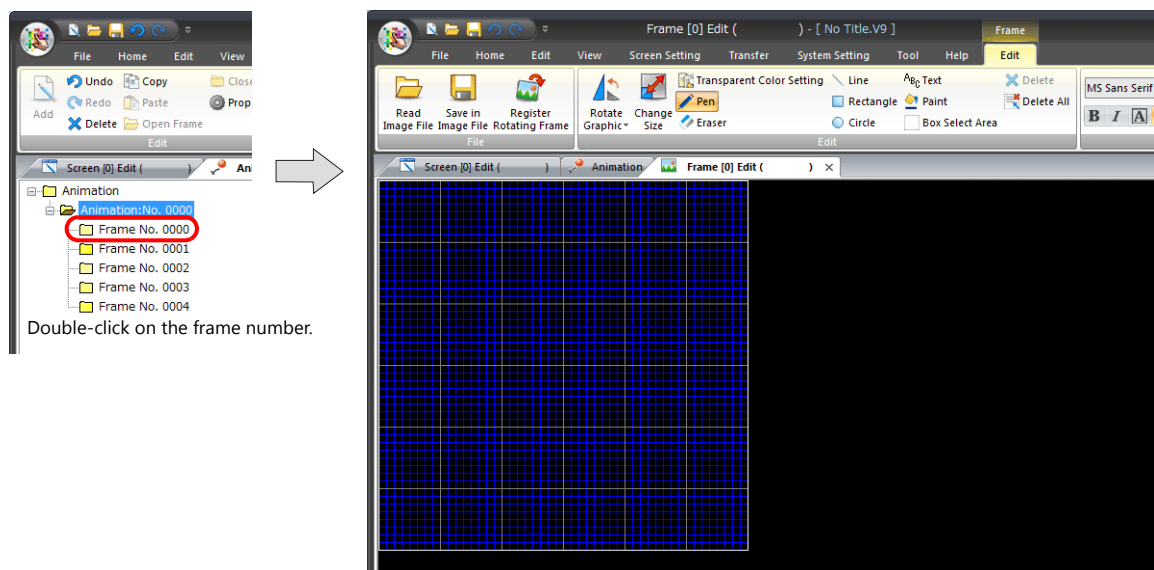

Frame Structure

- A maximum of 1,023 frames from No. 0 to No. 1,022 can be registered.
- The maximum capacity per frame is 1 MB.
In the case of capturing a bitmap or JPEG file larger than 1 MB, the file will be automatically divided into 1 MB sections so that the bitmap or JPEG can be captured. (Files with a resolution of up to 1,920 × 1,080 can be captured.)
- If changing the frame size, it can be changed up to the same resolution as the MONITOUCH model for which the screen program is being configured.

Frame Editing

Frames can be edited in the same manner as for patterns.



For more information on editing, refer to page 6-49 .

6.13 Pattern

Patterns are areas where bitmap or JPEG files are imported and graphics are drawn in dots and then registered.

6.13.1 Pattern Structure

- A maximum of 1,024 patterns can be registered.

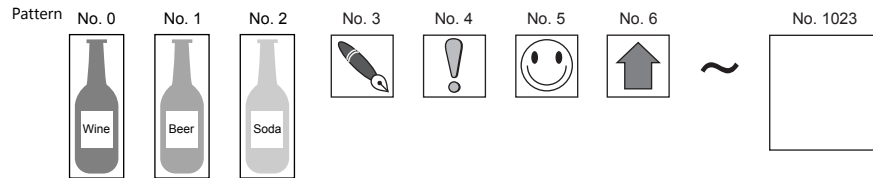

- The maximum capacity per pattern is 1 MB.
In the case of capturing a bitmap or JPEG file larger than 1 MB, the file will be automatically divided into 1 MB sections so that the bitmap or JPEG can be captured. (Files with a resolution of up to 1920 × 1080 can be captured.)
- If changing the pattern size, it can be changed up to the same resolution as the MONITOUCH model for which the screen program is being configured.

6.13.2 Calling a Pattern

Click [Home] → [Registration Item] → [Pattern].

The [Pattern] window is displayed. Specify the pattern number to open and click [OK].

(Alternatively, you can call one from the [Registration Item] menu in the project list view window.)

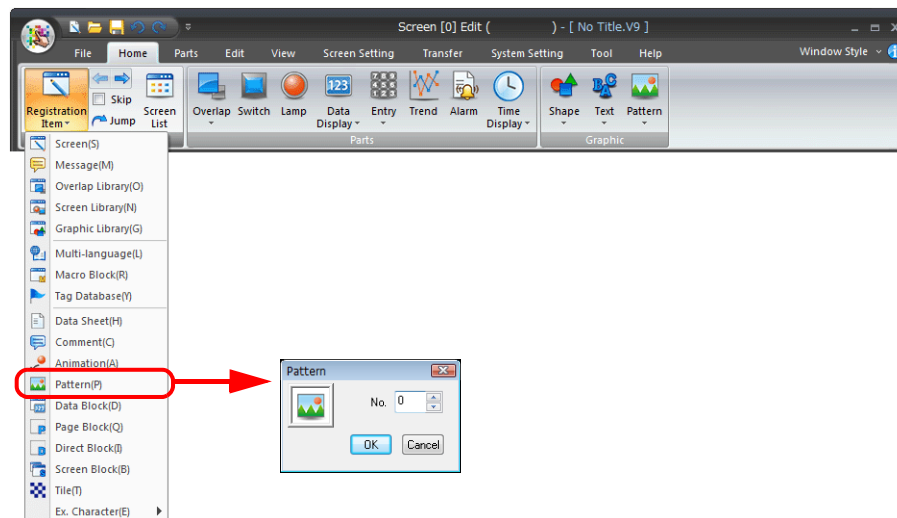

6.13.3 Pattern Editing

An [Edit] menu is added to the right end of the ribbon menu when the [Pattern Edit] tab window is displayed.

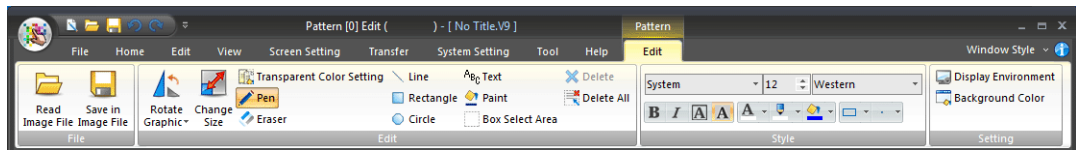

Pen

The [Pen] tool enables you to draw freehand.

1. On the [Style] menu, select the desired pen color with [Line Color/Frame Color], right-click color with [Paint Color/Back Color], and pen size with [Pen Size].

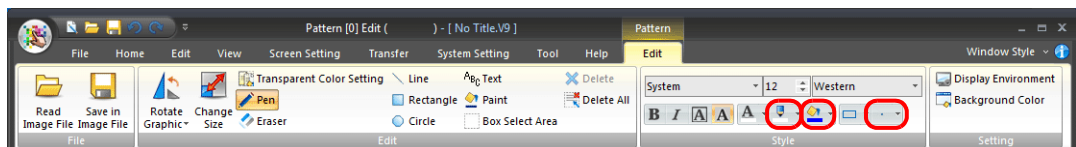

2. Click [Pen] and draw a graphic in the [Pattern Edit] tab window by clicking or dragging the mouse. The selected color and pen size apply to the graphic you are drawing.

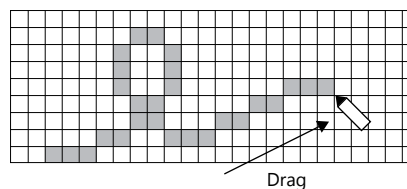

3. To draw in the color of [Paint Color/Back Color], right-click or right-drag the mouse.

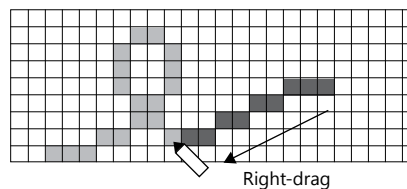

Eraser

The [Eraser] tool enables you to erase graphics freehand.

1. Select the desired size with [Pen Size].
2. In the [Pattern Edit] tab window, click or drag the mouse over the graphic. The eraser in the size of [Pen Size] erases the graphic.

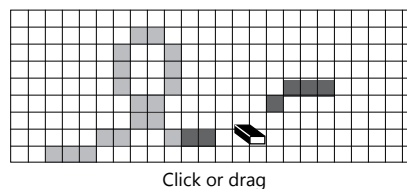

The operation of the eraser command is the same as drawing dots in black.

Line

The [Line] tool enables you to draw straight lines.

1. Select the desired line color with [Line Color/Frame Color], right-click color with [Paint Color/Back Color], and pen size with [Pen Size].
2. Click [Line] and draw lines in the [Pattern Edit] tab window by dragging the mouse.
The selected color and pen size apply to the line you are drawing.

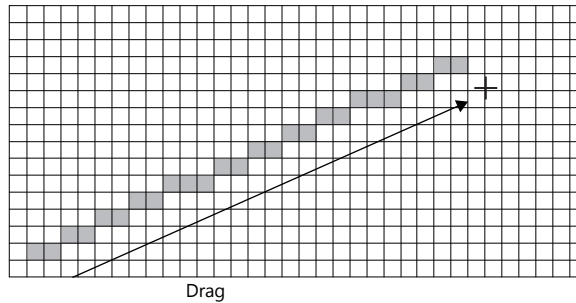

3. To draw in the color of [Paint Color/Back Color], right-drag the mouse.

Rectangle

The [Rectangle] tool enables you to draw boxes.

1. Make the necessary settings in advance for [Line Color/Frame], [Paint Color/Back Color], and [Frame Type].

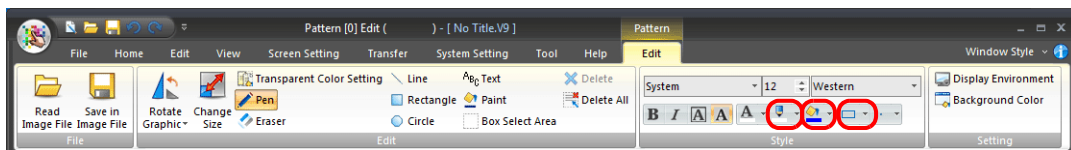

2. Click [Rectangle] and draw boxes in the [Pattern Edit] tab window by dragging the mouse.
The selected settings apply to the box you are drawing.

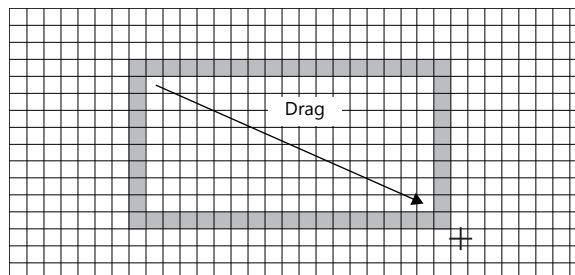

Circle

The [Circle] tool enables you to draw circles.

1. Make the necessary settings in advance for [Line Color/Frame], [Paint Color/Back Color], and [Frame Type].
2. Click [Circle] and draw circles in the [Pattern Edit] tab window by dragging the mouse.
The selected settings apply to the circle you are drawing.

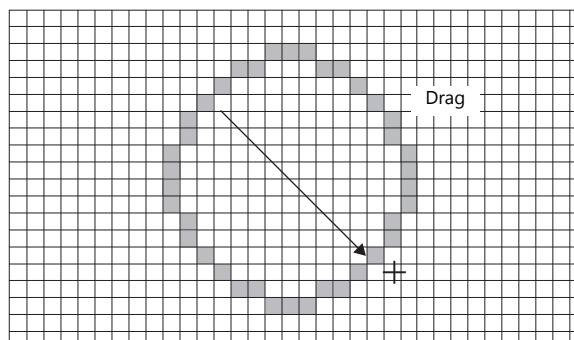

Text

A font available for use under Windows can be imported as a bitmap.
Follow the procedure described below.

1. Make the necessary font settings in advance on the [Style] menu.

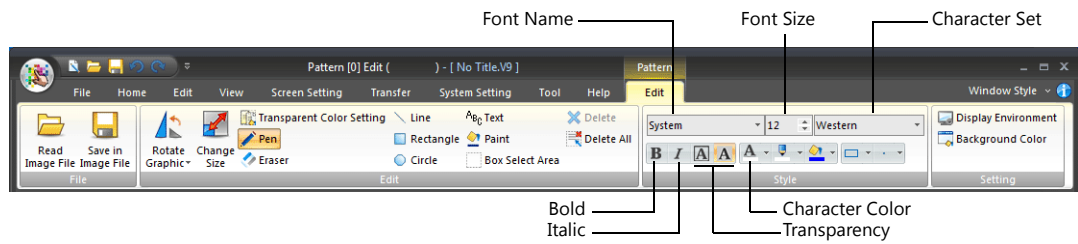

Configure the font settings as desired.

2. Click [Text].
The [Text] window is displayed.

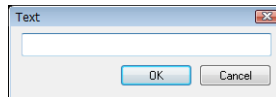
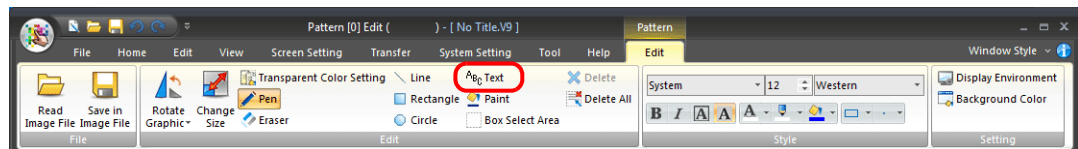

3. Enter text.

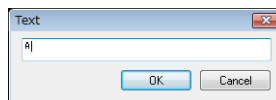

4. Click [OK] to display a box the size of the text in the [Pattern Edit] tab window.
Click to place the text.

A crosshair and box are displayed

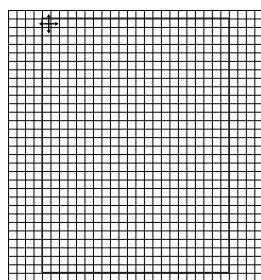

Clicking the mouse places the text.

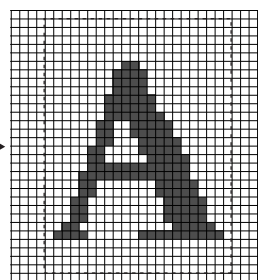

If the pattern size in the window is too small at the time of clicking the mouse in step 4, the following message appears.

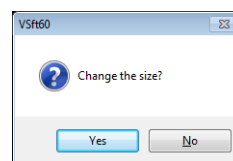

By clicking [Yes], the pattern is enlarged to a size that suits the text.
When [No] is clicked, the pattern size remains unchanged and the text is nevertheless placed in a partial state.



It is not possible to change placed text.
When correcting the text, delete it or cancel it using the [Undo] tool.

Paint

The [Paint] tool enables you to paint graphics.

1. Select the desired paint color with [Paint Color/Back Color].

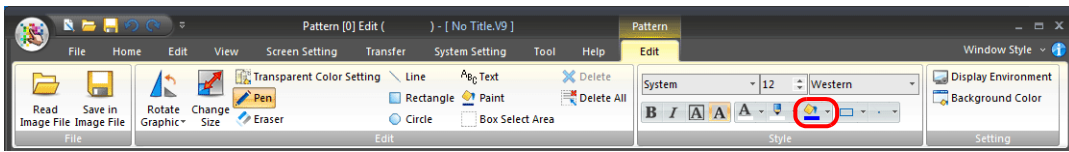

2. Click [Paint] and click the graphic in the [Pattern Edit] tab window.
The graphic (enclosed area) is painted in the color selected for [Paint Color/Back Color].

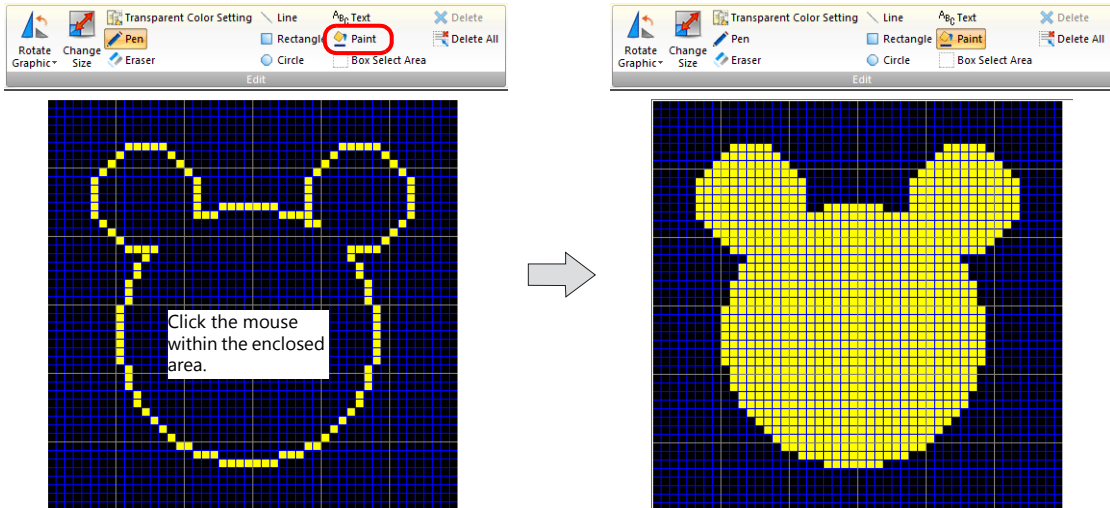

Box Select Area

This tool is used when specifying a pattern area. Dragging the mouse over a pattern encloses it. The enclosed area becomes a target for copy or deletion.

Using [Box Select Area]

1. Click [Box Select Area].

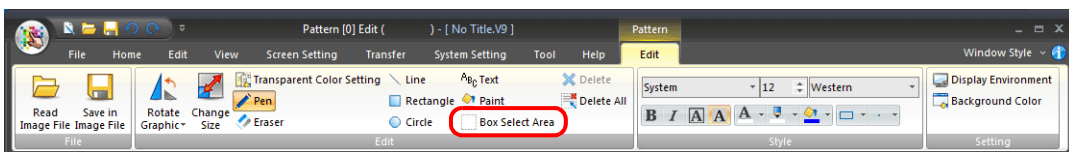

2. In the [Pattern Edit] tab window, drag the mouse from the start point to the end point to draw a box.

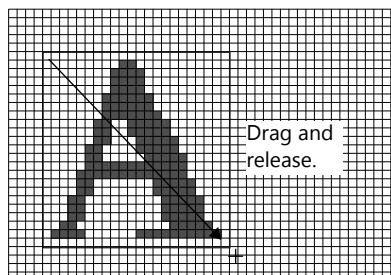

3. A box is displayed.
Execute the necessary function, such as copy or delete.
To move the box, drag it.

Drag the displayed box.

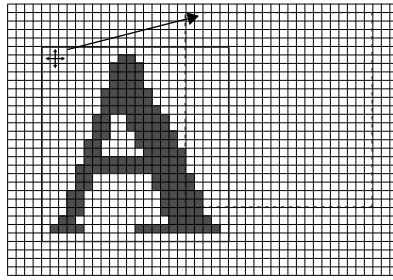

Release the mouse to finish the movement.

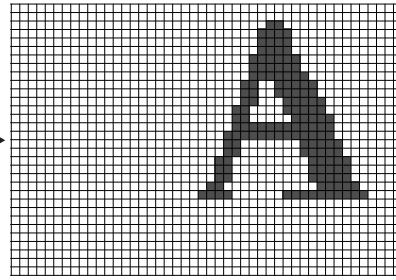

6.13.4 Transforming Patterns

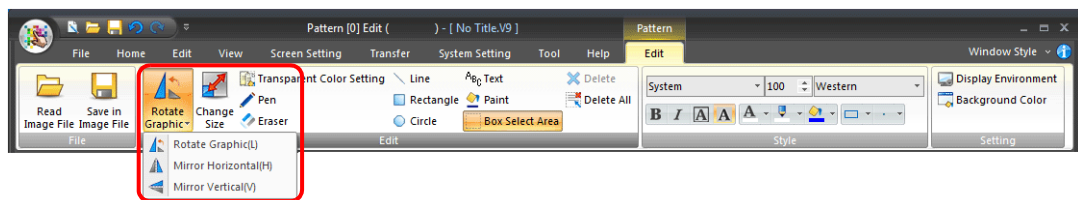

[Rotate Graphic] (rotate 90° to the left)

Rotate the registered pattern by 90° turns to the left.

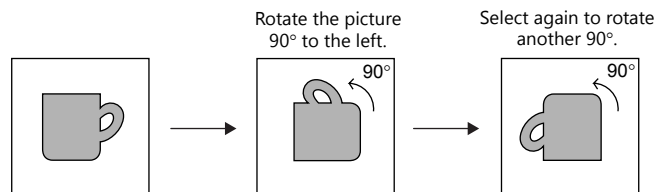

[Mirror Horizontal]

Click this command to flip the registered pattern horizontally.

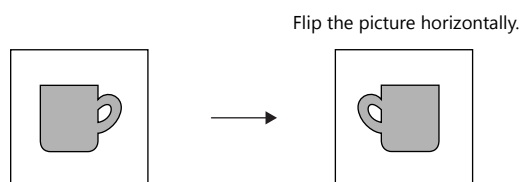

[Mirror Vertical]

Click this command to flip the registered pattern vertically.

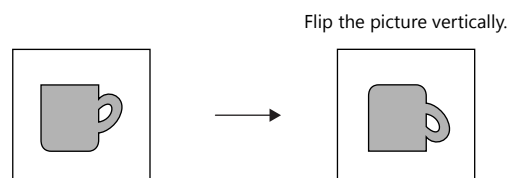

[Change Size]

This command is used to change the pattern size.
Click this command to display the following [Change Size] window.

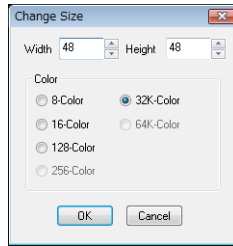

The available setting ranges are as follows:

Width (X)/Height (Y): Change up to the same resolution as the MONITOUCH model for which the screen program is being configured.

Color: 8-Color/16-Color/128-Color/32k-Color/64k-Color



Note that if a size change is made during pattern editing or when a pattern has been completed, the created pattern data is deleted.

[Transparent Color Setting]

When a pattern is animated in graphic relay mode, etc., the pattern is displayed in the XORed color. If the screen background is not colored black, the pattern may not be displayed in its actual color.

This setting is for displaying the pattern in its actual color without influencing the background. (Specify the color that you do not want to display as transparent when the pattern is placed on the screen.)

Only one color can be set as a transparent color for each pattern.

The transparent color setting applies throughout pattern placement on the screen regardless of whether animation is used.

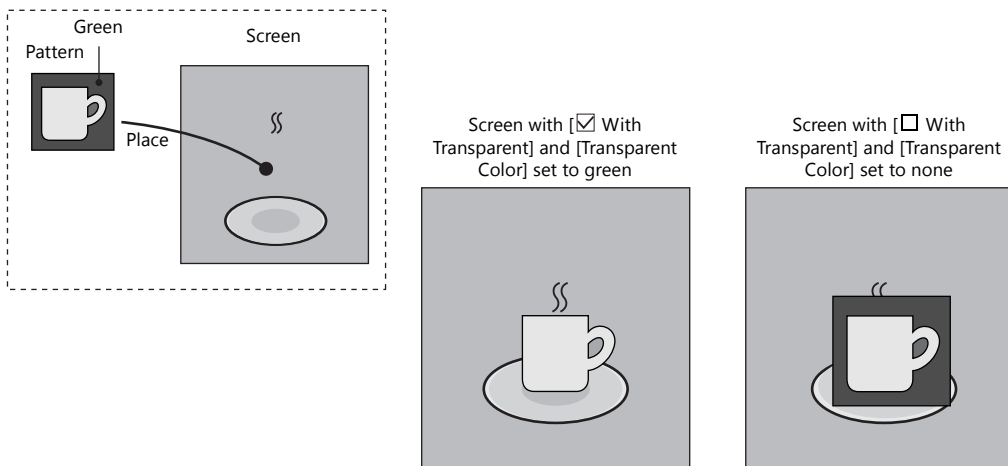

Click this command to display the [Transparent Color Setting] window.

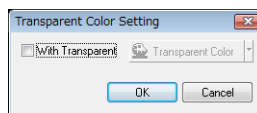

6.13.5 Image File Import and Saving

It is possible to import bitmap or JPEG files into pattern editing.
It is also possible to save patterns as bitmap or JPEG files.

Importing Image Files

1. An [Edit] menu is added to the right end of the ribbon menu when the [Pattern Edit] tab window is displayed.
2. Click [Read Image File]. The [Open Image File] window is displayed.
 - * **Files with a resolution of up to 1920 × 1080 can be imported.**

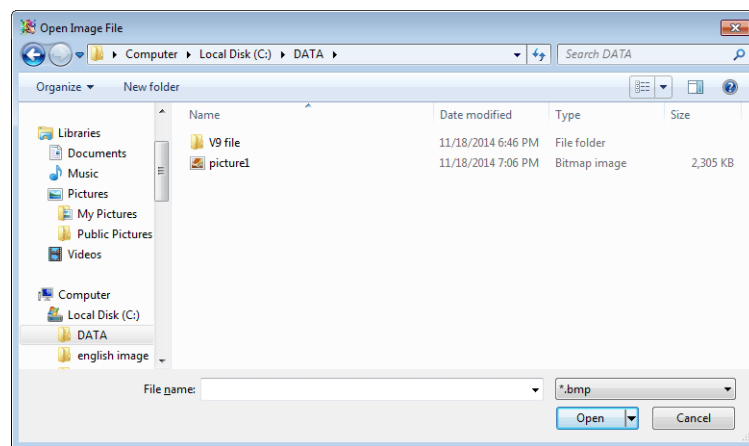
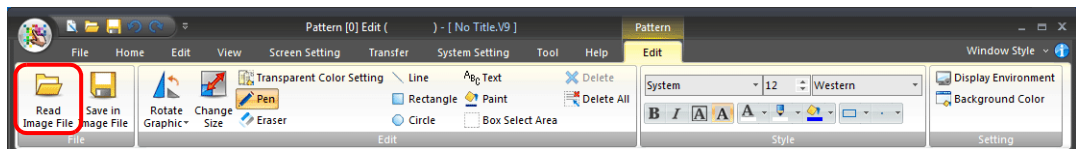

3. Select the desired file and click [Open].
The following window is displayed.

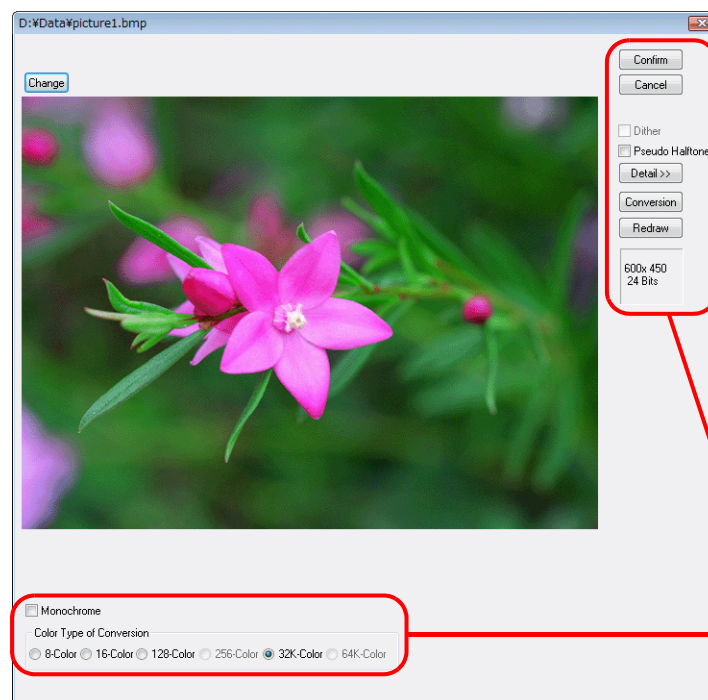

For more information on each setting item, refer to page 6-56.

Click [Confirm].

- The following confirmation dialog box is displayed.
Clicking [Yes] imports the bitmap file.

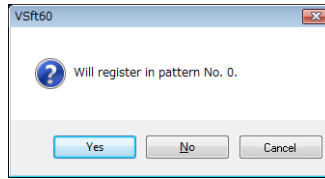

- Clicking [No] displays the [Bitmap Import Number Designation] window.
Enter the top pattern number to be imported and click [OK]. The bitmap data is imported.

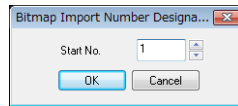

Window displayed during image import

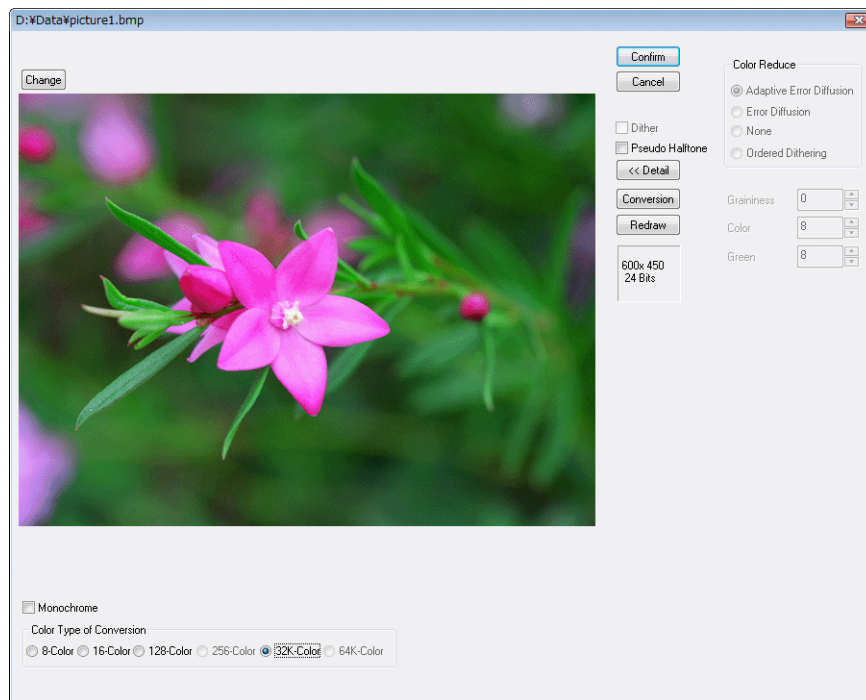

Item	Description		
Confirm	Import the displayed image as a pattern.		
Cancel	Cancel image importing.		
Dither	Select this checkbox to perform color correction to make the colors of the image closer to the original. The option is unavailable when [64K-Color] or [32K-Color] is selected for [Color Type of Conversion].		
Pseudo Halftone	Select this checkbox to enable the [Detail] settings.		
Detail	Click to display the following settings.		
	Item	Description	
	Color Reduce	Adaptive Error Diffusion	Perform error diffusion adapted to each individual part of the image. This function places more of an emphasis on image smoothness than the [Error Diffusion] setting below.
		Error Diffusion	If a color in the source image is not included in the color pallet, two bits in similar colors are placed alternately so as to reproduce the color.
		None	A pallet similar to the source image color is selected.
		Ordered Dithering	The error diffusion pattern is made closer to a regular pattern as opposed to a random pattern.
	Graininess	Specify a level of graininess. The smaller the entered value, the lower the graininess becomes.	
	Color	Assign priority to brightness or color depiction. When the specified number gets smaller, brightness takes priority over color.	
	Green	Assign priority to blue-green-based color or red-yellow-based color depiction. When the specified number gets smaller, green-based color takes priority.	

Item	Description
Conversion	Click (depress) to display a preview of the image when placed on the screen.
Redraw	If any settings, such as [Dither] or [Pseudo Halftone], are changed while the [Conversion] button is depressed, changes to the image can be previewed by clicking this button.
Monochrome	Select this checkbox to degrade image quality to 8-tone monochrome. This reduces the data size of the pattern.

Saving Image Files

The pattern currently open can be saved as a bitmap file (with an extension .bmp) or a JPEG file (with an extension .jpg).

1. An [Edit] menu is added to the right end of the ribbon menu when the [Pattern Edit] tab window is displayed.
2. Click [Save in Image File]. The [Select Image File to be Saved] window is displayed.

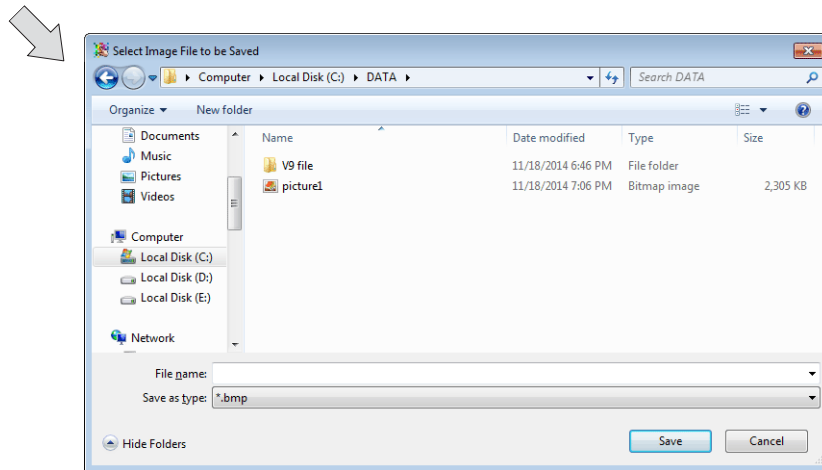
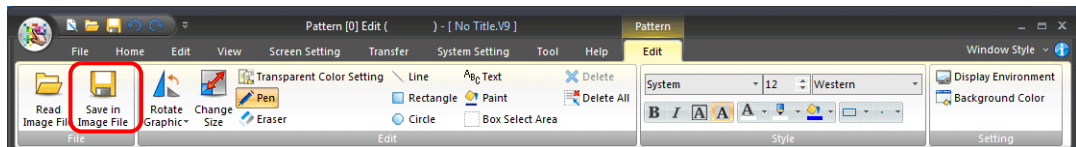

3. Enter the desired filename and click [Save].
The pattern is saved as a bitmap or JPEG file.

6.13.6 Pattern Environment Settings

Display Environment Settings

Click [Display Environment] to display the following window.

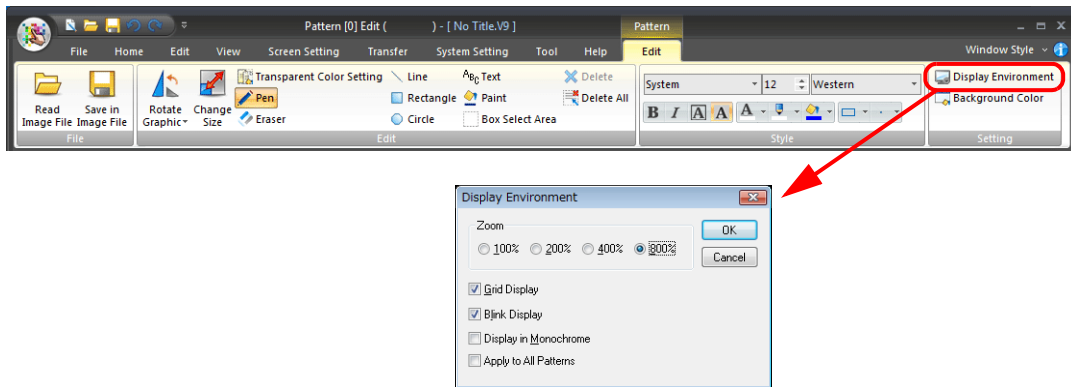

Zoom: (100%/200%/400%/800%)	Select a display magnification. The default is 800%.
Grid Display	Select whether or not to display a grid in the background.
Blink Display	It is possible to distinguish the color set to flash on the pattern. When this checkbox is unselected, the color set to flash is indistinguishable from the normal colors.
Apply to All Patterns	When this checkbox is selected, the display environment settings made in this window apply to all patterns.

Background Color Setting

When editing a pattern, it is possible to view the actual screen background color.

Click [Background Color] to display a window for setting the color. Select the desired color and click [OK]. The pattern edit window background color changes.

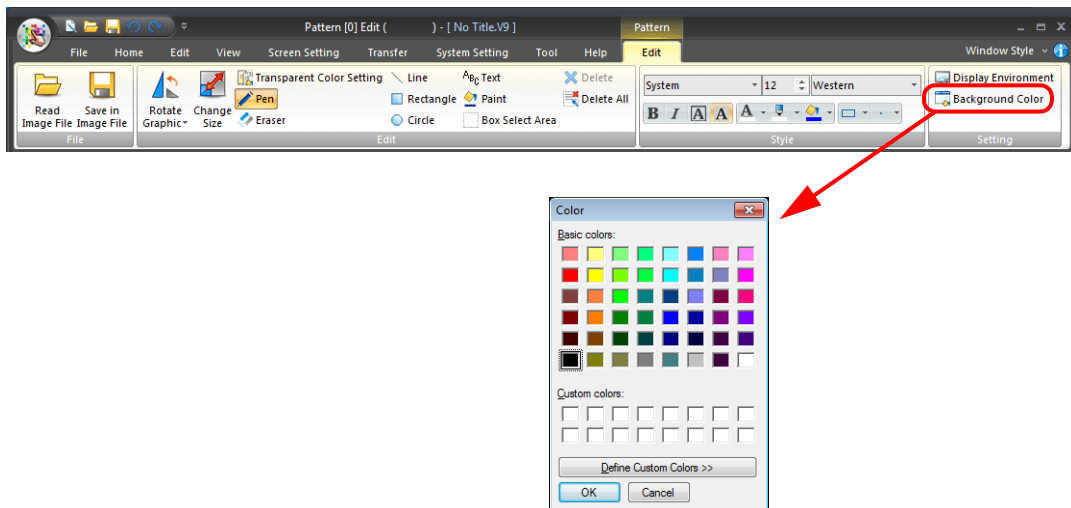

6.13.7 Placing a Pattern

Registered patterns can be placed on screens or in the graphic library.
Use [Pattern] on the ribbon menu to place a pattern.



For more information, refer to "3.6.3 Pattern" page 3-83.

After a pattern placement, the [Pattern No.] can be changed and [Rotate/Mirror] operations can be performed.
Click (or double-click) on a placed pattern, or select it with handles, right-click, and select [Detail Setting] to display the [Pattern] view window for configuring settings.

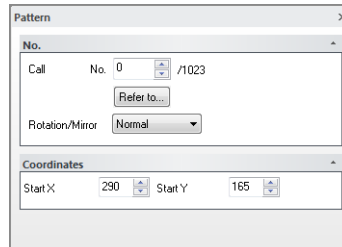

Once a pattern is placed, it cannot be reduced but can be enlarged. Pattern enlargement up to 8 times (integral multiple) is possible.

Pattern number setting on multi-language screens

For multi-language screen programs, pattern numbers can be selected individually for each [Display Language].
Selection can be made via the [Open] button when selecting a pattern.

6.14 Data Block

Data blocks (parts) are provided as areas where data displays such as numerical data or character display parts or drawing items are registered.

6.14.1 Data Block Structure

A maximum of 1,024 data blocks can be registered.

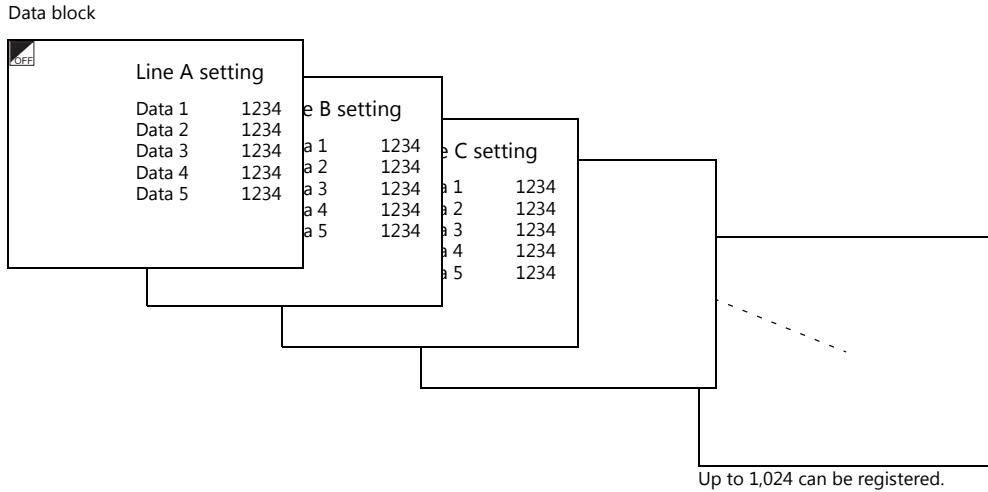

6.14.2 Calling a Data Block

Click [Home] → [Registration Item] → [Data Block].

The [Data Block] window is displayed. Specify the data block number to open and click [OK].

(Alternatively, you can call one from the [Registration Item] menu in the project list view window.)

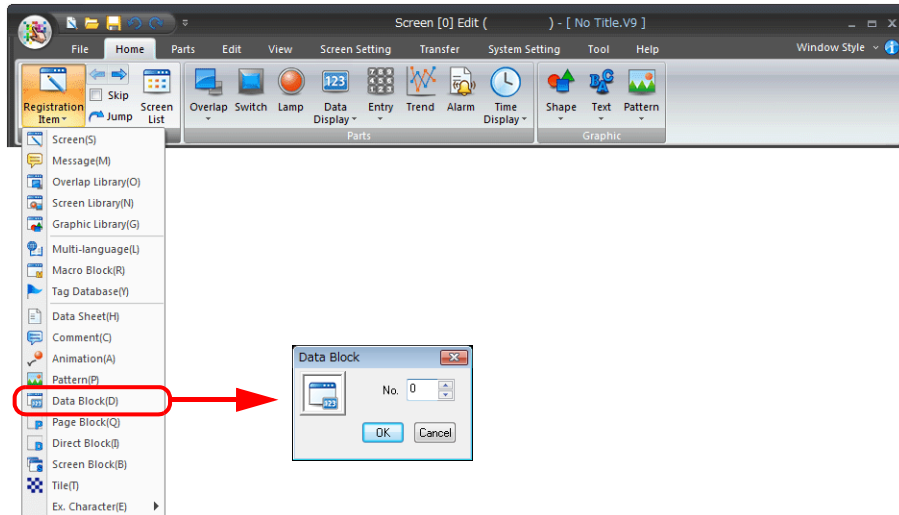

6.14.3 Data Block Editing

Placing Parts

Numerical data display, character display, table data display, and drawing parts can be placed in the same manner that they are placed on the screen.

Placement procedure

An [Edit] menu is added to the right end of the ribbon menu when the [Data Block Edit] tab window is displayed. Select a part and place it.

Offset Position Setting

Every data block has a reference position called an offset.

A registered data block is always placed on the screen with respect to the offset position.

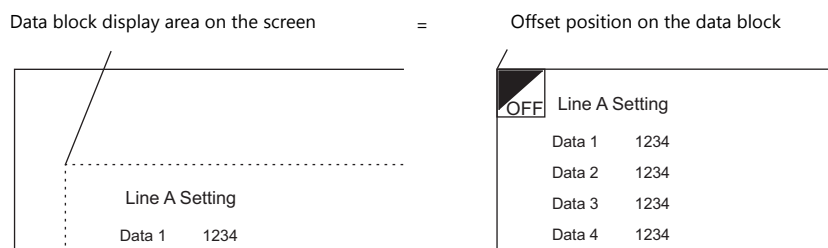

An offset position on the data block is shown with an "OFF" mark.

Changing an offset position

Every data block has an offset position at coordinates X, Y (0, 0) as default. To change the position, follow the procedure below.

1. An [Edit] menu is added to the right end of the ribbon menu when the [Data Block Edit] tab window is displayed. Click [Offset Position Setting].

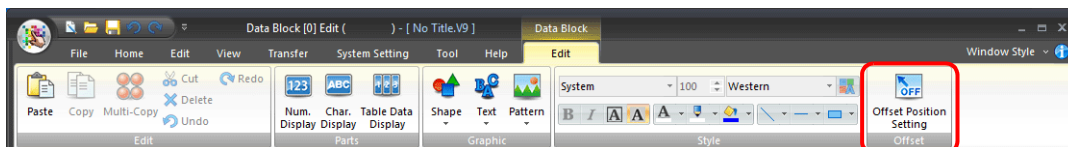

2. A crosshair marked with "OFF" appears.



3. Click the left mouse button at an arbitrary position on the screen. The [OFF] offset mark is displayed at that location.

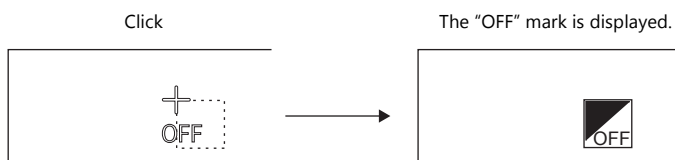

Changes made to the offset position prior to registering a data block are invalid. Set an offset position after registering a data block.

Data Block Environment Settings

Environment settings for data blocks are also performed via [View] → [Display Environment]. Therefore, this section explains the display environment settings that are different from those in screen editing.

[Base Screen Dsp.] ([Others] tab)

While editing a data block, a screen or overlap library can be placed behind the data block to check how the screen will actually look when displayed.

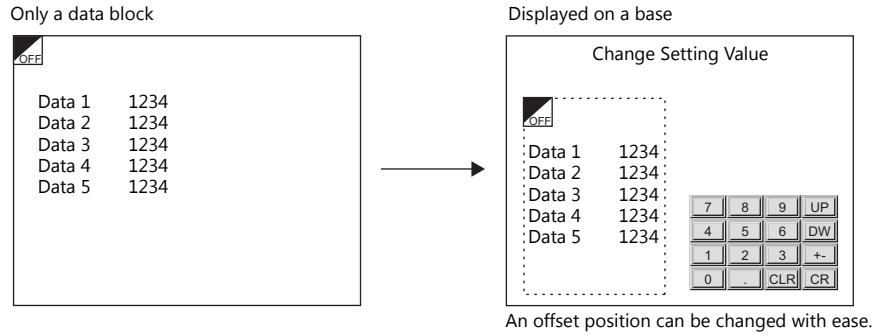

Click [View] → [Display Environment].

The [Display Environment] window is displayed. Display the [Others] tab.

Select the [Base Screen Dsp.] checkbox to enable [Screen] and [Overlap Library]. Select either one and specify the desired number.

Click [OK] to display the selected screen as the background.

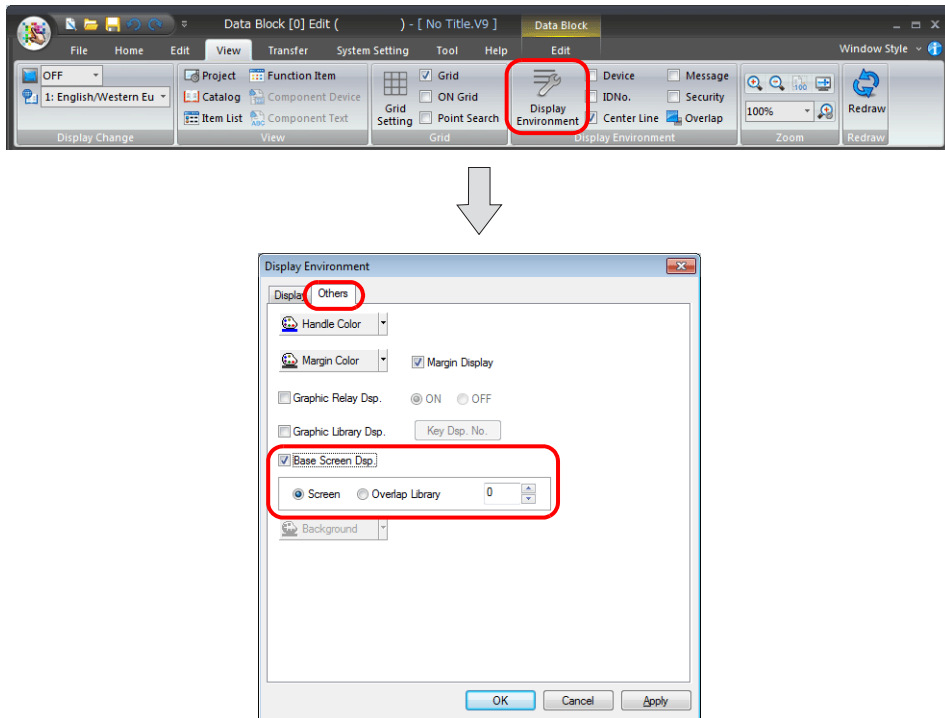

[Background] ([Others] tab)

It is possible to change the background color of a data block.

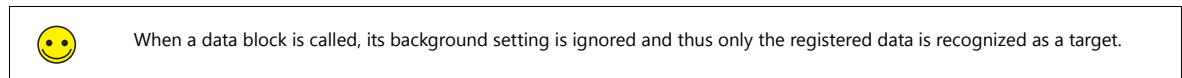

Click [View] → [Display Environment].

The [Display Environment] window is displayed. Display the [Others] tab.

Select the desired background color and click [OK].

The screen library is shown on the background colored as specified.

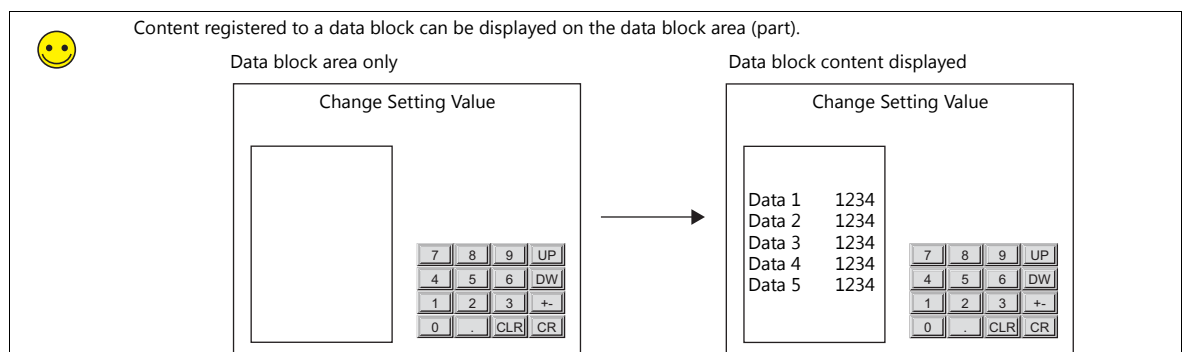
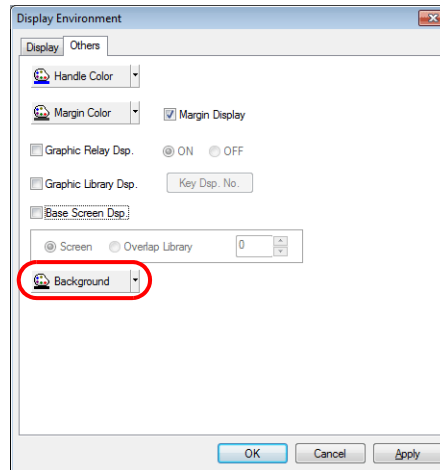

Click [View] → [Display Environment].

The [Display Environment] window is displayed. Display the [Display] tab.

Select the [Display Data Block] checkbox and click [OK] to display the content registered to a data block on the data block area (part).

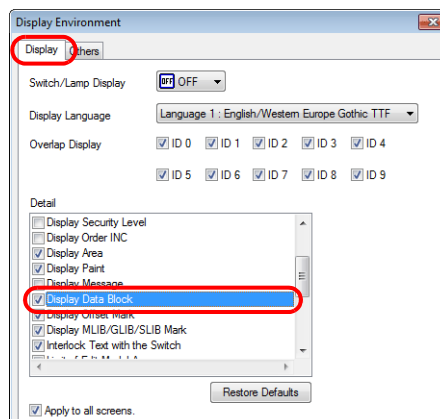
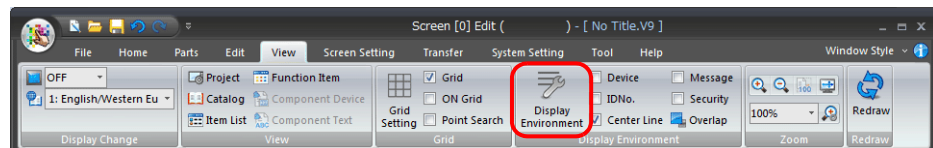

6.15 Page Block

Registered messages can be divided into groups and registered in page blocks.
This is used in the message (part) function.

6.15.1 Page Block Structure

A maximum of 1,024 page blocks can be registered.
One page block can contain 256 lines.

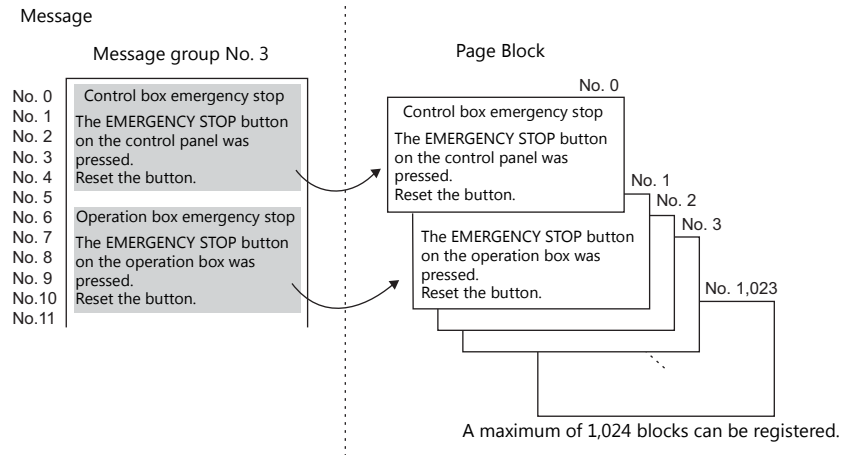

6.15.2 Calling a Page Block

Click [Home] → [Registration Item] → [Page Block].

The [Page Block] window is displayed. Specify the page block number to open and click [OK].

(Alternatively, you can call one from the [Registration Item] menu in the project list view window.)

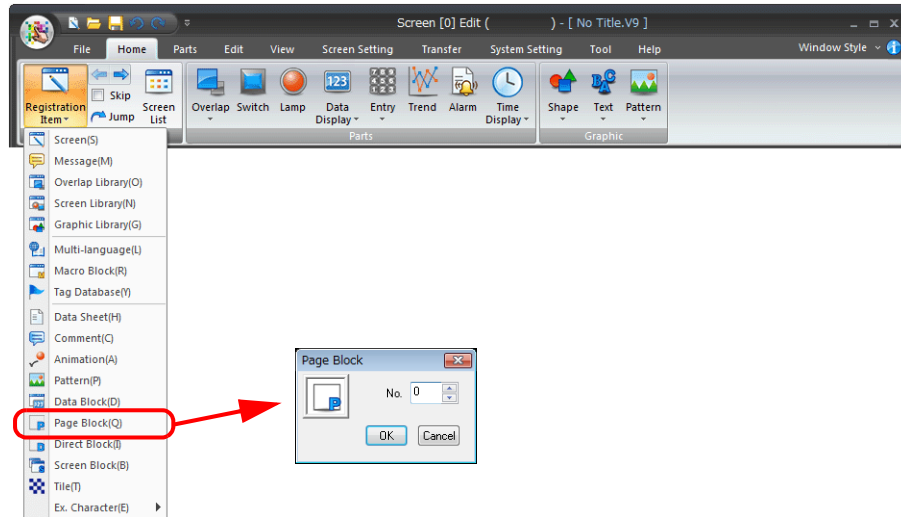

6.15.3 Page Block Editing

In the [Page Block Edit] window, editing is performed on a block basis.
Follow the procedure below.

1. Check the current value of [Block No.].
Also check the value of [Message GNo.] to be used.

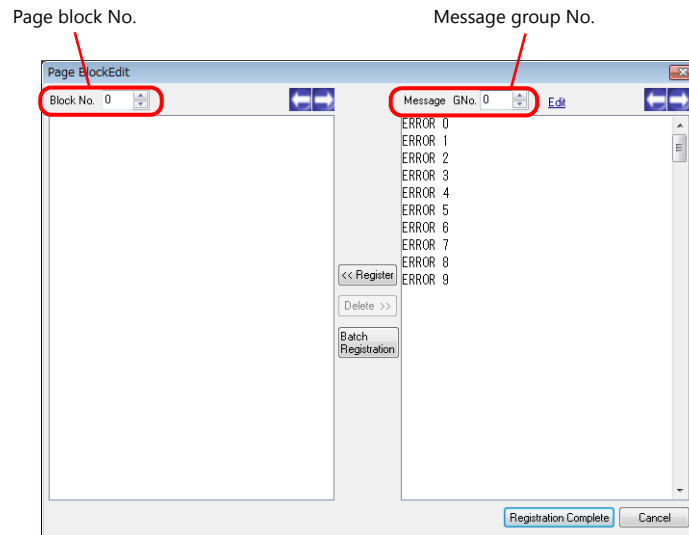

2. In the right-side area under [Message GNo.], select the lines to be used for a page block by clicking the first line and then the last line while holding down the [Shift] key.

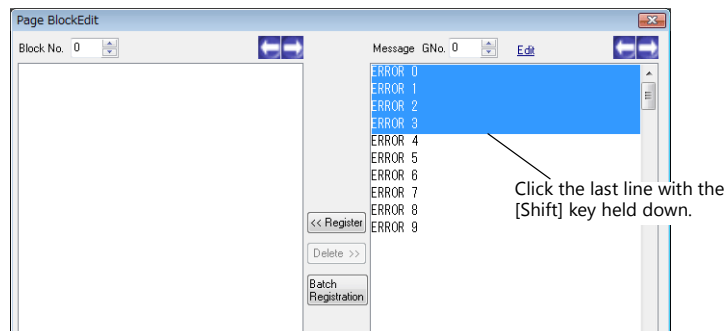

3. Click the [Register] button.
In the left-side area under [Block No.], the selected messages are registered.

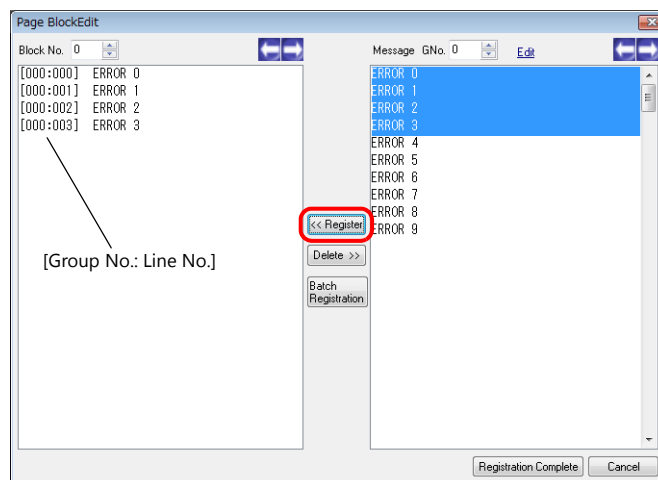

4. To proceed to block No. 1 and subsequent registrations, increment the block number by one using the [→] button provided on the right of [Block No.]. Then follow the above steps.
5. When registration is complete, click the [Registration Complete] button.
(To cancel the registration, click the [Cancel] button.)
This completes the page block editing procedure.

6.16 Direct Block

Lines selected as desired from the previously registered messages in different groups can be re-registered in direct blocks. Unlike page blocks, messages can be selected as desired line by line and registered in an arbitrary order. Direct blocks are used in alarm sub display mode (parts) or message mode (parts).

6.16.1 Direct Block Structure

A maximum of 1,024 direct blocks can be registered. One direct block can contain 256 lines.

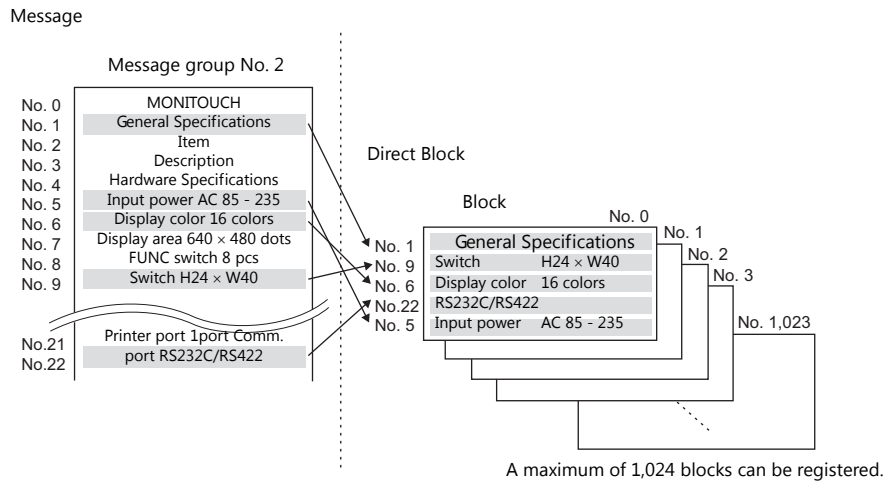

6.16.2 Calling a Direct Block

Click [Home] → [Registration Item] → [Direct Block]. The [Direct Block] window is displayed. Specify the direct block number to open and click [OK].

(Alternatively, you can call one from the [Registration Item] menu in the project list view window.)

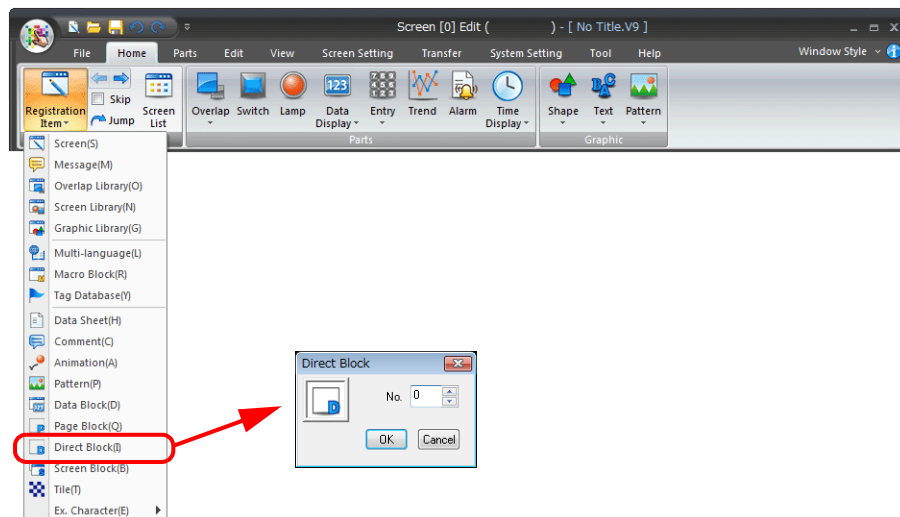

6.16.3 Direct Block Editing

In the [Direct Block Edit] window, editing is performed on a block basis.
Follow the procedure below.

1. Check the current value of [Block No.].
Also check the value of [Message GNo.] to be used.

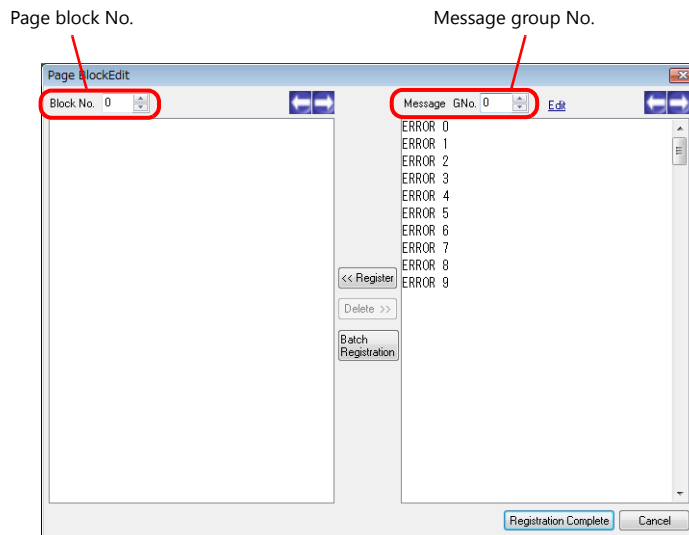

2. In the right area under [Message GNo.], click the line to be used for a direct block and then click the [Register] button.

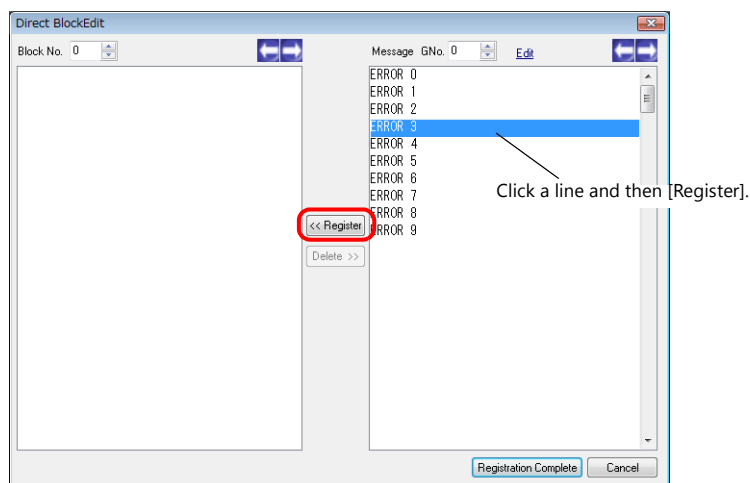

3. In the left-side area under [Block No.], the selected messages are registered.

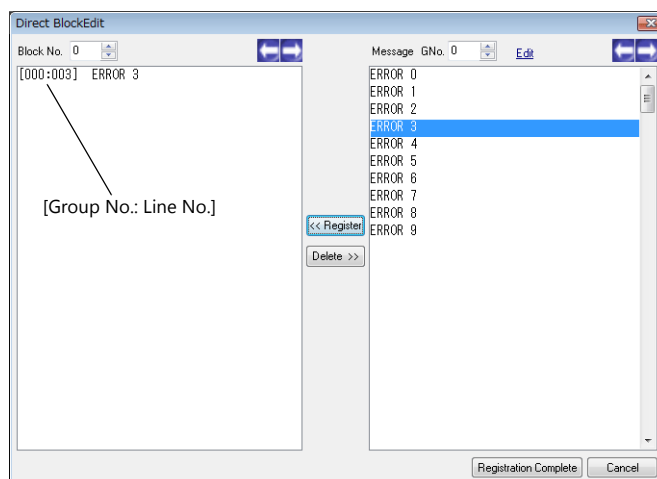

4. To proceed with the next message registration, click the message and then the [Register] button.

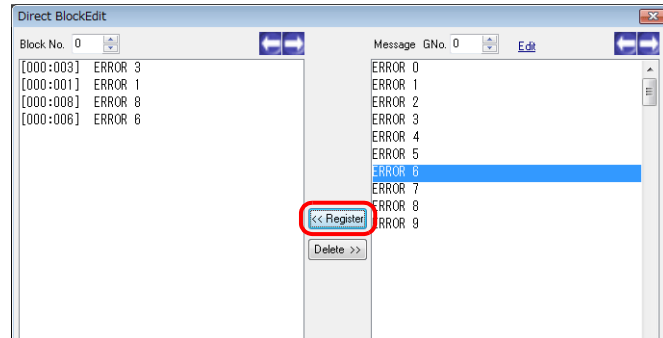

 To select messages at the same time, hold down the [Ctrl] key and click the desired messages.

5. To proceed to block No. 1 and subsequent registrations, increment the block number by one using the [->] button provided on the right of [Block No.]. Then follow the above steps.
6. When registration is complete, click the [Registration Complete] button. (To cancel the registration, click the [Cancel] button.)
This completes the direct block editing procedure.

6.17 Tile

For painting a graphic, a paint pattern can be selected from eight default types plus up to eight extra user-registered patterns.

6.17.1 Tile Structure

A maximum of 8 tiles can be registered.

The size of one tile is 8×8 dots.

White dots specified on a tile are regarded as areas in the foreground color and black dots are regarded as areas in the background color.

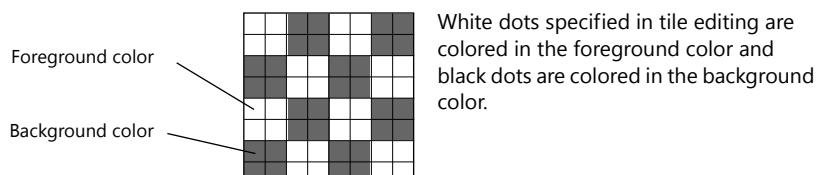

6.17.2 Calling a Tile

Click [Home] → [Registration Item] → [Tile].

The [Tile Edit] tab window is displayed.

(Alternatively, you can call one from the [Registration Item] menu in the project list view window.)

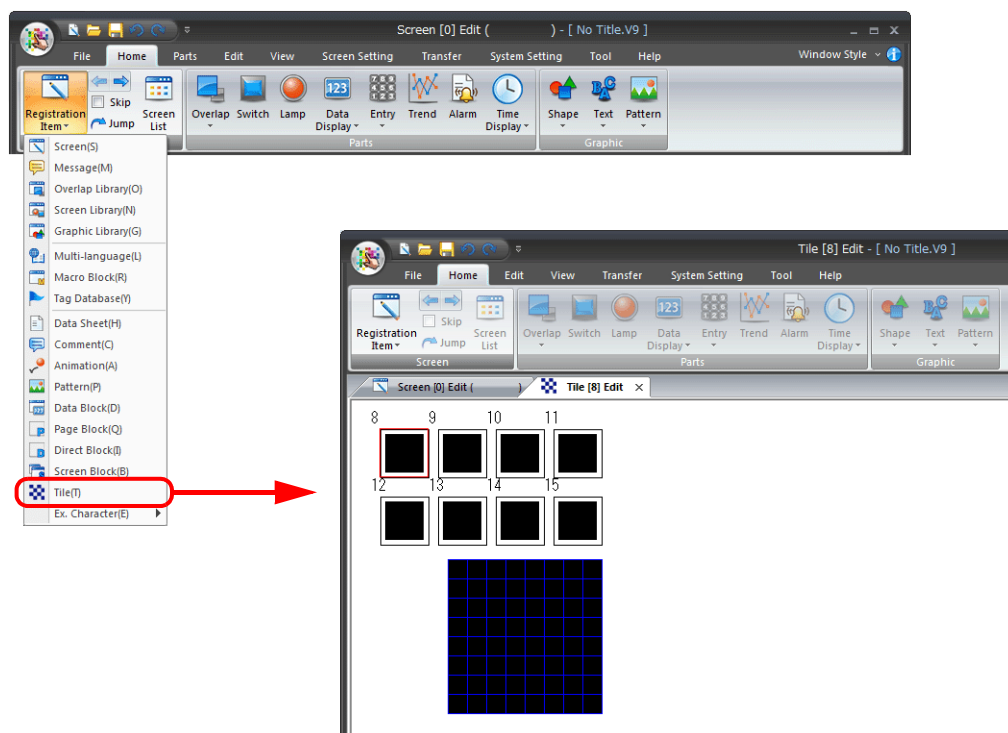

6.17.3 Tile Editing

1. Select a tile number to register by clicking.

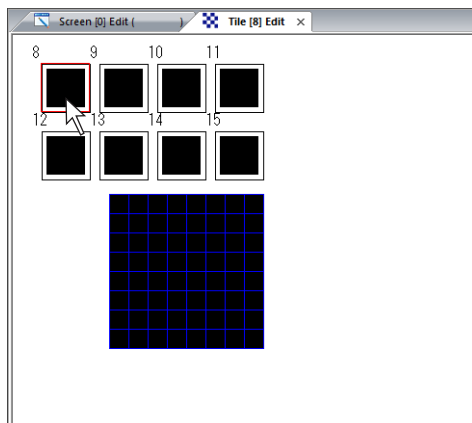

2. Create a tile in the tile editing area.
Draw white dots by clicking or dragging. Draw black dots by right-clicking or right-dragging.

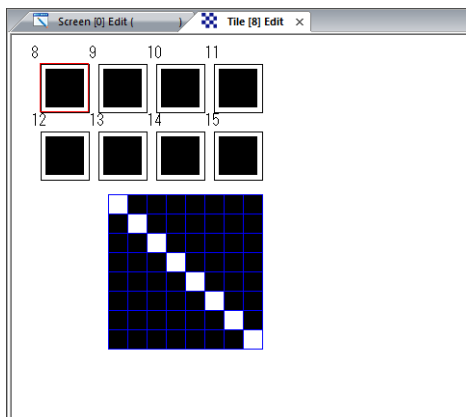

3. When tile editing is complete, click the next tile number.
The previous tile number shows the registered image.

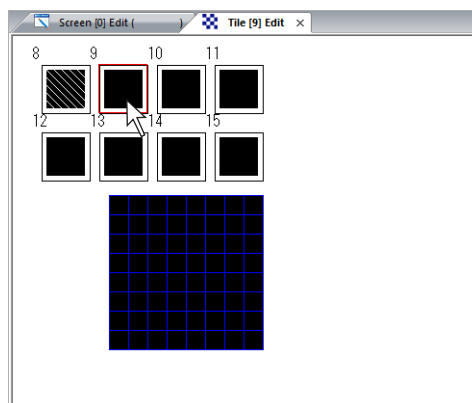

4. Perform the same procedure for the remaining tile numbers.

7 Transfer

7.1 Overview

7.2 Preparation for Transfer

7.3 USB Transfer

7.4 Ethernet Transfer

7.5 V-CP Transfer

7.6 Transfer via Storage

7.7 Selective Transfer

7.8 Message/Comment Transfer

7.1 Overview

This chapter explains how to transfer screen programs to the V9 series unit and export screen programs from the V9 series unit.

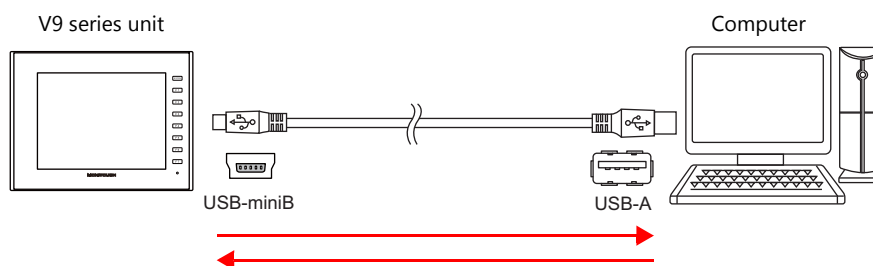

7.1.1 Transfer Methods

Data can be transferred between a V9 series unit and the computer installed with the editor via a storage device or while these two are connected with a communication cable.

Using a Communication Cable

USB (USB mini-B port)

Connect the USB-B port on the V9 series unit and the USB-A port on the computer using a USB cable.

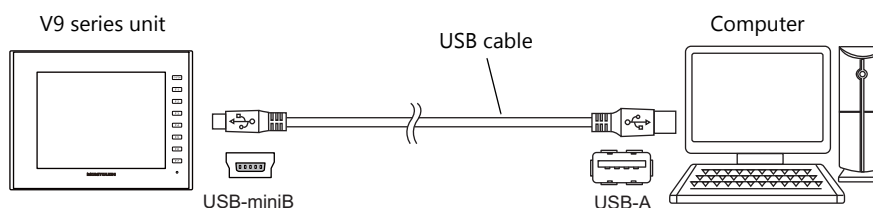

For more information on the transfer procedure, refer to page 7-7.

Ethernet (LAN port)

Connect the V9 series LAN port and computer via Ethernet.
Use a LAN cable.

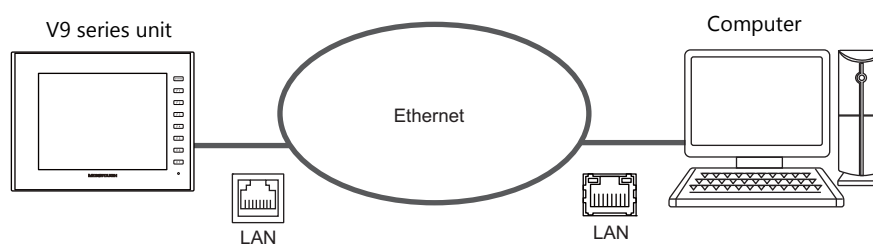

For more information on the transfer procedure, refer to page 7-14.

V-CP (serial port)

Connect MJ1 (modular jack for transfer) on the V9 series unit to the computer using Hakko Electronics' "V-CP" data transfer cable.

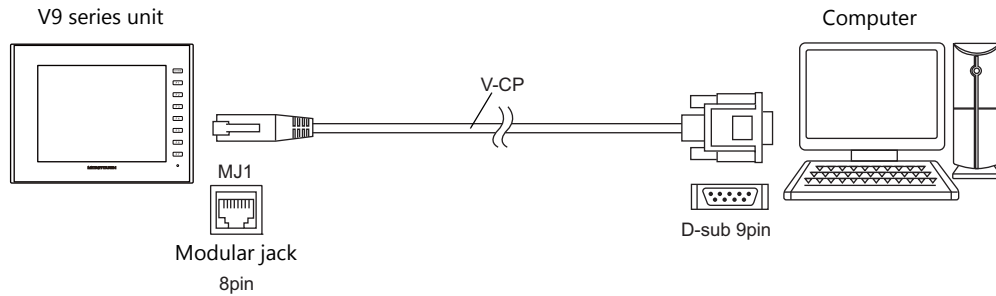

When a USB port is provided on the computer instead of a D-sub 9-pin serial interface, use a commercially-available USB → D-sub 9-pin serial converter.

For more information on the transfer procedure, refer to page 7-25.

Using a Storage Device

SD card

Use the storage manager in V-SFT version 6 to copy data from the computer to a commercially available SD card, and then insert the SD card into the V9 series unit to transfer the data.

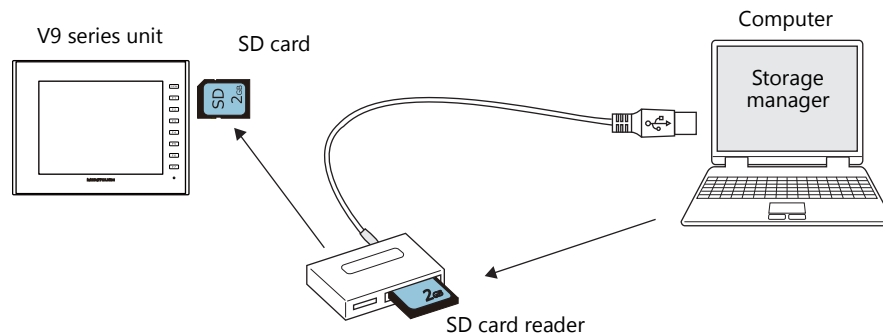

An appropriate environment to read from or write to the SD card is required on the computer.
For more information on the transfer procedure, refer to page 7-29.

USB flash drive

Use the storage manager in V-SFT version 6 to copy data from the computer to a commercially available USB flash drive, and then insert the USB flash drive into the V9 series unit to transfer the data.

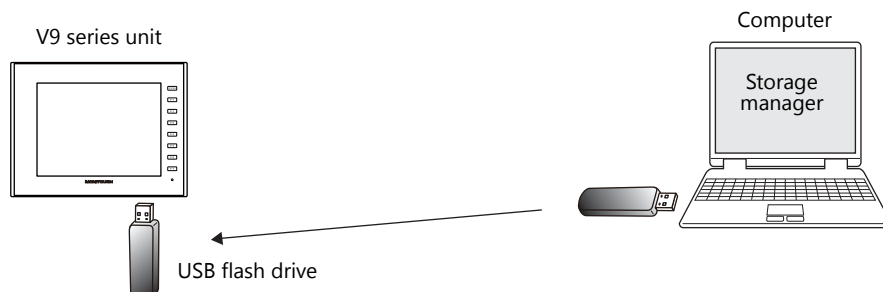

The computer environment must be capable of reading from or writing to a USB flash drive.
For more information on the transfer procedure, refer to page 7-29.

7.1.2 Types of Data to Transfer

There are many kinds of data which can be transferred to V9 series units.

Normally, users will only need to select [Screen Data].

When [Screen Data] is selected and data transfer is started, any other necessary data is automatically transferred together with the screen program.

Transfer Data List

Transfer Data	File to Transfer	Description
Screen Data	xxx.V9	The screen program file.
I/F Driver	xxx.TPD	This is the communication driver. The driver file type varies with the devices connected.
Display System Program	V9Series.prg	System program file for the V9 series unit. This file is common to all V9 series units. This file is transferred when updating the entire MONITOUCH system or the program on the unit.
Font Data		Source file of fonts used for display on the unit. This file is automatically transferred when a screen program with a different font setting is transferred to the V9 series unit. The fonts used in Local mode are also updated by transferring this data.
SRAM Data	xxx.RAM	This data is used when using the internal SRAM. This file is transferred to make a backup copy of the SRAM data.
Station No. Table	xxx.dtmB	This file is used when the station number table is used for Ethernet or a specific PLC. This file is transferred to update the station number table.
Basic/Japanese Dictionary	JPN.fcpB	This is a program file used for the Japanese FEP function.
Simulator Program	UniPLC_U.tpd UniPLC_E.tpd UniPLC_S.tpd	This is a program file used for the simulator. Three kinds are provided for the serial, USB, and Ethernet ports. When the [Use Simulator] checkbox is selected in the [Transfer] window, this file will be sent at the time of screen program transfer.
IniFile	xxx.BIN	This data stores settings configured in Local mode on the V9 series unit.



Keep the power on during system program transfer. Failure to do so may cause irrecoverable damage to the unit.



To update the entire system, it is recommended to use [Up-date of System].
In this case, however, executing [Up-date of System] re-transfers the whole system file so you may have to transfer the screen program again.
As a basic procedure, transfer the screen program after executing [Up-date of System].
Note that [Up-date of System] does not update the operating system. For more information on the procedure for updating the operating system, refer to "18 Storage" in V9 Series Reference Manual 2.

7.2 Preparation for Transfer

7.2.1 Preparation for MONITOUCH

The screen status before starting transfer varies between a new MONITOUCH and an existing one.

New MONITOUCH

When a new MONITOUCH is started for the first time, the following screen appears.

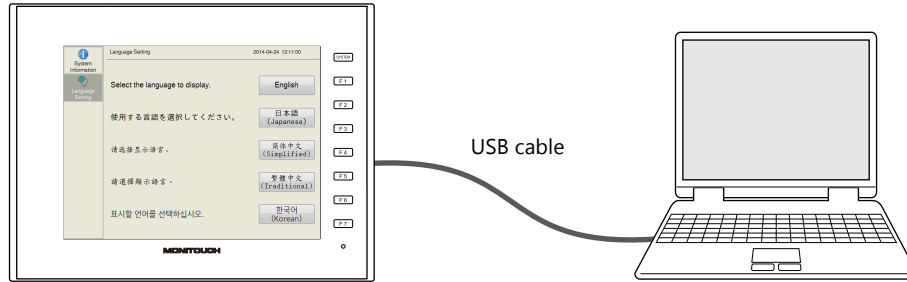

When transferring via USB or V-CP:

The data can be transferred from the screen shown above.

When transferring via Ethernet or a storage device:

Press the language switch on the screen to switch to the "Welcome!" screen.



Press [Transfer via Ethernet] or [Transfer Using Storage] to switch the screen.

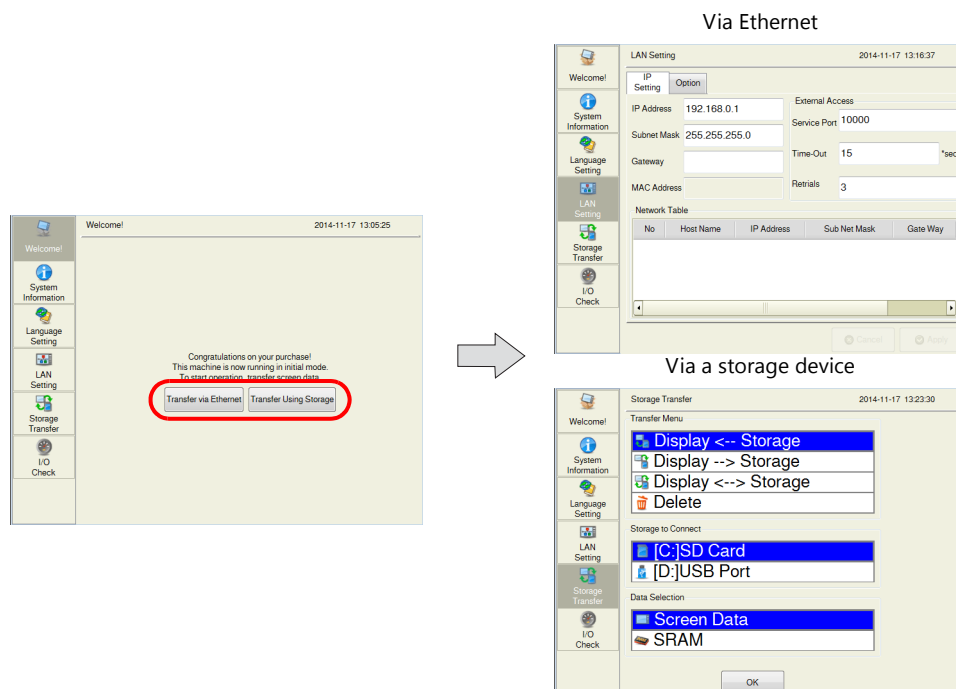

Existing MONITOUCH

When an existing MONITOUCH is started, it enters RUN mode.

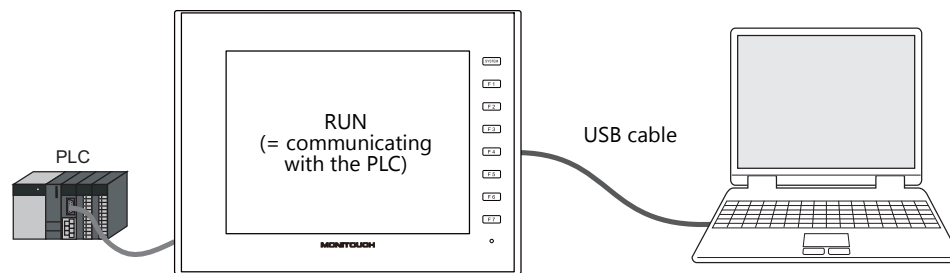

Depending on the situation, data transfer may be possible in RUN mode or may require entering Local mode.

Switching to Local mode

 - V9 Advanced
Press any of the four corners of the screen for more than two seconds and then press any of the remaining corners for more than two seconds to display the system menu. Tap the [Local] switch to enter Local mode.

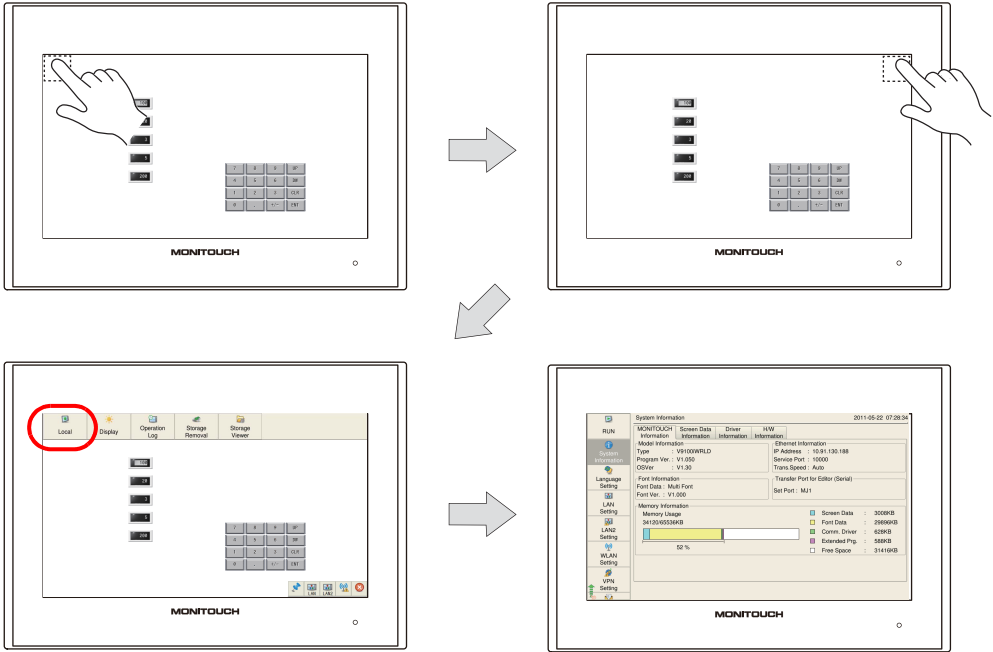

- * If the [Local] switch on the system menu is unresponsive, a mode change delay time may be set. In this case, hold down the [Local] switch.
- * For details, refer to the V9 Series Troubleshooting/Maintenance Manual.

- V9 Standard/Lite
Press the [SYSTEM] function switch to display the system menu. Tap the [Local] switch to enter Local mode.

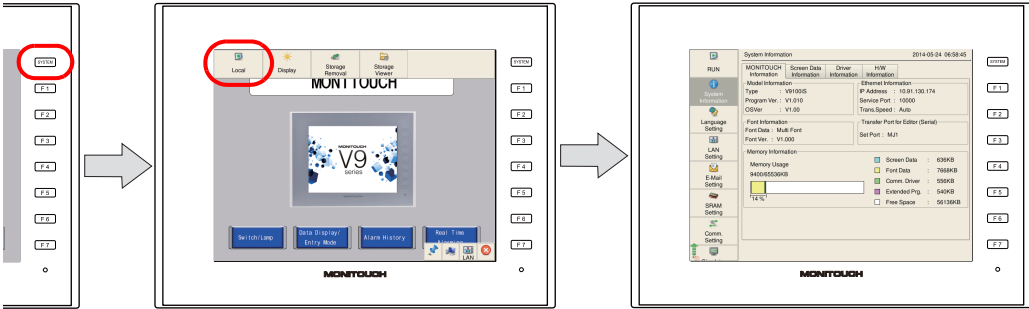

- * If nothing happens even after pressing the [SYSTEM] switch, a prohibition may be set on the use of system switches. Hold down the [SYSTEM] switch and [F7] switch at the same time.
- * If a [Local] switch does not appear on the system menu displayed by pressing the [SYSTEM] switch, hold down the [F1] switch and [F7] switch at the same time with the system menu displayed.

For details, refer to the V9 Series Troubleshooting/Maintenance Manual.

Via USB

The screen programs can be transferred in RUN mode as well as in Local mode.

Via Ethernet

When the IP address or subnet mask is correctly set for Ethernet transfer, the screen program can be transferred in RUN mode as well as Local mode.

However, it is necessary to display the Ethernet screen in Local mode to check or change the current setting.



For more information on the procedure for switching to Local mode, refer to page 7-5.

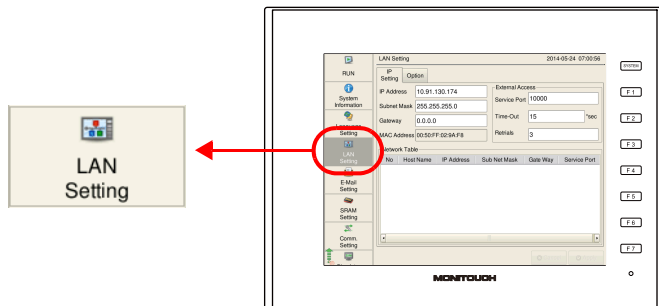

Via V-CP

When [No connection] is specified for [MJ1] (modular jack 1) in the Project View associated with the screen program already transferred to the V9 series unit, program transfer is allowed even while the unit is in RUN mode. However, if a setting other than [No connection] is set for [MJ1], you must enter Local mode before starting the transfer.



For more information on the procedure for switching to Local mode, refer to page 7-5.

Via a storage device

To transfer a screen program using a storage device, enter Local mode and display the [Storage Transfer] screen.



For more information on the procedure for switching to Local mode, refer to page 7-5.

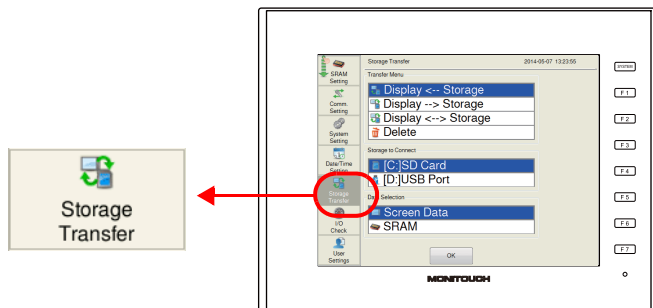

*** In the case of automatic uploading using a storage device, it is not necessary to enter Local mode. For more information on automatic uploading, refer to "18 Storage" in V9 Series Reference Manual 2.**

Preparation of Peripheral Equipment

Depending on the transfer method, it is necessary to prepare peripheral equipment (LAN cable, SD card, etc.) in addition to MONITOUCH and accessories included with MONITOUCH. Prepare any equipment that is not specifically prescribed by Hakko Electronics from commercially available items.

7.3 USB Transfer

7.3.1 Installing the USB Driver

A USB driver must be installed on the computer in advance in order to perform transfer using a USB cable. Install the driver according to the following procedure.

For Windows Vista/7/8/8.1

1. Connect the USB-mini-B port of the V9 series unit (with power on) to the USB-A port of the computer using a USB cable.

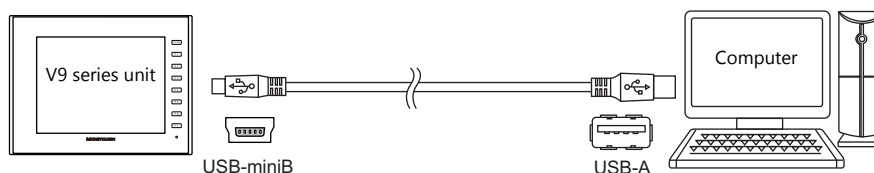

2. The USB driver is installed automatically. During installation, the following message is displayed on the computer's taskbar.

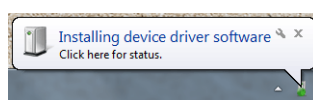

3. The following message is displayed on the computer's taskbar when installation is finished. When successfully completed, transfer the screen program. → Refer to page 7-10. If installation has terminated due to an error, reinstall the USB driver. → Refer to page 7-8.

- When successfully completed

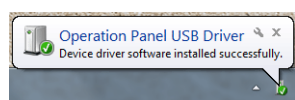

- When terminated due to error

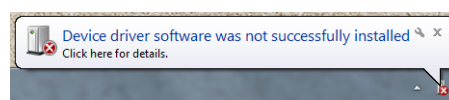

For Windows XP

1. Connect the USB-mini-B port of the V9 series unit (with power on) to the USB-A port of the computer using a USB cable.

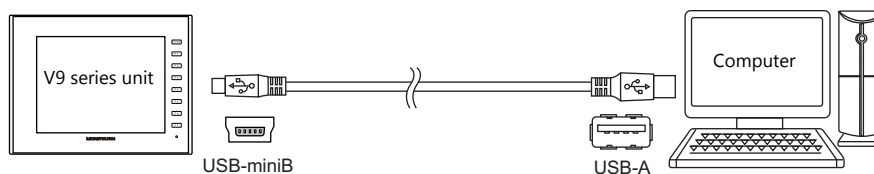

2. The message "Found New Hardware" and then the driver installation wizard appear on the computer. Select [No, not this time] and click the [Next] button.

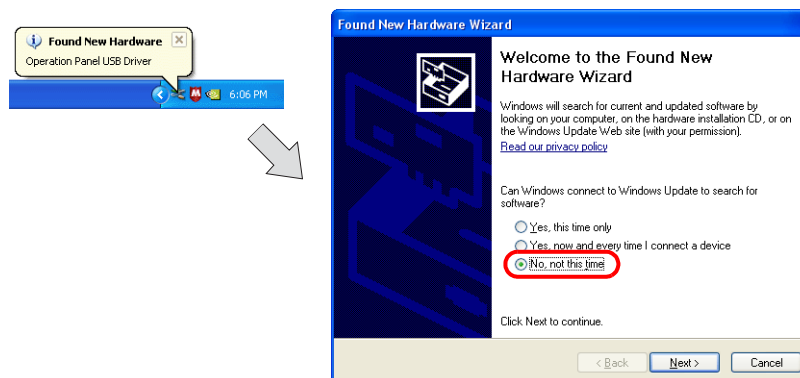

3. Select [Install the software automatically (Recommended)] on the [Found New Hardware Wizard] and click [Next].

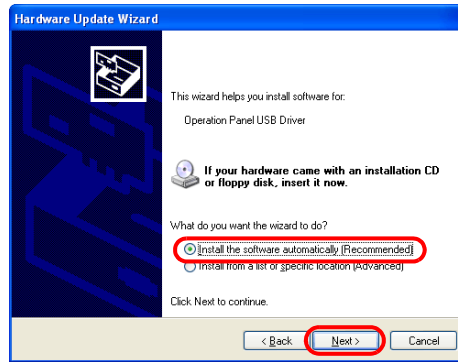

4. Installation of the USB driver starts.

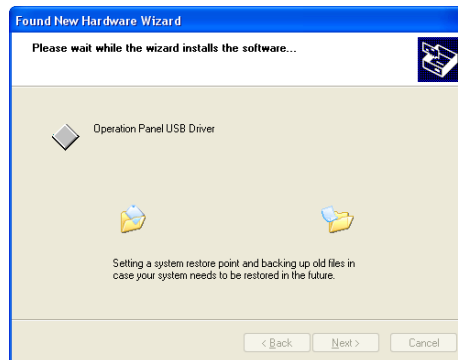

5. Click the [Finish] button on the screen below.



When USB driver installation fails

If automatic installation of the USB driver fails, perform installation according to the following procedure.

1. Open the following folder using [My Computer] or [Windows Explorer].
C:\MONITOUCH\Common\Driver
2. Double-click "USBDriverInstaller.exe".

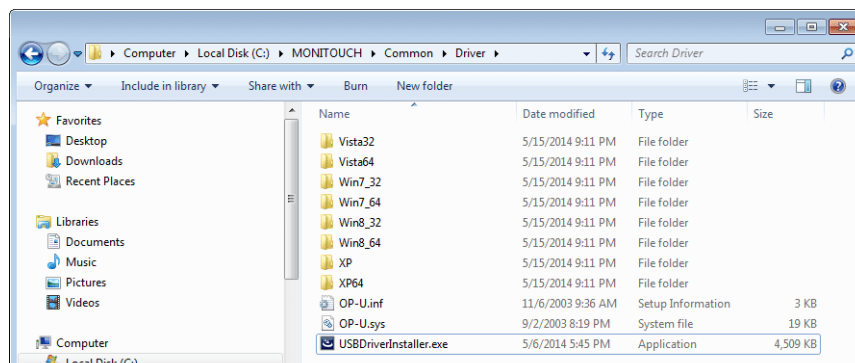

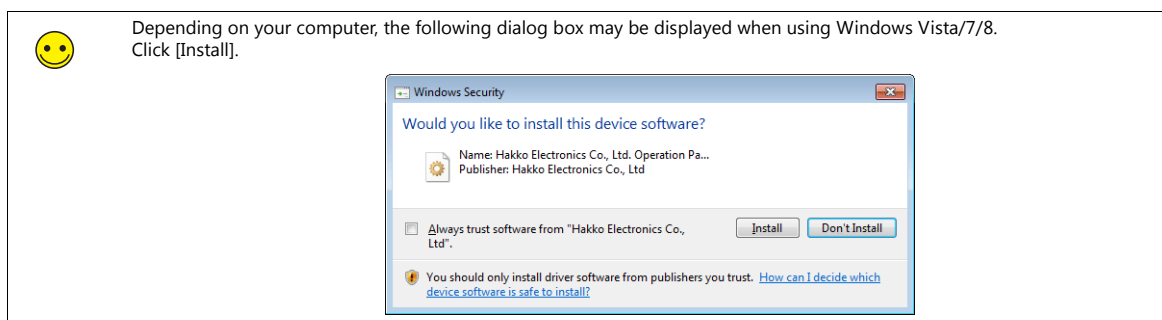

3. Click the [Next] button on the screen below. Installation of the USB driver starts.

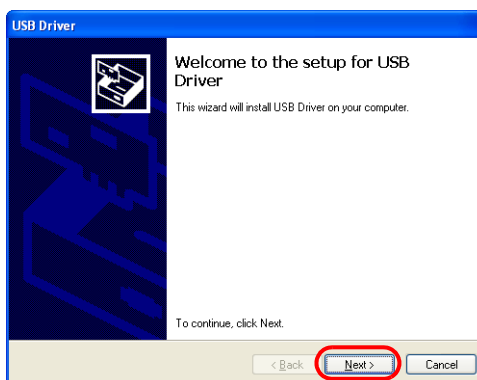

4. Click the [Finish] button on the screen below.

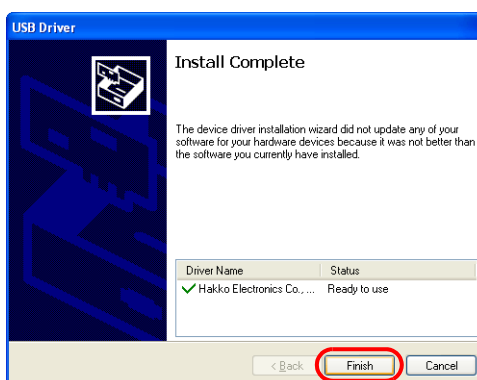

USB driver installation is complete. Transfer the screen program.

Confirming Installation of the USB Driver

When the driver has been installed successfully, the [Device Manager] window shows "Operation Panel - Operation Panel USB Driver".

- For Windows Vista/7/8/8.1

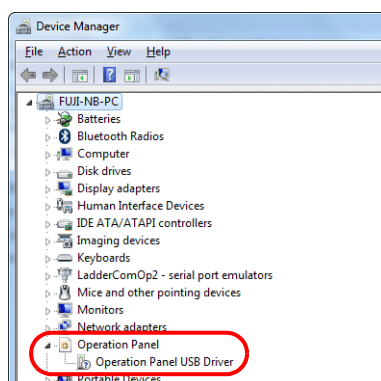

- For Windows XP

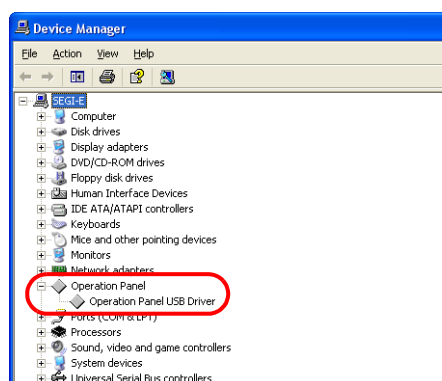

This item disappears when the USB cable is removed from a powered V9 series unit.

If [Other Device] or a mark other than shown above is displayed even while the USB is connected, the USB driver is not recognized. If this happens, uninstall the USB driver and reinstall it.

7.3.2 Transfer

Connect the USB-mini-B port of the V9 series unit to the USB-A port of the computer using a USB cable.

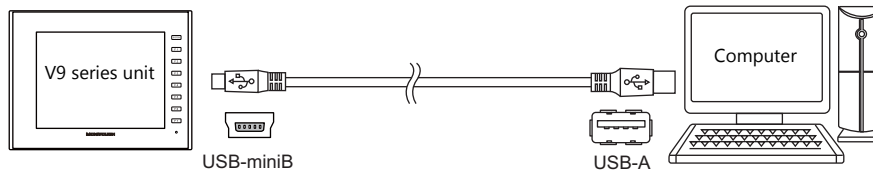

Download

Transfer screen program from the computer to the V9 series unit.

1. Click [Transfer] → [Download].

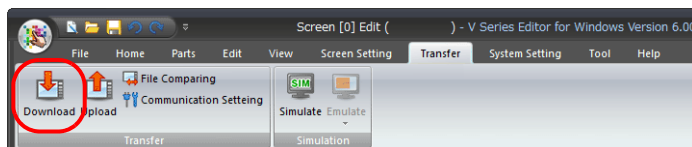

2. Set [Transfer Data] to "Screen Data" in the [Transfer] window.

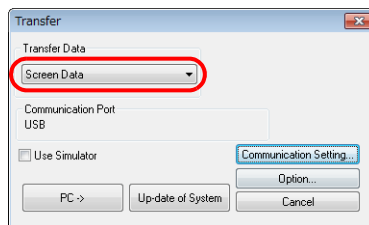

3. Check the [Communication Port] setting.
If the setting is "USB", proceed to step 4.
If the setting is a serial port or Ethernet IP address, click the [Communication Setting] button and select "USB" under [Communication Port].

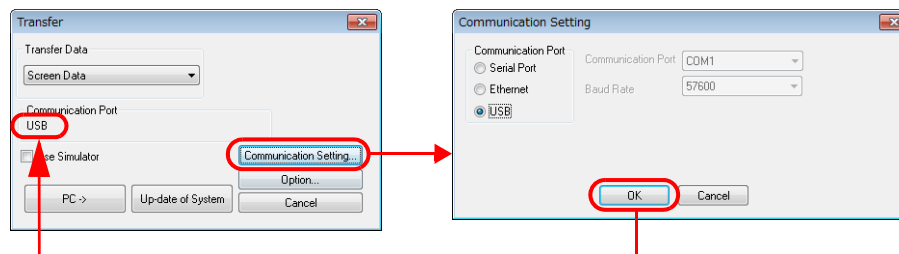

4. Select the [Use Simulator] checkbox to use the simulator.



Simulator

If a PLC is not available during debugging, use the simulator to check screen operation with only the V9 series unit. The simulator that runs on the computer acts as the PLC. For more information, refer to "8.1 Simulator" page 8-1.

5. Configure the [Option] settings as necessary.

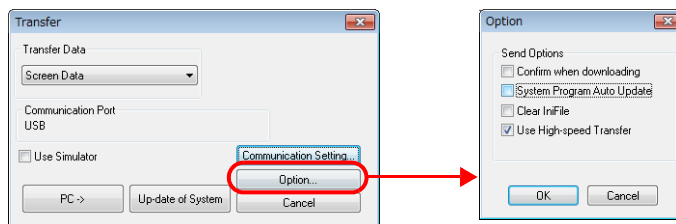

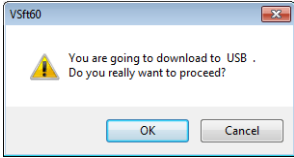
Item	Description
Confirm when downloading	When downloading, a confirmation dialog box asking "You are going to download to USB. Do you really want to proceed?" is displayed. This allows you to confirm the download method before transfer. 
System Program Auto Update	Automatically transfer the latest system program when downloading.
Clear IniFile	Clear the configuration file when downloading. For more information on the configuration file, refer to the V9 Series Troubleshooting/Maintenance Manual.
Use High-speed Transfer	Only download the parts that differ from the screen program on the unit.

6. Click [PC→] to start downloading.

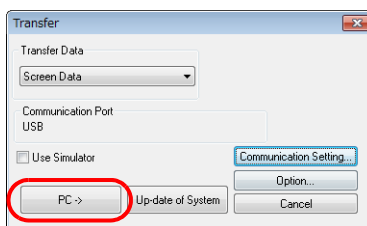

7. The following dialog box is displayed in the editor during transfer.

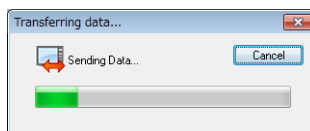

The V9 series unit switches to Local mode and the [Transferring data... (USB)] message is displayed.

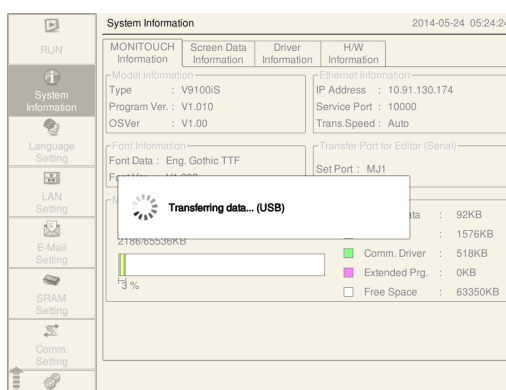

- * If the V9 series unit does not switch to Local mode and the transfer does not start, manually switch to Local mode and execute the transfer.



For more information on the procedure for switching to Local mode, refer to page 7-5.

8. When uploading is complete, the "transferring data" message disappears and communication with the PLC starts. Check the operation of the V9 series unit.

Upload

Export the screen program on the V9 series unit to the computer.

1. Click [Transfer] → [Upload].

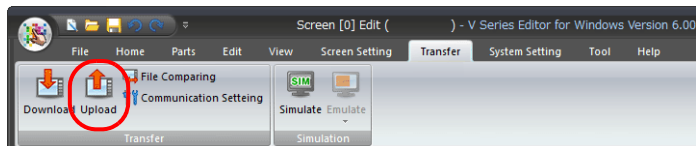

2. Set [Transfer Data] to "Screen Data" in the [Transfer] window.

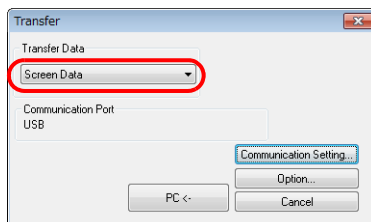

3. Check the [Communication Port] setting.

If the setting is "USB", proceed to step 4.

If the setting is a serial port or Ethernet IP address, click the [Communication Setting] button and select "USB" under [Communication Port].

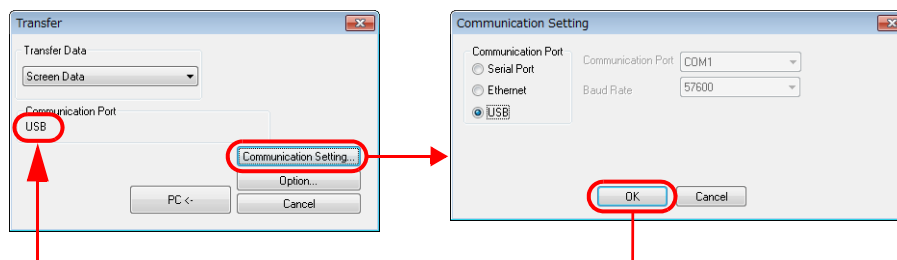

4. Click [PC<-] to start uploading.

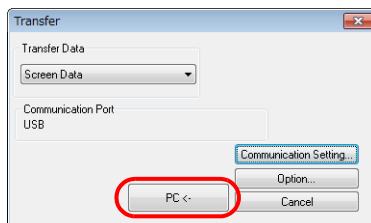

5. When uploading is complete, the "transferring data" message disappears and the uploaded screen program is displayed. Save the screen program to a new file.

File Comparing

Compare the program on the computer with the program on the V9 series unit.

1. Click [Transfer] → [File Comparing].

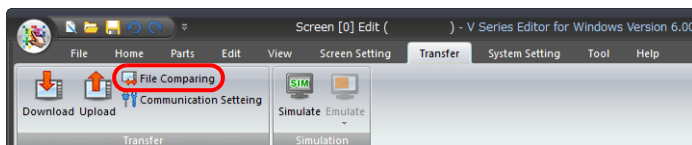

2. Set [Transfer Data] to "Screen Data" in the [Transfer] window.

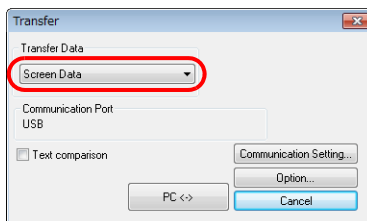

3. Check the [Communication Port] setting.
If the setting is "USB", proceed to step 4.
If the setting is a serial port or Ethernet IP address, click the [Communication Setting] button and select "USB" under [Communication Port].

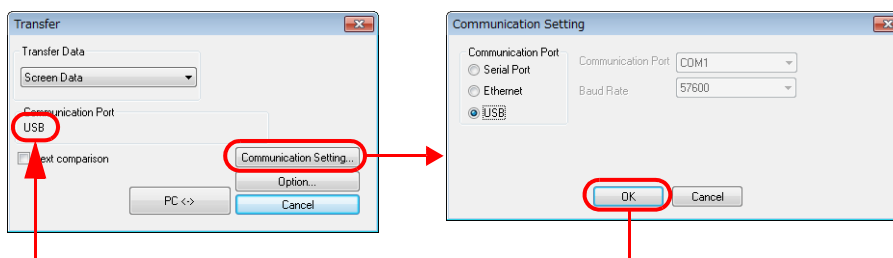

4. Select the [Text comparison] checkbox.

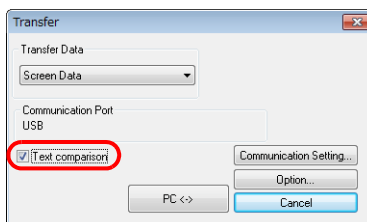

5. Click [PC<=>] to start the comparison.

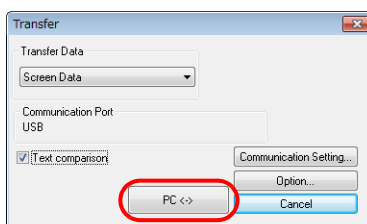

6. When the comparison is complete, the "transferring data" message disappears and the comparison results are displayed.

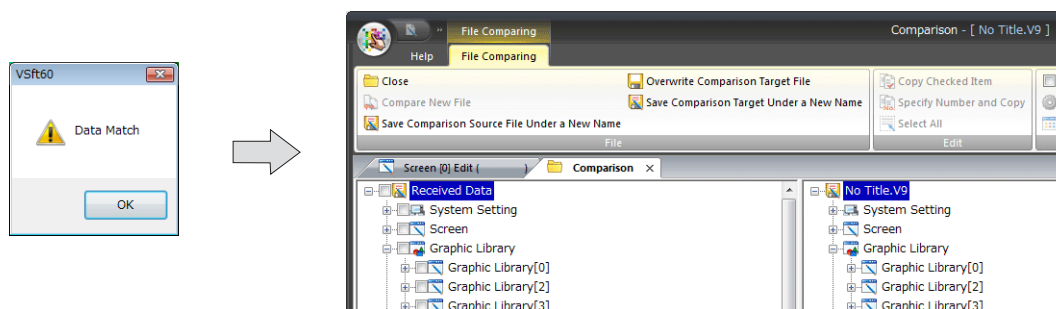

The displayed content is the same as the [File Comparing] function.
For more information, refer to "2.8 File Comparing" page 2-66.

7.4 Ethernet Transfer

7.4.1 IP Address Settings

The IP address of the V9 series unit must be configured in advance to allow Ethernet communication.

Configuring New Units

1. The following screen is displayed after the power is turned on. Selecting a language displays the "Welcome!" screen.



2. Press the [Transfer via Ethernet] switch to display the [LAN Setting] screen.

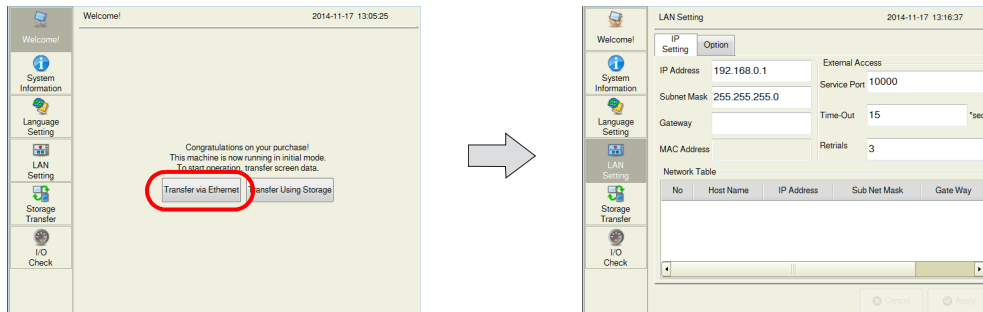

3. Configure each setting.

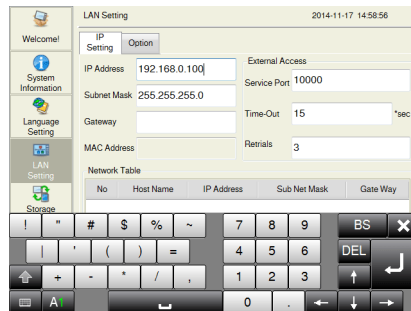

Tapping each setting displays a keyboard.

4. Press the [Apply] switch to confirm the IP address.
Press [System Information] and check the IP address displayed under [Ethernet Information].

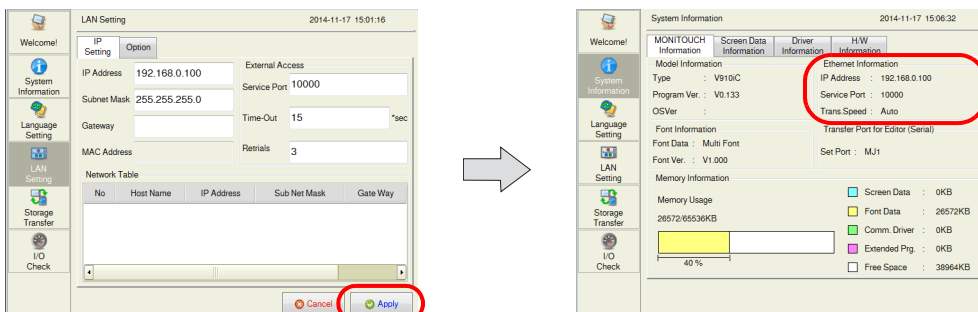

This completes the IP address settings. Next, perform screen program transfer.

Configuring Existing Units

V9 Advanced

Example: Using the [LAN] port

1. The PLC communication screen is displayed after the power is turned on. If a PLC is not connected, the [Communication Error: Time-Out] screen is displayed.
2. Press any of the four corners of the screen for more than two seconds and then press any of the remaining corners for more than two seconds to display the system menu.

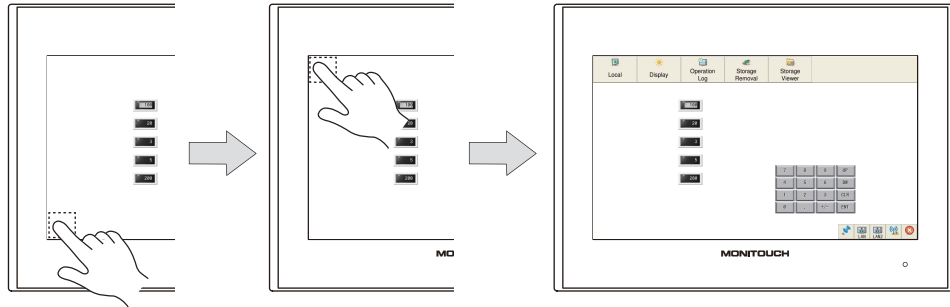

3. Press the [Local] switch on the system menu. The V9 series unit switches to Local mode.

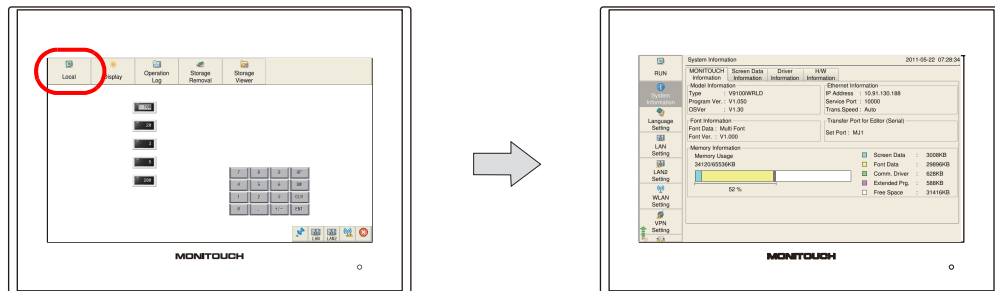

4. Press the [LAN Setting] switch to display the LAN settings screen.

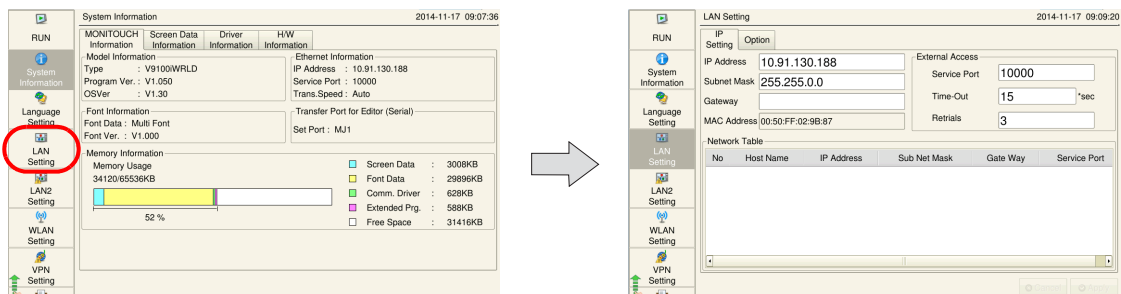

5. Configure each setting.

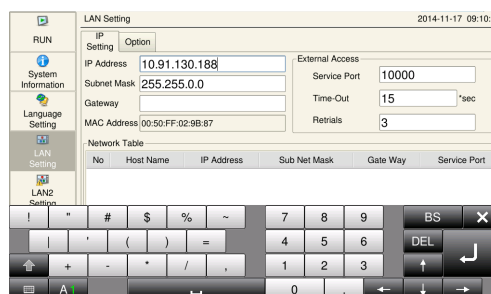

Tapping each setting displays a keyboard.

6. Press the [Apply] switch to confirm the settings.

Press [System Information] and check the IP address displayed under [Ethernet Information].

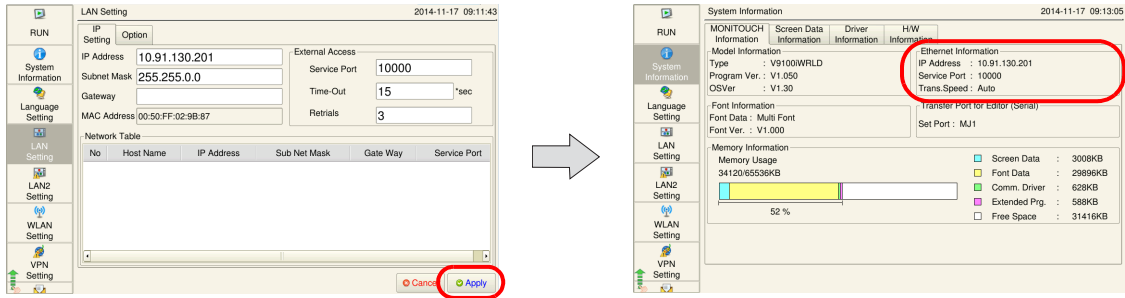

This completes the IP address settings. Next, perform screen program transfer.

V9 Standard / Lite

1. The PLC communication screen is displayed after the power is turned on. If a PLC is not connected, the [Communication Error: Time-Out] screen is displayed.
2. Press the [SYSTEM] switch to display the system menu at the top of the screen.

* **If nothing happens even after pressing the [SYSTEM] switch, hold down the [SYSTEM] switch and [F7] switch at the same time.**

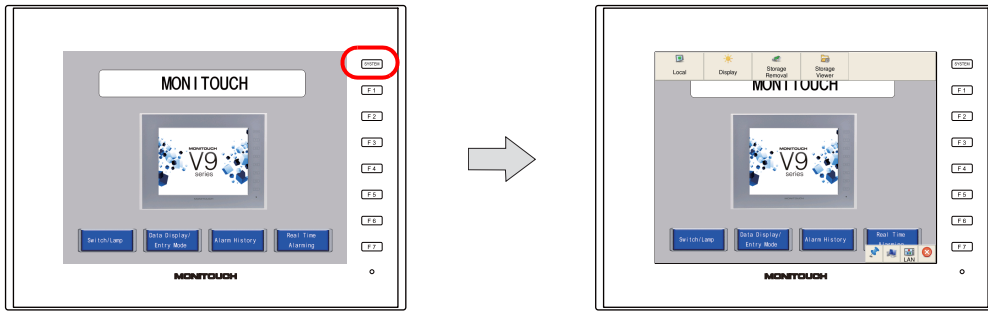

3. Press the [Local] switch on the system menu. The V9 series unit switches to Local mode.

* **If a [Local] switch does not appear on the system menu displayed by pressing the [SYSTEM] switch, hold down the [F1] switch and [F7] switch at the same time with the system menu displayed.**

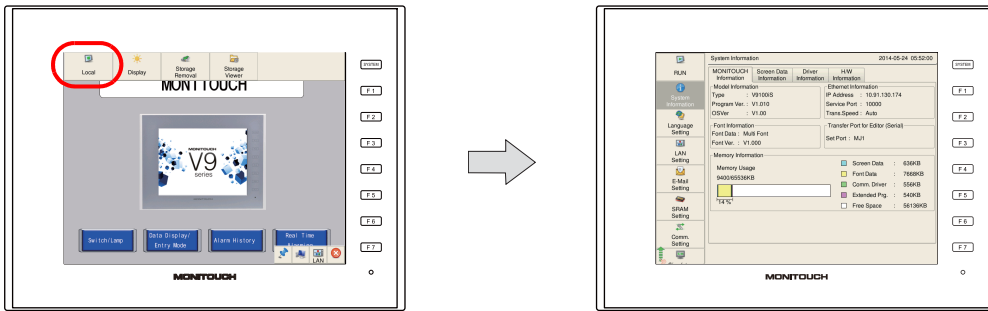

4. Press the [LAN Setting] switch to display the LAN settings screen.

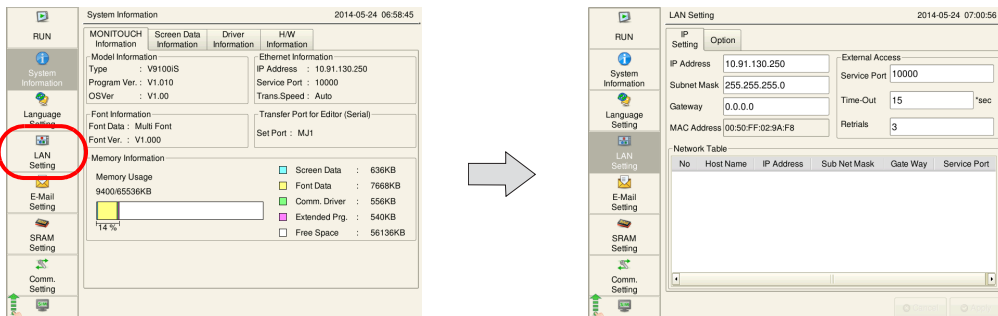

5. Configure each setting.

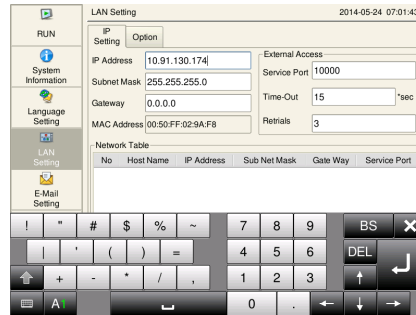

Tapping each setting displays a keyboard.

6. Press the [Apply] switch to confirm the settings.
Press [System Information] and check the IP address displayed under [Ethernet Information].

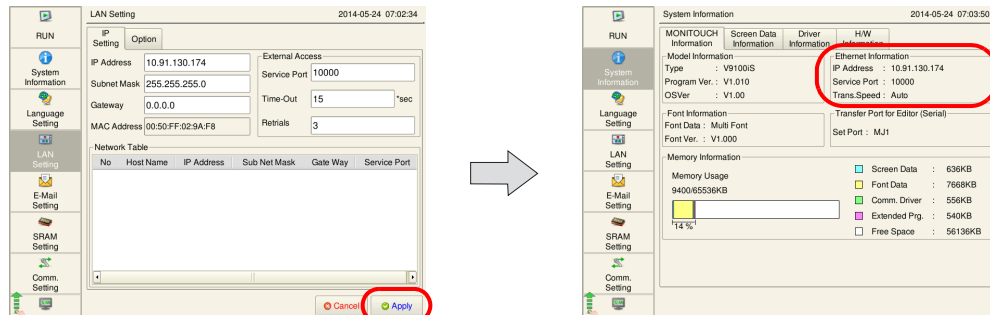

This completes the IP address settings. Next, perform screen program transfer.

Network Test

The following two methods can be used to check whether there is a problem with the Ethernet connection.

- Testing in Local mode on the V9 series unit
- Testing using the PING command on the computer

Testing in Local Mode on the V9 Series Unit

- Network test
Test whether communication is established with connected devices.
- 1) Select [I/O Check] → [Network Test].

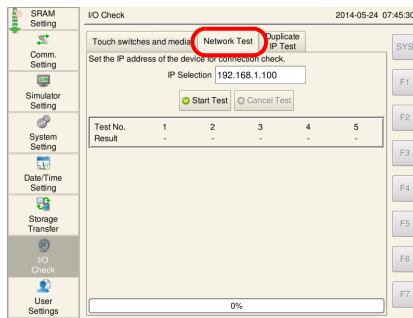

- 2) Set the IP address of the computer to [IP Selection] and press the [Start Test] switch.

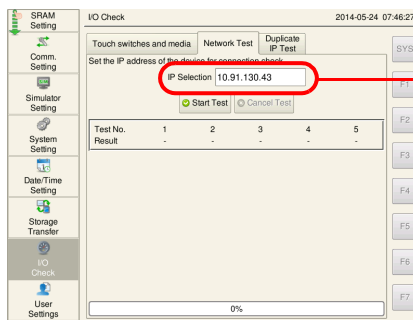

- 3) The test results are displayed.
When the test result is "NG", check the IP address of the V9 series unit and computer as well as the connection cable.

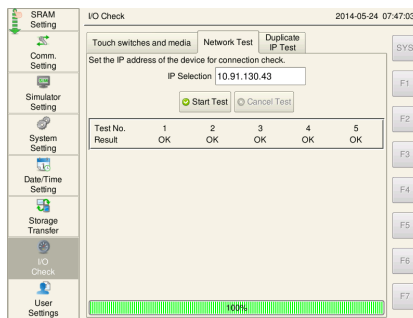

- Duplicate IP address test
Check whether any devices have the same IP address as the V9 series unit on the network.
- 1) Select [I/O Check] → [Duplicate IP Test].

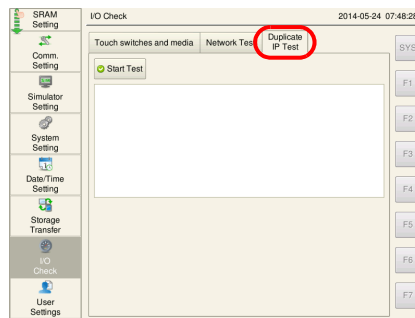

- 2) Press the [Start Test] switch.

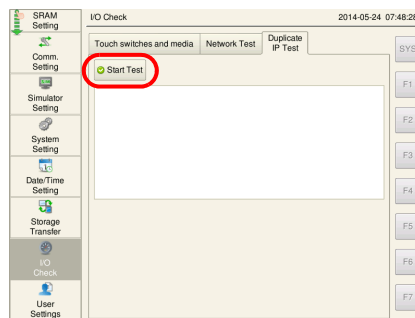

- 3) The test results are displayed.
If a duplicate IP address is found, the MAC address of the corresponding device is displayed.
Either check the device with the duplicate IP address or change the IP address of the V9 series unit.

When there is no duplicate IP address

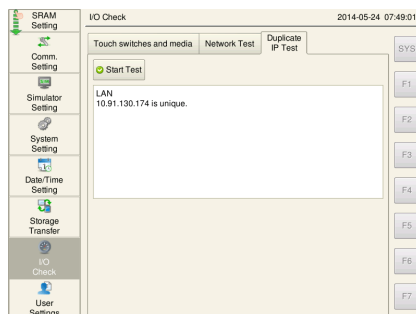

When a duplicate IP address is found

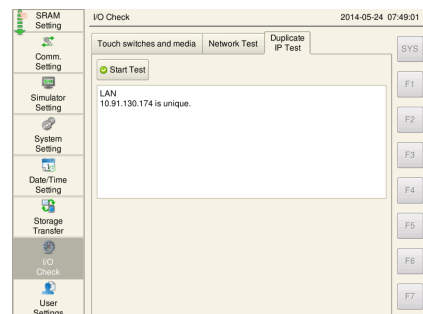

Testing using the PING command on the computer

Example: Check the connection state from the computer when the IP address of the V9 series unit is "10.91.130.174".

1. Open a [Command Prompt] window on the computer.

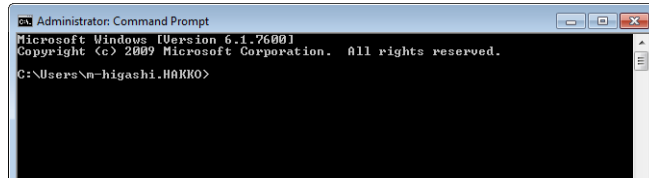

```
Administrator: Command Prompt
Microsoft Windows [Version 6.1.7600]
Copyright (c) 2009 Microsoft Corporation. All rights reserved.
C:\Users\n-higashi.HAKKO>
```

2. Enter "ping 10.91.130.174" on the command line using the keyboard and press the [Enter] key.

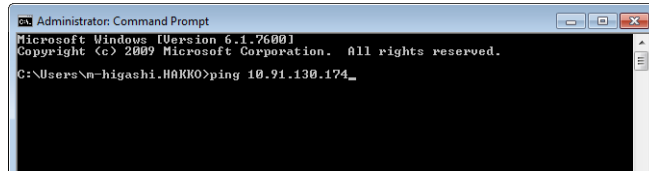

```
Administrator: Command Prompt
Microsoft Windows [Version 6.1.7600]
Copyright (c) 2009 Microsoft Corporation. All rights reserved.
C:\Users\n-higashi.HAKKO>ping 10.91.130.174_
```

3. The following result is displayed if the unit is connected.

Connection OK

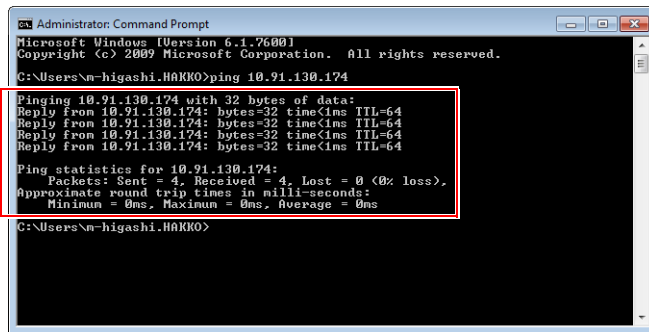

```
Administrator: Command Prompt
Microsoft Windows [Version 6.1.7600]
Copyright (c) 2009 Microsoft Corporation. All rights reserved.
C:\Users\n-higashi.HAKKO>ping 10.91.130.174
Pinging 10.91.130.174 with 32 bytes of data:
Reply from 10.91.130.174: bytes=32 time<ms TTL=64
Reply from 10.91.130.174: bytes=32 time<ms TTL=64
Reply from 10.91.130.174: bytes=32 time<ms TTL=64
Reply from 10.91.130.174: bytes=32 time<ms TTL=64
Ping statistics for 10.91.130.174:
    Packets: Sent = 4, Received = 4, Lost = 0 (0% loss),
    Approximate round trip times in milli-seconds:
        Minimum = 0ms, Maximum = 0ms, Average = 0ms
C:\Users\n-higashi.HAKKO>
```

4. The following result is displayed if the unit is disconnected.

Disconnected

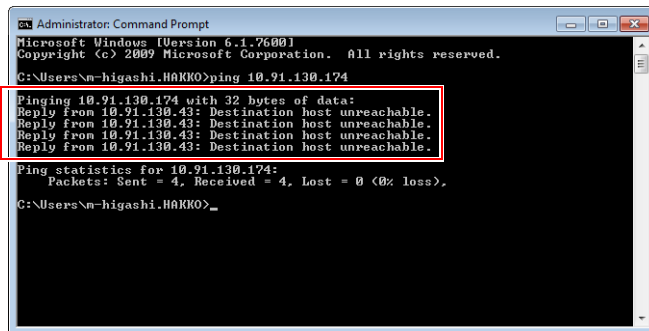

```
Administrator: Command Prompt
Microsoft Windows [Version 6.1.7600]
Copyright (c) 2009 Microsoft Corporation. All rights reserved.
C:\Users\n-higashi.HAKKO>ping 10.91.130.174
Pinging 10.91.130.174 with 32 bytes of data:
Reply from 10.91.130.43: Destination host unreachable.
Reply from 10.91.130.43: Destination host unreachable.
Reply from 10.91.130.43: Destination host unreachable.
Reply from 10.91.130.43: Destination host unreachable.
Ping statistics for 10.91.130.174:
    Packets: Sent = 4, Received = 4, Lost = 0 (0% loss),
C:\Users\n-higashi.HAKKO>
```

Check the IP address of the V9 series unit and computer as well as the connection cable.

7.4.2 Transfer

Connect the LAN port on the V9 series unit to the computer using a LAN cable.

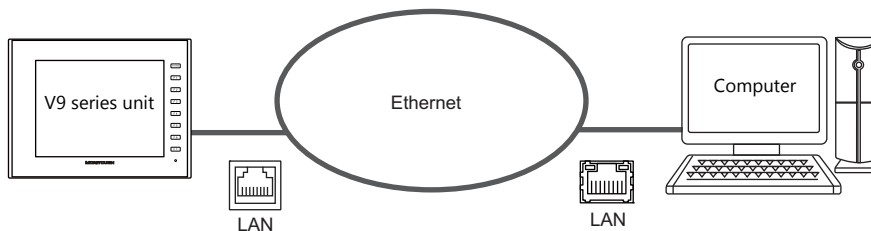

Download

Transfer a screen program from the computer to the V9 series unit.

1. Click [Transfer] → [Download].

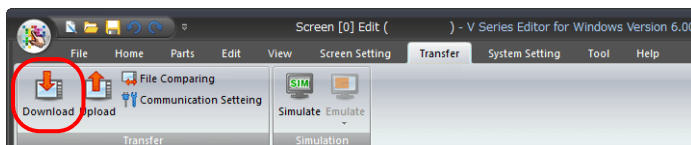

2. Set [Transfer Data] to "Screen Data" in the [Transfer] window.

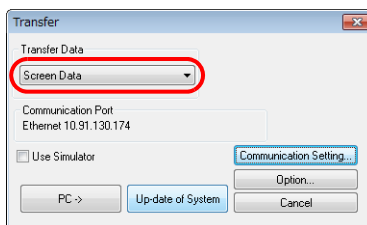

3. Check the [Communication Port] setting.

If the setting is Ethernet and the IP address is correct, proceed to step 4.

If the setting is a serial port or USB, click the [Communication Setting] button, select "Ethernet" under [Communication Port], and set the IP address of the V9 series unit.

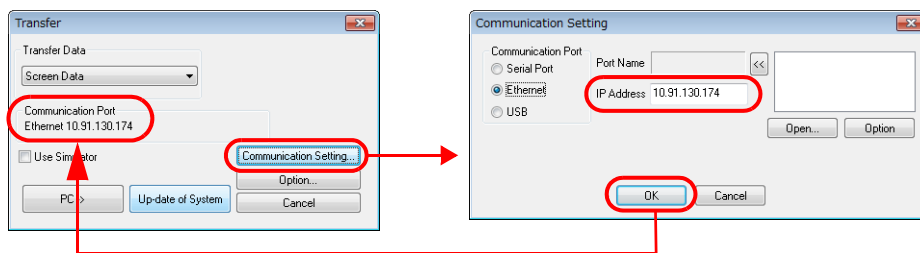

For a screen program with a configured network table, the table contents are displayed in the upper right field.

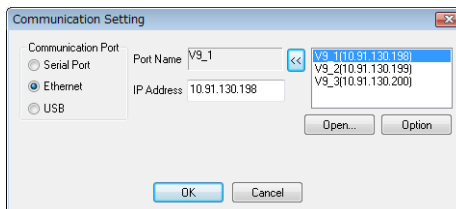

Click to select the IP address of the V9 series unit from the list and use the [<<] button to move the selected IP address to the [IP Address] field.

4. Select the [Use Simulator] checkbox to use the simulator.



Simulator

If a PLC is not available during debugging, use the simulator to check screen operation with only the V9 series unit. The simulator that runs on the computer acts as the PLC. For more information, refer to "8.1 Simulator" page 8-1.

5. Configure the [Option] settings as necessary.

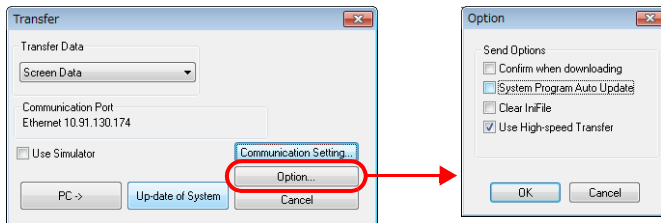

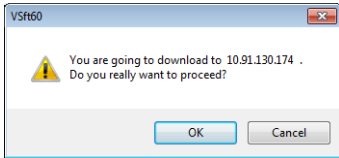
Item	Description
Confirm when downloading	When downloading, a confirmation dialog box “You are going to download to xxx.xxx.xxx.xxx (IP address of V9 series unit). Do you really want to proceed?” is displayed. This allows you to confirm the download method before transfer. 
System Program Auto Update	Automatically transfer the latest system program when downloading.
Clear IniFile	Clear the configuration file when downloading. For more information on the configuration file, refer to the V9 Series Troubleshooting/Maintenance Manual.
Use High-speed Transfer	Only download the parts that differ from the screen program on the unit.

6. Click [PC→] to start downloading.

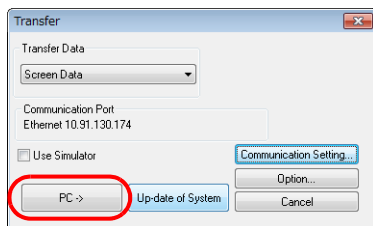

7. The following dialog box is displayed in the editor during transfer.

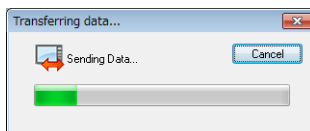

The V9 series unit switches to Local mode and the [Transferring data... (Ethernet)] message is displayed.

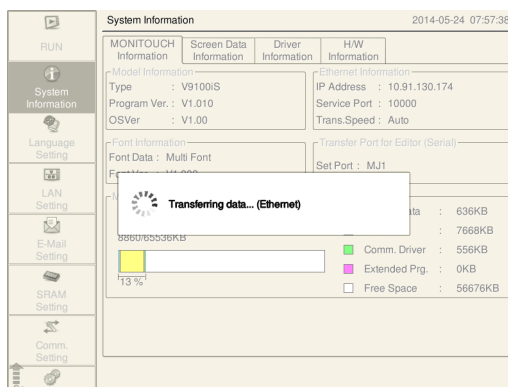

8. When downloading is complete, the “transferring data” message disappears and communication with the PLC starts. Check the operation of the V9 series unit.

Upload

Export the screen program on the V9 series unit to the computer.

1. Click [Transfer] → [Upload].

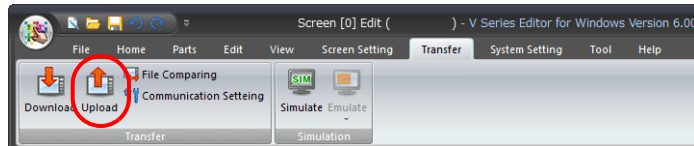

2. Set [Transfer Data] to "Screen Data" in the [Transfer] window.

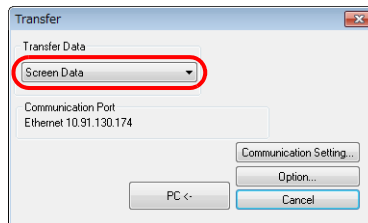

3. Check the [Communication Port] setting.

If the setting is Ethernet and the IP address is correct, proceed to step 4.

If the setting is a serial port or USB, click the [Communication Setting] button, select "Ethernet" under [Communication Port], and set the IP address of the V9 series unit.

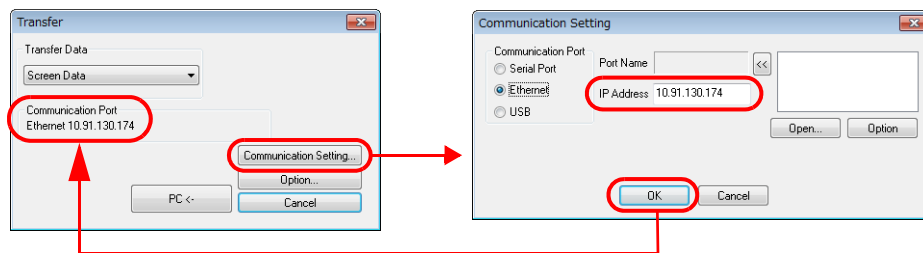

For a screen program with a configured network table, the table contents are displayed in the upper right field.

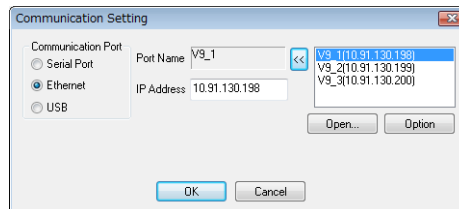

Click to select the IP address of the V9 series unit from the list and use the [<<] button to move the selected IP address to the [IP Address] field.

4. Click [PC<->] to start uploading.

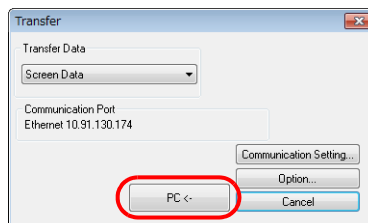

5. When uploading is complete, the "transferring data" message disappears and the uploaded screen program is displayed. Save the screen program to a new file.

File Comparing

Compare the program on the computer with the program on the V9 series unit.

1. Click [Transfer] → [File Comparing].

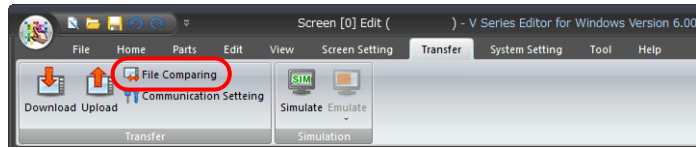

2. Set [Transfer Data] to "Screen Data" in the [Transfer] window.

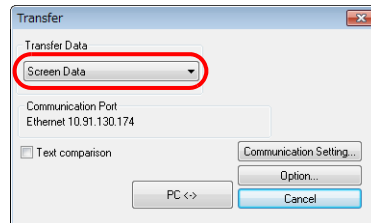

3. Check the [Communication Port] setting.

If the setting is Ethernet and the IP address is correct, proceed to step 4.

If the setting is a serial port or USB, click the [Communication Setting] button, select "Ethernet" under [Communication Port], and set the IP address of the V9 series unit.

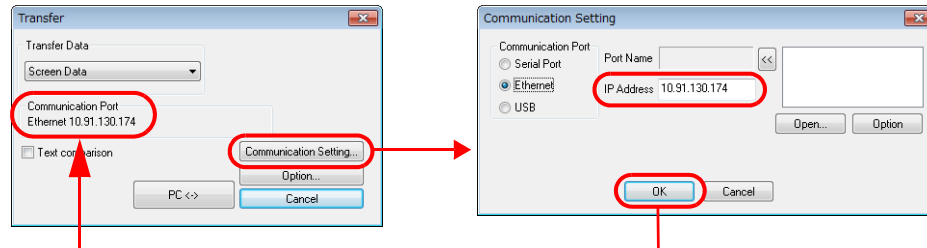

4. Select the [Text comparison] checkbox.

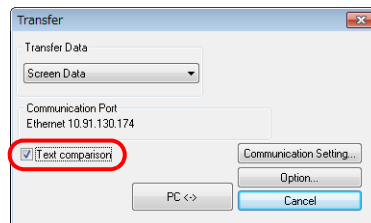

5. Click [PC↔] to start the comparison.

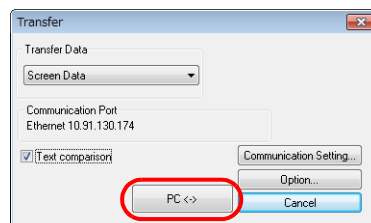

6. When the comparison is complete, the "transferring data" message disappears and the comparison results are displayed.

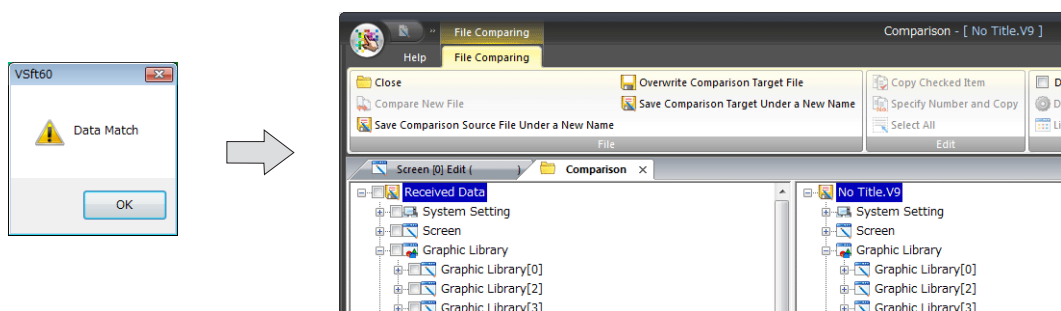

The displayed content is the same as the [File Comparing] function.
For more information, refer to "2.8 File Comparing" page 2-66.

7.5 V-CP Transfer

Connect the MJ1 port on the V9 series unit to the COM port of the computer using a V-CP cable.

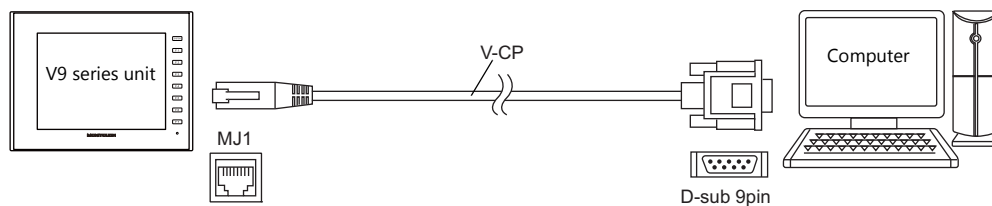

Download

Transfer a screen program from the computer to the V9 series unit.

1. Click [Transfer] → [Download].

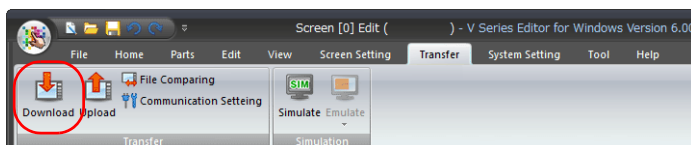

2. Set [Transfer Data] to "Screen Data" in the [Transfer] window.

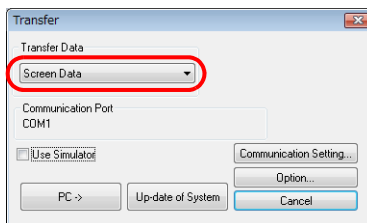

3. Check the [Communication Port] setting.
If the setting is "Serial Port", proceed to step 5.
If the setting is USB or Ethernet, click the [Communication Setting] button, select "Serial Port" under [Communication Port], and set a value for [Communication Port] and [Baud Rate].

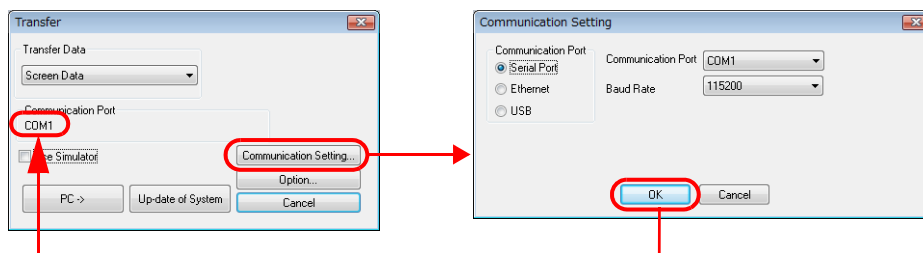

When using a USB-serial converter, select the COM port set for the USB port.

4. Select the [Use Simulator] checkbox to use the simulator.



Simulator
If a PLC is not available during debugging, use the simulator to check screen operation with only the V9 series unit. The simulator that runs on the computer acts as the PLC. For more information, refer to "8.1 Simulator" page 8-1.

5. Configure the [Option] settings as necessary.

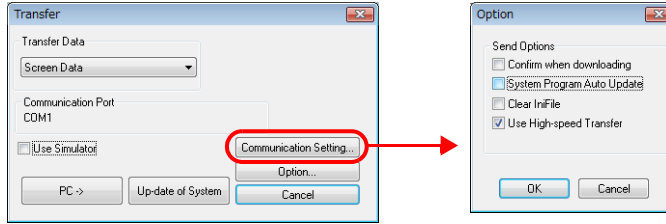

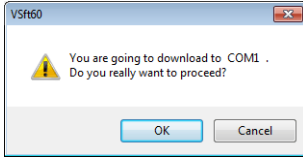
Item	Description
Confirm when downloading	When downloading, a confirmation dialog box asking "You are going to download to COMx. Do you really want to proceed?" is displayed. This allows you to confirm the download method before transfer. 
System Program Auto Update	Automatically transfer the latest system program when downloading.
Clear IniFile	Clear the configuration file when downloading. For more information on the configuration file, refer to the V9 Series Troubleshooting/Maintenance Manual.
Use High-speed Transfer	Only download the parts that differ from the screen program on the unit.

6. Click [PC→] to start downloading.

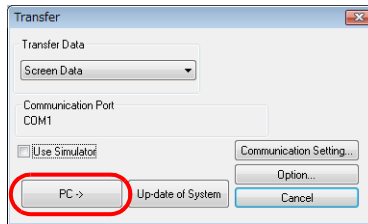

7. The following dialog box is displayed in the editor during transfer.

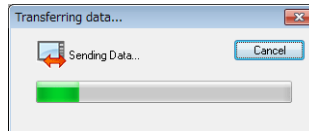

The V9 series unit switches to Local mode and the [Transferring data... (Serial)] message is displayed.

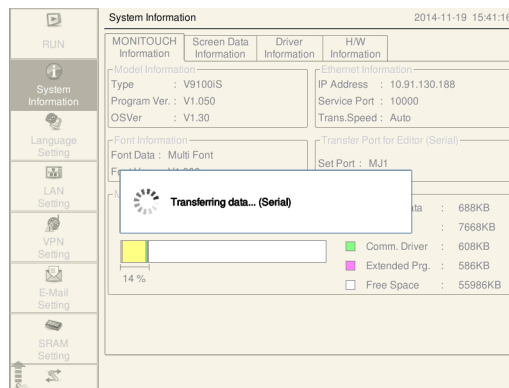

* If the V9 series unit does not switch to Local mode and the transfer does not start, manually switch to Local mode and execute the transfer.



For more information on the procedure for switching to Local mode, refer to page 7-5.

8. When downloading is complete, the "transferring data" message disappears and communication with the PLC starts. Check the operation of the V9 series unit.

Upload

Export the screen program on the V9 series unit to the computer.

1. Click [Transfer] → [Upload].

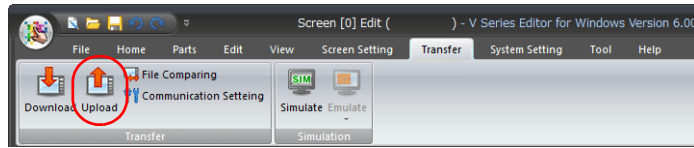

2. Set [Transfer Data] to "Screen Data" in the [Transfer] window.

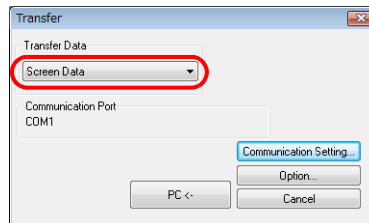

3. Check the [Communication Port] setting.

If the setting is "COM", proceed to step 4.

If the setting is USB or Ethernet, click the [Communication Setting] button, select "Serial Port" under [Communication Port], and set a value for [Communication Port] and [Baud Rate].

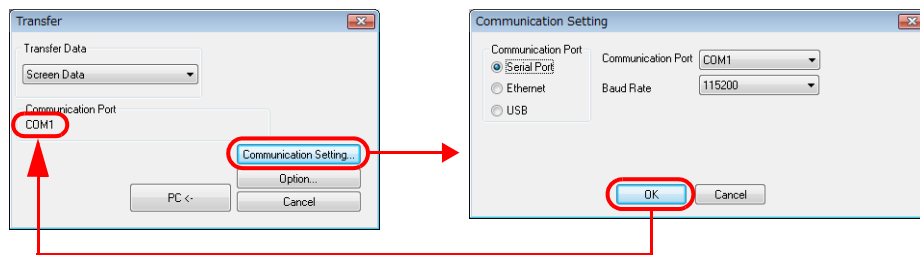

When using a USB-serial converter, select the COM port set for the USB port.

4. Click [PC←] to start uploading.

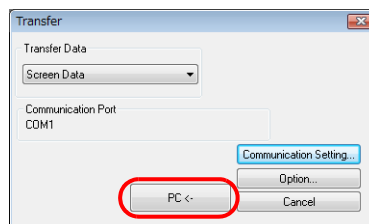

5. When uploading is complete, the "transferring data" message disappears and the uploaded screen program is displayed. Save the screen program to a new file.

File Comparing

Compare the program on the computer with the program on the V9 series unit.

1. Click [Transfer] → [File Comparing].

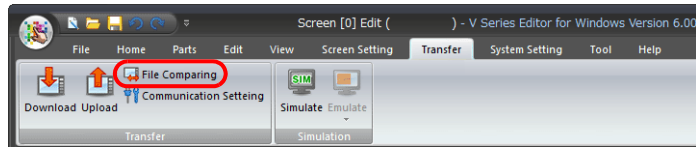

2. Set [Transfer Data] to "Screen Data" in the [Transfer] window.

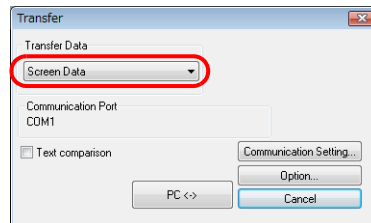

3. Check the [Communication Port] setting.

If the setting is "COM", proceed to step 4.

If the setting is USB or Ethernet, click the [Communication Setting] button, select "Serial Port" under [Communication Port], and set a value for [Communication Port] and [Baud Rate].

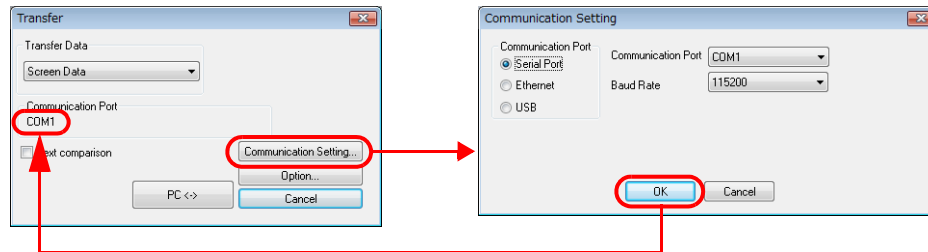

4. Select the [Text comparison] checkbox.

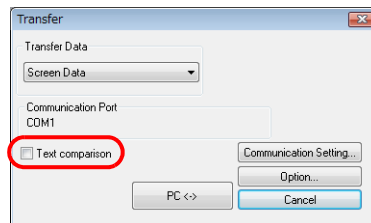

5. Click [PC<->] to start the comparison.

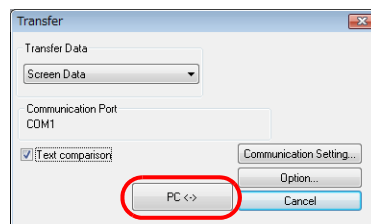

6. When the comparison is complete, the "transferring data" message disappears and the comparison results are displayed.

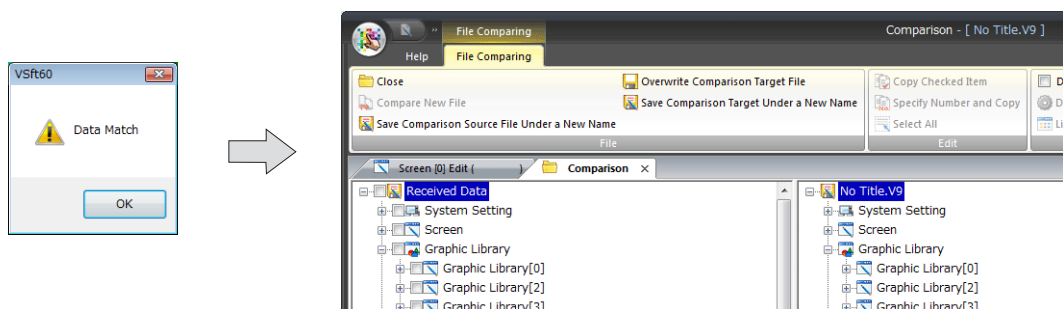

The displayed content is the same as the [File Comparing] function.
For more information, refer to "2.8 File Comparison" page 2-66.

7.6 Transfer via Storage

When transferring data using a storage device, the system configuration is as follows.

Example: SD card

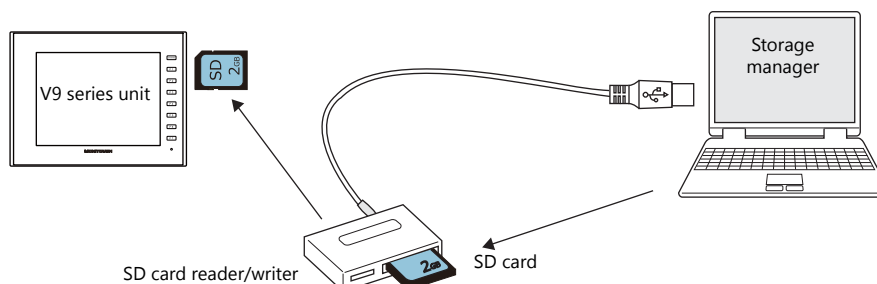

Transfer Procedure for Storage Device → V9 Series Unit

When a storage device is used, data is transferred by following the procedure described below.

- Transfer for editor → storage device (using storage manager)
- Transfer for storage device → V9 series unit

This section explains the procedure when using an SD card.

Transfer procedure for editor → storage device (using storage manager)

1. Insert (or connect) the SD card into the computer.

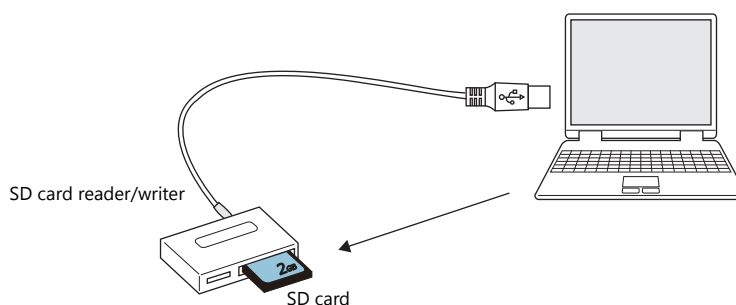

Check the drive allocation of the SD card in advance.
(In the example, H: drive is allocated as the storage device drive.)

2. In the editor, click [File] → [Storage Manager].

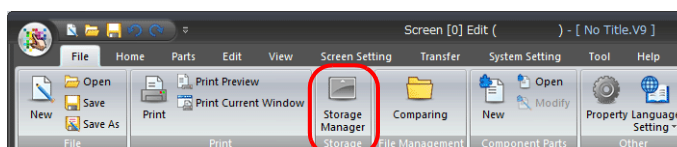

3. The window for specifying the drive is displayed.
Specify the drive that you checked in step 1 (e.g. H: drive), and click [OK].

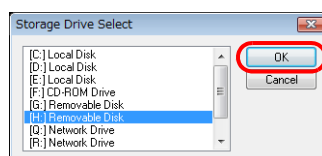

- The [Storage Manager] tab window is displayed.

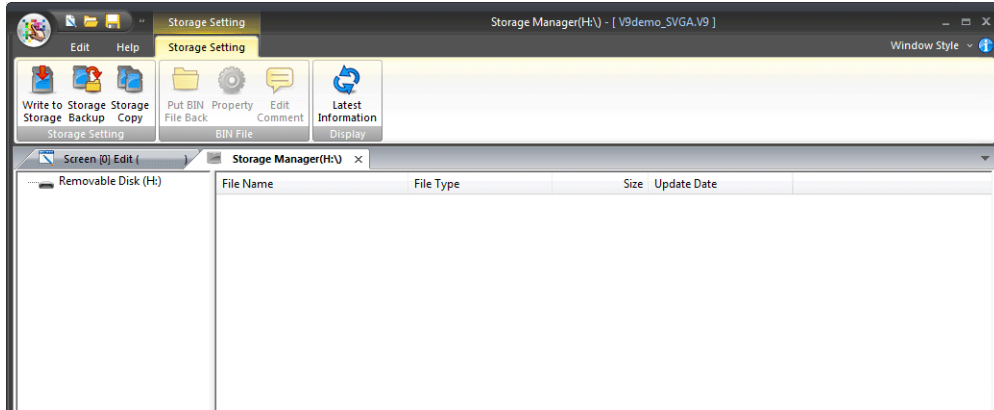

- Click [Write to Storage].
The [Write to storage] window is displayed.

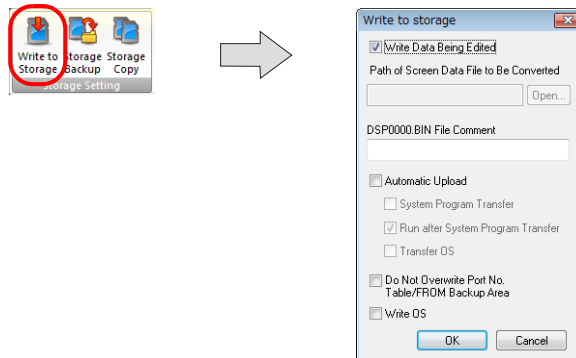

- When transferring the currently open file, select the [Write Data Being Edited] checkbox.
When selecting a different screen program file, deselect the [Write Data Being Edited] checkbox and click the [Open] button for [Path of File to Be Converted].

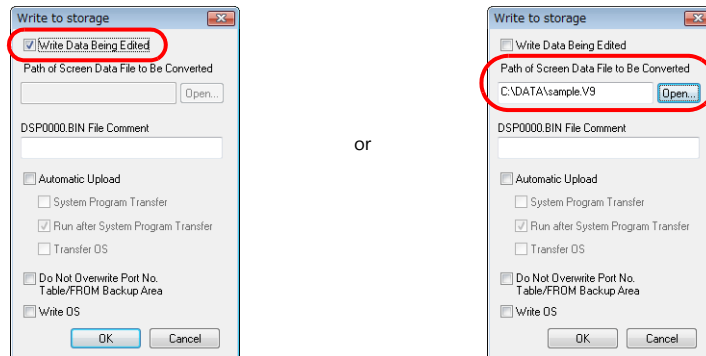

☺ For more information on the automatic upload method and procedure for updating the operating system, refer to "18 Storage" in V9 Series Reference Manual 2.

- Click [OK].
The program is written to the SD card.

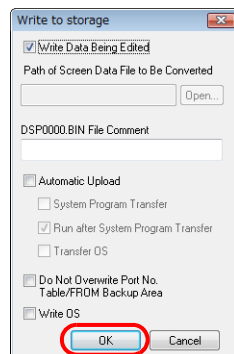

8. When writing is complete, the access folder is automatically created on the storage device.
 In the "DSP" folder created in the access folder, check that the [DSP0000.BIN] file has been created.
 This "DSP0000.BIN" file is the screen program file.

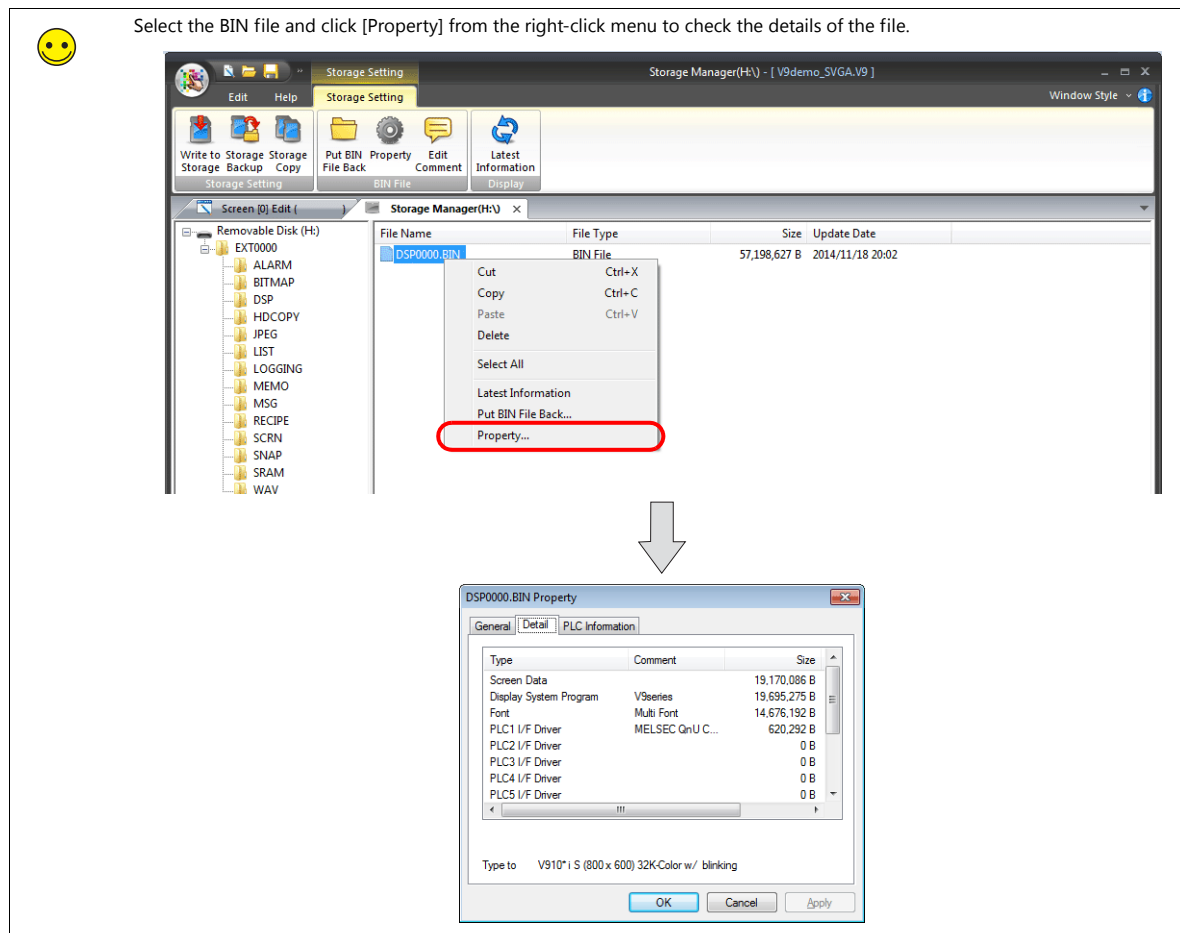
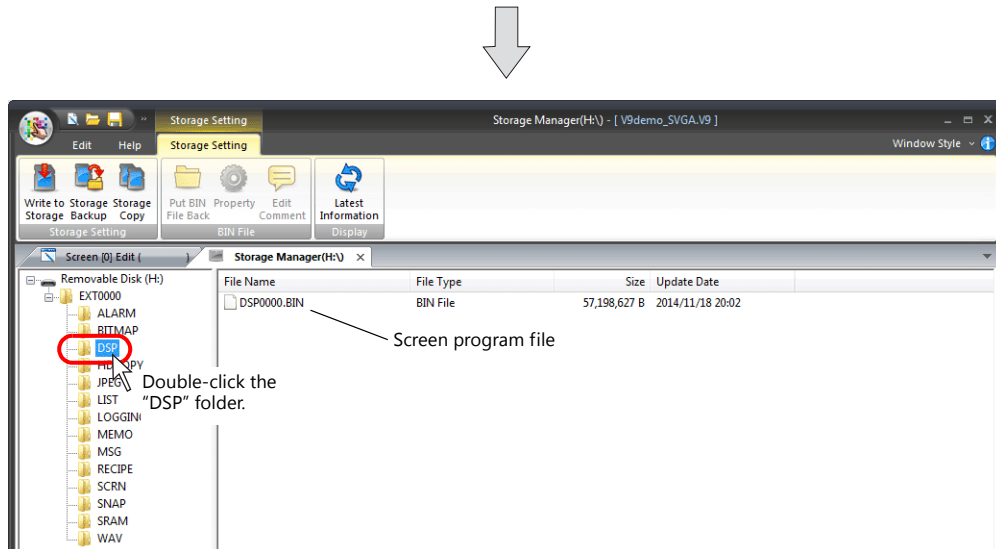
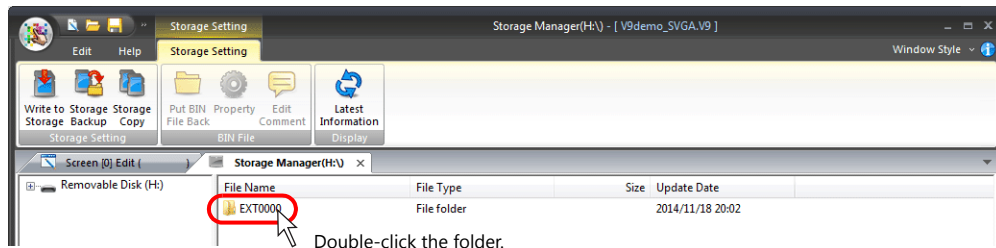

Transfer procedure for storage device → V9 series unit

1. Switch to Local mode on the V9 series unit.

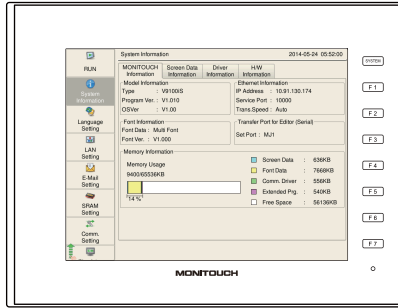

For more information on the procedure for switching to Local mode, refer to page 7-5.

2. Insert the SD card that contains the screen program into the V9 series unit.

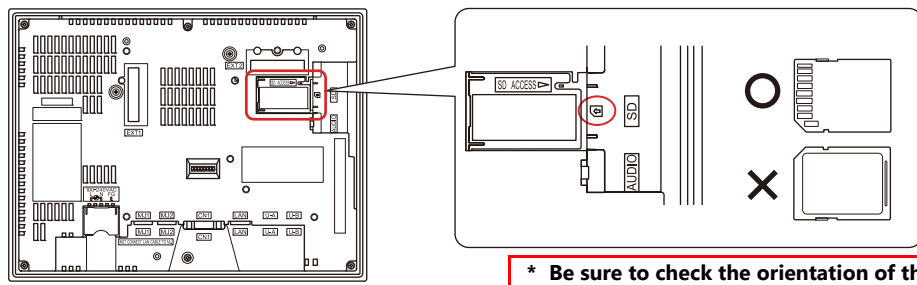

3. Press the [Storage Transfer] switch on the left-side menu.
The [Storage Transfer] screen is displayed.

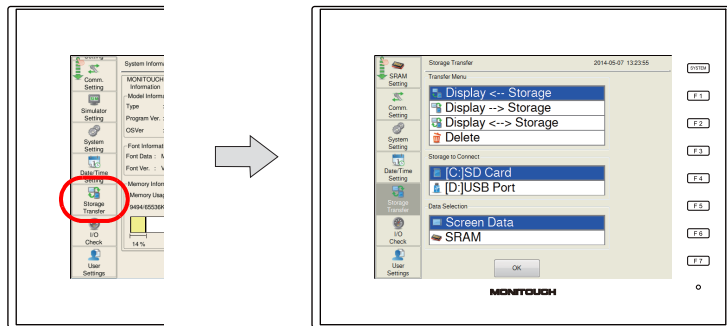

4. Select "Display ← Storage" for [Transfer Menu], "[C:] SD Card" for [Storage to Connect], and "Screen Data" for [Data Selection].

Press [OK].

The [Storage File Information] screen is displayed.

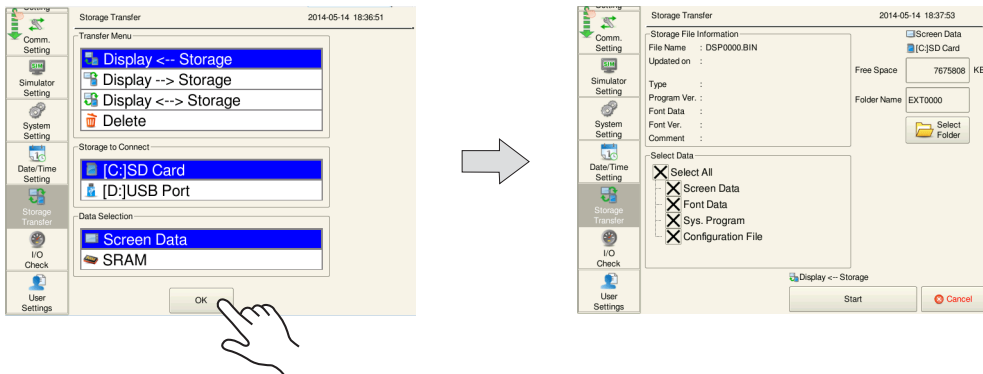

5. When the name of the access folder created on the storage device is shown as [Folder Name], go to the next step (step 6). When a different name is displayed for [Folder Name], press the [Select Folder] switch and select the desired folder.

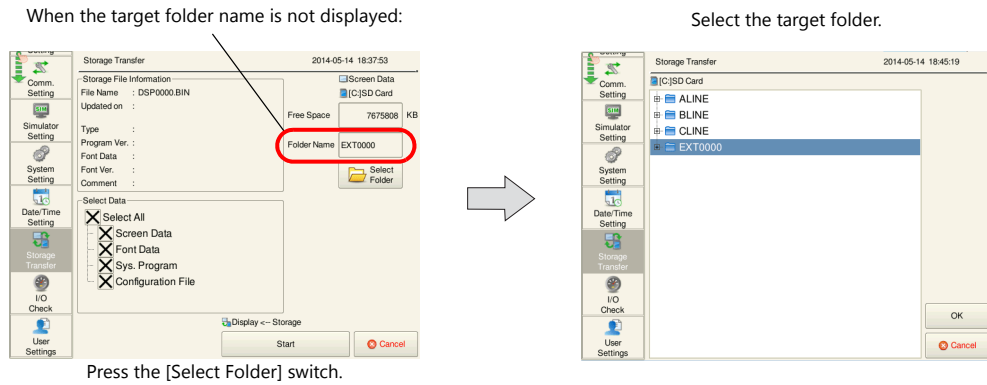

6. Select the items to transfer under [Select Data]. In this example, press the [Select All] switch so that all data will be transferred. Press the [Start] switch. [Transferring data... (Storage)] is displayed.

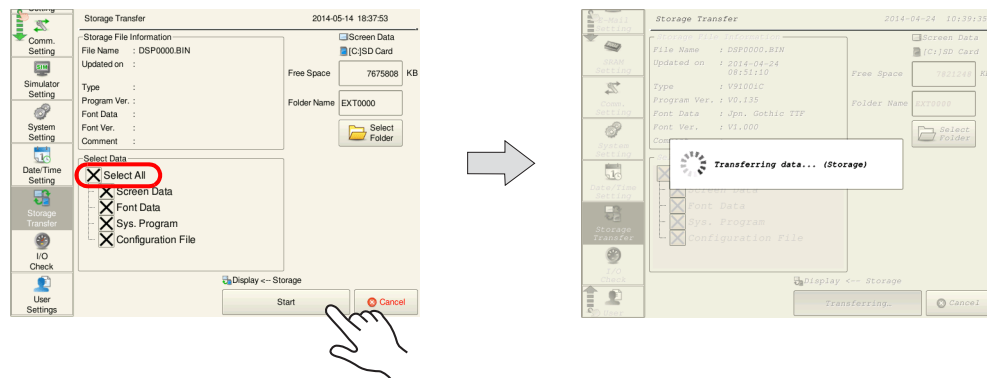

7. When the transfer is complete, [Work normally finished] is displayed. Pressing [OK] displays [Acquiring file information] and then the [Storage File Information] screen is updated.

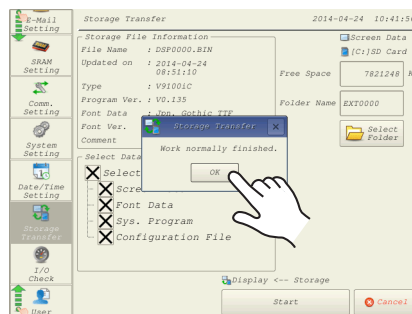

This completes the data transfer.

Transfer Procedure for V9 Series Unit → Storage Device

When a storage device is used, data is transferred by following the procedure described below.

- Transfer for V9 series unit → storage device
- Transfer for storage device → editor (using storage manager)

This section explains the procedure when using an SD card.

Transfer procedure for V9 series unit → storage device

1. Switch to Local mode on the V9 series unit.

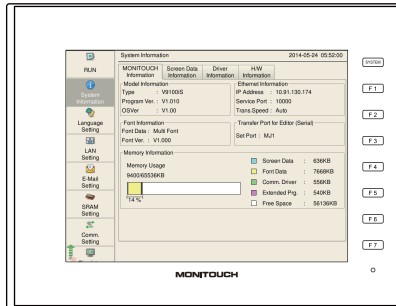

For more information on the procedure for switching to Local mode, refer to page 7-5.

2. Insert the SD card into V9 series unit.

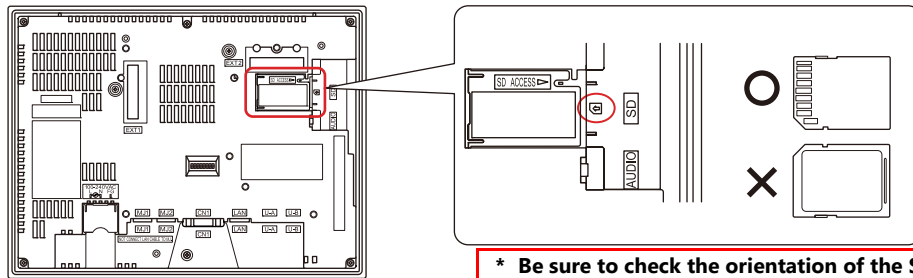

*** Be sure to check the orientation of the SD card.**

3. Press the [Storage Transfer] switch on the left-side menu. The [Storage Transfer] screen is displayed.

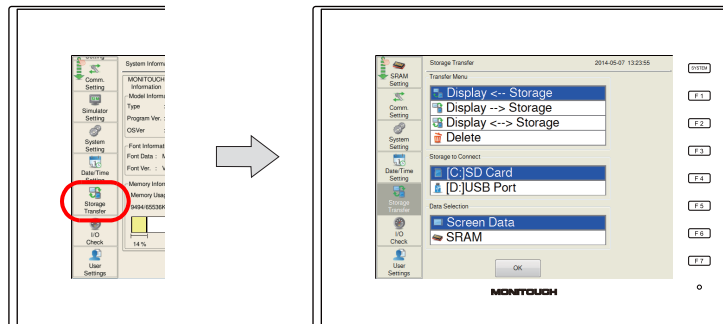

4. Select "Display → Storage" for [Transfer Menu], "[C:] SD Card" for [Storage to Connect], and "Screen Data" for [Data Selection].

Press [OK].

The [Storage File Information] screen is displayed.

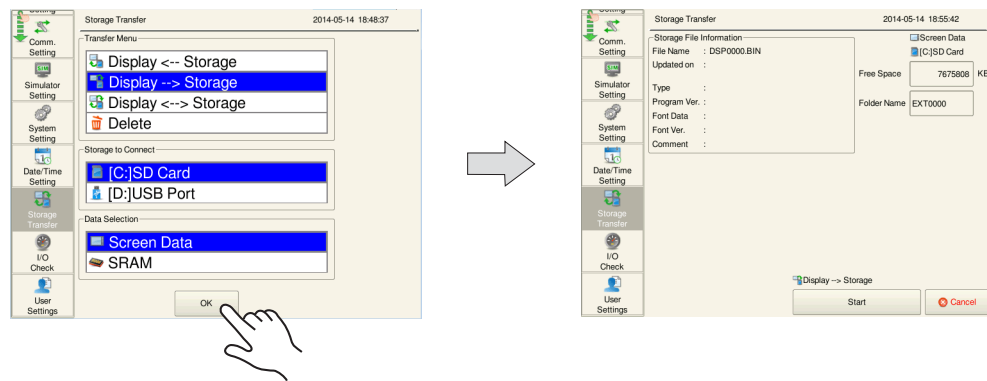

5. Press the [Start] switch. [Transferring data... (Storage)] is displayed.

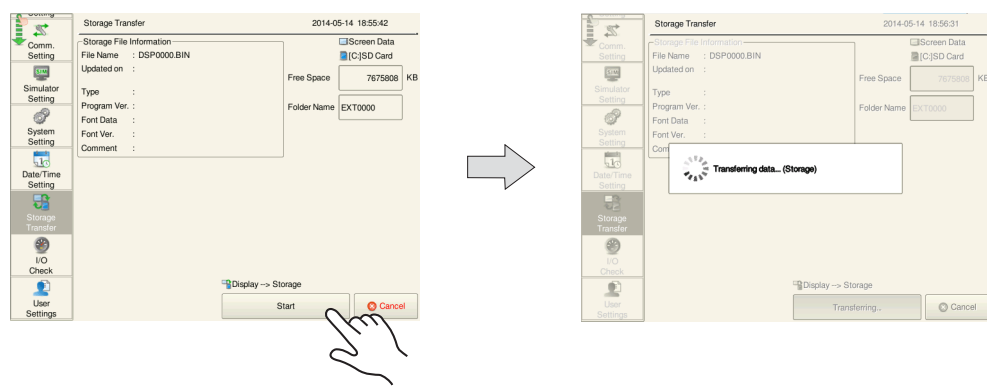

6. When the transfer is complete, [Work normally finished] is displayed. Pressing [OK] displays [Acquiring file information] and then the [Storage File Information] screen is updated.

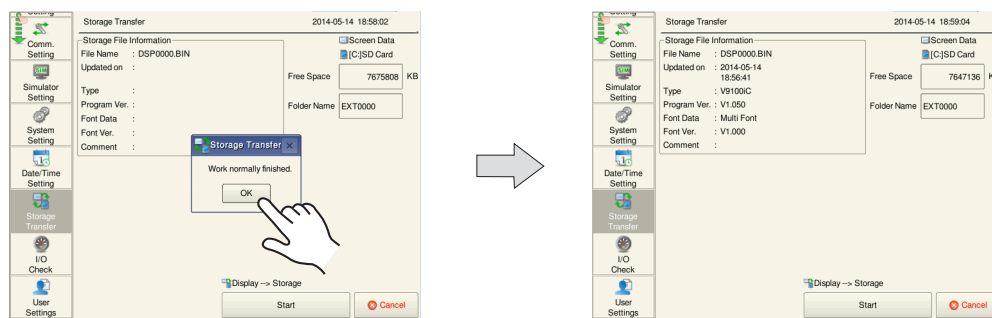

This completes the data transfer.

Converting a Storage Device File → V9 File (using storage manager)

1. Insert (or connect) the SD card into the computer.

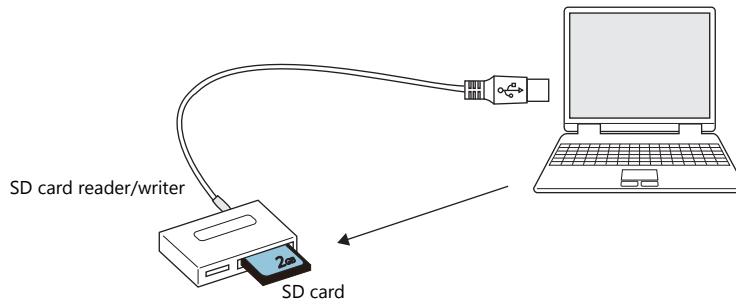

Check the drive allocation of the SD card in advance.
(In the example, H: drive is allocated as the storage device drive.)

2. In the editor, click [File] → [Storage Manager].

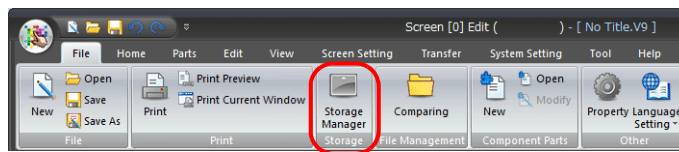

3. The window for specifying the drive is displayed.
Specify the drive that you checked in step 1. (e.g. H drive), click [OK].

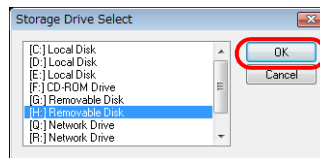

4. The [Storage Manager] tab window is displayed.

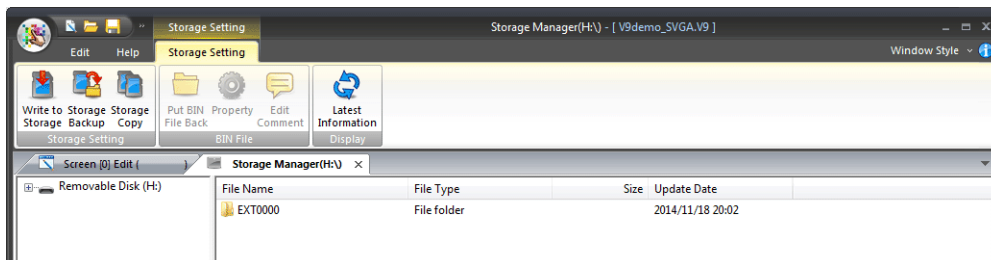

5. There is a "DSP0000.BIN" file in the [DSP] folder in the access folder.
This "DSP0000.BIN" file is the screen program file.

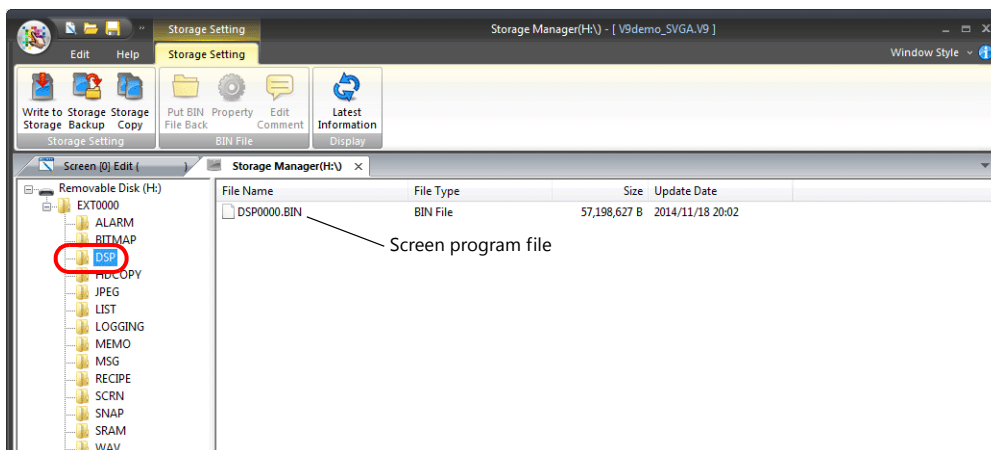

6. Select the "DSP0000.BIN" file by right-clicking and select [Put BIN File Back].

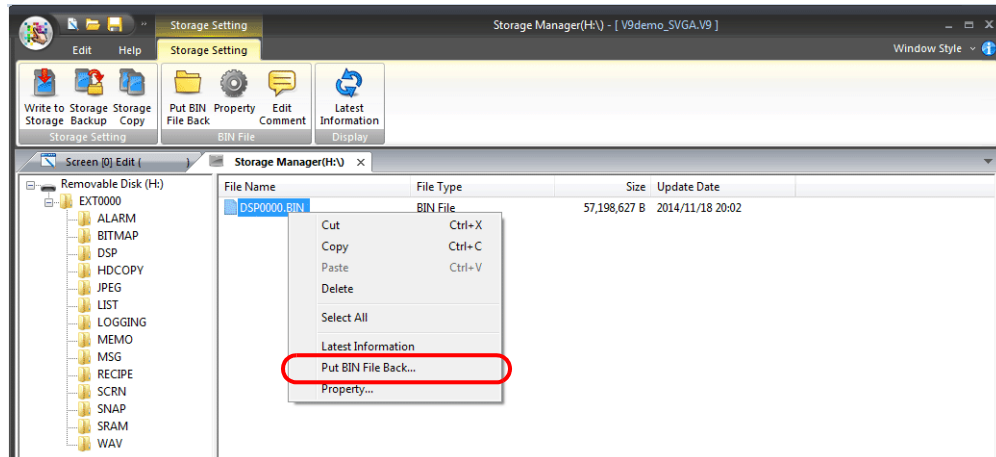

7. The [Save As] window is displayed. Specify a location and filename and save the file.

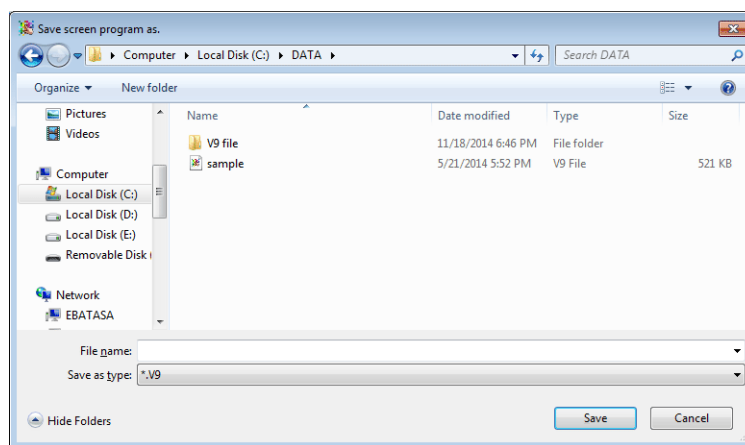

8. A V9 file is saved to the specified location.

Procedure for V9 Series Unit ↔ Storage Device Comparison

After transferring a screen program from a storage device to the V9 series unit, compare the screen program on the unit with the screen program on the storage device to confirm that the transfer was performed correctly.

This section explains the procedure when using an SD card.

1. Transfer a screen program from a storage device to the V9 series unit in advance.

 For more information on the storage device → V9 series unit transfer procedure, refer to page 7-29.

2. Switch the V9 series unit to Local mode and then press the [Storage Transfer] switch on the left-side menu. The [Storage Transfer] screen is displayed.

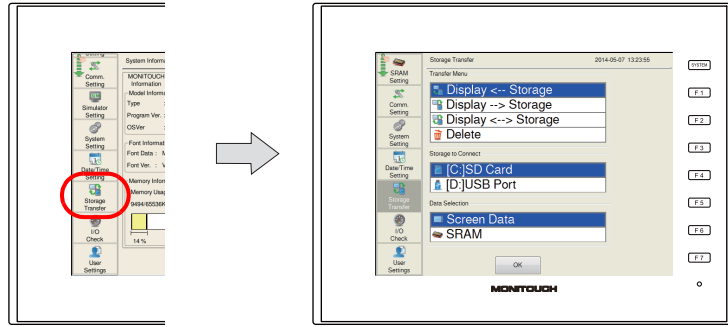

 For more information on the procedure for switching to Local mode, refer to page 7-5.

3. Select "Display ↔ Storage" for [Transfer Menu], "[C:] SD Card" for [Storage to Connect], and "Screen Data" for [Data Selection]. Press [OK].

The [Storage File Information] screen is displayed.

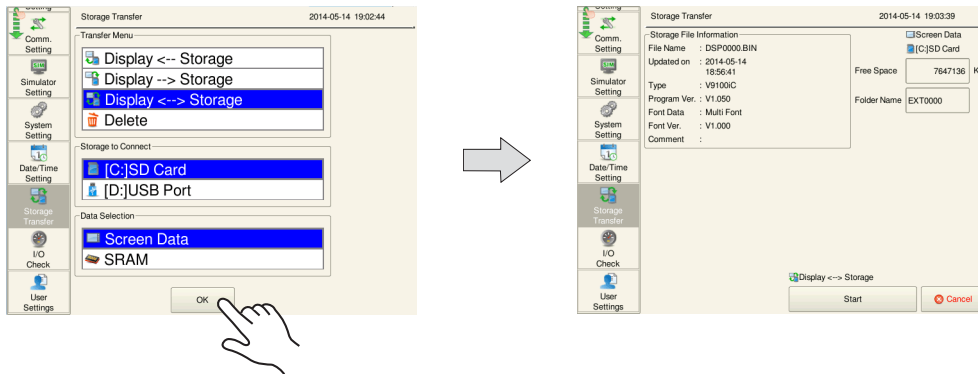

4. Press the [Start] switch. [Transferring data... (Storage)] is displayed.

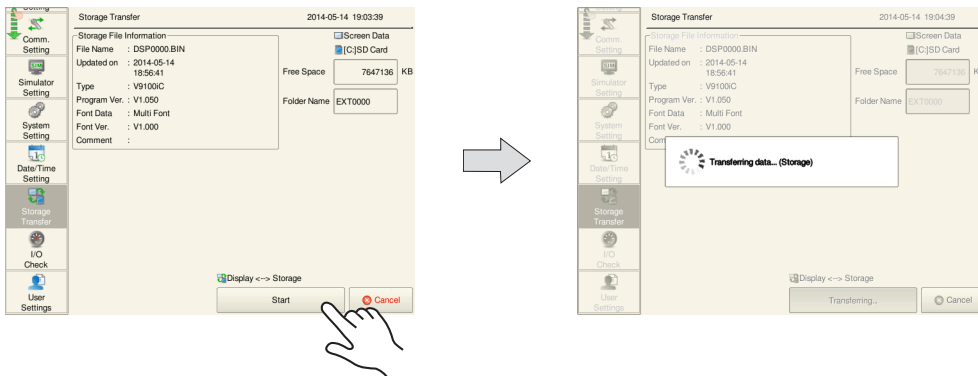

5. When the comparison completes normally, [Work normally finished] is displayed.

This completes the comparison.

7.7 Selective Transfer

Use this function when multiple operators are editing a single screen program.

A single screen program can be divided into sections under the management of an administrator and these sections can be assigned separately to operators. Each operator can then edit only his/her section and transfer the data to the V9 series unit. This leads to improved efficiency because operators do not need to consider sections undertaken by other operators.

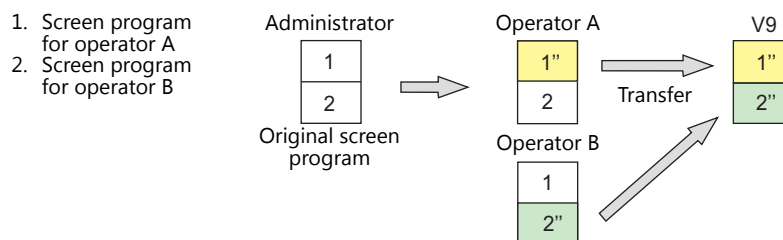

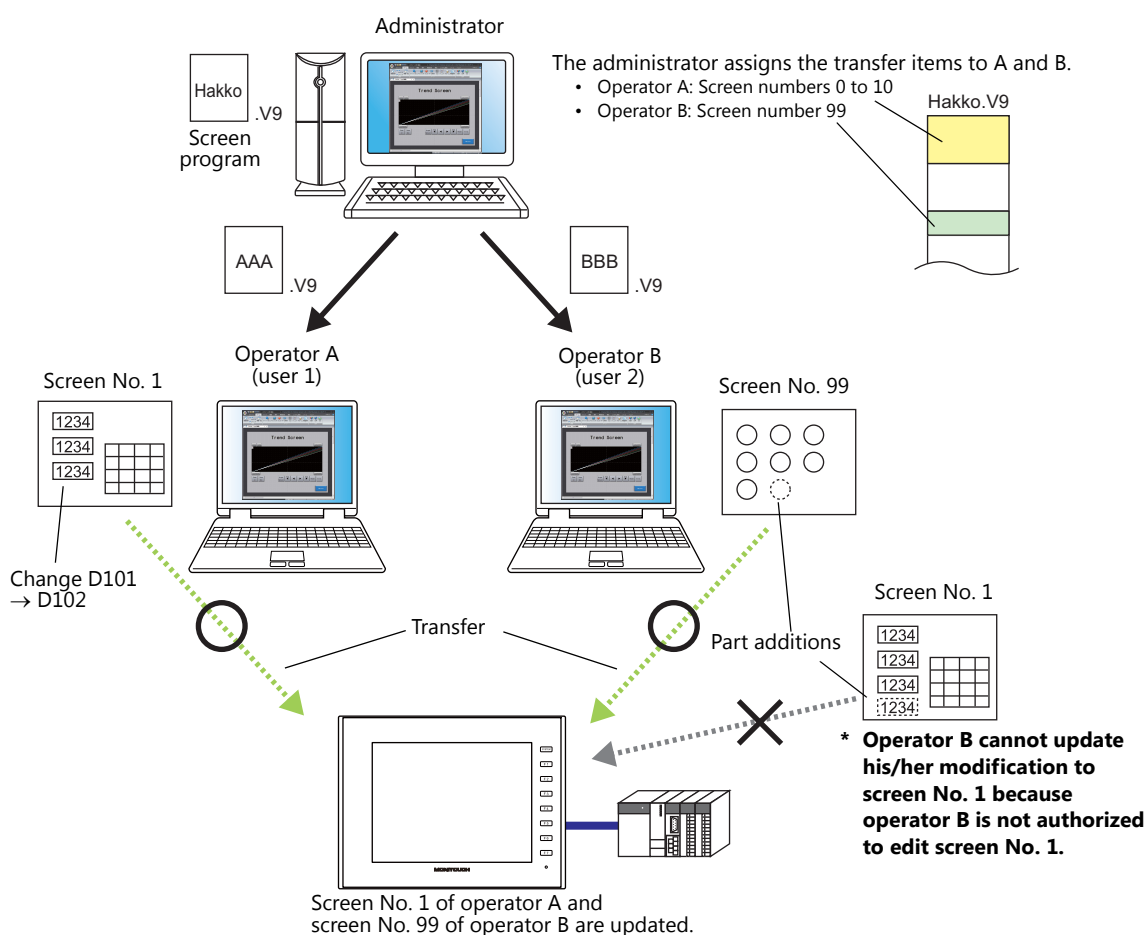

Operation Example

Original screen program: Hakko.V9
Screen program for operator A: AAA.V9 (transfer items assigned to A: screen numbers 0 to 10)
Screen program for operator B: BBB.V9 (transfer item assigned to B: screen number 99)

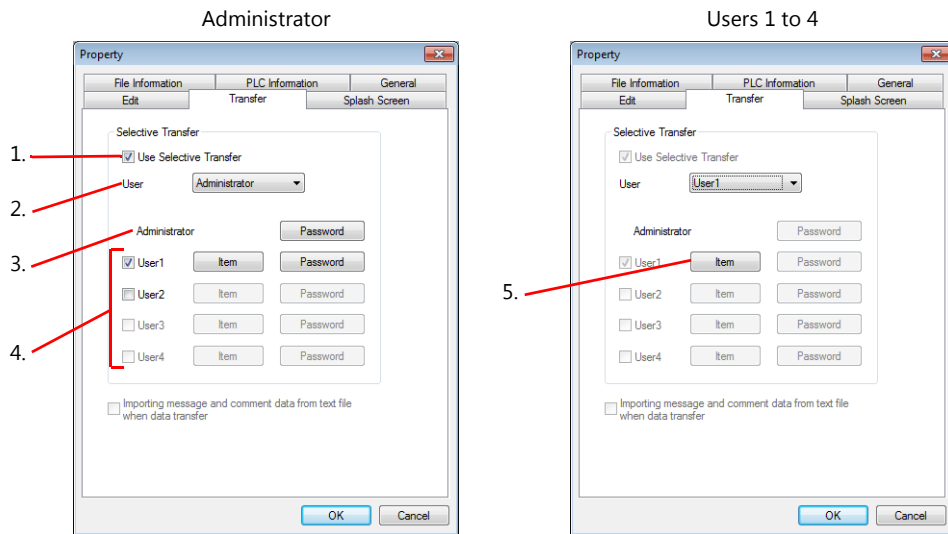

Setting Items



Item	Description																					
1. Use Selective Transfer	Select this checkbox to use the selective transfer function.																					
2. User	Set the user who undertakes screen program editing. <ul style="list-style-type: none"> Administrator The administrator assigns transfer items to users 1 through 4 and determines their passwords. The administrator can transfer the whole screen program to the V9 series unit. Users 1 to 4 Users are not permitted to change the assigned transfer items or their password. Each user may transfer only the item(s) that is/are shown with the [Item] button. 																					
3. Administrator [Password] (6 or less alphanumeric characters)	<p>An administrator-level password* can be set through this button. Switching of the [User] field can be password-protected. (No password protection is provided for switching from "Administrator" to "User" in the [User] field as detailed in the table below.) Password protection will prohibit users from changing the assigned transfer items on their own. Also when a user attempts to export a screen program from the V9 unit, he or she will be prompted to enter a password for authentication.</p>  <table border="1" data-bbox="718 1344 1369 1579"> <thead> <tr> <th>Before change</th> <th>After change</th> <th>Password</th> </tr> </thead> <tbody> <tr> <td rowspan="2">Administrator</td> <td>Users 1 to 4</td> <td>No password</td> <td>Not required</td> </tr> <tr> <td></td> <td>Password-protected</td> <td>Not required</td> </tr> <tr> <td rowspan="4">Users 1 to 4</td> <td rowspan="2">Administrator</td> <td>No password</td> <td>Not required</td> </tr> <tr> <td>Password-protected</td> <td>Required</td> </tr> <tr> <td rowspan="2">Users 1 to 4</td> <td>No password</td> <td>Not required</td> </tr> <tr> <td>Password-protected</td> <td>Required</td> </tr> </tbody> </table> <p>* For the assurance of data security, password setting is recommended. Note that once a password has been entered, it cannot be checked. Take care managing passwords.</p>	Before change	After change	Password	Administrator	Users 1 to 4	No password	Not required		Password-protected	Not required	Users 1 to 4	Administrator	No password	Not required	Password-protected	Required	Users 1 to 4	No password	Not required	Password-protected	Required
Before change	After change	Password																				
Administrator	Users 1 to 4	No password	Not required																			
		Password-protected	Not required																			
Users 1 to 4	Administrator	No password	Not required																			
		Password-protected	Required																			
	Users 1 to 4	No password	Not required																			
		Password-protected	Required																			

Item	Description
<p>4. Users 1 to 4 [Item] and [Password]</p>	<p>Use the individual buttons to assign transfer items and a password to each user. (See section 3 (above) for more information on passwords.) A maximum of four users can be set.</p> <div data-bbox="746 280 1412 929" style="border: 1px solid gray; padding: 10px;"> </div> <p>* All items other than the registration items are included in [System Setting]. The items "a." are also included in [System Setting]. Select an "a." item if you wish to transfer it independently.</p>

Setting Procedure

This section describes the usage of the selective transfer function with the following example.

- Transfer items assigned to user 1: Screen numbers 0 to 10
- Transfer items assigned to user 2: Screen number 99

Administrator settings

1. Select the [Use Selective Transfer] checkbox.

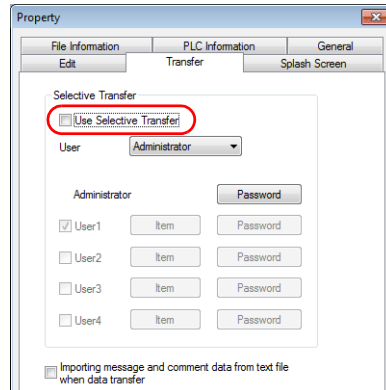

2. Select the [User 1] checkbox and click the corresponding [Item] button.

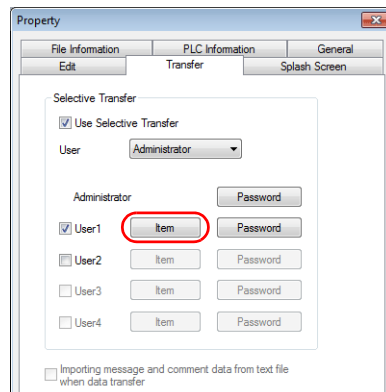

3. In the [Transfer Item Selection] window, select [Screen], specify screen numbers 0 to 10, and click [OK].

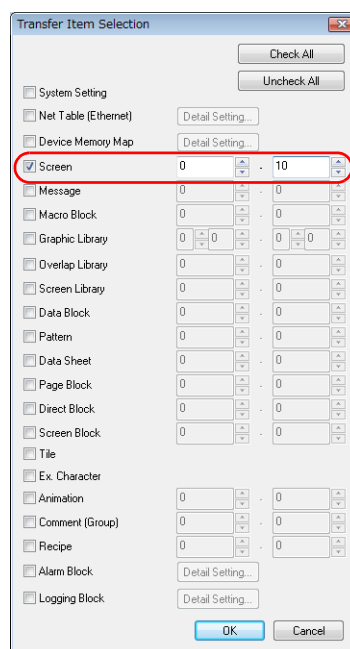

- In the [Selective Transfer] area, click the [Password] button for [User 1]. Set a password for user 1 (6 or less alphanumeric characters).

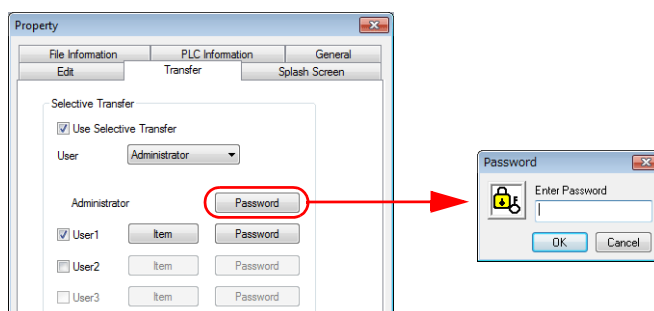

- In the [User] field, select "User 1". Click the [OK] button.

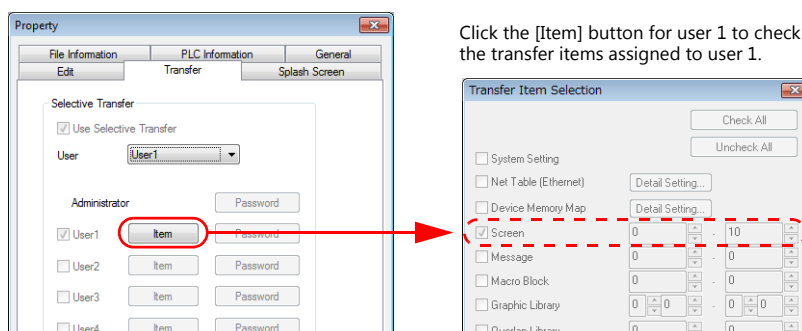

- Specify a name and save the screen program file.
This completes the user 1 settings.
- Proceed to user 2 settings.
In the [User] field, select "Administrator".
Select the [User 2] checkbox. Follow steps 2 through 6 for user 2.
- Two screen program files for users 1 and 2 are now prepared. This completes the necessary settings.
Pass these files to the individual users.

Settings for users 1 to 4

This section describes how user 1, for example, performs a selective transfer.

- Open the screen program file for user 1.
Click [File] → [Property] → [Transfer] tab to display the selective transfer settings.
Review the user number selected in the [User] field. (Example: "User 1")

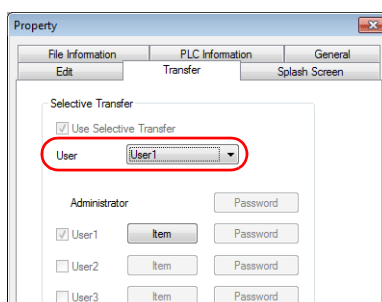

- Press the [Item] button. The [Transfer Item Selection] window is displayed.
Review the transfer items assigned to user 1. (Example: Screen numbers 0 to 10)

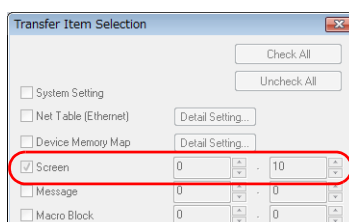

- Edit these screens and transfer the screen program to the V9 series unit.
* **Even if modifications are made to any item outside the range assigned, the modified data will not be transferred to the V9 series unit.**

PC <- V9 series unit transfer

When password protection is set, the following confirmation dialog box is displayed before transferring a screen program from the V9 series unit.

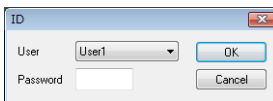

Item	Description
User	The screen program is transferred from the V9 series unit under the name of the user selected in this field. The default shown in this field is the user who performed screen program transfer to the V9 series unit most recently.
Password	Enter the password assigned to the user selected in the [User] field.

Notes

- The administrator should take care not to assign the same item to multiple users in the [Transfer Item Selection] window.
- Only the administrator is allowed to edit the Windows fonts registered with text.
- Tags cannot be transferred by the selective transfer function.
- Only the user, for whom the [System Setting] checkbox is selected in the [Transfer Item Selection] window, is allowed to change the number of interface languages in the [Font Setting] window and to transfer the I/F driver data for the simulator.
- If a screen includes a component part, the relevant memory table and text table will be transferred together with the screen to the V9 series unit. In the [Transfer Item Selection] window, it is recommended that the item [Buffering Area] or [Device Memory Map] be selected if either one is used.
- Screen program transfer is executable via a serial port, USB port, or Ethernet port. However, transfer via a storage device is not supported.
Transfer from the V9 series unit to a storage device is supported. Note that the [ID] dialog box that appears before the export of data from the V9 series unit shows the user who transferred data to the V9 series unit most recently. Therefore, change the [User] field in the [ID] dialog box to the name of who attempts to export data from the V9 series unit.
(If you wish to prohibit data export from the V9 series unit to a storage device, configure a password at [System Setting] → [Storage Setting] → [Password]. For more information, refer to V9 Series Reference Manual 2.
- If passwords are set in both the [File Information] tab window and the [Selective Transfer] tab window ([File] → [Property]), you will be requested to enter the password set in the [File Information] tab window first and then will be prompted to enter the password set in the [Selective Transfer] tab window.
- Before any user transfers his/her screen program, the administrator must transfer the entire screen program with the selective transfer function configured to the V9 series unit in advance. If the screen program in the V9 series unit is not configured with the selective transfer function, it may become overwritten in a way not intended.

7.8 Message/Comment Transfer

If it is necessary to display, for example, different unit names on alarm messages depending on the situation while using the same screen program, the message/comment transfer function can be used to transfer a text file for messages only. Messages can easily be edited in text format.

Operation Example

When changing alarm messages in message GNo. 0 :
 Original screen program: Hakko.V9
 Text file: MSG00000.txt (Language 1, message GNo. 0)

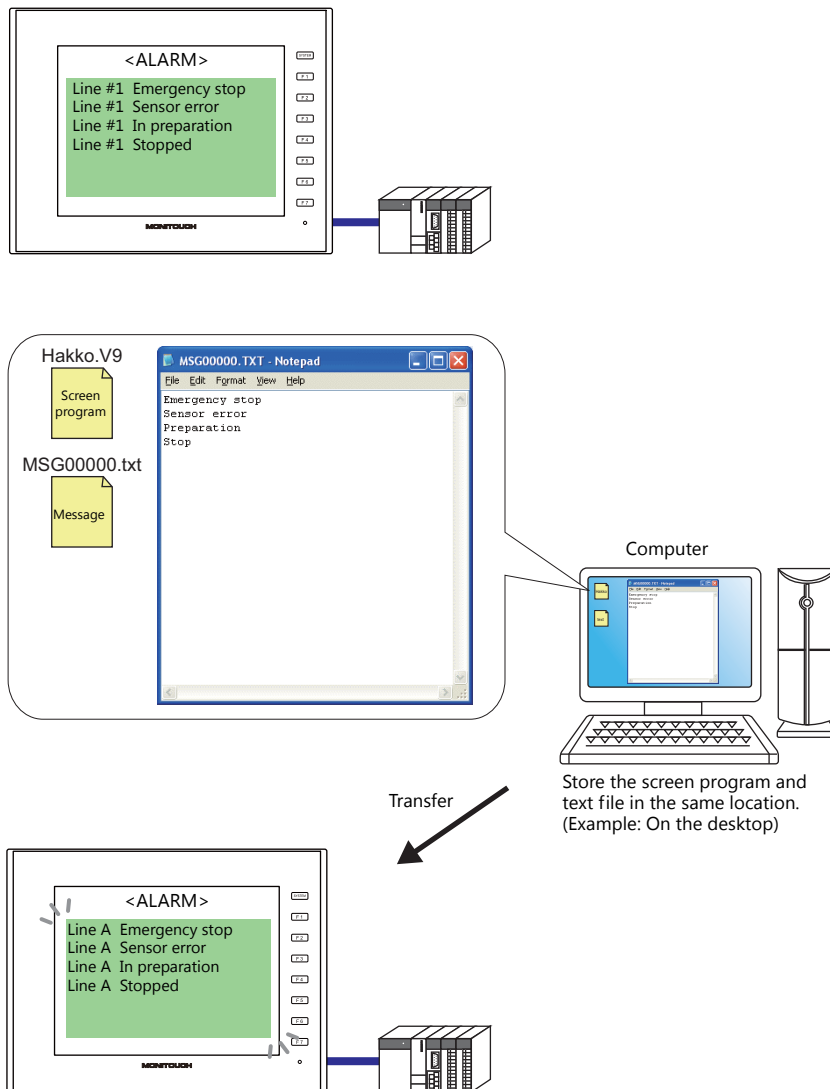

* Messages can also be changed by saving them in text format on a storage device.
 For more information, refer to V9 Series Reference Manual 2.
 (Comments cannot be changed in this way.)

Target Items

- [Registration Item] → [Message]
- [Registration Item] → [Comment]

Location of Settings

Select the [Importing message and comment data from text file when data transfer] checkbox located at [File] → [Property] → [Transfer] tab.

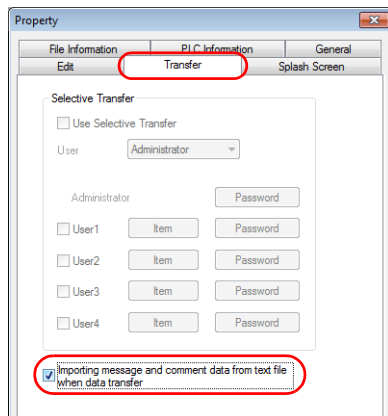

Setting Procedure

Message

The section explains the case where messages in message GNo. 0 of Language 1 are changed.

1. Start up Notepad.

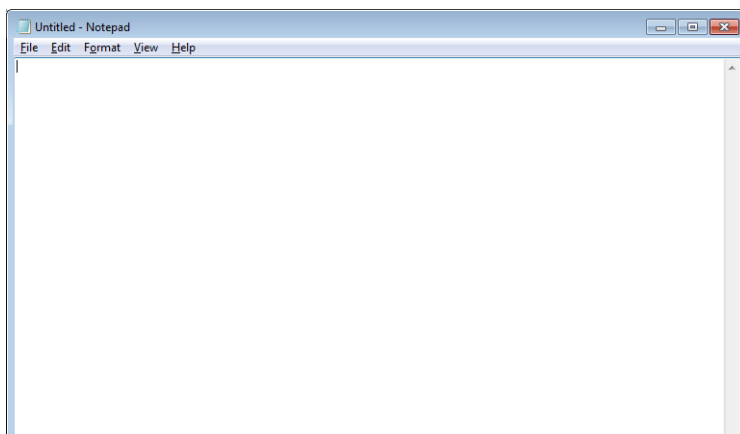

2. Register messages in order from the top.

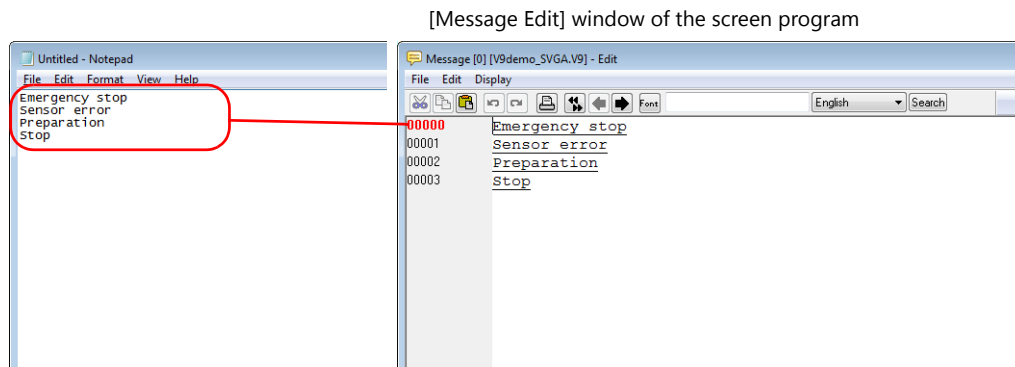

- * A maximum of 127 one-byte (63 two-byte) characters per line and a maximum of 256 lines can be registered. All of the 256 lines are transferred. Note that character properties are not transferred.

3. Click [File] → [Save As].

Be sure to select the same location where the screen program "*.V9" is saved. (Example: C:\DATA\V9 file)

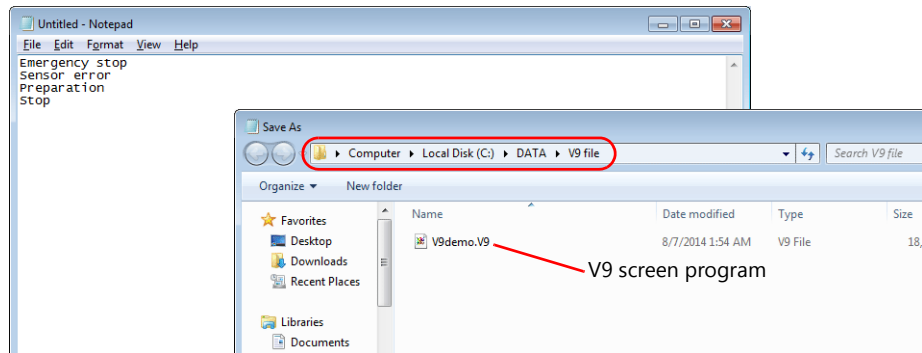

4. Name the file in the format shown below and save it.

MSGxyyy.txt

Message GNo.: 000 to 127

Language numbers: 00 to 15 (Language 1 to 16)

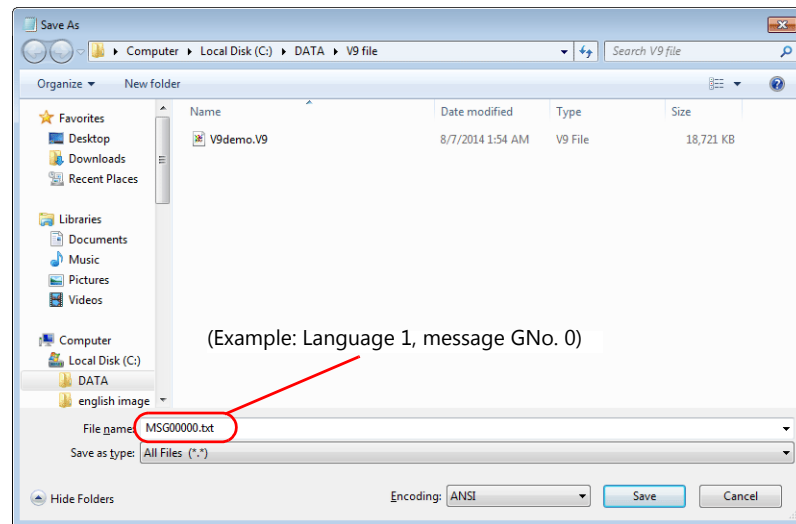

5. Check that the screen program and the text file are saved in the same location. (Example: C:\DATA\V9 file)

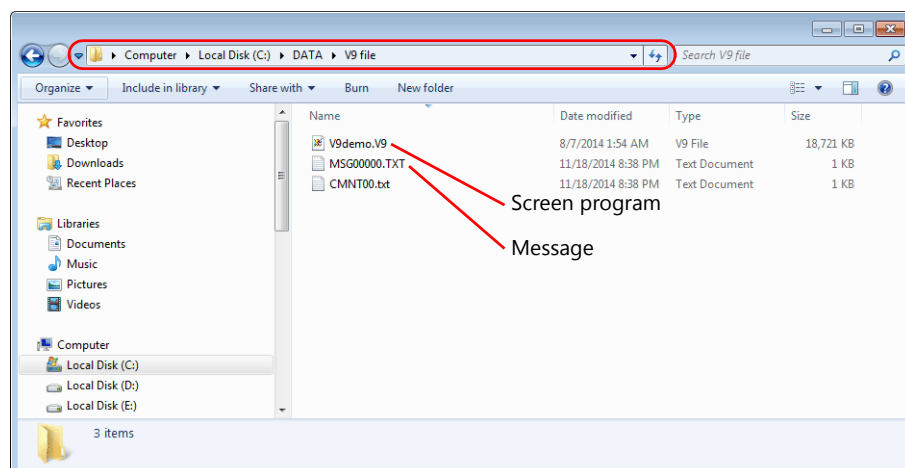

- Start V-SFT and click [Transfer] → [Download].
Click [PC ->].

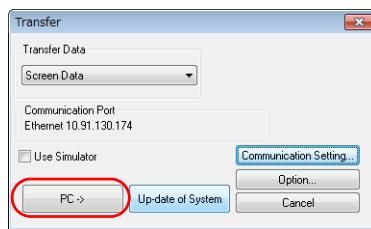

- Select the screen program. (Example: Hakko.V9)



- Transfer of the screen program and text file starts.
Transfer has been completed.

Comment

The section explains the case where comments of Language 1 are changed.

- Open a screen program. (Example: Hakko.V9)
- Open the [Comment Edit] window by clicking [Registration Item] → [Comment].

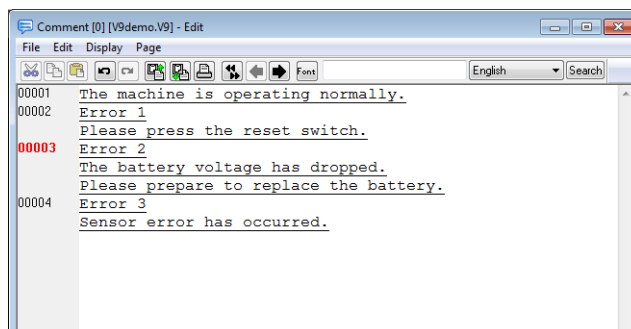

- Click [File] → [Export]. The [Save As] window is displayed.
Be sure to select the same location where the screen program "*.V9" is saved. (Example: C:\DATA\V9 file)

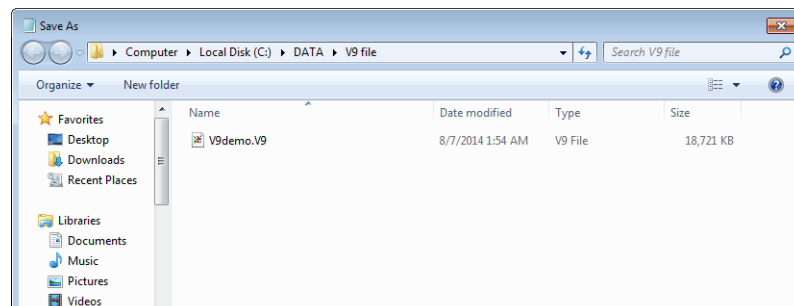

* In multi-language editing, select the language number currently edited.

4. Select [Text File (*.txt)] for [Save as type], create a filename in the following format, and save the file.

CMNTxx.txt

Language No.: 00 to 15 (Language 1 to 16)

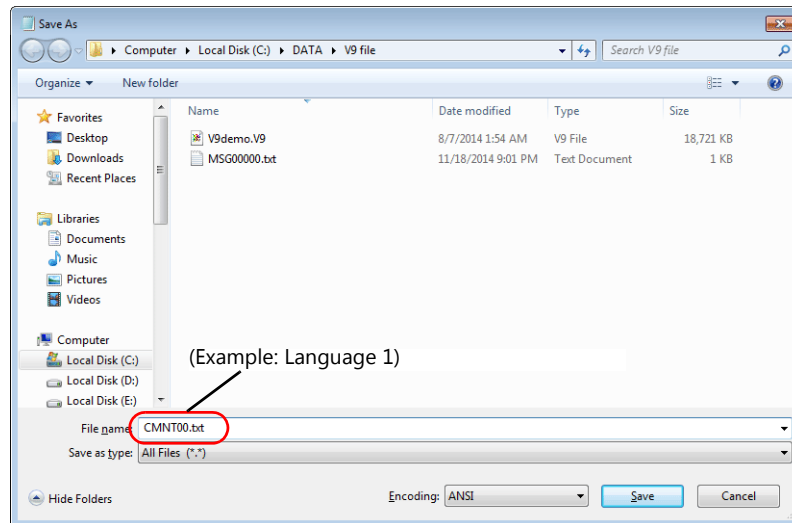

5. Check that the screen program and the text file are saved in the same location.

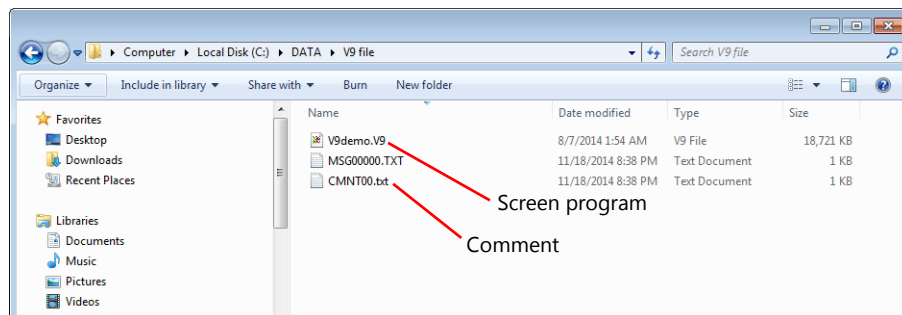

6. Open the text file in Notepad. (Example: CMNT00.txt)
Edit a comment in double-quotations.

Comment number: //(1 - 32767)
Comment text: "(text)"
Multiple lines: Carriage return

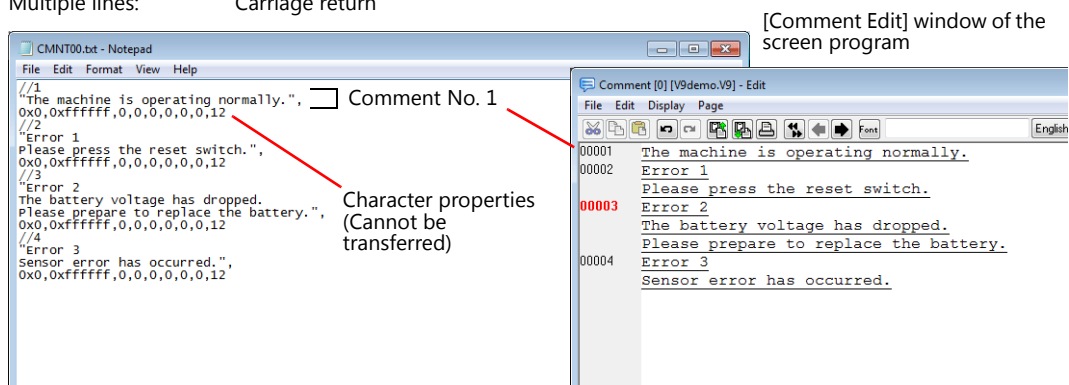

- * A maximum of 127 one-byte (63 two-byte) characters can be registered per line.
A maximum of 32767 comments (32 lines, 1024 one-byte characters per comment) can be registered.
Note that character properties are not transferred.

7. Click [File] → [Save].

8. Start V-SFT and click [Transfer] → [Download].
Click [PC ->].

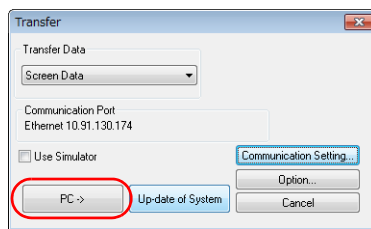

9. Select the screen program. (Example: Hakko.V9)



10. Transfer of the screen program and comment file starts.
Transfer has been completed.

Notes

- When a text file is transferred with the screen program that includes a blank line or comment for which Windows font properties are set, properties set for the blank line or comment will be deleted.

Example: Message editing

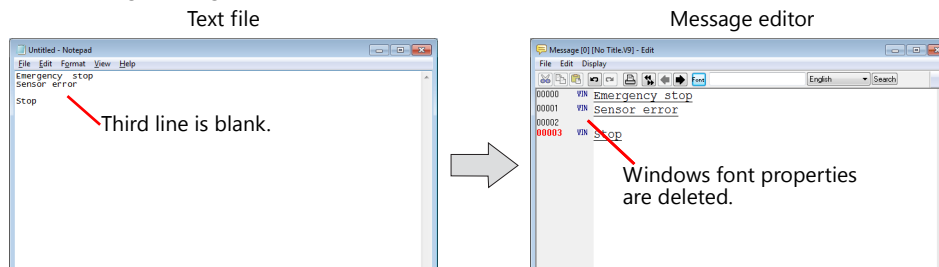

- Unicode text cannot be used. Accordingly, when a file saved in Unicode text format is transferred, text will not be displayed correctly.
- The selective transfer function cannot be used when the message/comment transfer function is used.
- After transfer with the message/comment transfer function from the computer to the V9 series unit, the screen program on the computer remains the same as before. The screen program to which changes are updated must be exported from the V9 series unit to the computer.

8 Simulation

8.1 Simulator

8.2 Emulator

8.1 Simulator

8.1.1 Overview

Screen program operation on the V9 series unit is usually confirmed using a connection to a PLC. However, it is possible to perform an operation check without the PLC using the simulator function. The simulator runs on Windows and it is possible to set/reset bit device memory as well as input data into word device memory.

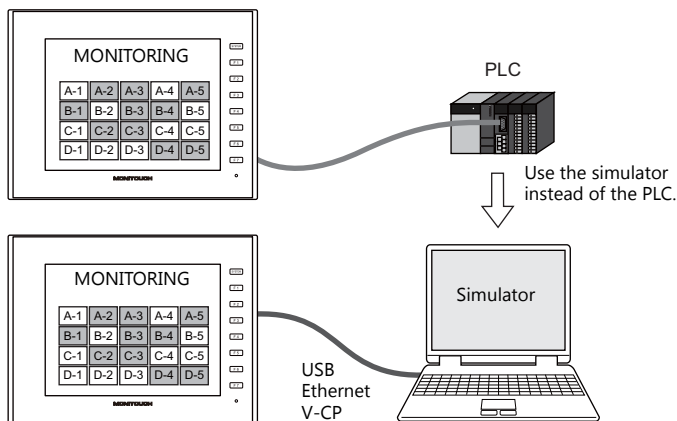

If the operation is simple, it can be checked on the simulator as if using a PLC.

 If a V9 series unit isn't available either, operation of created screens can be checked using the emulator. For more information, refer to page 8-23.

- * **The simulator can be used for 1:1 connections between the V9 series unit and a connected device. The simulator cannot be used for 1:n and n:1 connections.**
- * **The simulator is also disabled where a connection is established with a barcode reader or the V9 series unit and its connected device are in slave communication mode (V-Link or MODBUS slave).**

Communication with a maximum of 8 kinds of external devices, such as PLCs (8-way communication), is possible. The simulator can also be run for a maximum of 8 kinds of devices. For example, the simulator may be run only for two of the eight kinds of devices, and the remaining devices may be actually connected to MONITOUCH for operation check.

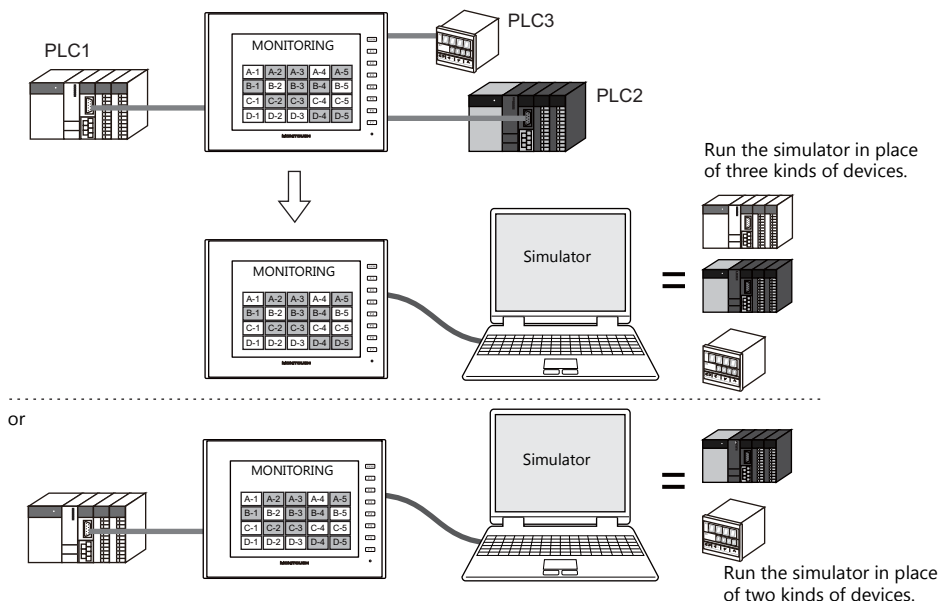

As the simulator can be started together with the V-SFT editor (configuration software for the V series), operation can be checked easily during screen editing.

The operation of the parts placed on the screen can be checked between just the computer and the V series. Therefore, both screen creation and debugging become possible on one computer and time can be saved.

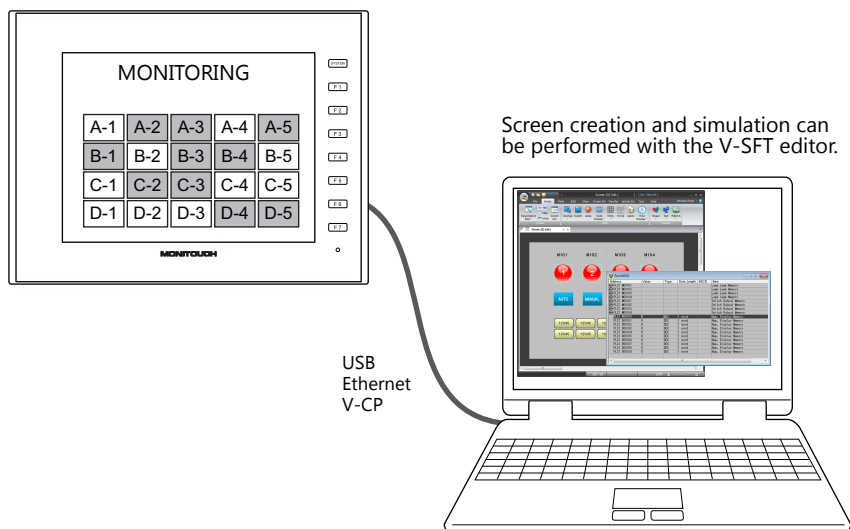

Based on the device memory assigned to the screen program of the V series, simulation sheets are automatically created on a screen basis.

8.1.2 Operating Procedure

1. Open a screen program file.
2. Establish a connection between the computer and V9 series unit (page 8-3).
3. Transfer the screen program and simulator program
 - Screen program transfer (page 8-4)
 - V9 series unit settings (page 8-5)
4. Start and quit the simulator (page 8-7)
5. Start and stop communication
 - Starting communication (page 8-8)
 - Stopping communication (page 8-8)
 - Communication settings (page 8-9)
6. Perform a test.
 - Testing bit access device memory (page 8-19)
 - Testing word access device memory (page 8-21)

8.1.3 Establishing a Connection Between the Computer and V9 Series Unit

Via USB

Connect the V9 series unit to the computer using a USB cable.
Be sure to connect the cable to the USB mini-B port of the V9 series unit.

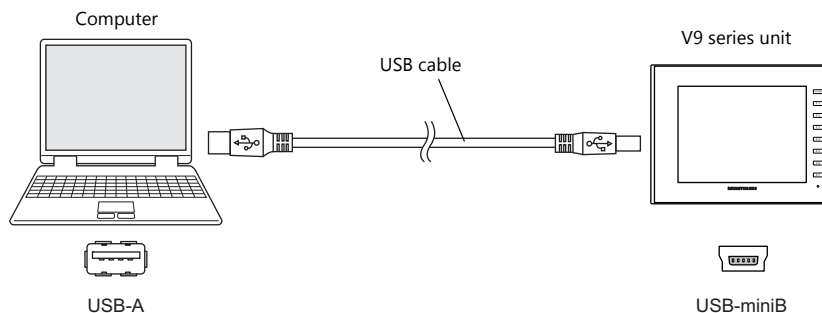

Via Ethernet

Connect the V9 series unit to the computer using a LAN cable.
Be sure to connect the cable to the LAN port of the V9 series unit.

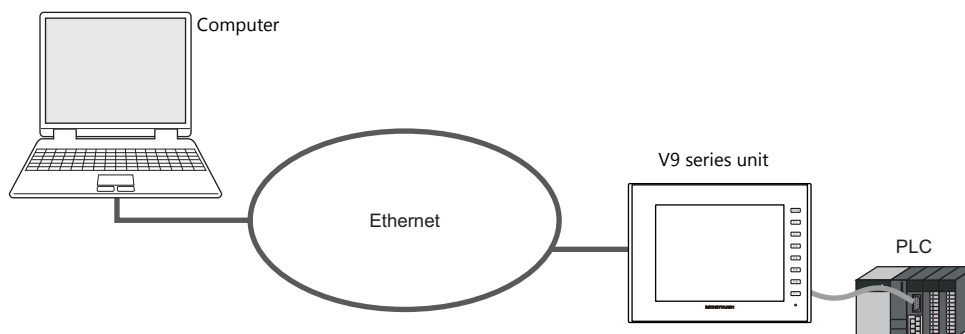

Via V-CP

Connect the V9 series unit to the computer using the data transfer cable (V-CP).

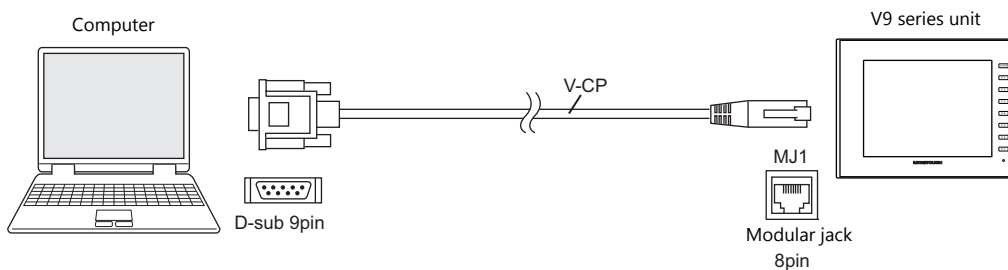

Use MJ1 (modular jack 1) on the V9 series unit.
On the editor software, check that [MJ1] shows [No connection].

* **Whether [MJ1] shows [No connection] can be checked via [System Setting] → [Hardware Setting].**

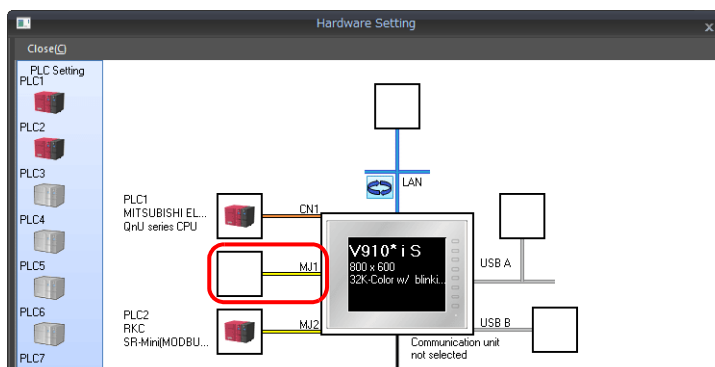

8.1.4 Screen Program and Simulator Program Transfer

Transfer the screen program and the simulator program to the V9 series unit.

A driver file will automatically be transferred to the V9 series unit according to the connection format: "UniPLC_S.tpc" file for serial communication via V-CP, "UniPLC_E.tpc" file for a connection via Ethernet, or "UniPLC_U.tpc" file for a connection via USB.

😊 What is the simulator program?
The simulator program is a driver file that the V9 series unit requires to use the simulator.
The driver files are:

Filename	Communication Type	Display on Unit *
UniPLC_U.tpd	USB	USB-B (Device)
UniPLC_E.tpd	Ethernet	Ethernet (UDP)
UniPLC_S.tpd	Serial (with V-CP)	MJ1 (Serial)

* Check the display on the V9 series unit by pressing the [Simulator] switch in Local mode.
For more information, refer to page 8-5.

Screen Program Transfer

Follow the steps below to transfer the screen program.

1. Click [Transfer] → [Download].

The [Transfer] window for downloading is displayed.

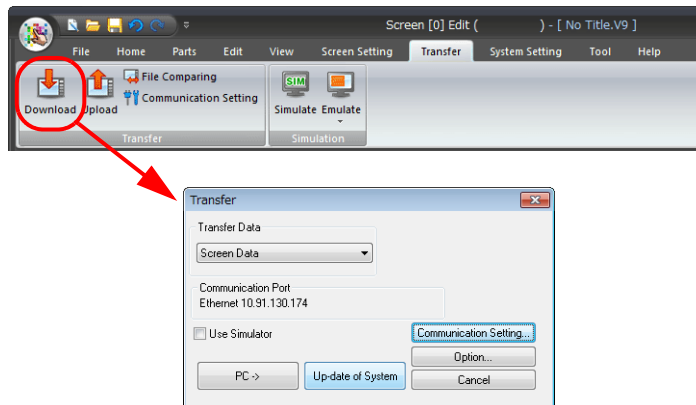

2. Select the [Use Simulator] checkbox.

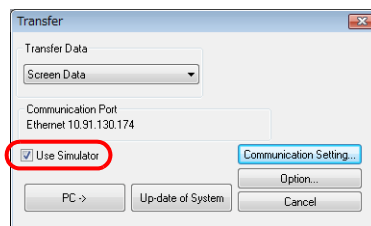

😊 For more information on other setting items, such as the [Communication Setting] button, refer to "7 Transfer".

3. Set [Transfer Data] to [Screen Data] and click the [PC ->] button.

The screen program is transferred together with the simulator program.

😊 To transfer the simulator program independently, select [Simulator Program] for [Transfer Data] and click the [PC->] button. In the file selection window that appears, select the driver file and execute transfer.

V9 Series Unit Settings

When using the simulator, always configure the V9 series unit to [Simulator] instead of [Actual Machine] (other devices). Follow the procedure described below.

1. After transferring the screen program, display the [Simulator Setting] screen in Local mode.



For more information on the procedure for switching to Local mode, refer to page 7-5.

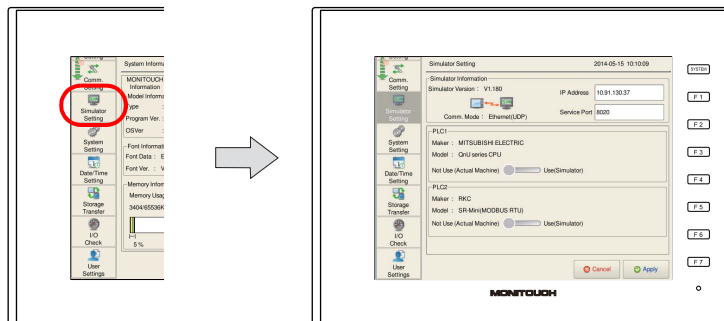

* If [Simulator Setting] is not displayed on the menu, the screen program may not have been transferred with the [Use Simulator] checkbox selected or screen program transfer did not finish normally. Check the relevant settings and resend the screen program.

2. Check that the information displayed in the [Simulator Information] area matches the actual communication format configured between the V9 series unit and the computer.

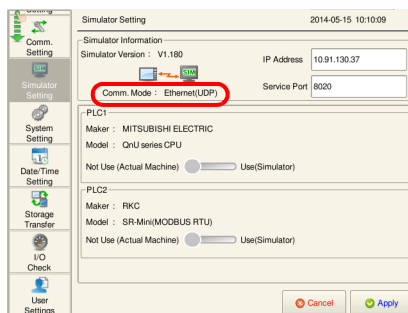

Communication Type	Description
USB-B (Device)	The simulator is run while a connection is established between the USB mini-B port of the V9 series unit and a USB-A port of the computer with a USB cable.
Ethernet (UDP)	The simulator is run while a connection is established between the LAN port of the V9 series unit and the computer with a LAN cable.
MJ1 (Serial)	The simulator is run while a connection is established between MJ1 (modular jack 1) of the V9 series unit and the computer with a V-CP cable.

3. If [Comm. Mode] is set to [Ethernet (UDP)], set values for [IP Address] and [Service Port].
If [Comm. Mode] is set to [MJ1 (Serial)] or [USB-B (Device)], proceed to step 4.

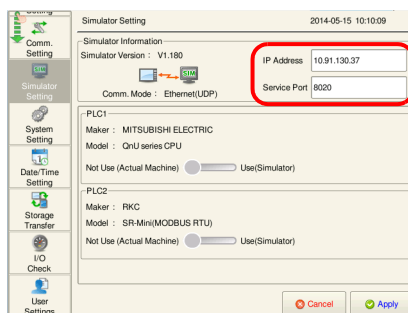

Setting Item	Description
IP Address	Set the IP address of the connected computer. Press on the item to display a keyboard and enter an IP address.
Service Port	Set the port number for the simulator. Press on the item to display a keyboard and enter a port number. This port number must match the port number set at [File] → [Communication Setting] → [Port No.] of the simulator window. The default setting is "8020".



- Select which devices the simulator is used as a substitute for.

Device names corresponding to the logical ports of PLC 1 to PLC 8 are displayed, each of which is provided with a [Use (Simulator)]/[Not Use (Actual Machine)] switch. Set the switch to [Use (Simulator)] for the devices to check using the simulator.

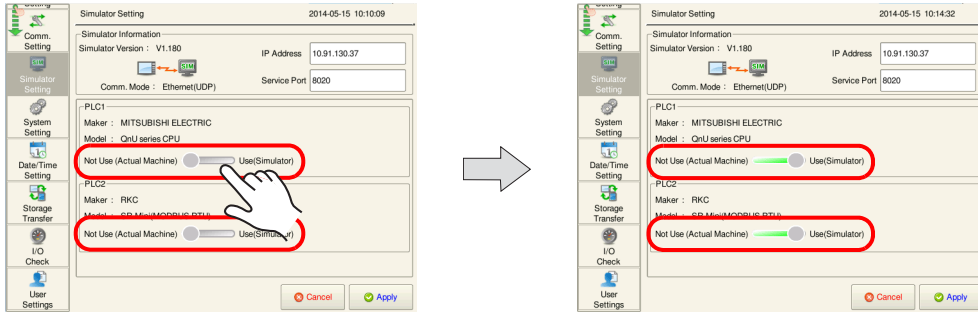

When running the simulator for PLC 1 and PLC 2, for example, set the switch for both of these to [Use (Simulator)].



When not using the simulator, set the relevant switches to [Not Use (Actual Machine)]. Resending the screen program is not necessary.

- Press the [Apply] switch.

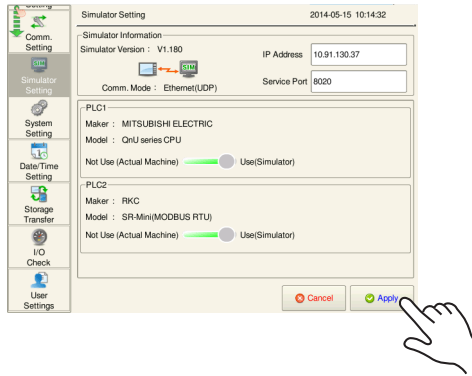

8.1.5 Starting and Quitting the Simulator

Startup

1. Click [Transfer] → [Simulate].

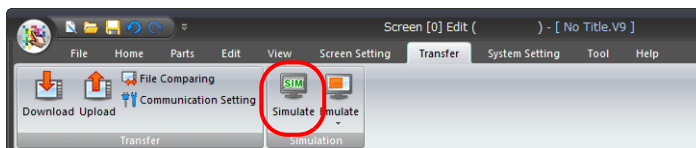

2. The simulator starts up.
Communication with the V9 series unit starts at this time.
Also, the addresses associated with the screen program currently open in the editor are automatically displayed on a sheet in the simulator.

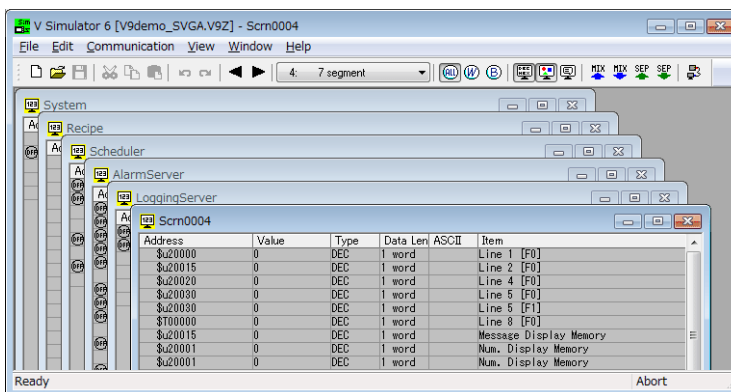

If the V9 series unit is in Local mode, press the [SYSTEM] switch and the [F1] switch to switch to RUN mode. The simulator starts communications with the V9 series unit.

Quitting

1. In the simulator window, click [File] → [Exit] or click the [Close] button.

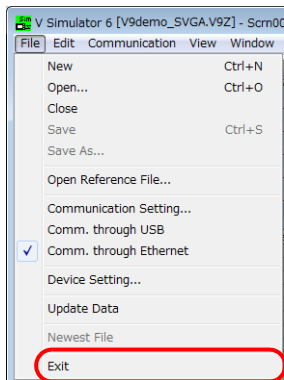

or

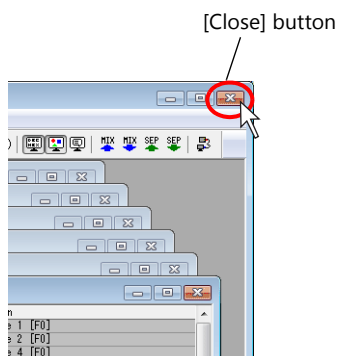

2. The simulator window closes.
At the same time, the simulator terminates communication with the V9 series unit and "Communication Error: Simulator: Time-Out" appears on the V9 series unit.

8.1.6 Starting and Stopping Communication

Starting Communication

Communication using the simulator starts when the [Simulator] window opens. The communication status is shown by the [Communication] icon and the status display at the bottom of the window.

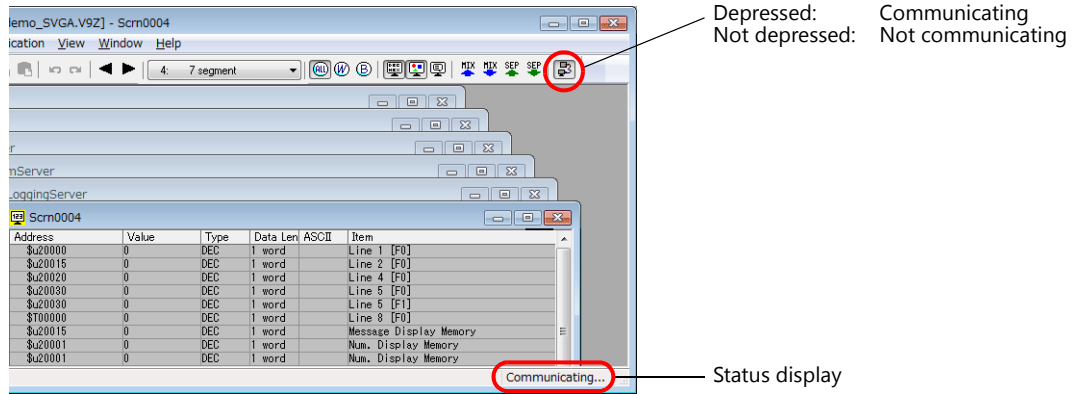

Stopping Communication

Click the [Communication] icon to make it not depressed (communication stopped).

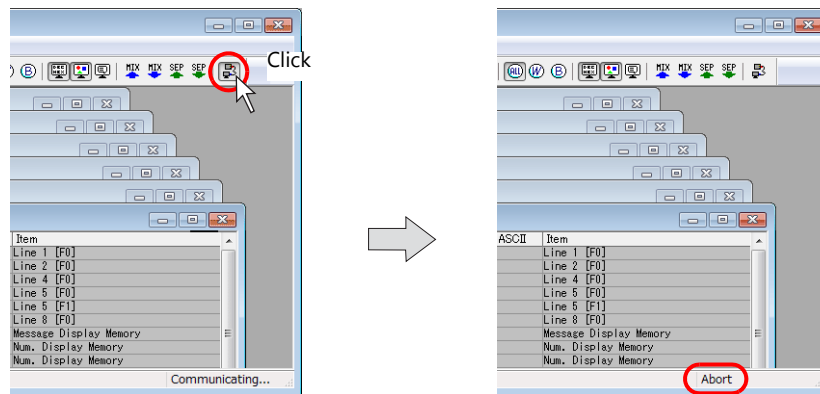

☹️ "Communication Error: Simulator: Time-Out" appears on the V9 series unit.

Communication Settings

Configure the required settings for communication between the computer and the V9 series unit. If the settings are incorrect, the V9 series unit and computer will not communicate correctly. In such an event, be sure to check the settings.

*** Before checking the communication settings, suspend communication between devices.**

Via USB

Click [File] in the simulator window.

Check that [Comm. through USB] has a check mark. This completes the required settings.

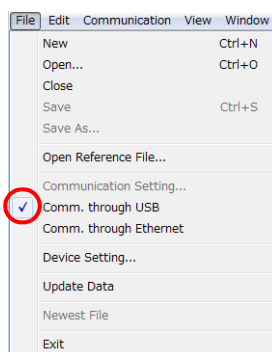

Via Ethernet

1. Click [File] in the simulator window.

Check that [Comm. through Ethernet] has a check mark, and then click [Communication Setting].

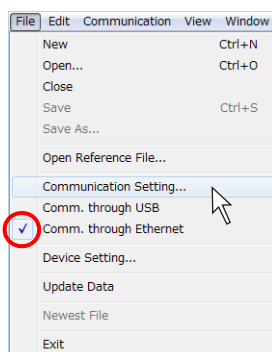

2. The [Port No.] window is displayed.

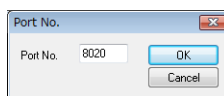

Item	Description
Port No. 1024 to 65535	The default is "8020". If you have changed this port number, make the same change to the port number on the V9 series unit. When connecting the simulator to multiple V9 series units from a single computer, use a different port number for each V9 series unit.

Via serial communication

1. Click [File] in the simulator window.
Check that [Comm. through USB] and [Comm. through Ethernet] do not have a check mark and then click [Communication Setting].

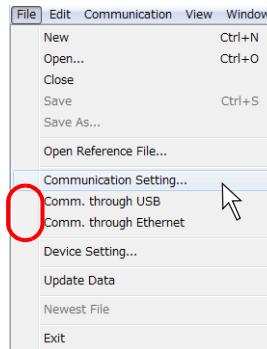

2. The [Communication Setting] window is displayed.

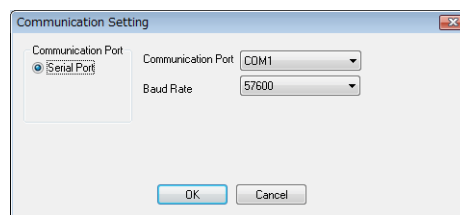

Item	Description
Communication Port	Serial Port
Communication Port COM1 to 256	Select a communication port number for RS-232C of the computer.
Baud Rate	Set a baud rate used between the V9 series unit and the computer. (This has no relation to the actual communication baud rate between the V9 series unit and actual PLCs.)

8.1.7 Structure of the [Simulator] Window

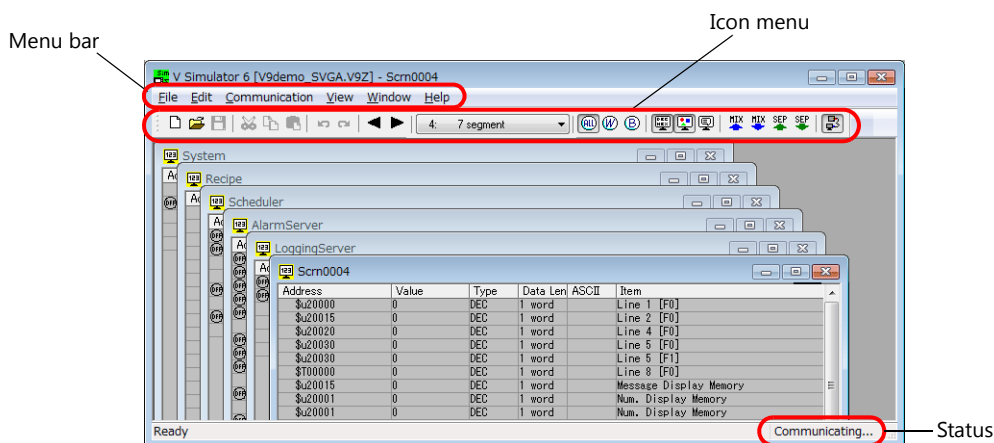

Item	Description
Menu bar	For more information, refer to page 8-12.
Icon menu	For more information, refer to page 8-14.
Sheets	
System	Displays a list of addresses used for system settings of the screen program file.
Scrnxxxx	Displays a list of addresses used on each screen.
Recipe	Displays a list of addresses used by recipes.
Scheduler	Displays a list of addresses used by schedulers.
AlarmServer	Displays a list of addresses used by alarm servers.
LoggingServer	Displays a list of addresses used by logging servers.
Scrnxxx_x	Displays a list of addresses used on normal overlap displays. These are displayed when the corresponding normal overlap is displayed.
Mlibx_xxxx Mlibxxxx	Displays a list of addresses used on each overlap library. <ul style="list-style-type: none"> Mlibx_xxxx: These are displayed when the corresponding multi-overlap or global overlay is displayed. Mlibxxxx: These are displayed when the corresponding call overlap is displayed.
Untitled	Displays newly registered addresses. For more information on registering new addresses, refer to page 8-17.
Status display	Displays the current status of the simulator (communicating or interrupted).

Menu Bar

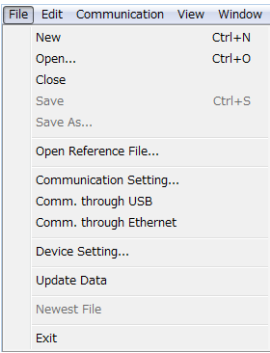

File

Item	Description
 New	Create a new [Untitled] sheet.
Open	Open an existing screen program file (*.V9) or device memory table file (*.sim).
Close	Close an open sheet.
Save	Save an open sheet.
Save As	Save an open sheet under a different name.
Open Reference File	Open a screen program data file (*.V9" for example) for the simulator to refer to.
Communication Setting	Configure settings related to serial and Ethernet communication. (Refer to page 8-9.)
Comm. through USB	This menu item automatically displays a check mark when communication via USB takes place.
Comm. through Ethernet	This menu item automatically displays a check mark when communication via Ethernet takes place.
Device Setting	Specify the range of device memory addresses to be used by the simulator.
Update Data	If changes have been made to the source screen program for simulation, clicking this menu item updates the screen program displayed on the simulator.
Exit	Exit the simulator. (Refer to page 8-7.)

Edit

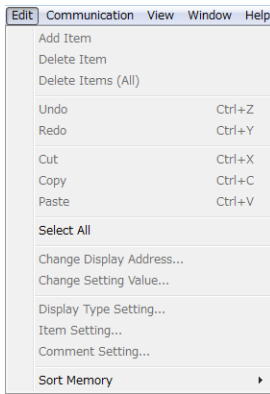
Item	Description
 Add Item	This command is available for the [Untitled] sheet. Add a new address.
Delete Item	This command is available for the [Untitled] sheet. Delete an address.
Delete Items (All)	This command is available for the [Untitled] sheet. Delete all addresses.
Undo	Cancel the previous action.
Redo	Revert to the state prior to undo.
Cut	This command is available for the [Untitled] sheet. Cut any selected addresses.
Copy	Copy any selected addresses.
Paste	This command is available for the [Untitled] sheet. Paste any copied or cut addresses.
Select All	Select all addresses on the sheet.
Change Display Address	This command is available for the [Untitled] sheet. Change the selected address to another address.
Change Setting Value	Change the value of the selected address.
Display Type Setting	Change the display format of the selected address.
Item Setting	This command is available for the [Untitled] sheet. Set items for the selected addresses.
Comment Setting	This command is available for the [Untitled] sheet. Set comments for the selected addresses.
Sort Memory	Select the device memory display method.

Communication

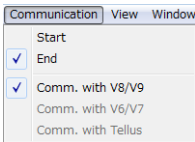
Item	Description	
	Start	Start communication.
	End	End communication.
	Comm. with V8/V9	This menu item automatically displays a check mark when communication with a V8 or V9 series unit takes place.
	Comm. with V6/V7	This menu item automatically displays a check mark when communication with a V6 or V7 series unit takes place.
	Comm. with Tellus	This menu item automatically displays a check mark when communication with TELLUS takes place.

View

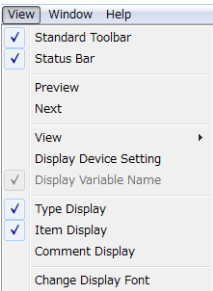
Item	Description	
	Standard Toolbar	The toolbar is displayed when this menu item shows a check mark.
	Status Bar	The status bar is displayed when this menu item shows a check mark.
	Preview	This command is available for [Scrn xxxx] sheets. Display the previous screen.
	Next	This command is available for [Scrn xxxx] sheets. Display the next screen.
	View	Select from the following device memory types to display. All device memory/word device memory only/bit device memory only
	Display Device Setting	Select which PLC addresses of PLC 1 to PLC 8 are displayed.
	Display Variable Name	This setting is available when connected to the Fuji Electric's MICREX-SX series and using the variable name cooperation function. Display variable names.
	Type Display	Display [Type], [Data Length], and [ASCII] values.
	Item Display	Display items.
	Comment Display	Display comments.
	Change Display Font	Configure font settings, such as the size of the font displayed on the sheet.

Window

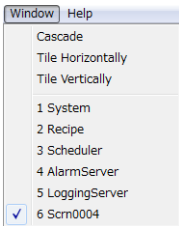
Item	Description	
	Cascade	Cascade sheets.
	Tile Horizontally	Tile sheets horizontally.
	Tile Vertically	Tile sheets vertically.

Help

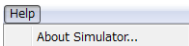
Item	Description	
	About Simulator	Display the simulator version.

Icon Menu

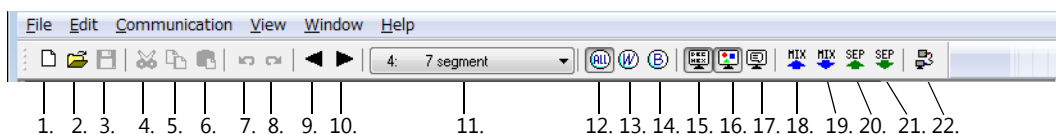

Item		Description
1.	New file	Create a new [Untitled] sheet. This sheet can be used to register and check addresses that do not exist on the automatically created [System] and [Scrn xxxx] sheets. (Refer to page 8-17.)
2.	Open	Open a saved sheet.
3.	Save	Save the [Untitled] sheet under a new name.
4.	Cut	This command is available for the [Untitled] sheet. Cut any selected addresses.
5.	Copy	Copy any selected addresses.
6.	Paste	This command is available for the [Untitled] sheet. Paste any copied or cut addresses.
7.	Undo	Cancel the previous action.
8.	Redo	Revert to the state prior to undo.
9.	Previous screen	This command is active on [Scrn xxxx] sheets. Display the previous screen.
10.	Next screen	This command is active on [Scrn xxxx] sheets. Display the next screen.
11.	Screen	Display the selected screen.
12.	Display all	Display all word items and bit items.
13.	Word	Display word items.
14.	Bit	Display bit items.
15.	Type display	Display [Type], [Data Length], and [ASCII] values.
16.	Item display	Display items.
17.	Comment display	Display comments.
18.	Mix sort (ascending)	Sort device memory addresses.
19.	Mix sort (descending)	
20.	Separate sort (ascending)	
21.	Separate sort (descending)	
22.	Communication	Start or stop communication. (Refer to page 8-8.)

Sheet Structure

This example includes the format display, item display, and comment display.

1. Address	2. Value	3. Type	4. Data Length	5. ASCII	6. Item	7. Comment
\$u20000	0	DEC	1 word		Line 1 [F0]	
\$u20015	0	DEC	1 word		Line 2 [F0]	
\$u20020	0	DEC	1 word		Line 4 [F0]	
\$u20030	0	DEC	1 word		Line 5 [F0]	
\$u20030	0	DEC	1 word		Line 5 [F1]	
\$T00000	0	DEC	1 word		Line 8 [F0]	
\$u20015	0	DEC	1 word		Message Display Memory	
\$u20001	0	DEC	1 word		Num. Display Memory	
\$u20001	0	DEC	1 word		Num. Display Memory	
\$u20000	0	DEC	1 word		Num. Display Memory	
\$u20000	0000	BIN	1 word		Num. Display Memory	
\$u20000	0000	HEX	1 word		Num. Display Memory	
\$u20000	000000	OCT	1 word		Num. Display Memory	
\$u20000	0	-DEC	1 word		Num. Display Memory	
\$u20000	0	DEC	1 word		Num. Display Memory	
\$u20000	0	-DEC	1 word		Num. Display Memory	
\$u20000	0	DEC	1 word		Num. Display Memory	
\$u20020		CHAR	1 word		Char. Display Memory	
\$u20021		CHAR	1 word		Char. Display Memory	
\$u20022		CHAR	1 word		Char. Display Memory	

Item	Description
1. Address	Displays addresses.
2. Value	Displays the currently entered setting values.
3. Type	Displays the currently set display format.
4. Data Length	Displays the currently set data length.
5. ASCII	This column is only available when [Display] is selected for [ASCII]. Displays the current setting value in ASCII code format.
6. Item	Displays the item name and setting item for each address.
7. Comment display	This column is available for items set on the [Untitled] sheet. Displays comments registered on the [Untitled] sheet.

8.1.8 Operation Method

Changing Values (Word Address)

1. Double-click the [Value] field or click [Change Setting Value] from the right-click menu.

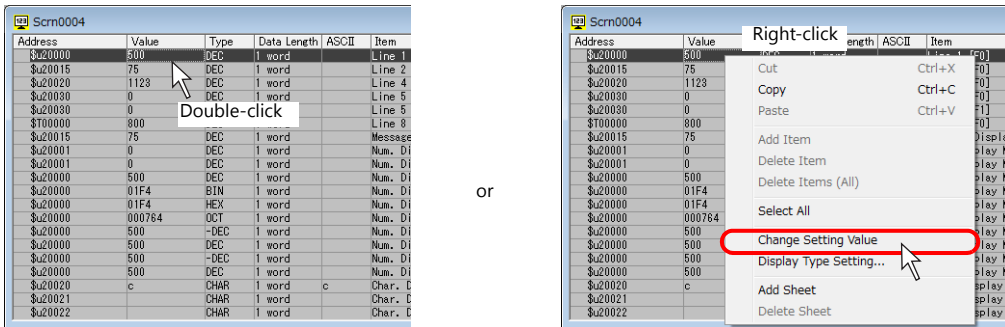

2. The [Write Device] window is displayed. Set the desired value and click [OK].

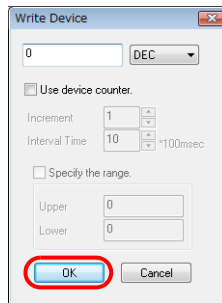

3. The entered value is displayed on the sheet. It is also displayed on the V9 series unit.

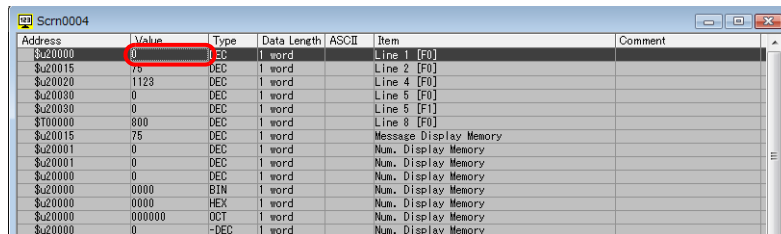

Device counter

Selecting the [Use device counter] checkbox makes it possible to increment or decrement values within the specified range at the specified intervals.

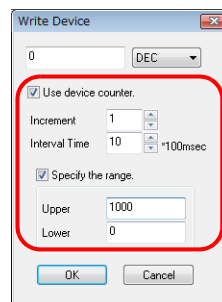

When this checkbox is selected, the "□" mark is displayed on the left of the address displayed on the sheet. Clicking the mark executes increment or decrement.

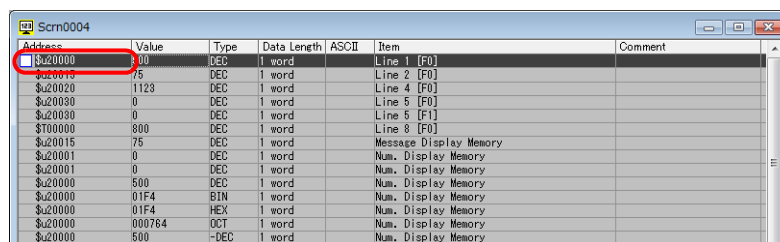

Adding a New Address

When checking addresses that are not shown on the [System] and [Scrn xxxx] sheets, it is necessary to create a new [Untitled] sheet for adding or inserting those addresses.

The procedure for adding a new address is described below.

1. Create a new sheet.
Click [File] → [New] or click the [New] icon on the toolbar.

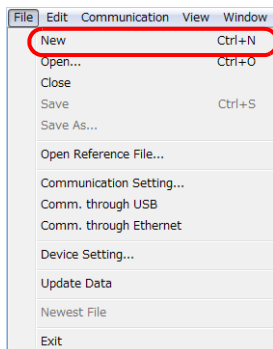

or

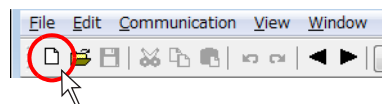

2. A new [Untitled] sheet is displayed.

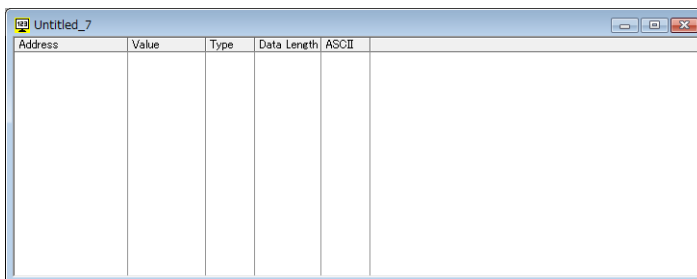

3. Click [Add Item] on the right-click menu.
The [Add Device] window is displayed.

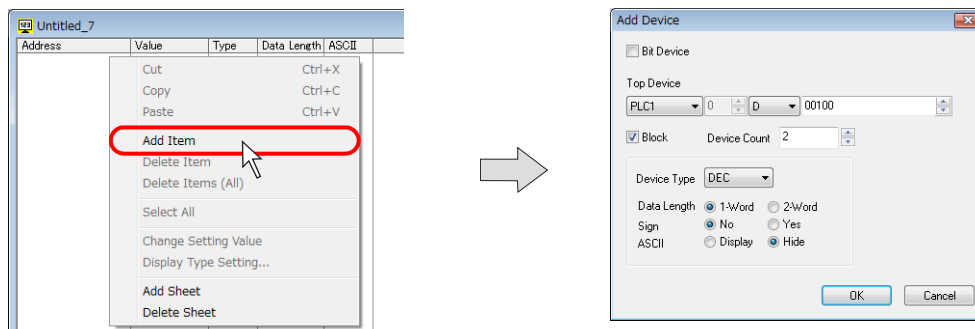

4. For bit device memory, select the [Bit Device] checkbox.
Make the desired settings and click [OK].
New addresses are displayed on the sheet.

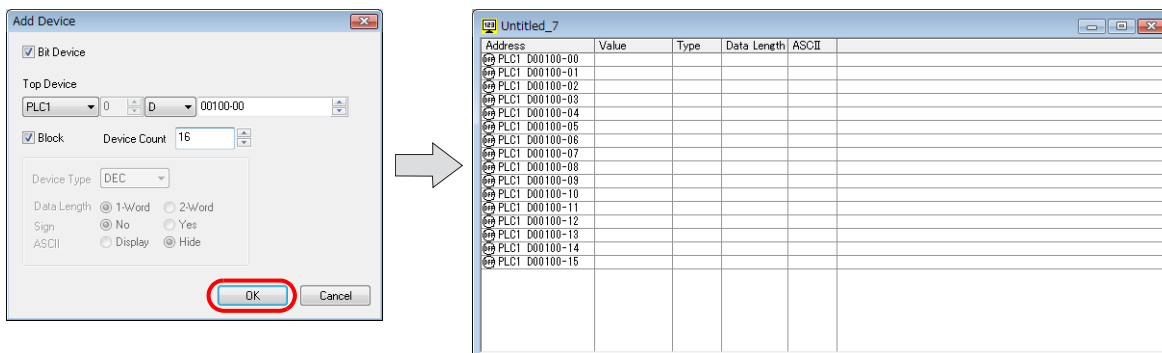

Display Device Memory

The simulator is able to run for up to eight kinds of devices in communication with the V9 series unit (8-way communication). Whether or not to use the simulator is selectable for each of the connected devices.

If the addresses of devices, for which the simulator is not used, are shown on the simulator, the addresses turn red on the simulator sheet (as shown below). Changes to the values for these addresses made on the simulator will not take effect.

Address	Value	Type	Data Len	ASCII	Item
PLC1 M00100					Lamp Lamp Memory
PLC1 M00101					Lamp Lamp Memory
PLC1 M00102					Lamp Lamp Memory
PLC1 M00103					Lamp Lamp Memory
PLC1 D00100	0	DEC	1 word		Num. Display Memory
PLC1 D00101	0	DEC	1 word		Num. Display Memory
PLC1 D00102	0	DEC	1 word		Num. Display Memory
PLC1 D00103	0	DEC	1 word		Num. Display Memory
PLC1 D00104	0	DEC	1 word		Num. Display Memory
PLC1 D00105	0	DEC	1 word		Num. Display Memory
PLC1 D00106	0	DEC	1 word		Num. Display Memory
PLC1 D00107	0	DEC	1 word		Num. Display Memory
PLC1 D00108	0	DEC	1 word		Num. Display Memory
PLC1 D00109	0	DEC	1 word		Num. Display Memory
PLC2 1:0100	0	DEC	1 word		Num. Display Memory
PLC2 1:0101	0	DEC	1 word		Num. Display Memory
PLC2 1:0102	0	DEC	1 word		Num. Display Memory
PLC2 1:0103	0	DEC	1 word		Num. Display Memory
PLC2 1:0104	0	DEC	1 word		Num. Display Memory
PLC2 1:0105	0	DEC	1 word		Num. Display Memory
PLC2 1:0106	0	DEC	1 word		Num. Display Memory
PLC2 1:0107	0	DEC	1 word		Num. Display Memory
PLC2 1:0108	0	DEC	1 word		Num. Display Memory
PLC2 1:0109	0	DEC	1 word		Num. Display Memory
PLC2 1:0000-00					Lamp Lamp Memory
PLC2 1:0000-01					Lamp Lamp Memory
PLC2 1:0000-02					Lamp Lamp Memory

When displaying device memory addresses, which of the addresses to display of the selected devices from PLC 1 to PLC 8 can be selected. Click [View] → [Display Device Setting]. The [Display Device Setting] window is displayed.

Select the checkboxes of the PLCs to display on the simulator and click [OK]. Only the addresses of the selected devices will be displayed on the simulator.

8.1.9 Test Example

This section explains testing using the screen shown below as an example.

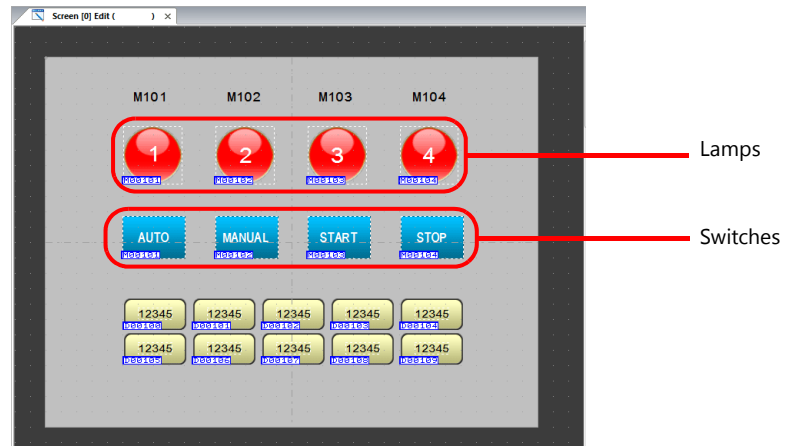

Testing Bit Device Memory

V9 series unit → simulator

Use the simulator to check the output signal. As an example, M101 is allocated to the leftmost [Auto] switch as an output device memory.

1. Press the leftmost [Auto] switch on the V9 series unit.



2. M0101 will turn ON on the simulator. The left icon will change from [OFF] to [ON].

The screenshot shows a table of PLC1 memory addresses and their values. The table has columns for Address, Value, Type, Data Length, ASCII, and Item. The row for PLC1 M00101 is highlighted with a red circle, showing a value of 1. The other rows show values of 0.

Address	Value	Type	Data Length	ASCII	Item
PLC1 M00101	1				Lamp Lamp Memory
PLC1 M00102	0				Lamp Lamp Memory
PLC1 M00103	0				Lamp Lamp Memory
PLC1 M00104	0				Lamp Lamp Memory
PLC1 M00105	0				Switch Output Memory
PLC1 M00106	0				Switch Output Memory
PLC1 M00107	0				Switch Output Memory
PLC1 M00108	0				Switch Output Memory
PLC1 M00109	0				Switch Output Memory
PLC1 D00100	0	DEC	1 word		Num. Display Memory
PLC1 D00101	0	DEC	1 word		Num. Display Memory
PLC1 D00102	0	DEC	1 word		Num. Display Memory
PLC1 D00103	0	DEC	1 word		Num. Display Memory
PLC1 D00104	0	DEC	1 word		Num. Display Memory
PLC1 D00105	0	DEC	1 word		Num. Display Memory
PLC1 D00106	0	DEC	1 word		Num. Display Memory
PLC1 D00107	0	DEC	1 word		Num. Display Memory
PLC1 D00108	0	DEC	1 word		Num. Display Memory
PLC1 D00109	0	DEC	1 word		Num. Display Memory

Simulator → V9 series unit

Use the simulator to turn the lamp on. As an example, M104 is allocated to the rightmost lamp "4".

1. On the simulator, click the [OFF] icon for M104 (lamp device memory).
The icon changes from [OFF] to [ON].

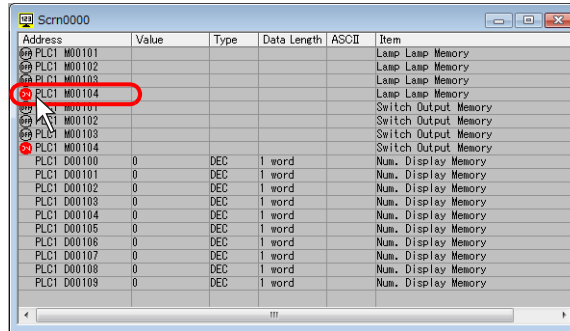

The screenshot shows a window titled 'Scrn0000' containing a table of PLC memory addresses. The table has columns for Address, Value, Type, Data Length, ASCII, and Item. The row for 'PLC1 M00104' is highlighted with a red circle, and a mouse cursor is pointing at it.

Address	Value	Type	Data Length	ASCII	Item
PLC1 M00101					Lamp Lamp Memory
PLC1 M00102					Lamp Lamp Memory
PLC1 M00103					Lamp Lamp Memory
PLC1 M00104					Lamp Lamp Memory
PLC1 M00101					Switch Output Memory
PLC1 M00102					Switch Output Memory
PLC1 M00103					Switch Output Memory
PLC1 M00104					Switch Output Memory
PLC1 D00100	0	DEC	1 word		Num. Display Memory
PLC1 D00101	0	DEC	1 word		Num. Display Memory
PLC1 D00102	0	DEC	1 word		Num. Display Memory
PLC1 D00103	0	DEC	1 word		Num. Display Memory
PLC1 D00104	0	DEC	1 word		Num. Display Memory
PLC1 D00105	0	DEC	1 word		Num. Display Memory
PLC1 D00106	0	DEC	1 word		Num. Display Memory
PLC1 D00107	0	DEC	1 word		Num. Display Memory
PLC1 D00108	0	DEC	1 word		Num. Display Memory
PLC1 D00109	0	DEC	1 word		Num. Display Memory

2. Lamp "4" will light up on the V9 series unit.

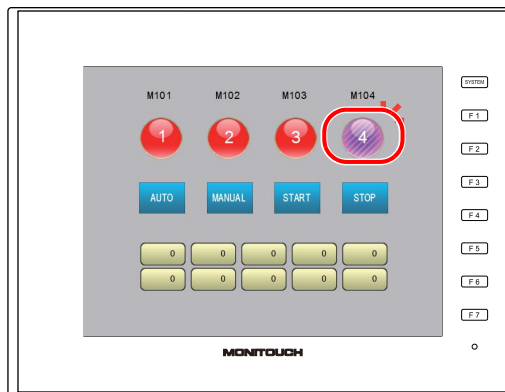

- While a device memory address is selected with the cursor on the simulator, the corresponding bit device memory is set or reset at each press of the space key on the keyboard.
- Simultaneously setting/resetting multiple bits
 1. Select bit device memory addresses that will be set/reset (multiple selections possible).
Select sequentially by holding down the [Shift] key and clicking the mouse.
Select randomly by holding down the [Ctrl] key and clicking the mouse.
 2. Pressing the space key sets the bits.
 3. Pressing the space key again resets the bits.

Testing Word Device Memory

This section explains changing the numerical value of a data display. As an example, the value D100 will be changed.



1. Double-click the "D100" field on the simulator.
The [Write Device] window is displayed.

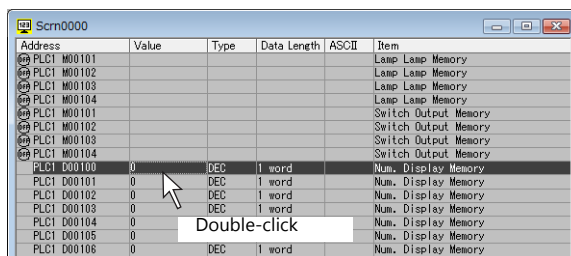

2. Enter a value as desired. (If necessary, change the format of the value to be entered.)
As an example, "123" is entered in decimal notation.

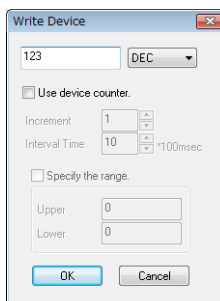

3. Click on [OK] to close the window.
"123" is displayed on the V9 series unit.



Simultaneously entering numerical values for multiple device memory addresses

1. Select the device memory to set numerical values for (multiple selections possible).
Select sequentially by holding down the [Shift] key and clicking the mouse.
Select randomly by holding down the [Ctrl] key and clicking the mouse.
2. Right-click on any of the lines that are selected, and then click [Change Setting Value].
3. Set the desired value and click [OK]. The numbers of all the selected lines are changed simultaneously.

8.1.10 Error List

The following errors may occur on the V9 series unit during communication between the V9 series unit and the simulator (computer).

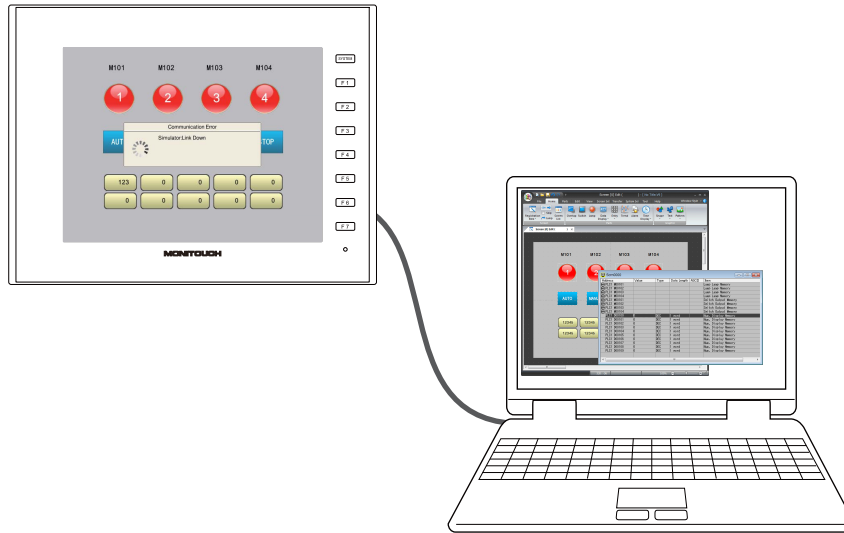

Message	Description	Corrective Action
Communication Error: Simulator: Time-Out	After a request for communication transmitted to the computer (simulator), the computer does not respond within the preset time.	<p>Take corrective action according to the following. If the problem persists, restart the simulator.</p> <p>Serial communication</p> <ul style="list-style-type: none"> Wiring Connect the V-CP cable to MJ1 (modular jack 1). Simulator settings Baud rate and COM port settings at [File] → [Communication Setting] <p>Ethernet communication</p> <ul style="list-style-type: none"> Wiring LAN cable connection Connect a cable to the LAN port. Simulator settings Check [File] → [✓ Comm. through Ethernet] Check [Port No.] at [File] → [Communication Setting] (The port number must match the port number setting for the simulator setting on the V9 series unit.) V9 series unit settings Match the IP address at Local mode → [Simulator Setting] with the IP address of the computer. Set the port number the same as the port number set on the simulator. <p>USB communication</p> <ul style="list-style-type: none"> Wiring Connect a USB cable to the USB-B port. Simulator settings Check [File] → [✓ Comm. through USB]
Communication Error: Simulator: Link Down	The LAN cable is not connected.	<p>Ethernet communication only</p> <p>Connect the Ethernet cable to the V9 series unit.</p>
Communication Error: Simulator: MAC address not registered.	The MAC address is not registered.	<p>Ethernet communication only</p> <p>Servicing is required because a MAC address is not registered.</p>
Communication Error: Simulator: Check Code	A check code error occurred. (received characters in a nonconforming format)	<p>Serial communication only</p> <p>A communication error occurred between the V9 series unit and the computer. Check for adverse effects due to noise, etc.</p>
Communication Error: Simulator: Undefined Error	The MAC address is not registered.	<p>Turn the power OFF and then ON again. If the problem persists, the unit may be faulty.</p>
Communication Error: Simulator: Format	A format error occurred. (received characters in a nonconforming format)	<p>A communication error occurred between the V9 series unit and the computer. Check for adverse effects due to noise, etc.</p>

8.2 Emulator

8.2.1 Overview

If no V9 series unit or other connected devices are available, operation of created screens can be checked using the emulator. This means that the emulator replaces the V9 series unit and the simulator replaces the devices connected to the V9 series unit.

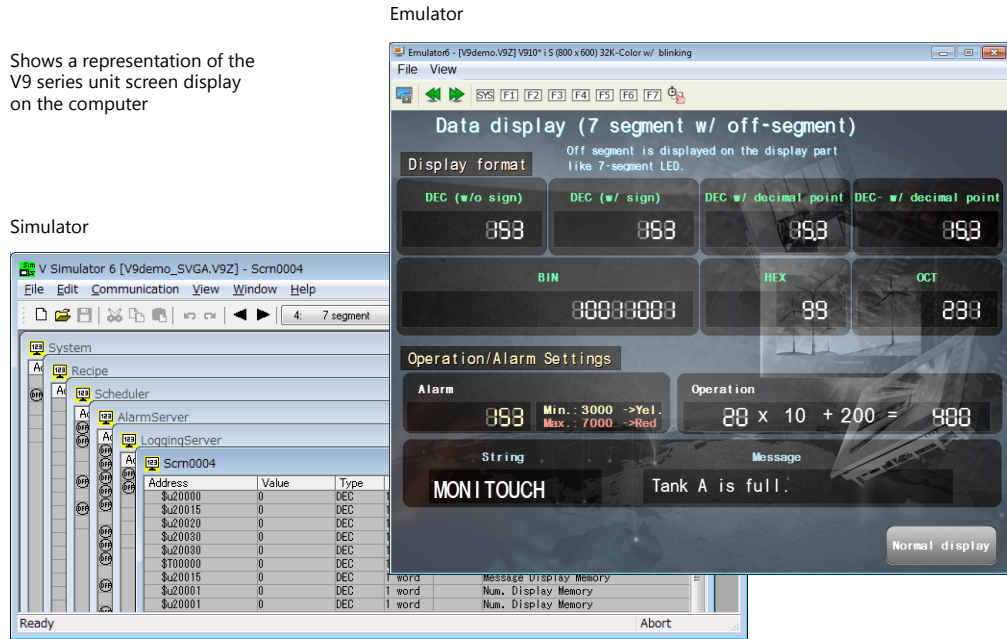

The emulator enables you to easily capture actual screenshots and paste them into documents, such as when creating an instruction manual. (Refer to page 8-26.)

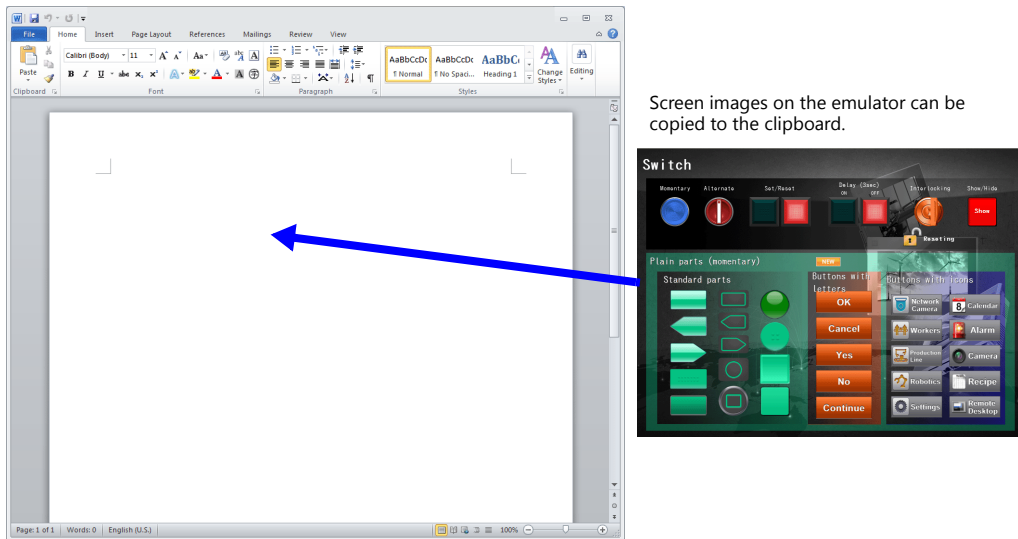

8.2.2 Operating Procedure

1. Open a screen program file.
2. Start the emulator (page 8-24)
 - Check operation on the simulator and emulator (page 8-25)
3. Close the emulator (page 8-24).

Starting and Quitting

Startup

Click [Transfer] → [Emulate] → [Start].

The simulator starts automatically. The [Emulator] window is displayed as well.

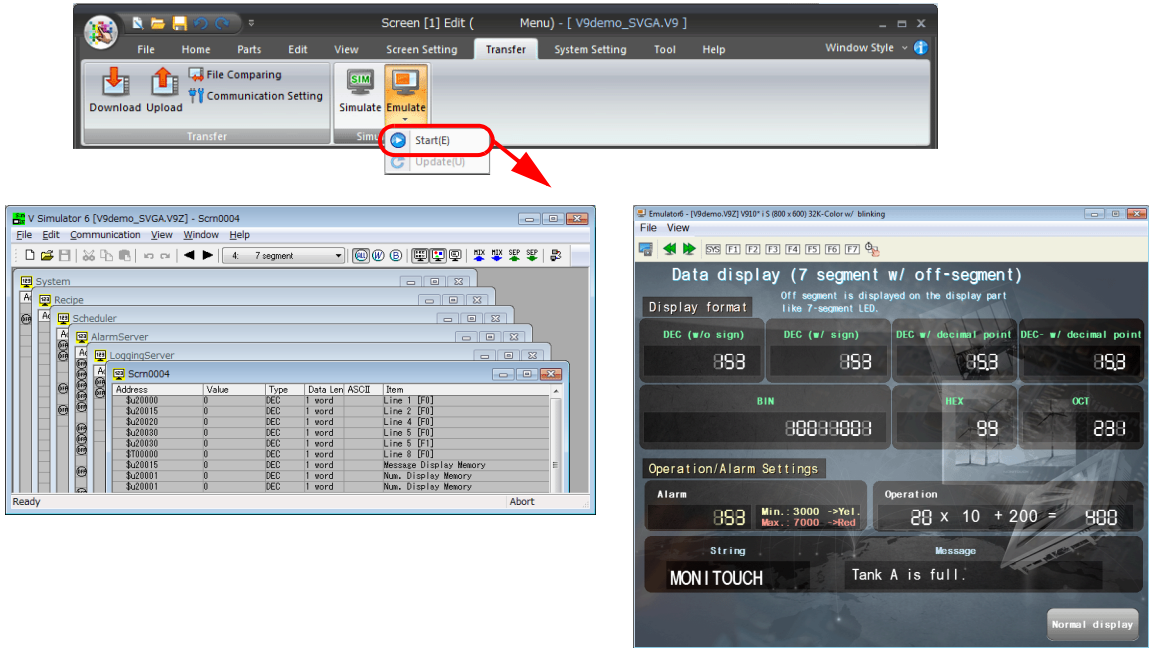

Quitting

On the [Emulator] window, click [File] → [Exit] or click the [Close] button.

The [Emulator] window closes. The simulator quits at the same time.

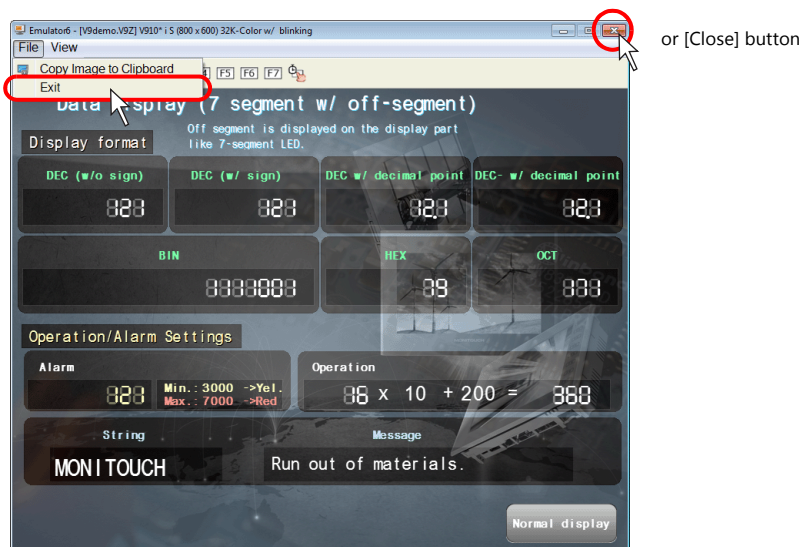

Operation Example

- When a switch part is clicked on the screen displayed on the emulator, the switch reacts in the same way as it reacts on the V9 series unit.



- To change the setting value in the connected device, use the simulator.

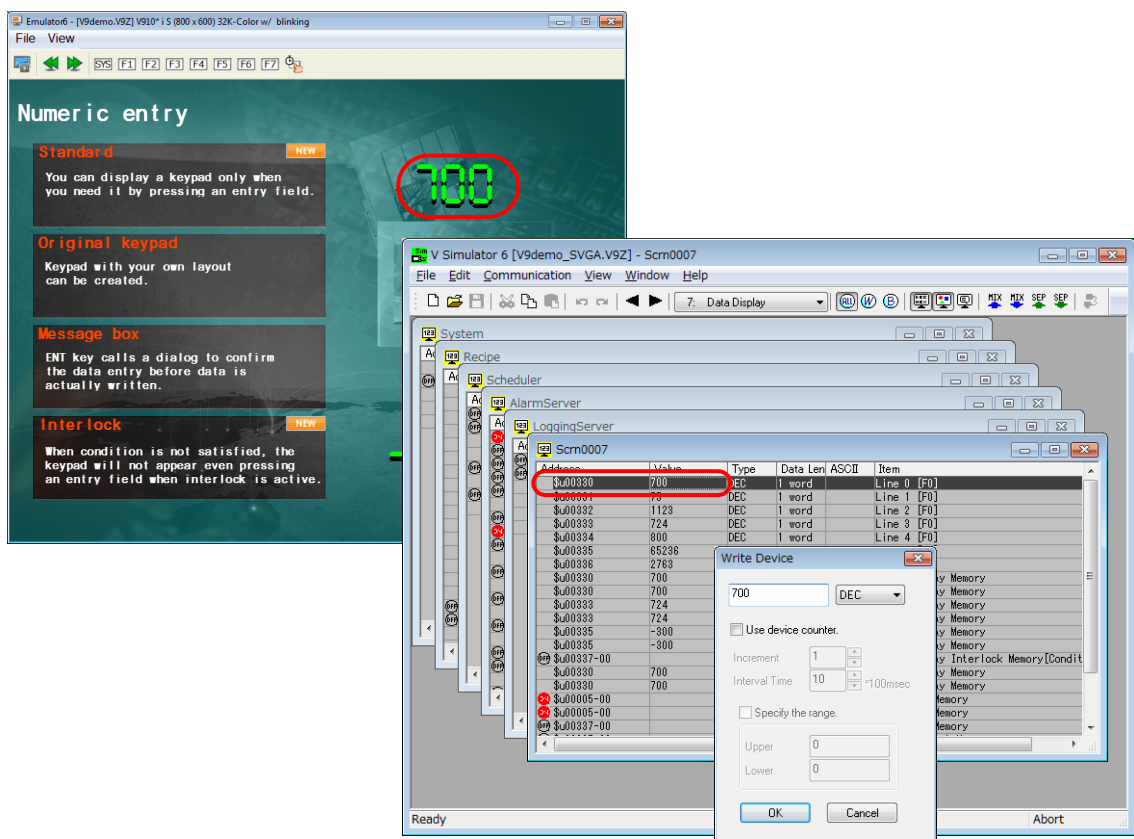

For more information on operating the simulator, refer to "8.1 Simulator" page 8-1.

8.2.3 Structure of the [Emulator] Window



Item	Description
Menu bar	For more information, refer to page 8-26.
Icon menu	For more information, refer to page 8-26.
Emulator screen	Operations to be performed on the V9 series unit can be emulated on the emulator.

Menu Bar

File

Item	Description	
	Copy Image to Clipboard	Copy an image of the emulator screen to the clipboard.
	Exit	Quit the emulator.

View

Item	Description	
	Next Screen	Display the next screen.
	Previous Screen	Display the previous screen.

Icon Menu

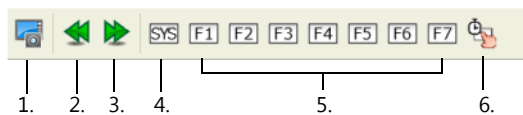

Item	Description	
1.	Copy image to clipboard	Copy an image of the emulator screen to the clipboard.
2.	Previous screen	Display the previous screen.
3.	Next screen	Display the next screen.
4.	SYS switch	Display the system menu.
5.	Function switches F1 to F7	Execute the function of the function switch.
6.	Alternate mode	Changes the function switches to their alternate operation.

9 Printing

- 9.1 Overview
- 9.2 Printing
- 9.3 Print Preview
- 9.4 Print Current Window
- 9.5 Example of Printing

9.1 Overview

The screen program file currently being edited can be printed out from a printer connected to the computer.

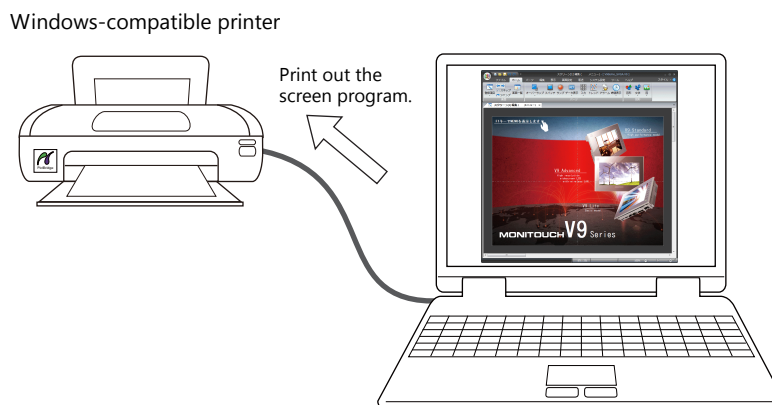

* When printing the screen program from a printer connected to the V9 series unit, refer to "16 Print" in V9 Series Reference Manual 1.

9.1.1 Compatible Printers

Printing can be executed from the editor using any printer that is available in the Windows environment.

* **Note that there is a limitation on printers that can be used to execute printing from the V9 series unit.**

9.2 Printing

9.2.1 Operating Procedure

1. Prepare the printer.
Connect a printer to the computer.
2. Open a screen program file.
3. Configure the printing environment ([File] → [Print] → [Print Settings] window) (page 9-2).
 - Printer settings
 - Page settings
4. Set the print target ([File] → [Print] → [Print Settings] window) (page 9-2).
 - Output range (page 9-6)
 - Print format (page 9-4)
5. Printing

9.2.2 Print Settings

Click [File] → [Print]. The [Print Settings] window is displayed.

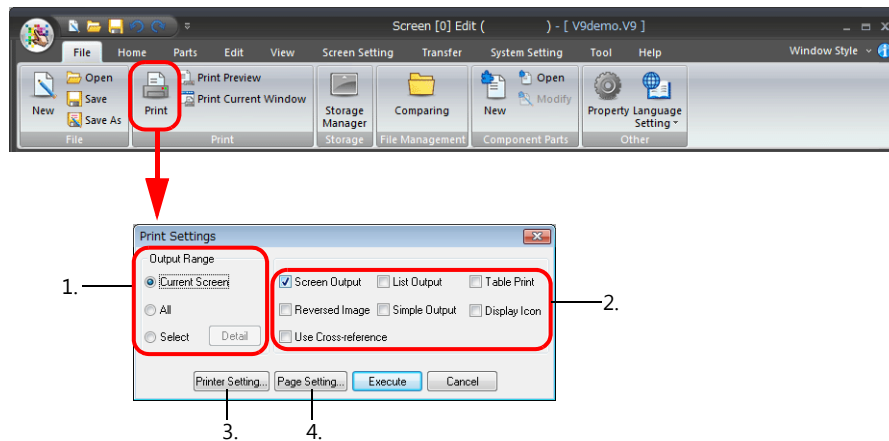

Item	Description
1. Output Range	Select the range to be printed out. For more information, refer to page 9-3.
2. Print format	Set the output format for printing. For more information, refer to page 9-4.
3. Printer Setting	Configure the same printer settings that are provided in Windows, such as printer model and paper size.
4. Page Setting	Set the print format. For more information, refer to page 9-5.

Output Range

[Current Screen]

Print the window currently opened in the editor.

[All]

Print all content in the screen program file.

[Select]

Select the range to print. Select this option and click the [Detail] button.

The [Print Item Setting] window is displayed.

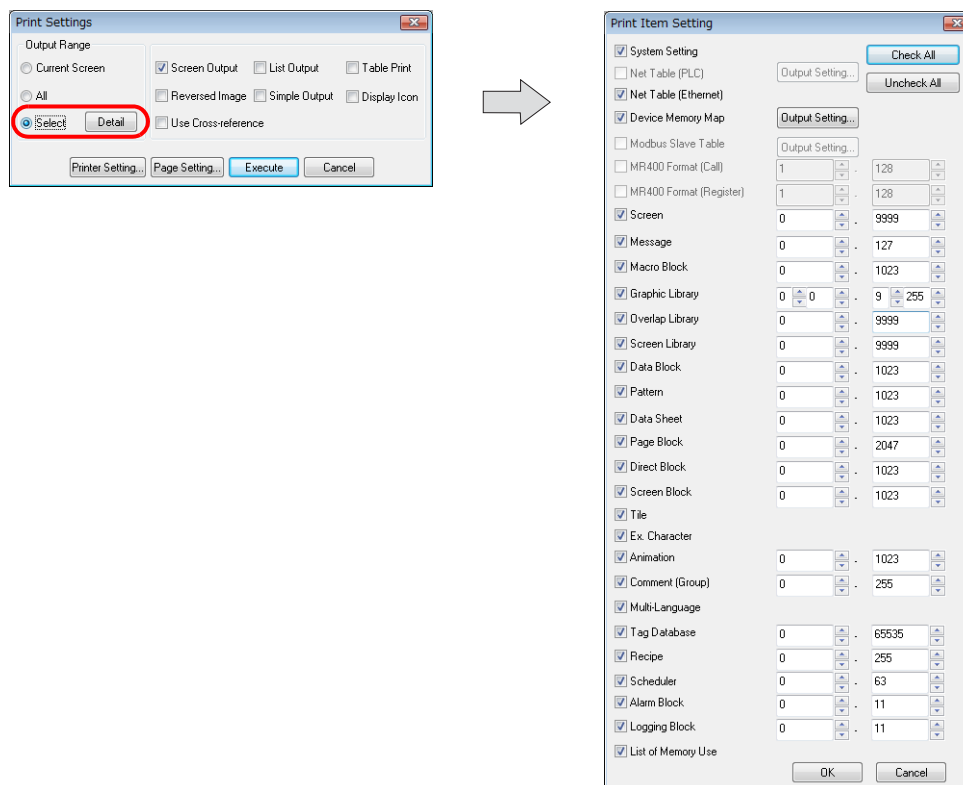

Item	Description
System Setting	Print the system setting data.
Net Table (PLC)	This option becomes available when [Omron: SYSMAC CS1/CJ1 DNA] or [Omron: SYSMAC CS1/CJ1 DNA (Ethernet)] is selected for the PLC model. Select this checkbox to print the registered network table.
Net Table (Ethernet)	Select this checkbox to print the network table for Ethernet.
Device Memory Map	Select this checkbox to print the contents of the device memory map, selected through the [Output Setting] button.
Modbus Slave Table (0 to 255)	This option becomes available when Modbus slave communication is used. Select this checkbox to print out the memory table (Modbus table) used for Modbus slave communication.
MR400 Format (Call) (1 to 128)	This option becomes available when Sato's MR-400 barcode printer is connected. Select this checkbox to print the contents registered in [MR400 Format (Call)].
MR400 Format (Register) (1 to 128)	This option becomes available when Sato's MR-400 barcode printer is connected. Select this checkbox to print the contents registered in [MR400 Format (Register)].
Screen (0 to 9999)	Select this checkbox to print screens.
Message (0 to 127)	Select this checkbox to print the contents of [Home] → [Registration Item] → [Message].
Macro Block (0 to 1023)	Select this checkbox to print the contents of [Home] → [Registration Item] → [Macro Block].
Graphic Library (0 : 0 to 9 : 255)	Select this checkbox to print the contents of [Home] → [Registration Item] → [Graphic Library].
Overlap Library (0 to 9999)	Select this checkbox to print the contents of [Home] → [Registration Item] → [Overlap Library].
Screen Library (0 to 9999)	Select this checkbox to print the contents of [Home] → [Registration Item] → [Screen Library].
Data Block (0 to 1023)	Select this checkbox to print the contents of [Home] → [Registration Item] → [Data Block].
Pattern (0 to 1023)	Select this checkbox to print the contents of [Home] → [Registration Item] → [Pattern].
Data Sheet (0 to 1023)	Select this checkbox to print the contents of [Home] → [Registration Item] → [Data Sheet].

Item	Description
Page Block (0 to 2047)	Select this checkbox to print the contents of [Home] → [Registration Item] → [Page Block].
Direct Block (0 to 1023)	Select this checkbox to print the contents of [Home] → [Registration Item] → [Direct Block].
Screen Block (0 to 1023)	Select this checkbox to print the contents of [Home] → [Registration Item] → [Screen Block].
Tile	Select this checkbox to print the tile pattern.
Ex. Character	Select this checkbox to print external characters.
Animation (0 to 1023)	Select this checkbox to print the contents of [Home] → [Registration Item] → [Animation].
Comment (Group) (0 to 255)	Select this checkbox to print the contents of [Home] → [Registration Item] → [Comment].
Multi-Language	This option becomes available when "2" or more is specified for [Interface Languages] in [System Setting] → [Font Setting]. Select this checkbox to print the contents of the multi-language editing window.
Tag Database (0 to 65535)	Select this checkbox to print the contents of [Home] → [Registration Item] → [Tag Database].
Recipe (0 to 255)	Select this checkbox to print the contents of [System Setting] → [Recipe].
Scheduler (0 to 63)	Select this checkbox to print the contents of [System Setting] → [Scheduler].
Alarm Block (0 to 11)	Select this checkbox to print the contents of [System Setting] → [Alarm Server].
Logging Block (0 to 11)	Select this checkbox to print the contents of [System Setting] → [Logging Server].
List of Memory Use	Select this checkbox to print items registered in the screen program file.
Check All	Click this button to select all of the checkboxes.
Uncheck All	Click this button to deselect all of the checkboxes.

Click [OK] to return to the [Print Settings] window.

Print Format

Item	Description
Screen Output	Print screen images.
List Output	Print the screen settings. (For an example of printer output, refer to page 9-7.)
Table Print	Print a table of screen images. (For an example of printer output, refer to page 9-8.) When this checkbox is selected, the [Screen Output] and [List Output] checkboxes are prohibited.
Reversed Image	This option becomes available when the [Screen Output] checkbox is selected. Print the screen with the tone inverted. Only the white and black parts are inverted.
Simple Output	If the printed screen program is difficult to see, select this checkbox. Legibility may be improved.
Display Icon	Select this checkbox to also print the icons of overlaps and items.
Use Cross-reference	When the graphic library is printed, device memory numbers set for graphic parts are also printed. (For an example of printer output, refer to page 9-8.) * This is only available when the switching method is set to device memory (bit designation)

*** The print formats described above are always active for any items to be printed out.**

However, for items that cannot be printed in the selected print format, the following message appears when [Execute] is clicked.

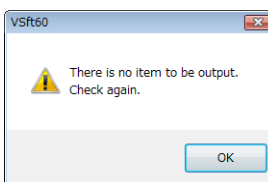

When this message is displayed, make sure that the items to be printed and the print format are correctly selected.

When the settings are complete, click [Execute]. Printing is executed.
To cancel printing, click the [Cancel] button.

Page Settings

Item	Description
Left Margin (mm)	Specify the left margin.
Right Margin (mm)	Specify the right margin.
Upper Margin (mm)	Specify the upper margin.
Bottom Margin (mm)	Specify the lower margin.
Header	Specify the contents of the header. The header is displayed by default, comprising three lines that respectively denote the V-SFT version and date of printing, file comments, and filename. The text is changeable as needed. However, do not change the following text. (These can be deleted.) %Ver, %Date, %Time, %FileComment, %FileName
Footer	Specify the contents of the footer. No footer is selected as default.
Page No.	Select whether to show and where to print page numbers.
Start Page No.	When the [Page No.] checkbox is selected, specify the start page number.
Font Size	Specify the size for printing characters.

9.3 Print Preview

A preview of printer output can be displayed in the editor.

9.3.1 Operating Procedure

1. Open a screen program file.
2. Click [File] → [Print Preview].
3. Set the range to print (in the [Print Settings] window).
 - Output range
 - Other settings

The settings in the [Print Settings] window are the same as the [Print Settings] window selected from [File] → [Print]. For more information, refer to page 9-2.

4. Display the preview.

9.4 Print Current Window

When printing the window (of a screen, messages, macro editor, etc.) currently opened, perform the steps below.

9.4.1 Operating Procedure

1. Open a screen program file.
2. Click [File] → [Print Current Window].
3. The window currently opened is printed.

9.5 Example of Printing

Screen Output



List Output

Screen

```
V-SFT Ver 6.00 DATE [2014/5/1] TIME [15:29:29]
File Comment: []
Filename: [D:\V9\V9demo_SVGA.V9]

Screen [No 4] [7 segment w/ off-segment]

[Screen Setting]
Item selection device: None
PLC device memory: None
Security level: 0
[Item show/hide]
Redraw the screen
[OPEN Macro]
0: ;
1: $u20000 = 0 C: 2 (FILL)
2: $u20015 = 2560 (W)
3: ;
4: $u20020 = 'HAKKO'
5: $u20030 = $u20030 + 1 (W)
6: ;
7: ;>7 segment display
8: $T00000 = 1H (W)
9: ;
[CLOSE Macro]
No setting
[CYCLE Macro]
No setting
Local function switches not used
Blend value: 255

[Base]

[ID No0] Interval timer
Repeat interval: 2
Process cycle: Low speed
[Execution macro]
Macro block No. 60
0: IF ($u20005 != 0U) LB 0 (W)
1: $u20000 = $u20000 + 1U (W)
2: IF ($u20000 < 9999U) LB 1 (W)
3: $u20005 = 1 (W)
4: ;
```

System settings

```
V-SFT Ver 6.00 DATE [2014/5/1] TIME [15:29:29]
File Comment: []
Filename: [D:\V9\V9demo_SVGA.V9]

***System Setting***
Filename: V9demo_SVGA.V9
File Comment:

[Edit Model]
Edit Model: V910* i S
Size: 800 x 600
Color: 64K-Color w/ blinking
Touch switch: Analog switch

[Connection device settings]
PLC1: CN1: [MITSUBISHI ELECTRIC QnU series CPU]
PLC2: Disconnected
PLC3: Disconnected
PLC4: Disconnected
PLC5: Disconnected
PLC6: Disconnected
PLC7: Disconnected
PLC8: Disconnected

[Serial Port]
CN1 : PLC1
MJ1 : Disconnected
MJ2 : Disconnected

[Control area]
---Screen---
Displaying Screen Device: $u00000
Initial Screen: 1
---Calendar Setting---
PLC Selection: PLC1
---Other---

[PLC1 Communication Settings]
Manufacturer: MITSUBISHI ELECTRIC
Model: QnU series CPU
Connection Port: CN1
Signal level: RS-232C
Baud Rate: 9600BPS
```

List of memory use

```

V-SFT Ver 6.00 DATE [2014/5/1] TIME [15:29:29]
File Comment: [ ]
Filename: [D:\V9\V9demo_SVGA.V9]

*** Status of Use ***
[ Screen ] 49 [ Multi-Overlap ] 6
[ Graphic 0 ] 10 [ Graphic 1 ] 10
[ Graphic 2 ] 10 [ Graphic 3 ] 10
[ Graphic 4 ] 10 [ Graphic 5 ] 10
[ Graphic 6 ] 10 [ Graphic 7 ] 10
[ Graphic 8 ] 10 [ Graphic 9 ] 10
[ Data Block ] 10 [ Message ] 16
[ Pattern ] 10 [ Macro Block ] 152
[ Page Block ] 10 [ Direct Block ] 10
[ Screen Block ] 10 [ Data Sheet ] 10
[ Screen Library ] 10 [ Animation ] 10
[ MR400 (Call) ] 10 [ MR400 (Register) ] 10
[ Comment ] 10
[ Device Memory Map (PLC1) ] 10 [ Device Memory Map (PLC2) ] 10
[ Device Memory Map (PLC3) ] 10 [ Device Memory Map (PLC4) ] 10
[ Device Memory Map (PLC5) ] 10 [ Device Memory Map (PLC6) ] 10
[ Device Memory Map (PLC7) ] 10 [ Device Memory Map (PLC8) ] 10
[ External Character 16 ] 10 [ External Character 32 ] 10
[ Recipe ] 11 [ Scheduler ] 12
[ Alarm Block ] 12 [ Logging Block ] 11

[ Number of Total Bytes ] 19185371 / 47159296 byte

[ Screen ]
  0 1 2 3 4 5 6 7 8 9 10 11 12 13 14 15 16 17 18 19
0 * * * * * * * * * * * * * * * * * *
20 * * * * * * * * * * * * * * * * *
40 * * * * * * * * * * * * * * * * *
60 * * * * * * * * * * * * * * * * *
80 * * * * * * * * * * * * * * * * *
    
```

Table Print

For screens

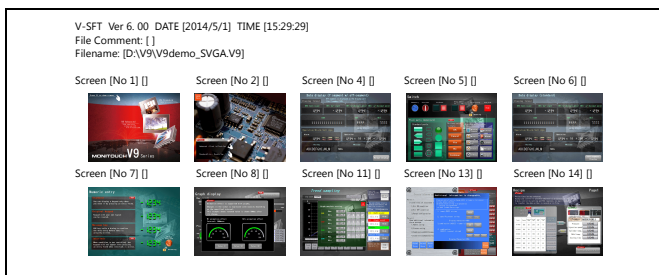

For screen library

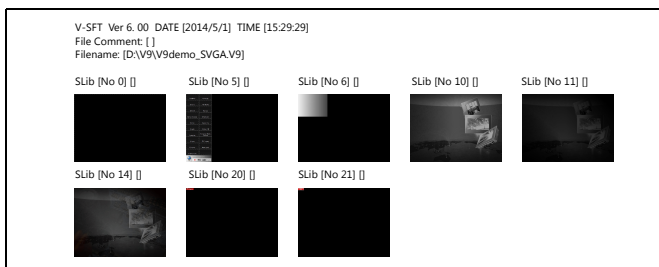

Use Cross-reference

For graphic library

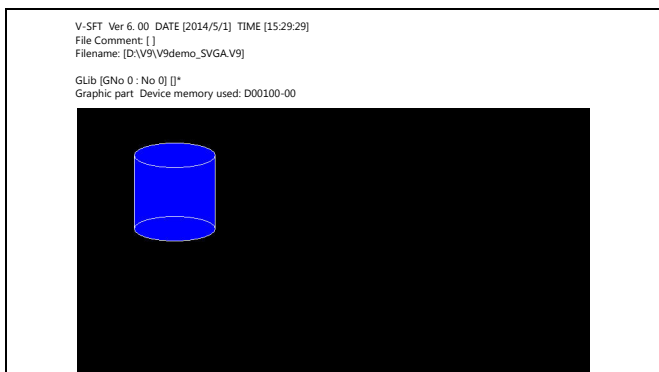

10 Fonts

10.1 Font Types

10.2 Setting Fonts

10.3 Entering Multiple Languages

10.4 Windows Font

10.1 Font Types

System Fonts

Fonts are generally divided into two types: TrueType fonts and bitmap fonts.

Because the mixed use of fonts is not permitted on the V9 series unit, select one font type in the [System Setting] → [Font Setting] window.

Type	Size Specification Method	Features	Image
TrueType font	Point specification	Supports smoothing. Note that TrueType fonts require more memory than bitmap fonts.	<p>8ポイント 運転 MONITOUCH 10ポイント 運転 MONITOUCH 12ポイント 運転 MONITOUCH 16ポイント 運転 MONITOUCH 18ポイント 運転 MONITOUCH 24ポイント 運転 MONITOUCH</p>
Bitmap font	XY magnification factor specification	Font data designed in sizes of 16 × 16 dots and 32 × 32 dots (two-byte characters). This font type occupies less memory but is not suitable if a smoother-line typeface is required.	<p>1×1 運転 MONITOUCH 2×2 運転 MONITOUCH 3×3 運転 MONITOUCH</p>

Windows Fonts

No font data is stored on the V9 series unit. Fonts used in Windows, such as “Times New Roman” or “Arial”, are used as image data. Settings can be configured for each item.

System fonts and Windows fonts can be used at the same time.

Type	Size Specification Method	Features
Windows Font	Point specification	<p>Fonts used in Windows can be used as is. Different language code characters can be displayed on the same screen.</p> <p>Because characters are drawn as images in addition to always using system fonts, this font type occupies more memory. Also, there are restrictions depending on the functions used. For more information, refer to page 10-11.</p>

Supported Language List

The following table lists the fonts and corresponding languages supported by the V9 series.

Font Setting ^{*1}	Supported Language	Supported Character Code	Remarks	
TrueType font	Japanese Gothic TTF	Japanese, English	JIS level-1 to level-4 + ANK code	8794 not displayable
	Japanese Times TTF			
	English/Western Europe Gothic TTF	English, Icelandic, Irish, Italian, Dutch, Spanish, Danish, German, Norwegian, Portuguese, Finnish, Faroese, French, Swedish	ISO-8859-1: Latin1 (Extended ASCII code)	
	English/Western Europe Times TTF			
	Chinese (Traditional) TTF	Chinese (traditional), English	BIG5 code (A141 to F9FE) + ASCII code	A344 to A373 not displayable
	Chinese (Simplified) TTF	Chinese (simplified), English	GB2312 code (A1A1 to F7FE) + ASCII code	A021 to A07E A6A1 to A6B8 A6C1 to A6D8 A7A1 to A7C0 A7D1 to A7F1 A8BB, A8BD, A8BE, A8C0 not displayable
	Korean TTF	Hangul, English	KS code (A1A1 to FDFE) + ASCII code	A2E6 and A2E7 not displayable
	Central Europe TTF	Croatian, Czech, Hungarian, Polish, Romanian, Slovakian, Slovene, Hrvatska (Croatian)	CP1250 code	
	Cyrillic TTF	Russian, Ukrainian, Bulgarian, Kazakh, Uzbek, Azerbaijani	CP1251 code	
	Greek TTF	Greek	CP1253 code	
	Turkish TTF	Turkish	CP1254 code	
	Baltic TTF	Estonian, Latvian, Lithuanian	CP1257 code	
Bitmap font	Japanese	Japanese, English	JIS level-1 to level-2 + ANK code	
	Japanese 32			
	English/Western Europe	English, Icelandic, Irish, Italian, Dutch, Spanish, Danish, German, Norwegian, Portuguese, Finnish, Faroese, French, Swedish	ISO-8859-1: Latin1 (Extended ASCII code)	
	Chinese (Traditional)			
	Chinese (Simplified)	Chinese (simplified), English	GB2312 code (A1A1 to FEFE) + ASCII code	
	Korean	Hangul, English	KS code (A1A2 to C8FE) + ASCII code	
	Central Europe	Croatian, Czech, Hungarian, Polish, Romanian, Slovakian, Slovene, Hrvatska (Croatian)	CP1250 code	
	Cyrillic	Russian, Ukrainian, Bulgarian, Kazakh, Uzbek, Azerbaijani	CP1251 code	
	Greek	Greek	CP1253 code	
	Turkish	Turkish	CP1254 code	
	Baltic	Estonian, Latvian, Lithuanian	CP1257 code	

*1 TrueType fonts and bitmap fonts cannot be used together.

Checking Fonts in Local Mode

The font name is displayed at the following location in Local mode.

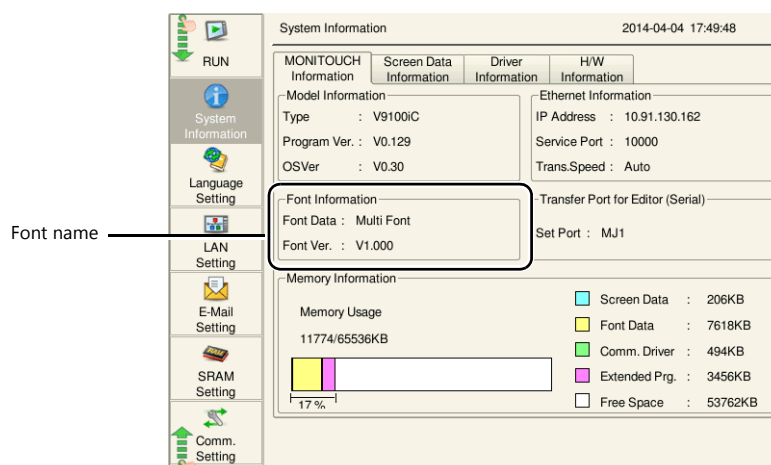

The font names that are displayed in the [Font Setting] window and in Local mode are listed below.

	Font Setting	Local Mode
TrueType font	Japanese Gothic TTF	Jpn. Gothic TTF
	Japanese Times TTF	Jpn. Times TTF
	English/Western Europe Gothic TTF	Eng. Gothic TTF
	English/Western Europe Times TTF	Eng. Times TTF
	Chinese (Traditional) TTF	Chinese(Trd.)TTF
	Chinese (Simplified) TTF	Chinese(Smp.)TTF
	Korean TTF	Korean TTF
	Central Europe TTF	Central Euro.TTF
	Cyrillic TTF	Cyrillic TTF
	Greek TTF	Greek TTF
	Turkish TTF	Turkish TTF
	Baltic TTF	Baltic TTF
	Bitmap font	Japanese
Japanese 32		JAPANESE 32
English/Western Europe		ENGLISH
Chinese (Traditional)		CHINESE(TRAD.)
Chinese (Simplified)		CHINESE(SIMP.)
Korean		KOREAN
Central Europe		Central Euro.
Cyrillic		Cyrillic
Greek		Greek
Turkish		Turkish
Baltic	Baltic	
	Multi-language screen (with multiple fonts selected)	Multi Font

Font Size

Bitmap font

"1" to "8" can be specified for [Enlarge X] or [Enlarge Y]. Correspondence between character sizes and values for [Enlarge] is shown below:

Enlargement Factor	1	2	3	4	5	6	7	8
One-byte (W × H dots)	8 × 16	16 × 32	24 × 48	32 × 64	40 × 80	48 × 96	56 × 112	64 × 128
Two-byte (W × H dots)	16 × 16	32 × 32	48 × 48	64 × 64	80 × 80	96 × 96	112 × 112	128 × 128

Memory Sizes of Fonts

Depending on the font type, the memory used varies.
The font size can be checked in Local mode on the V9 series unit.

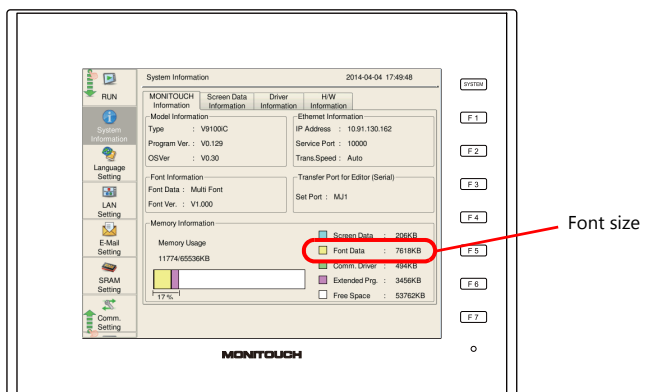

10.2 Setting Fonts

10.2.1 Font Settings

Set the fonts to use in the screen program via [System Setting] → [Multi-language Setting].

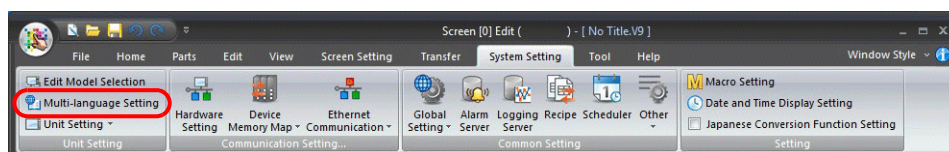

Fonts

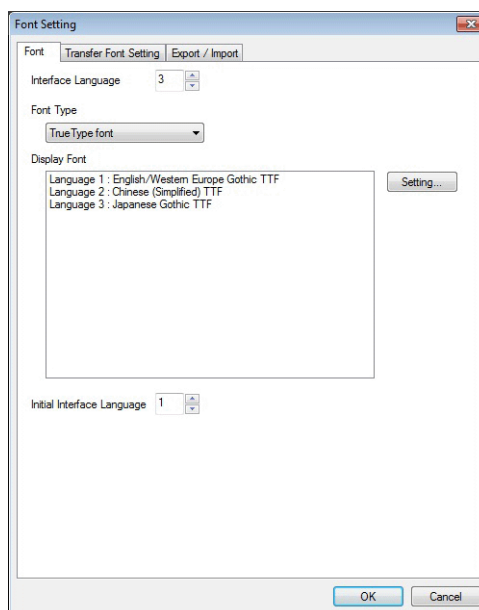

Item	Description
Interface Language	Set the number of interface languages.
Font Type	Select the type of system font to use.
Display Font	Select the font to use for each language.
Initial Interface Language	Select the language to be displayed immediately after the screen program is transferred.

Transfer Font Settings

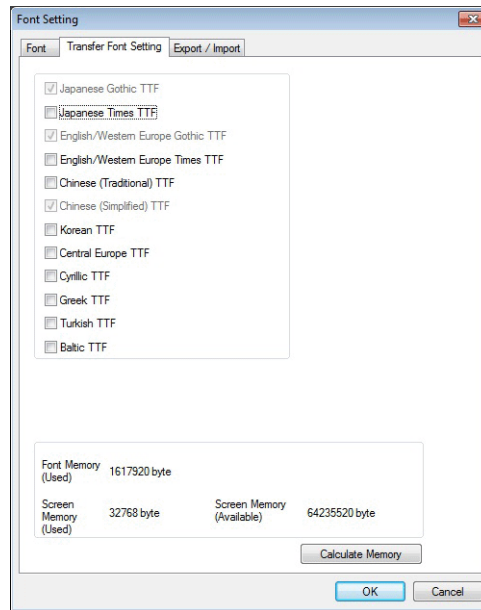





Item	Description
Transfer Font Setting ^{*1}	Select the checkboxes of the fonts required on the V9 series unit. * More fonts transferred to the V9 series unit will decrease the screen program capacity. To avoid a memory shortage, do not select unnecessary fonts.
Font Memory (Used)	Displays the total memory size used for the currently selected fonts for transfer.
Screen Memory (Used)	Displays the size of the screen program currently being created.
Screen Memory (Available)	Displays the space available for the screen program.
Calculate Memory	Recalculate the volume of the screen program from the current settings.

*1 Languages that can be displayed in Local mode are listed below. Which languages are available for display is determined by selecting the corresponding checkboxes on the [Transfer Font Setting] tab.

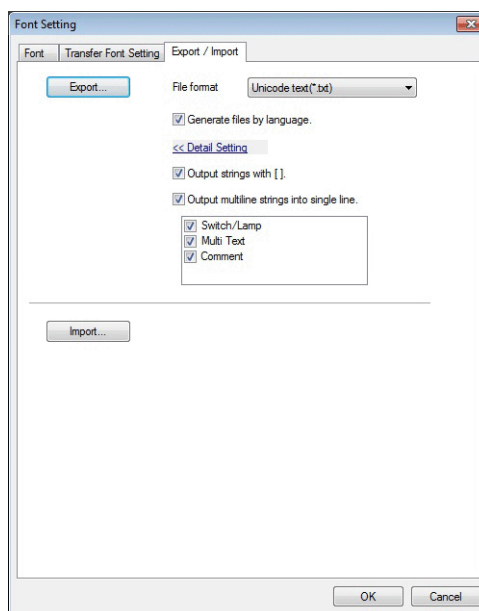
	Transfer Font Setting	Local Mode
TrueType font	Japanese Gothic TTF	Japanese, English
	Japanese Times TTF	
	English/Western Europe Gothic TTF	English
	English/Western Europe Times TTF	
	Chinese (Traditional) TTF	Chinese (Traditional), English
	Chinese (Simplified) TTF	Chinese (Simplified), English
	Korean TTF	Korean, English
	Central Europe TTF	English
	Cyrillic TTF	
	Greek TTF	
	Turkish TTF	
	Baltic TTF	
Bitmap font	Japanese	Japanese, English
	Japanese 32	
	English/Western Europe	English
	Chinese (Traditional)	Chinese (Traditional), English
	Chinese (Simplified)	Chinese (Simplified), English
	Korean	Korean, English
	Central Europe	English
	Cyrillic	
	Greek	
	Turkish	
	Baltic	

Import and Export



Item	Description								
Export	Use this button when editing text for a language other than Language 1 in another application.								
File format	Select the type of file to be exported.								
Generate files by language.	<p>Set the file creation method used in exporting.</p> <ul style="list-style-type: none"> Selected The same number of files are created as there are languages. Unselected One file is created. <div style="display: flex; justify-content: space-around; align-items: flex-start;"> <div style="text-align: center;"> <p>Test.txt — Language 1</p> <p>Test_2.txt — Language 2</p> <p>Test_3.txt — Language 3</p> <p>Test_4.txt — Language 4</p> </div> <div style="text-align: center;"> <p>Test.txt — Languages 1 to 4</p> </div> </div>								
Output strings with [.]	<p>Selected Include square brackets in output files.</p> <p>Unselected Delimit output with commas. When a file is opened in Excel, some text like the following will not be imported correctly.</p> <table border="1" style="margin-left: auto; margin-right: auto;"> <thead> <tr> <th>Characters on V-SFT</th> <th>Output File (Standard cell format)</th> </tr> </thead> <tbody> <tr> <td>0123</td> <td>123</td> </tr> <tr> <td>+BK</td> <td>#NAME?</td> </tr> </tbody> </table> <p style="margin-left: 200px;">← Leading zeros dropped</p> <p style="margin-left: 200px;">← Not recognized as a character string</p>	Characters on V-SFT	Output File (Standard cell format)	0123	123	+BK	#NAME?		
Characters on V-SFT	Output File (Standard cell format)								
0123	123								
+BK	#NAME?								
Output multiline strings into single line.	<p>Set how multiple lines of text located on a switch or lamp are output.</p> <p>Selected Lines of text are output in one cell with the line feed code “\n”.</p> <p>Unselected Text is output line by line in separate cells.</p> <table border="1" style="margin-left: auto; margin-right: auto;"> <thead> <tr> <th>Switch</th> <th>Checkbox</th> <th>Output Result</th> </tr> </thead> <tbody> <tr> <td rowspan="2" style="text-align: center;">  </td> <td>Selected</td> <td>[alarm \n screen]</td> </tr> <tr> <td>Unselected</td> <td>[alarm] [screen]</td> </tr> </tbody> </table>	Switch	Checkbox	Output Result		Selected	[alarm \n screen]	Unselected	[alarm] [screen]
Switch	Checkbox	Output Result							
	Selected	[alarm \n screen]							
	Unselected	[alarm] [screen]							
Import	Use this button when importing a file that contains multi-language text edited in another application.								



For more information on importing and exporting, refer to “9 Language Changeover” in V9 Series Reference Manual 2.

10.3 Entering Multiple Languages

Enter characters in the same manner as you type each language on your computer.

Example: Entering “Chinese (simplified)” Text in a English OS

This section explains how to enter Chinese (simplified) text in Windows 7, for example.



Enter Traditional Chinese characters in BIG5 code and Simplified Chinese in GB2312 code.

Adding input method editors (IMEs)

1. In Windows 7, click [Start] → [Control Panel] to display the [Control Panel] window. Click [Region and Language]. The [Region and Language] window is displayed.

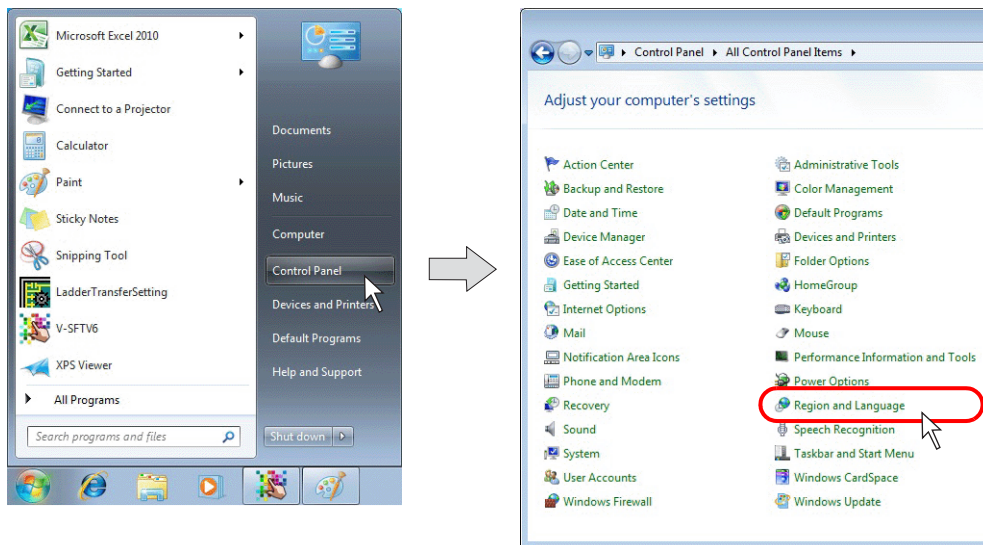

2. Display the [Keyboards and Languages] tab and click the [Change keyboards] button.

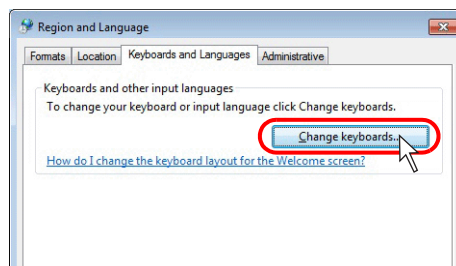

3. Click the [Add] button.

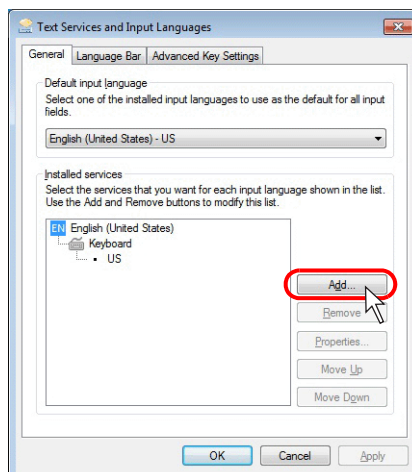

- The [Add Input Language] window is displayed.
Expand [Chinese (Simplified, PRC)] and then [Keyboard] by clicking the [+] marks, select the [Chinese (Simplified) - Microsoft Pinyin New Experience Input Style] checkbox, and click [OK].

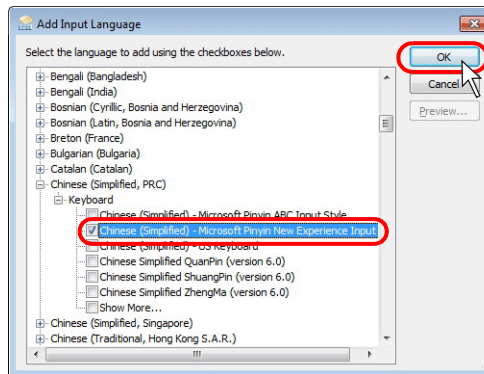

- In the [Text Services and Input Languages] window, [Chinese (Simplified) - Microsoft Pinyin New Experience Input Style] appears in the [Installed services] list.

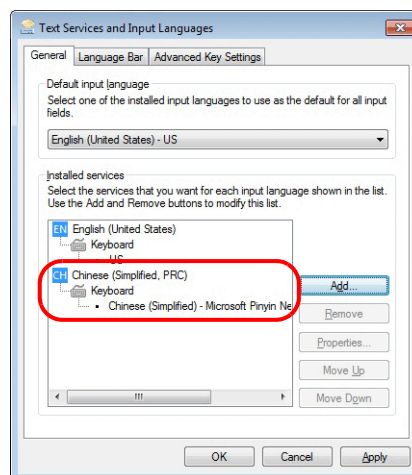

- Click [OK] to add the Chinese language ([CH Chinese (Simplified, PRC)] is added to the language bar).
The [Region and Language] window dialog is displayed again.

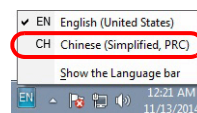

- Click [OK] to close the window.

Text entry procedure

1. Start up V-SFT version 6 and click [System Setting] → [Multi-language Setting]. In the [Font Setting] window, select [Chinese (Simplified)] under [Display Font].

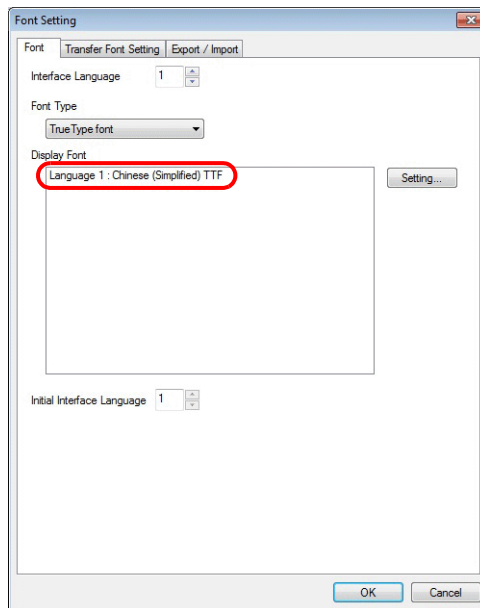

2. When editing items or entering text, select [CH Chinese (Simplified, PRC)] on the Windows 7 language bar.

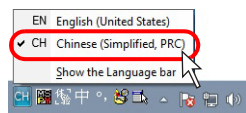

3. Type Chinese characters and place them on the screen.

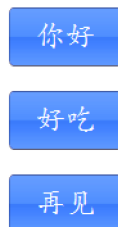

When typing in other languages, follow the same procedure.

10.4 Windows Font

Windows fonts can be displayed on the V9 series unit. Because Windows font settings can be changed for individual parts and messages, a high degree of flexibility is available for screen creation.

Windows fonts also allow for multi-language display on one screen.



With Windows fonts, it becomes possible to display multiple languages on one screen and also to switch the language (switch only the displayed characters while the screen layout remains the same). When creating this sort of multi-language screens, set the number of languages to "2" or more, select the same font (e.g. Japanese Gothic TTF) for the languages, and use necessary Windows fonts respectively for the languages (page 10-19).

10.4.1 Limitations



Note that if your computer is not installed with the Windows fonts that are used in the screen data, the computer cannot be used to edit text in those fonts.

The limitations on the use of Windows fonts:

- Windows fonts occupy a large memory space in screen program.
- Available Windows fonts differ between text in drawing/text for messages and variable text.
- When multiple languages are used on the screen together with Windows fonts, the same text properties apply to all these languages.

10.4.2 Setting Items

Depending on parts that use Windows fonts, setting items required for these parts vary. See the table below for details:

Part		Required Settings		
		Text Properties (page 10-13)	Message Editor (page 10-14)	Font Registration (page 10-15)
Text		<input type="radio"/>	---	---
Multi-text ^{*1}		<input type="radio"/>	---	---
Switch text		<input type="radio"/>	---	---
Lamp text		<input type="radio"/>	---	---
Data display	Numerical data display ^{*2}	<input type="radio"/>	---	Automatic
	Character display ^{*2}	<input type="radio"/>	---	<input type="radio"/> ^{*9}
	Message display ^{*10}	<input type="radio"/>	<input type="radio"/>	---
Table data display	Numerical data display ^{*3}	<input type="radio"/>	---	Automatic
	Character display	<input type="radio"/>	---	<input type="radio"/> ^{*9}
	Message display ^{*10}	<input type="radio"/>	<input type="radio"/>	---
	Text	<input type="radio"/>	---	---
Logging ^{*4}	Display method: Data display	<input type="radio"/> ^{*5}	---	<input type="radio"/> ^{*9}
Alarm ^{*6} ^{*7} ^{*10}		<input type="radio"/> ^{*5}	<input type="radio"/>	---
Time display		<input type="radio"/>	---	Automatic
Calendar		<input type="radio"/>	---	Automatic
Message display ^{*10}		<input type="radio"/>	<input type="radio"/>	---
Comment display		<input type="radio"/> ^{*8}	---	---

*1 There is a limit on the multi-text size as follows:

Height × length = 120,000 bytes or less per single instance of multi-text

*2 When Windows fonts are used, the option selected for [Function] must be [No Function], [Entry Display Part], [Entry Target], [Max. Value Display Part], [Min. Value Display Part] or [Digital Switch]. Windows fonts are not available with data display in graphic libraries.

*3 Windows fonts are disabled if [Max. Value Display Part], [Min. Value Display Part], or [Total Value Display] is selected for [Function].

*4 When logging data is printed out, Windows fonts are not available.

*5 For logging, configure settings on the [Data Setting] menu of the item settings window.

For alarms, configure settings on the [Contents] menu of the item settings window.

*6 Set the character ON and OFF colors in the alarm server settings. The color settings made in the message editing window are disabled.

*7 The text size in message display areas is set on the [Contents] menu of the item settings window. The text size settings made in the message editing window are disabled.

*8 Set in the comment editing window in which the comment is registered (click [Registration Item] → [Comment]).

*9 If no font is registered for a part that requires font registration, spaces are displayed in place of characters.

*10 The font selected in the [Font Setting] window (click [System Setting] → [Font Setting]) takes effect for text display (instead of Windows fonts) in the following situations:

- A part placed on the screen requires settings for both text properties and message editing, but the settings are not made completely.
- Any Windows-font-disabled part is placed.

10.4.3 Setting Procedure

 It is possible to perform Windows font settings for multiple items at once. For more information, refer to "10.4.5 Change All Windows Fonts" page 10-17.

Character Properties

1. Open the item settings window for the part.
2. Select the [Use Windows Fonts] in the [Char. Prop.] menu or select [Windows Font].

Switch

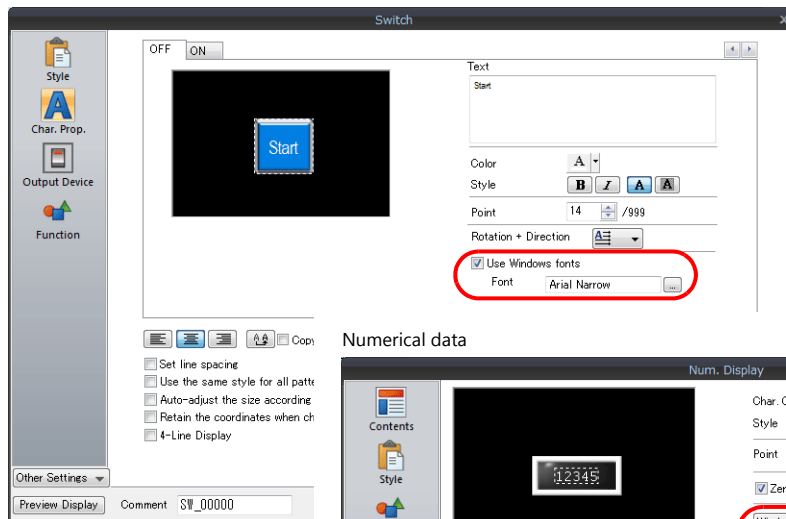

Numerical data

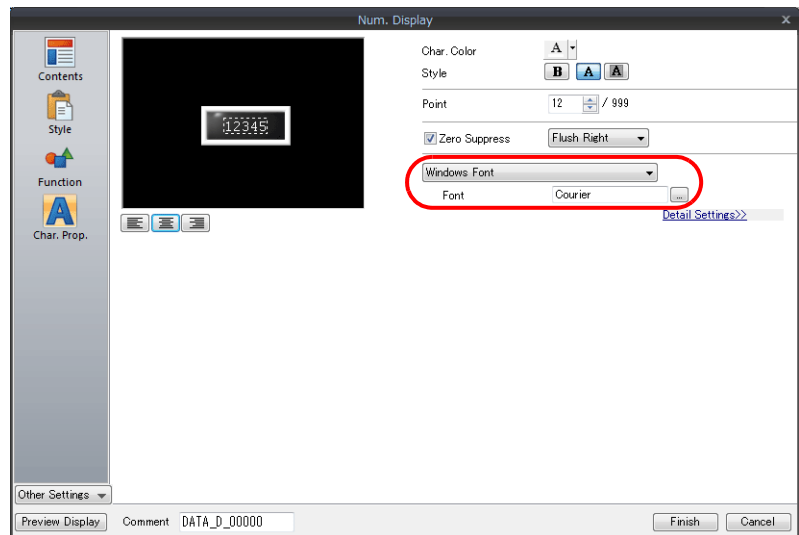

3. The name of the Windows font is displayed.



For more information on the [Windows Font Registration] button, refer to "Font Registration" page 10-15.

4. Click the button next to [Font]. In the displayed window, select the desired font name and the point size.

 For a part that also requires message editing, follow step 2 only (select the [Windows Font] checkbox). Windows font settings are made in the message editing window.



Only monospaced Windows fonts can be used for numerical data and character display parts. Proportional fonts are not available.

Example:

Font	Usable
MS Gothic	○
MS P Gothic	×
Courier	○
Arial	×

In Message Editing

1. In the item settings window for the part, click [Open] or click [Registration Item] → [Message]. The [Message Edit] window is displayed.

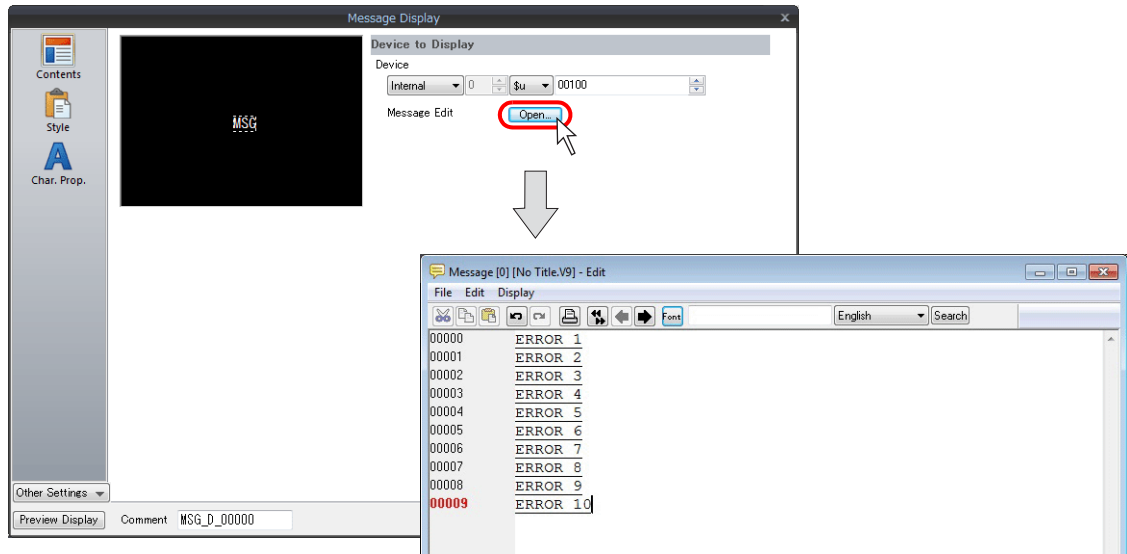

2. Select the target messages and right-click the mouse. From the right-click menu, click [Char. Prop.].

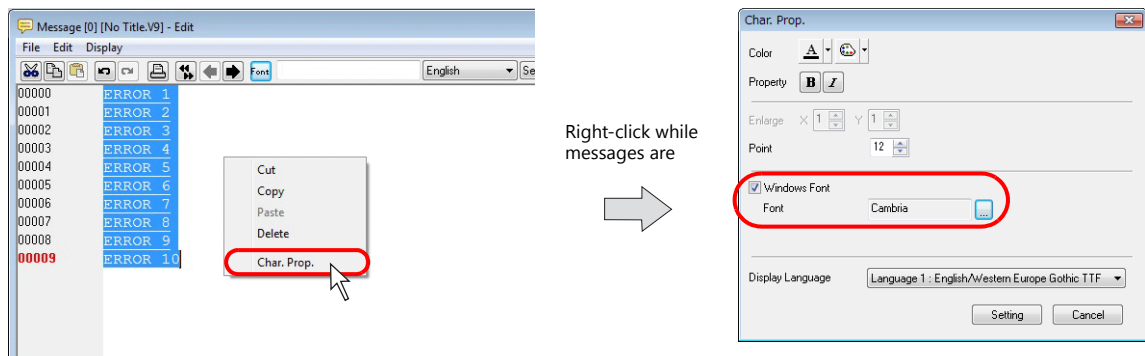

3. In the [Char. Prop.] window, select the [Windows Font] checkbox, desired color, point size, and font, etc. Click [Setting] to return to the [Message Edit] window. The window shows the messages in the Windows font as set.

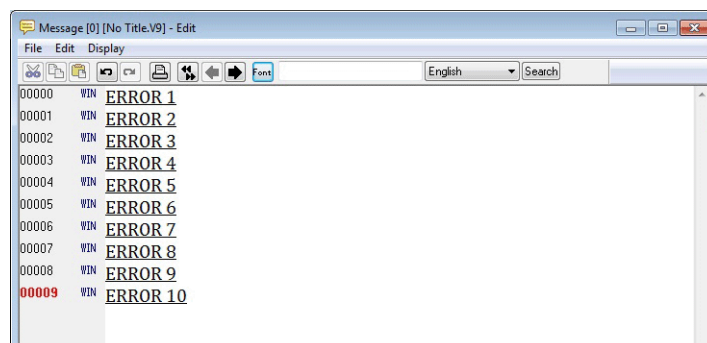

Font Registration

In the case of some parts, setting text properties for Windows fonts activates the [Windows Font Registration] button. Unlike fixed text used for text in drawing parts or message display parts, the above-mentioned parts are likely to display varied characters. Therefore, it is necessary to register all such probable characters through [Windows Font Registration] so as to make them displayable on the V9 series unit.



Characters that are not registered are displayed as spaces on the V9 series unit.

1. Select [Char. Prop.] in the item settings window of the character display.
2. Click the [Windows Font Registration] button. The [Windows Font Registration] window is displayed.

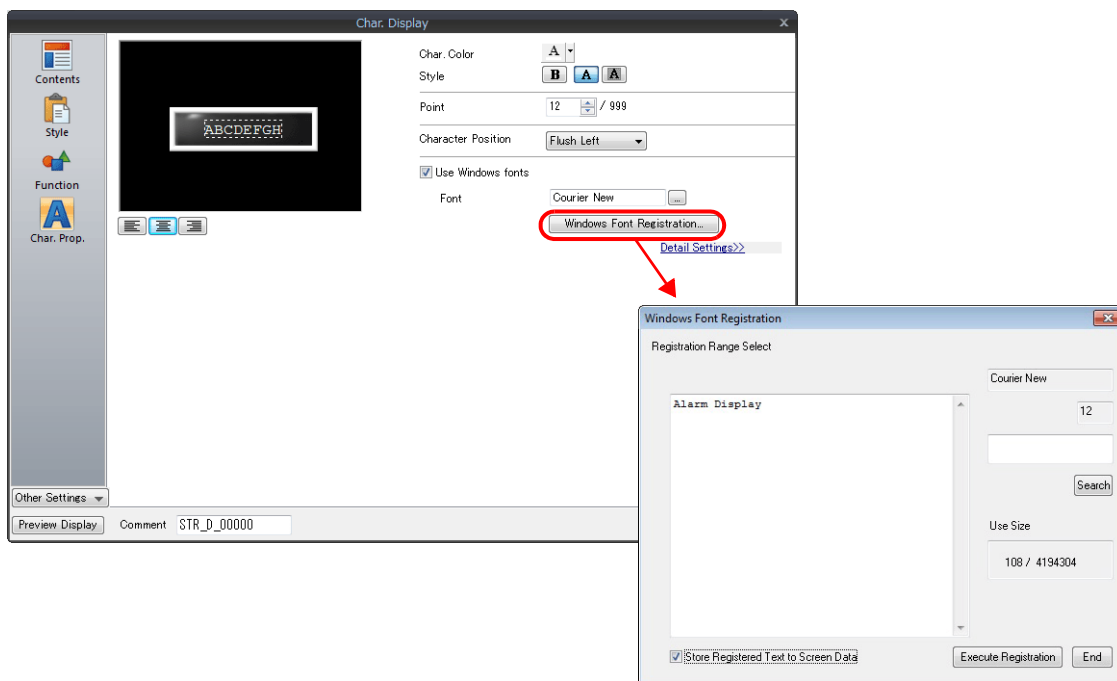

Item	Description
Registration Range Select	Register a Windows font to use to display text.
Search	This button searches the area under [Registration Range Select] for the text entered in the box. The text will be highlighted if found. Once you have registered text, you do not need to repeat its registration.
Use Size	The data size of the registered text in the currently selected font is displayed. The maximum size is 256 kB. The data size of characters in the same font and the same point size is displayed. If there are characters in the same font but in different point sizes, they are assumed to be different. These characters must be registered separately.
Store Registered Text to Screen Data	When this checkbox is selected, a font registration file ^{*1} (with an extension .txw) will not be stored on the V9 series unit. Because the file will be necessary when screen program is transferred from the V9 series unit, be sure to store the file together with the screen program. ^{*2} When this checkbox is selected, a font registration file (with an extension .txw) will be stored together with the screen program on the V9 series unit. The larger the file size, the less memory available for the screen program.
Execute Registration	This button registers the text entered under [Registration Range Select].
End	This button ends font registration.

*1 For details on the font registration file (with an extension *.txw), refer to the following page.

*2 If the txw file is lost, the registered text will be rebuilt from the screen program. However, in this case, the text is registered in character code order.

A txw file is created when saving the screen program.

Font registration file

At the time of storing screen program that includes Windows font settings, the file shown below will be stored in the same place as the screen program.

xxxxxxx.txw

File given the same name as the screen program

This file stores the text registered through font registration. Whenever you store a screen program, store the font registration file at the same time. Be sure to make no changes to the file.

Note that if the font registration file is lost or revised, the registered font data may be deleted or altered. Registration will be required again in such a case.

[Windows Font Registration] window

The [Windows Font Registration] window offers a list of the fonts registered in the screen program and their memory sizes. The font names in the window can also be changed.



The [Windows Font Registration] window only lists the fonts registered through [Windows Font Registration] for character display parts. To see other Windows fonts used in drawing parts etc., open [Windows Font List].

- Window location

Click [Tool] → [Register Windows Font]. The [Windows Font Registration] window is displayed.

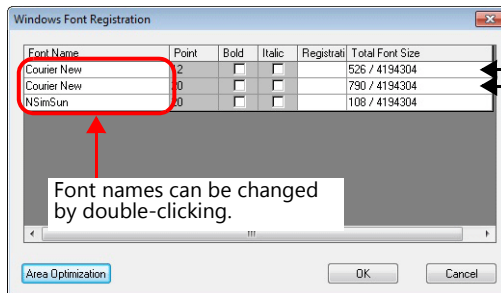

Characters in different point sizes must be registered separately even though they are in the same font.



Settings under [Point], [Bold], and [Italic] cannot be changed in the above window. If necessary, configure these settings in the item settings window of the relevant part.

- Area Optimization

If any font is changed, the data size of the text is changed accordingly and the memory area is optimized.

10.4.4 [Windows Font List] Window

The [Windows Font List] window offers a list of the Windows font names used in the screen program, setting locations, point sizes, language numbers, etc.

Window Location

Click [Tool] → [Search] → [Windows Font].

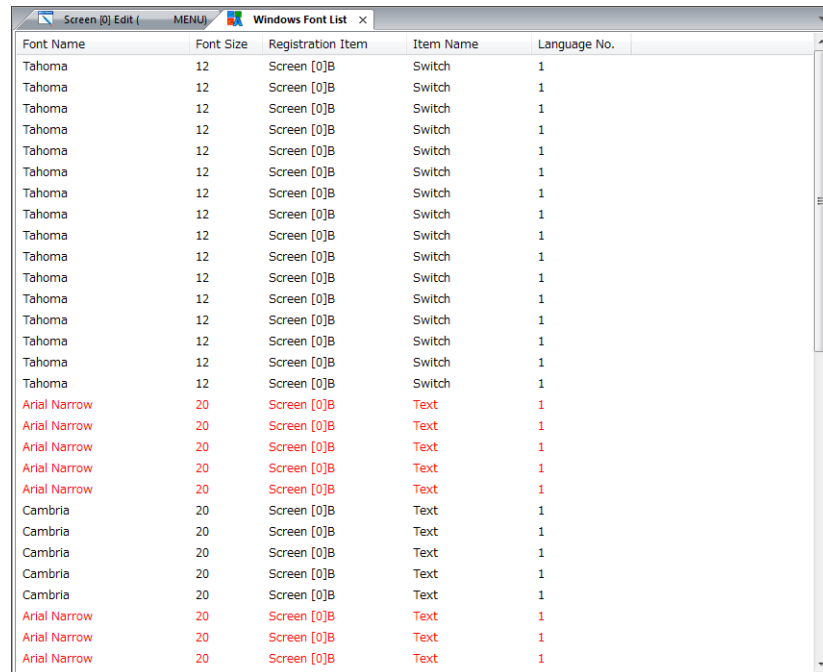

Font Name	Font Size	Registration Item	Item Name	Language No.
Tahoma	12	Screen [0]B	Switch	1
Tahoma	12	Screen [0]B	Switch	1
Tahoma	12	Screen [0]B	Switch	1
Tahoma	12	Screen [0]B	Switch	1
Tahoma	12	Screen [0]B	Switch	1
Tahoma	12	Screen [0]B	Switch	1
Tahoma	12	Screen [0]B	Switch	1
Tahoma	12	Screen [0]B	Switch	1
Tahoma	12	Screen [0]B	Switch	1
Tahoma	12	Screen [0]B	Switch	1
Tahoma	12	Screen [0]B	Switch	1
Tahoma	12	Screen [0]B	Switch	1
Tahoma	12	Screen [0]B	Switch	1
Tahoma	12	Screen [0]B	Switch	1
Tahoma	12	Screen [0]B	Switch	1
Tahoma	12	Screen [0]B	Switch	1
Tahoma	12	Screen [0]B	Switch	1
Arial Narrow	20	Screen [0]B	Text	1
Arial Narrow	20	Screen [0]B	Text	1
Arial Narrow	20	Screen [0]B	Text	1
Arial Narrow	20	Screen [0]B	Text	1
Arial Narrow	20	Screen [0]B	Text	1
Arial Narrow	20	Screen [0]B	Text	1
Cambria	20	Screen [0]B	Text	1
Cambria	20	Screen [0]B	Text	1
Cambria	20	Screen [0]B	Text	1
Cambria	20	Screen [0]B	Text	1
Cambria	20	Screen [0]B	Text	1
Arial Narrow	20	Screen [0]B	Text	1
Arial Narrow	20	Screen [0]B	Text	1
Arial Narrow	20	Screen [0]B	Text	1

- Double-clicking a font name in the window causes a jump to the screen where the font is set.
- If a font that is not installed on your computer is used in the screen program, its name is colored red.
For more information, refer to "Windows Fonts Not Installed on Your Computer Exist in a Screen Program" (page 10-20).

10.4.5 Change All Windows Fonts

It is possible to make/cancel/change all Windows font settings at once.

Procedure

1. Click [Tool] → [Windows Font].
2. From the displayed sub-menu, select an item according to your purpose.

Item	Description
Change All	Select this item when making changes to all items in the screen program you are currently editing.
Current Window Change	Select this item when making changes to all items in the window you are currently editing.
Selected Item	Select this item when making changes to selected items.

3. The [Change All Windows Fonts] window is displayed.

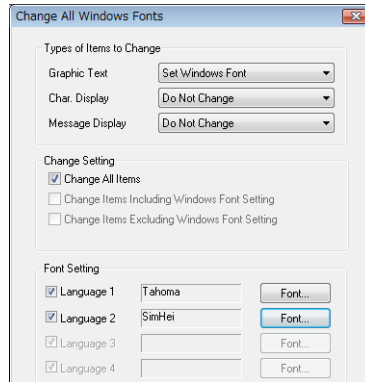

Item	Description						
Types of Items to Change	<p>Select items to which batch setting applies.</p> <ul style="list-style-type: none"> Do Not Change Reset Windows Font Set Windows Font <p>The target items and their categories are:</p> <table border="1"> <tr> <td>Graphic text</td> <td>Text Multi-text Comment display Text on switch/lamp Table data display (text)</td> </tr> <tr> <td>Character display *1</td> <td>Numerical display Character display Table data display (numerical data/character) Logging parts Time display Calendar</td> </tr> <tr> <td>Message display *2</td> <td>Message display Table data display (message) Message mode Alarm parts</td> </tr> </table>	Graphic text	Text Multi-text Comment display Text on switch/lamp Table data display (text)	Character display *1	Numerical display Character display Table data display (numerical data/character) Logging parts Time display Calendar	Message display *2	Message display Table data display (message) Message mode Alarm parts
Graphic text	Text Multi-text Comment display Text on switch/lamp Table data display (text)						
Character display *1	Numerical display Character display Table data display (numerical data/character) Logging parts Time display Calendar						
Message display *2	Message display Table data display (message) Message mode Alarm parts						
Change Setting	<ul style="list-style-type: none"> Change All Items Change Items Including Windows Font Setting Change Items Excluding Windows Font Setting 						
Font Setting	Press the [Font] button. In the displayed window, select the desired font.						

*1 Proportional fonts are not available for character displays (page 10-13).
If you attempt to use such a font, the following error message appears.
Select a non-proportional font instead.

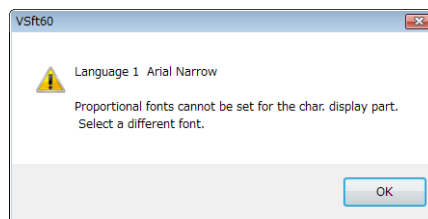

*2 In the case of message displays, batch change applies to only the style of each item.
If you change Windows font settings for messages registered through the [Registration Item] menu, manual setting is required.

4. When the settings are complete, click [OK].



Note that once a batch change is executed, it is not possible to undo the operation.

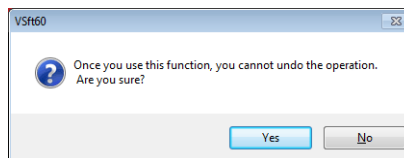

5. Batch change has been completed.

10.4.6 Windows Fonts for Language Selection

Some limitations, however, apply to the above.

Conditions for Language Selection Using Windows Fonts

- [Font Setting]
For the interface languages, select the same font (the [Font Setting] window).
- Screen program capacity
Windows fonts will occupy a large memory space in the screen program. Check available memory constantly. In comparison to the amount of memory consumed for a screen program without Windows fonts, the amount may double if Windows fonts are used.
- Text properties
Except for the font type selection, the same text properties apply to the languages.
For all the languages, [Windows Font] must be checked, and the other properties including the point size must be the same. Therefore, checking [Windows Font] for only one of the languages (the second language, for example) is not allowed.

Multi-Language Editing Using Windows Fonts

- Multi-language editing is performed basically on the screen in the editor software or in the [Multi-language (n) Edit] window (click [Registration Item] → [Multi-language]).



If text converted to a CSV file ([System Setting] → [Font Setting] → [Export]) is read into other editing software, whether or not this operation is supported depends on which language is used. Whenever you wish to use [Export], consult with your local distributor.

- If any language is incorrectly displayed in the [Multi-language (n) Edit] window, click [Edit] → [Multi-language Setting] and select the correct font in the [Multi-language Edit Setting] window.

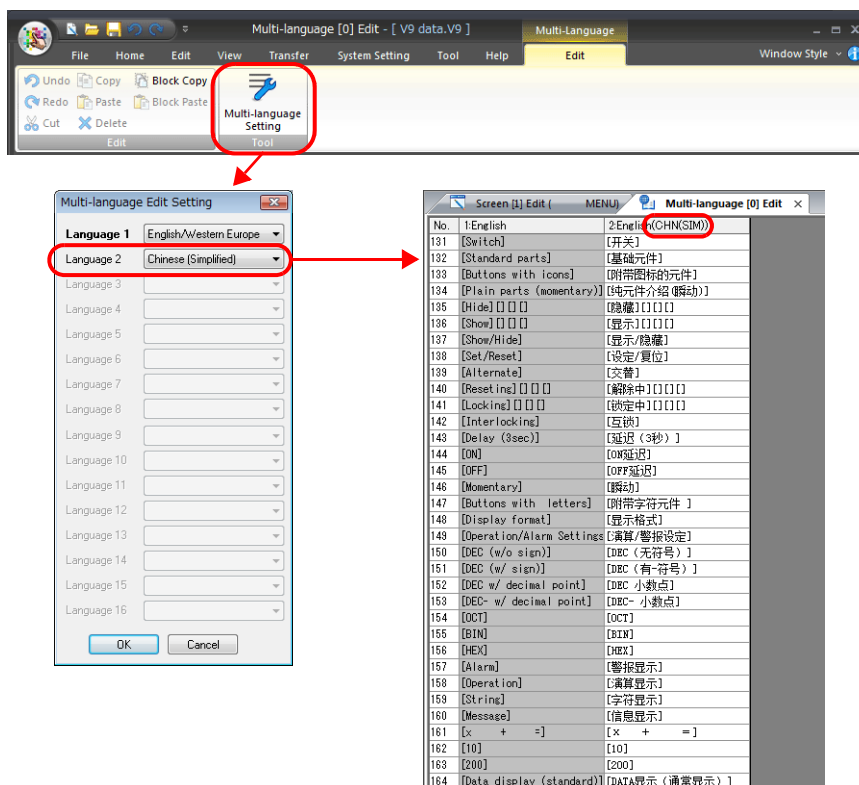

10.4.7 Windows Fonts Not Installed on Your Computer Exist in a Screen Program

If any Windows fonts that are not installed on your computer are used in a screen program, the text in such fonts cannot be edited or modified. For this reason, enhanced search and prohibition functions which check if fonts that are not installed on your computer are used, and locate areas where editing/modification is prohibited are provided.

When Opening a File

Example:

In a case where you tried to open a screen program including the Arial Narrow font although the font is not installed on your computer:

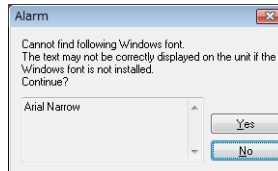

To open the file, click [Yes]. To cancel, click [No].

When Error Checking is Performed

The execution of an error check detects any fonts that are not installed on your computer.

Category	Location	Explanation	Solution
Warning	Screen[0] Text	An uninstalled Windows font has been specified.	Set Windows font again.
Warning	Screen[0] Multi Text	An uninstalled Windows font has been specified.	Set Windows font again.
Warning	Screen[0] Multi Text	An uninstalled Windows font has been specified.	Set Windows font again.
Warning	Screen[0] Switch	An uninstalled Windows font has been specified.	Set Windows font again.
Warning	Screen[0] Switch	An uninstalled Windows font has been specified.	Set Windows font again.

When Viewing Text Properties

Any font name that is not installed on your computer is colored red.

While such a font is selected, registered text and point size cannot be modified.

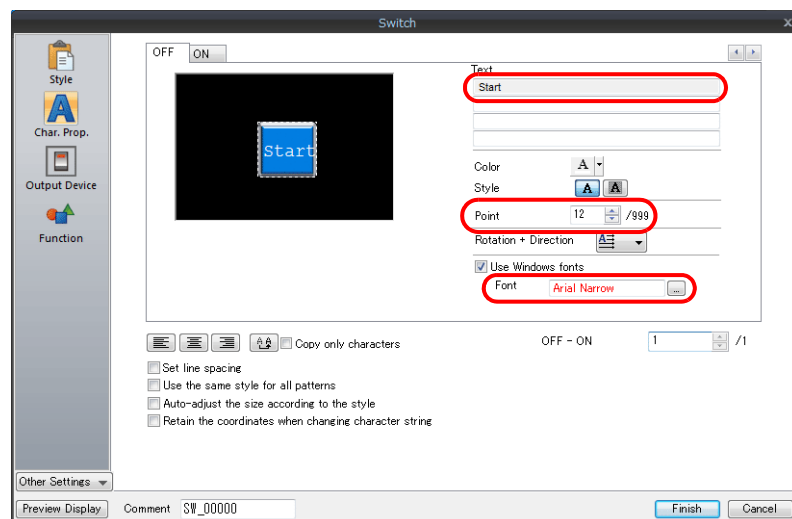

When Enlarging/Reducing

If you try to enlarge or reduce any item for which a font that is not installed on your computer is used, the following error message appears and the item is restored to the original size.

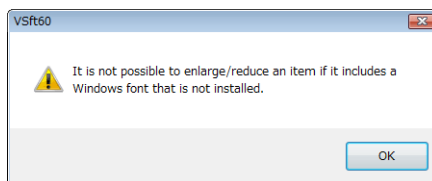

[Windows Font List] Window

If any Windows font used in a screen program is not installed on your computer, the location where the font is set is shown in the [Windows Font List] tab window.

Font Name	Font Size	Registration Item	Item Name	Language No.
Tahoma	12	Screen [0]B	Switch	1
Tahoma	12	Screen [0]B	Switch	1
Tahoma	12	Screen [0]B	Switch	1
Arial Narrow	20	Screen [0]B	Text	1
Arial Narrow	20	Screen [0]B	Text	1
Tahoma	12	Screen [0]B	Switch	1
Tahoma	12	Screen [0]B	Switch	1

[Windows Font Registration] Window

Windows fonts used for character displays are listed in the [Windows Font Registration] window.

If any Windows font that is not installed on your computer is used, the font name is colored red also in this window. Size change and additional registration are not allowed for the font.

Font Name	Point	Bold	Italic	Registrat	Total Font Size
Courier New	14	<input type="checkbox"/>	<input type="checkbox"/>		1252 / 4194304
Consoles	20	<input type="checkbox"/>	<input type="checkbox"/>		1824 / 4194304

MEMO

MONITOUCH

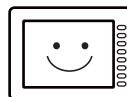

11 Parts Editing

11.1 Parts

11.2 Selecting from Images Files

11.3 Changing Placed Parts

11.4 Component Parts

11.1 Parts

Parts are selectable from the parts files included in the editor.
If a desired part does not exist, the user can also create a part.
The following methods are available for creating parts.

- Selecting user-prepared image files (*.png/*.bmp) and changing them into the desired designs



For more information, refer to "11.2 Selecting from Images Files" page 11-1.

- Drawing using shapes such as rectangles and lines



For more information, refer to "11.3 Changing Placed Parts" page 11-10.

11.2 Selecting from Images Files

User-created image files (*.png/*.bmp) are usable for designing parts such as switches.
Image files can be used to either create a new part from the image file or applying the image file to a part already placed on the screen.



Selected image files are copied to the "MONITOUCH\User\Parts" folder as *.png files and used as part images.
Deleting any files currently in use from this folder causes an error 91 to occur on the V9 series unit.



Some switch and lamp parts cannot be applied image files.

- Switch parts
[Shape]: 2D, [Group]: Square2

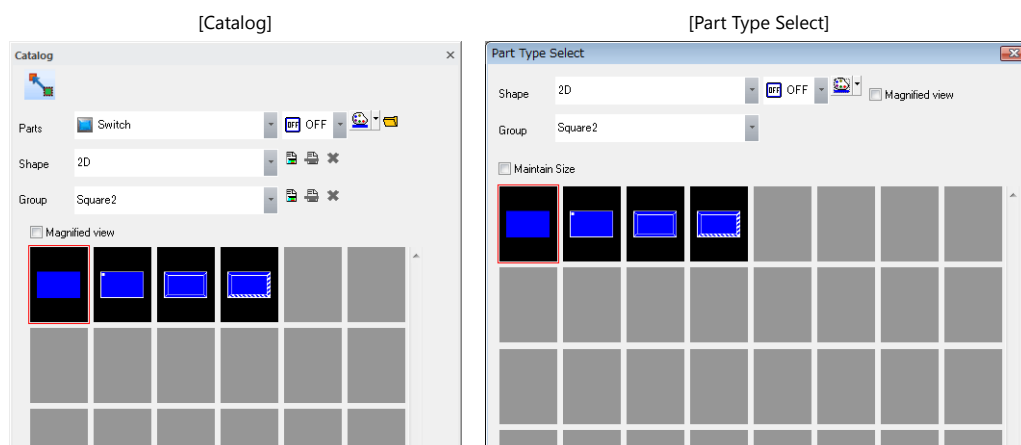

- Lamp parts
[Shape]: 2D, [Group]: Square2

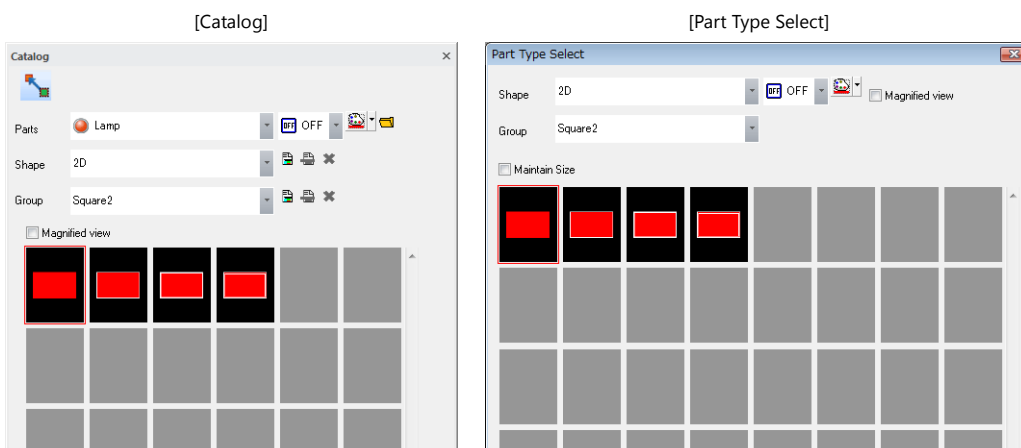

11.2.1 Setting Procedure

Using an Image File on a Placed Part

This section explains the procedure for changing the design of a lamp part. The same procedure applies to other kinds of parts.

1. Display the [Lamp] item settings window, click the [Style] menu item, and select [Area Setting] → [Select from image files].

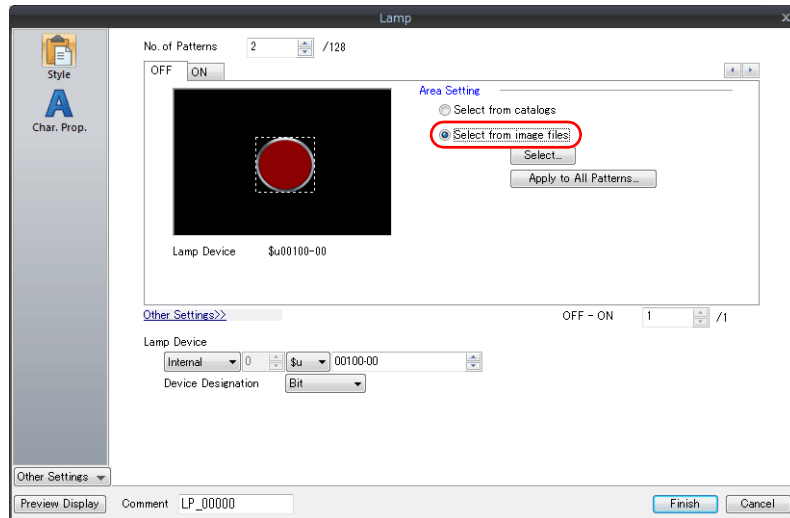

2. Click [Select] to display the [Open] window.

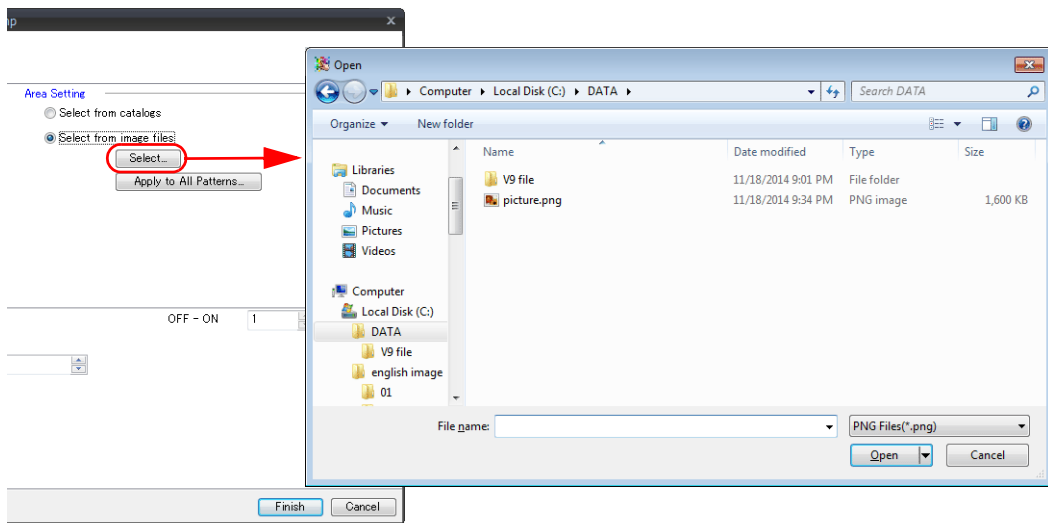

3. Select an image file and click the [Open] button.

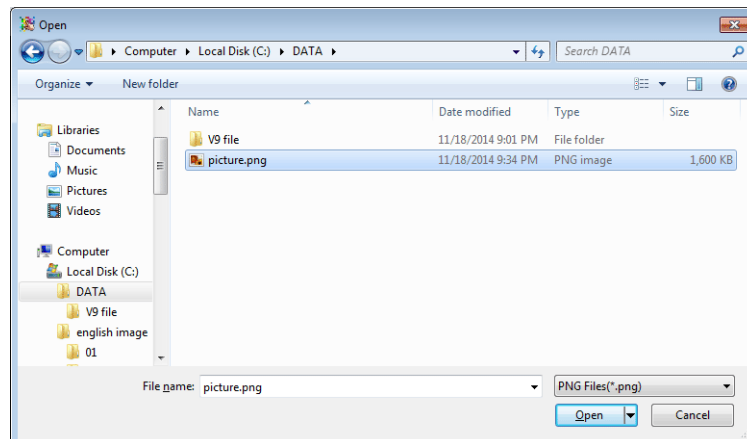

- The selected image file and filename are displayed in the item settings window. Perform steps 1 to 3 for each pattern of the lamp part.

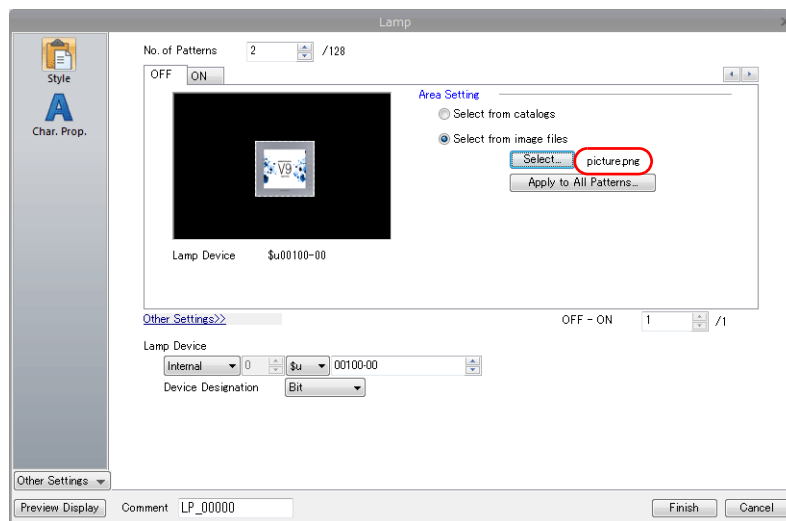

For switch and lamp parts, different image files must be used for each pattern. If not, error 91 will occur on the V9 series unit.

Apply to all patterns (switches and lamps only)

It is possible set images files for all patterns. A three-pattern switch is used as an example in the following explanation.

- Click [Apply to All Patterns] to display the following pattern list window.

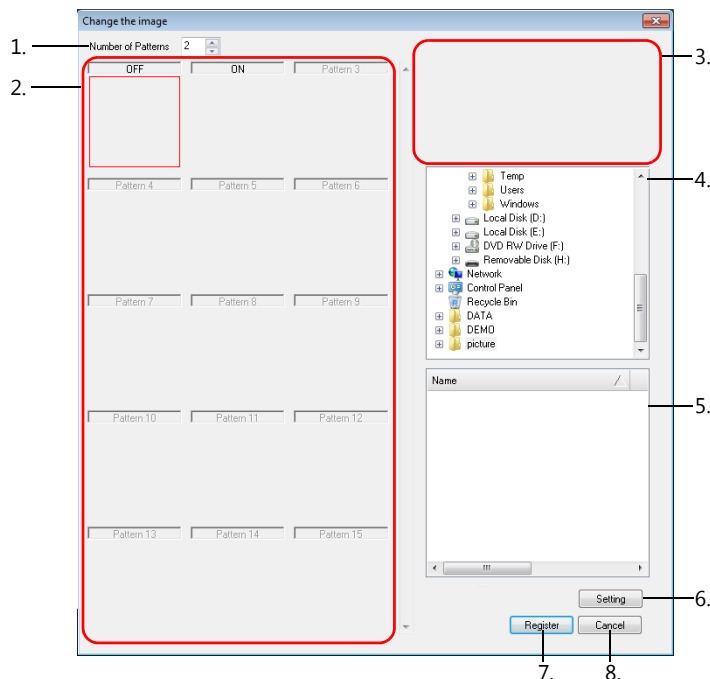

Item	Description
1.	Number of Patterns Set the number of patterns of the switch or lamp.
2.	Pattern selection area Select the pattern whose image file is to be changed. The image file set for each pattern is displayed.
3.	Preview A preview of the image file selected in the file selection area is displayed.
4.	Folder selection area Select the folder that stores the desired image file.
5.	File selection area Any image files stored in the folder specified in the folder selection area are displayed. Select the image file to use for the selected pattern.
6.	Setting Apply the image file selected in the file selection area to the selected pattern.
7.	Register Accept the changes specified in the [Change the image] window.
8.	Cancel Cancel any settings made.

- Set [Number of Patterns] to "3".

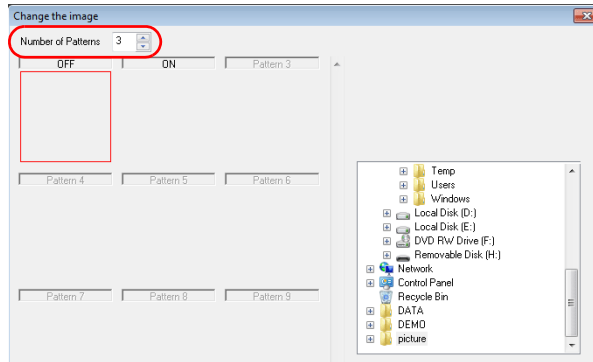

- Select the [OFF] pattern and select an image file.

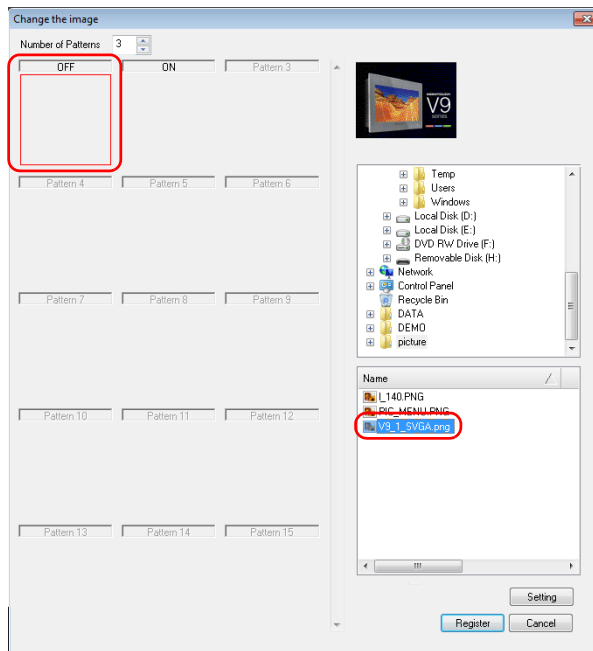

- Click [Setting] to display the image selected for the [OFF] pattern.

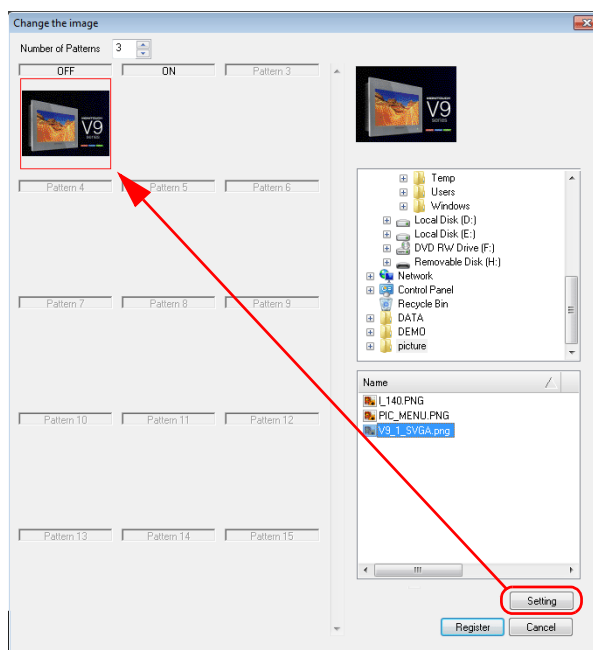

5. Select an image for the [ON] pattern and [Pattern 3] in the same manner.

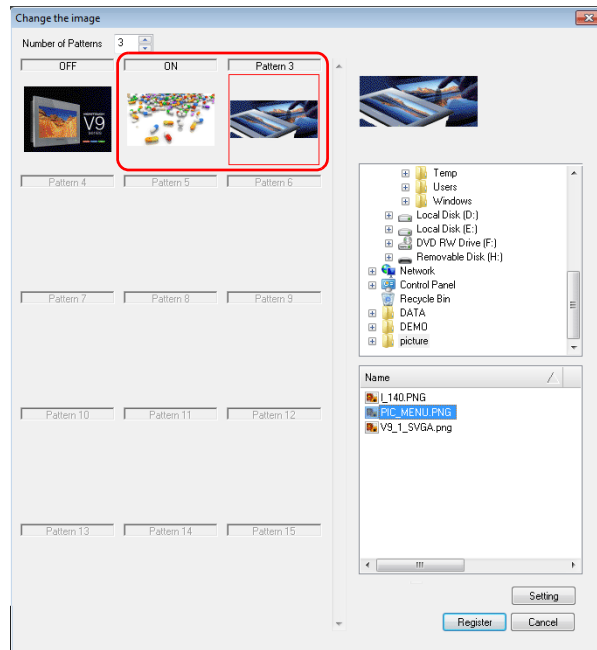

6. Click [Register] to apply the selected image files and return to the item settings window.

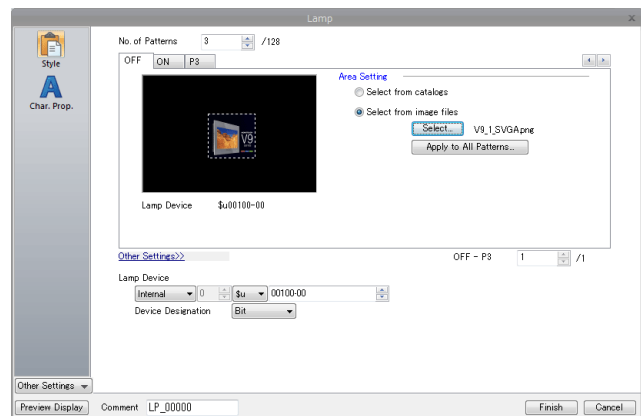
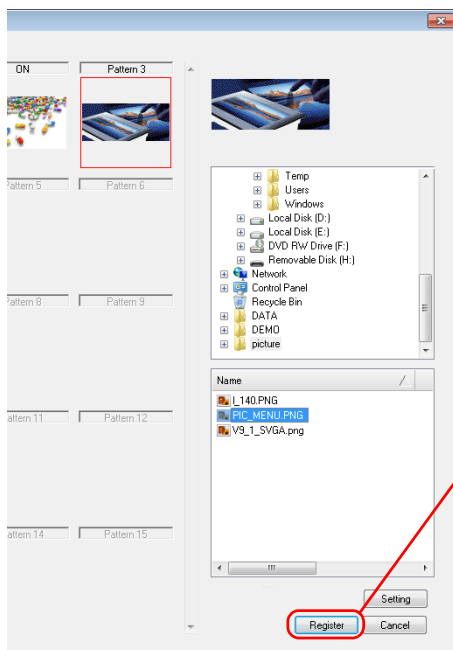

Creating New Parts from Image Files

The following two methods are available.

- Creating additional parts using the catalog

 For more information, refer to the next page.

- Creating new parts via [Parts] → [Pattern] → [Parts]

 For more information, refer to "3.6.3 Pattern" in "3 Placing Parts" page 3-83.

Creating additional parts using the catalog

This section explains the procedure for changing the design of a three-pattern lamp. The same procedure applies to other kinds of parts.

1. Click [Parts] → [Catalog] to display the [Catalog] view window.

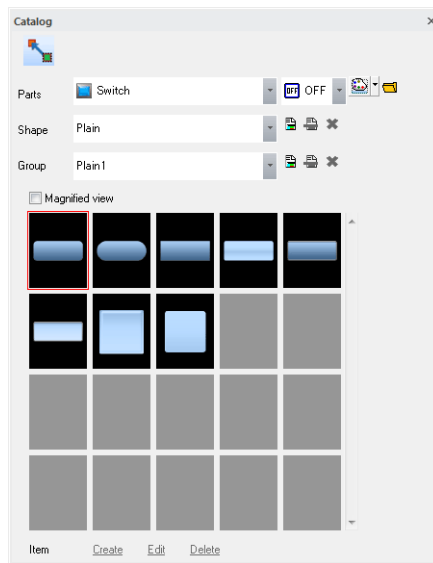

2. Select the type of part to create with the [Parts] setting.

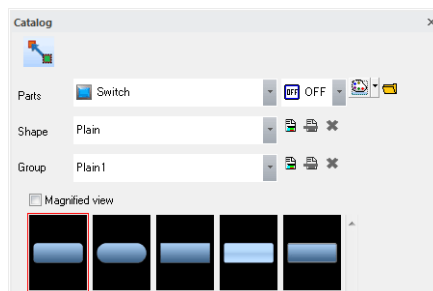

3. Click the add shape icon. [Custom Shape 00] is added to [Shape] and [Custom Group 00] is added to [Group]. The shape and group names can be changed by clicking the shape name change icon and group name change icon.

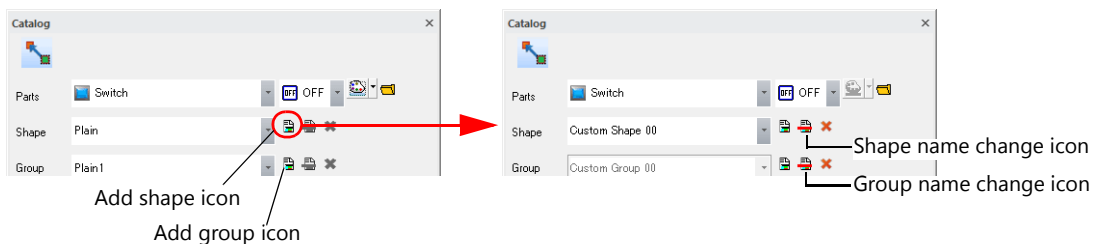

4. Click [Create] next to [Item] at the bottom of the view window.
The following window is displayed.

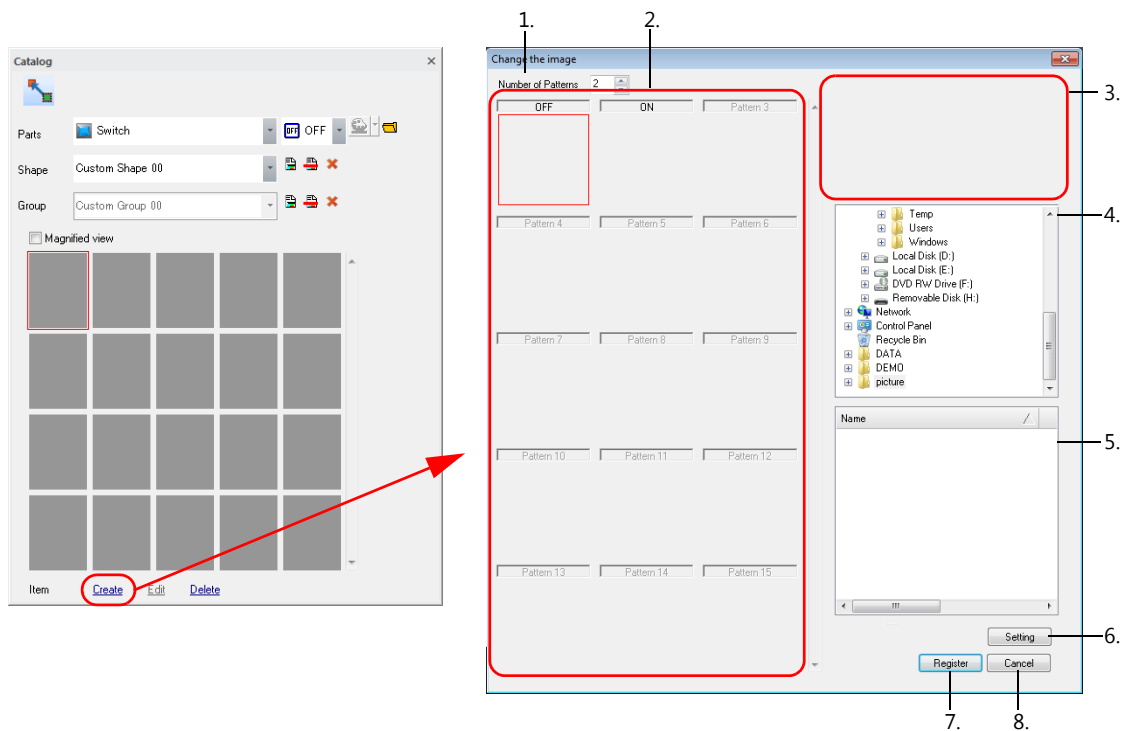

Item	Description	
1.	Number of Patterns	Set the number of patterns of the switch or lamp.
2.	Pattern selection area	Select the pattern whose image file is to be changed. The image file set for each pattern is displayed.
3.	Preview	A preview of the image file selected in the file selection area is displayed.
4.	Folder selection area	Select the folder that stores the desired image file.
5.	File selection area	Any image files stored in the folder specified in the folder selection area are displayed. Select the image file to use for the selected pattern.
6.	Setting	Apply the image file selected in the file selection area to the selected pattern.
7.	Register	Accept the changes specified in the [Change the image] window.
8.	Cancel	Cancel any settings made.

5. Set [Number of Patterns] to "3".

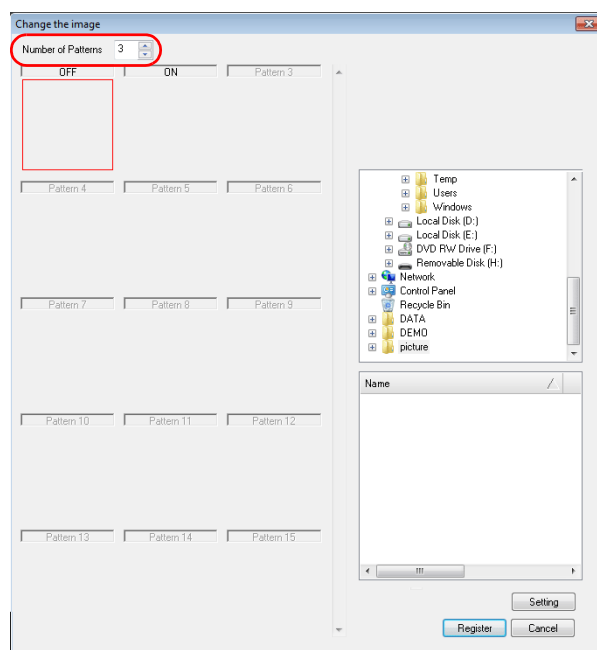

6. Select the [OFF] pattern and select an image file.

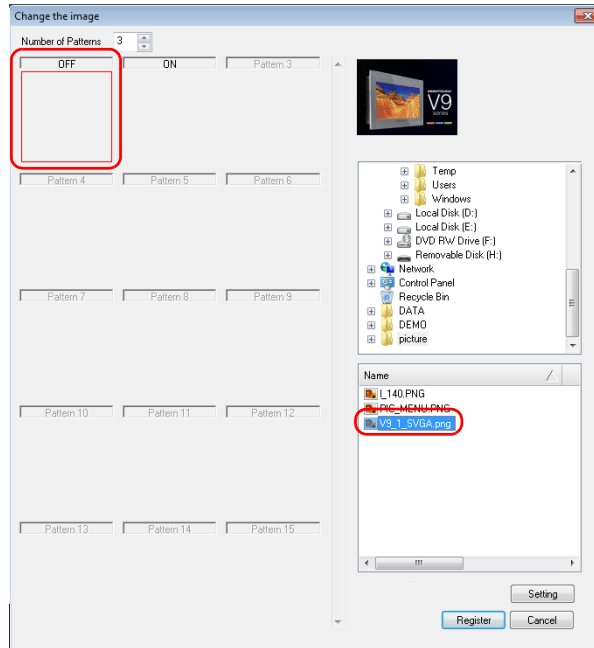

7. Click [Setting] to display the image selected for the [OFF] pattern.

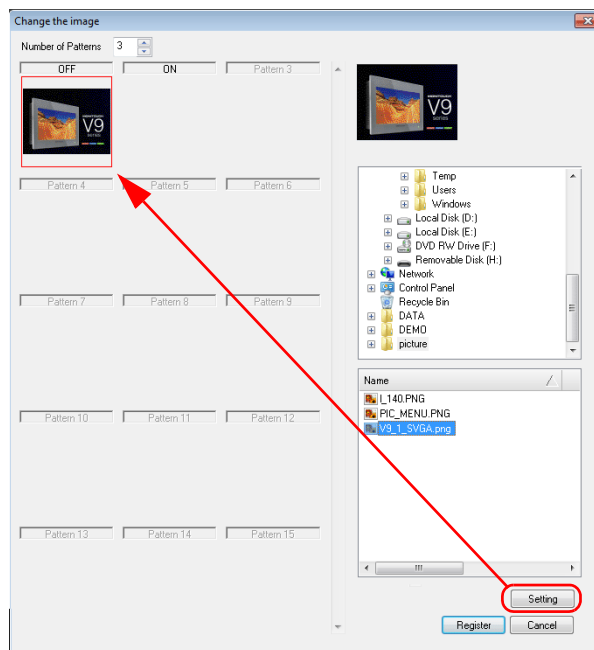

8. Select an image for the [ON] pattern and [Pattern 3] in the same manner.

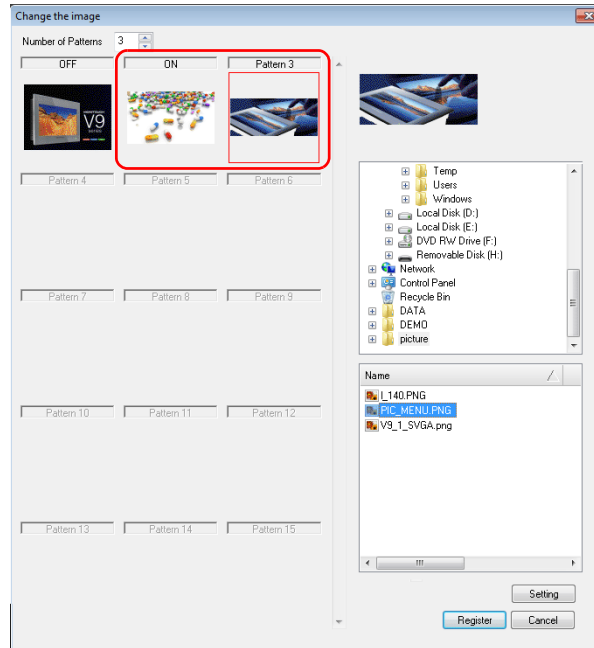

9. Click [Register] to apply the selected image files and add them to the [Catalog] view window.

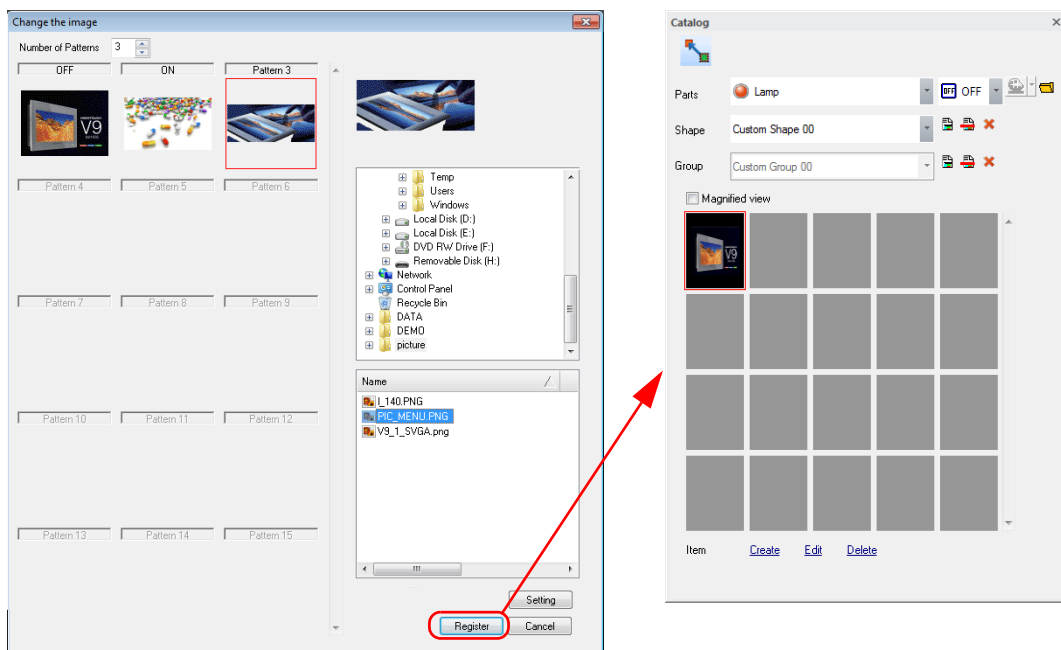

- An image file of an added part can be changed by clicking [Edit] in the [Catalog] view window.
An added part can be deleted from the catalog by clicking [Delete] in the [Catalog] view window.

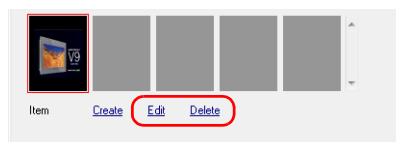

- An added custom shape can be deleted by clicking the delete shape icon in the [Catalog] view window.
An added custom group can be deleted by clicking the delete group icon in the [Catalog] view window.

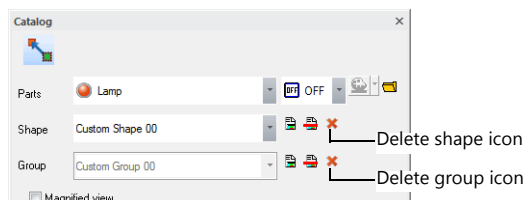

11.3 Changing Placed Parts

11.3.1 Part Structure

Parts have different properties but their structures are all the same. The components of a part are the basic area that possesses part properties, the graphic data, and the frame (part area) that denotes the overall size (involving the basic area and the graphic data) of the part.

Example: Switch part

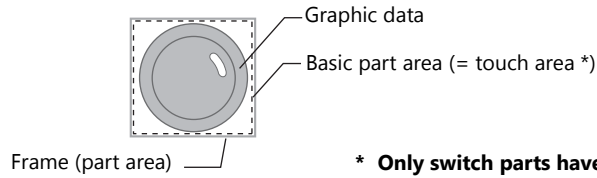

* Only switch parts have a touch area.

11.3.2 Editable Parts

The parts listed below are editable.

Part		Refer to
Overlap		page 11-13
Switch/Lamp		page 11-14
Data Display	Numerical Display	page 11-18
	Character Display	
	Message Display	
Keypad		page 11-19
Slider Switch		page 11-19
Graph	Bar Graph	page 11-20
	Pie Graph	page 11-21
	Closed Area Graph	page 11-24
	Panel Meter	page 11-26
	Statistic Bar Graph	page 11-27
	Statistic Pie Graph	page 11-28
Trend		page 11-29
Trend (display method: Data Display)		page 11-31
Display area		page 11-30
Calendar		page 11-32

11.3.3 Displaying the [Modify Part] Tab Window

Display Procedure

1. Select the part to modify placed on the screen.

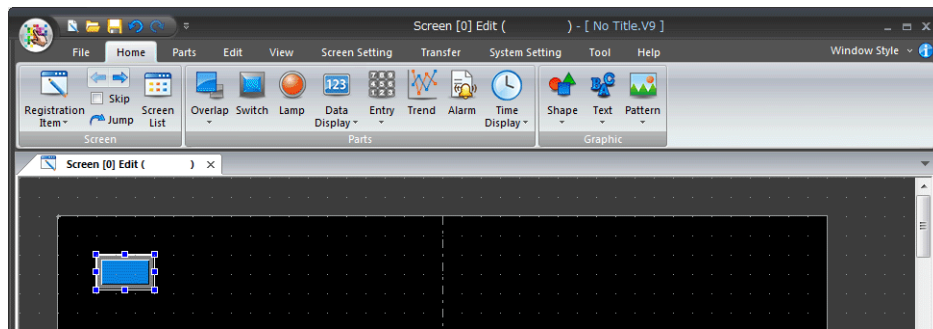

2. Use any of the following methods to display the [Modify Part] tab window.
 - Click [Edit] → [Change Part] → [Modify Part].
 - Right-click → [Change Part] → [Modify Part].

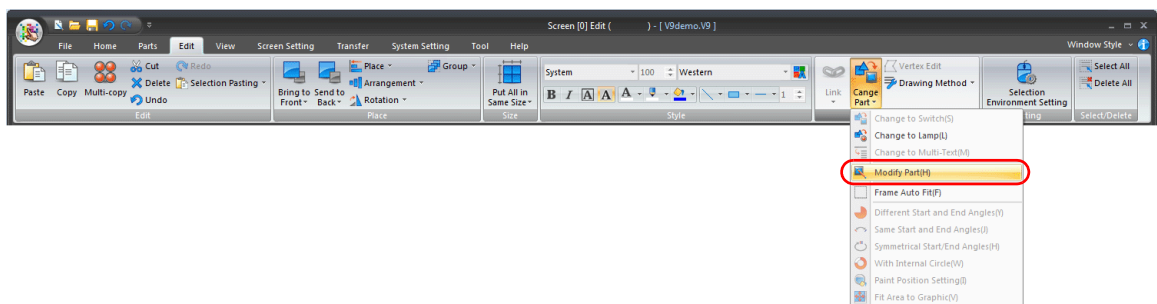

or

Right-click

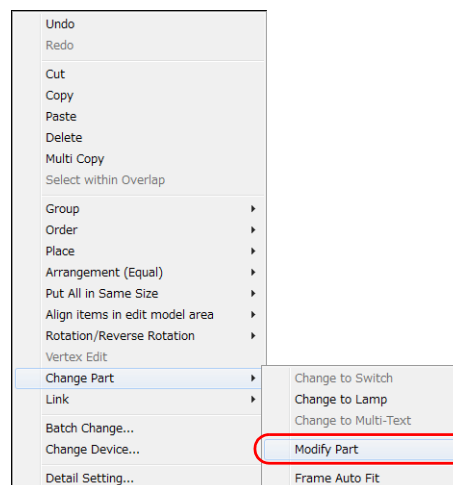

Closing the Tab Window

1. When the part editing is complete, use any of the following methods to close the [Modify Part] tab window.
 - Click [Edit] → [Change Part] → [Modify Part].
 - Click the [X] mark on the window tab.

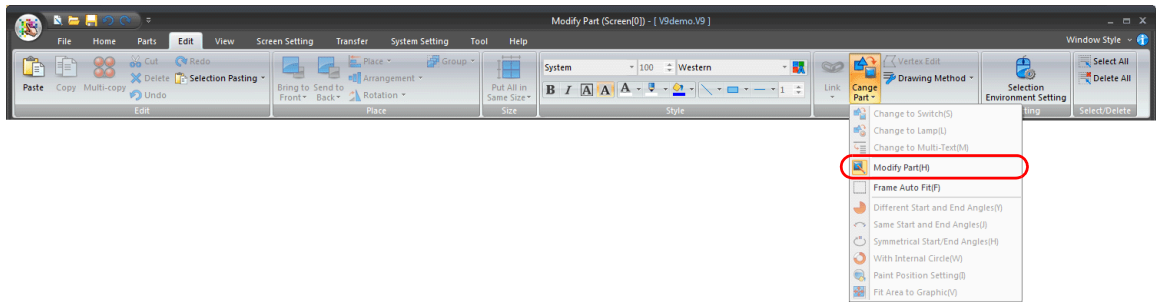

OR

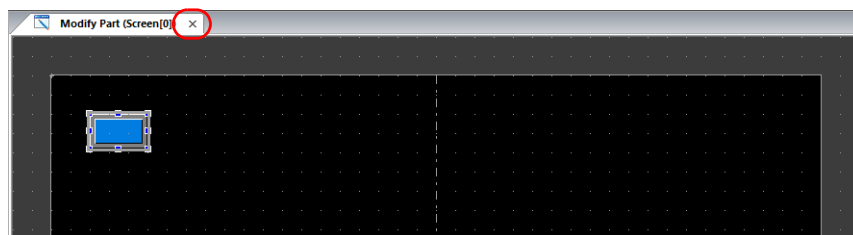

2. The previous screen reappears.

11.3.4 Editing Parts

Overlap

Structure



* **Overlap display parts are provided with no frame.**

Editing procedure

This section explains the procedure for editing a normal overlap display part. Follow the same procedure as when registering an overlap display into the overlap library ([Home] → [Registration Item] → [Overlap Library]).

1. Select the overlap display placed on the screen and display the [Modify Part] tab window.
2. Use drawing parts etc. to edit the design as desired.
For more information on editing with drawing parts, refer to "3.6.1 Shape" page 3-48.



- Drawing outside the basic part area is invalid. Perform all drawing inside the basic part area.
- The color of the basic part area can be selected in the item settings window of the overlap display on the base screen.

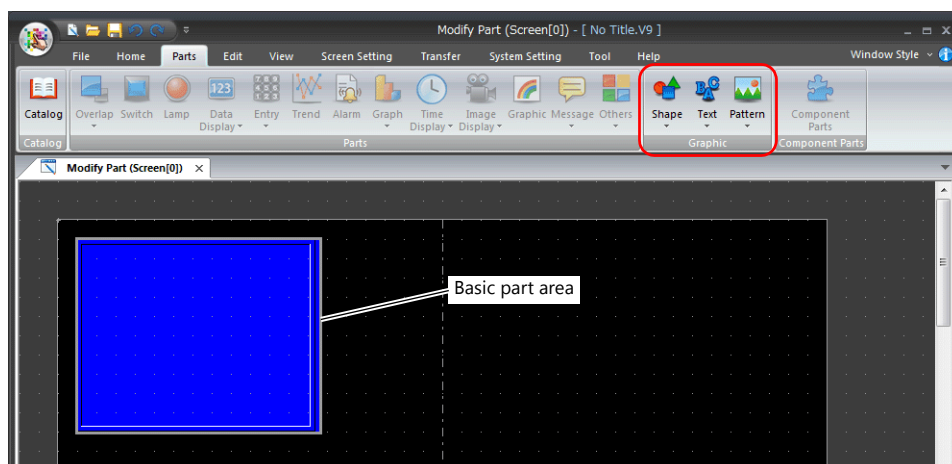

3. Return to the base screen.

Switch/Lamp

Structure

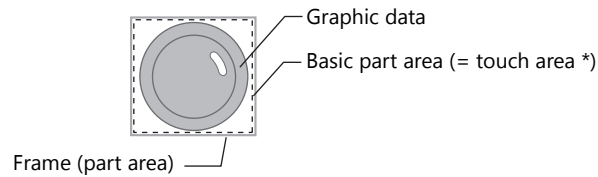

* Only switch parts have a touch area.

Editing procedure

This section explains the procedure for editing a switch part. The same procedure applies to lamp part editing.

1. Select a switch part placed on the screen and display the [Modify Part] tab window.

2. Use drawing parts etc. to edit the design as desired.

For more information on editing with drawing parts, refer to "3.6.1 Shape" page 3-48.

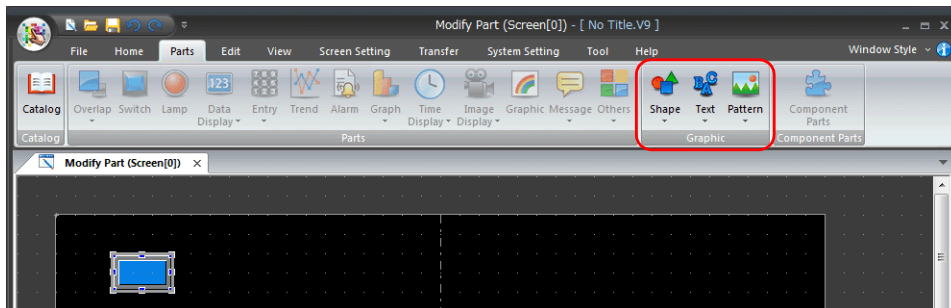

3. When editing other patterns of the switch, click [View] → [State Change] to select a pattern from [OFF], [ON], [P3] and after, and then edit according to step 2.



- When creating a switch or lamp, the graphic of the ON pattern is placed over the graphic of the OFF pattern. Even a slight deviation from each other will not display the switch or the lamp correctly. In the [Modify Part] tab window, copy the graphic of the OFF pattern, change the tab window to the tab window for ON pattern editing, and paste the copy to the tab window.
- Whether the patterns (OFF, ON, P3 and after) of an edited switch or lamp are displayed on the V9 series unit as intended depends on the [Draw Mode] setting (XOR or REP) on the [Style] menu of the item settings window. Extra care is needed in this mode setting.

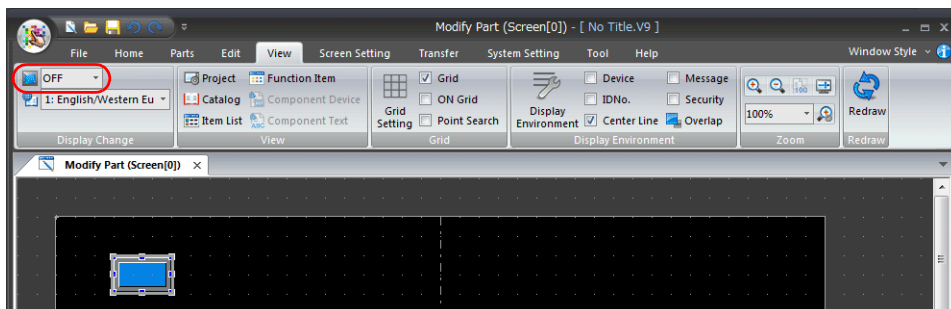

* For more information on the properties of drawing parts, refer to "Properties of graphic frames and areas" (page 11-15).

4. When editing the patterns of the switch is complete, set its touch area again.

For more information on the setting method, "Re-setting the touch area" (page 11-15).



- Lamp parts do not have a touch area. Set the basic part area again.
For more information on the setting method, refer to "Re-setting the basic part area" (page 11-16).

5. Set the frame again.

For more information on the setting method, refer to "Re-setting the frame" (page 11-17).

6. Return to the base screen.

Properties of graphic frames and areas

In the case of editing a switch or lamp part, frame and area properties can be set for the graphics of ON and OFF patterns. Once a pattern of a switch or lamp is set with the frame property ([Frame Prop.]) or area property ([Area Property]) setting, its color can be changed directly from the [Switch] or [Lamp] item settings window. When [Frame Prop.] or [Area Property] is selected, its corresponding color setting can be made in the following location:

Graphic Properties		On Switch / Lamp
Editing the OFF pattern graphic	Frame property	OFF frame color
	Area property	OFF color
Editing the ON pattern graphic	Frame property	ON frame color
	Area property	ON color

- Editing the OFF pattern graphic

- Editing the ON pattern graphic

*** The same applies to lamp parts.**

Re-setting the touch area

Every switch part has a touch area. Pressing the touch area activates the switch. If the graphic data of a switch part deviates from the touch area during editing, the switch may become inactive or may be activated by pressing anywhere outside the switch. Re-setting the touch area is required to avoid such a deviation problem.

When a switch is placed on V-SFT, its dotted frame denotes the touch area.

There are the following two methods of touch area setting:

- Dragging
 - 1) Select the dotted frame of the target switch part or click [View] → [View] → [Item List], and select the target switch part.
 - 2) Handles now appear around the basic area. Drag one of the handles with the mouse.

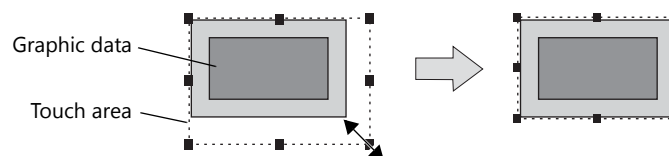

- Move to an arbitrary position
 - 1) In the right-click menu, click [Touch Area Setting]. A crosshair appears.

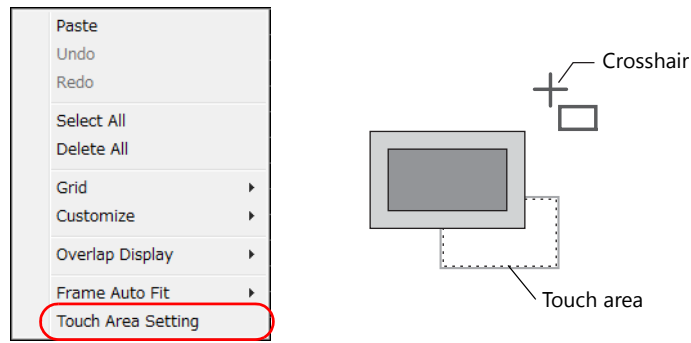

- 2) Adjust the touch area to the desired position by dragging the crosshair.

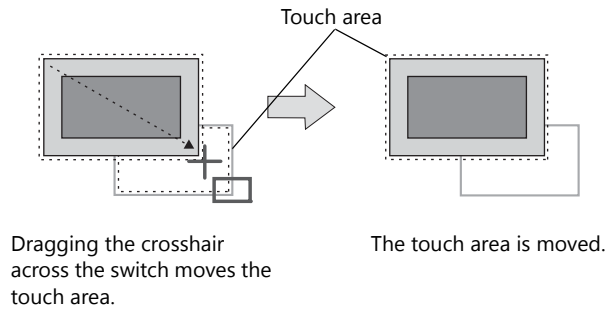

Re-setting the basic part area

Parts have a basic part area*. This area serves as the part recognition range.

For example, if an edited graphic of a lamp part deviates from its basic area, the ON and OFF patterns of the lamp will not be switched correctly due to the deviation.

Re-setting the basic part area is required to avoid such a deviation problem.

When a part is placed on V-SFT, its dotted frame denotes the basic part area.

The following section uses a lamp part as an example to explain the procedure for setting a basic part area.

- * **As for a switch part, its touch area is equivalent to the basic part area.**
For more information on how to re-set the touch area, refer to "Re-setting the touch area" (page 11-15).

- 1) Select the dotted frame of the target lamp part or click [View] → [View] → [Item List], and select the target lamp part.
- 2) Handles now appear around the touch area. Drag one of the handles with the mouse.

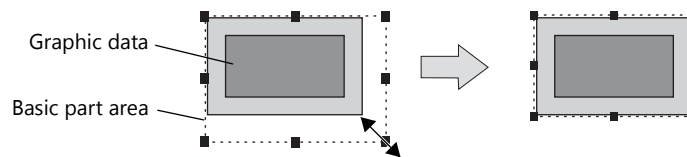

Re-setting the frame

Every part has a frame (in default color: gray). The frame of a part denotes its overall size, comprising the graphic data and the basic area (the touch area in the case of a switch part). For a graphic freely drawn, its frame may not fit the size of the drawn graphic. Re-setting the frame is required to avoid such a deviation problem.

There are the following two methods of frame setting:

- Automatic setting

1) Click [Edit] → [Modify Part] → [Frame Auto Fit] or select [Frame Auto Fit] → [Auto] from the right-click menu.

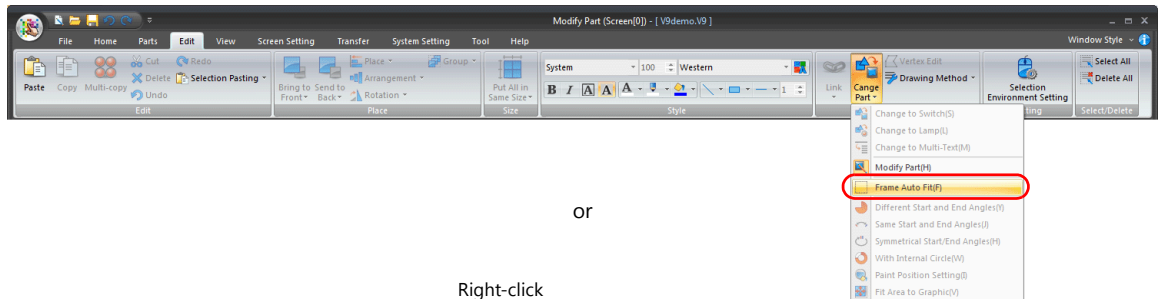

OR

Right-click

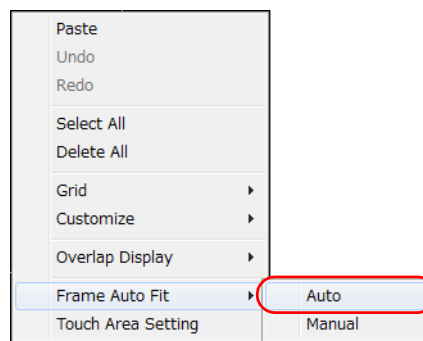

2) The frame is fit to the graphic data and the touch area.

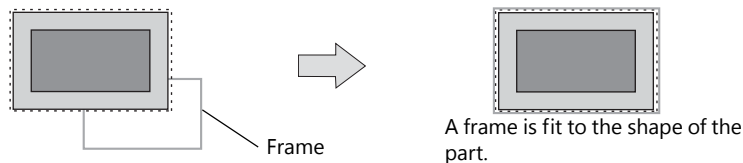

Frame re-setting is also executable on the base screen. Select the target part (or parts), and follow one of the procedures below:

- In the right-click menu, click [Change Part] → [Frame Auto Fit].
- Click [Edit] → [Modify Parts] → [Frame Auto Fit].

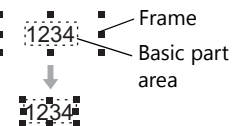

- Manual setting

1) In the right-click menu, click [Frame Auto Fit] → [Manual]. A crosshair appears.

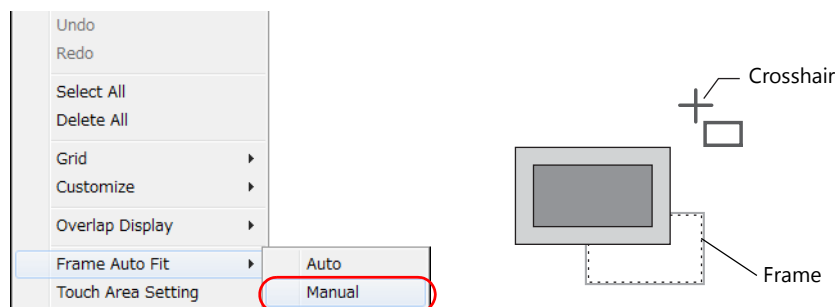

2) Adjust the frame to the desired position by dragging the crosshair.



Data Display

Data display parts include numerical data display, character display, and message display parts.

Structure

Example: Numerical data display

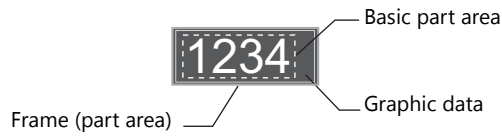

Editing procedure

This section explains the procedure for editing a numerical data display part. The same explanation applies to character and message display parts.

1. Select the numerical data display to edit and display the [Modify Part] tab window.
2. Use drawing parts etc. to edit the design as desired.

For more information on editing with drawing parts, refer to "3.6.1 Shape" page 3-48.

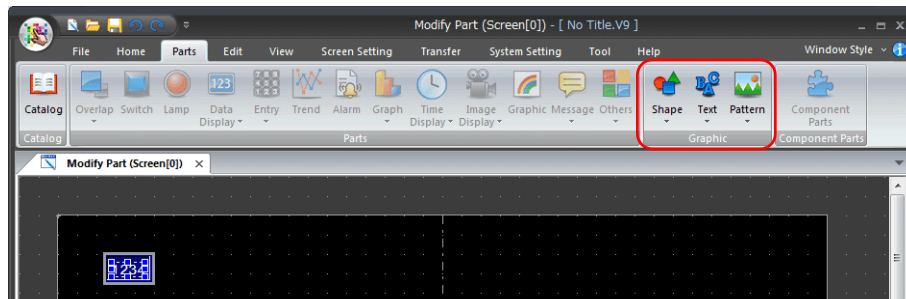

3. When editing is complete, click [Frame Auto Fit] in the right-click menu.

For more information on frames and the setting method, refer to "Re-setting the frame" (page 11-17).

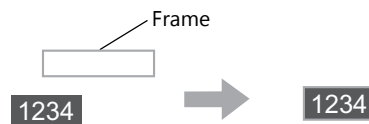
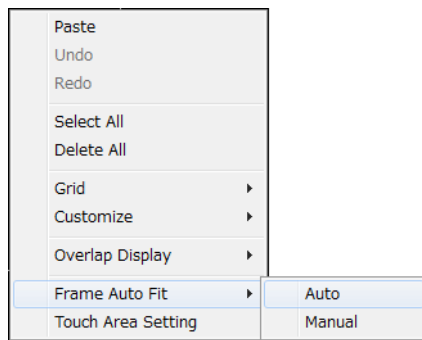

4. Return to the base screen.

Keypad

Structure

A keypad part for numerical or text entry consists of multiple switch parts.

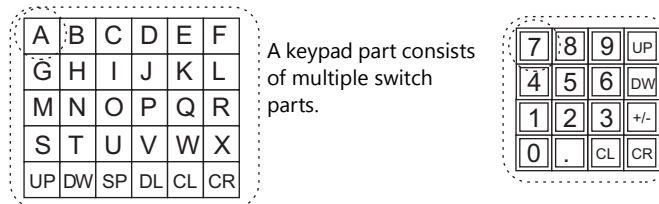

Editing procedure

The editing procedure is the same as that for switch parts.*

For more information, refer to "Switch/Lamp" (page 11-14).

- * **The components of this part are linked. Therefore, the components need to be unlinked prior to editing. Click [Link] → [Link Cancel] in the right-click menu or click [Edit] → [Link] → [Link Cancel]. Once the components are unlinked, linking them again is recommended after editing is finished.**

Slider Switch/Scroll Bar

Structure

A slider switch part or scroll bar part consists of a sliding switch and a rail.

The slide switch and the rail must be edited independently.

Similar to a switch part, the slider switch and scroll bar parts have a touch area.

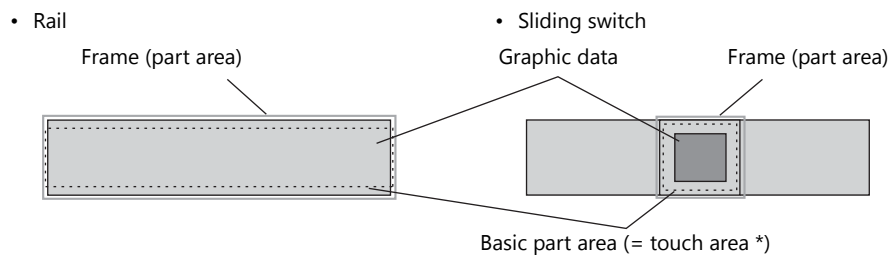

Editing procedure

1. Select the slider switch part to edit and display the [Modify Part] tab window.

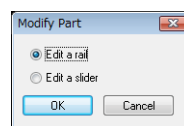

2. The sliding switch and the rail must be edited independently. Select [Edit a rail] or [Edit a slider] and click [OK]. The editing procedure is the same as that for switch parts. For more information, refer to "Switch/Lamp" (page 11-14).

Graph

There are seven kinds of graph parts: bar graph, pie graph, panel meter, statistic bar graph, statistic pie graph, trend, and closed area graph parts. The graph editing method varies according to part type.

Bar Graph

Structure

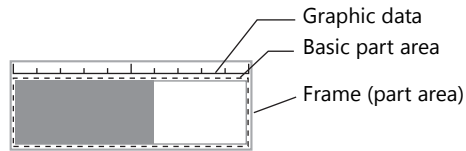

Procedure

1. Select the bar graph part to edit and display the [Modify Part] tab window.
2. Use drawing parts etc. to edit the design as desired.
For more information on editing with drawing parts, refer to "3.6.1 Shape" page 3-48.

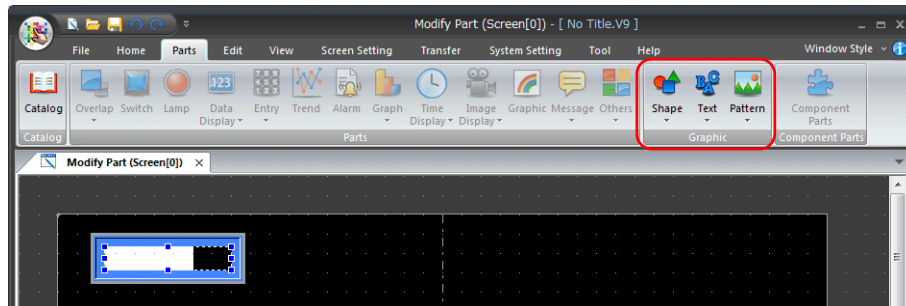

3. When editing is complete, click [Frame Auto Fit] in the right-click menu.
For more information on frames and the setting method, refer to "Re-setting the frame" (page 11-17).

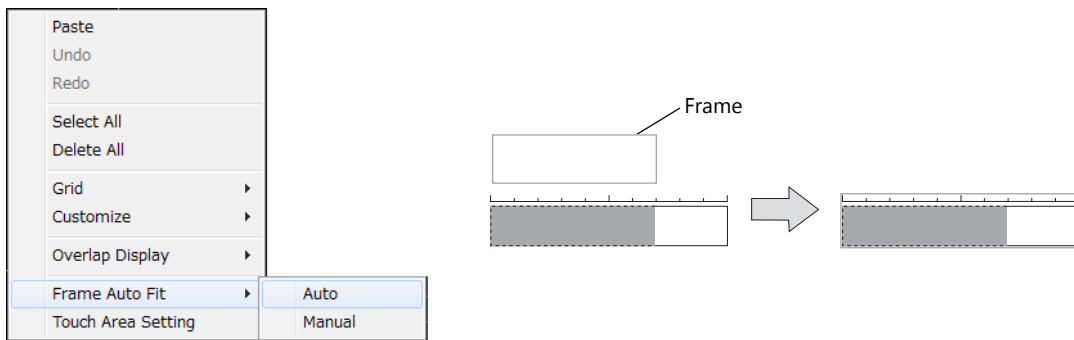

4. Return to the base screen.

Pie Graph

Pie graph parts are divided into the following types.

Symmetrical without internal circle

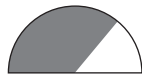

Circle without internal circle



Asymmetrical without internal circle



Symmetrical with internal circle



Circle with internal circle

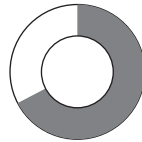

Asymmetrical with internal circle



Structure

Example: Circle without internal circle

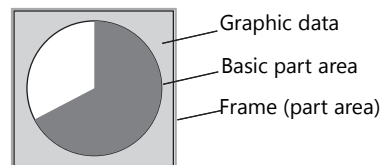

Procedure

1. Select the pie graph part to edit and display the [Modify Part] tab window.
2. Use drawing parts etc. to edit the design as desired.
For more information on editing with drawing parts, refer to "3.6.1 Shape" page 3-48.
For more information on how to edit pie graph parts, refer to "Icons dedicated to pie graph editing" (page 11-22).

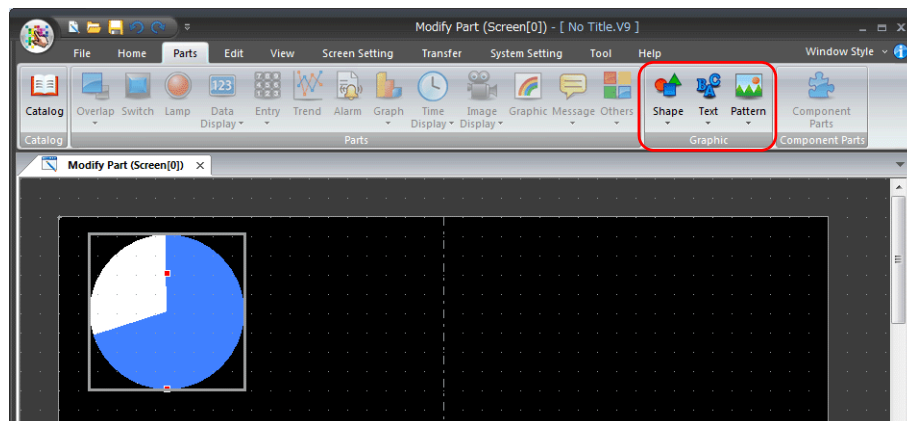

Minimum permissible sizes are designated for pie graph parts.

For a pie graph part without an internal circle, the minimum radius is set to 16 dots.

For a pie graph part with an internal circle, the minimum radius of the internal circle is set to 10 dots, and the minimum difference between the radii of the internal circle and the external circle is set to 16 dots.

3. When editing is complete, click [Frame Auto Fit] in the right-click menu.
For more information on frames and the setting method, refer to "Re-setting the frame" (page 11-17).

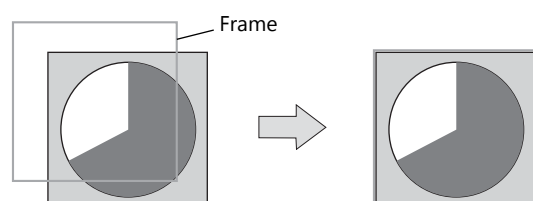
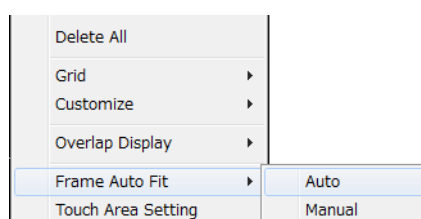

4. Return to the base screen.

Icons dedicated to pie graph editing

Some icons become active only when editing pie graph parts. These icons do not appear for other graph parts. The contents are shown below:

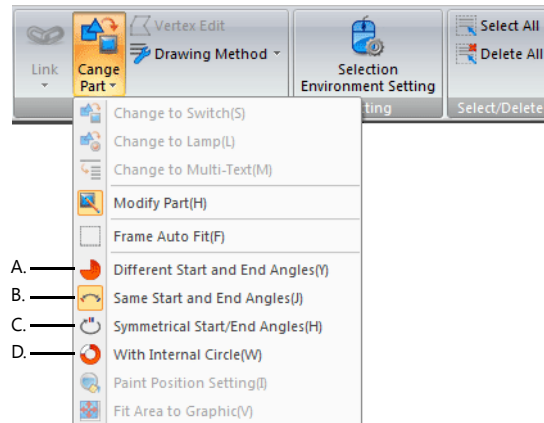

A. [Different Start and End Angles]

A pie graph will have start and end angles if it is not a complete circle, such as a sector. These angles are changeable in the course of part editing.

(Procedure)

- 1) Click the [Different Start and End Angles] icon.
Next click the pie graph part to display handles around the part.

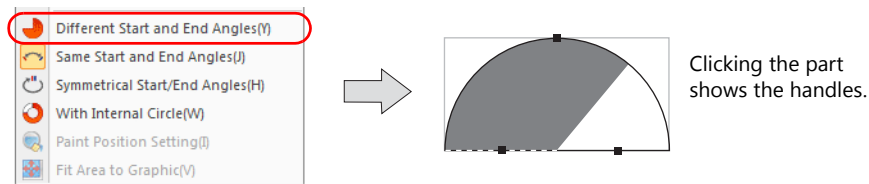

- 2) Drag the handle for either the start or end angle. The start and end angles can be changed separately.

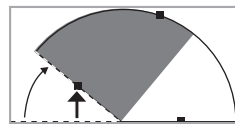

Dragging the handle for the start angle changes the start angle only.

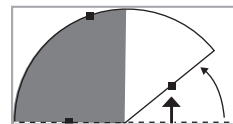

Dragging the handle for the end angle changes the end angle only.

B. [Same Start and End Angles]

(Procedure)

- 1) Click the [Same Start and End Angles] icon.
Next click the pie graph part to display handles around the part.

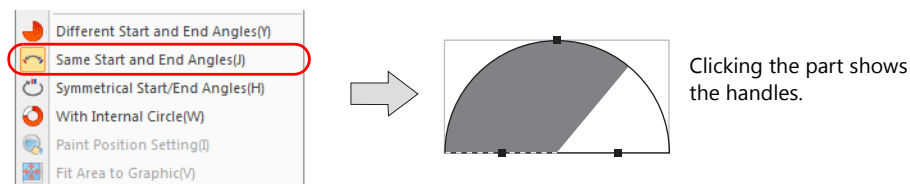

- 2) Drag the handle for either the start or end angle. The handles for the start and end angles are brought to the same position. The graph thereby becomes a complete circle. (The handle for the start angle is moved to the handle for the end angle.)

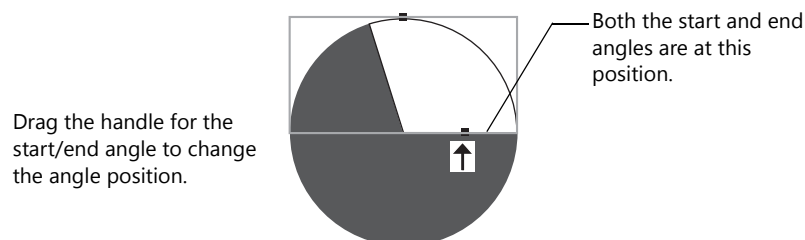

C. [Symmetrical Start/End Angles]

Both the start and end angles can be changed simultaneously.
(Procedure)

- 1) Click the [Symmetrical Start/End Angles] icon.
Next click the pie graph part to display handles around the part.

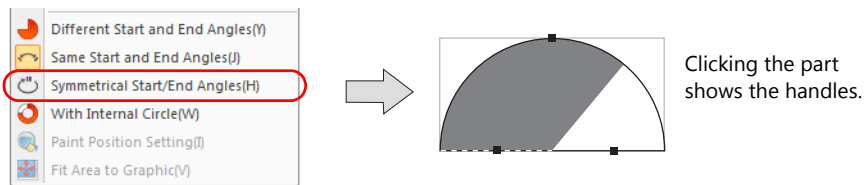

- 2) Drag the handle for either the start or end angle. Both the start and end angles are changed simultaneously and symmetrically.

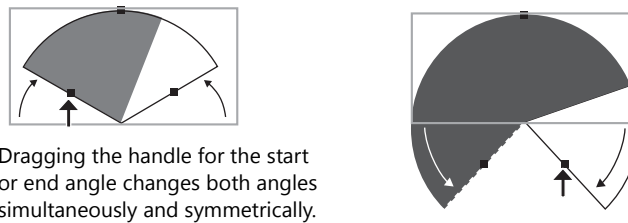

D. [With Internal Circle]

(Procedure)

- 1) Click the [With Internal Circle] icon.
An internal circle (hole) is made in the pie graph part.

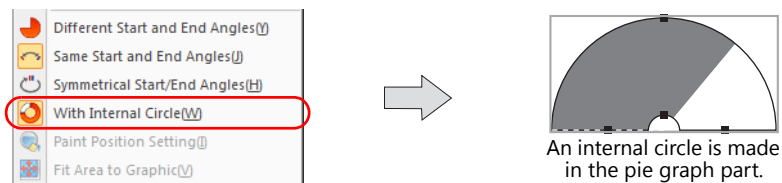

Clicking the [With Internal Circle] icon again resets it. The internal circle (hole) is deleted from the pie graph part as a result.

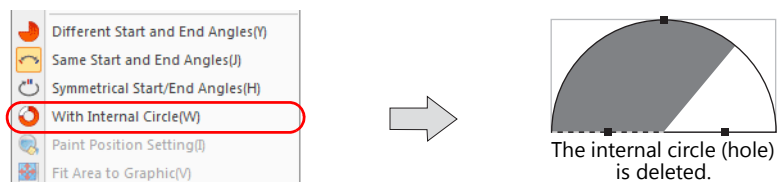

- 2) While the pie graph part has an internal circle (hole), drag the handle of the internal circle. The internal circle is changed in size by dragging the handle.

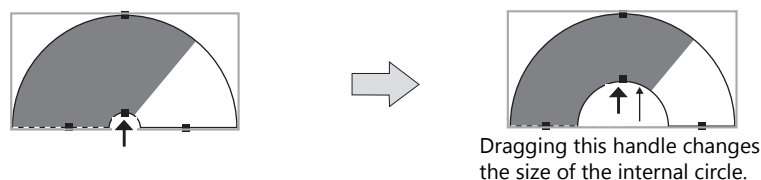

Closed Area Graph

Structure

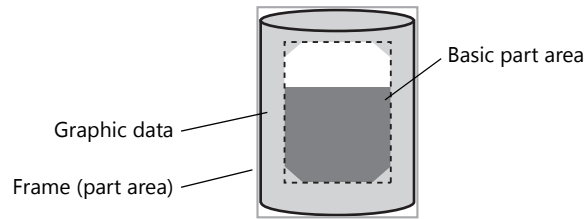

Procedure

1. Select the closed area graph part to edit and display the [Modify Part] tab window.
2. Use drawing parts etc. to edit the design as desired.
For more information on editing with drawing parts, refer to "3.6.1 Shape" page 3-48.



Tools useful for drawing

- "Grid" page 4-26
- "Item List" page 4-21

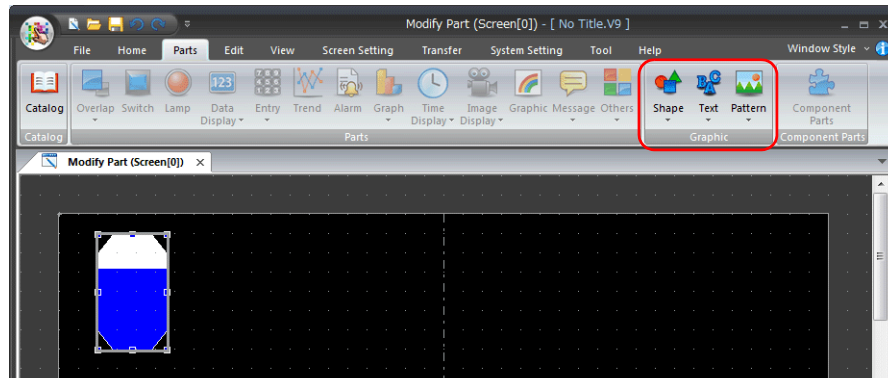

The maximum size of a closed area graph is 65,536 bytes (height × width).

3. Proceed to the setting of the graph area in the dotted frame (= basic part area). The graph area serves as the graph recognition range. Move the graph area (dotted frame) to the drawn graphic. Adjust the graph area appropriately by dragging the handle.

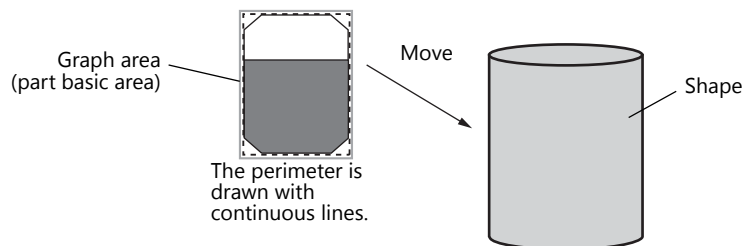

☹ To use the entire drawn graphic as the graph area, select the graph area or the graphic, open the right-click menu, and select [Fit Area to Graphic]. The graph area is fit to the graphic.

4. Right-click and select [Paint Position Setting].

☹ **Paint (start) position setting**
 Set a graph start point, which is equivalent to the paint (start) position. Click [Paint Position Setting] in the right-click menu. Next, move the mouse to the graph area and click on the target position.
 (The "X" mark of the paint (start) position is moved along the horizontal line at a level one dot higher from the lower limit of the graph.)

Example:

If the graph is not painted correctly even with the paint (start) position setting, shift the lower limit of the graph area upward by one dot or more. To check the paint (start) position, open the [Display] tab in the [Display Environment] window ([View] → [Display Environment]), deselect the [Display Paint] checkbox under [Detail], and click [OK]. The "X" denotes the paint (start) position.

Example:

In cases where the vertex of the graphic is not matched with the vertex of the graph area, or the graphic is shaped in such a manner that painting discontinues partially within the graphic, such closed area graphs cannot be painted correctly.

Example:

5. When editing is complete, click [Frame Auto Fit] in the right-click menu.

For more information on frames and the setting method, refer to "Re-setting the frame" (page 11-17).

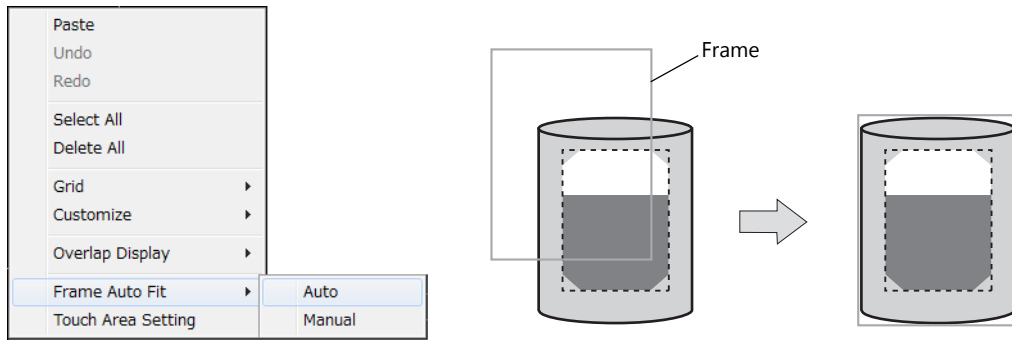

6. Return to the base screen.

Panel Meter

Structure

A panel meter part is almost the same as a pie graph part in structure. When a pie graph part is adopted as the part basic area, the panel meter shows a graph value by painting the area in the [Target Value Color]. Meanwhile, a panel meter with an indicator shows a graph value with the indicator.

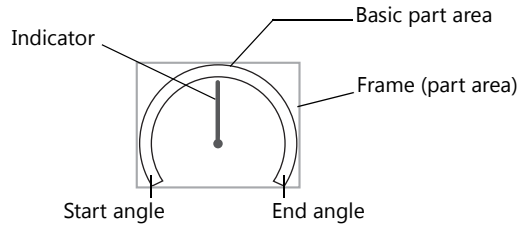

Editing procedure

The editing procedure is the same as that for pie graph parts.

For more information, refer to "Pie Graph" (page 11-21).



Every panel meter part contains an internal circle. When editing a panel meter part, the [With Internal Circle] icon is inactive. Minimum permissible sizes are designated for panel meter parts. The minimum radius of the internal circle is set to 10 dots, and the minimum difference between the radii of the internal circle and the external circle is set to 16 dots.

Statistic Bar Graph

Structure

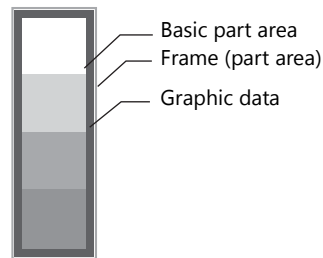

Editing procedure

1. Select the statistic bar graph part to edit and display the [Modify Part] tab window.
2. Use drawing parts etc. to edit the design as desired.
For more information on editing with drawing parts, refer to "3.6.1 Shape" page 3-48.

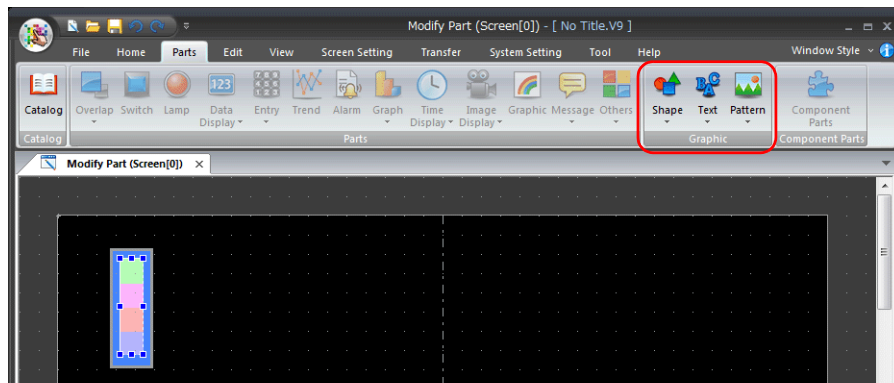

3. When editing is complete, click [Frame Auto Fit] in the right-click menu.
For more information on frames and the setting method, refer to "Re-setting the frame" (page 11-17).

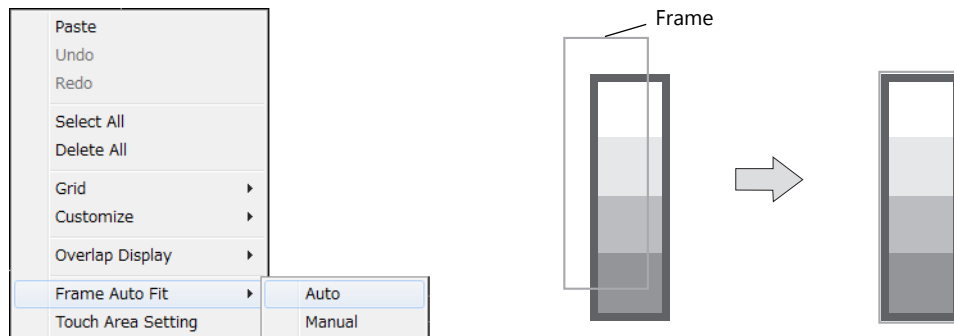

4. Return to the base screen.

Statistic Pie Graph

There is only one type of statistic pie graph part. Unlike pie graph parts, varied forms, such as a sector, do not exist. Every statistic pie graph part is in the form of circle with an internal circle.

Structure

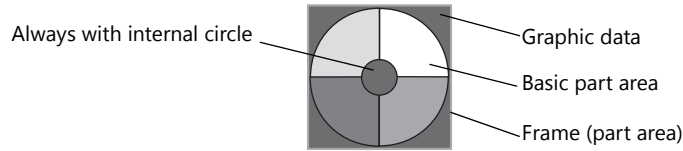

Editing procedure

1. Select the statistic pie graph part to edit and display the [Modify Part] tab window.
2. Use drawing parts etc. to edit the design as desired.
For more information on editing with drawing parts, refer to "3.6.1 Shape" page 3-48.

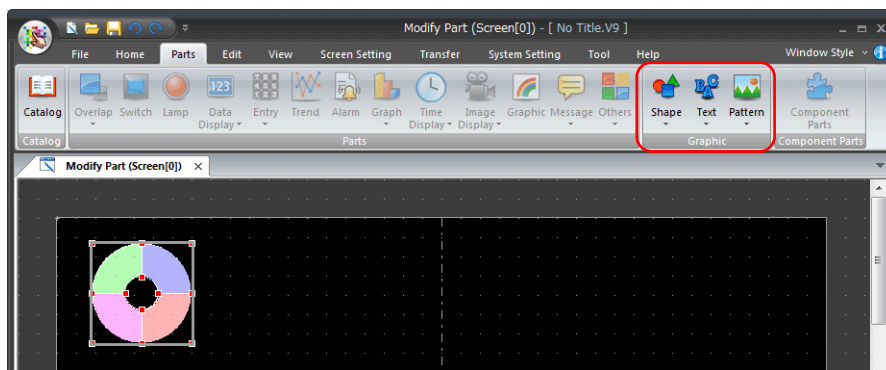

☺ Minimum permissible sizes are designated for statistic pie graph parts. The minimum radius of the internal circle is set to 10 dots, and the minimum difference between the radii of the internal circle and the external circle is set to 16 dots.

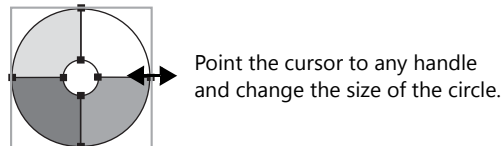

3. When editing is complete, click [Frame Auto Fit] in the right-click menu.
For more information on frames and the setting method, refer to "Re-setting the frame" (page 11-17).

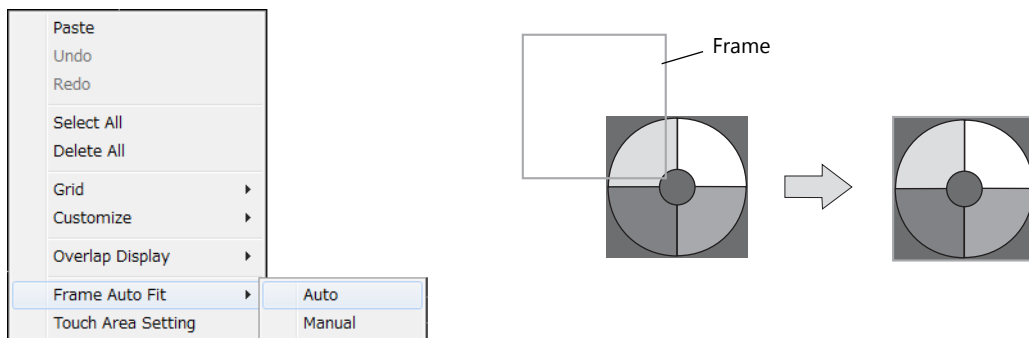

4. Return to the base screen.

Trend Part

Structure

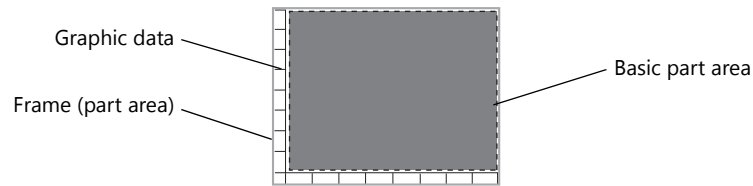

Editing procedure

* **The components of this part are linked. Therefore, the components need to be unlinked prior to editing. Click [Link] → [Link Cancel] in the right-click menu or click [Edit] → [Link] → [Link Cancel]. Once the components are unlinked, linking them again is recommended after editing is finished.**

1. Select the trend parts to edit and display the [Modify Part] tab window.
2. Use drawing parts etc. to edit the design as desired.
For more information on editing with drawing parts, refer to "3.6.1 Shape" page 3-48.



In the case of trend parts (display mode: history display, display method: graph display), note that graphics drawn in the part basic area will not be displayed correctly on the V9 series unit.

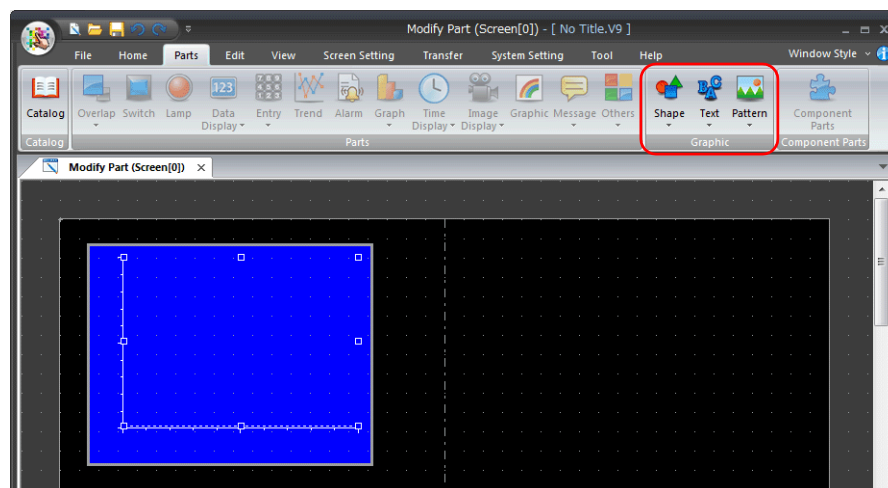

3. When editing is complete, click [Frame Auto Fit] in the right-click menu.
For more information on frames and the setting method, refer to "Re-setting the frame" (page 11-17).

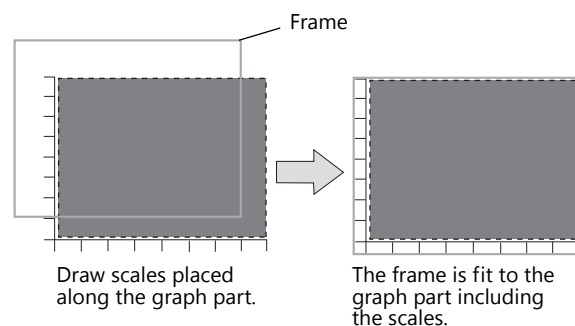
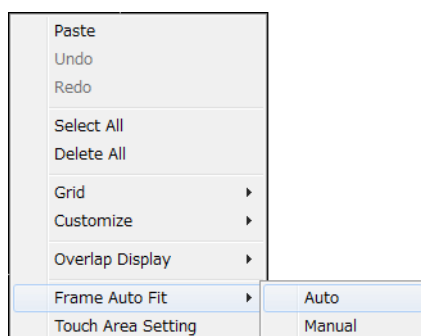

4. Return to the base screen.

Display Area

Display area parts are used for functions to display messages, such as message parts, and functions to display graphics, such as graphic parts.

Structure



Editing procedure

The editing procedure is almost the same as that for overlap editing.

For more information on the editing procedure, refer to "Overlap" (page 11-13).

However, frame setting is allowed for display area parts. Unlike an overlap display part, the basic area and the graphic area of a display area part are independent from each other. In the course of editing a display area part, frame re-setting is necessary to determine the size of the part.

For more information on frames, refer to "Re-setting the frame" (page 11-17).

- * **The components of this part are linked. Therefore, the components need to be unlinked prior to editing. Click [Link] → [Link Cancel] in the right-click menu or click [Edit] → [Link] → [Link Cancel]. Once the components are unlinked, linking them again is recommended after editing is finished.**

Trend Part (Display Method: Data Display)

A data sampling part is displayed when [Trend] is selected from the [Parts] menu and then [Data Display] is selected for the display mode.

Structure

A data sampling part consists of data display fields in addition to the basic area and the graphic data.

The data display fields, which are different from data display parts, exist only in data sampling parts. The data display fields are placed only in the first line. (The data display fields are movable only to right and left.)

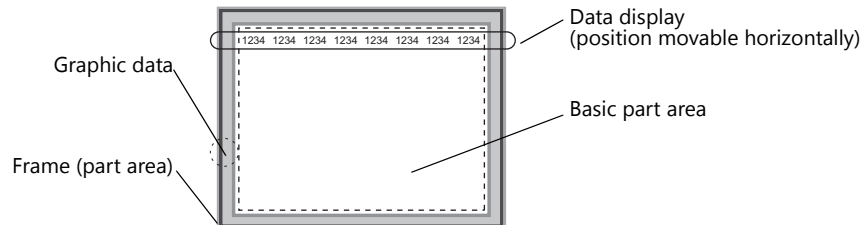

☺ One data sampling part can show a maximum of 16 data display fields. Whether or not to display data is set on the [Data Setting] menu in the item settings window of the trend part. For more information on the data sampling function, refer to V9 Series Reference Manual 1.

Data No.	0	1	2	3
Logging Word No.	0	1	2	3
Device				
Input Type	DEC	DEC	DEC	DEC
Data Length	1-Word	1-Word	1-Word	1-Word
Display Method	Num. Display	Num. Display	Num. Display	Num. Display
Display Function	No Function	No Function	No Function	No Function
Display Format	DEC(w/o sign)	DEC(w/o sign)	DEC(w/o sign)	DEC(w/o sign)

Editing procedure

- * **The components of this part are linked. Therefore, the components need to be unlinked prior to editing. Click [Link] → [Link Cancel] in the right-click menu or click [Edit] → [Link] → [Link Cancel]. Once the components are unlinked, linking them again is recommended after editing is finished.**

1. Select the data sampling part to edit and display the [Modify Part] tab window.
2. Use drawing parts etc. to edit the design as desired.
For more information on editing with drawing parts, refer to "3.6.1 Shape" page 3-48.



Note that graphics drawn in the basic part area will not be displayed correctly on the V9 series unit.

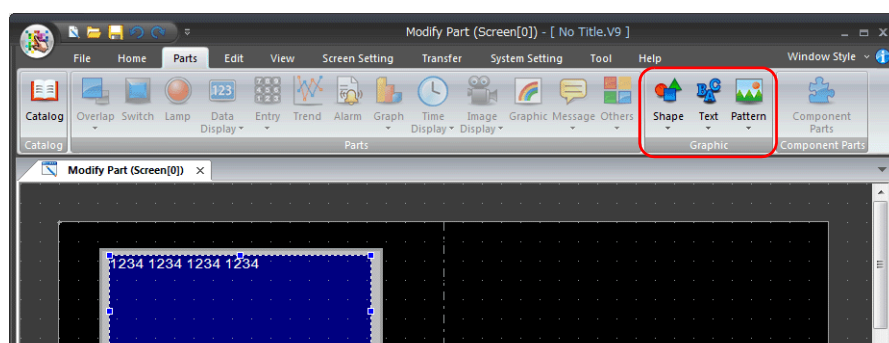

- When editing is complete, click [Frame Auto Fit] in the right-click menu.
For more information on frames and the setting method, refer to "Re-setting the frame" (page 11-17).

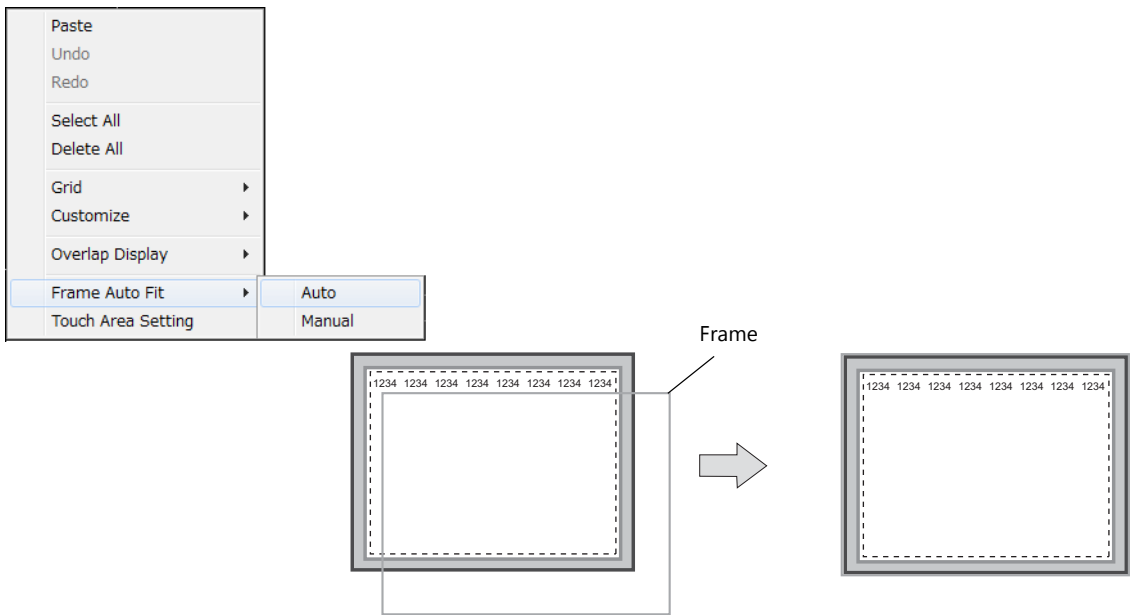

- Return to the base screen.

Moving the data display fields on a data sampling part

- Click the data sampling part so that handles are shown.
- Click one data display field to move. Only the clicked field is selected with handles.
- Drag the clicked field to the right or left.

Calendar Part

One calendar part is capable of containing the entire calendar information (year, month, day, hour, minutes, seconds, and the day of the week). Meanwhile, the calendar information can be divided into components. These components can be registered one by one.

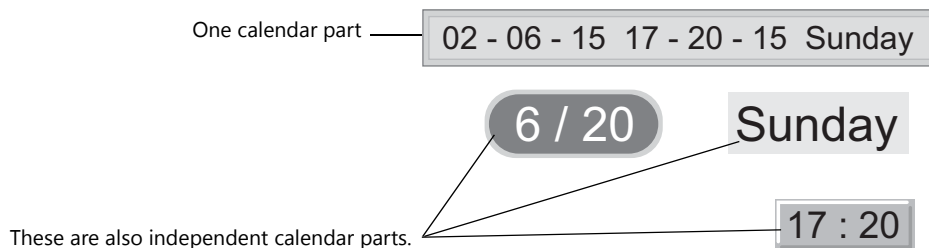

Structure

A calendar part has a structure consisting of several components. These components can be individually moved and enlarged during editing.

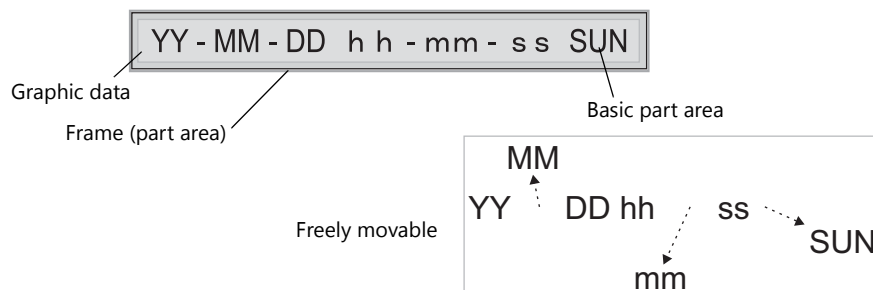

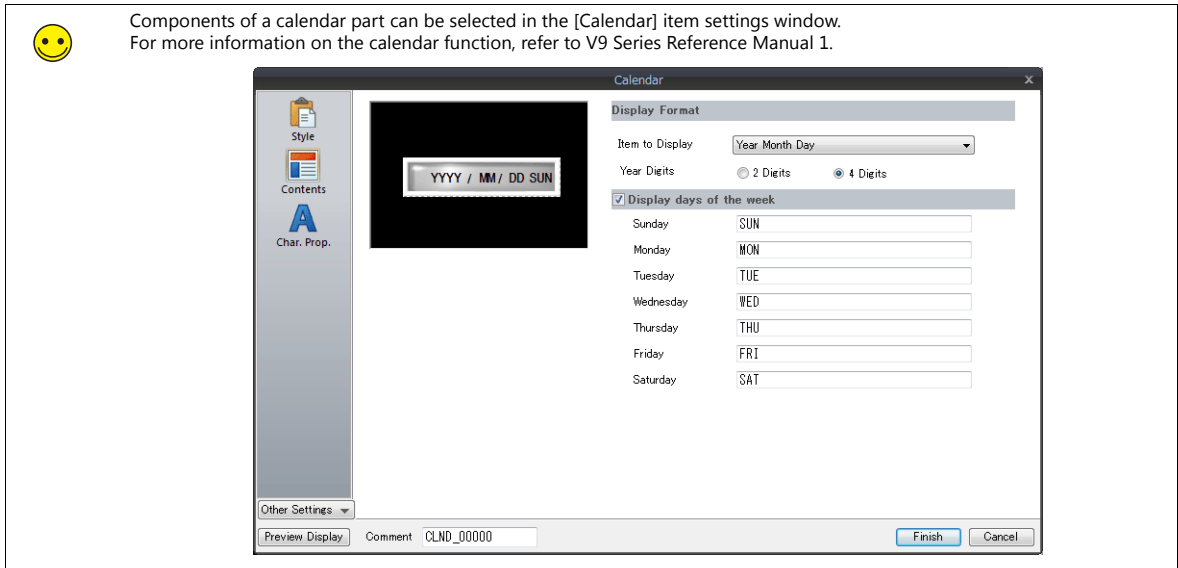

Editing procedure

1. Select the calendar part to edit and display the [Modify Part] tab window.

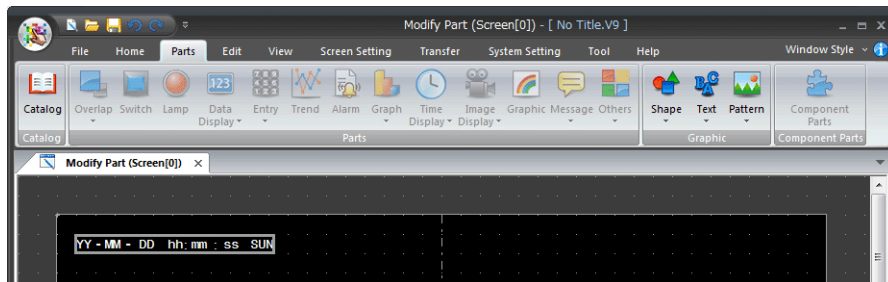

2. Use drawing parts etc. to edit the design as desired.
For more information on editing with drawing parts, refer to "3.6.1 Shape" page 3-48.
3. When editing is complete, click [Frame Auto Fit] in the right-click menu.
For more information on frames and the setting method, refer to "Re-setting the frame" (page 11-17).

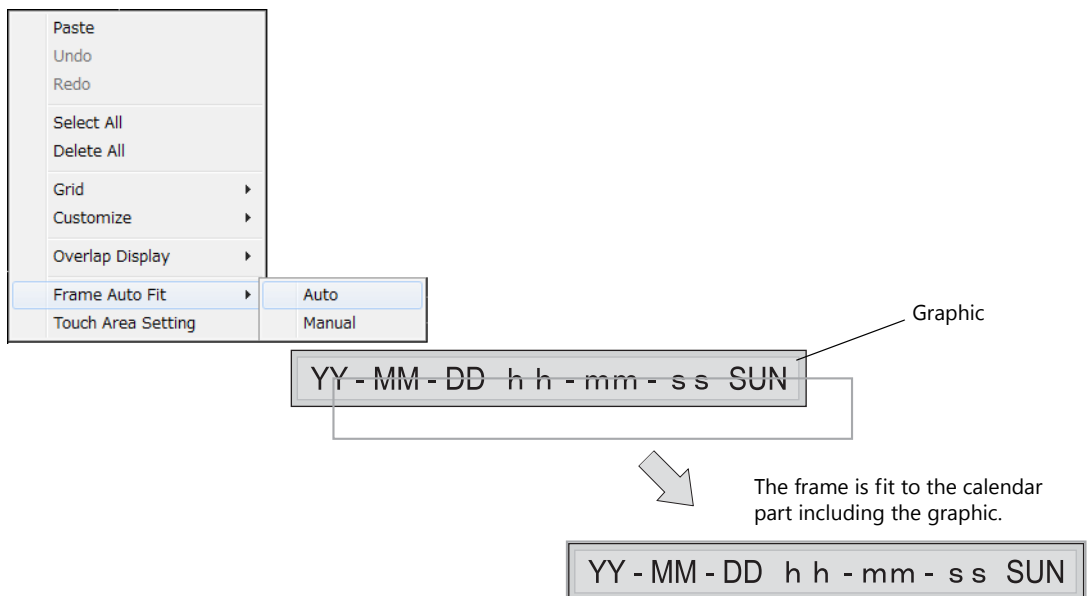

4. Return to the base screen.

11.3.5 After Completing Part Editing

Once the original parts created in the [Modify Part] tab window are saved as a screen program (*.V9), they can be loaded from the [Catalog] view window and added to the parts list.

Viewing from the [Catalog] View Window

1. Click [Parts] → [Catalog] to display the [Catalog] view window.

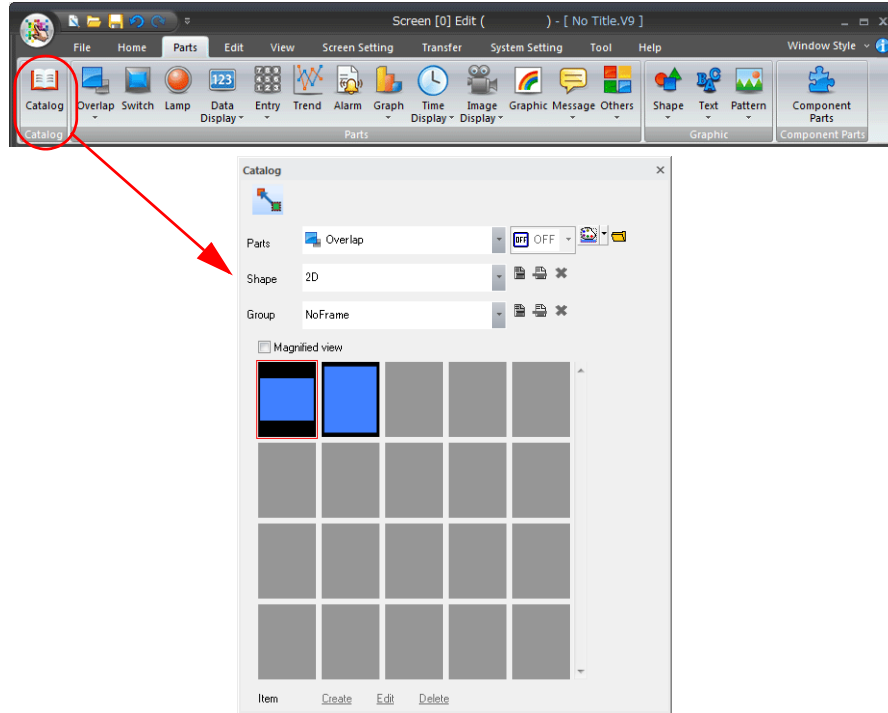

2. Click the open file icon.

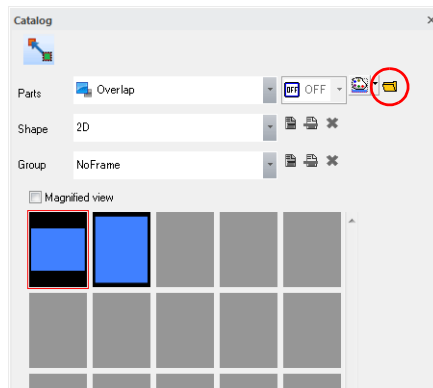

3. The [Parts File Select] window is displayed. Select the screen program file to add to the parts list and click [Open].

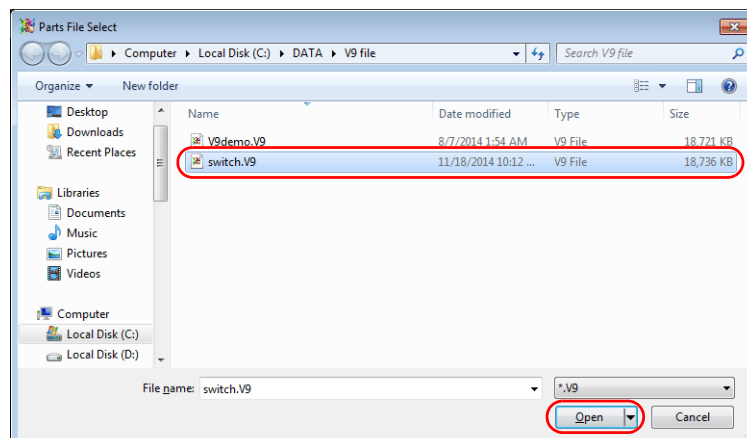

4. The selected screen program file loaded to the [Catalog] window and added to the parts list as a "Custom" file.

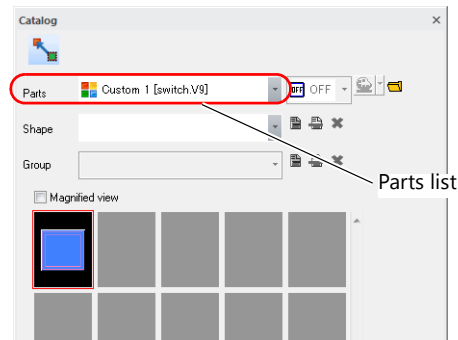

A maximum of four custom files can be added to the parts list.

5. Select a part from the catalog and drag it onto the screen.

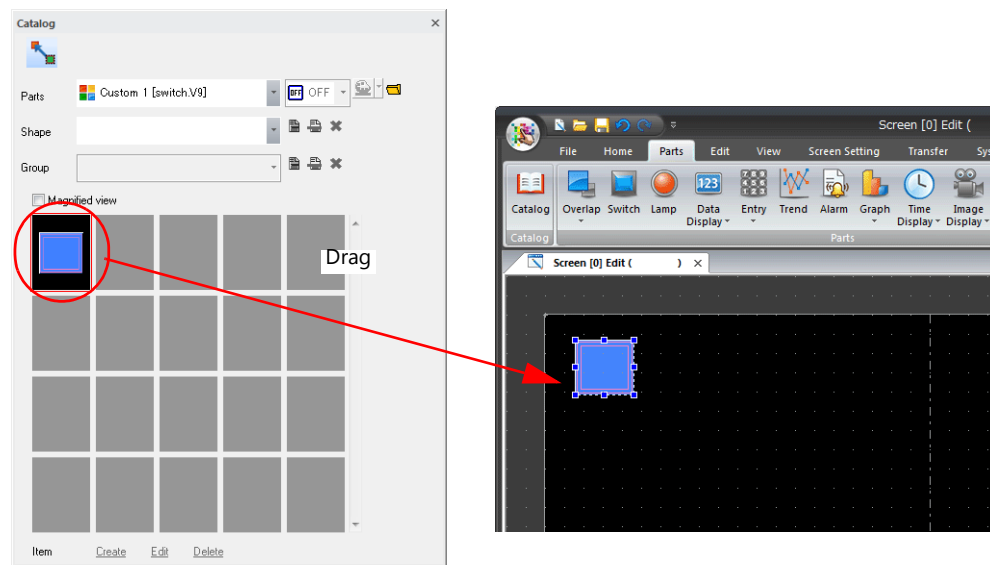

11.4 Component Parts

11.4.1 Overview

A component part is a single part that consists of multiple components (functions).
 Component parts can be placed in new files and existing files.
 Reusing created component parts can significantly improve editing efficiency.
 In addition, configuring a device memory table will allow device memory to be changed easily after placement.

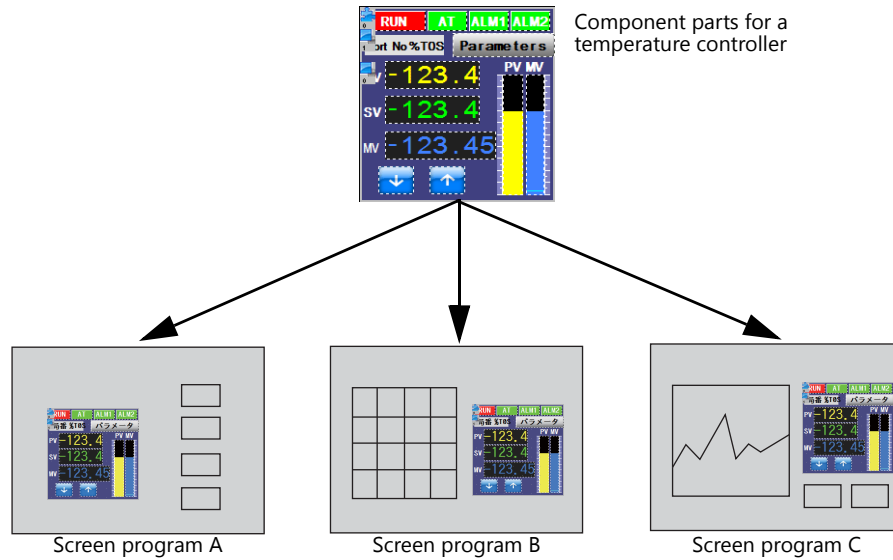

 Device memory table

A device memory table is used to register the addresses of items when editing component parts. Registering addresses in this table enables the addresses of all component parts to be easily changed when placing component parts in screen programs.

Component parts

12345 n = \$u00100

12345 n+1

12345 n+2

12345 D00000

12345 D00001

12345 D00002

Screen program A

12345 D00200

12345 D00201

12345 D00202

Screen program B

12345 \$u00500

12345 \$u00501

12345 \$u00502

Screen program C

Device Table

No.	Device	Device Access	Name
0	\$u00100	Word	Num. Display
1			
2			
3			
4			
5			
6			
7			
8			

Screen[0] Num. Display Device
 Screen[0] Num. Display Device
 Screen[0] Num. Display Device
 Screen[0] Num. Display Device

11.4.2 Component Part Creation Procedure

Creation Sequence

- Step 1 (page 11-37)Create a New Component Part
- Step 2 (page 11-39)Place Items That Comprise the Component Part
- Step 3 (page 11-39)Register the Component Name and Comments
- Step 4 (page 11-41)Register the Number of Words Used by Internal Device Memory (\$C) for the Component Part
- Step 5 (page 11-42)Register a Device Memory Table
- Step 6 (page 11-45)Register a Text Table
- Step 7 (page 11-46)Name and Save to Create a Component Part File (*.V9C)

Step 1: Create a New Component Part

1. Click [File] → [Component Parts] → [New] to display the [Edit Model Selection] window. Set the MONITOUCH model and each setting and click [OK].

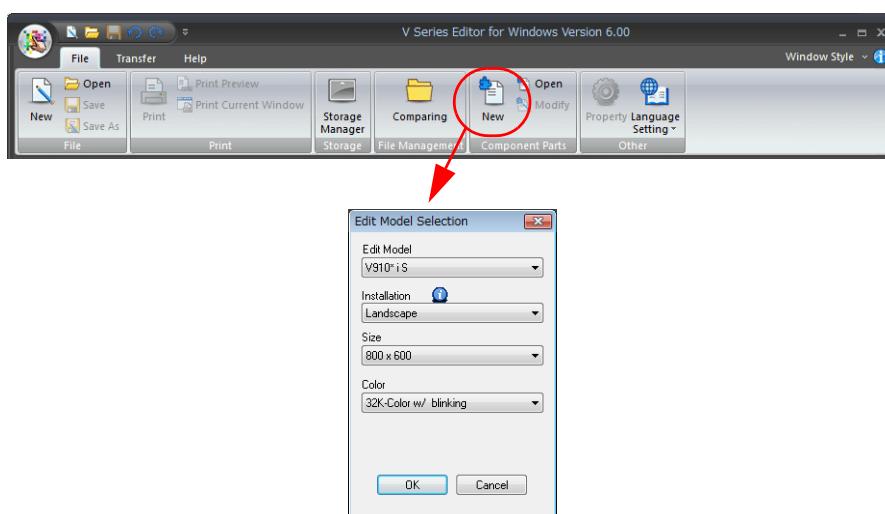

2. The [PLC1 Connection Device Selection] window is displayed. Select the device that will connect to the V9 series unit and click [OK].

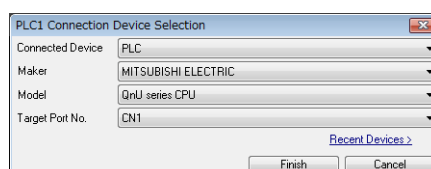

- The hardware settings and PLC properties are displayed.
Set the communication settings for the device to connect.

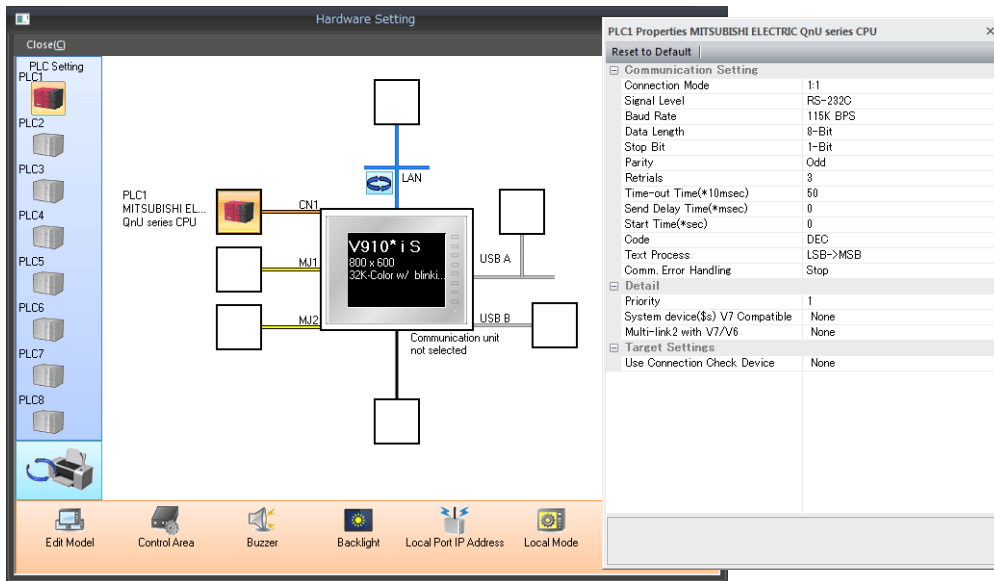

- Close the [Hardware Setting] window.
The [Component Part Edit] tab window is displayed.

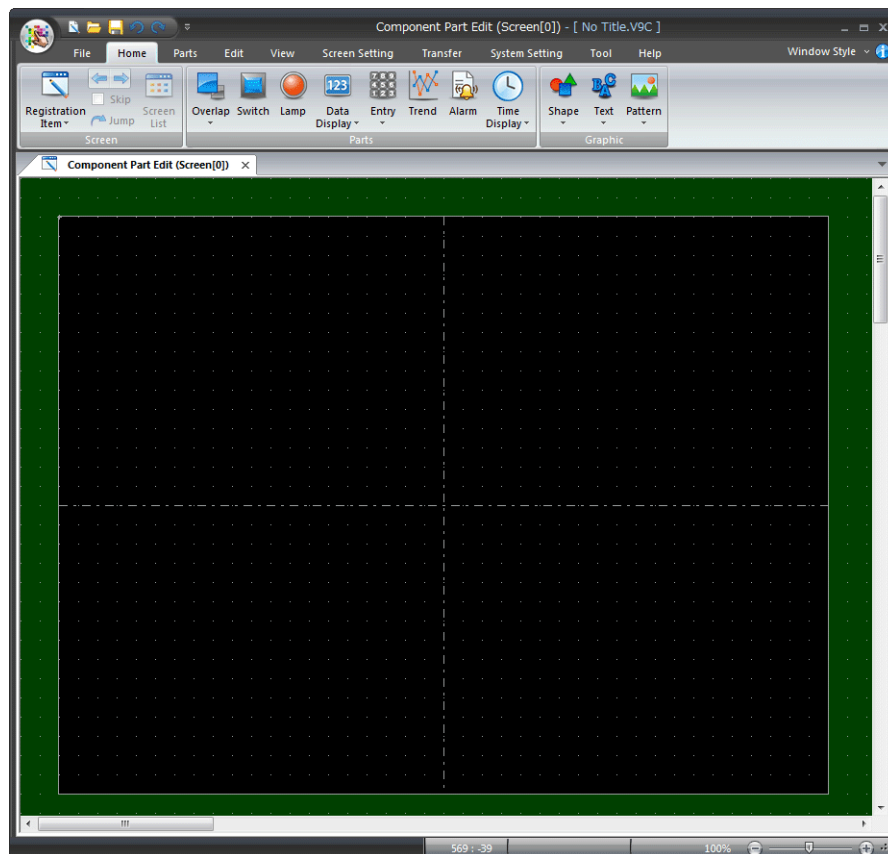

😊 To edit an existing part, click [File] → [Component Parts] → [Open] and specify a file to open it in a [Component Part Edit] tab window.

The screenshot shows the 'V Series Editor for Windows Version 6.00' menu bar. The 'File' menu is open, and the 'Open' option is highlighted with a red circle. Other options in the 'File' menu include New, Save, Save As, Print, Print Preview, Print Current Window, Storage Manager, Comparing, New, Modify, Property, and Language Setting.

Step 2: Place Items

Place an item for the component part on the screen.

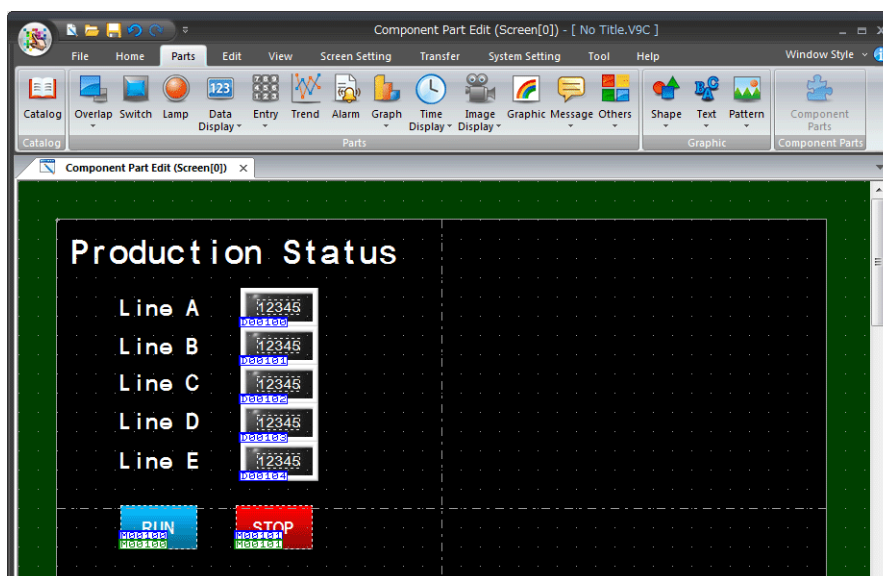

Prohibited items

- Placement prohibited items
Memory card parts, recipe parts
- Registration prohibited libraries
Screens other than screen number 0, data sheets
- Usage prohibited items
Alarm server, logging server, Ethernet communication, unit settings (other than sound), global settings, storage settings, memory card settings, MES settings, operation log settings, security settings, time display format settings, local function switch settings

Step 3: Register the Component Name and Comments

On the [Component Parts Information] tab displayed by clicking [File] → [Property], register a component part name and description of its function.

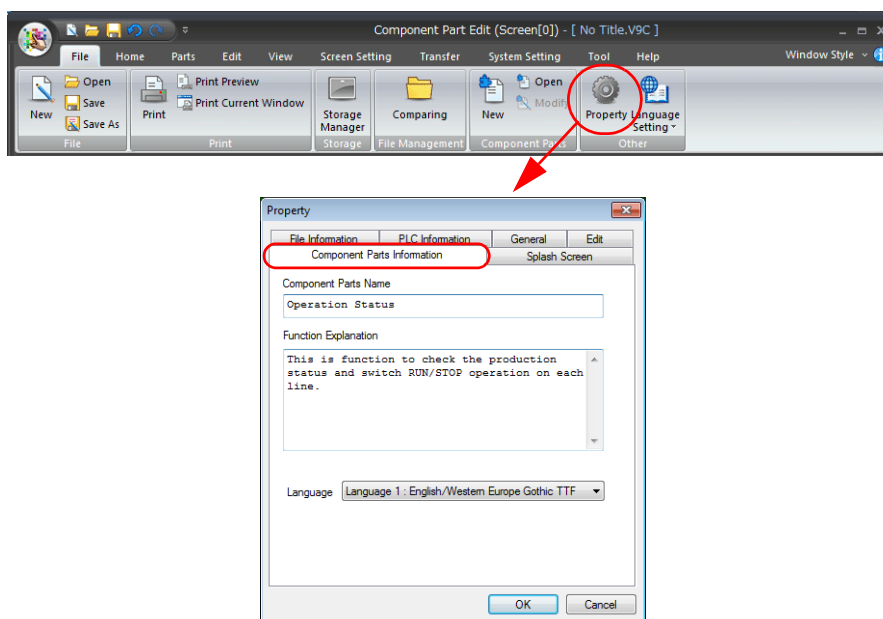

There is a limit on the number of characters that can be registered for [Component Parts Name] and [Function Explanation].

- [Component Parts Name]: 16 or less one-byte characters (8 or less two-byte characters)
- [Function Explanation]: 100 lines (however, a total character limit of 3,825 one-byte characters, including carriage return codes)

The registered information is displayed in the following manner when the component part is placed on the screen.

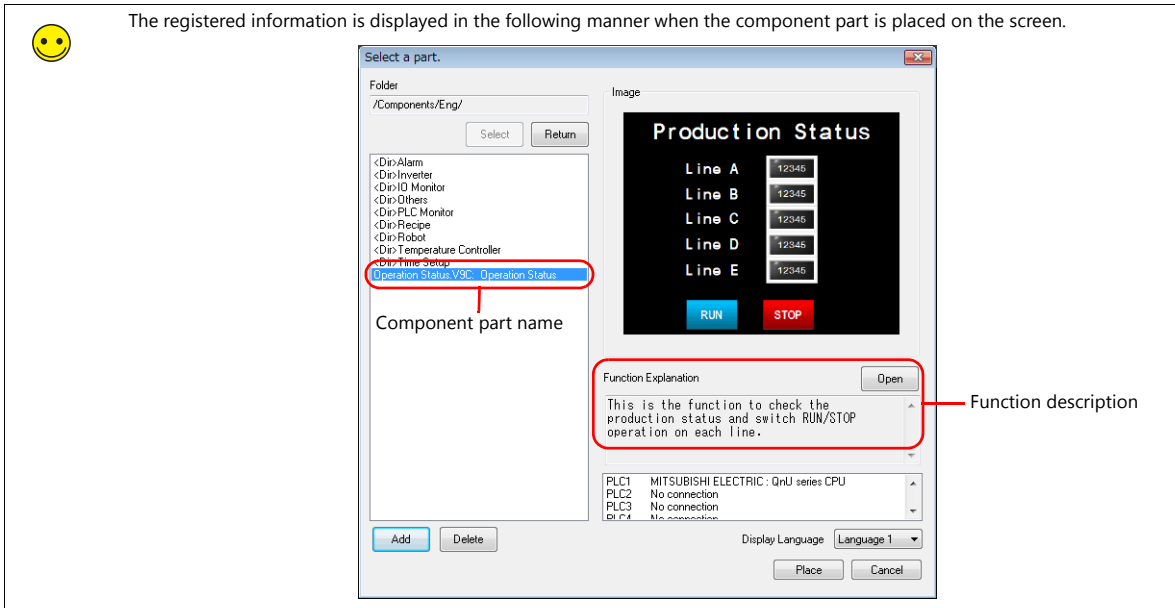

The screenshot displays a 'Select a part.' dialog box with the following elements:

- Folder:** /Components/Eng/
- Select/Return buttons:** Located above the component list.
- Component List:**
 - <Dir>Alarm
 - <Dir>Inverter
 - <Dir>ID Monitor
 - <Dir>Others
 - <Dir>PLC Monitor
 - <Dir>Recipe
 - <Dir>Robot
 - <Dir>Temperature Controller
 - <Dir>Time Setup
 - Operation Status.VSD: Operation Status** (highlighted with a red circle)
- Component part name:** A text field below the list.
- Add/Delete buttons:** Located at the bottom left.
- Image Preview:** A window titled 'Production Status' showing:
 - Line A: 12345
 - Line B: 12345
 - Line C: 12345
 - Line D: 12345
 - Line E: 12345
 - RUN (blue button) and STOP (red button) buttons at the bottom.
- Function Explanation:** A text box with an 'Open' button, containing the text: "This is the function to check the production status and switch RUN/STOP operation on each line." (highlighted with a red circle and labeled 'Function description').
- PLC Information:** A list showing PLC1 (MITSUBISHI ELECTRIC: QnJ series CPU), PLC2 (No connection), PLC3 (No connection), and PLC4 (No connection).
- Display Language:** Language 1 (dropdown menu).
- Place/Cancel buttons:** Located at the bottom right.

Step 4: Register \$C Device Memory

Set the number of words of device memory addresses (\$C) for the component part. Using \$C device memory cuts down on memory usage.



\$C device memory

- This is internal memory that can be allocated to items used in a component part. Because internal device memory, such as \$u, and PLC device memory is not used when \$C device memory is used, the amount of device memory used when placing component parts in actual screen programs is reduced.
- A maximum of 4,096 words can be set.

- Click [Screen Setting] → [Screen Setting] to display the [Screen Setting] window.

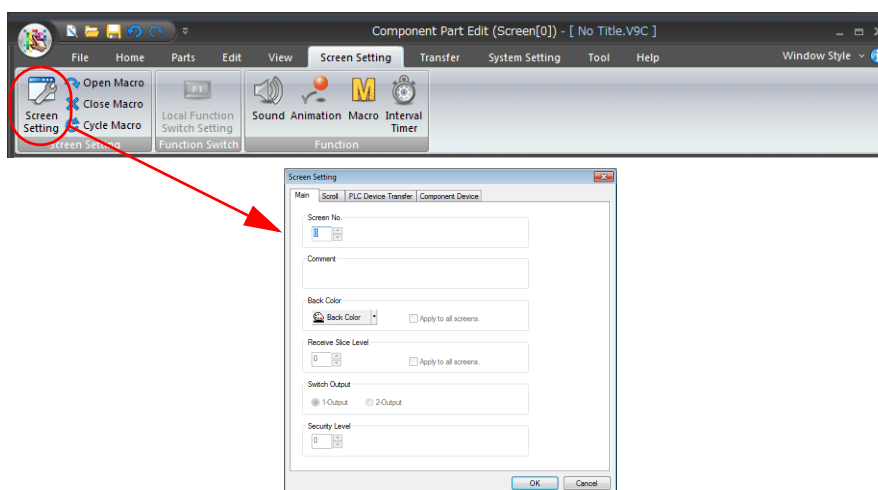

- On the [Component Device] tab of the [Screen Setting] window, select the [Set Component Device (\$C)] checkbox and enter the number of words to set (maximum of 4,096 words).

If the [Set Component Device (\$C)] checkbox is not selected, a value of 4,096 words is set automatically.

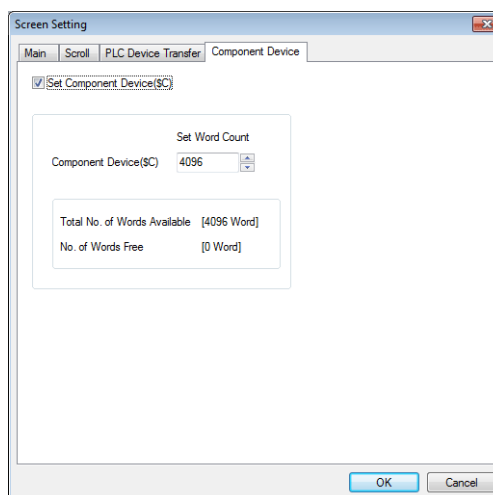

- \$C device memory limitations
The device memory map and event timer macro functions cannot be used.
- Notes on placing component parts on screens
The amount of \$C device memory that can be placed on a single screen of a screen program is 64K of words. When placing multiple component parts on the same screen, make sure that the total amount of \$C device memory does not exceed 64K of words.
If 64K of words is exceeded, a placement error will occur and the following message is displayed.

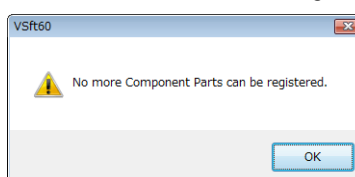

Step 5: Register a Device Memory Table

When item device memory is set to a device memory table, changing device memory in the item settings window displayed when placing a component part on the screen also allows any associated device memory to be changed.

1. Change the device memory addresses of the screen created in step 2 into a device memory table for addresses.

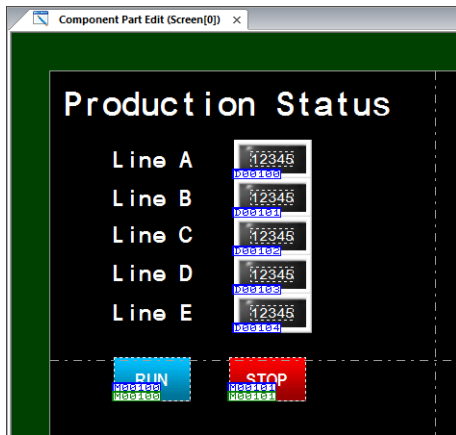

Before Change	After Change
D00100	TBL0.+0.+0
D00101	TBL0.+0.+1
D00102	TBL0.+0.+2
D00103	TBL0.+0.+3
D00104	TBL0.+0.+4
M00100	TBL1.+0.+0
M00101	TBL1.+0.+1

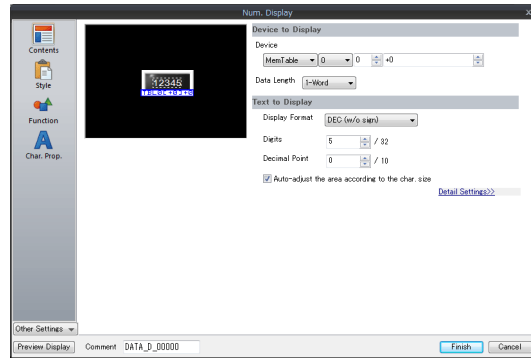
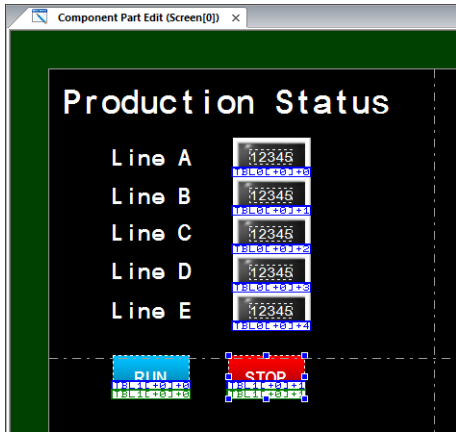

☺ Device memory table address parts

TBL 0. +0. +0

└─ Address offset

└─ Local offset

└─ Table number

2. Configure the device memory table.

Click [View] → [Component Device] to display the [Device Table] view window.

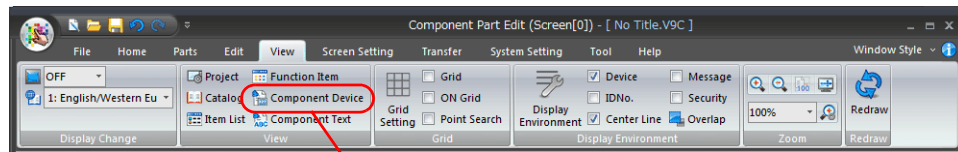

No.	Device	Device Access	Name
0			
1			
2			
3			
4			
5			
6			
7			
8			

3. Set [No. 0] as follows.

No.	Device	Device Access	Name
0	D00100	Word	Num. Display
1			
2			
3			
4			
5			
6			
7			
8			

Screen[0] Num. Display Device
Screen[0] Num. Display Device
Screen[0] Num. Display Device
Screen[0] Num. Display Device
Screen[0] Num. Display Device

4. Set [No. 1] as follows.

No.	Device	Device Access	Name
0	D00100	Word	Num. Display
1	M00100	Bit	SW/LP
2			
3			
4			
5			
6			
7			
8			

Screen[0] Switch Output Device
Screen[0] Switch Lamp Device
Screen[0] Switch Output Device
Screen[0] Switch Lamp Device



Procedure for changing device memory of component parts during screen creation

1. Place a component part on the screen and display the item settings window. Select a device memory item to display a device memory table as shown below.

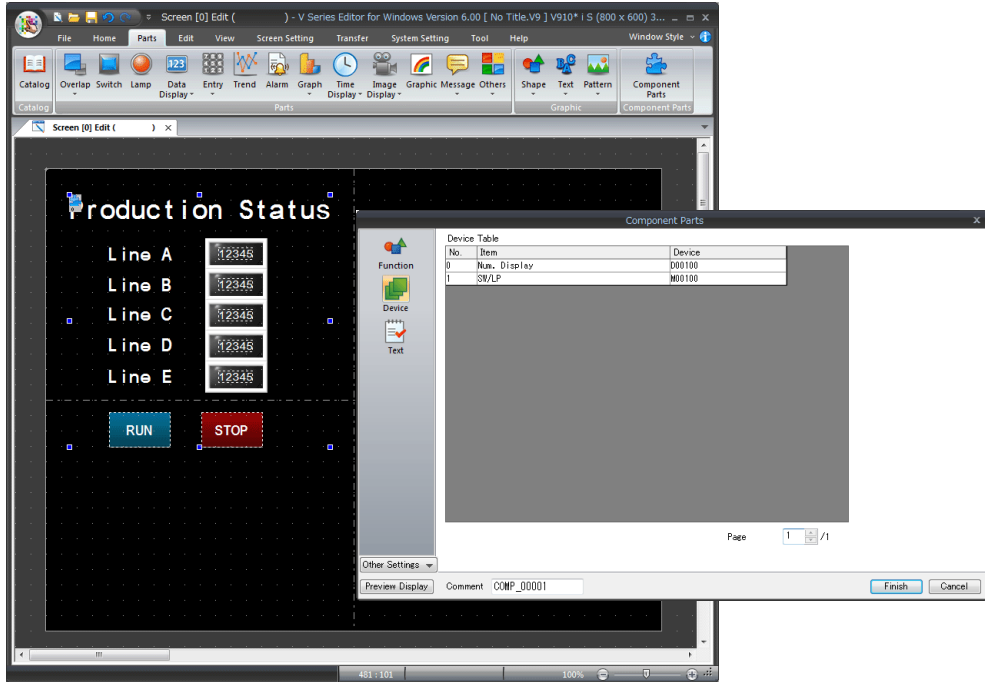

2. Double-click the device memory cell to make the address editable.

Example: Change D100 → D200 and M100 → M200

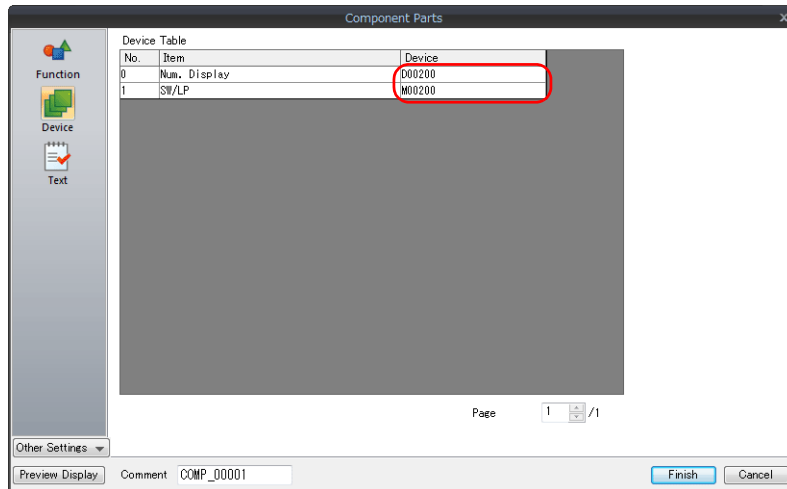

Example of changing addresses

Before change		After change	
Memory Table	PLC Memory	Memory Table	PLC Memory
TBL0.+0.+0	D00100	TBL0.+0.+0	D00200
TBL0.+0.+1	D00101	TBL0.+0.+1	D00201
TBL0.+0.+2	D00102	TBL0.+0.+2	D00202
TBL0.+0.+3	D00103	TBL0.+0.+3	D00203
TBL0.+0.+4	D00104	TBL0.+0.+4	D00204
TBL1.+0.+0	M00100	TBL1.+0.+0	M00200
TBL1.+0.+1	M00101	TBL1.+0.+1	M00201

Step 6: Register a Text Table

A text table is used to register text when editing component parts.

By registering text into a text table, changing text in the item settings window displayed when placing a component part on the screen also allows any associated text to be changed.

1. Change the "Production Status" text on the screen created in step 2 to "%TOS" (one-byte characters) so that it can be used with a text table.

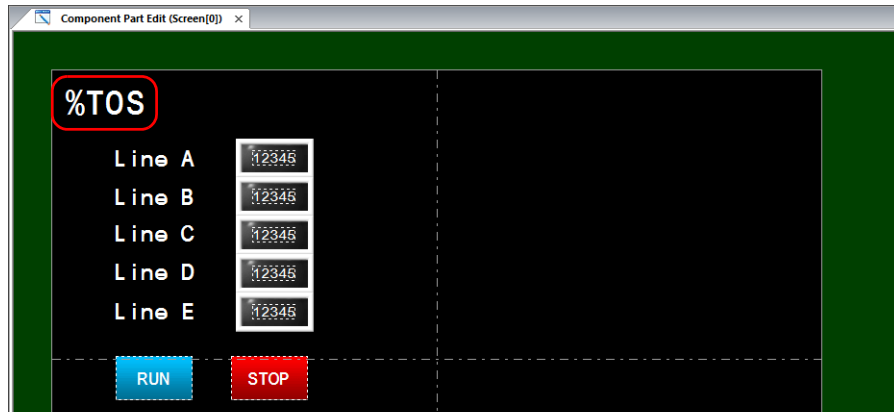

2. Configure a text table.
Click [View] → [Component Text] to display the [Text Table] view window.

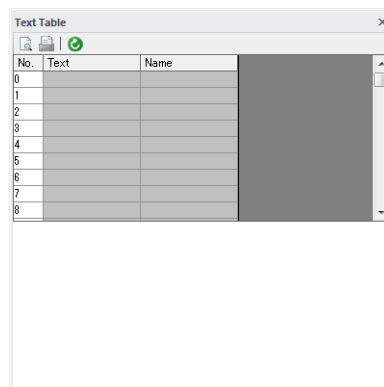
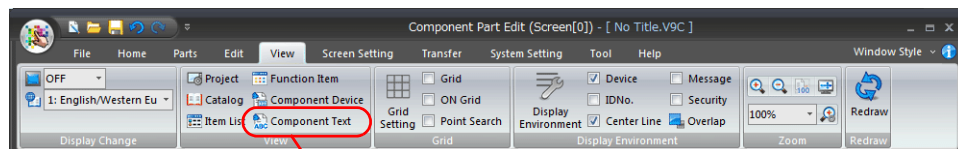

3. Set [No. 0] as follows.

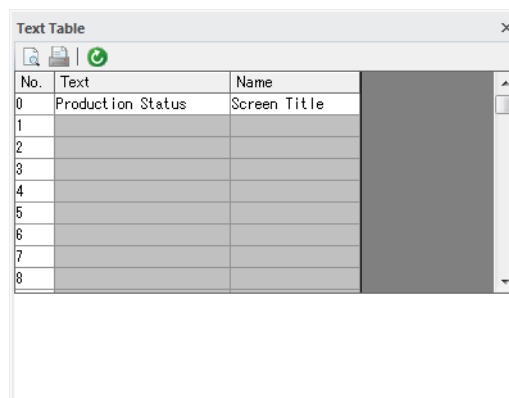

Procedure for changing text of component parts during screen creation

- Place a component part on the screen and display the item settings window. Select a text item to display the text table as shown below.

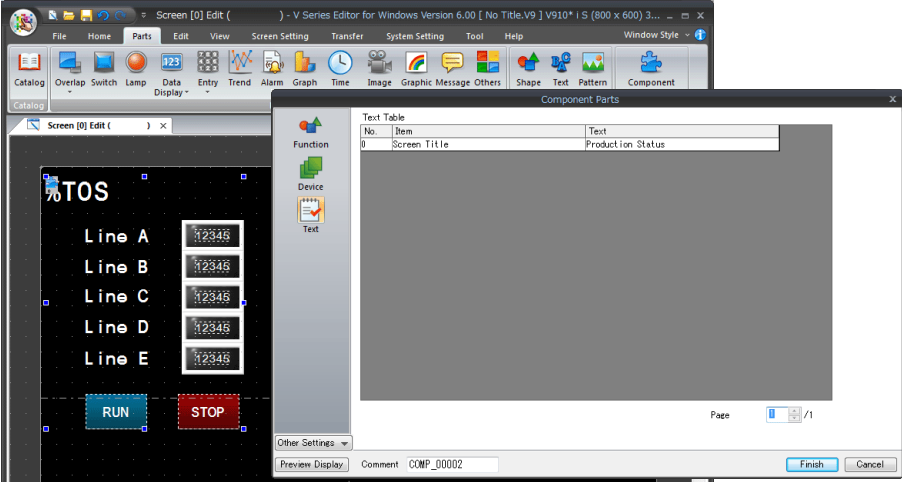

- Double-click on the "Production Status" text to make it editable.
Example: Change "Production Status" to "Line Monitor"

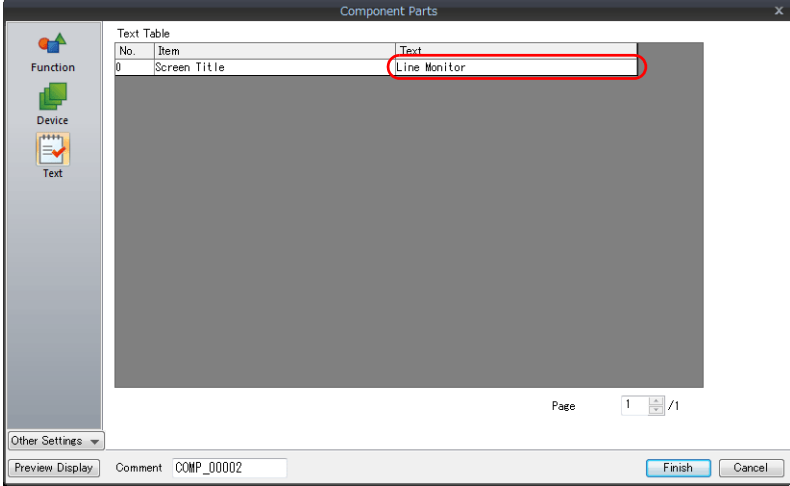

Step 7: Save the Component Part

Click [File] → [Save As] to display the [Save screen program as] window. Specify a filename and click [Save] to save a *.V9C file.

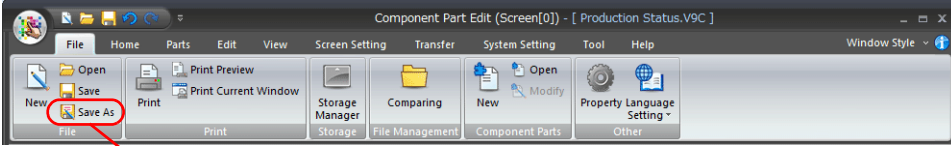
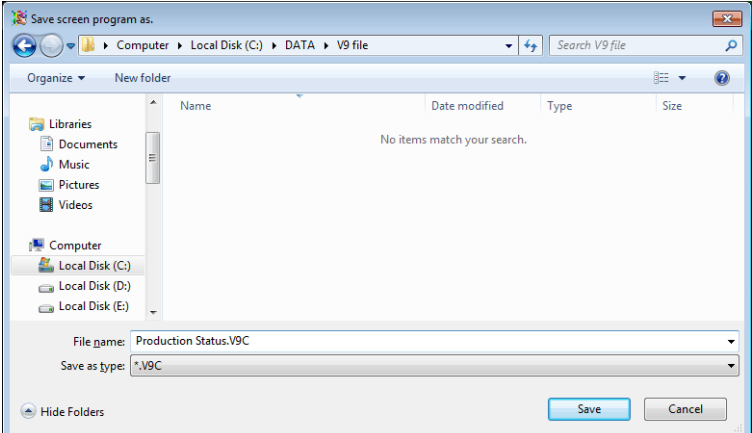



11.4.3 Procedure for Placing Created Component Parts

Placement Procedure

Component parts are used placed on screens in the process of being created or new screens.

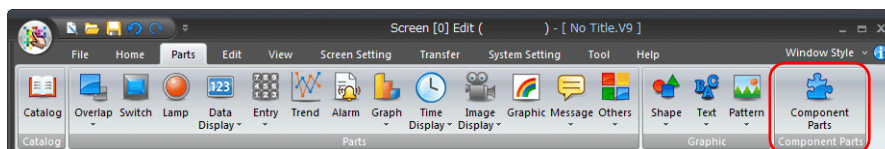
1. Click [Parts] → [Component Parts].



2. The [Select a part] window is displayed.
Click [Add].

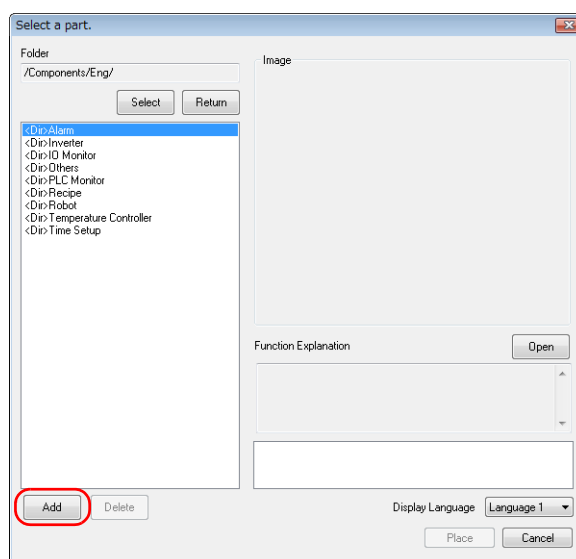

3. In the [Open] window that appears, select the desired part and click [Open].

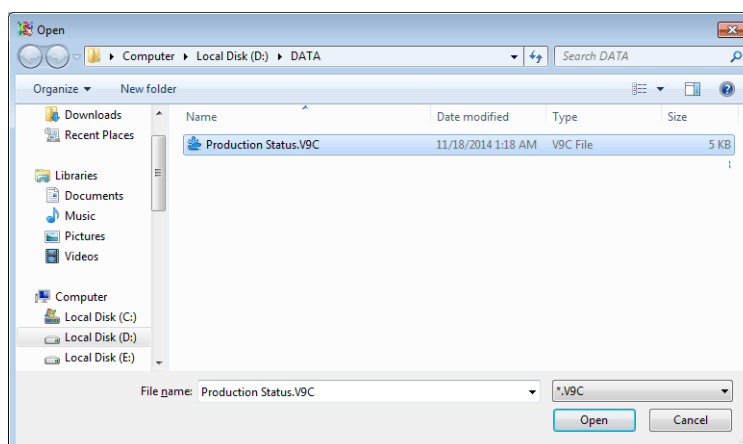

- The part selected in step 3 is added to the [Select a part] window.

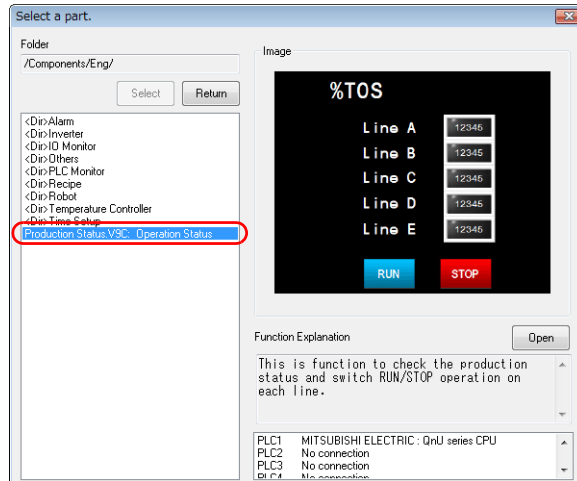

- Select the added part and click [Place].

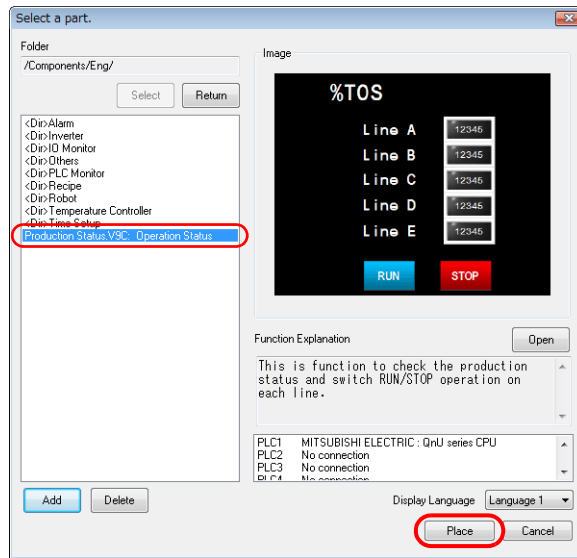

- The mouse cursor changes to a crosshair and the selected part is displayed together with the crosshair. Click a position to place the part.

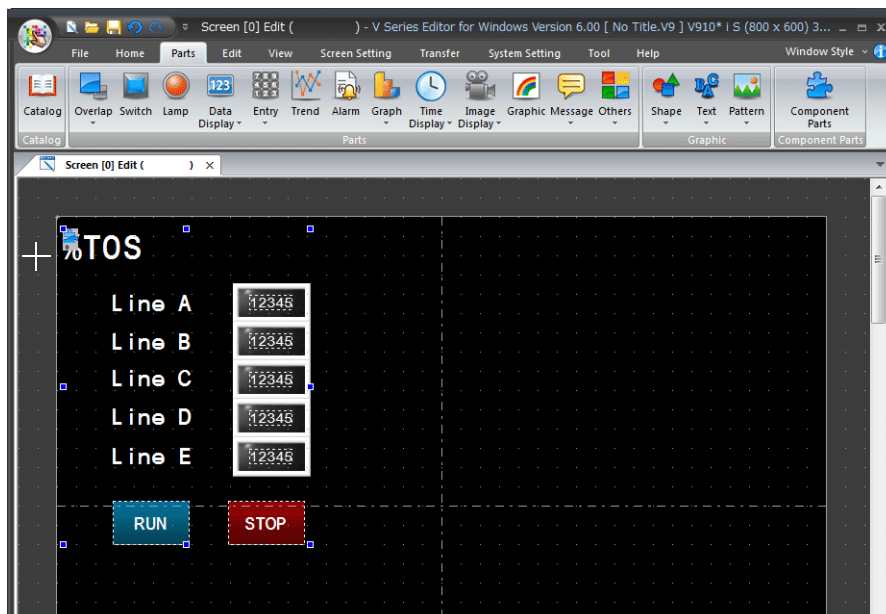

7. Double-click the placed part to display the item settings window.
 - Addresses registered in the device memory table can be changed during component part editing by changing addresses of device memory items.
 - Text registered in the text table can be changed during component part editing by changing the text of text items.



For more information, refer to "Procedure for changing device memory of component parts during screen creation" (page 11-44) and "Procedure for changing text of component parts during screen creation" (page 11-46).



For more information on the component parts supplied by Hakko Electronics, refer to the operation manual of each component part.

Other Settings

Connection device settings

If the settings of connected devices differ with regard to component parts and placement destination in the screen program, the connection device settings of component parts can be copied to the placement destination in the screen program.

1. If the settings of connected devices differ with regard to component parts and placement destination in the screen program, a [Device Connection Setting] window for copying the connection device settings is displayed when placing the component parts.

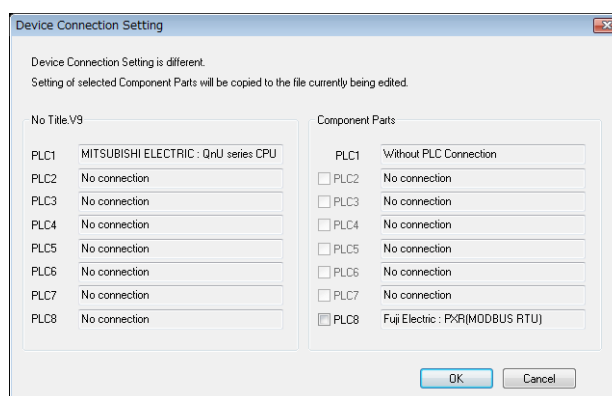

2. Select the checkboxes of the PLC numbers to copy and click [OK] to copy the component part settings to the placement destination of the screen program.

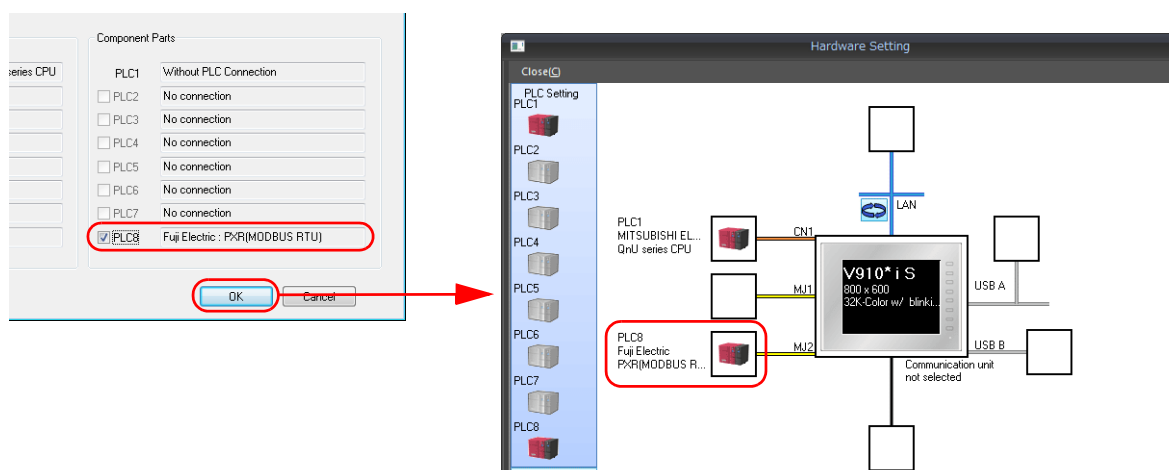

- The [Device Connection Setting] window for copying connection device settings is also displayed when copying and pasting component parts from the screen program being edited to another screen program.
- Copied connection device settings are not deleted when their associated component parts are deleted. Delete the settings manually from the [Hardware Setting] window.

Device memory map

If a device memory map of PLC numbers registered in the placement destination screen program is registered to component parts, the device memory map is automatically copied when placement is performed.

If a device memory map already exists for the placement destination, content is copied to the vacant numbers of the existing device memory map. If there are no vacant numbers at the placement destination, a placement error occurs.



- Every time component parts are copied and pasted, the associated device memory map is also copied.
 - When deleting component parts, the copied device memory map is also deleted.
 - A device memory map copied from component parts cannot be edited on the placement destination screen.
-

Multi-language settings

When the multi-language settings of the current screen program differ from the settings of component parts, the multi-language order of component parts are automatically switched to match the order of the placement destination screen program.



If the font settings of component parts and the placement destination screen program are completely different, characters may be garbled because switching processing is not performed in this case.

11.4.4 Editing Placed Component Parts

Component parts become editable after placement to allow changes to part color and layout.



Do not perform changes to the settings of component parts supplied by Hakko Electronics that are not described in the component part operation manuals. Making such changes may prevent the component parts from operating correctly.

Editing Procedure

1. With the placed component parts selected, click [File] → [Component Parts] → [Modify] or right-click and select [Modify].

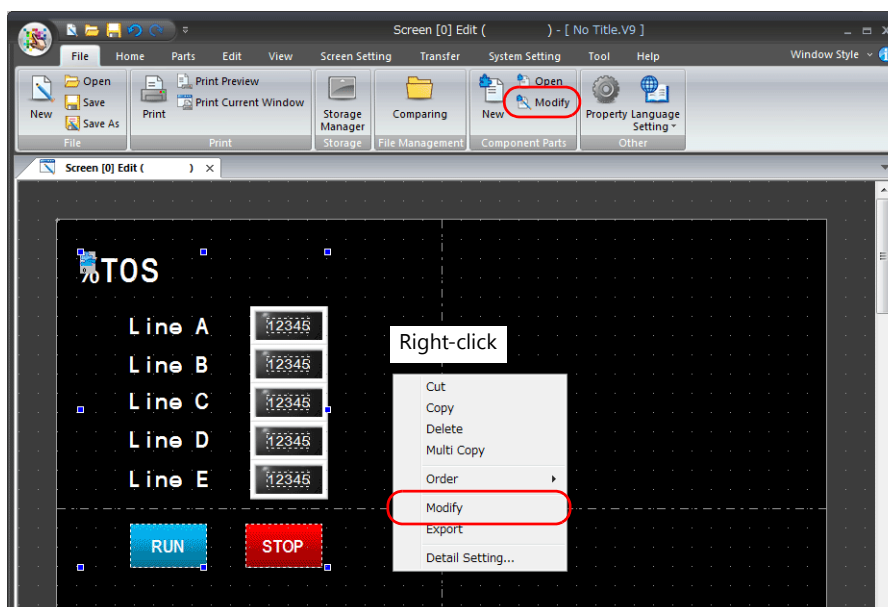

2. The [Component Part Edit] tab window is displayed. Edit the items to change in this tab window.

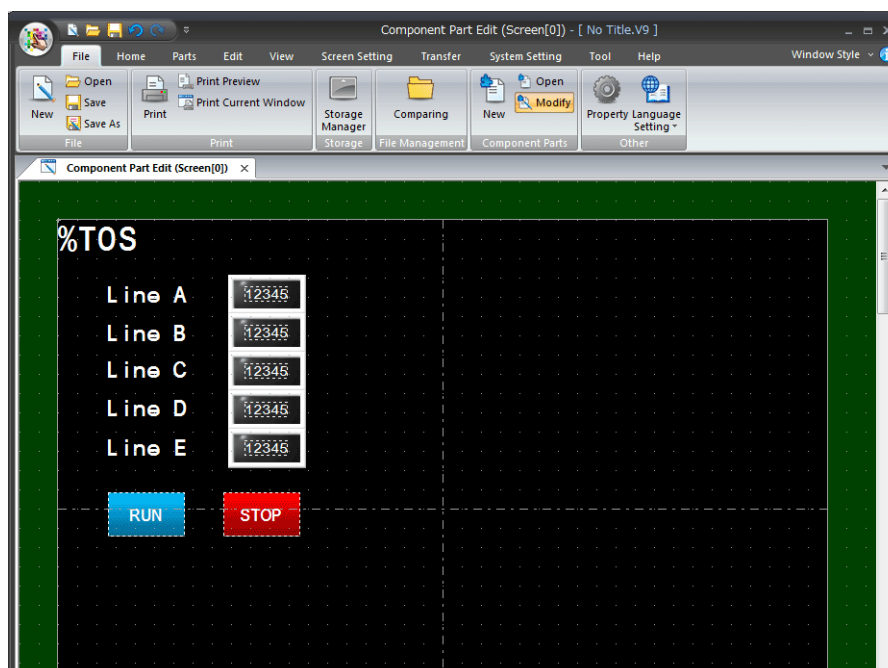

- When the changes are complete, click [File] → [Component Parts] → [Modify] or click [X] on the [Component Part Edit] tab window. The previous screen is displayed again.

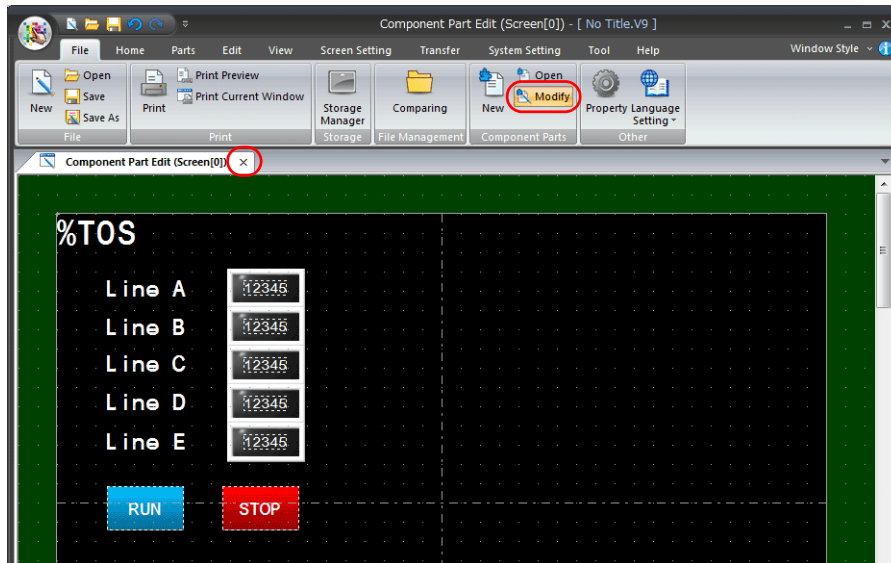

Hakko Electronics Co., Ltd.
www.monitouch.com

Sales 890-1, Kamikashiwano-machi, Hakusan-shi, Ishikawa,
924-0035 Japan
TEL +81-76-274-2144 FAX +81-76-274-5136