



INFRARED TEMPERATURE PRODUCT HANDBOOK & INSTALLATION GUIDE REV. 8

Self powered, infrared thermocouples, smart microprocessor based powered sensors, fast thermal switches, and NIST traceable thermometers



EXERGEN

C O R P O R A T I O N

Non-Contact Temperature Sensors for:

- *Product Inspection*
- *Process Control*
- *Factory Automation*
- *Maintenance and Safety*
- *OEM*

400 Pleasant Street

Watertown, MA U.S.A. 02472

617-923-9900, (F) 617-923-9911

www.exergen.com/industri



2006



How to contact EXERGEN Corporation

MAIL: EXERGEN Corporation
400 Pleasant Street
Watertown, MA 02472

PHONE: (617) 923-9900

SALES: (800) 422-3006

FAX: (617) 923-9911

EMAIL: industrial@exergen.com

WEBSITE: www.exergen.com/industrial

Table of Contents

- About Exergen Corporation..... 4
- Why Use The IRt/c™..... 5
- What is Infrared Thermometry 6
- Exergen Tools To Help You Understand The Technology 7
- IRt/c Installation..... 8
- What Information Is Needed To Recommend The Correct IRt/c 9
- Accessories / Input Device Selection..... 10
- Exergen Product Overview
- Precalibrated IRt/c's 12
- Adjustable IRt/c's 16
- micro IRt/c..... 18
- Smart IRt/c.....20
- Smart-microIRt/c 22
- Handheld Infrared Thermometers..... 23
- Microscanner E for Electrical Inspection..... 24
- SnakeEye Non-Contact Sensors For Infrared Thermal Switching..... 25
- Accessories 26
- Applications 27

World leader in the science and technology of infrared thermometry systems

About Exergen Corporation

During the 1970's energy crisis, Exergen Corporation was formed as a consulting company to develop new methods of reducing energy use for institutional and industrial clients. To find targets for energy savings, Exergen designed innovative sensors and instruments which measured energy lost through temperature changes or leakage at critical construction points, such as around window casing.

This early work led to the design and manufacturing of an extensive line of infrared sensors, thermometers, and scanners for industrial and medical applications. The advantages of the infrared temperature technique include:

- Measurement in hard to reach areas, such as embedded areas, electrical transformers or production ovens.
- Non-destructive, non-contaminating technique, for use in product quality control.
- Temperature determinations of moving objects, such as products on conveyor belts.

Infrared Temperature Systems

Relied upon by industry, Exergen Non-contact Infrared Temperature Systems provide accurate, reliable, and cost effective temperature measurements at process critical control points. With over 300 models, Exergen temperature sensors are an industry standard in such diverse applications as printing, packaging, climate control, and medicine. Exergen's product selection includes:

IRt/c™ - industry's most widely used infrared thermocouple sensor. With no power requirement, this extensive product line includes a wide selection of temperature ranges, sight views, and housings to meet the needs of the most difficult applications.

Smart IRt/c™ - Fully linearized, plug and play, powered sensor. Achieve optimal accuracy over temperature ranges of 0-100C, and 0-250C. With the Smart Air Purge, Smart Emissivity Shift Compensation, Smart Ambient Radiation Error Correction, Smart Continuous Auto Calibration, Automatic Self-Diagnostics, and Smart Six Variable Calibration, this product is the most accurate on the market.

Smart-microIRt/c™ - remote micro sized sensor heads (4 types available) wired to Smart electronics with same features of Smart IRt/c's

D Series and DX Series- the world's first pocket handheld infrared temperature units. NIST traceable measurement accuracy allows double duty as a temperature calibration unit as well as a thermal scanning measurement device.

SnakeEye™ - industry's choice for production line quality inspection of thermal processes/ thermal signatures at speeds up to 1000 ft. per minute.

Exergen's unique, patented technologies set the benchmark for non-contact infrared temperature measurement throughout a wide range of industrial and medical applications. All products are designed and manufactured by Exergen in the U.S.

Exergen's Mission Statement

We are the best in the world at what we do, and our products and services must be commensurate with our mission of supplying our customers with the best, to help them be the best in the world at what they do.

Why Use The IRt/c™?

Temperature is one of the most commonly measured and controlled parameters in industry

That statement alone should provide a clue as to why you want to utilize IRt/c's. Proper monitoring and control of process temperature improves product quality, reduces product scrap, and improves overall product yield and process speed. Every industry in today's competitive marketplace is putting in place programs and systems to lower production costs, through automated production and quality control systems. The benefits of employing Exergen Infrared Temperature products contribute directly to the bottom line.

Exergen products are easy to use

Exergen temperature sensors provide a cost effective means for obtaining highly accurate and reliable temperature data. These products provide you a powerful new technology. Designed to emulate a thermocouple signal, these sensors will replace any existing in-line thermocouple measurement. Providing a direct measurement of product temperature, not thermocouple temperature, results in faster and more accurate results.

Also available for OEM accounts, Exergen can meet the different housing, mounting and signal output needs of different design requirements. The sensor's small size and rugged construction make integration into systems simple. Plus, these sensors are factory calibrated and require no power for operation, further simplifying installation.

For linearity and permanent, drift free accuracy over a wide temperature range, and a non thermocouple signal output (i.e. 0-5V, 0-10V, 4-20mA, or RS-232), the Plug and Play Smart IRt/c is available. No thermocouple knowledge is necessary (cold junction compensation, t/c cable, leakage current, impedance, etc.) .

Similarly, the D Series and DX Series are an entirely different type of instrument than conventional temperature measuring devices. Designed specifically for the highest possible accuracy, they are the only instruments that can be certified with NIST-traceable accuracy on real surfaces of unknown emissivity, while remaining completely free of the contact errors and heat sinking errors of contact devices.

The SnakeEye products provide photocell simplicity of operation with extraordinary thermal sensitivity to "see" each and every hot melt adhesive bead as it is applied in real time. Now you can have 100% inspection of hot melt adhesives on your products.

What is Infrared Thermometry?

This measuring technique uses the properties of IR light waves to determine a target's temperature. By employing an infrared detector, the sensor detects the amount of thermal energy emitted from a target as IR light. There is a known relationship between the amount of infrared radiation emitted by an object and the object's surface temperature. Exergen products detect only specific IR wavelengths, so other sources of IR light, such as the sun, will not interfere with the measurement. Exergen can calibrate the IRt/c™ to provide a linear output signal similar to a specific thermocouple type, over a specified temperature range.

The major features of IRt/c temperature sensors

- Highly repeatable (error < 0.01°C)
- Non-contact measurement method
- Self powered - no excitation needed
- Emulates a t/c within a specific temperature range with 2% (or 2 °C, whichever is greater) accuracy
- Smart IRt/c's linearize over wide temperature ranges with superb accuracy
- Multiple output options available (t/c, 0-5V, 0-10V, 4-20mA, RS-232)
- Factory calibrated to real world operation conditions
- Small size, simple, rugged, and intrinsically safe
- Easy installation
- Fast response time
- Interchangeability ± 1%
- Cost effective

How infrared temperature technology improves your process control and throughput

- Increase production speed (see Speed Boost Equation, www.exergen.com/industry/spdboost)
- Reduce scrap costs through regulation of process critical procedures
- Improve quality with a low cost, direct monitoring solution
- Decrease safety risks due to out of control processes
- Measure moving or dirty samples, too difficult or labor intensive for a contact measurement technique

Why use Infrared Temperature Technology, over other measurement techniques?

- Non destructive measurement method, so no damage to the product
- Non contact method means less cleaning and maintenance required
- No breakage due to contact with moving objects
- Fast thermal response time
- Wide temperature range
- Highly accurate data, by measuring actual product temperature, not the sensor's temperature

The major features of the D Series and DX Series include

- No emissivity concerns
- No user adjustment errors
- Substantial reduction in background reflection errors
- No contact errors
- No friction heating errors
- No heat sinking or time based errors

The Snake Eye offers the following advantages

- Extraordinary thermal sensitivity
- Ability to sense through a closed flap
- Fast response time
- High speed operation

Exergen Tools To Help You Understand The Technology

Exergen In-House Technical Support, *Factory Experts at Your Service*

- To help you succeed, Exergen provides application review, product selection, and installation assistance for you. We provide four methods of contacting Exergen's In House Technical Support group, choose the method most convenient for you:
- Via Web: Log on to www.exergen.com and view the Industrial Division Page. Fill out our Tech Support Form. We will respond via email promptly.
- Via Email: Write to industrial@exergen.com to request further product information, literature, or technical assistance.
- Via FAX: Fill out a "Factory Expert" application support sheet and fax back to Exergen at (617) 923-9911.
- Via Phone: Call Exergen at (617) 923-9900, x 6238 with application questions.

Use the Power of the Internet at www.exergen.com for Instant Product Information

The Exergen website contains a wealth of information to assist you in specifying a project. From this site you can:

- Download the *Handbook of Non-Contact Temperature Sensors*. This catalog details all of Exergen's products, including product selection guides, specifications, and dimensional drawings.
- Obtain technical assistance using our Technical Support Link.
- Review Exergen's Technical Notes to receive detailed application and product installation information.
- Download product datasheets and brochures.
- Learn what's new with Exergen's Press Release Announcements introducing new products and services, and Technical Spotlights.
- mV vs. temperature curves for some of our common IRt/c sensors are available.
- Visit our worldwide network of distributors, reps and agent's websites for your local support.

IRt/c Installation

Set-up

1. Calibrate the meter for possible leakage current prior to installation (not necessary for Smarts)
 - a. Short out input to meter
 - b. Record the reading on the display
 - c. Attach the IRt/c sensor in normal fashion (Red is negative, see diagram for Smart below)
 - d. Place piece of aluminum foil over sensor window to blind sensor
 - e. Record new reading
 - f. $\text{Offset} = \text{Reading}_{\text{step e}} - \text{Reading}_{\text{step b}}$
2. Install sensor as close as possible to view target material.
3. Bring target up to operating temperature.
4. Contact the D or DX Series to the target and record the temperature.
5. Adjust the controller (Span, Gain or Hi Cal) to match the reading from step 4.

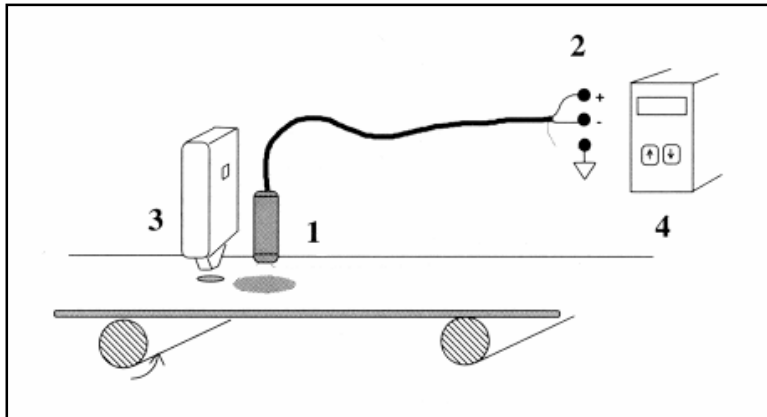

SmartIRt/c Wiring Diagram

Pin	Color	Function
1	White	Positive Output Voltage Signal
2	Green	Reference Output Voltage Signal
3	Red	Positive Power
4	Black	Ground
5	Bare	Shield
6	Brown	TA Pull Down Pin, Alarm (optional)
7	Yellow	RS232_TXD (optional)
8	Violet	RS232_RXD (optional)
9	Blue	RS232_RTD (READY_TO_SEND) / IO (optional)
10	Orange	RS232_CTS CLEAR_TO_SEND) / IO option, error alarm (optional)

What Information Is Needed To Select The Correct IRt/c™

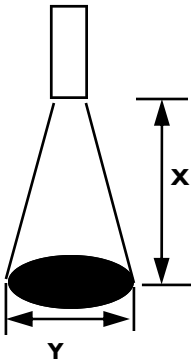
Question	Answer	Product Recommendation
<p>What is the target size (Y) and distance from sensor to target (X)?</p> 	<p>< 0.25" at distance greater than 0.75" < 0.8" at distance greater than 4"</p> <p>> 0.30" at 0.30" (or > distance from sensor to target)</p> <p>> 0.25" at 0.75" (or > distance from sensor to target divided by 3; i.e. target at least 2", distance 6" or closer)</p> <p>> 0.80" up to 4.0" (or > distance from sensor to target divided by 5; i.e. target at least 2", distance 10" or closer)</p> <p>> 0.80" up to 8.0" (or > distance from sensor to target divided by 10; i.e. target at least 2", distance 20" or closer)</p>	<p>IRt/c adjustable model with focused lens</p> <p>1:2 FOV model (micro IRt/c) 1:1 FOV models (IRt/c, IRt/c.01, IRt/c.1X, and IRt/c.SV)</p> <p>3:1 FOV models (IRt/c.3X, IRt/c.03, IRt/c.3SV, and SmartIRt/c)</p> <p>5:1 FOV (IRt/c.5)</p> <p>10:1 FOV (IRt/c.10 and IRt/c.07)</p> <p><i>FOV = X : Y where X = Sensor distance to target Y = Target Area Therefore, a sensor with FOV 3 : 1 provides a 1" target area when the sensor is placed 3" away.</i></p>
<p>How close can the sensor be located to the target without overheating?</p>	<p>Placement in ambient < 160 °F (70 °C) Placement in ambient < 185 °F (85 °C) Placement in ambient > 185 °F (85 °C)</p>	<p>ABS plastic housed units (IRt/c.01, IRt/c.03, IRt/c.07), SmartIRt/c and µIRt/c Any Stainless steel model without airpurge IRt/c with either built in or added air purge/cooling jacket</p>
<p>What is the surface material of the target?</p>	<ol style="list-style-type: none"> 1. Non-metals/coated metals, < 500 °F 2. Metal surfaces, >500 °F 3. All surfaces < 500 °F 4. Non-metals/coated metals, -50-1200 °F 5. All surfaces, >1200 °F 	<ol style="list-style-type: none"> 1. Precalibrated model w/non programmable input device and SmartIRt/c 2. Special LoE Adjustable models 3. SmartIRt/c 4. Precalibrated models w/programmable input device (mV tables are provided over -50 to 1200 °F range) 5. Custom calibrated Adjustable models w/programmable input device w/gain adjustment for emissivity.
<p>What is the desired output?</p>	<p>Selection based on current installation requirements.</p>	<p>IRt/c's can emulate a particular t/c signal over a given temperature range. Specify t/c type in model code selection. (J, K, T, etc.). Smart IRt/c's have 0-5V, 0-10V, 4-20mA, and RS-232 outputs</p>
<p>What is the target's temperature range?</p>	<ol style="list-style-type: none"> 1. Narrow ranges, <500 °F 2. Narrow ranges, >500 °F 3. Wide ranges, -50 to 1200 °F 4. Wide ranges, > 1200 °F 5. All wide ranges 	<ol style="list-style-type: none"> 1. Precalibrated IRt/c w/non programmable input device and SmartIRt/c 2. Adjustable IRt/c w/non programmable input device 3. Precalibrated IRt/c w/programmable input device 4. Adjustable IRt/c precalibrated to range 5. SmartIRt/c
<p>What is the ambient temperature range where the sensor is mounted?</p>	<ol style="list-style-type: none"> 1. -50 to 160 °F 2. 160-185 °F 3. 185-240 °F 4. 240-400 °F 5. 400- 700 °F 6. 700-1000 °F 	<ol style="list-style-type: none"> 1. IRt/c w/ABS housing (IRt/c.01, IRt/c.03, IRt/c.07, µIRt/c & SmartIRt/c) 2. IRt/c w/SS housing (IRt/c, IRt/c.SV, IRt/c.1X) 3. IRt/c w/built in air purge and SS housing (IRt/c.3X) 4. IRt/c w/built in air purge and SS housing (IRt/c.5, .10, and all adjustables) 5. IRt/c w/ external air cooling jacket & SS housing 6. IRt/c w/external water cooling jacket & SS housing
<p>Is there dust, dirt or condensation in the environment?</p>	<p>Yes</p>	<p>IRt/c w/air purge to maintain optical cleanliness and SmartIRt/c</p>
<p>What type of input device?</p>		<p>See next section, page 11.</p>

Accessories / Input Device Selection

Add-on Products

IRt/c™ Installation Accessories

Is the installation site high in ambient temperature? You can use a cooling jacket or air pump kit to ensure performance success for the environmental conditions.

Is the product to be mounted in a difficult space, requiring extension cables and connectors? Exergen provides mounting, brackets and wiring accessories for use with our IRt/c sensors. Refer to the Exergen Product Overview section of this book, for a complete description of offerings.

Every IRt/c needs a readout device

Each sensor requires some type of readout device, to interpret the sensor's mV output into useful information for the customer. Therefore, based on the installation needs, you may require a monitor, transmitter, PLC, or some other type of device.

To help you match the IRt/c's output requirements with the appropriate readout device, consider the following features when selecting a system:

1. IRt/c to Instrument Compatibility: Choose an instrument with a low leakage current (<10 nA). Leakage current is generated by the circuit diagnostics used to detect t/c wire breaks and by the input amplifier circuit. Although the measurement offset generated can be calibrated out, choosing a device with low leakage current simplifies sensor installation and calibration. With the SmartIRt/c, leakage current problems go away. An instrument with adjustable Span, Gain, or Cal High is required for easy sensor calibration.
2. Programmable vs. Non-programmable Device: A programmable device, with the option to download custom curves, allows the user to download Exergen's custom temperature curves to obtain higher measurement accuracy over the full sensing range of the IRt/c.
3. Output Signal: Consider the signal output needs of the application. Does the installation require 4 - 20 mA, 0 - 5 V, or 0 - 10 V output signal? Does this signal need to be linear? The SmartIRt/c and some transmitters and controllers provide this option. The SmartIRt/c does it all in one complete package.
4. Data Manipulation: Alarming, averaging, min/max, and peak pickers are all instrument features which customers find helpful. Alarms signal when a temperature reaches a critical high or low point. Data averaging combines and smoothes multiple measurements to minimize process variations. Devices using a Peak Picker feature hold product temperature in-between measurement gaps, to eliminate large signal changes and provide between sample control.

CONTACT YOUR LOCAL DISTRIBUTOR FOR INPUT DEVICES, CONTACT US FOR A LIST OF
DISTRIBUTORS OR VISIT
www.exergen.com/industry/distrib/

Some Recommended Input Devices

Others:

Manufacturer	Products	Model	Features (see preceding page)
Eurotherm Controls	Controls	2100 2200 2400	1, 2 1, 2 1, 2, 3
Harmony Technologies	Smart Transmitters	ST-5000	1, 2, 3, 4
Mescon	Smart Transmitters	MesConfigurator	1, 2, 3
QHi Infrared	Smart Transmitters	IRt/c Transmitter	1,2,3
	Thermal Monitoring Systems for Electrical Maintenance/Fire Protectio\n	Exertherm	1,4
		MT101, 301, 302, 501	1,2,3,4
Apogee Instruments	Data logger for agricultural and environmental use	Nanologger	1,4
Omega	Handheld data loggers	HH305/306	1,2,4
	Handheld indicators	HH200A	1,2,3,4

Controllers- Athena, Cal, Fenwal, Fuji, Honeywell, Love, Newport, Omega, Omron, Partlow, Red Lion, Syscon, Watlow, Yamatake, Shinko.

PLC's - Allen Bradley, Honeywell, Omron, PLC Direct, Siemens, Toshiba.

Transmitters - Accutech, Eurotherm, Honeywell, Moore Industries, Newport Rosemount, Siemens, Yokogawa

Indicators/Handheld - Cole-Parmer, Davis, Fluke, Keithley, Omega, Omron, Texmate, TME, Wahl, Yogogawa.

Data acquisition/signal conditioning - Analog Devices, IoTech, National Instruments, Strawberry Tree.

Feel free to contact the factory to discuss compatibility issues of any input devices.

Exergen Product Overview

Precalibrated IRT/c™ Sensor SPECIFICATIONS



Signal Output: Thermocouple type (J, K, etc.) over specific temperature ranges (IRT/c.10, Type K only)
Power requirements: None
Cold Junction Compensation: By measuring instrument, as with conventional thermocouples
Emissivity: 0.9 for non-metal surfaces at 25°C ambient
Repeatability: 0.01°C
Ambient Temperature Coefficient: 0.02% of reading/°F (0.04% / °C) or 0.02°F of reading/°F (0.04°C of reading/°C, whichever is greater)
Response Time Constant: Approximately 100—200 msec (depending on model, can reduce if needed)
Resolution: 0.0001°C
Dominant spectral response: 6.5 - 14 μm
Housings: Stainless steel: hermetically sealed, exceeds NEMA 4, 4X, IP67, intrinsically safe, cable shield grounded to housing and electrically isolated from signal. ABS: high strength plastic, hermetically sealed, exceeds NEMA 4, 4X, IP67, intrinsically safe, two locknuts supplied.
Cable: Stainless steel IRT/c's: Twisted shielded pair of base thermocouple material (J, K, etc), 3 ft (0.9 m) std length, teflon sheathed, rated to 392°F (200°C). ABS IRT/c's: Thermocouple extension grade, PVC jacket, unshielded, rated to 221°F (105°C).

Family	Model Selection	Output Impedance	Minimum spot size	Features
Light Duty ABS Plastic	IRT/c.01 (1 to 1 FOV)	Approx. 3 kΩ	0.3" (8 mm)	Low cost design alternative High strength ABS housing with mounting locknuts Small size for easy integration into existing designs Rated for use up to 70 °C (160 °F) Target temperature -45 to 290 °C (-50 to 550 °F)
	IRT/c.03 (3 to 1 FOV)	Approx. 4-8 kΩ	0.25" (6 mm)	
	IRT/c.07 (7 to 1 FOV)	Approx. 4.5-12.5kΩ	0.8" (20 mm)	
Stainless Steel	μIRT/c (1 to 2 FOV)	Approx 9-37 kΩ	0.1" (3 mm)	Cooling jackets for use to 540 °C (1000 °F), rated for up to 85° C (185°F) without. IRT/c.1X & IRT/c.3X include threaded nose, locknuts and mounting brackets IRT/c.3x includes built in air-purge for use in dirty or dusty environments, will cool up to 120 °C (240 °F) Target temperature -45 to 650 °C (-50 to 1200 °F)
	IRT/c (1 to 1 FOV)	Approx. 3 kΩ	0.3" (8 mm)	
	IRT/c.1X (1 to 1 FOV)	Approx. 3 kΩ	0.3" (8 mm)	
	IRT/c.3X (3 to 1 FOV)	Approx. 4-8 kΩ	0.25" (6 mm)	
	μIRT/c.4 (4 to 1 FOV)	Approx 12-32 kΩ	0.1" (3 mm)	
Stainless Steel Lensed	IRT/c.5 (5 to 1 FOV)	Approx. 3.5-11.5 kΩ	0.8" (20 mm)	Use for longer target distances Rated for use to 85 °C (185 °F) ambient Built in air purging/cooling for use to 260 °C (500 °F) ambient Target temperature -45 to 650 °C (-50 to 1200 °F)
	IRT/c.10 (10 to 1 FOV)	Approx. 4.5-12.5 kΩ	0.8" (20 mm)	
Stainless Steel Side View	IRT/c.SV (1 to 1 FOV)	Approx. 3 kΩ	0.3" (8 mm)	Mounts in narrow spaces Use up to 85 °C (185 °F) ambient IRT/c.3SV & μIRT/c.4SV include built-in air purge for use in dirty or dusty environments, will cool up to 120 °C (240 °F). Target temperature - 45 to 650 °C (-50 to 1200 °F)
	IRT/c.3SV (3 to 1 FOV)	Approx. 4-8 kΩ	0.3" (8 mm)	
	μIRT/c.4SV (4 to 1 FOV)	Approx 12-32 kΩ	.01" (3 mm)	
	μIRT/c.SV (1 to 2 FOV)	Approx 9-37 kΩ	0.1" (3 mm)	

Precalibrated IRt/c™ Model Code

Use the following model code selection guide to configure the appropriate sensor:

Pick one selection from each group.

IRt/c. **1** **2** **3**
 _____ - _____ - _____

Example: IRt/c.3X-K-240F/120C

1. IRt/c Model

- 01 Light Duty, ABS housing, 1:1 FOV (Field of View)
- 03 Light Duty, ABS housing, 3:1 FOV
- Stainless Steel housing, 1:1 FOV
- 1X Stainless Steel housing, threaded nose, 1:1 FOV
- 3X Stainless Steel housing, threaded nose, integral air purge, 3:1 FOV
- 5 Stainless Steel housing, lensed model, integral air purge, 5:1 FOV
- 07 Light Duty, ABS housing, 7:1 FOV (K only)
- JR Light Duty, ABS housing, 10:1 FOV (K only)
- 10 Stainless Steel housing, lensed model, integral air purge, 10:1 FOV (K only)
- SV Stainless Steel housing, side view, 1:1 FOV
- 3SV Stainless Steel housing, side view, integral air purge, 3:1 FOV

2. Thermocouple type

- J J type thermocouple
- K K type thermocouple
- T T type thermocouple
- E E type thermocouple

3. Target temperature range

- 98.6F/37C Human body range
- 50F/10C 0 - 85 °F (-18 - 30 °C)
- 80F/27C 32 - 120 °F (0 - 50 °C)
- 140F/60C 70 - 190 °F (20 - 90 °C)
- 180F/90C 140 - 220 °F (60 - 105 °C)
- 240F/120C 180 - 250 °F (80 - 120 °C)
- 280F/140C 240 - 330 °F (115 - 165 °C)
- 340F/170C 280 - 370 °F (140 - 190 °C)
- 440F/220C 320 - 500 °F (160 - 260 °C)

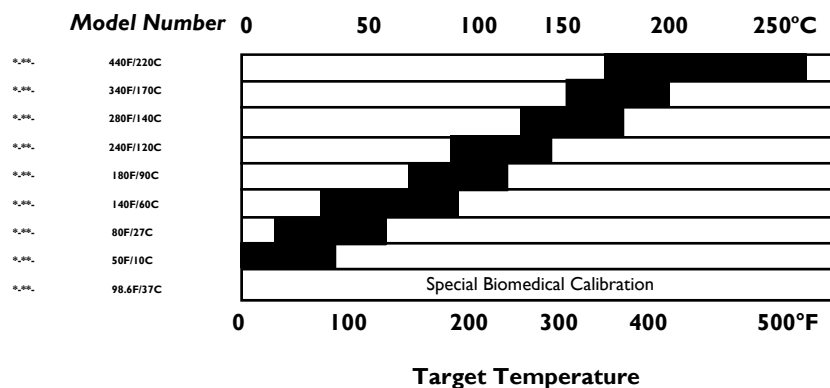

Precalibrated Model IRt/c's

IRt/c.01

1:1 Field-of-view

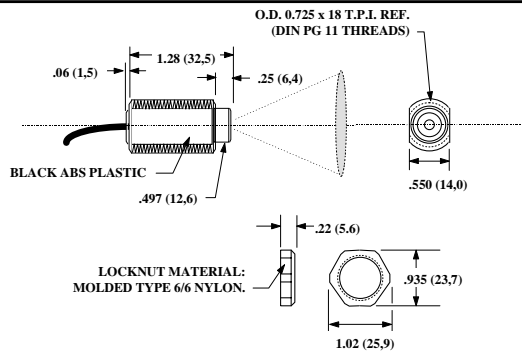

IRt/c.03

3:1 Field-of-view

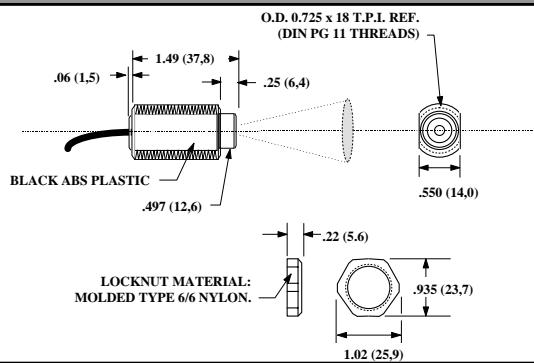

IRt/c

1:1 Field-of-view

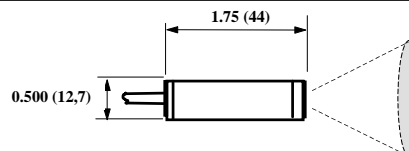

IRt/c.SV

1:1 Field-of-view

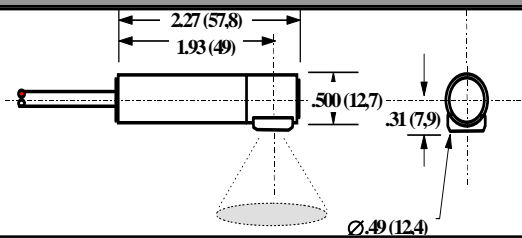

IRt/c.1X

1:1 Field-of-view

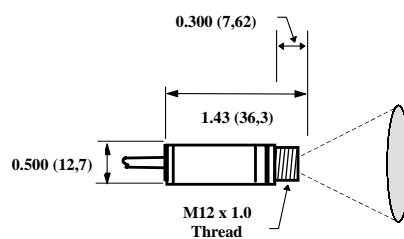
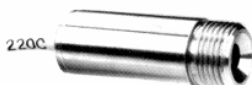

Includes ss mounting brackets and locknuts

Precalibrated Model IRt/c's

IRt/c.3X

3:1 Field-of-view

Built-in Air Purge

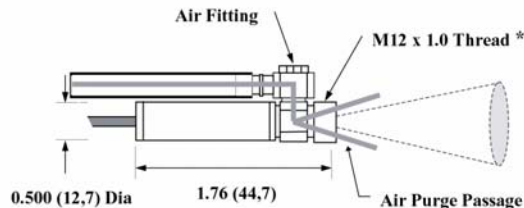
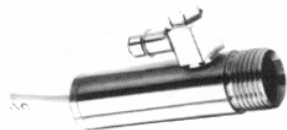

*Includes stainless steel mounting brackets and locknuts

IRt/c.3SV

3:1 Field-of-view

Built-in Air Purge

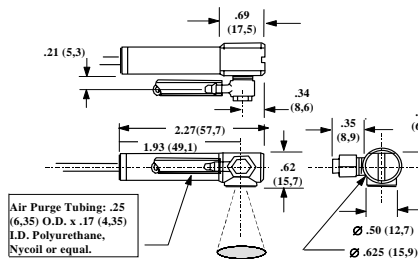
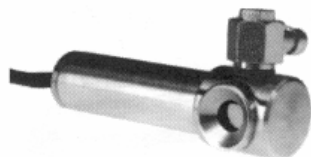

IRt/c.5

5:1 Field-of-view

Built-in Air Purge

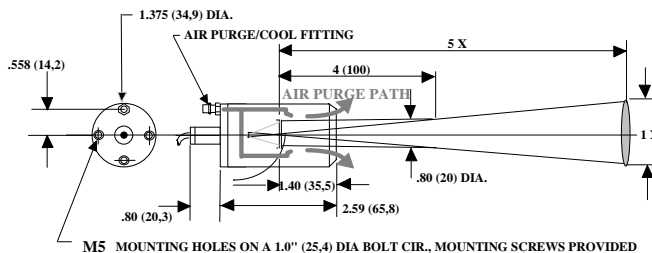
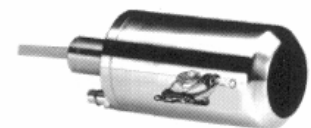

IRt/c.10

10:1 Field-of-view

Built-in Air Purge

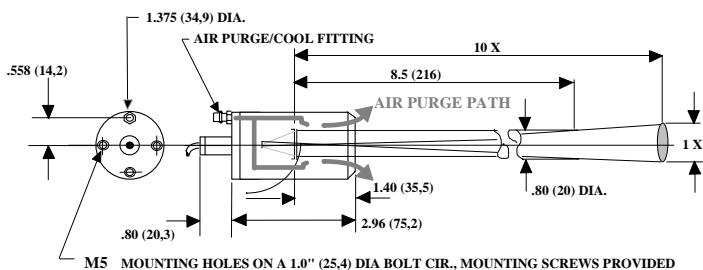

IRt/c.07

7:1 Field-of-view

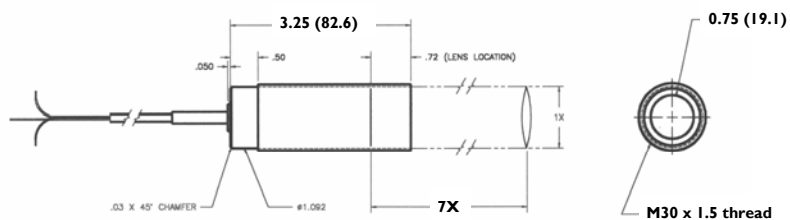

Exergen Product Overview

Adjustable IRt/c™ Sensors

Where Used

- Extrusions
- Oven control
- Molten metals
- Small objects
- High temperature
- Low and varying emissivities



Features

- User calibrated to match user specific t/c output and temperature range
- Provides choice of optimized temperature ranges
- Available in range of FOV
- Includes focused models to view targets through tight openings
- Choice in emissivity range to match target material
- Conventional t/c output signals available (J, K, R/S, etc.)

Adjustable IRt/c Sensor Models

Family	Model Selection	Features
Standard Adjustable	IRt/c.10A (10 to 1 FOV) IRt/c.20A (20 to 1 FOV) IRt/c.100A (100 to 1 FOV)	Stainless steel housing Built in air purge cooling system Rated for use up to 85 °C (185 °F) ambient
Close Focused Adjustable	IRt/c.2ACF (2.9 mm spot dia.) IRt/c.4ACF (5.0 mm spot dia.) IRt/c.8ACF (8.5 mm spot dia.) IRt/c.2/15ACF (2.9 x 8.7 mm rectangular focal slot)	Focal point at 43 mm from sensor Approximate 30° view angle beyond focal point Target temperature -18 to 1370 °C (0 to 2500 °F)*
Medium Focused Adjustable	IRt/c.3AMF (3 mm spot dia.) IRt/c.6AMF (6.5 mm spot dia.) IRt/c.12AMF (11.1 mm spot dia.) IRt/c.2/18AMF (4.5 x 12.8 mm rectangular focal slot)	Focal point at 76 mm from sensor Approximate 13° view angle beyond focal point Target temperature -18 to 1370 °C (0 to 2500 °F)*
Long Focused Adjustable	IRt/c.4ALF (3.5 mm spot dia.) IRt/c.7ALF (7.2 mm spot dia.) IRt/c.2/15ALF (3 x 7.2 mm rectangular focal slot)	Focal point at 105 mm from sensor Approximate 11° view angle beyond focal point Target temperature 150 to 1930 °C (300 to 3500 °F)*
Extra Long Focused Adjustable	IRt/c.2AXLF (1.8 mm spot dia.) IRt/c.4AXLF (4.8 mm spot dia.) IRt/c.10/38AULF (10 x 38 mm rectangular focal slot)	Focal point at 200 mm from sensor (except .10) IRt/c.10/38AULF 250 mm focal point Approximate 5° view angle beyond focal point IRt/c.10/38AULF HI E model only Target temperature -18 to 1930 °C (0 to 3500 °F)*

Adjustable IRt/c™ Model Code

Use the following model code selection guide to configure the appropriate sensor. Pick one selection from each group.

A B C
IRt/c. _____ - _____ - _____

Example: IRt/c.10A-K-LoE

A. IRt/c Model

	<u>FOV</u>	<u>HiE Sensing Range</u>	<u>LoE Sensing Range</u>
10A	10:1	-50 to 2500°F, -45 to 1370°C	500 to 2500°F, 260 to 1370°C
20A	20:1	500 to 3000°F, 260 to 1650°C	1000 to 3500°F, 540 to 1930 °C
100A	100:1	1000 to 5000°F, 540 to 2760°C	1500 to 5000°F, 820 to 2760°C
2ACF	0.11" at 1.7" (43 mm)	500 to 2500°F, 260 to 1370°C	1000 to 2500°F, 540 to 1370°C
2/15ACF	0.11" x 0.35" (2.9 x 8.7 mm) at 1.7" (43 mm)	0 to 2500°F, -18 to 1370°C	500 to 2500°F, 260 to 1370°C
4ACF	0.20" (5 mm) at 1.7" (43 mm)	0 to 2500°F, -18 to 1370°C	600 to 2500°F, 320 to 1370°C
8ACF	0.33" (8.5 mm) at 1.7" (43 mm)	Not available	300 to 2500°F, 150 to 1370°C
2/18AMF	0.18" x 0.5" (4.5 x 12.8 mm) at 3" (76 mm)	0 to 2500°F, -18 to 1370°C	600 to 2500°F, 320 to 1370°C
3AMF	0.15" (3.7 mm) at 3" (76 mm)	500 to 2500°F, 260 to 1370°C	1100 to 2500°F, 590 to 1370°C
6AMF	0.26" (6.5 mm) at 3" (76 mm)	0 to 2500°F, -18 to 1370°C	700 to 2500°F, 370 to 1370°C
12AMF	0.48" (11.1 mm) at 3" (76 mm)	Not available	400 to 2500°F, 200 to 1370°C
2/15ALF	0.12" x 0.28" (3 x 7.2 mm) at 4.1" (105 mm)	700 to 3000°F, 370 to 1650°C	1200 to 3500°F, 650 to 1930°C
4ALF	0.14" (3.5 mm) at 4.1" (105 mm)	700 to 3000°F, 370 to 1650°C	1200 to 3500°F, 650 to 1930°C
7ALF	0.28" (7.2 mm) at 4.1" (105 mm)	300 to 3000°F, 150 to 1650°C	900 to 3500°F, 480 to 1930°C
2AXLF	0.07" (1.8 mm) at 8" (200 mm)	1100 to 3500°F, 590 to 1930°C	2200 to 3500°F, 1200 to 1930°C
4AXLF	0.19" (4.8 mm) at 8" (200 mm)	900 to 3500°F, 480 to 1930°C	1700 to 3500°F, 930 to 1930°C
10/38AULF	0.4" x 1.5" (10 x 38 mm) at 10" (250 mm)	0 to 2500°F, -18 to 1370°C	Not available

B. Thermocouple type

J	J type thermocouple
K	K type thermocouple
R/S	R/S type thermocouple (.100A's and AXLF's)

C. Target surface material

HiE	High emissivity (non metals, coated metal surfaces)
LoE	Low emissivity (metal surfaces)

Optional Custom Factory Calibration of Adjustable IRt/c Sensors

Exergen offers NIST traceable factory calibration of adjustable IRt/c sensors to meet the customers measurement range. This option simplifies multiple same sensor installations for factory automation and OEMs. mV signal output curves and mV tables are available.

Exergen Product Overview

μIRt/c (micro IRt/c, microIRt/c.SV)

The World's Smallest IRt/c

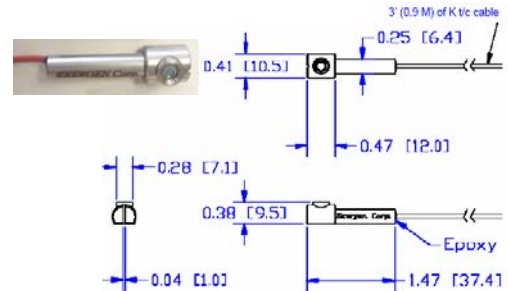
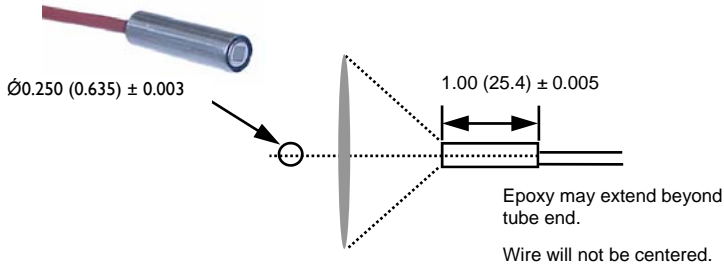

Specifications

Recommended Sensing Ranges	Model	2% Linear Temperature Range
	μIRt/c-K-80F/27C	40-118° F (4-48° C)
	μIRt/c-K-98.6F/37C	77-104° F (25-40° C)
	μIRt/c-K-140F/70C	90-180° F (32-82° C)
	μIRt/c-K-180F/90C	170-220° F (77-104° C)
	μIRt/c-K-240F/120C	220-245° F (104-118° C)
	μIRt/c-K-280F/140C	270-310° F (132-154° C)
	μIRt/c-K-340F/170C	330-370° F (166-188° C)
	μIRt/c-K-440F/220C	415-465° F (213-241° C)
Ambient Temperature Range	-20 °C to 100 °C (internal case temperature)	
Storage Temperature Range	-20 °C to 100 °C	
Field of View of Sensing Element	1:2 (distance: spot) approximately	
Minimum Spot size	3 mm (.1")	
Dominant Spectral Response	5 to 14 μm	
Output Sensor	K type thermocouple	
Impedance	15 – 60 Kohms, varies depending on temperature range	
Emissivity (e)	.90	
Measurement Type	Thermopile	
Resolution	Approximately 0.00018°C, Johnson Noise	
Update Time	Instantaneous	
Response Time	50 millisecond time constant (typical)	
Accuracy (Interchangeability)	1% to factory calibration conditions	
Dimensions	See above	
Housing	Stainless Steel 303	
Cable Assembly	3 feet of unshielded, duplex insulated, type K, 24 AWG, PFA jacket rated to 500 F (260 C) (Shielded cable available upon request)	
Humidity	Non-Condensing	
Power Requirements	None	
Sealed	Hermetically, exceeds NEMA 4,4X, IP67	
Weight	Approximately 30 grams (1 oz.)	

Exergen Product Overview

µIRt/c.4 (micro IRt/c.4, micro IRt/c.4SV)

The World's Smallest 4:1 IRt/c



micro IRt/c.4



micro IRt/c.4SV

Features

- Self powered
- Small size
- Low cost
- Mounting rings
- Air purge available
- 4:1 field of view

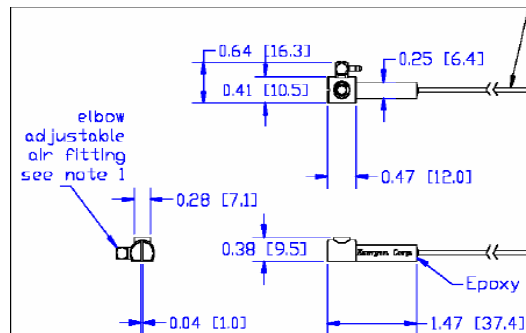
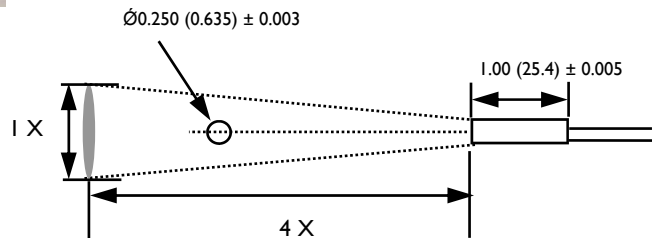

Specifications	
Sensing Range	-45 °C to 524 °C (2% linear to match a K t/c from 212 -240 °C)
Ambient Temperature Range	-20 °C to 100 °C (air purge jacket available for cooling to 175 °C)
Storage Temperature Range	-20 °C to 100 °C
Field of View of Sensing Element	approximately 4:1 (14°)
Minimum Spot size	3 mm (.1")
Dominant Spectral Response	5.5 to 20 µm
Output Sensor	K type thermocouple from 414 - 464 °F (212 - 240 °C), mV output tables available and recommendations for programmable devices.
Impedance	~ 40 kohms
Emissivity (e)	.90
Measurement Type	Thermopile
Resolution	Approximately 0.0003°C, Johnson Noise
Update Time	Instantaneous
Time Constant	50 milliseconds
Accuracy (Interchangeability)	1% to factory calibration conditions
Dimensions	See above
Housing	Stainless Steel 303
Cable Assembly	3 feet (0.9 meters) of unshielded, duplex insulated, type K, 24 AWG, PFA jacket, rated to 500 °F (260 °C) (Shielded cable also available)
Humidity	Non-Condensing
Power Requirements	None
Environmental Ratings	Hermetically sealed, exceeds NEMA 4, 4X, IP67
Weight	~ 30 grams (1 oz.), SV model ~ 60 grams (2 oz.)

Exergen Product Overview

POWERED SMART IRt/c SERIES

- Smart air purge assures maintenance free long term accuracy
- Smart continuous auto calibration
- All digital system
- Smart housing resists mechanical and thermal shocks
- Smart emissivity shift and ambient radiation correction
- Easy plug and play installation
- Lowest cost air purged, linearized sensor on the market
- Optics from 3:1 to 40:1 available
- Outputs of 0-5V, 0-10V, 4-20mA, & RS232



SmartIRt/c.3 (3:1 FOV)
&

3.71" x 1.37" x 0.76" (94.3 x 34.9 x 19.4 mm)



SmartIRt/c.20 (20:1 FOV) & SmartIRt/c.40 (40:1 FOV)

SmartIRt/c.20: 3.71" x 1.37" x 0.76" (94.3 x 34.9 x 19.4 mm)

& 1.63" (41.3 mm) x 0.75" diameter snout

MEASUREMENT SPECIFICATIONS

	Temperature Range	Accuracy	Repeatability	Interchangeability	
SmartIRt/c.3	0-100 °C & 0-250 °C	±1 °C or 1%	± 1 BIT	±1 °C (1.8 °F) or 0.5%	
	0-500 °C	± 1.5 °C or ± 1.5%		± 1.5 °C or ± 1.5%	
SmartIRt/c.5	0-100 °C, 0-250 °C & 0-500° C	± 1.5 °C or ± 1.5%		± 1 °C (1.8 °F) or 0.5%	
	0-1000 °C	± 2.0 °C or ± 1.5%		± 1.5 °C or ± 1.5%	
SmartIRt/c.20	0-100 °C, 0-250 °C, & 0-500 °C	± 1.5 °C or ± 1.5%		0-100 °C = ± 0.1 °C	± 1 °C (1.8 °F) or 0.5%
	0-1000 °C	± 1.5 °C or ± 2.0%		0-250 °C = ± 0.25 °C	± 1.5 °C or ± 1.5%
SmartIRt/c.40	0-100 °C, 0-250 °C, & 0-500 °C	± 1.5 °C or ± 1.5%		0-500 °C = ± 0.5 °C	± 1 °C (1.8 °F) or 0.5%
	0-1000 °C	± 2.0 °C or ± 2.5%		0-1000 °C = ± 1 °C	± 1.5 °C or ± 1.5%

OUTLINE DRAWING

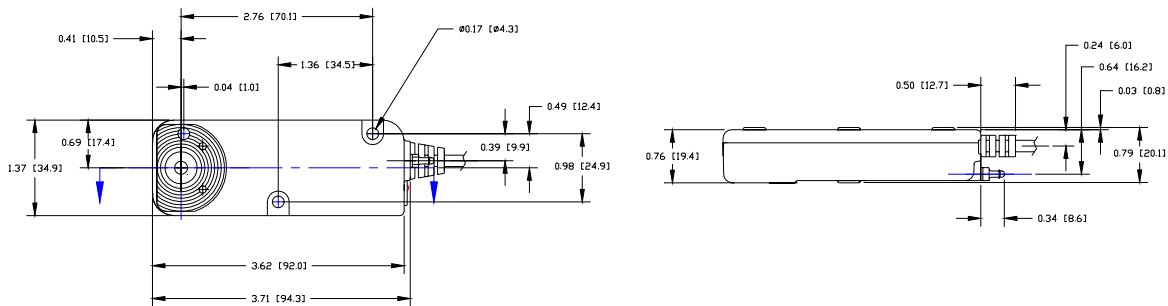

Exergen Product Overview

POWERED SMART IRt/c SERIES

ELECTRICAL SPECIFICATIONS

	SmartIRt/c.3	SmartIRt/c.5	SmartIRt/c.20	SmartIRt/c.40
LINEAR TEMPERATURE RANGES <small>(custom scaling also available upon request)</small>	0-100 °C (32-212 °F) 0-250 °C (32- 482 °F) 0-500 °C (32- 932 °F)	0-100 °C (32-212 °F), 0-250 °C (32- 482 °F), 0-500 °C (32- 932 °F), 0-1000 °C (32 - 1832 °F)		
OUTPUT	0-5V, 0-10V (24VDC power only), 4-20mA (50 ohm max), RS232 (12VDC power only)			
UPDATE TIME	Approximately 250 msec.			
FIRST READING UPON POWER UP	Approximately 2 seconds			
EMISSIVITY SETTING	0.90 (custom low emissivity settings available for metals, etc. upon request)			
SPECTRAL RESPONSE	5.5 to 20 microns (other ranges available for specific applications, thin films, etc.)			
POWER	12 or 24 VDC (10%). Shuts off when voltage is functionally low.			
OUTPUT IMPEDANCE	750 ohms on 0-5V and 0-10V models			
MINIMUM LOAD IMPEDANCE	100 K ohms			

MECHANICAL SPECIFICATIONS

	SmartIRt/c.3	SmartIRt/c.5	SmartIRt/c.20	SmartIRt/c.40
Minimum Spot Size	0.12" (3.0 mm)	0.12" (3.0 mm)	0.625" (15.9 mm)	0.625" (15.9 mm)
Ambient Temperature Range	0 to 70 °C (32 to 158 °F)			
Storage Temperature	-10 to 70 °C (14 to 158 °F)			
Construction	Heavy Duty Alloy Casting			
Weight	Approximately 8 oz. (227 g)			
Relative Humidity	95% non condensing			
Air Purge	Integral built in air purge with small sized aperture and heat exchanged which minimizes drift for superb accuracy			
Cable	3 ft (0.9 m) of 5 conductor, tinned copper, twisted pair, polypropylene, insulated with shielded wire			
Ratings	NEMA , IP54 (with air on)			

ORDERING INFORMATION

SmartIRt/c-F-P-O-T

F	FIELD OF VIEW	P	POWER	O	OUTPUT	T	TEMPERATURE RANGE
.3	3:1	12V	12 VDC	05	0-5V	100C	0-100C
.5	5:1	24V	24 VDC	010	0-10V	250C	0-250C
.20	20:1			420	4-20 mA	500C	0-500C
.40	40:1			232	RS232	1000C	0-1000C

Example: SmartIRt/c.20-24V-420-500C

Add—Ta for ambient temperature output option.

Smart-microIRt/c's



Smart-microIRt/c

FEATURES

- Non-Contact Temperature Measurement, that's Plug and Play
- No Impedance, leakage current, or linearity problems to worry about
- Sensor head is remote and without air purge can be used in ambient temperatures to 100 °C (212 °F) and with small sized air purge jacket can be cooled to 350 °F (177 °C)
- The sensor heads are the smallest sized in the market (0.25" diameter)

4 sensor heads to choose from



micro IRt/c.SV



micro IRt/c.4SV



micro IRt/c.4



micro IRt/c

SPECIFICATIONS	Smart-microIRt/c	Smart-microIRt/c.SV	Smart-microIRt/c.4	Smart-microIRt/c.4SV
Sensing Ranges:	-30-70 °C, 0-100 °C, 0-250 °C, 0-500 °C (only 4:1's) (-22-158 °F, 32-212 °F, 32-482 °F, 32-932 °F)			
Output:	0-10V, 0-5V, 4-20mA, RS232			
Ambient Range:	Sensing Head: -40—212 °F (-40—100 °C) Transmitter: 0—70 °C (32—158 °F)			-40—240 °F (-40—120 °C) With built in air purge
Field of View:	1:2 (3 mm, 0.1" min spot)		4:1 (3 mm, 0.1" min spot)	
Power Supply	12 or 24 VDC (±10%), Shuts off when voltage is functionally low.			
Update Time:	< 250 milliseconds; Time constant = 40 milliseconds			
Accuracy: (Includes repeatability & interchangeability)	2% of full scale		3% of full scale	
Environmental:	Sensor Head: IP67, NEMA 4X, 1000 grams of shock, Non condensing humidity,			
Storage Temperature:	14 °F-158 °F (-10-70 °C)			
Relative Humidity:	Non-condensing			
Allowed Load Impedance	(voltage models) 750 Ω			
Output Impedance	(4-20mA models) 50 Ω			
Cable Assembly:	10 feet (3 meters) from sensor to transmitter and 10 feet (3 meters) from transmitter, 24 AWG stranded			

Exergen Product Overview

Handheld Infrared Thermometers Microscanner D Series and DX Precision Thermometers

Where Used

- Primary calibration of other temperature devices
- Spot product inspections
- Machine wear monitoring

Features

- Dual purpose temperature calibrator and thermal scanning systems
- NIST traceable
- Design eliminates target emissivity, radiation errors, contact, friction heating, and heat sinking errors
- Fast response time < 80 mSec
- Remote sensor available for hard to reach target areas
- Wide measurement ranges
- Factory calibrated

Features by Model

D Series Microscanner



- Three measurement modes SCAN, MIN, MAX
- Full range resolution to 0.1 °C/°F
- 1 to 1 FOV
- Relative humidity measurement
- Analog output option

DX Precision Thermometer



- Two measurement modes SCAN, MAX
- Full range resolution to 0.1 °C/°F
- 1 to 1 FOV
- Ergodynamic design
- Low cost
- RS232 output option

Temperature Ranges by Model	
Model Selection	Measurement Ranges
D501, D501-RS, DX501, DX501-RS	-45 to 287 °C (-50 to 550 °F)
D1001, D1001-RS, DX1001, DX1001-RS	-18 to 538 °C (0 to 1000 °F)
D1201, DX1201 (includes remote sensor)	86 to 653 °C (186 to 1207 °F)
D1601, DX1601 (includes remote sensor)	86 to 871 °C (186 to 1600 °F)

Exergen Product Overview

MicroScanner E for Electrical Inspection

Where Used

- Electrical Inspection
- Safety inspection of transformers and junctions

Features

- Factory calibrated
- Fast response time < 60 sec
- Scanning display for thermal patterns
- Optional laser sight available
- Choice of field of view



MicroScanner E for Electrical Inspection

Features	MicroScanner Super E	MicroScanner
Field of View	200 : 1	50 : 1
Max. distance for 1" (2.5 cm spot)	17 ft (5 m)	4 ft (1.3 m)
Scan Readings/sec	20	10
Time to Scan 1 x 4 ft panel @ distance	< 30 secs @ 17 ft	< 60 secs @ 4 ft
Resolution	0.1 °C	1 °C
Automatic Ambient	Yes	Yes
Scanning Display/Thermal Patterns	Yes	Yes
Color-coded Scale	Yes	Yes
Locking Display	Yes	No
Peak Hold Display	Yes	No
Audible Heat Seeker	Yes	No
Waterproof Case	Yes	No
Optional Laser Sight	Yes	No

Exergen Product Overview

SnakeEye™ Non-contact Sensors for Infrared Thermal Switching

Where Used

- Case sealing
- Packaging
- Pharmaceutical and general bottling
- Discrete part monitoring

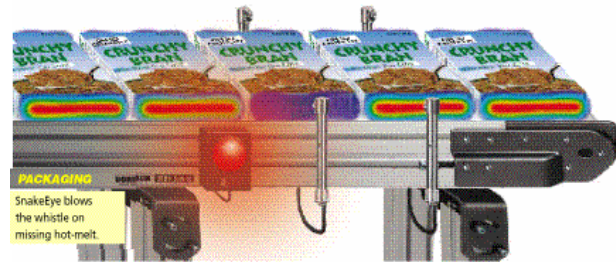

Features

- Two on/off solid state switches
- Photocell simplicity
- Adjustable sensitivity
- Rugged design meets NEMA ratings
- Measure at speeds up to 1000 ft. /minute
- Can sense through closed flap

SnakeEye Thermal Switches

Features	SnakeEye™
Sensing Range	0.01" (0.25 mm) hot melt adhesive bead (minimum) or 2 °C (4 °F) temperature differential
Sensing Speed	5 ms response, 1000 ft/min (500 m/min) max line speed 1 ft/min (0.3 m/min) min. line speed , based on model
Field of View	3 to 1 (approximately 20°)
Signal Output	Two solid state switches, N/O, triggering from hot leading edge (H), cold trailing edge (C) independently
Output Cable	4 wire: +V, GND, SWH, SWC; 10 ft (3 m) length
Sensor Dimensions	4.5" x 0.5" diameter (114 x 12.7 mm)
Weight	5 oz (140 g) with cable
Housing	Stainless steel, built in air purge, hermetically sealed, meets or exceeds NEMA 4, 4X, and IP67.
Models	Straight View Low Speed SnakeEye.3-LTE-LS Straight View High Speed SnakeEye.3-LTE-HS Side View Low Speed SnakeEye.3SV-LTE-LS Side View High Speed SnakeEye.3SV-LTE-HS

Exergen Manufactured Accessories

Product	Model Number	Feature
In-Line Transmitters	IRt/c.XMTR	4 to 20 mA Precalibrated for temperature range and t/c type Meets NEMA 4X and IP67
Cooling Jackets	CJK-1 CJK-2 CJK2-SV APJ-1	Used for IRt/c, IRt/c.3X, IRt/c.1x Either water or air cooling source Enables measurements in harsh environments Efficient design for low air/water usage Used for IRt/c.3X for air cooling only Side view mounted air cooling for IRt/c.SV and 3SV Air purge jacket for micro IRt/c
Mounting Brackets	MB-1 MB-2 MB-3 MB-4 MB-5	Conveniently mounts IRt/c sensor at or within process Metal bracket for durability
Air pumps for purge	APK-1 APK-2	Use to keep sensors clean Convenient source if plant air not available Standoff mounts for vertical or horizontal mounting Works with sensors that have built in air purge connectors Available in 120VAC (APK-1) or 12VDC (APK-2)
Wiring supplies	Connector Kit T/C Cable	For installation or cable extension Protects against electrical noise High grade components
Carrying pouches	Black pouch w/strap	Carrying pouches for D and DX Series

Accessories available from other suppliers:

Sight windows (Barium Fluoride) - ISP Optics
Calibrators—TME, Omega Engineering

For specifications, drawings, and data sheets on accessories, please visit:

www.exergen.com/industrl/irtc/accessrs/index.htm

CONTACT YOUR LOCAL DISTRIBUTOR FOR OTHER ACCESSORIES NOT MANUFACTURED BY EXERGEN, CONTACT US FOR A LIST OF DISTRIBUTORS OR VISIT

www.exergen.com/industrl/distrib/

Applications

Some markets that our IRT/c's are already utilized in. Look for our Tech Notes on www.exergen.com.

Market	Application	Measurement
Agriculture	Plant residue control, Plant automated watering system	Plant surface temperature
Automotive/ Aerospace	Product quality, Racing performance, climate control	Tire vulcanizing process control, paint curing/monitoring, tire and suspension temperature, and car interior temperature systems
Chemical	Hazardous material monitoring & Process control	Flame detection, distilling and cracking process control, and liquid level verification
Construction	Asphalt production Asphalt delivery and application	Mixing process monitoring & product delivery temperature
Electric Power	Safety inspection and part maintenance	Flame detection, Switchgear monitoring, Transformer inspection, and Busbar monitoring
Electronics	Part inspection and process control	Circuit board preheat control and discrete parts monitoring
Food	Process control and food quality	Food mixing operation monitoring, freezing operation, packaging operation, food preparation and cooking systems, and storage area inspection
Glass	Process control	Oven temperature control, glass melt production and discrete part monitoring
Heating	Oven manufacturing, product quality, and process system start-up	Oven temperature monitoring and process system control
Machining	Machine tolerance control, soldering quality, tool deterioration, wafer polishing, chip bonding and coating quality	Part temperature monitoring, preheat control, tool temperature monitoring, discrete parts monitoring, and paint system control
Medical	IV warming, blood analysis, cardiopulmonary bypass system, dialysis, ECMO systems and transfusion	System temperature monitoring and sample preparation processing
Metal	Molten process control and Paint curing	Furnace monitoring, dryer control, flame detection, and discrete part monitoring
Packaging	Lamination quality, sealing process control, graphics application, raw material processing, product temperature, and web control	Hot melt detection, liquid, foam, seal level verification, lamination system control, discrete parts monitoring, printing press operation, part inspection, dry out point control, and date code verification
Plastics	Thermoforming quality, extrusion control, raw material processing, and product curing	Mold temperature monitoring, liquid level verification, oven system control and cure rate monitoring
Printing	Ink viscosity, web drying, roller temperature, sheet temperature, printing quality	Ink application system monitoring, dry out point control, pre-press system set-up, and toner fusing
Refrigeration	Ice quality and food quality	Refrigeration system control, ink rink monitoring, and food inspection
Semiconductor	Product quality and process control	Controlling machining tolerances, silicon wafer inspection and polish process control

Technical Experts at Your Service

Call 617-923-9900 from 8 AM—5 PM EST for applications and technical support, or email industrial@exergen.com, you will have a response within 24 hours.

EXERGEN
C O R P O R A T I O N

400 Pleasant Street

Watertown, MA U.S.A. 02472

617-923-9900, (F) 617-923-9911

www.exergen.com/industry

2006



pn/ 818164 r8