

# **EUCHNER**

## **Operating Instructions**

**Transponder-Coded Safety Switch With Guard Locking  
CET.-AS-... (Unicode/Multicode)**

**EN**

## Contents

<b>1.</b>	<b>About this document</b> .....	<b>4</b>
1.1.	Scope.....	4
1.2.	Target group .....	4
1.3.	Key to symbols.....	4
1.4.	Supplementary documents .....	4
<b>2.</b>	<b>Correct use</b> .....	<b>5</b>
<b>3.</b>	<b>Description of the safety function</b> .....	<b>6</b>
<b>4.</b>	<b>Exclusion of liability and warranty</b> .....	<b>6</b>
<b>5.</b>	<b>General safety precautions</b> .....	<b>7</b>
<b>6.</b>	<b>Function</b> .....	<b>8</b>
6.1.	Guard locking on version CET3-AS .....	9
6.2.	Guard locking on version CET4-AS .....	9
6.3.	Switching states .....	10
<b>7.</b>	<b>Manual release</b> .....	<b>11</b>
7.1.	Auxiliary release and auxiliary key release (can be retrofitted) .....	11
7.1.1.	Actuating auxiliary release .....	11
7.1.2.	Actuating auxiliary key release .....	11
7.2.	Emergency release (can be retrofitted) .....	12
7.2.1.	Actuating emergency release .....	12
7.3.	Escape release (optional) .....	12
7.3.1.	Actuating escape release.....	12
7.4.	Wire front release (optional) .....	13
7.4.1.	Laying wire front release.....	13
<b>8.</b>	<b>Changing the approach direction</b> .....	<b>13</b>
<b>9.</b>	<b>Mounting</b> .....	<b>14</b>
<b>10.</b>	<b>Electrical connection</b> .....	<b>16</b>
10.1.	Notes about  .....	16
10.2.	Setting the AS-Interface address .....	16
10.3.	Configuration in the AS-Interface safety monitor .....	16
10.3.1.	Dual-channel conditionally dependent.....	16
10.3.2.	Dual-channel independent .....	17
10.4.	AS-Interface status messages.....	17
10.5.	Safety in case of faults.....	17
10.6.	Connection of guard locking control .....	17
10.6.1.	Guard locking control via ASi bit D0.....	17

<b>11.</b>	<b>Setup .....</b>	<b>18</b>
11.1.	LED displays .....	18
11.2.	Teach-in function for actuator (only for unicode evaluation) .....	18
11.2.1.	Actuator teach-in.....	19
11.3.	Functional check.....	19
11.3.1.	Mechanical function test.....	19
11.3.2.	Electrical function test.....	19
<b>12.</b>	<b>System status table .....</b>	<b>20</b>
<b>13.</b>	<b>Technical data .....</b>	<b>21</b>
13.1.	Technical data for safety switch CET.-AS-.....	21
13.1.1.	Typical system times.....	22
13.2.	Dimension drawing for safety switch CET.-AS-.....	22
13.3.	Technical data for actuator CET-A-B... ..	23
13.3.1.	Dimension drawing for actuator CET-A-BWK-50X.....	23
<b>14.</b>	<b>Ordering information and accessories .....</b>	<b>24</b>
<b>15.</b>	<b>Inspection and service .....</b>	<b>24</b>
<b>16.</b>	<b>Service .....</b>	<b>24</b>
<b>17.</b>	<b>Declaration of conformity .....</b>	<b>25</b>

## 1. About this document





### 1.1. Scope

These operating instructions, the document *Safety information* and any enclosed data sheet form the complete user information for your device.

### 1.2. Target group



Design engineers and installation planners for safety devices on machines, as well as setup and servicing staff possessing special expertise in handling safety components.

### 1.3. Key to symbols

Symbol/depiction	Meaning
	Printed document
	Document is available for download at <a href="http://www.euchner.com">www.euchner.com</a>
 <b>DANGER</b> <b>WARNING</b> <b>CAUTION</b>	Safety precautions <b>Danger</b> of death or severe injuries <b>Warning</b> about possible injuries <b>Caution</b> Device damage possible
 <b>NOTICE</b> <b>Important!</b>	Important information
<b>Tip</b>	Useful information

### 1.4. Supplementary documents

The overall documentation for this device consists of the following documents:

Document title (document number)	Contents	
Safety information (2525460)	Basic safety information	
Operating instructions (2113689)	(this document)	
Possibly enclosed data sheet	Item-specific information about deviations or additions	

	<b>Important!</b> Always read all documents to gain a complete overview of safe installation, setup and use of the device. The documents can be downloaded from <a href="http://www.euchner.com">www.euchner.com</a> . For this purpose enter the doc. no. in the search box.
---	--

### 2. Correct use

Safety switches series CET-AS are operated as slaves on the safety bus AS-Interface Safety at Work and function as interlocking devices with guard locking solenoid (type 4). The device complies with the requirements according to EN IEC 60947-5-3. Devices with unicode evaluation possess a high coding level, devices with multicode evaluation possess a low coding level.

In combination with a movable guard and the machine control, this safety component prevents the guard from being opened while a dangerous machine function is being performed.

This means:

- Starting commands that cause a dangerous machine function must become active only when the guard is closed and locked.
- The guard locking must not be released until the dangerous machine function has ended.
- Closing and locking a guard must not cause automatic starting of a dangerous machine function. A separate start command must be issued. For exceptions, refer to EN ISO 12100 or relevant C-standards.

Devices from this series are also suitable for process protection.

Before the device is used, a risk assessment must be performed on the machine, e.g. in accordance with the following standards:

- EN ISO 13849-1
- EN ISO 12100
- IEC 62061

Correct use includes observing the relevant requirements for installation and operation, particularly based on the following standards:

- EN ISO 13849-1
- EN ISO 14119
- EN 60204-1

The safety switch is allowed to be operated only in conjunction with the intended EUCHNER actuator and the related connection components from EUCHNER. On the use of different actuators or other connection components, EUCHNER provides no warranty for safe function.



#### Important!

- The user is responsible for the proper integration of the device into a safe overall system. For this purpose, the overall system must be validated, e.g. in accordance with EN ISO 13849-2.
- It is only allowed to use components that are permissible in accordance with the table below.

Table 1: Possible combinations for CET components

Safety switch	Actuator	
	CET-A-B...	
CET.-AS-... (Unicode/Multicode)	●	
<b>Key to symbols</b>	●	Combination possible

### 3. Description of the safety function

Devices from this series feature the following safety functions:

#### Monitoring of guard locking and the position of the guard (interlocking device with guard locking according to EN ISO 14119)

- Safety function (see chapter 6.3. *Switching states on page 10*):
  - When guard locking is released, no valid code sequence is sent (monitoring of the locking device).
  - When the guard is open, no valid code sequence is sent (monitoring of the door position).
  - Guard locking can be activated only when the actuator is located in the switch head (prevention of inadvertent locking position (faulty closure protection)).
- Safety characteristics: category, Performance Level, PFH<sub>d</sub> (see chapter 13. *Technical data on page 21*).

#### Control of guard locking

If the device is used as guard locking for personnel protection, the control of the guard locking must be regarded as a safety function.

Guard locking is controlled on the output side via ASi bit D0 from the control system. The auxiliary power must not be switched off for the CET, because the CET's monitoring circuit is powered by the auxiliary power.

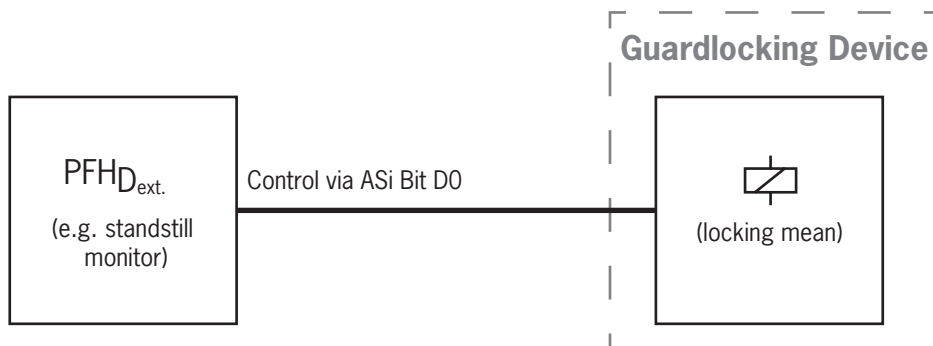

### 4. Exclusion of liability and warranty

In case of failure to comply with the conditions for correct use stated above, or if the safety regulations are not followed, or if any servicing is not performed as required, liability will be excluded and the warranty void.

### 5. General safety precautions

Safety switches fulfill personnel protection functions. Incorrect installation or tampering can lead to fatal injuries to personnel.

Check the safe function of the safeguard particularly

- › after any setup work
- › after the replacement of a CET component
- › after an extended period without use
- › after every fault

Independent of these checks, the safe function of the safeguard should be checked at suitable intervals as part of the maintenance schedule.



#### **WARNING**

Danger to life due to improper installation or due to bypassing (tampering). Safety components fulfill a personnel protection function.

- › Safety components must not be bypassed, turned away, removed or otherwise rendered ineffective. On this topic pay attention in particular to the measures for reducing the possibility of bypassing according to EN ISO 14119:2013, section 7.
- › The switching operation must be triggered only by actuators designated for this purpose.
- › Prevent bypassing by means of replacement actuators (only for multicode evaluation). For this purpose, restrict access to actuators and to keys for releases, for example.
- › Mounting, electrical connection and setup only by authorized personnel possessing the following knowledge:
  - specialist knowledge in handling safety components
  - Knowledge about the applicable EMC regulations
  - Knowledge about the applicable regulations on operational safety and accident prevention



#### **Important!**

Prior to use, read the operating instructions and keep these in a safe place. Ensure the operating instructions are always available during mounting, setup and servicing. For this reason you should archive a printed copy of the operating instructions. You can download the operating instructions from [www.euchner.com](http://www.euchner.com).

## 6. Function

The device permits the locking of movable guards.

The system consists of the following components: coded actuator (transponder) and switch.

Whether the device learns the complete actuator code (unicode) or not (multicode) depends on the respective version.

- › **Devices with unicode evaluation:** The actuator must be assigned to the safety switch by a teach-in operation so that it is detected by the system. This unambiguous assignment ensures a particularly high level of protection against tampering. The system thus possesses a high coding level.
- › **Devices with multicode evaluation:** Unlike systems with unique code detection, on multicode devices a specific code is not requested but instead it is only checked whether the actuator is of a type that can be detected by the system (multicode detection). There is no exact comparison of the actuator code with the taught-in code in the safety switch (unique code detection). The system possesses a low coding level.

When the guard is closed, the actuator is moved towards the safety switch. When the operating distance is reached, power is supplied to the actuator by the switch and data are transferred.

If the guard is closed, guard locking is effective and the code is permissible, each CET-AS transmits a switch-specific, unique safety code sequence with 8 x 4 bits via the AS-Interface bus.

The zero sequence is transmitted via the AS-Interface bus when the guard is opened.

In the event of a fault in the safety switch, the zero sequence is transmitted via the AS-Interface bus and the STATE LED illuminates red. The occurrence of faults is detected at the latest on the next demand to close the safety outputs (e.g. on starting).

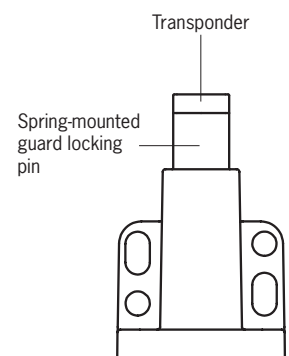
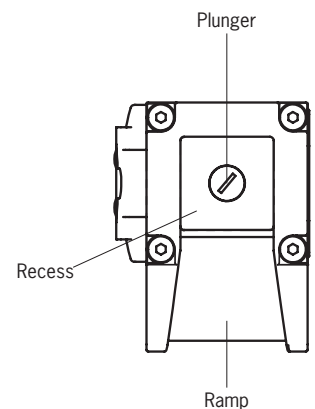
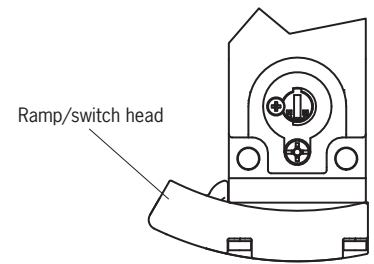



### 6.1. Guard locking on version CET3-AS

(guard locking actuated by spring force and released by power-ON)



#### Important!

The auxiliary power must not be switched off for the CET, because the CET's monitoring circuit is powered by the auxiliary power.

**Activating guard locking:** close guard, clear AS-Interface output bit D0.

**Releasing guard locking:** set AS-Interface output bit D0.

The spring-operated guard locking functions in accordance with the closed-circuit current principle.

The actuator's guard locking pin cannot be moved out of the recess and the guard is locked as long as the plunger is pressed down by the actuator.

If the solenoid is controlled via the ASi bus, the guard locking pin is retracted and the actuator is released. The guard can be opened.

### 6.2. Guard locking on version CET4-AS

(guard locking actuated by power-ON and released by spring force)



#### Important!

- › The auxiliary power must not be switched off for the CET, because the CET's monitoring circuit is powered by the auxiliary power.
- › Use as guard locking for personnel protection is possible only in special cases, after strict assessment of the accident risk (see EN ISO 14119:2013, section 5.7.1)!

**Activating guard locking:** set AS-Interface output bit D0.

**Releasing guard locking:** clear AS-Interface output bit D0.



The magnetically actuated guard locking operates in accordance with the open-circuit current principle. If the solenoid is not controlled (D0=0), guard locking is released and the guard can be opened directly!

If the solenoid is controlled via the ASi bus (D0=1), the plunger is released. The actuator's guard locking pin can now press the plunger down. The guard is locked as soon as the guard locking pin is fully inserted into the recess.

### 6.3. Switching states

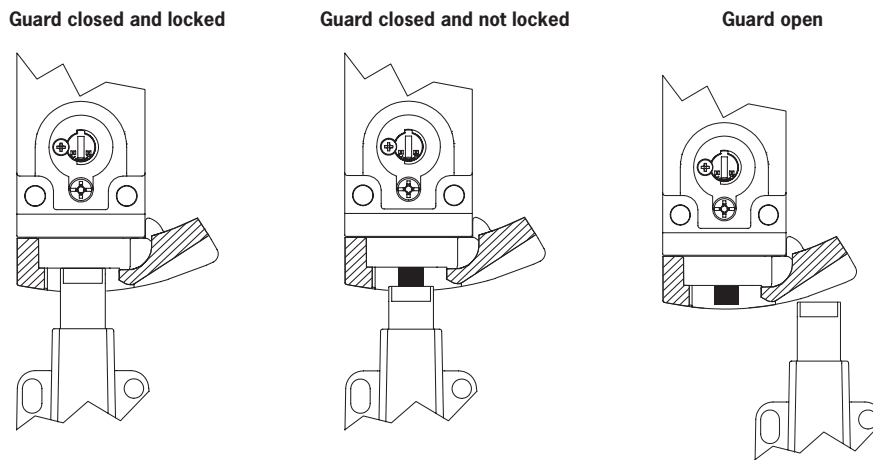
The detailed switching states for your switch can be found in the system status table. All safety outputs, monitoring outputs and display LEDs are described there.



Programming	State	D0, D1	D2, D3	Monitor diagnostics
<b>Dual-channel conditionally dependent</b>	Guard closed and locked 	Code sequence		Green
	Guard closed and not locked	Half-sequence	00	Yellow flashing
	Invalid state (guard open, guard locking active)	00	Half-sequence	Red flashing (monitoring of the invalid state)
	Guard open	00	00	Red
	Address 0 or communication disrupted	-		Gray
<b>Dual-channel independent</b>	Guard closed and locked 	Code sequence		Green
	Guard closed and not locked	Half-sequence	00	Red
	Invalid state (guard open, guard locking active)	00	Half-sequence	Red
	Guard open	00	00	Red
	Address 0 or communication disrupted	-		Gray

### 7. Manual release

Some situations require the guard locking to be released manually (e.g. malfunctions or an emergency). A function test should be performed after release.

More information on this topic can be found in the standard EN ISO 14119:2013, section 5.7.5.1. The device can feature the following release functions:

#### 7.1. Auxiliary release and auxiliary key release (can be retrofitted)

In the event of malfunctions, the guard locking can be released with the auxiliary release or the auxiliary key release irrespective of the state of the solenoid.

The zero sequence is sent via the ASi bus when the auxiliary release or auxiliary key release is actuated.

Open the guard and close it again after resetting the auxiliary release or auxiliary key release. The device will then operate normally again.



#### Important!

- › The actuator must not be under tensile stress during manual release.
- › After use, reset the auxiliary release and screw in and seal the locking screw (e.g. with sealing lacquer).
- › The auxiliary key release must not be used to lock the switch during servicing to prevent activation of guard locking, for example.
- › Loss of the release function due to mounting errors or damage during mounting.
- › Check the release function every time after mounting.
- › Please observe the notes on any enclosed data sheets.

#### 7.1.1. Actuating auxiliary release

1. Unscrew locking screw.
  2. Using a screwdriver, turn the auxiliary release to  in the direction of the arrow.
- ➔ Guard locking is released.

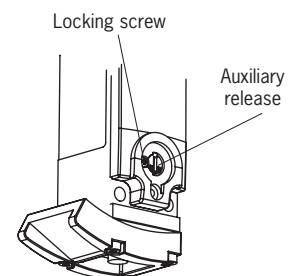

#### 7.1.2. Actuating auxiliary key release

On devices with auxiliary key release (can be retrofitted), simply turn the key to release. Function as for auxiliary release. For mounting, see the auxiliary key release supplement.

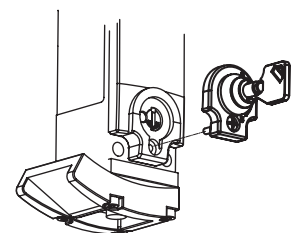

## 7.2. Emergency release (can be retrofitted)

Permits opening of a locked guard from outside the danger zone without tools. For mounting, see the mounting supplement.



### Important!

- › It must be possible to operate the emergency release manually from outside the protected area without tools.
- › The emergency release must possess a marking indicating that it may be used only in an emergency.
- › The actuator must not be under tensile stress during manual release.
- › The emergency release must be sealed or the misuse of the release function must be prevented in the control system.
- › The release function meets all other requirements from EN ISO 14119.
- › The emergency release meets the requirements of Category B according to EN ISO 13849-1:2008.
- › Loss of the release function due to mounting errors or damage during mounting.
- › Check the release function every time after mounting.
- › Please observe the notes on any enclosed data sheets.

### 7.2.1. Actuating emergency release

Turn emergency release clockwise until it clicks into place.

➔ Guard locking is released.

To reset, press the snap-in bolt inward using a small screwdriver or similar tool and turn the emergency release back.

The zero sequence is sent via the ASi bus when the emergency release is actuated.

Open the guard and close it again after resetting the emergency release. The device will then operate normally again.

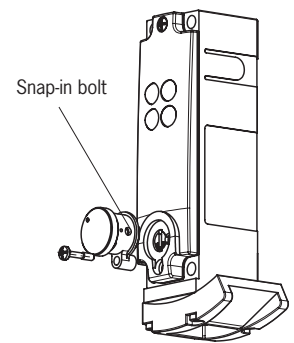

## 7.3. Escape release (optional)

Permits opening of a locked guard from the danger zone without tools (see chapter 13.2. Dimension drawing for safety switch CET.-AS-... on page 22).



### Important!

- › It must be possible to actuate the escape release manually from inside the protected area without tools.
- › It must not be possible to reach the escape release from the outside.
- › The actuator must not be under tensile stress during manual release.
- › The escape release meets the requirements of Category B according to EN ISO 13849-1:2008.

### 7.3.1. Actuating escape release

Press the red release knob to the stop.

➔ Guard locking is released.

Pull the knob out again to reset.

The half-sequence/zero sequence is sent via the ASi bus when the escape release is actuated.

Open the guard and close it again after resetting the escape release. The device will then operate normally again.

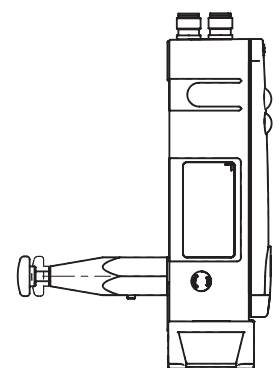

### 7.4. Wire front release (optional)

Release via a pull wire. Depending on the type of attachment, the wire front release can be used as an emergency release or escape release.

The following applies to non-latching wire front releases:

If the release is to be used as an emergency release, one of the following measures must be taken (see EN ISO 14119:2013, section 5.7.5.3):

- › Install the release so that it can be reset only with the aid of a tool.
- › Alternatively, resetting can be implemented at the control-system level, e.g. by means of a plausibility check (status of the transmitted code sequence/zero sequence does not match the guard locking control signal).

The emergency-release specifications in chapter 7.2 on Page 12 apply irrespective of this information.

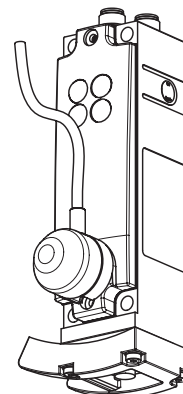

#### Important!

- › The wire front release meets the requirements of Category B according to EN ISO 13849-1:2008.
- › The correct function depends on the laying of the pull wire and the attachment of the pull handle, and this is the responsibility of the plant manufacturer.
- › The actuator must not be under tensile stress during manual release.

#### 7.4.1. Laying wire front release



#### Important!

- › Loss of the release function due to mounting errors, damage or wear.
- › Check the release function every time after mounting.
- › When routing the wire front release, ensure that it operates smoothly.
- › Observe the min. bending radius (100 mm) and minimize the number of bends.
- › The switch is not allowed to be opened.
- › Observe the notes on the enclosed data sheets.

## 8. Changing the approach direction

1. Remove the screws from the safety switch.
2. Set the required direction.
3. Tighten the screws with a torque of 1.5 Nm.

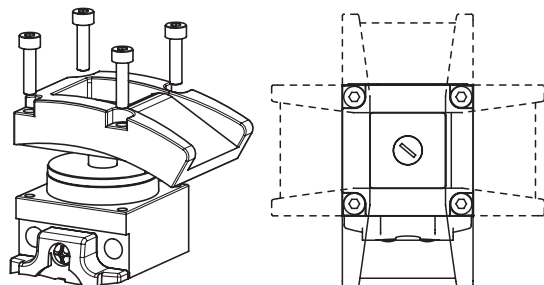

Figure 1: Changing the approach direction

## 9. Mounting



### CAUTION

Safety switches must not be bypassed (bridging of contacts), turned away, removed or otherwise rendered ineffective.

- › Observe EN ISO 14119:2013, section 7, for information about reducing the possibilities for bypassing an interlocking device.



### NOTICE

Risk of damage to equipment and malfunctions as a result of incorrect installation.

- › Safety switches and actuators must not be used as an end stop.
- › Observe EN ISO 14119:2013, sections 5.2 and 5.3, for information about mounting the safety switch and the actuator.
- › Protect the switch head against damage, as well as penetrating foreign objects such as swarf, sand and blasting shot, etc. The switch should be installed with the actuating head down for this purpose.
- › Observe the min. door radii (see Figure 2).
- › Ensure that the actuator contacts the ramp in the designated area (see figure below). Marks on the ramp specify the prescribed approach zone.

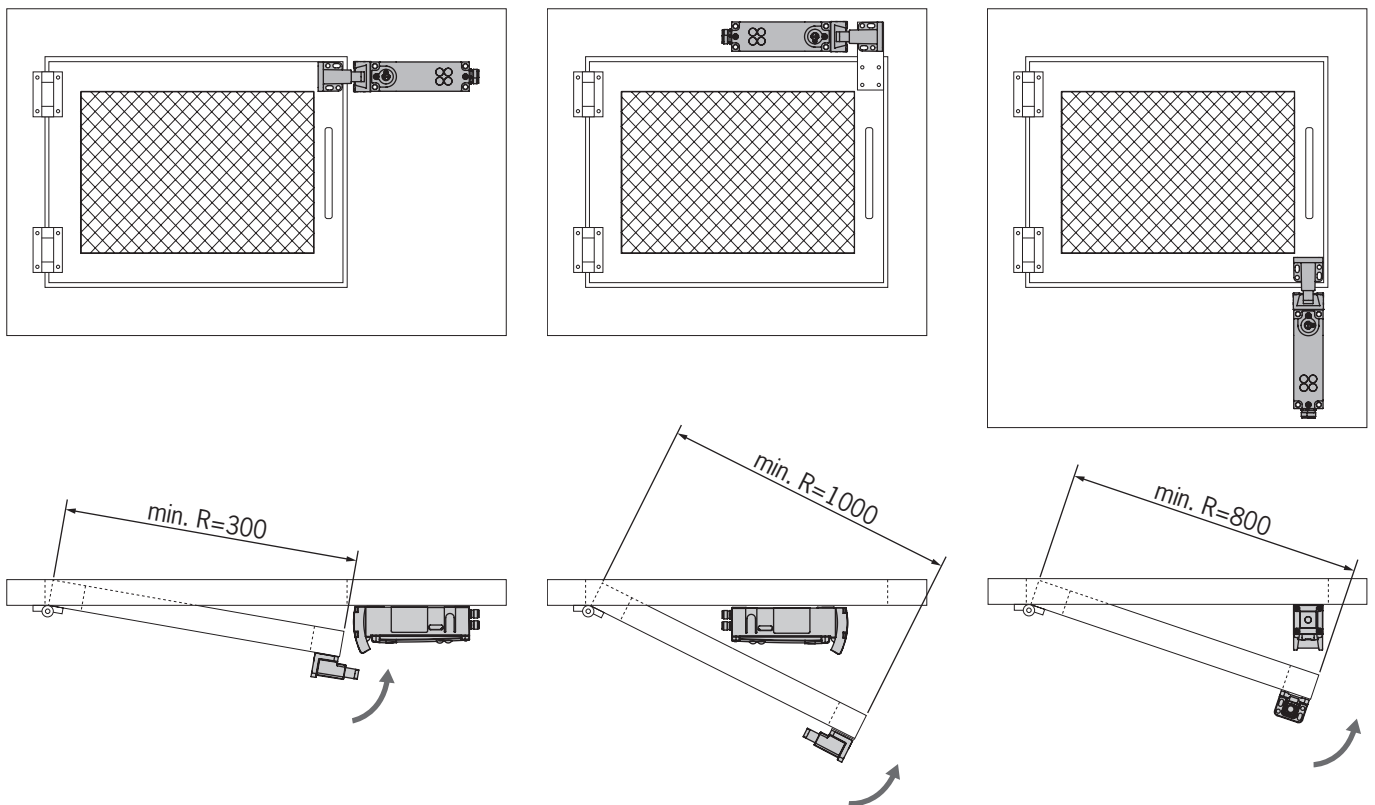
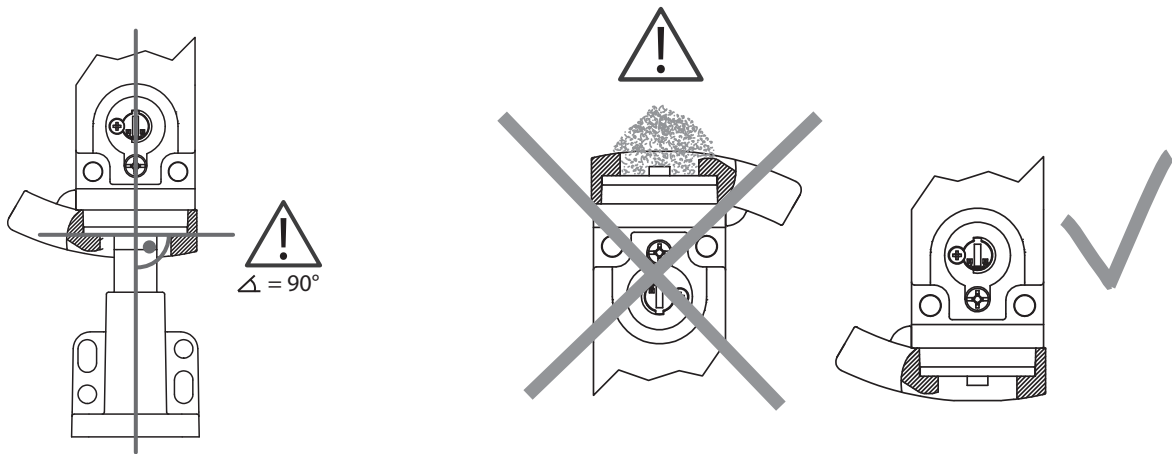

Figure 2: Installation situation and door radii

### Note the following points:

Actuator and safety switch must be fitted so that

- › the active faces of the actuator and the safety switch are parallel with each other.
- › the actuator is fully inserted into the switch recess when the guard is closed.
- › no dirt can accumulate in the recess.



### Tip!

EUCHNER offers special cover plates to improve protection against tampering. These accessories can be found at [www.euchner.com](http://www.euchner.com).

## 10. Electrical connection

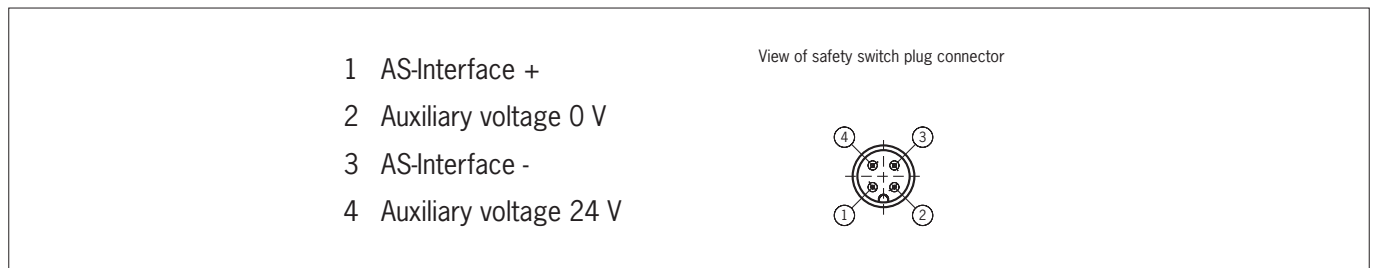

Figure 3: Terminal assignment, AS-Interface M12 plug connector



**Important!**

The auxiliary power must not be switched off for the CET, because the CET's monitoring circuit is powered by the auxiliary power.

### 10.1. Notes about



**Important!**

This device shall be used with a suitable isolating source in conjunction with a fuse in accordance with UL248. The fuse shall be rated max. 3.3 A and be installed in the max. 30 V DC power supply to the device in order to limit the available current to comply with the UL requirements. Please note possibly lower connection ratings for your device (refer to the technical data).

### 10.2. Setting the AS-Interface address

The address can be set prior to or after mounting.

The AS-Interface address of the safety switch is set using an AS-Interface programming device. Addresses 1 to 31 are valid.

The unit is programmed by connecting the programming device to the M12 plug connector of the safety switch with a programming cable.

Address 0 is the default setting on delivery (the AS-Interface LED flashes alternately red/yellow).

### 10.3. Configuration in the AS-Interface safety monitor

(see operating instructions for the AS-Interface safety monitor)

#### 10.3.1. Dual-channel conditionally dependent

**Cat.  
4**

The safety switch is configured in the AS-Interface safety monitor with the AS-Interface address set as follows, for example:

- Dual-channel conditionally dependent
- Independent: In-1



**Important!**

The switch is monitored for a malfunction; the door monitoring must not switch before guard lock monitoring. The guard does not have to be opened in this operating mode. Safety is provided again when the guard locking is closed.



### 10.3.2. Dual-channel independent

**Cat.  
4**

The safety switch is configured in the AS-Interface safety monitor with the AS-Interface address set as follows, for example:

- Dual-channel independent
- With or without start-up test

### 10.4. AS-Interface status messages

A dual LED (red/green) displays the colors red, green and yellow. The following table provides assistance with troubleshooting.

State ASI LED	Explanation
green	Normal operation
red	No data exchange between master and slave Cause: - Master in STOP mode - Slave not in LPS - Slave with wrong IO/ID
red/yellow alternately flashing	No data exchange between master and slave Cause: slave address=0
red/green alternately flashing	Device fault in the slave. Contact EUCHNER.
red flashing	

### 10.5. Safety in case of faults

The ASi power supply and the auxiliary voltage are reverse polarity protected.

### 10.6. Connection of guard locking control

#### 10.6.1. Guard locking control via ASi bit D0

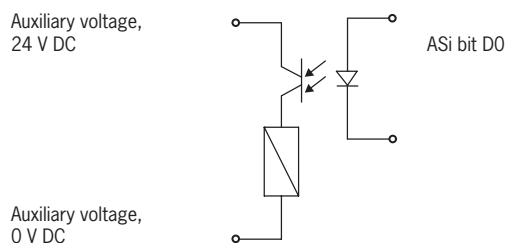

Figure 4: Connection example: guard locking control via ASi bit D0

## 11. Setup

### 11.1. LED displays

You will find a detailed description of the signal functions in chapter 12. *System status table on page 20.*

LED	Color
ASi	green/red
STATE	green/red
LED 1	red
LED 2	green

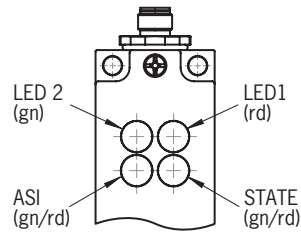

#### NOTICE

Depending on version, the function of LED 1 and LED 2 can differ. Detailed information is available on the enclosed data sheet or at [www.euchner.com](http://www.euchner.com). Simply enter the order number of your device in the search box.

### 11.2. Teach-in function for actuator (only for unicode evaluation)

The actuator must be allocated to the safety switch using a teach-in function before the system forms a functional unit.

The zero sequence is output during a teach-in operation.



#### Tip!

Prior to switching on, close the guard on which the actuator to be taught-in is installed. The teach-in operation starts immediately after switching on.



#### Important!

- › The teach-in operation may be performed only if the device does not have any internal fault.
- › Devices in the condition as supplied remain in teach-in standby state until you have successfully taught-in the first actuator. Once taught-in, switches remain in the teach-in standby state for approx. 3 min. after each switch-on.
- › The safety switch disables the code of the preceding device if teach-in is carried out for a new actuator. Teach-in is not possible again immediately for this device if a new teach-in operation is carried out. The disabled code is released again in the safety switch only after a third code has been taught-in.
- › The safety switch can be operated only with the last actuator taught-in.
- › If the switch detects the actuator that was most recently taught-in when in the teach-in standby state, this state is ended immediately and the switch changes to normal operation.
- › The actuator to be taught-in is not activated if it is within the actuating range for less than 60 s.

### 11.2.1. Actuator teach-in

1. Establish teach-in standby:
  - Connect AS-Interface bus and auxiliary power to the safety switch.
- ➔ Teach-in standby indication, STATE LED flashes 3x repeatedly.
2. Activate guard locking via bit D0:
  - CET3**            Bit D0 = 0
  - CET4**            Bit D0 = 1
3. Fully insert new actuator into the recess. Do not cant it; place it in the center of the recess (see picture on left).
  - ➔ Teach-in operation starts, the STATE LED flashes green (approx. 1 Hz). The teach-in operation is completed after approx. 60 seconds; the STATE LED illuminates red for 1 second and then goes out.
4. Disconnect AS-Interface bus and auxiliary power (at least 3 seconds).
  - ➔ The code of the actuator that was just taught-in is activated in the safety switch.
4. Connect AS-Interface bus and auxiliary power to the safety switch.
  - ➔ The device operates normally.

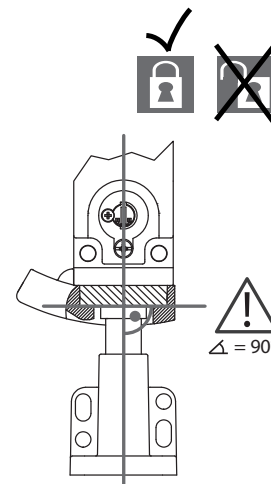

### 11.3. Functional check



#### WARNING

- Danger of fatal injury as a result of faults in installation and functional check.
- › Before carrying out the functional check, make sure that there are no persons in the danger zone.
  - › Observe the valid accident prevention regulations.

#### 11.3.1. Mechanical function test

The actuator must slide easily into the recess on the actuating head. Close the guard several times to check the function. For devices with mechanical release (emergency release or escape release), the correct function of the release must be checked as well.













#### 11.3.2. Electrical function test

After installation and any fault, the safety function must be fully checked. Proceed as follows:

1. Switch on operating voltage.
  - ➔ The machine must not start automatically.
  - ➔ The safety switch carries out a self-test. The green STATE LED then flashes at regular intervals.
2. Close all guards. In case of guard locking by solenoid force: activate guard locking.
  - ➔ The machine must not start automatically. It must not be possible to open the guard.
  - ➔ The green STATE LED illuminates continuously.
3. Enable operation in the control system.
  - ➔ It must not be possible to deactivate guard locking as long as operation is enabled.
4. Disable operation in the control system and deactivate guard locking.
  - ➔ The guard must remain locked until there is no longer any risk of injury.
  - ➔ It must not be possible to start the machine as long as the guard locking is deactivated.

Repeat steps 2 - 4 for each guard.

## 12. System status table

Operating mode	Actuator/door position	LED indicator Output		State
		STATE (green)	STATE (red)	
Normal operation	closed		○	Normal operation, door closed and locked
	closed	 1 x	○	Normal operation, door closed and <b>not</b> locked
	open	 1 x	○	Normal operation, door open
Teach-in standby	open	 3 x	○	Door open; device is ready for teach-in for a new actuator (only short time after power-up)
Setup	closed	 1 Hz	○	Teach-in operation
	X	○	○	Positive acknowledgment after completion of teach-in operation
Fault display	X	 1 x		Fault in the teach-in operation (e.g. actuator removed from the actuating range prior to the end of the teach-in operation or disabled actuator in the actuating range)
	X	 5 x		Internal fault (e.g. component faulty, data error)
	X	X	X	Internal fault
Key to symbols		○		LED not illuminated
				LED illuminated
		 10 Hz (8 s)		LED flashes for 8 seconds at 10 Hz
		 3 x		LED flashes three times
		X		Any state

After the cause has been remedied, faults can generally be reset by opening and closing the guard. If the fault is still displayed afterward, use the reset function or briefly interrupt the power supply. Please contact the manufacturer if the fault could not be reset after restarting.



### Important!

If you do not find the displayed device status in the system status table, this indicates an internal device fault. In this case, you should contact the manufacturer.

### 13. Technical data



#### NOTICE

If a data sheet is included with the product, the information on the data sheet applies.

#### 13.1. Technical data for safety switch CET.-AS-...

Parameter	Value			Unit
	min.	typ.	max.	
<b>General</b>				
Material, ramp	Stainless steel			
Material, safety switch housing	Die-cast aluminum			
Installation orientation	Any (recommendation: switch head downward)			
Degree of protection	IP67 (screwed tight with the related mating connector)			
Safety class	III			
Degree of contamination	3			
Mechanical life	1 x 10 <sup>6</sup> operating cycles			
Ambient temperature at U <sub>B</sub>	-20	-	+55	°C
Actuator approach speed, max.	20			m/min
Locking force F <sub>max</sub>	6,500			N
Locking force F <sub>Zh</sub> in acc. with test principles GS-ET-19	F <sub>Zh</sub> = F <sub>max</sub> /1.3 = 5,000			N
Weight	Approx. 1.0			kg
Degrees of freedom (actuator in recess) X, Y, Z	X and Y: ± 5; Z: ± 4			mm
Connection (depending on version)	Plug connector M12, 4-pin			
Resilience to vibration	Acc. to EN 60947-5-2			
EMC protection requirements	Acc. to EN IEC 60947-5-3			
Ready delay	-	-	1	s
Risk time	-	-	400	ms
Turn-on time	-	-	500	ms
<b>Solenoid</b>				
Auxiliary voltage	-	24 +10%/-15% (PELV)	-	V DC
Current consumption with auxiliary voltage	-	480	-	mA
Duty cycle	-	100	-	%
<b>AS-Interface data</b>		EA code: 7	ID code: B	
Total current consumption	-	-	50	mA
Valid AS-Interface addresses	1 - 31			
<b>AS-Interface inputs</b> Acc. to AS-Interface Safety at Work				
Door monitoring contact	D0, D1			
Solenoid monitoring contact	D2, D3			
<b>AS-Interface outputs</b>				
Guard locking solenoid	D0, 1 = solenoid energized			
Red LED	D1, 1 = LED on			
Green LED	D2, 1 = LED on			
<b>Reliability values acc. to EN ISO 13849-1</b>				
Mission time	20			years
<b>Monitoring of guard locking and the guard position</b> Any installation orientation (head downward, upward or horizontal)				
Category	4			
Performance Level (PL)	e			
PFH <sub>D</sub>	3.1 x 10 <sup>-9</sup> / h			
<b>Control of guard locking by ASi bit D0</b>				
Category	B			
Performance Level (PL)	b			
PFH <sub>D</sub>	4.23 x 10 <sup>-6</sup> / h			

**13.1.1. Typical system times**

Please refer to the technical data for the exact values.

**Turn-on time of safety outputs:** The max. reaction time  $t_{on}$  is the time from the moment when the guard is locked to the moment when the safety outputs switch on.

**Risk time according to EN 60947-5-3:** If an actuator moves outside the actuating range, the safety outputs  $\square$  (OA and OB) are deactivated at the latest after the risk time.

**13.2. Dimension drawing for safety switch CET.-AS-...**

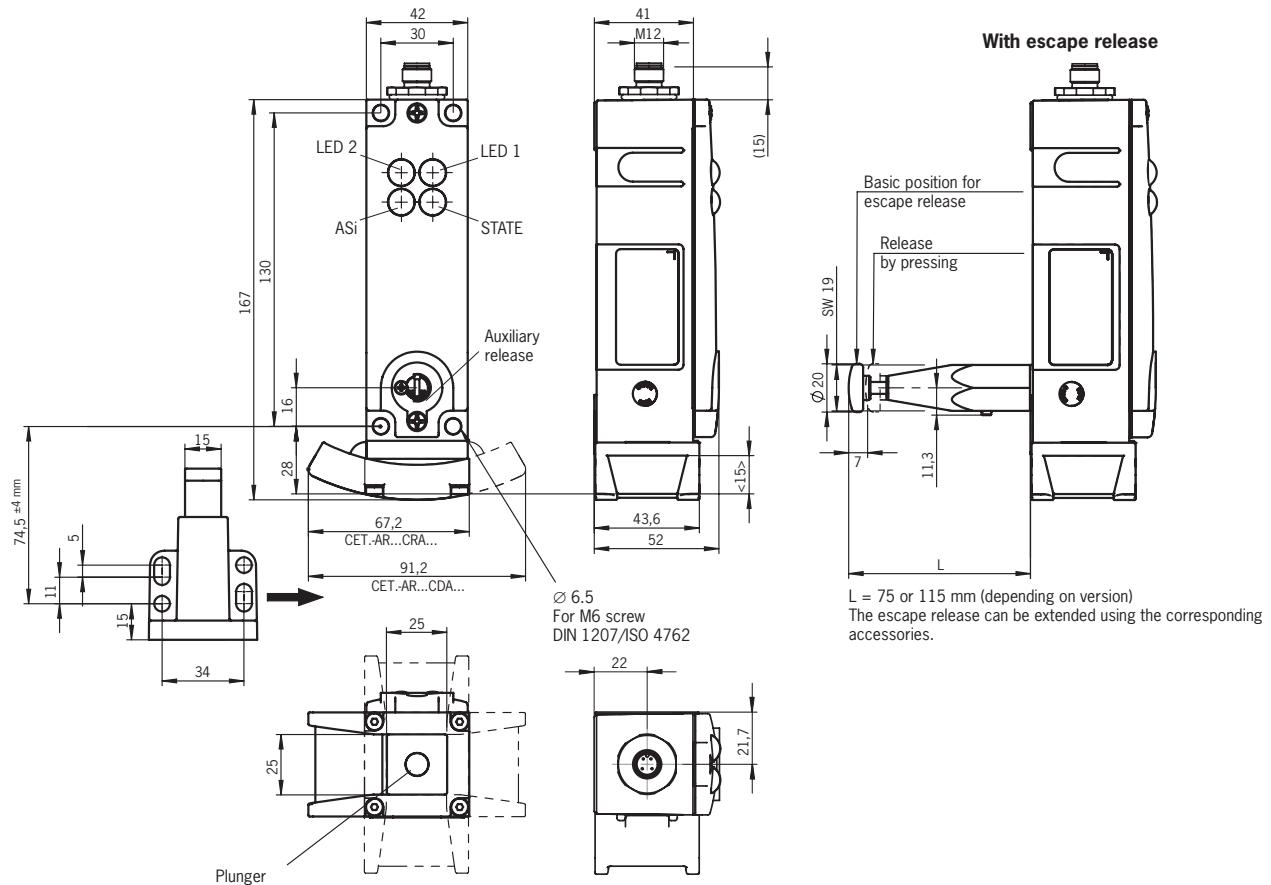

**Versions with manual release options**

With auxiliary key release

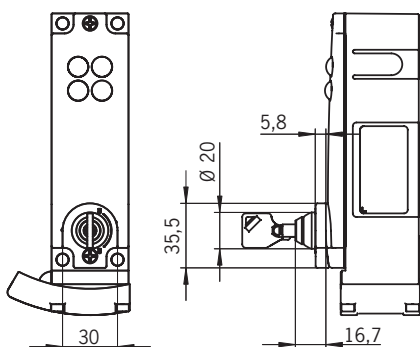

With emergency release

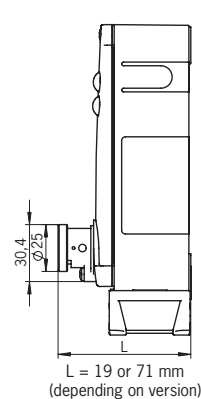

With wire front release

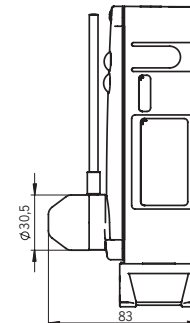

### 13.3. Technical data for actuator CET-A-B...

Parameter	Value			Unit
	min.	typ.	max.	
Housing material	Stainless steel			
Stroke, max.	15			mm
Weight	0.25			kg
Ambient temperature	- 20	-	+ 55	°C
Degree of protection	IP67 (transponder degree of protection)			
Mechanical life	1 x 10 <sup>6</sup> operating cycles			
Locking force, max.	6,500			N
Installation orientation	Active face opposite switch head			
Power supply	Inductive via switch			

#### 13.3.1. Dimension drawing for actuator CET-A-BWK-50X

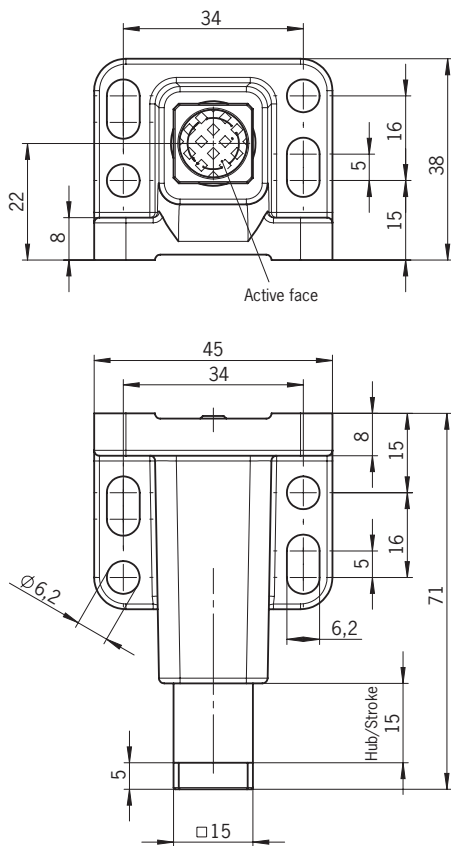

#### NOTICE

- › Four safety screws M5 x16 are included with the actuator.
- › All four safety screws must always be used.

## 14. Ordering information and accessories



**Tip!**

Suitable accessories, e.g. cables or assembly material, can be found at [www.euchner.com](http://www.euchner.com). To order, enter the order number of your item in the search box and open the item view. Accessories that can be combined with the item are listed in *Accessories*.

## 15. Inspection and service



**WARNING**

Loss of the safety function because of damage to the device.

- › In case of damage, the entire device must be replaced.
- › Only accessories or spare parts that can be ordered from EUCHNER may be replaced.

Regular inspection of the following is necessary to ensure trouble-free long-term operation:

- › Check the switching function (see chapter 11.3. *Functional check on page 19*)
- › Check all additional functions (e.g. escape release, lockout bar, etc.)
- › Check the secure mounting of the devices and the connections
- › Check for soiling

No servicing is required. Repairs to the device are only allowed to be made by the manufacturer.



**NOTICE**

The year of manufacture can be seen in the lower right corner of the rating plate. The current version number in the format (V X.X.X) can also be found on the device.

## 16. Service

If servicing is required, please contact:

EUCHNER GmbH + Co. KG  
Kohlhammerstraße 16  
70771 Leinfelden-Echterdingen  
Germany

**Service telephone:**

+49 711 7597-500

**E-mail:**

[support@euchner.de](mailto:support@euchner.de)

**Internet:**

[www.euchner.com](http://www.euchner.com)



### 17. Declaration of conformity



# EUCHNER

More than safety.

**EU-Konformitätserklärung**  
**EU declaration of conformity**  
**Déclaration UE de conformité**  
**Dichiarazione di conformità UE**  
**Declaración UE de conformidad**

Original DE  
Translation EN  
Traduction FR  
Traduzione IT  
Traducción ES

2110802-11-01/20

Die nachfolgend aufgeführten Produkte sind konform mit den Anforderungen der folgenden Richtlinien (falls zutreffend):  
The beneath listed products are in conformity with the requirements of the following directives (if applicable):  
Les produits mentionnés ci-dessous sont conformes aux exigences imposées par les directives suivantes (si valable)  
I prodotti sotto elencati sono conformi alle direttive sotto riportate (dove applicabili):  
Los productos listados a continuación son conforme a los requisitos de las siguientes directivas (si fueran aplicables):

I:	Maschinenrichtlinie Machinery directive Directive Machines Direttiva Macchine Directiva de máquinas	2006/42/EG 2006/42/EC 2006/42/CE 2006/42/CE 2006/42/CE
II:	Funkanlagen-Richtlinie (RED) Radio equipment directive Directive équipement radioélectrique Direttiva apparecchiatura radio Directiva equipo radioeléctrico	2014/53/EU 2014/53/EU 2014/53/UE 2014/53/UE 2014/53/UE
III:	RoHS Richtlinie RoHS directive Directive de RoHS Direttiva RoHS Directiva RoHS	2011/65/EU 2011/65/EU 2011/65/UE 2011/65/UE 2011/65/UE

Die Schutzziele der Niederspannungsrichtlinie 2014/35/EU und EMV Richtlinie 2014/30/EU werden gemäß Artikel 3.1 der Funkanlagen-Richtlinie eingehalten.  
The safety objectives of the Low-voltage directive 2014/35/EU and EMC Directive 2014/30/EU comply with article 3.1 of the Radio equipment directive.  
Les objectifs de sécurité de la Directive basse tension 2014/35/UE et Directive de CEM 2014/30/UE sont conformes à l'article 3.1 de la Directive équipement radioélectrique.  
Gli obiettivi di sicurezza della Direttiva bassa tensione 2014/35/UE e Direttiva CEM 2014/30/UE sono conformi a quanto riportato nell'articolo 3.1 della Direttiva apparecchiatura radio.  
Los objetivos de seguridad de la Directiva de bajo voltaje 2014/35/UE y Directiva CEM 2014/30/UE cumplen con el artículo 3.1 de la Directiva equipo radioeléctrico.

Folgende Normen sind angewandt: a: EN 60947-5-3:2013  
Following standards are used: b: EN ISO 14119:2013  
Les normes suivantes sont appliquées: c: EN ISO 13849-1:2015  
Vengono applicate le seguenti norme: d: EN 62026-2:2013 (ASI)  
Se utilizan los siguientes estándares: e: EN 50581:2012 (RoHS)  
f: EN 50364:2018  
g: EN 300 330 V2.1.1

Bezeichnung der Sicherheitsbauteile Description of safety components Description des composants sécurité Descrizione dei componenti di sicurezza Descripción de componentes de seguridad	Type Type Type Tipo Tipo	Richtlinie Directives Directive Direttiva Directivas	Normen Standards Normes Norme Estándares	Zertifikats-Nr. No. of certificate Número du certificat Numero del certificato Número del certificado
Sicherheitsschalter Safety Switches Interrupteurs de sécurité Fincorsa di sicurezza Interruptores de seguridad	CET1-AR... CET2-AR... CET3-AP... CET3-AR... CET4-AP... CET4-AR... CET3-AS... CET4-AS...	I, II, III I, II, III	a, b, c, e, f, g a, b, c, d, e, f, g	UQS 117149 UQS 122248
Betätiger Actuator Actionneur Azionatore Actuador	CET-A-BW...	I, II, III	a, b, c, e, f, g	UQS 122248

Genehmigung der umfassenden Qualitätssicherung (UQS) durch die benannte Stelle 0035  
Approval of the full quality assurance system by the notified body 0035  
Approbation du système d'assurance qualité complet par l'organisme notifié 0035  
Approvazione del sistema di garanzia di qualità totale da parte dell'organismo notificato 0035  
Aprobación del sistema de aseguramiento de calidad total por parte del organismo 0035 notificado

TÜV Rheinland Industrie Service GmbH  
Alboinstr. 56  
12103 Berlin  
Germany



**EUCHNER**

More than safety.

Die alleinige Verantwortung für die Ausstellung dieser Konformitätserklärung trägt der Hersteller:  
*This declaration of conformity is issued under the sole responsibility of the manufacturer:*  
*La présente déclaration de conformité est établie sous la seule responsabilité du fabricant:*  
*La presente dichiarazione di conformità è rilasciata sotto la responsabilità esclusiva del fabbricante:*  
*La presente declaración de conformidad se expide bajo la exclusiva responsabilidad del fabricante:*

EUCHNER GmbH + Co. KG  
Kohlhammerstraße 16  
70771 Leinfelden-Echterdingen  
Germany

i.A. Dipl.-Ing. Richard Holz  
Leiter Elektronik-Entwicklung  
*Manager Electronic Development*  
*Responsable Développement Électronique*  
*Direttore Sviluppo Elettronica*  
*Director de desarrollo electrónico*

i.A. Dipl.-Ing.(FH) Duc Binh Nguyen  
Dokumentationsbevollmächtigter  
*Documentation manager*  
*Responsable documentation*  
*Responsabilità della documentazione*  
*Agente documenta*

Leinfelden, Januar 2020

EUCHNER GmbH + Co. KG  
Kohlhammerstraße 16  
70771 Leinfelden-Echterdingen  
Germany



Euchner GmbH + Co. KG  
Kohlhammerstraße 16  
70771 Leinfelden-Echterdingen  
Germany  
info@euchner.de  
www.euchner.com

Edition:  
2113689-05-05/20  
Title:  
Operating Instructions Transponder-Coded Safety Switch  
CET-AS-...  
(Translation of the original operating instructions)  
Copyright:  
© EUCHNER GmbH + Co. KG, 05/2020

Subject to technical modifications; no responsibility is accepted for the accuracy of this information.