



CMC-EC01

EtherCAT Communication Card Operation Manual



<http://www.deltaww.com/>



Warning

- ✓ This operation manual provides information on specifications, installation, basic operation, setup and details of the communication protocol
- ✓ AC motor drive is a delicate electrical and electronic product. For the safety of operator and the mechanical equipment, please allow professional electrical mechanics to do the trial run and adjust parameters for you. Should there be any questions, please consult your local Delta distributors. Our professional staff will be happy to help you
- ✓ Please read this operation manual thoroughly and follow the instructions in case damage on the device or injury on the operation staff occur.

Table of Content

1	Introduction.....	3
1.1	EtherCAT Description	3
1.2	Functionality.....	3
2	Product Profile and Outline	4
2.1	Dimension.....	4
2.2	Parts.....	4
2.3	LED indicator	5
2.4	RJ-45 PIN Definition	5
3	Installation and Wiring	6
3.1	How to Install	6
3.2	How to Disconnect.....	6
3.3	Wiring.....	7
4	VFD-C2000 Drive Configuration	8
5	EtherCAT List and Description of supported Index.....	9
5.1	Index related to the state machine.....	9
5.2	Index related to the control mode	10
5.3	Index related to the speed	10
5.4	Index Related to Disconnections	11
6	Configuring the Connection with the Beckhoff PLC.....	13
6.1	Basic Configuration.....	13
6.2	Speed Mode Demo	17

1 Introduction

1.1 EtherCAT Description

The application layer of the C2000's EtherCAT communication interface uses the standard DS402 protocol and complies with the CoE (CAN Application Protocol over EtherCAT) definition. Therefore, all of C2000's application layer protocols that comply with the CANopen DS402 standard can be used on top of EtherCAT.

1.2 Functionality

For the user's convenience, C2000's EtherCAT card currently supports standard DS402 Velocity (Index 6060 = 2). It should be noted, however, that this mode is asynchronous control mode. C2000 support EtherCAT communication card from v2.02, please make sure if the drive firmware is supported or not.

■ Specification

Item	Specifications
Connection	RJ-45
Ports	2 Port
Interface	IEEE802.3, IEEE802.3u
Cable	Category 5e shielding 100 M
Speed	10 / 100 Mbps Auto-Defect
Protocol	EtherCAT

■ Environment

Item	Specifications
Nosie Immunity	ESD (IEC 61800-5-1, IEC 6100-4-2) EFT (IEC 61800-5-1, IEC 6100-4-4) Surge Teat (IEC 61800-5-1, IEC 6100-4-5) Conducted Susceptibility Test (IEC 61800-5-1, IEC 6100-4-6)
Operation Temperature	-10 °C ~ 50 °C (Temperature) · 90 % (Humidity)
Storage Temperature	-25 °C ~ 70 °C (Temperature) · 95 % (Humidity)
Vibration / Shock Immunity	IEC 61800-5-1, IEC 60068-2-6 / IEC 61800-5-1, IEC 60068-2-27

■ Electrical Specification

Item	Specifications
Power Supply	5 V _{dc}
Power Consumption	0.8 W
Insulation Voltage	500 V _{dc}
Weight	27 (g)

2 Product Profile and Outline

2.1 Dimension

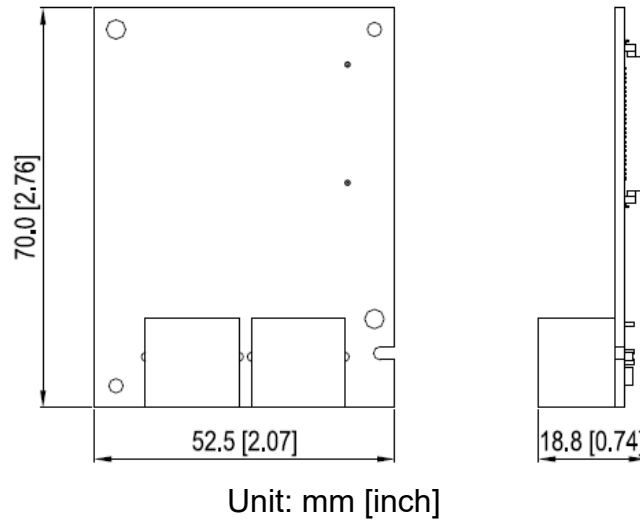

2.2 Parts

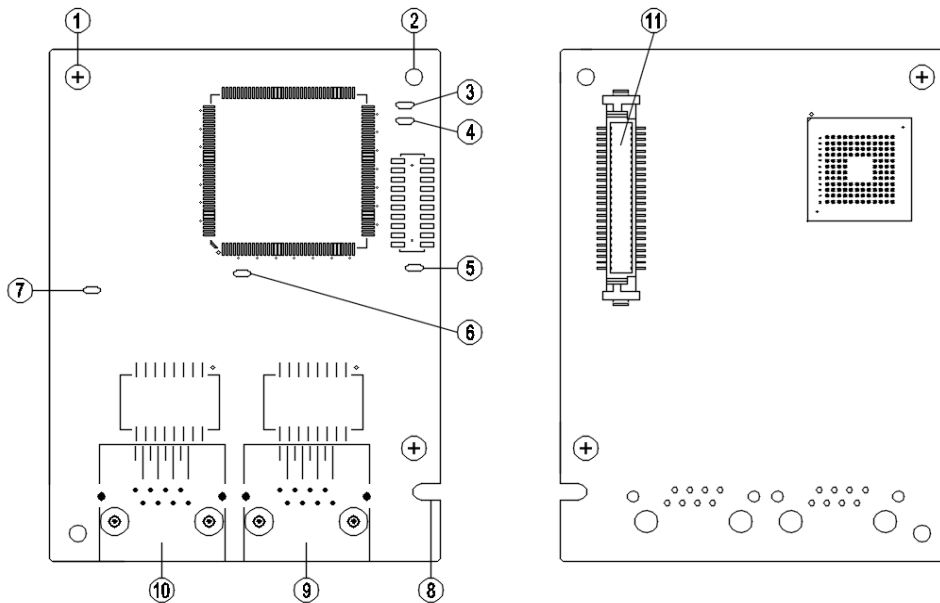

1. Screw fixing hole	7. IN LINK indicator
2. Positioning hole	8. Fool-proof groove
3. RUN indicator	9. RJ-45 connection port
4. ERR indicator	10. RJ-45 connection port
5. POWER indicator	11. AC motor drive connection port
6. OUT LINK indicator	

2.3 LED indicator

Name	Status		Indication
POWER	Green	On	Power supply in normal status
		Off	No power supply
LINK	Green	On	Normal status
		Blink	Pre-operation(on/off200ms)
			Safe mode (on 200ms/ off 1000ms)
Off	Initial		
ERROR	Red	Blink	Basic configuration error (on/off 200ms)
			Status witch error (on200ms /off1000ms)
			Timeout(on 200ms twice /off1000ms)
Off	No error		
IN LINK	Green	On	Network connected
		Blink	Network in operation
		Off	Network not connected
OUT LINK	Green	On	Network connected
		Blink	Network in operation
		Off	Network not connected

2.4 RJ-45 PIN Definition

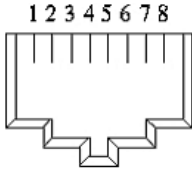
RJ-45 Sketch	No.	Signal	Definition
	1	Tx+	Positive pole for data transmission
	2	Tx-	Negative pole for data transmission
	3	Rx+	Positive pole for data receiving
	4	--	N / C
	5	--	N / C
	6	Rx-	Negative pole for data receiving
	7	--	N / C
	8	--	N / C

3 Installation and Wiring

In this section, we illustrate how to connect CMC-EC01 to VFD-C2000 and the network

3.1 How to Install

How to connect CMC-EIP01 to VFD-C2000 series AC motor drive:

- Switch off the power supply of VFD-C2000
- Open the front cover of VFD-C2000
- Place the insulation spacer into the positioning pin at Slot 1 (see Figure 1) and aim the two holes on the PCB at the positioning pin. Press the pin to clip the holes with the PCB (see Figure 2).
- Crew up at torque 6~8 kg-cm [5.2~6.9 lb-in.] [0.59~0.78 Nm] after the PCB is clipped with the holes (see Figure3) .

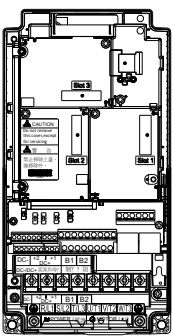

Figure1

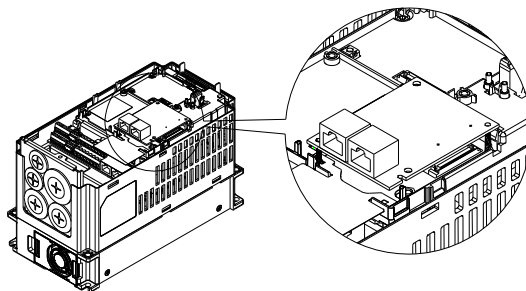

Figure 2

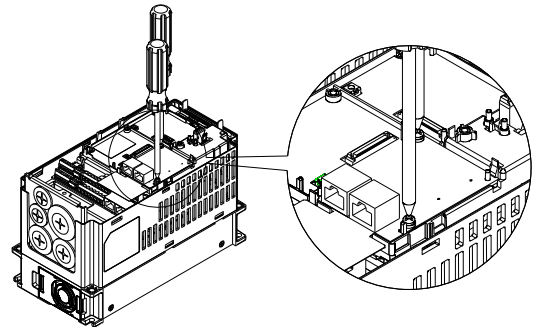

Figure 3

3.2 How to Disconnect

How to disconnect CMC-EIP01 from VFD-C2000

- Switch off the power of VFD-C2000
- Open the front cover of VFD-C2000
- Remove the two screws (see Figure 4).
- Twist open the card clip and insert the slot type screwdriver to the hollow to prize the PCB off the card clip (see Figure 5).
- Twist and open the other card clip to remove the PCB (see Figure 6).

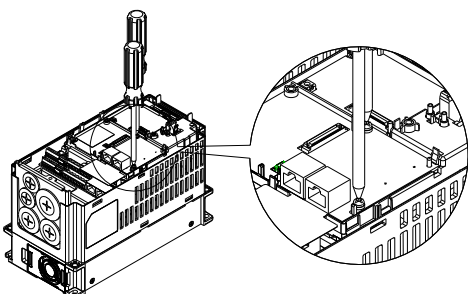

Figure 4

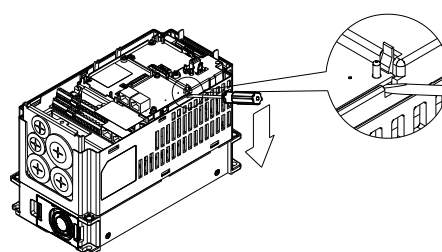

Figure 5

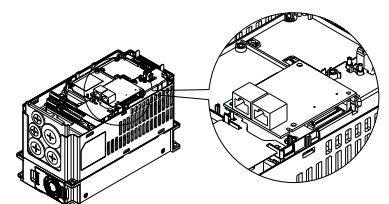
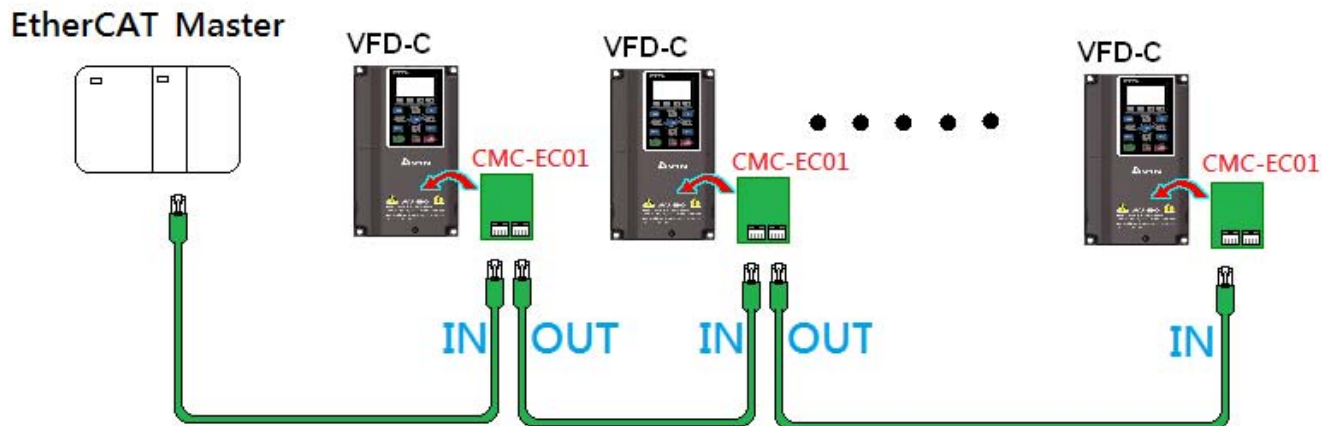

Figure 6

3.3 Wiring

The CMC-EC01 moves packets directionally from IN (left) to OUT (right), with the correct wiring method shown below:



After hardware installation is complete, turn on the power and look at parameter P9-60. The value displayed should be "6", and the word "EtherCAT" should also be displayed. If not, please check the version of the inverter and whether the card has been correctly connected. (C2000 of version v2.02 or above may support CMC-EC01)

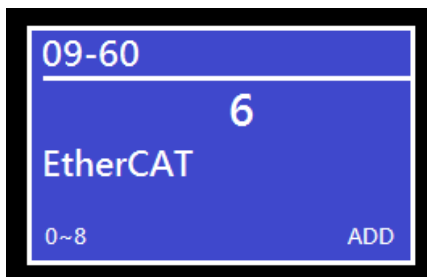

4 VFD-C2000 Drive Configuration

To control the C2000 via EtherCAT, all you need to do is configure relative parameters so that the command input source is set to the EtherCAT communications interface.

Relative settings are as follows :

Parameter	Value / Display	Description
Pr. 00-20	8	set the communications card as the frequency source if speed control is required
Pr. 00-21	5	set the communications card as the control source
Pr. 09-60	6	check whether P9-60 automatically displays EtherCAT as the communications card type

[NOTE] :

1. In order for the PLC or control PC to be able to recognize the C2000, the product description file (ESI file) of the C2000 must be loaded. The file name of the C2000 product description file is "CMC-EC01 with C2000.xml," and this file can be obtained from [Delta's website](#).
2. To have C2000 calculate correctly the output frequency by sending a target speed command, please enter motor pole number parameter based on the motor type set at Pr. 05-33. For example, set Pr. 05-04 if it is asynchronous motor, or set Pr. 05-37 if it is synchronous motor.

5 EtherCAT List and Description of supported Index

The C2000 currently supports the standard DS402 specification. Therefore, its state machine and control follow DS402 protocol definitions. These definitions are described in detail in the following sections.

5.1 Index related to the state machine :

In the DS402 definition, state machine state changes are conducted via the Index 6040 control word (bit0~3 and 7). The current state of the state machine is shown in the 6041 status word (bit0~6). Therefore, corresponding bit definitions are as follows:

Index 6040:

Bit	Definition
0	Switch on
1	Enable voltage
2	Quick Stop
3	Enable operation
7	Fault Reset

Index 6041:

Bit	Definition
0	Ready to switch on
1	Switched on
2	Operation enable
3	Fault
4	Voltage enabled
5	Quick stop
6	Switch on disabled

The relationships between the states of the state machine are as shown below:

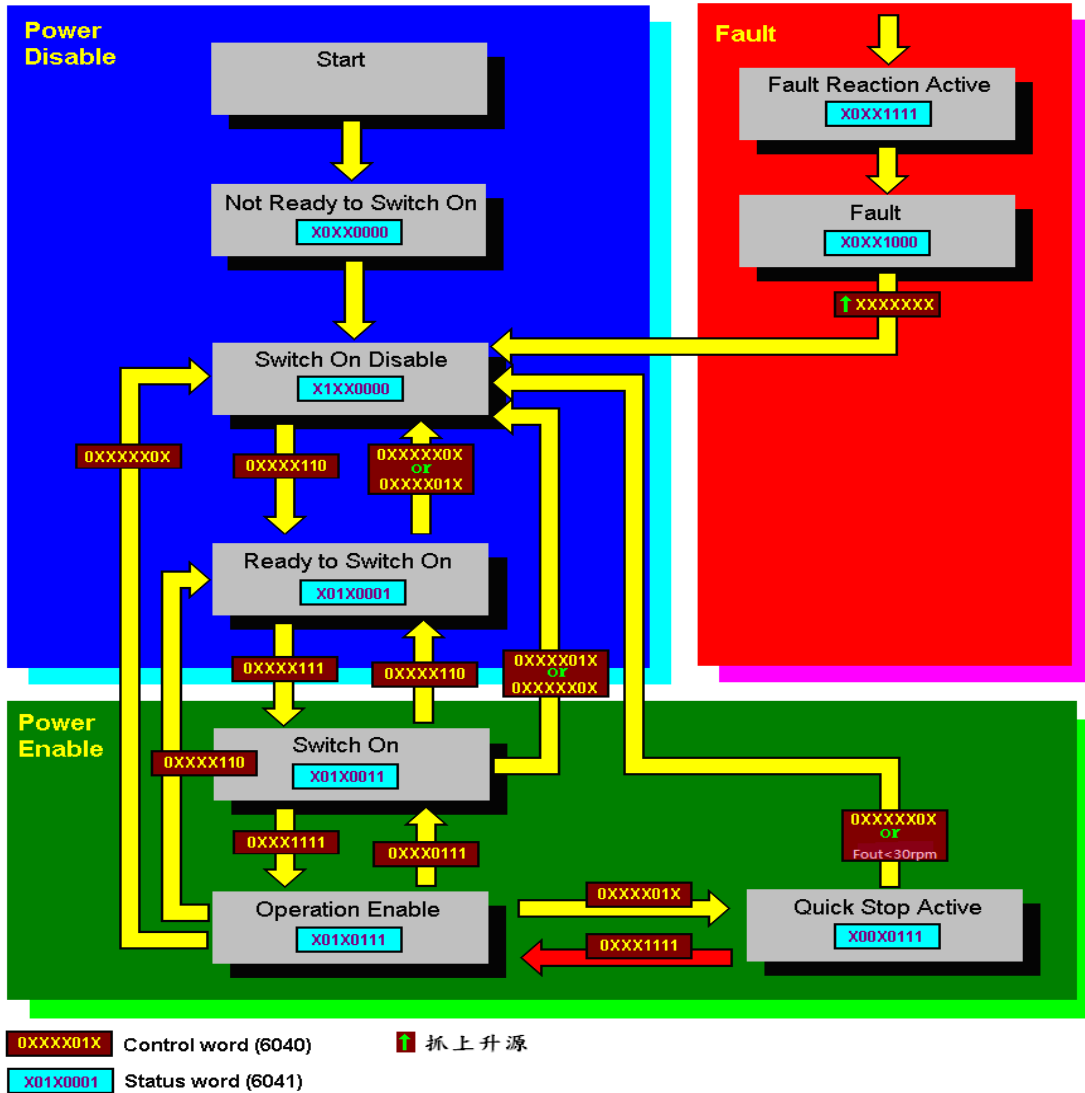

5.2 Index related to the control mode:

0x6060	0	Mode of operation	2	RW	S8	2: Velocity Mode
0x6061	0	Mode of operation display	2	RO	S8	Same as above

5.3 Index related to the speed:

When Index 6060 = 2 and the state machine is in the Operation Enable state, the speed of the drive can be controlled. The indexes and controls currently provided by the C2000 in speed mode are listed below:

Index	Sub	Define	Initial	R/W	Size	Unit	PDO Map	Note
0x6042	0	vl target velocity	0	RW	S16	rpm	Yes	
0x6043	0	vl velocity demand	0	RO	S16	rpm	Yes	
0x604F	0	vl ramp function time	10000	RW	U32	1ms	Yes	The unit must be 100ms
0x6050	0	vl slow down time	10000	RW	U32	1ms	Yes	

The system architecture is as shown below :

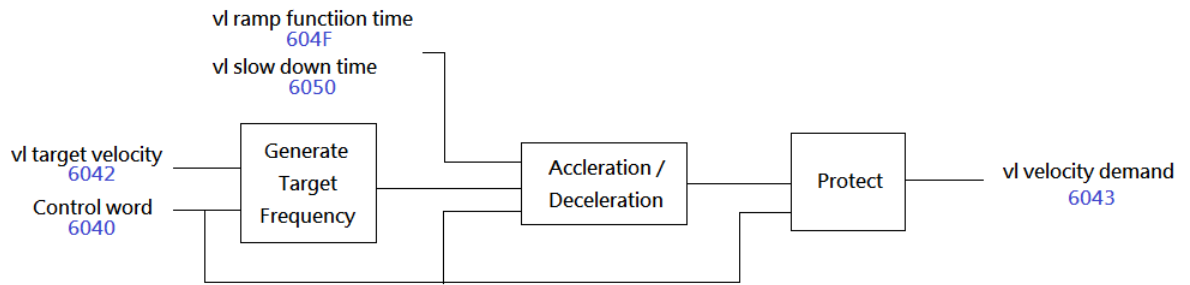

Therefore, when the state machine is in the Operation state, the speed mode control word (bits 4~6 and 8) is defined as follows:

Bit				Description
8	6	5	4	
Halt	rfg use ref	rfg unlock	rfg enable	
0	1	1	1	Run to the target speed
0	1	0	1	Pause at the current speed
1	X	X	X	Decelerate to zero speed
Other				Decelerate to zero speed

5.4 Index Related to Disconnections:

When EtherCAT is disconnected, the C2000 will switch states according to Index 6007.

Index	Sub	Define	Initial	R/W	Size	Note
0x6007	0	Abort connection option co	2	RW	S16	0 : No action 1 : malfunction 2 : Switch on disable 3 : Quick stop

- When 0 is selected for 6007, disconnection errors will be ignored, which means that no warnings will be issued and nothing will be done.
- When 1 is selected for 6007 and there is a disconnection, the CANopen state will change to the Error State and the warning code ECto will be displayed. Once the communications connection is confirmed to be re-established and Bit 7 of 6040 changes from 0 to 1, the error code will be cleared and the state machine will enter the "Switch on Disable" state.
- When 2 is selected for 6007 and a disconnection occurs, the CANopen state will change to "Switch On Disable," ECto will be displayed, and the stop operation will be triggered according to the index 605A settings. When the cable is re-connected and communications are successfully restored, the error code will be automatically cleared.
- When 3 is selected for 6007 and a disconnection occurs, the CANopen state will change to "Switch On Disable," ECto will be displayed, and the stop operation will be triggered according to the index 605C settings. When the cable is re-connected and communications are successfully restored, the error code will be automatically cleared.

When the state machine is in the "Quick Stop" state, stopping of the system will be conducted in accordance with the settings of Index 605A

Index	Sub	Define	Initial	R/W	Size	Note
0x605A	0	Quick stop option code	1	RW	S16	0 : disable drive function 1 : Slow down on slow down ramp and transit into Switch On Disabled 3: Slow down on current limit and transit into Switch On Disabled 5 slow down on slow down ramp and stay in QUICK STOP 7: slow down on the current limit and stay in QUICK STOP

When the state machine is in the "Switch On Disable" state, stopping of the system will be conducted in accordance with the settings of Index 605C

Index	Sub	Define	Initial	R/W	Size	Unit	PDO Map	Note
0x605C	0	Disable operation option code	1	RW	S16		No	0: Disable drive function 1: Slow down with slow down ramp; disable of the drive function

6 Configuring the Connection with the Beckhoff PLC

Here introduce using TwinCAT V2.11 and Beckhoff PLC by EtherCAT communication with VFD-C2000. Hardware configuration as following figure, PC connects to Beckhoff PLC by Ethernet, PLC use EtherCAT Master connects to C2000 CMC-EC01

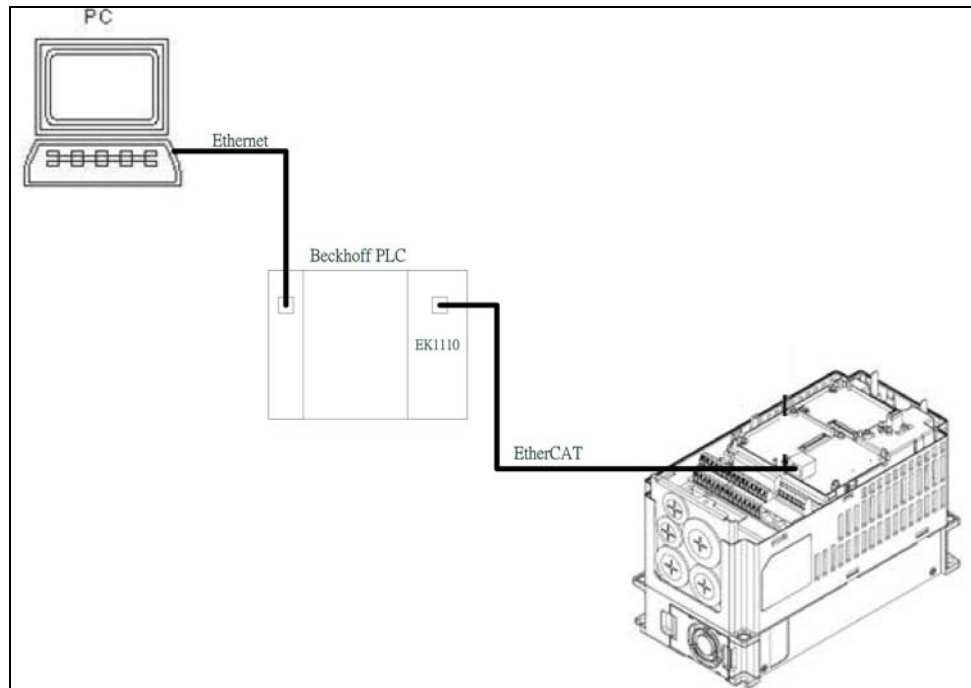

6.1 Basic Configuration

■ Basic Configurations

1. Select "automatically obtain IP address" for the PC's network IP setting.

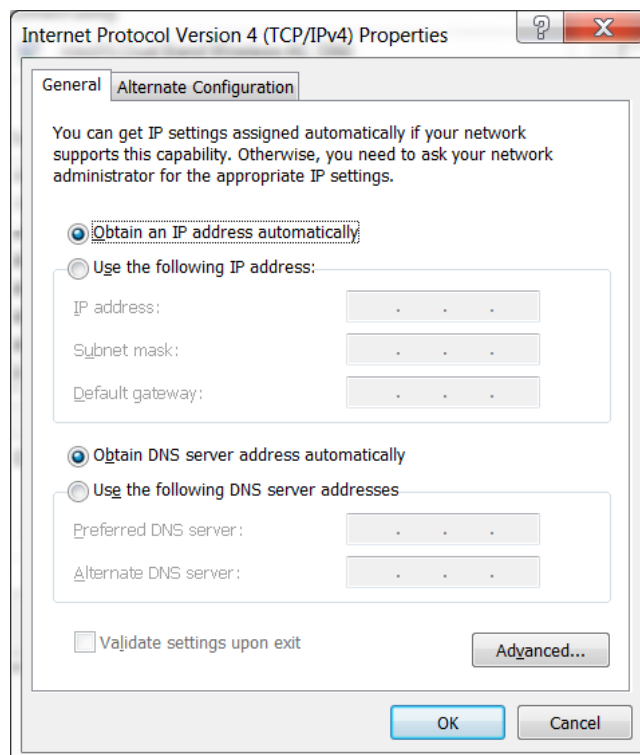

- Place the CMC_EC01 with C2000.xml file into the corresponding folder: ...\\TwinCAT\\Io\\EtherCAT\\

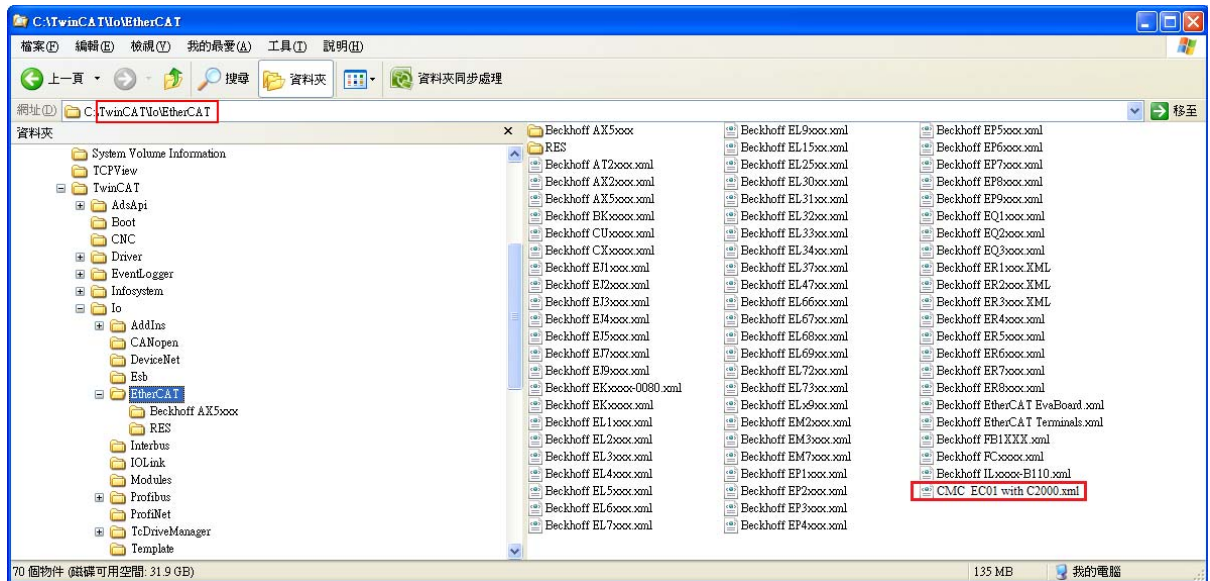

■ Open System Manager

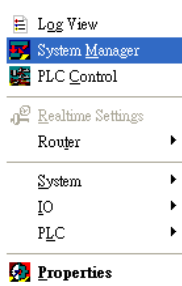

- Click "Choose Target System" (Since there are no target systems in the beginning, you must first scan for target systems)

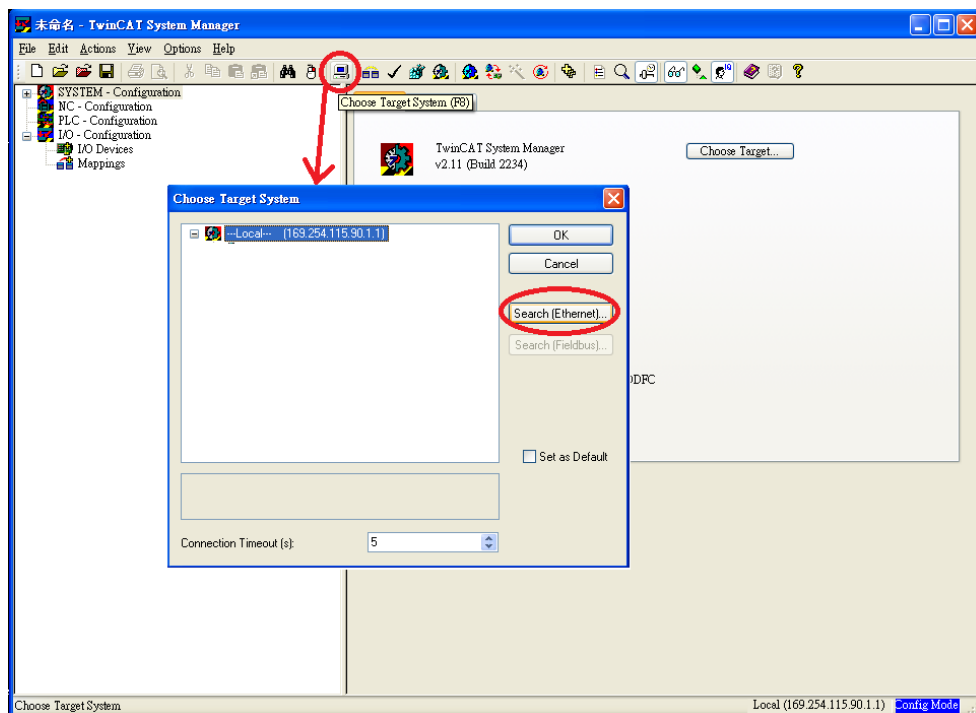

2. Scan via IP broadcast

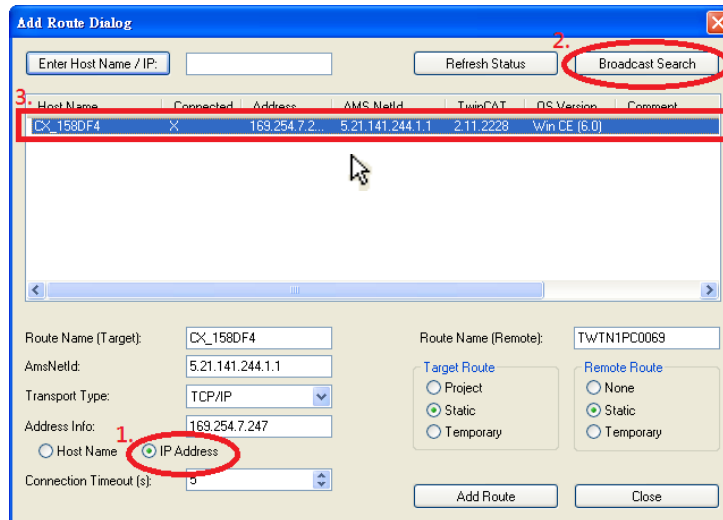

3. Select PLC module and click OK

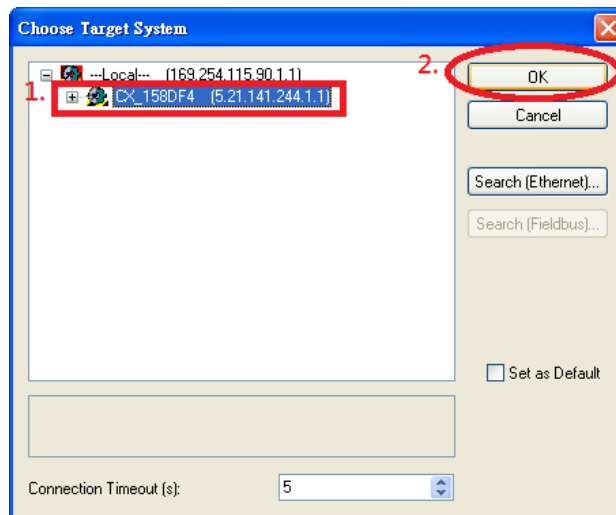

Left-click and select "Scan Devices" (note that the system must be in Configuration Mode). From the scan results, select the "EtherCAT" communications option

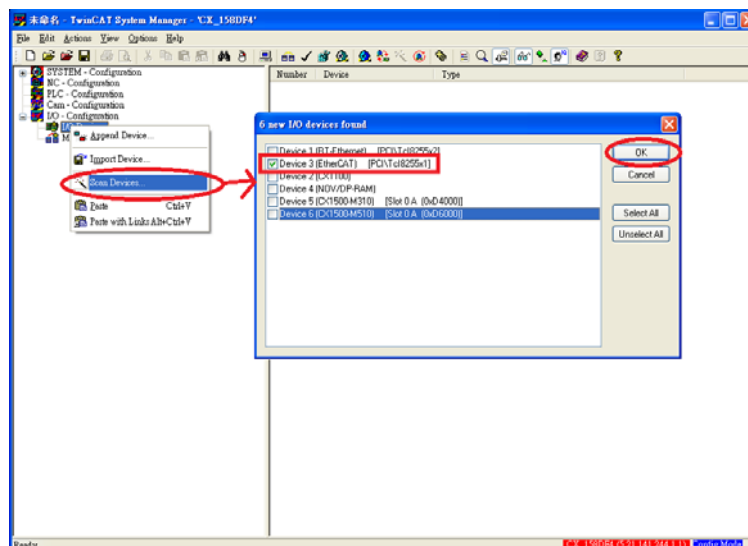

4. Pop-up window “Scan for boxes”, select Yes



5. Pop-up window “New device type found C2000(CMC-EC01 Card)”, select Yes

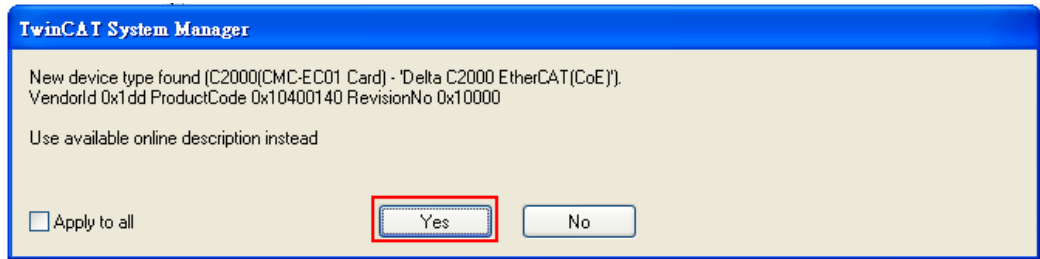

6. CMC-EC01 will be shown in the list of devices

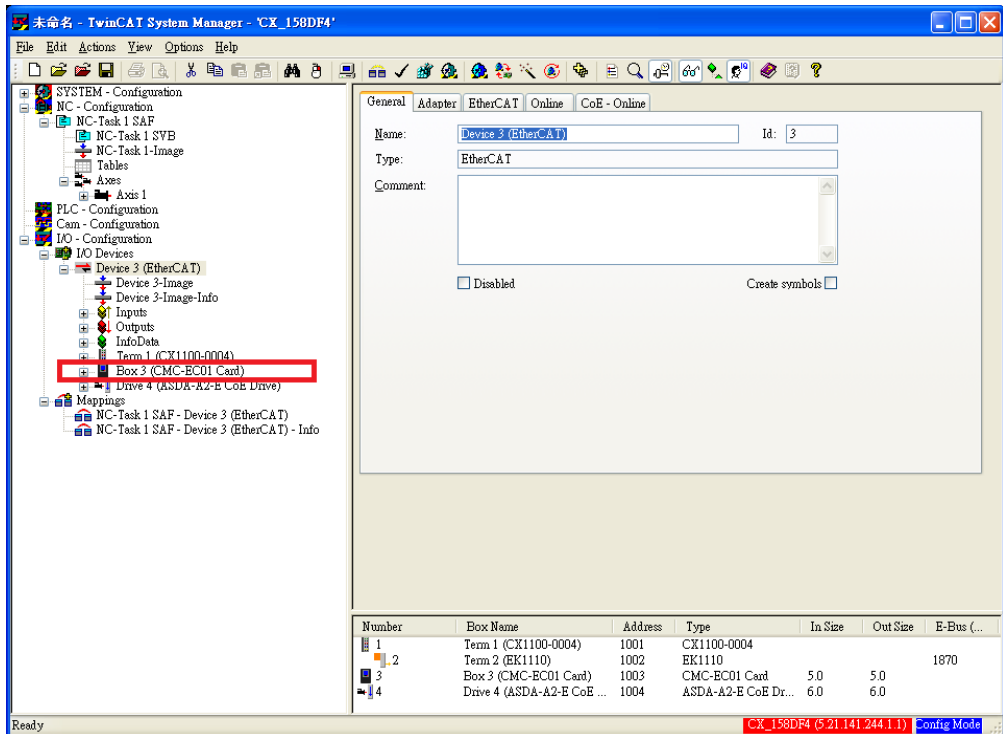

6.2 Speed Mode Demo

- In Configure mode, select PDO1 for TX/RX and then start mapping

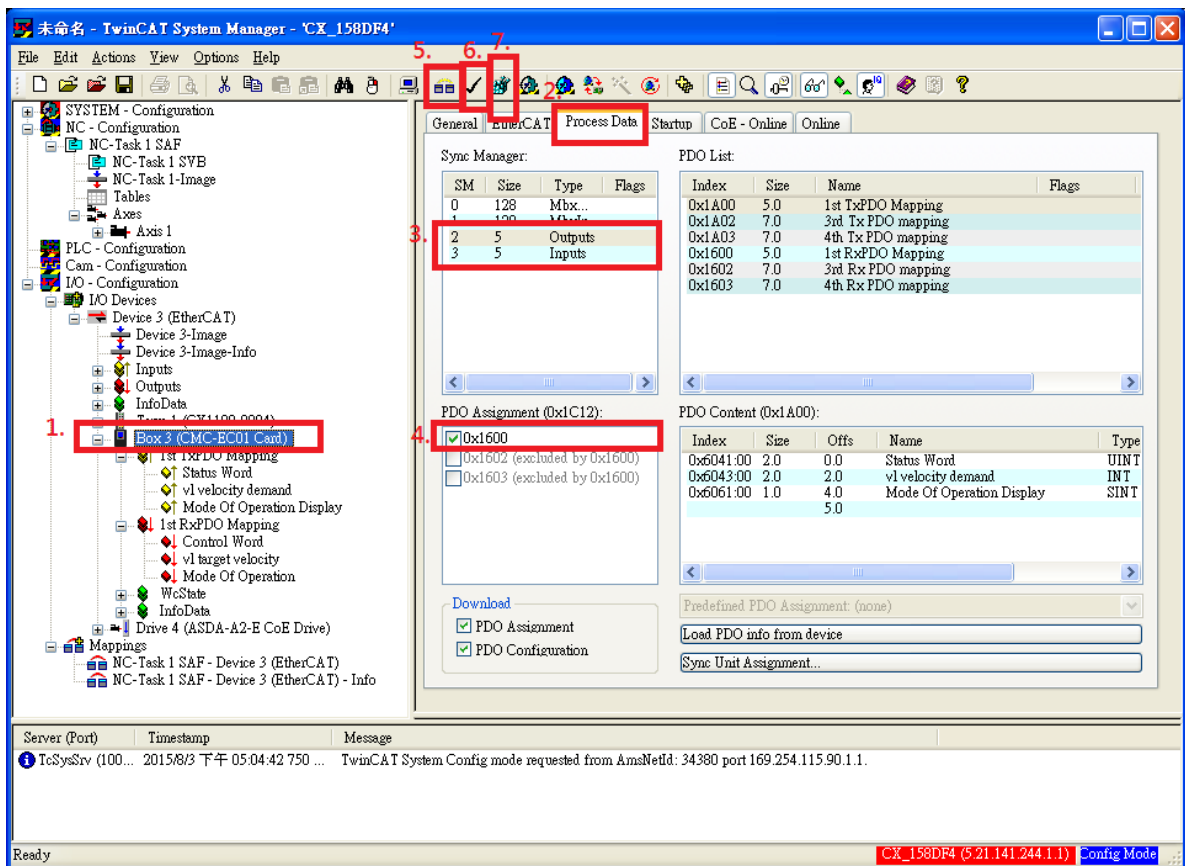

- Start test and modify speed

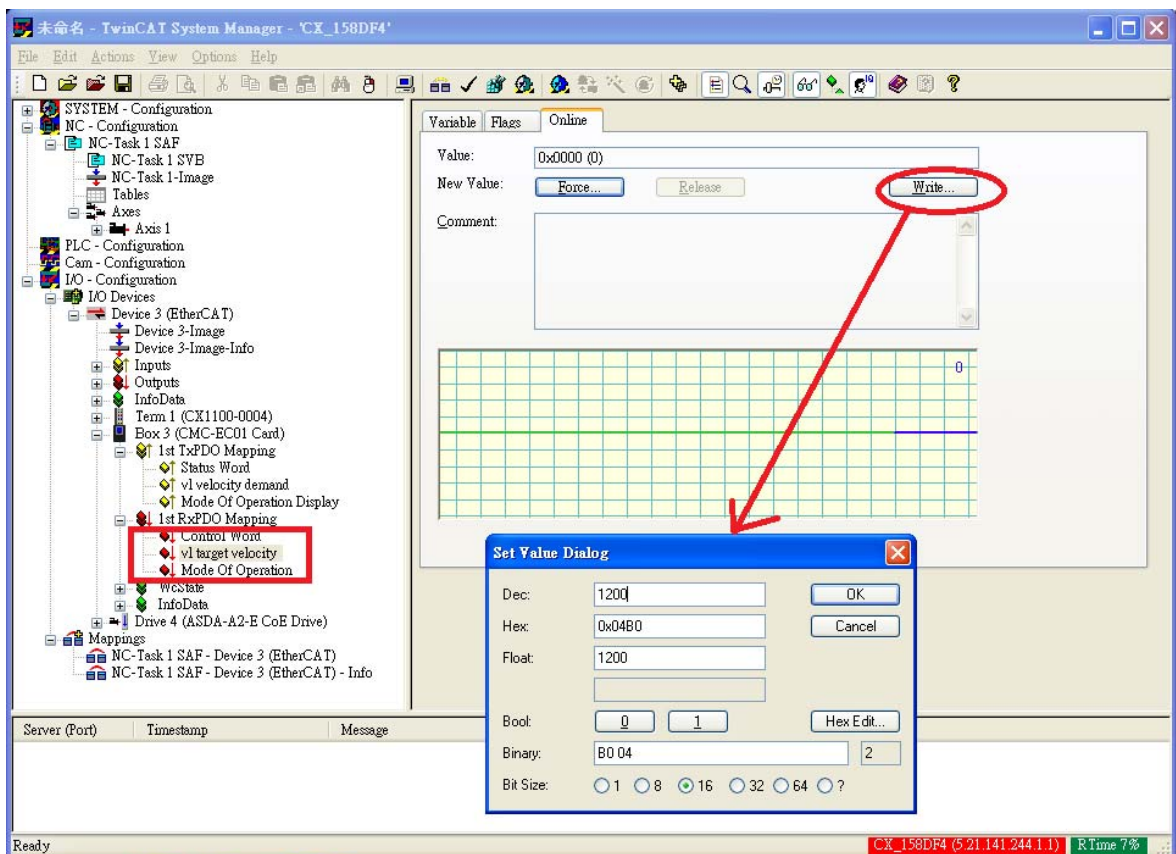

1. Set "target velocity" = 1200 so that the target speed of the drive is 1200rpm.
2. Set Control Word = 0xE, state machine of drive enters to Power Enable.
3. Set Control Word = 0xF, state machine of drive enters to Operation Enable.
4. Set Control Word = 0x7F, allowing the drive to reach the target frequency.
5. Set vl target velocity = -1200, drive begins operating in reverse.
6. Set Control Word = 0x5F, the drive stops at the current frequency.