

# Photoelectric sensors.

Reliable object detection and distance measurement  
even on challenging surfaces



Partnership.  
Precise.  
Pioneering.

# Visibly better: Baumer sensors.

The Baumer Group is leading at international level in the development and production of sensors, shaft encoders, measuring instruments as well as components for automatic image processing. As an owner-managed family business, we employ about 2600 workers worldwide in 38 subsidiaries and 19 countries. With marked customer orientation, consistently high quality and vast innovation capability, Baumer develops specific solutions for many industries and applications worldwide.

## Our standards – your benefits.

- Passion coupled with expertise – both have made us a sensor pioneer and technology leader
- Our range of services is hard to beat – we have the right product, developed by our own team, for every task
- Inspiring through innovation – a challenge Baumer employees take on every day
- Reliability, precision and quality – our customers' requirements are what drives us
- Partnership from the start – together with our customers we develop suitable solutions
- Always a step ahead – thanks to our production depth, our flexibility and our delivery reliability
- Available worldwide – Baumer is Baumer everywhere





## Optical sensors – keeping a sharp eye on your plant automation

Not all light barriers and laser distance sensors are the same. With its comprehensive knowledge of the market and extremely high levels of technological expertise in the field of optoelectronic sensors, Baumer stands for products that offer more:

- Exceptional performance in extremely compact designs.
- Detection with high repeat accuracy even for difficult surfaces, colors or lighting conditions
- Robust products for every environmental condition
- Digital intelligence for optimum application solutions, reduced control complexity, smooth data transfer and more efficient plant maintenance.

### Optical sensors from Baumer at a glance

- The right light source - LED, infrared, Baumer PinPoint and excellent laser sensors
- All functional principles - from through beam sensors to *Smart-Reflect*® light barriers with no reflectors
- The most reliable object detection and extremely precise distance measurement
- Sector-specific factory automation for robotics, assembly and handling, or packaging
- Ranges of up to 60 meters
- Plastic or stainless steel housing in washdown and hygienic designs
- Simple and adaptable setting, programming and installation for your application



Learn more.  
Downloadable data sheets as well as further information  
about our products is available at:  
[www.baumer.com/photoelectric](http://www.baumer.com/photoelectric)





---

## Introduction

Photoelectric miniature sensors	4
Laser light barriers and light sensors	5
Light barriers <i>SmartReflect</i> <sup>®</sup>	6
Photoelectric distance sensors	7
Smart profile sensors – <i>PosCon</i> <sup>®</sup>	8
Vision sensors for automation technology – <i>VeriSens</i> <sup>®</sup>	9
Industry 4.0 – the new standard	10

---

## Light barriers and light sensors

<i>SmartReflect</i> <sup>®</sup> Light barriers	16
Retro-reflective sensors	88
Through beam sensors	178
Fork and angle sensors	234
Diffuse sensor with background suppression	258
Diffuse sensors with intensity difference	362
Color sensors <i>LOGIPAL</i>	418
Contrast sensor	424
Differential sensors	443

---

## Fiber optic sensors and fiber optic cables

Plastic fiber optic sensors	456
Plastic fiber optic cables / Diffuse sensors	473
Plastic fiber optic cables / Through beam sensors	501
Glass fiber optic sensors	533
Glass fiber optic cables / Diffuse sensors	540
Glass fiber optic cables / Through beam sensors	542

---

## Level monitoring and leak detecting sensors

Overview	552
Introduction	554
Liquid level sensors	557
Leakage sensors	563
Divers	564

---

## Edge measurement and detection

Smart width and gap measurement <i>PosCon</i> <sup>®</sup> OXE7	572
Large measuring range ZADM 023	576
Measurement by parallel light beam ZADM 034	584
Copy counters <i>SCATEC</i>	590

---

## Distance sensors

Miniature sensors	624
Performance sensors for automation technology	646
High performance sensors	664
Long range sensors	682
Standard distance sensors	686

---

## Smart profile sensors *PosCon*<sup>®</sup>

Width measurement <i>PosCon</i> <sup>®</sup> OXE7	714
Height measurement <i>PosCon</i> <sup>®</sup> OXH7	716
Measurement of round objects <i>PosCon</i> <sup>®</sup> OXC7	720

---

## *VeriSens*<sup>®</sup> cameras

Introduction	724
Overview	726
Cameras	728

---

## Accessories

Connectors and mating connectors	736
Connectors / Pin assignment	741
Reflectors	742
Divers	748
Mountings	750
Mounting kits <i>Sensofix</i>	754
Hygienic and washdown	756
Fiber optics	758

---

Glossary	763
----------	-----

---

Index	775
-------	-----

# Smart & Small – High performance, extremely compact designs

## Optical miniature sensors

- Extensive miniature sensor portfolio for applications where space is at an absolute premium
- High performance in extremely cramped spaces from 4 mm with integral evaluation electronics with a range of up to 8 m
- All sensors, even the smallest, can be easily and accurately adjusted to the specific application requirements
- Sensors with beam diameters of up to 0.1 mm can detect the smallest objects or identify parts with the utmost precision regardless of color or objects in the background

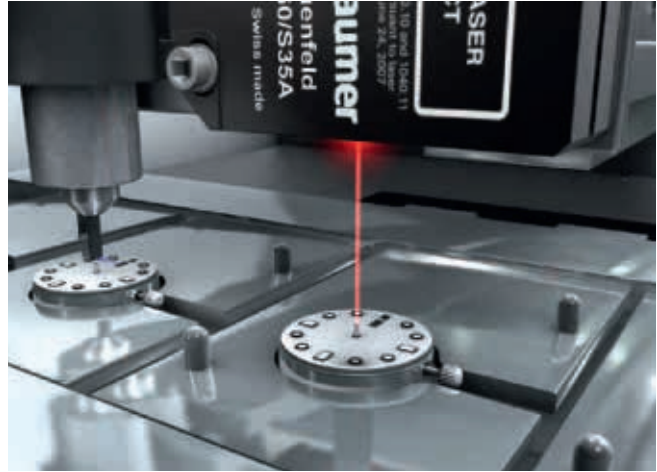

### Distance measuring miniature sensors

- Extremely small laser triangulation distance sensor with integral electronics
- Teachable measuring range of up to 550 mm
- Point laser for extremely small objects or line laser for coarse surfaces
- Highspeed measurements thanks to high measurement rates of 1 kHz

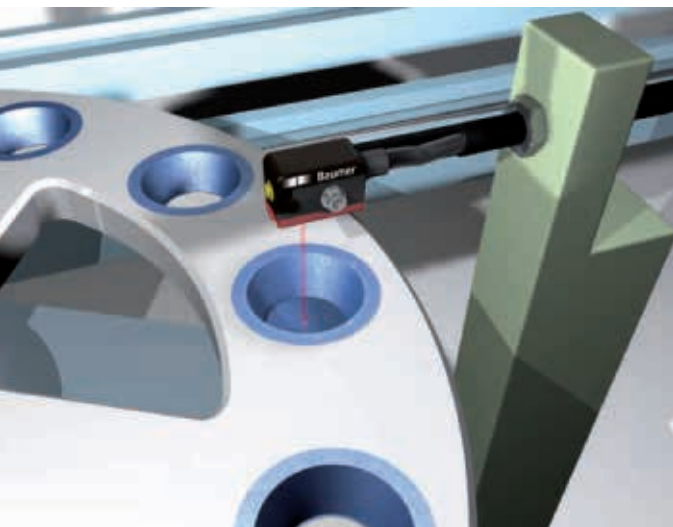

### Leading the global market

- FHDK 04: smallest sensor on the market with real background suppression
- FNxK 07: Smallest line of sensors with an adjustable switching distance
- OHDK 10: laser sensors with background suppression and adjustable sensing distance
- FxDM 08: Miniature sensors for profiled guideways



### Fiber optic sensors and fiber optics

- Detect extremely small objects in narrow and highly inaccessible spaces
- Very small, lightweight sensors for robotics
- Broad range of plastic or glass fiber optics in cubical or cylindrical designs
- Fiber optic sensors in a range of designs and sizes for greater flexibility, wherever they are mounted

# Precise control of fast processes and detection of very small objects

Laser light barriers and light sensors



## O300 miniature laser sensors with added value

- Precision triggering due to very low jitter of <math>< 22 \mu\text{s}</math>
- Safe laser class 1
- Reliable detection of irregular or small objects due to line or point beam geometry
- High repeat accuracy
- IO-Link – Industrie 4.0 and IIoT ready

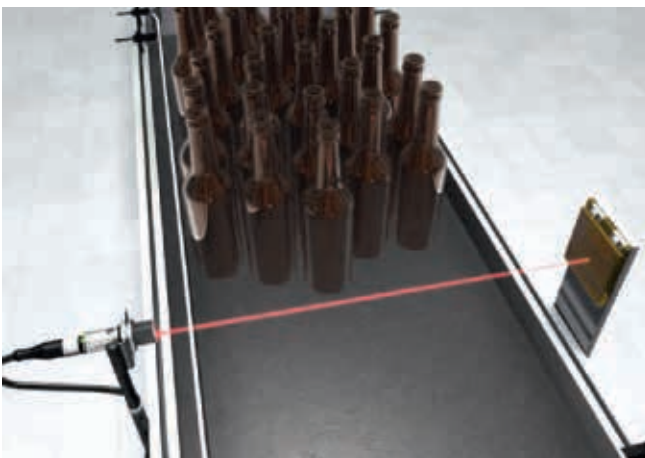

## Cylindrical M18 laser sensors

- Rugged M18 metal housing
- Range of up to 55 m

- Extremely high system performance due to very short response times of <math>< 0.1 \text{ ms}</math> provides rapid, high-precision processing. 0.1 mm laser beam detects extremely small components and differences in position
- Increased product and process quality due to precise detection of small objects from a safe distance and irrespective of their exact position, e.g. on the conveyor belt
- Complete design freedom due to availability in every configuration



## Laser differential sensors

- Detect extremely small objects <math>< 0.2 \text{ mm}</math>
- Tolerance analysis
- Comparison of object sizes and positions
- Stage and edge detection
- High insensitivity to color



# Light barriers without reflectors

SmartReflect®

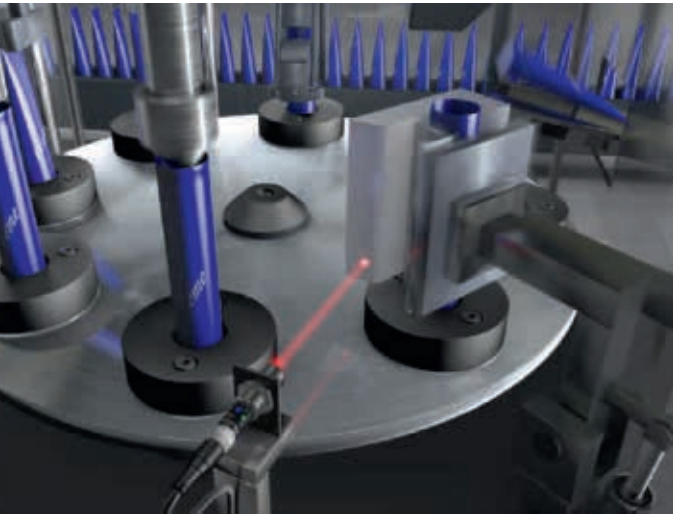

## Cylindrical M18 sensors

- Rugged M18 metal housing
- Baumer PinPoint LED
- Easy, uncomplicated setup with qTeach
- Range of up to 300 mm



## Transparent detection without reflectors

- Reliable detection of bowls, PET bottles and foils
- Short response time of < 0.25 ms
- IO link – Industrie 4.0 and IIoT ready
- Range of up to 1000 mm

- Extremely high plant availability and process security: Highly reliable object detection thanks to the barrier principle and removal of the reflector as a potential source of errors
- Reduced operating costs: Quick installation as no reflector to fit. No need to replace reflectors due to wear
- Increased productivity due to range of up to 1.9 m or 1 m for transparent objects, and short response times of < 0.25 ms. Quick format change, easy sensor replacement and access to additional information via IO-Link

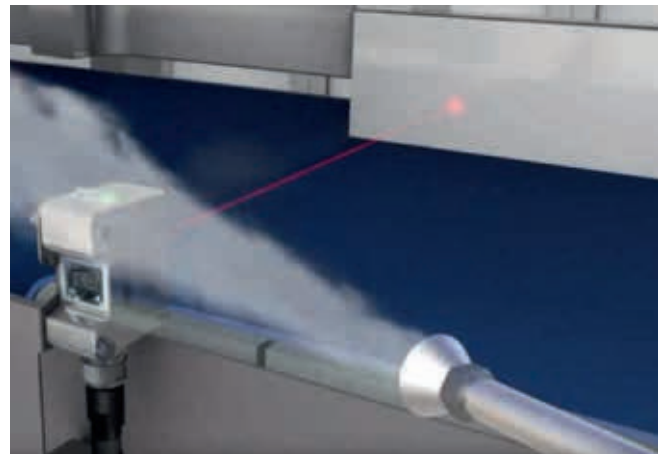

## Stainless steel sensors for demanding environments

- Robust stainless steel housing
- EHEDG-certified, FDA-compliant, Ecolab-tested
- IP 69K and Ecolab-tested
- Long-term seal thanks to proTect+
- Range of up to 1000 mm

# Measure distance, spacing and position even on challenging surfaces

Optical distance sensors



## Miniature sensors

- Extremely small housing with integral microcontroller
- Teachable measuring range of up to 550 mm
- Point laser for extremely small objects or line laser for coarse surfaces
- Safety due to laser class 1 sensors

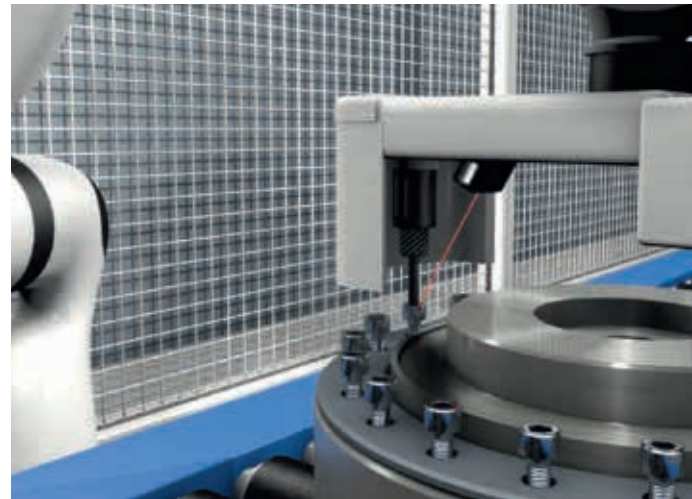

## High Performance

- Rugged M18 metal housing
- Baumer PinPoint LED
- Easy, uncomplicated setup with qTeach
- Range of up to 300 mm

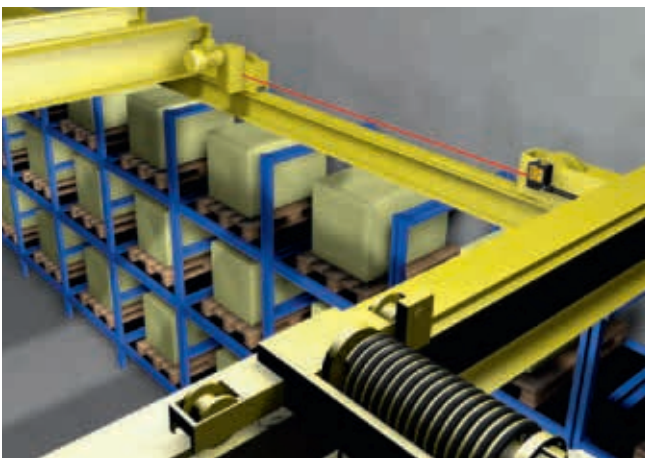

## Long ranges

- Robust stainless steel housing
- EHEDG-certified, FDA-compliant, Ecolab-tested
- IP 69K and Ecolab-tested
- Long-term seal thanks to proTect+
- Range of up to 1000 mm

- Reliable and efficient processes thanks to a range of beam shapes, accurate measurement to the sub-micrometer scale and long ranges
- Durable, robust solutions thanks to rugged housings made of stainless steel, metal and plastic for different applications
- Simple operation and integration Fast, economical initial start-up thanks to Plug & Play
- Factory-calibrated sensors with measuring values displayed in millimeters



# One function – one sensor

## Smart profile sensors – PosCon®

- Compact measuring devices with pre-configured functions for efficient object measurement
- Smart measurement of object heights, edge positions and diameters
- Quick installation with no reflectors
- Easy initial start-up with no external software (plug & measure)
- High accuracy and ambient light immunity



### Easy width measurement – PosCon OXE7

- Measurement of object edges, widths and gaps irrespective of out-of-roundness
- Resolution up to 20  $\mu\text{m}$  and measurement rates up to 550
- Reliable measurement even with out-of-round objects
- Adaptable sensor mounting up to  $\pm 30^\circ$



### Clever height measurement – PosCon OXH7

- Calibrated height measurement, even in rapid processes without precise positioning of the target objects
- High measuring accuracy up to 2  $\mu\text{m}$  even with varying ambient light conditions
- Simple solution for critical check-&-sort applications

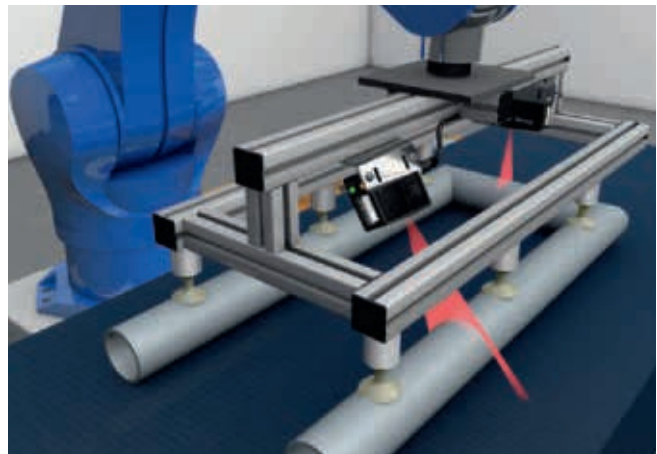

### Measuring round objects – PosCon OXC7

- Smart measurement of circle centers, diameters, top and external positions
- Reliable measurement for accurate positioning tasks and as reference points for inspection tasks
- Simple, adaptable mounting up to  $\pm 30^\circ$  with no reflectors

# Keeping an eye on your quality

Vision sensors for automation technology – *VeriSens*®

## Highlights:

- Simultaneous, image-based quality control of multiple features with a single sensor
- Easy configuration in a few minutes
- Versatile connection options including industrial Ethernet, digital I/Os
- Configurable web interface with *MultiViewer* function
- High process security due to contour-based image processing
- Image-based reading and evaluation

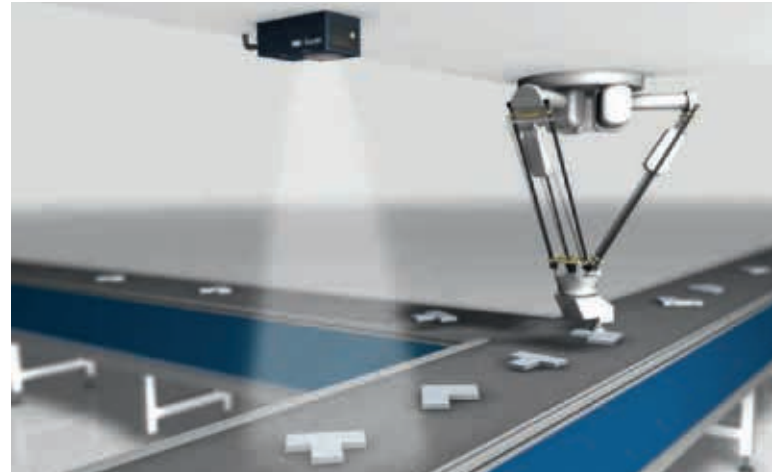

## XC series: Maximum functionality and versatility

- Check all features (up to 22) with one device, including reading code and text
- Automatic part alignment with FEXLoc®
- C-mount connection for interchangeable lens, lens protection due to modular Tube System (IP 67)
- Fully-integrated VeriFlash® flash controller



## XF series: Extended functionality for complex inspection tasks

- Check all available features (up to 22) with one device, including reading code and text
- Automatic part alignment with FEXLoc®
- Integral lighting and lens
- Variants with IP 69K stainless steel housing in washdown design



## ID series: Code reader and text reader

- Image-based checking of 1D/2D codes and plain text (OCR/OCV)
- Simple setup (no font training)
- Integral illumination and lens
- Check static and variable information

# Digitalization starts with the sensor



Sensors accurately capture all sorts of measured values. Valuable additional information is produced by processing the measured values in the sensor. These can be processed through standardized digital communications interfaces such as IO-Link to make significant improvements in business processes.

## Simple integration and maximum flexibility with IO-Link

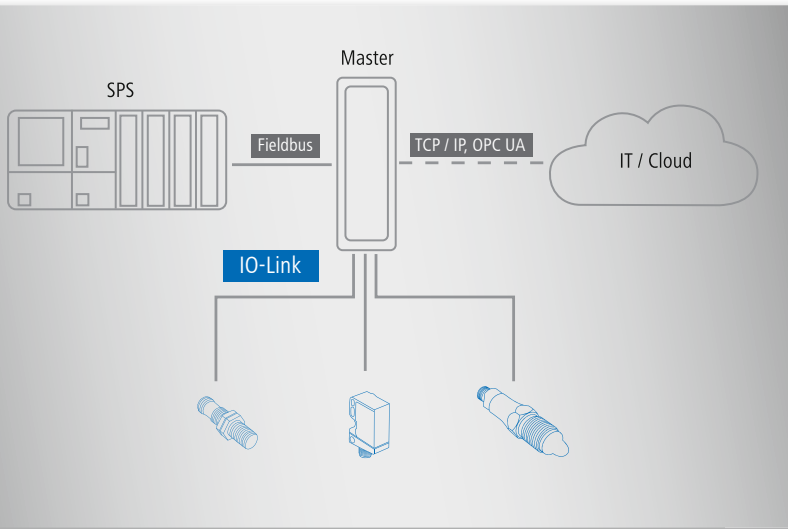

IO-Link is an international standardized IO technology in accordance with IEC 61131-9. It allows digital, bidirectional point-to-point communication irrespective of the manufacturer. Sensors are connected to the IO-Link Master using standard 3-core plug-in cables. IO-Link is available for a wide range of sensor technologies and can also be integrated into small miniature sensors.

The IO-Link Master bundles several sensors together and provides connection to the control via the relevant fieldbus system. An Ethernet-based connection (using OPC UA) from the master unit also provides direct communication between the sensor and IT systems. The maximum cable length between the sensor and the master unit is 20 m. However, significantly longer connections between the sensor and the control can be achieved by connecting to a fieldbus system via a fieldmaster system. This provides maximum flexibility for the connection solution.

## Additional data thanks to digital sensor connections

Data are the fundamental building blocks of process and product optimization. Access can be gained to valuable, extra data by using IO-Link.

**Cyclical data** are transmitted in real time. They service the process control in the automation system and can also be transmitted to other IT systems via IO-Link.

**Non-cyclical data** allow sensors (IO devices) to be configured; analytical and identification data can also be read as required.



### Process data

Measuring distances or switching conditions can be digitally processed and analyzed

Cyclical data

### Analytical data

Data such as signal quality are recorded

Non-cyclical data

### Identification

Data for identifying the sensor such as type of sensor, serial number, application

Cyclical data

### Parameterization

Data for sensor parameterization can be stored and thus quickly multiplied

Non-cyclical data

# The benefits of digitized connections

## Cost-effective & secure connection

- Connection between the sensor and the IO-Link master unit via 3-core standard cabling
- International communications standard, irrespective of manufacturer
- Digital signals are transmitted to the control without losses or conversion costs

## Simple & secure usability

- Intuitive sensor setting and functional monitoring via smart phone, tablet or PC
- Direct integration into engineering tools
- Local parameterization lock option

## Extended setting options

- IO-Link offers additional functionalities and settings such as free selection of switching points, adjustable measuring ranges and filter functions, and much more. This allows the sensor to be configured accurately and reliably to suit the application.



## Quick sensor replacement

- Automatic parameter transfer when replacing sensors

## Increased flexibility

- Simple reparameterization when changing format or recipe during continuous production provides high flexibility with extremely high machine utilization

## Additional data

- Transparency thanks to process data which can also be easily analyzed in IT systems
- Analytical data for monitoring the plant and sensor conditions, e.g. for preventative maintenance
- Identification and parameter data can also be digitally analyzed directly

# OPC UA, Modbus TCP and integral webserver

## Simple integration into existing network structures - Ethernet interface, Modbus TCP IP and OPC UA

Baumer uses Ethernet and other technology in its optical measuring systems for data transfer and network connectivity. This provides quick, simple and, thanks to standard components, economical integration of sensors into existing industrial networks. Rapid, complete and error-free transmission of measured data is a further benefit. The measured data themselves and other additional data can be read and analyzed irrespective of their location. The communication protocols which are currently available are Modbus TCP/IP and OPC UA.

The MODBUS protocol is a very lean protocol which allows process data to be exchanged openly and supports rapid and efficient communication in industrial networks.

OPC UA (Open Platform Communication Unified Architecture) is a modern communications standard for use by any manufacturer which allows sensor data to be exchanged beyond the automation system. This facilitates, for example, the use of information from different systems without significant programming effort and thus optimization of processes.

## Tailor-made measurement solutions - The Baumer web interface for simple configuration and operation



### Simple solutions even for complex measuring tasks

Both simple and complex measuring tasks can be configured and validated quickly and easily via the intuitive Baumer web interface. For complex measurement tasks, extended functionalities, such as the output of the height profile and the camera image, are available for assessing the measurement. The measurements can be recorded and analyzed over time.

### Storage of parameter sets

Up to three parameter settings can be stored in the sensor. The settings can be displayed quickly and easily.



## Process optimization by live visualization and in-depth diagnosis of measured values

### Live visualization and analysis of measured values

The delivered measured values for the selected mode can be monitored and controlled via the web interface. Invalid measured values are displayed immediately. The measured values can be frozen or exported for a more detailed analysis.

### In-depth diagnosis

The unfiltered camera image from the sensor can also be used for a more precise diagnosis of the measuring situation. For example, unwanted reflections can be detected and the alignment can be optimized. The camera image can also be sent directly as a screenshot to Baumer, where expert advice is quickly available.

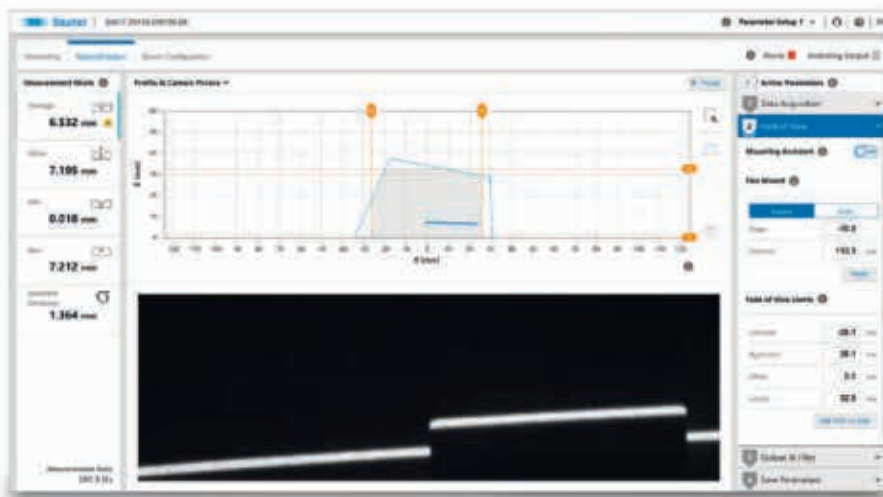

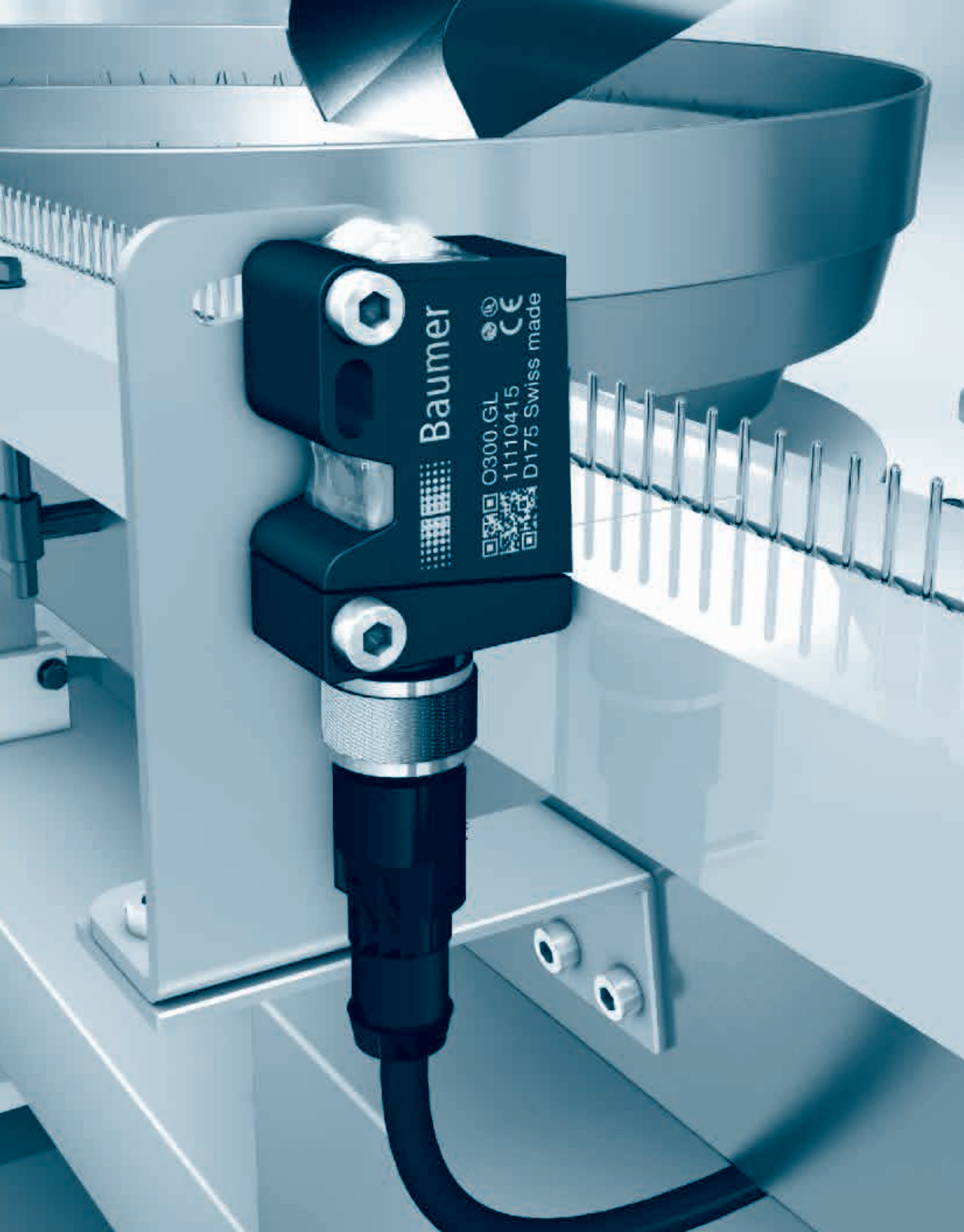

Baumer

O300.GL  
11110415  
D175 Swiss made















## Light barriers and light sensors

<i>SmartReflect</i> <sup>®</sup> Light barriers	Page 16
Retro-reflective sensors	Page 88
Through beam sensors	Page 178
Fork and angle sensors	Page 234
Diffuse sensor with background suppression	Page 258
Diffuse sensors with intensity difference	Page 362
Color sensors <i>LOGIPAL</i>	Page 418
Contrast sensor	Page 424
Differential sensors	Page 443

red light LED version

product family	FNCK 07	FNDK 07	O300.SP	O300.SP	FNDK 14	FNDK 14	O500.SP
							
	<i>MINOS</i>	<i>MINOS</i>					
	subminiature	subminiature	miniature	miniature	standard	standard	standard
version			standard object detection	line beam	standard object detection	standard object detection	standard object detection
width / diameter	8 mm	8 mm	12,9 mm	12,9 mm	14,8 mm	14,8 mm	18 mm
response time / release time	< 0,5 ms	< 0,5 ms	< 0,49 ms	< 1,5 ms	< 0,5 ms	< 1,8 ms	< 0,49 ms
light source	pulsed red LED	pulsed red LED	pulsed PinPoint LED	pulsed PinPoint LED	pulsed red LED	pulsed red LED	pulsed PinPoint LED
sensing distance adjustment	Teach-in	Teach-in	qTeach / external Teach-in and IO-Link qTeach qTeach / 1-Step Teach-in	Teach-in and IO-Link	Teach-in	Teach-in and IO-Link	qTeach / external Teach-in and IO-Link qTeach qTeach / 1-Step Teach-in
output circuit	NPN PNP	NPN PNP	push-pull NPN PNP	push-pull	PNP	push-pull	push-pull NPN PNP
connection types	cable flylead connector	cable flylead connector	cable connector flylead connector	cable connector	connector	cable connector	cable connector flylead connector
housing material	plastic	plastic	plastic	plastic	plastic	plastic	plastic
			 IO-Link	 IO-Link		 IO-Link	 IO-Link
protection class	IP 65	IP 65	IP 67	IP 67	IP 67	IP 67	IP 67
<b>page</b>	<b>26</b>	<b>28</b>	<b>30</b>	<b>34</b>	<b>36</b>	<b>38</b>	<b>40</b>

OR18.SP



standard

standard object  
detection

18 mm

< 0,49 ms

pulsed PinPoint  
LED

qTeach / external  
qTeach

push-pull  
NPN  
PNP

connector









metal

IP 67

44

















laser version

product family	O300.SL	O300.SL	O300W.SL	O300H.SL	ONDK 25
					
version	miniature	miniature	miniature	miniature	standard
width / diameter	12,9 mm	12,9 mm	16,5 mm	16,5 mm	23,4 mm
response time / release time	< 0,25 ms	< 1,5 ms	< 0,25 ms	< 0,25 ms	< 10 ms
light source	pulsed red laser diode	pulsed red laser diode	pulsed red laser diode	pulsed red laser diode	pulsed red laser diode
sensing distance adjustment	Teach-in and IO-Link qTeach	Teach-in and IO-Link	Teach-in and IO-Link	Teach-in and IO-Link	Teach-in
output circuit	push-pull NPN PNP	push-pull	push-pull	push-pull	push-pull
connection types	cable connector	cable connector	connector	cable flylead connector	cable connector
housing material	plastic	plastic	metal	metal	plastic
	 IO-Link	 IO-Link	 IO-Link	 IO-Link	
protection class	IP 67	IP 67	IP 68/69K & proTect+	IP 68/69K & proTect+	IP 67
<b>page</b>	<b>46</b>	<b>48</b>	<b>50</b>	<b>52</b>	<b>54</b>



transparency detection















product family	O300.S.P.T	O300W.S.P.T	O300H.S.P.T	FNDK 14	FNDR 14	FNDH 14	O500.S.P.T
							
version	transparency object detection	transparency object detection	transparency object detection	Tray and bottle detection Foil detection	Tray and bottle detection Foil detection	Tray and bottle detection Foil detection	transparency object detection
width / diameter	12,9 mm	16,5 mm	16,5 mm	14,8 mm	19,6 mm	19,6 mm	18 mm
response time / release time	< 0,25 ms	< 0,25 ms	< 0,25 ms	< 1,8 ms	< 1,8 ms	< 1,8 ms	< 0,25 ms
sensing distance adjustment	Teach-in and IO-Link	Teach-in and IO-Link	Teach-in and IO-Link	Teach-in and IO-Link	Teach-in Teach-in and IO-Link	Teach-in Teach-in and IO-Link	Teach-in and IO-Link
output circuit	push-pull	push-pull	push-pull	push-pull	push-pull	push-pull	push-pull
connection types	cable connector	connector	cable flylead connector	cable connector	connector	cable flylead connector	cable connector
housing material	plastic	metal	metal	plastic	metal	metal	plastic
	 IO-Link	 IO-Link	 IO-Link	 IO-Link	 IO-Link	 IO-Link	 IO-Link
protection class	IP 67	IP 68/69K & proTect+	IP 68/69K & proTect+	IP 67	IP 68/69K & proTect+	IP 68/69K & proTect+	IP 67
<b>page</b>	<b>56</b>	<b>58</b>	<b>60</b>	<b>62</b>	<b>64</b>	<b>66</b>	<b>68</b>

**O500W.S.P.T**    **O500H.S.P.T**



transparency object detection	transparency object detection
20,2 mm	20,2 mm
< 0,25 ms	< 0,25 ms
Teach-in and IO-Link	Teach-in and IO-Link
push-pull connector	push-pull cable flylead connector
metal	metal
IO-Link	IO-Link
IP 68/69K & proTect+	IP 68/69K & proTect+
<b>70</b>	<b>72</b>

stainless steel sensors in washdown or hygienic design

product family	O300W.SP	O300H.SP	FNDR 14	FNDH 14	O500W.SP	O500W.SP (Retro Serie 14)	O500H.SP
							
version	miniature	miniature	standard	standard	standard	standard	standard
width / diameter	16,5 mm	16,5 mm	19,6 mm	19,6 mm	20,2 mm	20,2 mm	20,2 mm
response time / release time	< 0,49 ms	< 0,49 ms	< 1,8 ms	< 1,8 ms	< 0,49 ms	< 0,49 ms	< 0,49 ms
light source	pulsed PinPoint LED	pulsed PinPoint LED	pulsed point source LED	pulsed point source LED	pulsed PinPoint LED	pulsed PinPoint LED	pulsed PinPoint LED
sensing distance adjustment	Teach-in and IO-Link	Teach-in and IO-Link	Teach-in Teach-in and IO-Link	Teach-in Teach-in and IO-Link	Teach-in and IO-Link	Teach-in and IO-Link	Teach-in and IO-Link
output circuit	push-pull	push-pull	push-pull	push-pull	push-pull	push-pull	push-pull
connection types	connector	cable flylead connector	connector	cable flylead connector	connector	connector	cable flylead connector
housing material	metal	metal	metal	metal	metal	metal	metal
	 IO-Link	 IO-Link	 IO-Link	 IO-Link	 IO-Link	 IO-Link	 IO-Link
protection class	IP 68/69K & proTect+	IP 68/69K & proTect+	IP 68/69K & proTect+	IP 68/69K & proTect+	IP 68/69K & proTect+	IP 68/69K & proTect+	IP 68/69K & proTect+
page	74	76	78	80	82	84	86







## General information

With SmartReflect®, Baumer has reinvented the optical light barrier: The reflector as the weak point has been eliminated, and highly reliable object detection is still guaranteed. This reduces your costs tremendously. Since every interruption of the light beam by any object is detected thanks to the SmartReflect® principle, the SmartReflect® light barrier can reliably detect objects irrespective of their shape, color or surface finish.

## Applications

- Presence check of object in processes irrespective of the precise position of the object
- Extremely rapid and precise position detection, even for extremely small objects
- Application in robotics and electronic components
- Automated and configurable object detection, e.g. in format adjustments
- Capture objects, even at large distances
- Reliable counting of objects, even at extremely small distances
- Extremely accurate referencing of movements
- Recognition of different object materials, surfaces and colors, even on transparent, uneven, pitted or rough surfaces
- Monitoring of gradual changes in production processes and automated testing

## Characteristics and advantages

Extremely high unit availability and process security

- Highly reliable object detection thanks to the sensor principle
- Elimination of the reflector as a potential source of error
- No function impairment from dirt accumulation
- Available in robust washdown or hygienic design

Reduction of operating costs

- Quick installation as no reflector to fit
- No need to replace reflectors due to wear
- Expensive reflector cleaning not required

Increase in productivity

- Range up to 1.9 m or 1 m for transparent objects
- High machine performance thanks to short response times of < 0.25 ms
- Quick change of format, easy sensor replacement and access to additional information via IO link



## Technology and operation

Contrary to diffuse or through beam sensors, SmartReflect light barriers feature a closed light beam which is set up between the sensor and machine. The sensor switches when an object interrupts the light beam. The only requirement is the presence of a defined background, e.g. a machine part, within the sensing range of the sensor, which closes the light beam.

## Mounting and adjustment

The SmartReflect light barrier has to be aligned with a machine part within its sensing range. This machine part is then set using the teach-in.

It should be noted that there is a dead band directly in front of the machine part that is set automatically during teach-in. The dead band is determined by the specification of the sensing range (Sa) as a percentage (%) of the background position (Sde).

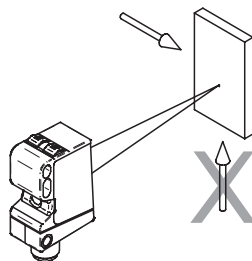

It should be noted that an object to be detected must approach the active range of the sensor from the side in order to avoid switching errors.

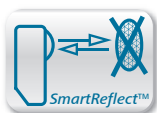

Sde = 10 ... 45 mm



- compact housing with cable rear side
- sensing distance adjustable via Teach-in
- suppression of mutual interference

**general data**

type	light barrier
light source	pulsed red LED
background position Sde	17 ... 45 mm
scanning range Sa	82% Sde
light indicator	LED green
output indicator	LED yellow
sensing distance adjustment	Teach-in
wave length	660 nm
suppression of reciprocal influence	yes

**electrical data**

response time / release time	< 0,5 ms
voltage supply range +Vs	10 ... 30 VDC
current consumption max. (no load)	25 mA
current consumption typ.	20 mA
voltage drop Vd	< 1,8 VDC
output function	light / dark operate
output current	< 100 mA
short circuit protection	yes
reverse polarity protection	yes

**mechanical data**

width / diameter	8 mm
height / length	16,2 mm
depth	10,8 mm
type	rectangular
housing material	plastic (PMMA, MABS, PA)
front (optics)	PMMA

**ambient conditions**

operating temperature	-20 ... +50 °C
protection class	IP 65

**connection diagrams****connectors and mating connectors**

ESG 32AH0200	Connector M8, 4 pin, straight, 2 m
ESW 31AH0200	Connector M8, 4 pin, angular, 2 m

additional cable connectors and field wireable connectors: see accessories

**Accessories**

10150844	Minofix mounting 07
----------	---------------------

for details: see accessories section

order reference	connection types	output circuit
FNCK 07N6910	cable rear side, 2 m	NPN
FNCK 07N6910/KS35A	flylead connector M8 4 pin, L=200 mm	NPN
FNCK 07P6910	cable rear side, 2 m	PNP
FNCK 07P6910/KS35A	flylead connector M8 4 pin, L=200 mm	PNP

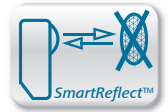

dimension drawings

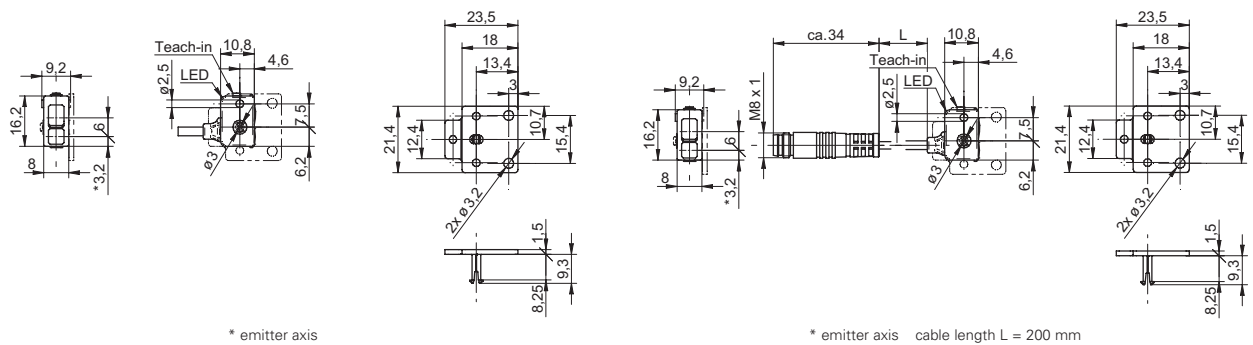

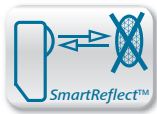

Sde = 10 ... 45 mm



- compact housing with cable bottom side
- sensing distance adjustable via Teach-in
- suppression of mutual interference

**general data**

type	light barrier
light source	pulsed red LED
background position Sde	17 ... 45 mm
scanning range Sa	82% Sde
light indicator	LED green
output indicator	LED yellow
sensing distance adjustment	Teach-in
wave length	660 nm
suppression of reciprocal influence	yes

**electrical data**

response time / release time	< 0,5 ms
voltage supply range +Vs	10 ... 30 VDC
current consumption max. (no load)	25 mA
current consumption typ.	20 mA
voltage drop Vd	< 1,8 VDC
output function	light / dark operate
output current	< 100 mA
short circuit protection	yes
reverse polarity protection	yes

**mechanical data**

width / diameter	8 mm
height / length	16,2 mm
depth	10,8 mm
type	rectangular
housing material	plastic (PMMA, MABS, PA)
front (optics)	PMMA

**ambient conditions**

operating temperature	-20 ... +50 °C
protection class	IP 65

**connection diagrams****connectors and mating connectors**

ESG 32AH0200	Connector M8, 4 pin, straight, 2 m
ESW 31AH0200	Connector M8, 4 pin, angular, 2 m

additional cable connectors and field wireable connectors: see accessories

**Accessories**

10150844	Minofix mounting 07
----------	---------------------

for details: see accessories section

order reference	connection types	output circuit
FNDK 07N6910	cable bottom side, 2 m	NPN
FNDK 07N6910/KS35A	flylead connector M8 4 pin, L=200 mm	NPN
FNDK 07P6910	cable bottom side, 2 m	PNP
FNDK 07P6910/KS35A	flylead connector M8 4 pin, L=200 mm	PNP



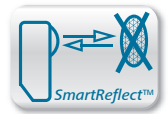

dimension drawings

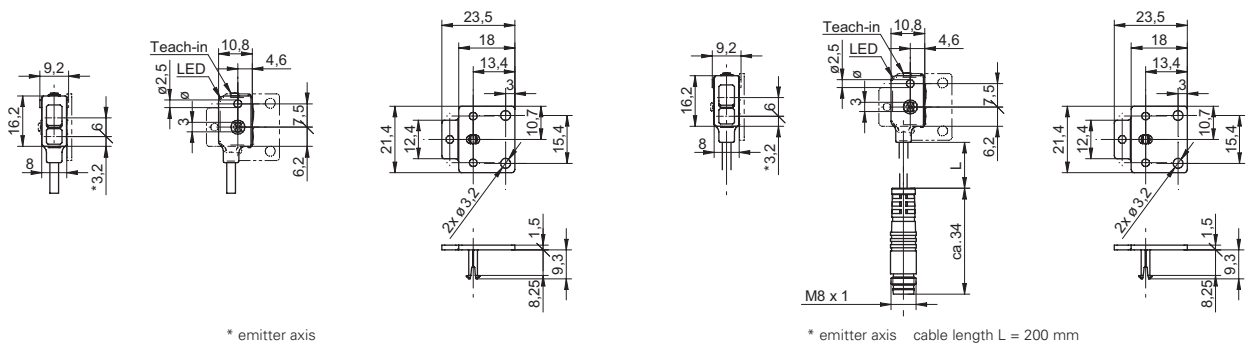

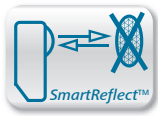

Sde = 30 ... 300 mm



- One inch class
- PinPoint LED
- IO-Link



**general data**

type	light barrier
version	standard object detection
light source	pulsed PinPoint LED
background position Sde	30 ... 300 mm
scanning range Sa	90% ... 85% Sde
power on indication	LED green
light indicator	LED yellow
wave length	630 nm
suppression of reciprocal influence	yes
alignment optical axis	< 2°

**electrical data**

response time / release time	< 0,49 ms
voltage supply range +Vs	10 ... 30 VDC
current consumption max. (no load)	45 mA
current consumption typ.	30 mA
voltage drop Vd	< 3 VDC
output function	light / dark operate
output current	< 100 mA
short circuit protection	yes
reverse polarity protection	yes

**mechanical data**

width / diameter	12,9 mm
height / length	32,3 mm
depth	23 mm
type	rectangular
housing material	plastic (ASA, PMMA)
front (optics)	PMMA

**ambient conditions**

operating temperature	-25 ... +60 °C
protection class	IP 67

**connection diagrams**

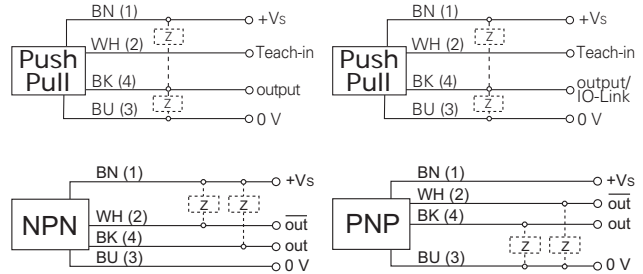

**connectors and mating connectors**

ESG 32AH0200	Connector M8, 4 pin, straight, 2 m
ESW 31AH0200	Connector M8, 4 pin, angular, 2 m
ESG 34AH0200	Connector M12, 4 pin, straight, 2 m
ESW 33AH0200	Connector M12, 4 pin, angular, 2 m

additional cable connectors and field wireable connectors: see accessories

**Accessories**

11104963	Sensofix O300
11102423	Mounting bracket O300 (L design)
11124807	Mounting bracket O300 - Retrofit for sensors series 20

for details: see accessories section

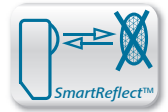

order reference	connection types	output circuit	sensing distance adjustment
<b>O300.SP-11120122</b>	cable 4 pin, 2 m	push-pull	qTeach / external
<b>O300.SP-11110450</b>	connector M8 4 pin	push-pull	qTeach / external
<b>O300.SP-11140097</b>	flylead connector M8, L=200 mm	push-pull	qTeach / external
<b>O300.SP-11139109</b>	flylead connector M12, L=200 mm	push-pull	qTeach / external
<b>O300.SP-11125077</b>	cable 4 pin, 2 m	push-pull	Teach-in and IO-Link
<b>O300.SP-11125057</b>	connector M8 4 pin	push-pull	Teach-in and IO-Link
<b>O300.SP-11120126</b>	cable 4 pin, 2 m	NPN complementary	qTeach
<b>O300.SP-11135851</b>	cable 4 pin, 2 m	NPN complementary	qTeach / 1-Step Teach-in
<b>O300.SP-11135852</b>	connector M8 4 pin	NPN complementary	qTeach / 1-Step Teach-in
<b>O300.SP-11110453</b>	connector M8 4 pin	NPN complementary	qTeach
<b>O300.SP-11120123</b>	cable 4 pin, 2 m	PNP complementary	qTeach
<b>O300.SP-11135854</b>	cable 4 pin, 2 m	PNP complementary	qTeach / 1-Step Teach-in
<b>O300.SP-11135855</b>	connector M8 4 pin	PNP complementary	qTeach / 1-Step Teach-in
<b>O300.SP-11110451</b>	connector M8 4 pin	PNP complementary	qTeach

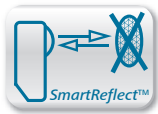

beam characteristics (typically)

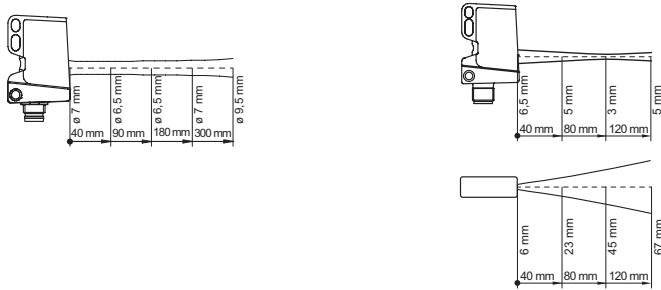

dimension drawings

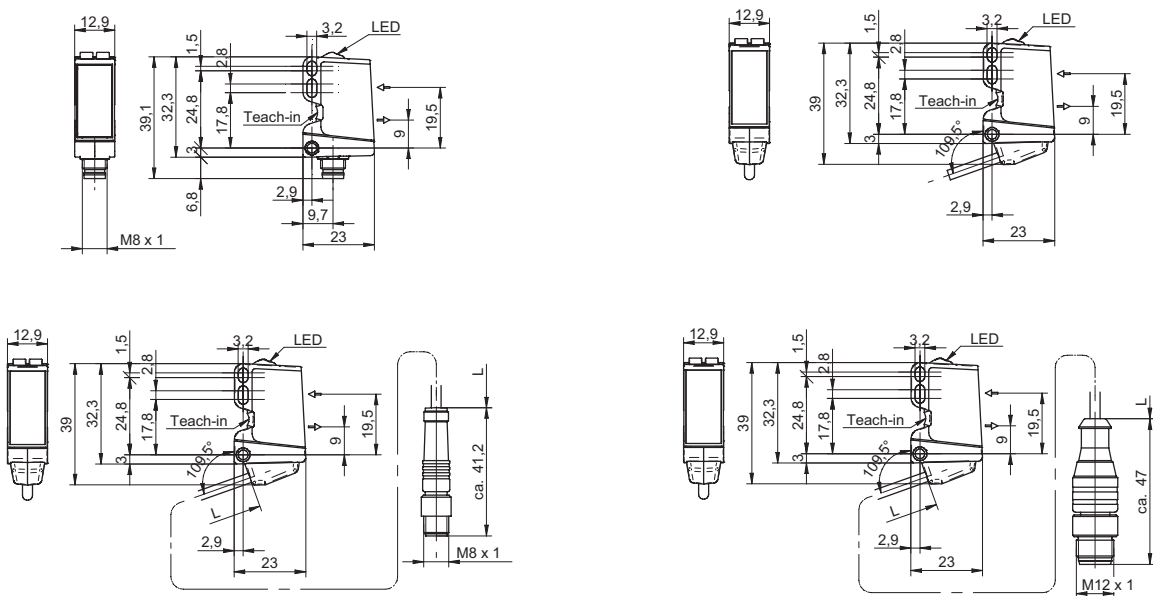

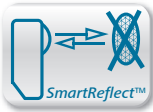

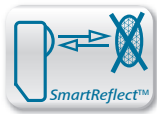

Sde = 30 ... 120 mm



- One inch class
- PinPoint LED
- line 5 x 67 mm



**general data**

type	light barrier
version	line beam
light source	pulsed PinPoint LED
background position Sde	30 ... 120 mm
scanning range Sa	90% ... 85% Sde
power on indication	LED green
light indicator	LED yellow
sensing distance adjustment	Teach-in and IO-Link
wave length	630 nm
suppression of reciprocal influence	yes
beam type	line
alignment optical axis	< 2°

**electrical data**

response time / release time	< 1,5 ms
voltage supply range +Vs	10 ... 30 VDC
current consumption max. (no load)	45 mA
current consumption typ.	30 mA
voltage drop Vd	< 3 VDC
output function	light / dark operate
output circuit	push-pull
output current	< 100 mA
short circuit protection	yes
reverse polarity protection	yes

**mechanical data**

width / diameter	12,9 mm
height / length	32,3 mm
depth	23 mm
type	rectangular
housing material	plastic (ASA, PMMA)
front (optics)	PMMA

**ambient conditions**

operating temperature	-25 ... +60 °C
protection class	IP 67

**order reference**                      **connection types**

O300.SP-11199073	cable 4 pin, 2 m
O300.SP-11199086	connector M8 4 pin

**connection diagrams**

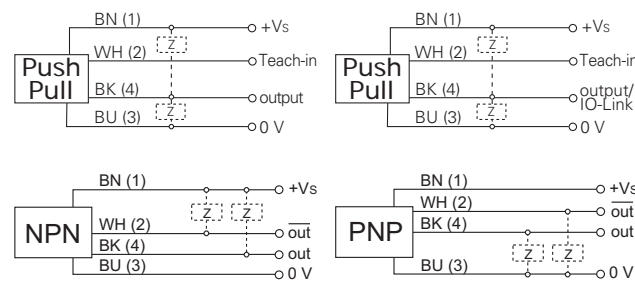

**connectors and mating connectors**

ESG 32AH0200	Connector M8, 4 pin, straight, 2 m
ESW 31AH0200	Connector M8, 4 pin, angular, 2 m

additional cable connectors and field wireable connectors: see accessories

**Accessories**

11104963	Sensofix O300
11102423	Mounting bracket O300 (L design)
11124807	Mounting bracket O300 - Retrofit for sensors series 20

for details: see accessories section

O300.SP Sde = 30 ... 120 mm

SmartReflect Light barriers



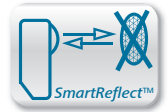

beam characteristics (typically)

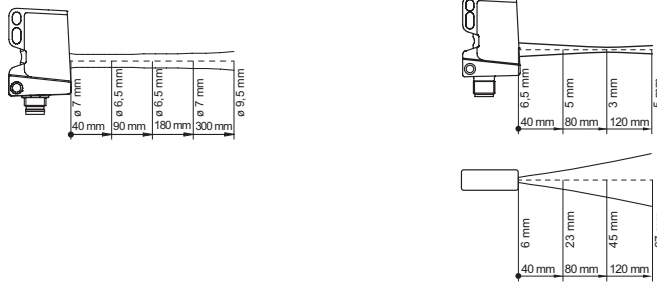

dimension drawings

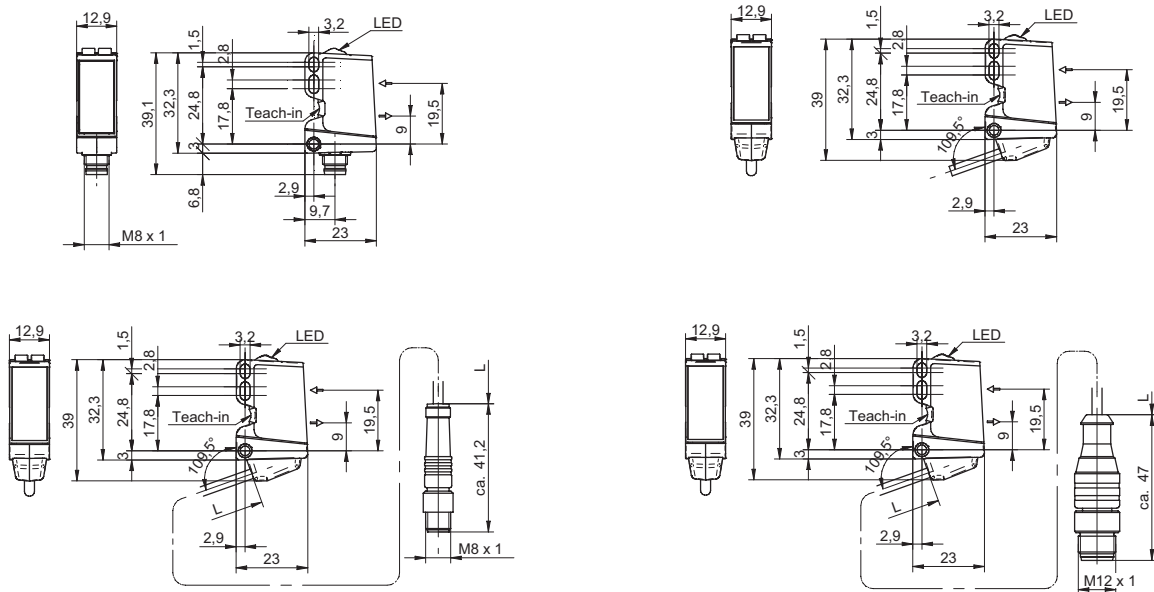

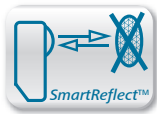

Sde = 55 ... 200 mm



- short response time
- sensing distance adjustable via Teach-in

**general data**

type	light barrier
version	standard object detection
light source	pulsed red LED
background position Sde	60 ... 200 mm
scanning range Sa	90% Sde
light indicator	LED green
output indicator	LED yellow
sensing distance adjustment	Teach-in
wave length	660 nm
suppression of reciprocal influence	yes

**electrical data**

response time / release time	< 0,5 ms
voltage supply range +Vs	10 ... 30 VDC
current consumption max. (no load)	40 mA
current consumption typ.	35 mA
voltage drop Vd	< 1,8 VDC
output function	light / dark operate
output circuit	PNP
output current	< 100 mA
short circuit protection	yes
reverse polarity protection	yes

**mechanical data**

width / diameter	14,8 mm
height / length	43 mm
depth	31 mm
type	rectangular
housing material	plastic (ASA, MABS)
front (optics)	PMMA

**ambient conditions**

operating temperature	-25 ... +65 °C
protection class	IP 67

**connection diagram****connectors and mating connectors**

ESG 34AH0200	Connector M12, 4 pin, straight, 2 m
ESW 33AH0200	Connector M12, 4 pin, angular, 2 m
ESG 32AH0200	Connector M8, 4 pin, straight, 2 m
ESW 31AH0200	Connector M8, 4 pin, angular, 2 m

additional cable connectors and field wireable connectors: see accessories

**Accessories**

10149011	Sensofix series 14
10134964	Mounting bracket series 14 (L design)

for details: see accessories section

**order reference**

**FNDK 14P6910/S14**  
**FNDK 14P6910/S35A**

**connection types**

connector M12 4 pin  
connector M8 4 pin

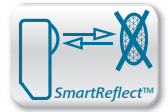

dimension drawings

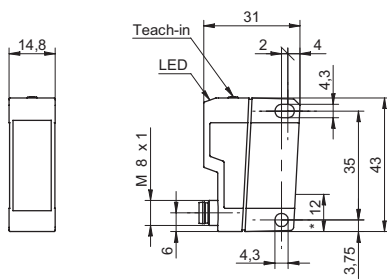

\* emitter axis

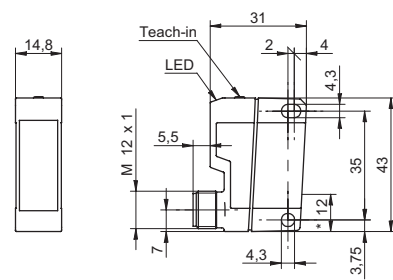

\* emitter axis

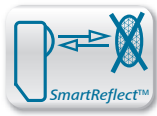

Sde = 50 ... 800 mm

- short response time
- sensing distance adjustable via Teach-in
- IO-Link

**general data**

type	light barrier
version	standard object detection
light source	pulsed red LED
background position Sde	50 ... 800 mm on V4A
scanning range Sa	96% Sde
alignment / soiled lens indicator	flashing light indicator
power on indication	LED green
output indicator	LED red
sensing distance adjustment	Teach-in and IO-Link
wave length	660 nm

**electrical data**

response time / release time	< 1,8 ms
voltage supply range +Vs	10 ... 30 VDC
current consumption max. (no load)	35 mA
current consumption typ.	30 mA
voltage drop Vd	< 2 VDC
output function	light / dark operate
output circuit	push-pull
output current	< 100 mA
short circuit protection	yes
reverse polarity protection	yes

**mechanical data**

width / diameter	14,8 mm
height / length	43 mm
depth	31 mm
type	rectangular
housing material	plastic (ASA, MABS)
front (optics)	PMMA

**ambient conditions**

operating temperature	-30 ... +60 °C
protection class	IP 67

**order reference**

<b>FNDK 14G6904/IO</b>	cable 4 pin, 2 m
<b>FNDK 14G6904/S14/IO</b>	connector M12 4 pin
<b>FNDK 14G6904/S35A/IO</b>	connector M8 4 pin

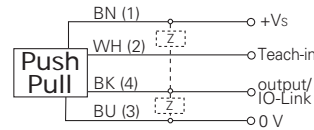
**connection types****connection diagram****connectors and mating connectors**

ESG 34AH0200	Connector M12, 4 pin, straight, 2 m
ESW 33AH0200	Connector M12, 4 pin, angular, 2 m
ESG 32AH0200	Connector M8, 4 pin, straight, 2 m
ESW 31AH0200	Connector M8, 4 pin, angular, 2 m

additional cable connectors and field wireable connectors: see accessories

**Accessories**

10149011	Sensofix series 14
10134964	Mounting bracket series 14 (L design)

for details: see accessories section



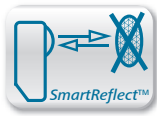

Sde = 60 ... 600 mm

IO-Link

- PinPoint LED
- IO-Link
- qTeach



**general data**

type	light barrier
version	standard object detection
light source	pulsed PinPoint LED
background position Sde	60 ... 600 mm
scanning range Sa	90% ... 85% Sde
power on indication	LED green
light indicator	LED yellow
wave length	630 nm
suppression of reciprocal influence	yes
alignment optical axis	< 1°

**electrical data**

response time / release time	< 0,49 ms
voltage supply range +Vs	10 ... 30 VDC
current consumption max. (no load)	40 mA
current consumption typ.	30 mA
voltage drop Vd	< 3 VDC
output function	light / dark operate
output current	< 100 mA
short circuit protection	yes
reverse polarity protection	yes

**mechanical data**

width / diameter	18 mm
height / length	45 mm
depth	32 mm
type	rectangular
housing material	plastic (ASA, PMMA)
front (optics)	PMMA

**ambient conditions**

operating temperature	-25 ... +60 °C
protection class	IP 67

**connection diagrams**

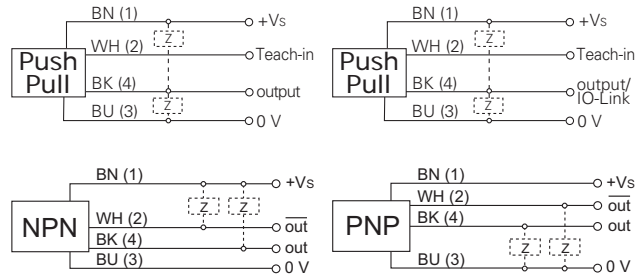

**connectors and mating connectors**

ESG 34AH0200 Connector M12, 4 pin, straight, 2 m

ESW 33AH0200 Connector M12, 4 pin, angular, 2 m

additional cable connectors and field wireable connectors: see accessories

**Accessories**

11099942	Sensofix O500/U500
11092246	Mounting bracket O500/U500 (L design)
11111164	Mounting bracket O500/U500 - Retrofit for sensors series 30

for details: see accessories section



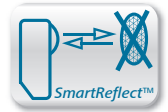

order reference	connection types	output circuit	sensing distance adjustment
<b>O500.SP-11096085</b>	cable 4 pin, 2 m	push-pull	qTeach / external
<b>O500.SP-11096080</b>	connector M12 4 pin	push-pull	qTeach / external
<b>O500.SP-11139106</b>	flylead connector M12, L=200 mm	push-pull	qTeach / external
<b>O500.SP-11125089</b>	cable 4 pin, 2 m	push-pull	Teach-in and IO-Link
<b>O500.SP-11125082</b>	connector M12 4 pin	push-pull	Teach-in and IO-Link
<b>O500.SP-11096088</b>	cable 4 pin, 2 m	NPN complementary	qTeach
<b>O500.SP-11135865</b>	cable 4 pin, 2 m	NPN complementary	qTeach / 1-Step Teach-in
<b>O500.SP-11135866</b>	connector M12 4 pin	NPN complementary	qTeach / 1-Step Teach-in
<b>O500.SP-11096083</b>	connector M12 4 pin	NPN complementary	qTeach
<b>O500.SP-11096086</b>	cable 4 pin, 2 m	PNP complementary	qTeach
<b>O500.SP-11135867</b>	cable 4 pin, 2 m	PNP complementary	qTeach / 1-Step Teach-in
<b>O500.SP-11135869</b>	connector M12 4 pin	PNP complementary	qTeach / 1-Step Teach-in
<b>O500.SP-11096081</b>	connector M12 4 pin	PNP complementary	qTeach

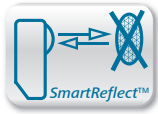

beam characteristic (typically)

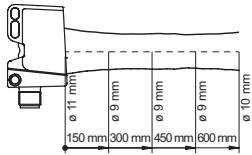

dimension drawings

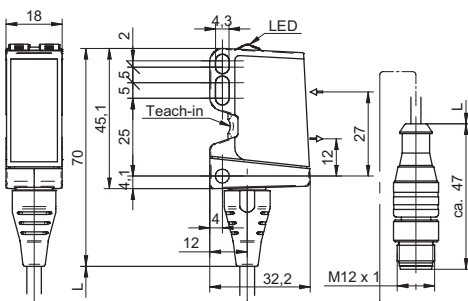
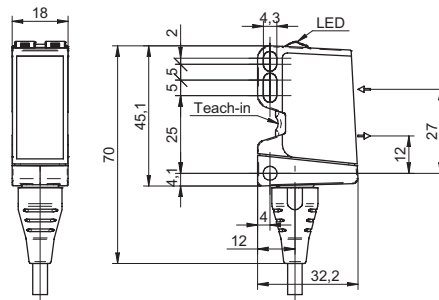
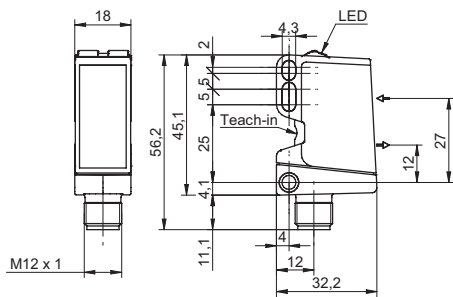

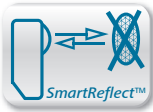

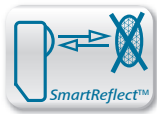

Sde = 55 ... 300 mm



- PinPoint LED
- qTeach
- short response time

**general data**

type	light barrier
version	standard object detection
light source	pulsed PinPoint LED
background position Sde	55 ... 300 mm
scanning range Sa	90% ... 85% Sde
light indicator	LED green
output indicator	LED yellow
wave length	630 nm
suppression of reciprocal influence	yes

**electrical data**

response time / release time	< 0,49 ms
voltage supply range +Vs	10 ... 30 VDC
current consumption max. (no load)	45 mA
current consumption typ.	30 mA
voltage drop Vd	< 3 VDC
output function	light / dark operate
output current	< 100 mA
short circuit protection	yes
reverse polarity protection	yes

**mechanical data**

width / diameter	18 mm
height / length	65 mm
type	cylindrical threaded
housing material	brass nickel plated
front (optics)	PA
connection types	connector M12 4 pin

**ambient conditions**

operating temperature	-25 ... +60 °C
protection class	IP 67

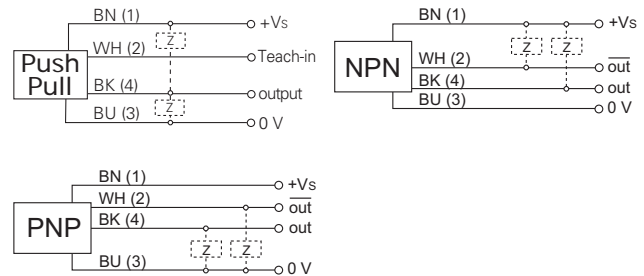
**connection diagrams****connectors and mating connectors**

ESG 34AH0200 Connector M12, 4 pin, straight, 2 m

ESW 33AH0200 Connector M12, 4 pin, angular, 2 m

additional cable connectors and field wireable connectors: see accessories

**Accessories**

10151658	Sensofix series 18
ZADAP-M18.STANDARD	Mounting bracket series 18
ZADAP-M18.SHORT	Mounting bracket short series 18 (L design)
ZADAP-M18.LONG	Mounting bracket long series 18 (L design)
ZADAP-M18.SWING	Mounting bracket for adjustment for sensors series 18
ZADAP-M18.MICRO	Mounting bracket for adjustment for sensors series 18

for details: see accessories section

order reference	output circuit	sensing distance adjustment
OR18.SP-11128095	push-pull	qTeach / external
OR18.SP-11129342	NPN complementary	qTeach
OR18.SP-11129340	PNP complementary	qTeach

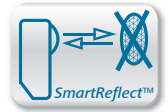

**beam characteristic (typically)**

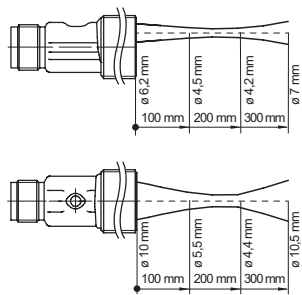

**dimension drawing**

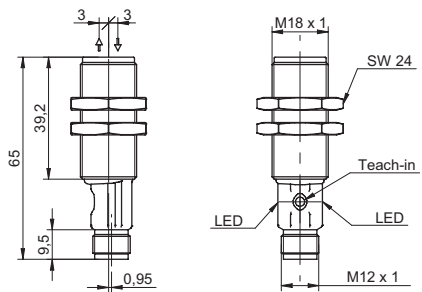

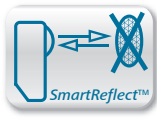

Sde = 30 ... 250 mm



- One inch class
- laser diode
- very small beam diameter



**general data**

type	light barrier
version	standard object detection
light source	pulsed red laser diode
background position Sde	30 ... 250 mm
scanning range Sa	90% ... 85% Sde
repeat accuracy	< 0,1 mm at 100 mm
power on indication	LED green
light indicator	LED yellow
laser class	1
distance to focus	400 mm
wave length	656 nm
suppression of reciprocal influence	yes
alignment optical axis	< 2°

**electrical data**

response time / release time	< 0,25 ms
voltage supply range +Vs	11 ... 30 VDC
current consumption max. (no load)	30 mA
current consumption typ.	25 mA
voltage drop Vd	< 2,5 VDC
output function	light / dark operate
output current	< 100 mA
short circuit protection	yes
reverse polarity protection	yes

**mechanical data**

width / diameter	12,9 mm
height / length	32,3 mm
depth	23 mm
type	rectangular
housing material	plastic (ASA, PMMA)
front (optics)	PMMA

**ambient conditions**

operating temperature	-10 ... +60 °C
protection class	IP 67

**connection diagrams**

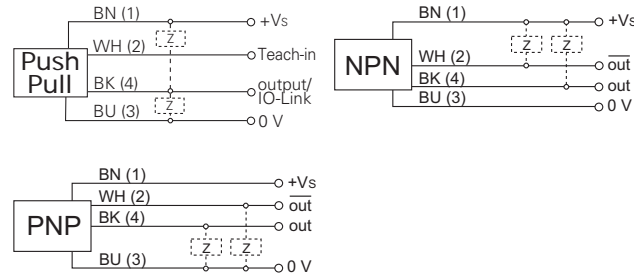

**connectors and mating connectors**

ESG 32AH0200	Connector M8, 4 pin, straight, 2 m
ESW 31AH0200	Connector M8, 4 pin, angular, 2 m

additional cable connectors and field wireable connectors: see accessories

**Accessories**

11104963	Sensofix O300
11102423	Mounting bracket O300 (L design)
11124807	Mounting bracket O300 - Retrofit for sensors series 20

for details: see accessories section

**laser warning**



IEC 60825-1/2014  
Complies with 21 CFR 1040.10 and 1040.11  
except for deviations pursuant to laser  
notice No. 50, dated June 24, 2007

order reference	connection types	output circuit	sensing distance adjustment
O300.SL-11176826	cable 4 pin, 2 m	push-pull	Teach-in and IO-Link
O300.SL-11176827	connector M8 4 pin	push-pull	Teach-in and IO-Link
O300.SL-11179003	cable 4 pin, 2 m	NPN complementary	qTeach
O300.SL-11179004	connector M8 4 pin	NPN complementary	qTeach
O300.SL-11179005	cable 4 pin, 2 m	PNP complementary	qTeach
O300.SL-11179006	connector M8 4 pin	PNP complementary	qTeach



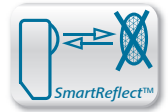

## beam characteristics (typically)

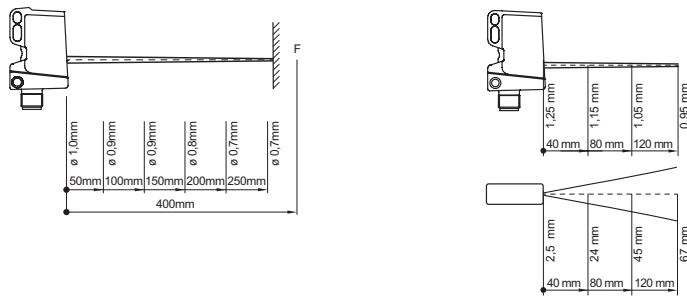

## dimension drawings



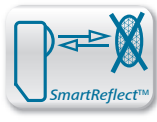

Tw = 30 ... 120 mm



- One inch class
- laser diode
- line 0,95 x 67 mm

### general data

type	light barrier
version	line beam
light source	pulsed red laser diode
background position Sde	30 ... 120 mm
scanning range Sa	90% ... 85% Sde
power on indication	LED green
light indicator	LED yellow
sensing distance adjustment	Teach-in and IO-Link
laser class	1
distance to focus	400 mm
wave length	656 nm
suppression of reciprocal influence	yes
beam type	line
alignment optical axis	< 2°

### electrical data

response time / release time	< 1,5 ms
voltage supply range +Vs	11 ... 30 VDC
current consumption max. (no load)	30 mA
current consumption typ.	25 mA
voltage drop Vd	< 2,5 VDC
output function	light / dark operate
output circuit	push-pull
output current	< 100 mA
short circuit protection	yes
reverse polarity protection	yes

### mechanical data

width / diameter	12,9 mm
height / length	32,3 mm
depth	23 mm
type	rectangular
housing material	plastic (ASA, PMMA)
front (optics)	PMMA

### ambient conditions

operating temperature	-10 ... +60 °C
protection class	IP 67

### order reference

order reference	connection types
O300.SL-11199074	cable 4 pin, 2 m
O300.SL-11199075	connector M8 4 pin

### connection diagrams

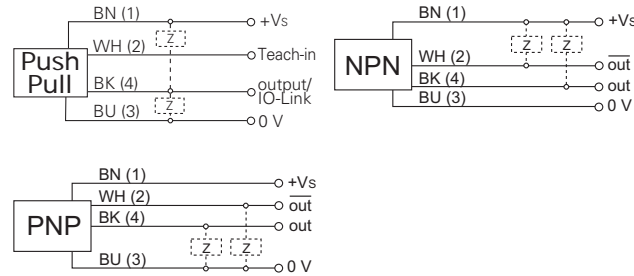

### connectors and mating connectors

ESG 32AH0200	Connector M8, 4 pin, straight, 2 m
ESW 31AH0200	Connector M8, 4 pin, angular, 2 m

additional cable connectors and field wireable connectors: see accessories

### Accessories

11104963	Sensofix O300
11102423	Mounting bracket O300 (L design)
11124807	Mounting bracket O300 - Retrofit for sensors series 20

for details: see accessories section

### laser warning



IEC 60825-1/2014  
Complies with 21 CFR 1040.10 and 1040.11  
except for deviations pursuant to laser  
notice No. 50, dated June 24, 2007

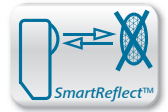

## beam characteristics (typically)

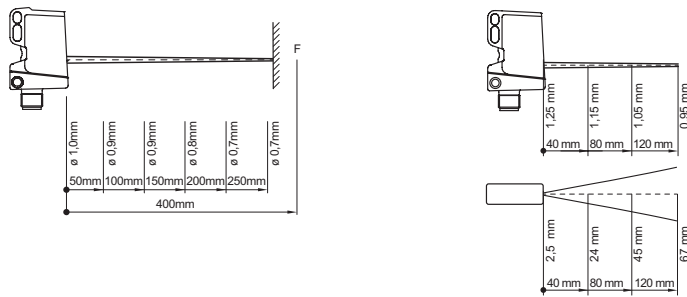

## dimension drawings



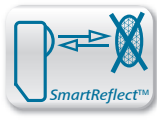

Sde = 30 ... 250 mm



- One inch class
- washdown design
- laser diode

**general data**

type	light barrier
special type	Washdown design
version	standard object detection
light source	pulsed red laser diode
background position Sde	30 ... 250 mm
scanning range Sa	90% ... 85% Sde
repeat accuracy	< 0,1 mm at 100 mm
power on indication	LED green
light indicator	LED yellow
sensing distance adjustment	Teach-in and IO-Link
laser class	1
distance to focus	400 mm
wave length	656 nm
suppression of reciprocal influence	yes
alignment optical axis	< 2°
approvals/certificates	Ecolab

**electrical data**

response time / release time	< 0,25 ms
voltage supply range +Vs	11 ... 30 VDC
current consumption max. (no load)	30 mA
current consumption typ.	25 mA
voltage drop Vd	< 2,5 VDC
output function	light / dark operate
output circuit	push-pull
output current	< 100 mA
short circuit protection	yes
reverse polarity protection	yes

**mechanical data**

width / diameter	16,5 mm
height / length	34,7 mm
depth	28,2 mm
type	rectangular
housing material	stainless steel 1.4404 (V4A)
front (optics)	PMMA
connection types	connector M8 4 pin

**ambient conditions**

operating temperature	-10 ... +60 °C
protection class	IP 68/69K & proTect+

**order reference**

O300W.SL-11179009

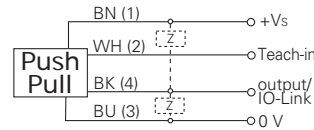
**connection diagram****connectors and mating connectors**

ESG 32AY0200	Connector M8, 4 pin, straight, 2 m, V4A-PP
ESW 31AY0200	Connector M8, 4 pin, angular, 2 m, V4A-PP

additional cable connectors and field wireable connectors: see accessories

**Accessories**

11104963	Sensofix O300
11102423	Mounting bracket O300 (L design)
11124807	Mounting bracket O300 - Retrofit for sensors series 20

for details: see accessories section

**laser warning**

**CLASS 1 LASER  
PRODUCT**

IEC 60825-1/2014  
Complies with 21 CFR 1040.10 and 1040.11  
except for deviations pursuant to laser  
notice No. 50, dated June 24, 2007

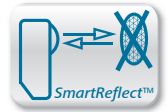

beam characteristic (typically)

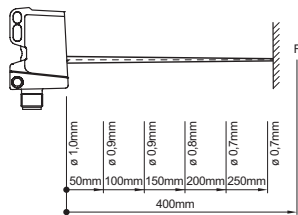

dimension drawing

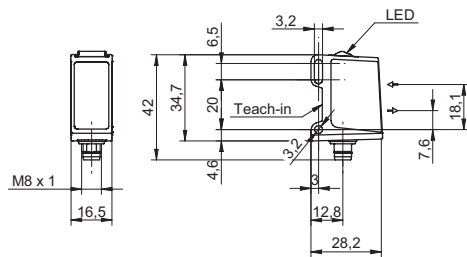

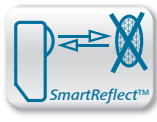

Sde = 30 ... 250 mm



- One inch class
- hygienic design
- laser diode

**general data**

type	light barrier
special type	hygienic design
version	standard object detection
light source	pulsed red laser diode
background position Sde	30 ... 250 mm
scanning range Sa	90% ... 85% Sde
repeat accuracy	< 0,1 mm at 100 mm
power on indication	LED green
light indicator	LED yellow
sensing distance adjustment	Teach-in and IO-Link
laser class	1
distance to focus	400 mm
wave length	656 nm
suppression of reciprocal influence	yes
alignment optical axis	< 2°
approvals/certificates	Ecolab

**electrical data**

response time / release time	< 0,25 ms
voltage supply range +Vs	11 ... 30 VDC
current consumption max. (no load)	30 mA
current consumption typ.	25 mA
voltage drop Vd	< 2,5 VDC
output function	light / dark operate
output circuit	push-pull
output current	< 100 mA
short circuit protection	yes
reverse polarity protection	yes

**mechanical data**

width / diameter	16,5 mm
height / length	34,6 mm
depth	28,7 mm
type	rectangular
housing material	stainless steel 1.4404 (V4A)
front (optics)	PMMA

**ambient conditions**

operating temperature	-10 ... +60 °C
protection class	IP 68/69K & proTect+

**order reference**

order reference	connection types
O300H.SL-11179007	cable 4 pin, 2 m
O300H.SL-11179008	flylead connector M8, L=200 mm

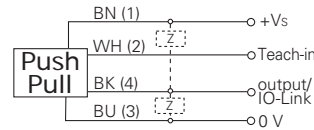
**connection diagram****connectors and mating connectors**

ESG 32AY0200	Connector M8, 4 pin, straight, 2 m, V4A-PP
ESW 31AY0200	Connector M8, 4 pin, angular, 2 m, V4A-PP

additional cable connectors and field wireable connectors: see accessories

**Accessories**

HI11-1H	Mounting for sensors in hygienic design Ø 11 mm
11137318	Teach Pen for sensors in metal housing
11141124	Teach Pen for sensors in metal housing (USA, CAN, JP)

for details: see accessories section

**laser warning**

**CLASS 1 LASER  
PRODUCT**

IEC 60825-1/2014  
Complies with 21 CFR 1040.10 and 1040.11  
except for deviations pursuant to laser  
notice No. 50, dated June 24, 2007



beam characteristic (typically)

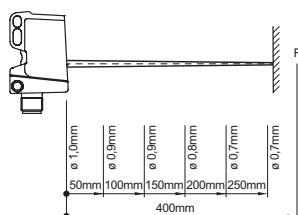

dimension drawings

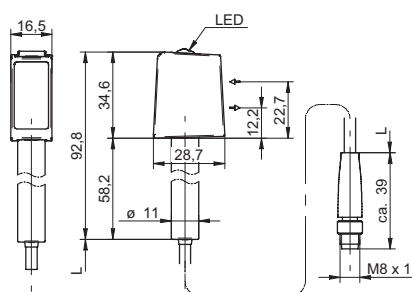
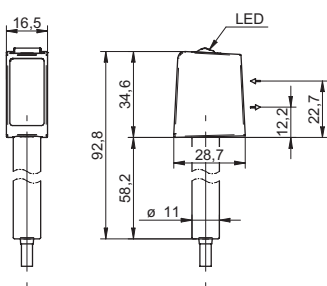

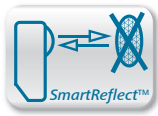

Sde = 100 ... 1900 mm



- long sensing range
- qTeach

**general data**

type	light barrier
version	standard object detection
light source	pulsed red laser diode
background position Sde	100 ... 1900 mm
scanning range Sa	97% ... 83% Sde
alignment / soiled lens indicator	flashing light indicator
power on indication	LED green
light indicator	LED yellow
sensing distance adjustment	Teach-in
laser class	1
wave length	656 nm
beam diameter	3,7 ... 22 mm

**electrical data**

response time / release time	< 10 ms
voltage supply range +Vs	10 ... 30 VDC
current consumption max. (no load)	80 mA
voltage drop Vd	< 3,5 VDC
output function	light / dark operate
output circuit	push-pull
output current	< 100 mA
short circuit protection	yes
reverse polarity protection	yes

**mechanical data**

width / diameter	23,4 mm
height / length	63 mm
depth	45 mm
type	rectangular
housing material	plastic (SAN LURAN 378P)
front (optics)	PMMA

**ambient conditions**

operating temperature	0 ... +50 °C
protection class	IP 67
storage temperature	-10 ... +70 °C

**order reference**

<b>ONDK 25G6911</b>	cable, 2 m
<b>ONDK 25G6911/S14</b>	connector M12 5 pin

ONDK 25 Sde = 100 ... 1900 mm

SmartReflect Light barriers

**connection diagram**

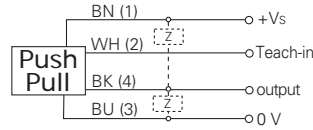

**connectors and mating connectors**

ESG 34AH0200	Connector M12, 4 pin, straight, 2 m
ESW 33AH0200	Connector M12, 4 pin, angular, 2 m

additional cable connectors and field wireable connectors: see accessories

**Accessories**

11077517	Mounting bracket for sensors series 25 (L design)
----------	---

for details: see accessories section





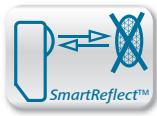

Sde = 30 ... 300 mm



- One inch class
- PinPoint LED
- designed for detection of transparent objects



**general data**

type	light barrier
version	transparency object detection
light source	pulsed PinPoint LED
background position Sde	30 ... 300 mm
scanning range Sa	100% ... 85% Sde
minimal signal attenuation	10 % / 20 % / 30 %
power on indication	LED green
light indicator	LED yellow
sensing distance adjustment	Teach-in and IO-Link
wave length	630 nm
suppression of reciprocal influence	yes
alignment optical axis	< 2°

**electrical data**

response time / release time	< 0,25 ms
voltage supply range +Vs	10 ... 30 VDC
current consumption max. (no load)	45 mA
current consumption typ.	30 mA
voltage drop Vd	< 3 VDC
output function	light / dark operate
output circuit	push-pull
output current	< 100 mA
short circuit protection	yes
reverse polarity protection	yes

**mechanical data**

width / diameter	12,9 mm
height / length	32,3 mm
depth	23 mm
type	rectangular
housing material	plastic (ASA, PMMA)
front (optics)	PMMA

**ambient conditions**

operating temperature	-25 ... +60 °C
protection class	IP 67

**order reference**

<b>O300.SPT-11136905</b>	cable 4 pin, 2 m
<b>O300.SPT-11136906</b>	connector M8 4 pin

**connection types**

**connection diagram**

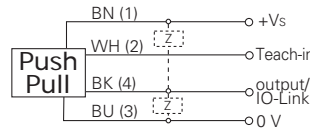

**connectors and mating connectors**

ESG 32AH0200	Connector M8, 4 pin, straight, 2 m
ESW 31AH0200	Connector M8, 4 pin, angular, 2 m

additional cable connectors and field wireable connectors: see accessories

**Accessories**

11104963	Sensofix O300
11102423	Mounting bracket O300 (L design)
11124807	Mounting bracket O300 - Retrofit for sensors series 20

for details: see accessories section

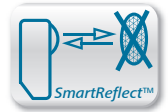

## beam characteristic (typically)

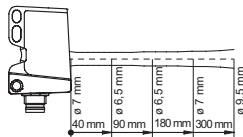

## dimension drawings

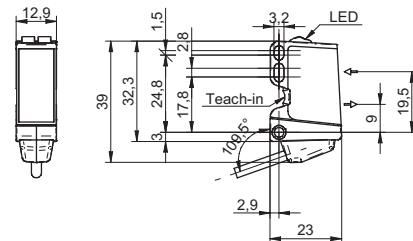
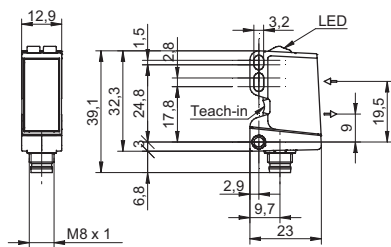

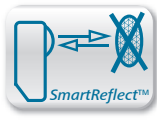

Sde = 30 ... 300 mm

IO-Link



- One inch class
- washdown design
- PinPoint LED

**general data**

type	light barrier
special type	Washdown design
version	transparency object detection
light source	pulsed PinPoint LED
background position Sde	30 ... 300 mm
scanning range Sa	100% ... 85% Sde
minimal signal attenuation	10 % / 20 % / 30 %
power on indication	LED green
light indicator	LED yellow
sensing distance adjustment	Teach-in and IO-Link
wave length	630 nm
suppression of reciprocal influence	yes
alignment optical axis	< 2°
approvals/certificates	Ecolab

**electrical data**

response time / release time	< 0,25 ms
voltage supply range +Vs	10 ... 30 VDC
current consumption max. (no load)	45 mA
current consumption typ.	30 mA
voltage drop Vd	< 3 VDC
output function	light / dark operate
output circuit	push-pull
output current	< 100 mA
short circuit protection	yes
reverse polarity protection	yes

**mechanical data**

width / diameter	16,5 mm
height / length	34,7 mm
depth	28,2 mm
type	rectangular
housing material	stainless steel 1.4404 (V4A)
front (optics)	PMMA
connection types	connector M8 4 pin

**ambient conditions**

operating temperature	-25 ... +60 °C
protection class	IP 68/69K & proTect+

**order reference**

O300W.SP.T-11136922

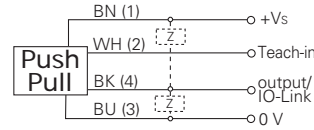
**connection diagram****connectors and mating connectors**

ESG 32AY0200	Connector M8, 4 pin, straight, 2 m, V4A-PP
ESW 31AY0200	Connector M8, 4 pin, angular, 2 m, V4A-PP

additional cable connectors and field wireable connectors: see accessories

**Accessories**

11104963	Sensofix O300
11102423	Mounting bracket O300 (L design)
11124807	Mounting bracket O300 - Retrofit for sensors series 20

for details: see accessories section

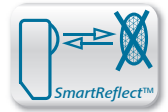

beam characteristic (typically)

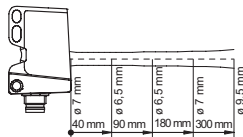

dimension drawing

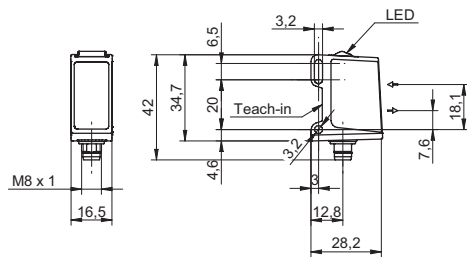

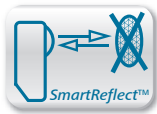

Sde = 30 ... 300 mm



- One inch class
- hygienic design
- PinPoint LED

**general data**

type	light barrier
special type	hygienic design
version	transparency object detection
light source	pulsed PinPoint LED
background position Sde	30 ... 300 mm
scanning range Sa	100% ... 85% Sde
minimal signal attenuation	10 % / 20 % / 30 %
power on indication	LED green
light indicator	LED yellow
sensing distance adjustment	Teach-in and IO-Link
wave length	630 nm
suppression of reciprocal influence	yes
alignment optical axis	< 2°
approvals/certificates	Ecolab

**electrical data**

response time / release time	< 0,25 ms
voltage supply range +Vs	10 ... 30 VDC
current consumption max. (no load)	45 mA
current consumption typ.	30 mA
voltage drop Vd	< 3 VDC
output function	light / dark operate
output circuit	push-pull
output current	< 100 mA
short circuit protection	yes
reverse polarity protection	yes

**mechanical data**

width / diameter	16,5 mm
height / length	34,6 mm
depth	28,7 mm
type	rectangular
housing material	stainless steel 1.4404 (V4A)
front (optics)	PMMA

**ambient conditions**

operating temperature	-25 ... +60 °C
protection class	IP 68/69K & proTect+

**order reference**

order reference	connection types
O300H.S.P.T-11136925	cable 4 pin, 2 m
O300H.S.P.T-11136926	flylead connector M8, L=200 mm

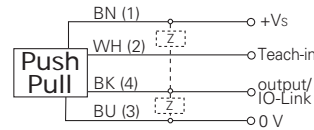
**connection diagram****connectors and mating connectors**

ESG 32AY0200	Connector M8, 4 pin, straight, 2 m, V4A-PP
ESW 31AY0200	Connector M8, 4 pin, angular, 2 m, V4A-PP

additional cable connectors and field wireable connectors: see accessories

**Accessories**

HI11-1H	Mounting for sensors in hygienic design Ø 11 mm
11137318	Teach Pen for sensors in metal housing
11141124	Teach Pen for sensors in metal housing (USA, CAN, JP)

for details: see accessories section

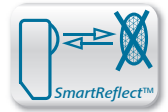

beam characteristic (typically)

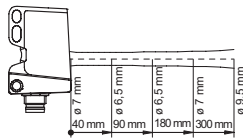

dimension drawings

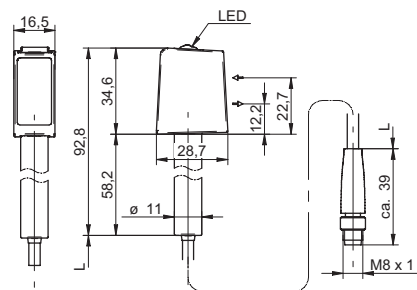
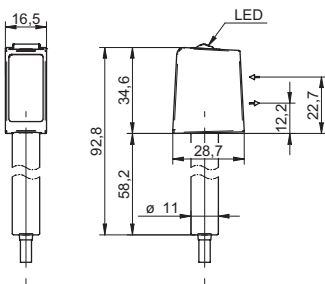

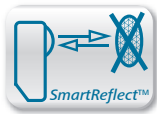

Sde = 200 ... 800 mm

IO-Link

- short response time
- sensing distance adjustable via Teach-in
- IO-Link



**general data**

type	light barrier
light source	pulsed red LED
background position Sde	200 ... 800 mm on V4A
alignment / soiled lens indicator	flashing light indicator
power on indication	LED green
output indicator	LED red
sensing distance adjustment	Teach-in and IO-Link
wave length	660 nm

**electrical data**

response time / release time	< 1,8 ms
voltage supply range +Vs	10 ... 30 VDC
current consumption max. (no load)	35 mA
current consumption typ.	30 mA
voltage drop Vd	< 2 VDC
output function	light / dark operate
output circuit	push-pull
output current	< 100 mA
short circuit protection	yes

**mechanical data**

width / diameter	14,8 mm
height / length	43 mm
depth	31 mm
type	rectangular
housing material	plastic (ASA, MABS)
front (optics)	PMMA

**ambient conditions**

operating temperature	-30 ... +60 °C
protection class	IP 67

**connection diagram**

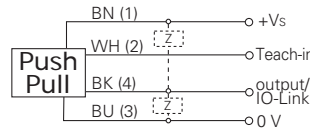

**connectors and mating connectors**

ESG 34AH0200	Connector M12, 4 pin, straight, 2 m
ESW 33AH0200	Connector M12, 4 pin, angular, 2 m
ESG 32AH0200	Connector M8, 4 pin, straight, 2 m
ESW 31AH0200	Connector M8, 4 pin, angular, 2 m

additional cable connectors and field wireable connectors: see accessories

**Accessories**

10149011	Sensofix series 14
10134964	Mounting bracket series 14 (L design)

for details: see accessories section

order reference	version	connection types	reverse polarity protection	minimal signal attenuation
FNDK 14G6902/IO	Tray and bottle detection	cable 4 pin, 2 m	yes, Vs to GND	30 %
FNDK 14G6902/S14/IO	Tray and bottle detection	connector M12 4 pin	yes, Vs to GND	30 %
FNDK 14G6902/S35A/IO	Tray and bottle detection	connector M8 4 pin	yes, Vs to GND	30 %
FNDK 14G6903/IO	Foil detection	cable 4 pin, 2 m	yes	12 %
FNDK 14G6903/S14/IO	Foil detection	connector M12 4 pin	yes	12 %
FNDK 14G6903/S35A/IO	Foil detection	connector M8 4 pin	yes	12 %

FNDK 14 Sde = 200 ... 800 mm

SmartReflect Light barriers



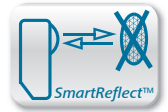

dimension drawings

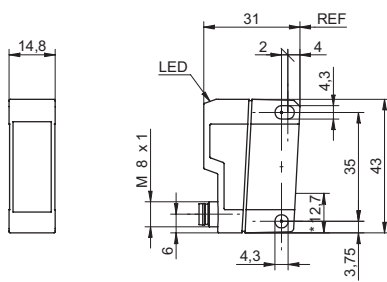

\* emitter axis

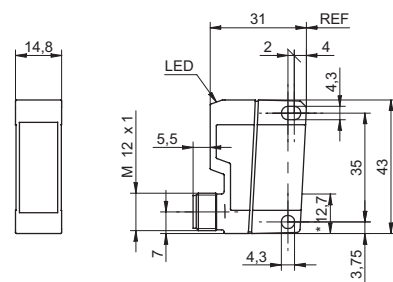

\* emitter axis

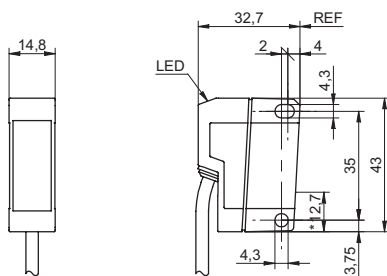

\* emitter axis

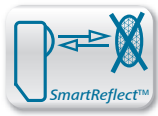

Sde = 200 ... 800 mm

IO-Link



- washdown design
- IO-Link
- remote Teach-in

**general data**

type	light barrier
special type	Washdown design
light source	pulsed point source LED
background position Sde	200 ... 800 mm on V4A
alignment / soiled lens indicator	flashing light indicator
power on indication	LED green
output indicator	LED red
wave length	660 nm
approvals/certificates	Ecolab

**electrical data**

response time / release time	< 1,8 ms
voltage supply range +Vs	10 ... 30 VDC
current consumption max. (no load)	40 mA
current consumption typ.	35 mA
voltage drop Vd	< 2 VDC
output function	light / dark operate
output circuit	push-pull
output current	< 100 mA
short circuit protection	yes

**mechanical data**

width / diameter	19,6 mm
height / length	51 mm
depth	34,3 mm
type	rectangular
housing material	stainless steel 1.4404 (V4A)
front (optics)	PMMA
connection types	connector M12

**ambient conditions**

operating temperature	-30 ... +60 °C
protection class	IP 68/69K & proTect+
storage temperature	-30 ... +70 °C

**connection diagrams**

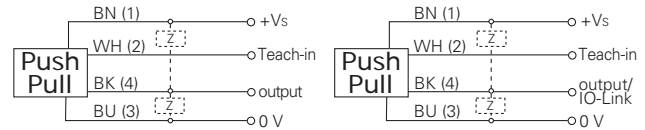

**connectors and mating connectors**

ESG 34AY0200	Connector M12, 4 pin, straight, 2 m, V4A-PP
ESW 33AY0200	Connector M12, 4 pin, angular, 2 m, V4A-PP

additional cable connectors and field wireable connectors: see accessories

**Accessories**

11046278	Mounting bracket series 14 washdown
11046279	Sensofix series 14 washdown

for details: see accessories section

**remarks**

Sensor FDA compliant and Ecolab approved  
 IO-Link: output signal, service status, object presence  
 sensitivity adjustable: via Teach-in wire input  
 LSR = Liquid Silicon Rubber

order reference	version	sensing distance adjustment	reverse polarity protection	minimal signal attenuation
<b>FNDR 14G6902/S14</b>	Tray and bottle detection	Teach-in	yes, Vs to GND	30 %
<b>FNDR 14G6902/S14/IO</b>	Tray and bottle detection	Teach-in and IO-Link	yes, Vs to GND	30 %
<b>FNDR 14G6903/S14</b>	Foil detection	Teach-in	yes	12 %
<b>FNDR 14G6903/S14/IO</b>	Foil detection	Teach-in and IO-Link	yes	12 %

FNDR 14 Sde = 200 ... 800 mm

SmartReflect Light barriers

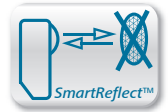

dimension drawing

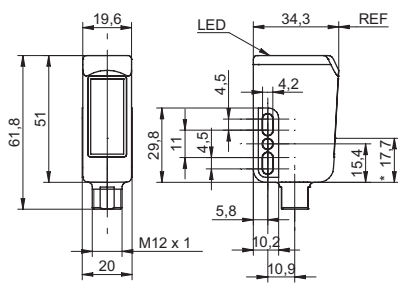

\* emitter axis

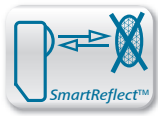

Sde = 200 ... 800 mm

IO-Link



- hygienic design
- IO-Link
- remote Teach-in

general data	
type	light barrier
special type	hygienic design
light source	pulsed point source LED
background position Sde	200 ... 800 mm on V4A
alignment / soiled lens indicator	flashing light indicator
power on indication	LED green
output indicator	LED red
wave length	660 nm
approvals/certificates	Ecolab EHEDG

electrical data	
response time / release time	< 1,8 ms
voltage supply range +Vs	10 ... 30 VDC
current consumption max. (no load)	40 mA
current consumption typ.	35 mA
voltage drop Vd	< 2 VDC
output function	light / dark operate
output circuit	push-pull
output current	< 100 mA
short circuit protection	yes

mechanical data	
width / diameter	19,6 mm
height / length	52,2 mm
depth	34,3 mm
type	rectangular
housing material	stainless steel 1.4404 (V4A)
front (optics)	PMMA

ambient conditions	
operating temperature	-30 ... +60 °C
protection class	IP 68/69K & proTect+
storage temperature	-30 ... +70 °C

connection diagrams

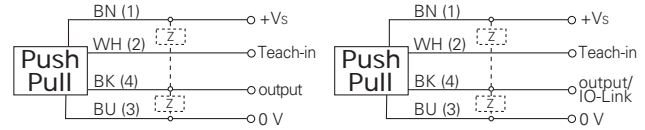

connectors and mating connectors

ESG 34AY0200	Connector M12, 4 pin, straight, 2 m, V4A-PP
ESW 33AY0200	Connector M12, 4 pin, angular, 2 m, V4A-PP

additional cable connectors and field wireable connectors: see accessories

Accessories

HI17-1H	Mounting for sensors in hygienic design Ø 17 mm
---------	---

for details: see accessories section

remarks

Sensor FDA compliant, EHEDG certified and Ecolab approved  
 IO-Link: output signal, service status, object presence  
 sensitivity adjustable: via Teach-in wire input  
 LSR = Liquid Silicon Rubber

order reference	version	connection types	sensing distance adjustment	reverse polarity protection	minimal signal attenuation
FNDH 14G6902	Tray and bottle detection	cable 4 pin, 2 m	Teach-in	yes, Vs to GND	30 %
FNDH 14G6902/IO	Tray and bottle detection	cable 4 pin, 2 m	Teach-in and IO-Link	yes, Vs to GND	30 %
FNDH 14G6902/KS34A	Tray and bottle detection	flylead connector M12, L=300 mm	Teach-in	yes, Vs to GND	30 %
FNDH 14G6902/KS34A/IO	Tray and bottle detection	flylead connector M12, L=300 mm	Teach-in and IO-Link	yes, Vs to GND	30 %
FNDH 14G6903	Foil detection	cable 4 pin, 2 m	Teach-in	yes	12 %
FNDH 14G6903/IO	Foil detection	cable 4 pin, 2 m	Teach-in and IO-Link	yes	12 %
FNDH 14G6903/KS34A	Foil detection	flylead connector M12, L=300 mm	Teach-in	yes	12 %
FNDH 14G6903/KS34A/IO	Foil detection	flylead connector M12, L=300 mm	Teach-in and IO-Link	yes	12 %

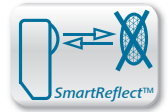

dimension drawings

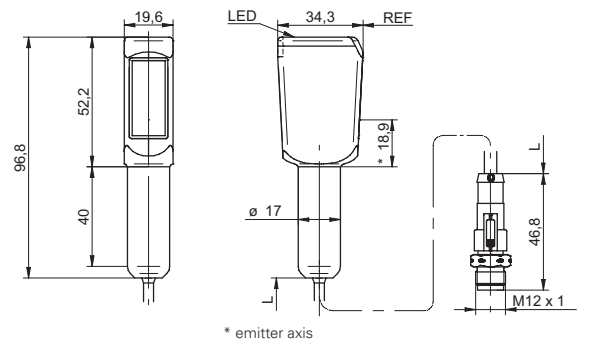
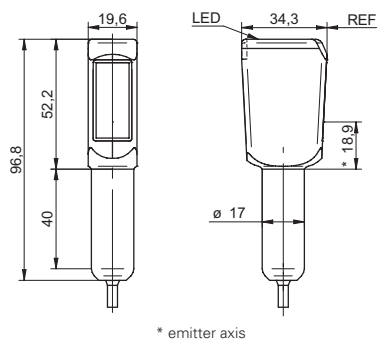

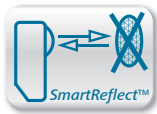

Sde = 60 ... 1000 mm



- PinPoint LED
- designed for detection of transparent objects
- IO-Link

**general data**

type	light barrier
version	transparency object detection
light source	pulsed PinPoint LED
background position Sde	60 ... 1000 mm
scanning range Sa	100% ... 85% Sde
minimal signal attenuation	10 % / 20 % / 30 %
power on indication	LED green
light indicator	LED yellow
sensing distance adjustment	Teach-in and IO-Link
wave length	630 nm
suppression of reciprocal influence	yes
alignment optical axis	< 1°

**electrical data**

response time / release time	< 0,25 ms
voltage supply range +Vs	10 ... 30 VDC
current consumption max. (no load)	40 mA
current consumption typ.	30 mA
voltage drop Vd	< 3 VDC
output function	light / dark operate
output circuit	push-pull
output current	< 100 mA
short circuit protection	yes
reverse polarity protection	yes

**mechanical data**

width / diameter	18 mm
height / length	45 mm
depth	32 mm
type	rectangular
housing material	plastic (ASA, PMMA)
front (optics)	PMMA

**ambient conditions**

operating temperature	-25 ... +60 °C
protection class	IP 67

**order reference**

order reference	connection types
O500.SP.T-11136920	cable 4 pin, 2 m
O500.SP.T-11136921	connector M12 4 pin

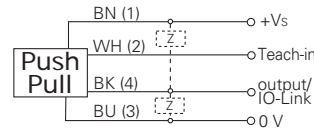
**connection diagram****connectors and mating connectors**

ESG 34AH0200 Connector M12, 4 pin, straight, 2 m

ESW 33AH0200 Connector M12, 4 pin, angular, 2 m

additional cable connectors and field wireable connectors: see accessories

**Accessories**

11099942	Sensofix O500/U500
11092246	Mounting bracket O500/U500 (L design)
11111164	Mounting bracket O500/U500 - Retrofit for sensors series 30

for details: see accessories section

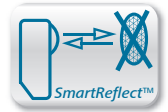

### beam characteristic (typically)

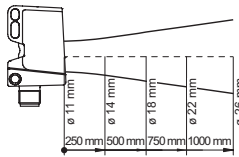

### dimension drawings

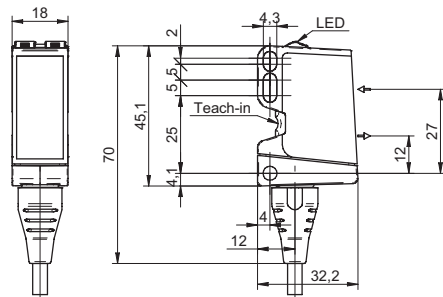
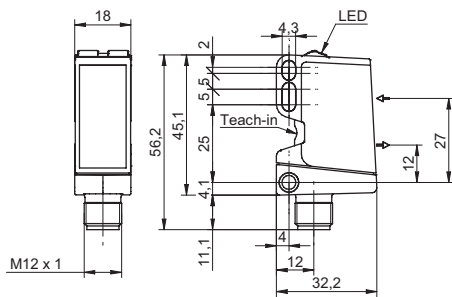

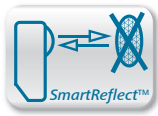

Sde = 60 ... 1000 mm



- washdown design
- PinPoint LED
- designed for detection of transparent objects

#### general data

type	light barrier
special type	Washdown design
version	transparency object detection
light source	pulsed PinPoint LED
background position Sde	60 ... 1000 mm
scanning range Sa	100% ... 85% Sde
minimal signal attenuation	10 % / 20 % / 30 %
power on indication	LED green
light indicator	LED yellow
sensing distance adjustment	Teach-in and IO-Link
wave length	630 nm
suppression of reciprocal influence	yes
alignment optical axis	< 1°
approvals/certificates	Ecolab

#### electrical data

response time / release time	< 0,25 ms
voltage supply range +Vs	10 ... 30 VDC
current consumption max. (no load)	40 mA
current consumption typ.	30 mA
voltage drop Vd	< 3 VDC
output function	light / dark operate
output circuit	push-pull
output current	< 100 mA
short circuit protection	yes
reverse polarity protection	yes

#### mechanical data

width / diameter	20,2 mm
height / length	47,2 mm
depth	37,7 mm
type	rectangular
housing material	stainless steel 1.4404 (V4A)
front (optics)	PMMA
connection types	connector M12 4 pin

#### ambient conditions

operating temperature	-25 ... +60 °C
protection class	IP 68/69K & proTect+

#### order reference

O500W.SP.T-11136924

#### connection diagram

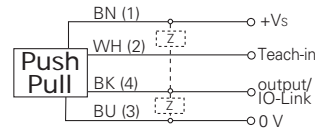

#### connectors and mating connectors

ESG 34AY0200	Connector M12, 4 pin, straight, 2 m, V4A-PP
ESW 33AY0200	Connector M12, 4 pin, angular, 2 m, V4A-PP

additional cable connectors and field wireable connectors: see accessories

#### Accessories

11092246	Mounting bracket O500/U500 (L design)
11111164	Mounting bracket O500/U500 - Retrofit for sensors series 30
11099942	Sensofix O500/U500

for details: see accessories section



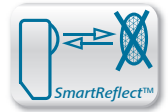

beam characteristic (typically)

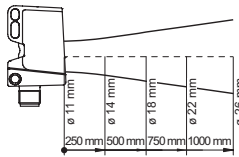

dimension drawing

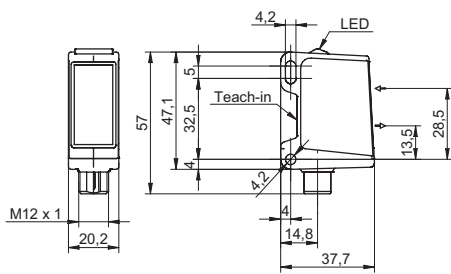

SmartReflect Light barriers O500W.SP.T Sde = 60 ... 1000 mm

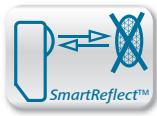

Sde = 60 ... 1000 mm



- hygienic design
- PinPoint LED
- designed for detection of transparent objects

**general data**

type	light barrier
special type	hygienic design
version	transparency object detection
light source	pulsed PinPoint LED
background position Sde	60 ... 1000 mm
scanning range Sa	100% ... 85% Sde
minimal signal attenuation	10 % / 20 % / 30 %
power on indication	LED green
light indicator	LED yellow
sensing distance adjustment	Teach-in and IO-Link
wave length	630 nm
suppression of reciprocal influence	yes
alignment optical axis	< 1°
approvals/certificates	Ecolab

**electrical data**

response time / release time	< 0,25 ms
voltage supply range +Vs	10 ... 30 VDC
current consumption max. (no load)	40 mA
current consumption typ.	30 mA
voltage drop Vd	< 3 VDC
output function	light / dark operate
output circuit	push-pull
output current	< 100 mA
short circuit protection	yes
reverse polarity protection	yes

**mechanical data**

width / diameter	20,2 mm
height / length	47,7 mm
depth	36,4 mm
type	rectangular
housing material	stainless steel 1.4404 (V4A)
front (optics)	PMMA

**ambient conditions**

operating temperature	-25 ... +60 °C
protection class	IP 68/69K & proTect+

**order reference**

<b>O500H.SP.T-11136929</b>	cable 4 pin, 2 m
<b>O500H.SP.T-11136930</b>	flylead connector M12, L=300 mm

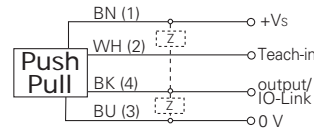
**connection types****connection diagram****connectors and mating connectors**

ESG 34AY0200	Connector M12, 4 pin, straight, 2 m, V4A-PP
ESW 33AY0200	Connector M12, 4 pin, angular, 2 m, V4A-PP

additional cable connectors and field wireable connectors: see accessories

**Accessories**

HI17-1H	Mounting for sensors in hygienic design Ø 17 mm
11137318	Teach Pen for sensors in metal housing
11141124	Teach Pen for sensors in metal housing (USA, CAN, JP)

for details: see accessories section

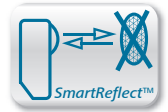

beam characteristic (typically)

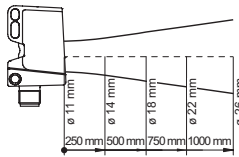

dimension drawings

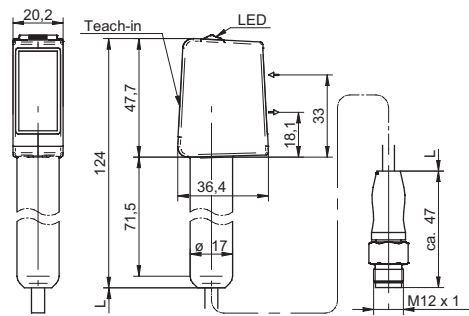
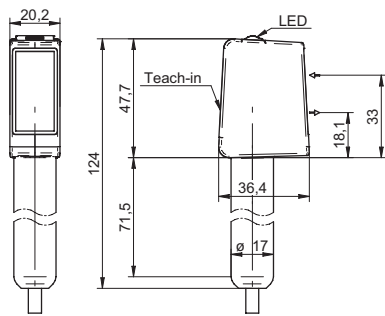

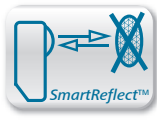

Sde = 30 ... 300 mm



- One inch class
- washdown design
- PinPoint LED

**general data**

type	light barrier
special type	Washdown design
version	standard object detection
light source	pulsed PinPoint LED
background position Sde	30 ... 300 mm
scanning range Sa	90% ... 85% Sde
power on indication	LED green
light indicator	LED yellow
sensing distance adjustment	Teach-in and IO-Link
wave length	630 nm
suppression of reciprocal influence	yes
alignment optical axis	< 2°
approvals/certificates	Ecolab

**electrical data**

response time / release time	< 0,49 ms
voltage supply range +Vs	10 ... 30 VDC
current consumption max. (no load)	45 mA
current consumption typ.	30 mA
voltage drop Vd	< 3 VDC
output function	light / dark operate
output circuit	push-pull
output current	< 100 mA
short circuit protection	yes
reverse polarity protection	yes

**mechanical data**

width / diameter	16,5 mm
height / length	34,7 mm
depth	28,2 mm
type	rectangular
housing material	stainless steel 1.4404 (V4A)
front (optics)	PMMA
connection types	connector M8 4 pin

**ambient conditions**

operating temperature	-25 ... +60 °C
protection class	IP 68/69K & proTect+

**order reference**

O300W.SP-1127758

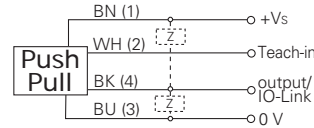
**connection diagram****connectors and mating connectors**

ESG 32AY0200 Connector M8, 4 pin, straight, 2 m, V4A-PP

ESW 31AY0200 Connector M8, 4 pin, angular, 2 m, V4A-PP

additional cable connectors and field wireable connectors: see accessories

**Accessories**

11104963 Sensofix O300

11102423 Mounting bracket O300 (L design)

11124807 Mounting bracket O300 - Retrofit for sensors series 20

for details: see accessories section

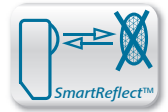

beam characteristic (typically)

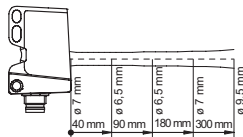

dimension drawing

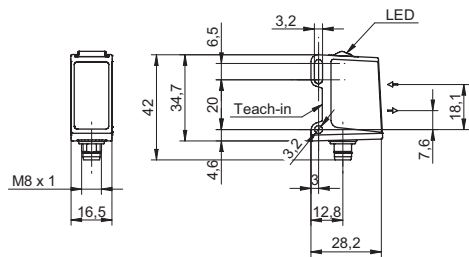

SmartReflect Light barriers O300W.SP Sde = 30 ... 300 mm

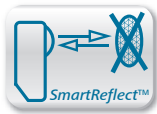

Sde = 30 ... 300 mm



- One inch class
- hygienic design
- PinPoint LED

**general data**

type	light barrier
special type	hygienic design
version	standard object detection
light source	pulsed PinPoint LED
background position Sde	30 ... 300 mm
scanning range Sa	90% ... 85% Sde
power on indication	LED green
light indicator	LED yellow
sensing distance adjustment	Teach-in and IO-Link
wave length	630 nm
suppression of reciprocal influence	yes
alignment optical axis	< 2°
approvals/certificates	Ecolab

**electrical data**

response time / release time	< 0,49 ms
voltage supply range +Vs	10 ... 30 VDC
current consumption max. (no load)	45 mA
current consumption typ.	30 mA
voltage drop Vd	< 3 VDC
output function	light / dark operate
output circuit	push-pull
output current	< 100 mA
short circuit protection	yes
reverse polarity protection	yes

**mechanical data**

width / diameter	16,5 mm
height / length	34,6 mm
depth	28,7 mm
type	rectangular
housing material	stainless steel 1.4404 (V4A)
front (optics)	PMMA

**ambient conditions**

operating temperature	-25 ... +60 °C
protection class	IP 68/69K & proTect+

**order reference**

<b>O300H.SP-11127754</b>	cable 4 pin, 2 m
<b>O300H.SP-11136904</b>	flylead connector M8, L=200 mm

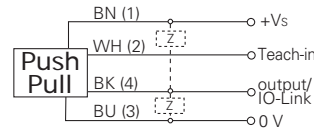
**connection types****connection diagram****connectors and mating connectors**

ESG 32AY0200 Connector M8, 4 pin, straight, 2 m, V4A-PP

ESW 31AY0200 Connector M8, 4 pin, angular, 2 m, V4A-PP

additional cable connectors and field wireable connectors: see accessories

**Accessories**

HI11-1H Mounting for sensors in hygienic design Ø 11 mm

11137318 Teach Pen for sensors in metal housing

11141124 Teach Pen for sensors in metal housing (USA, CAN, JP)

for details: see accessories section

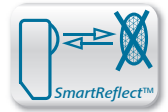

beam characteristic (typically)

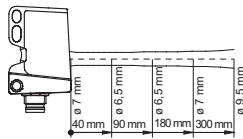

dimension drawings

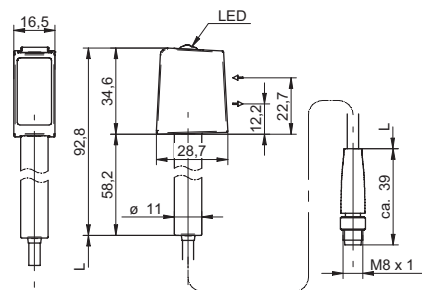
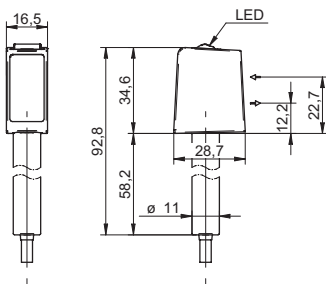

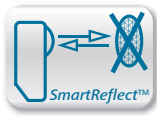

Sde = 50 ... 800 mm



- washdown design
- IO-Link
- remote Teach-in

**general data**

type	light barrier
special type	Washdown design
version	standard object detection
light source	pulsed point source LED
background position Sde	50 ... 800 mm on V4A
scanning range Sa	96% Sde
alignment / soiled lens indicator	flashing light indicator
power on indication	LED green
output indicator	LED red
wave length	660 nm
approvals/certificates	Ecolab

**electrical data**

response time / release time	< 1,8 ms
voltage supply range +Vs	10 ... 30 VDC
current consumption max. (no load)	40 mA
current consumption typ.	35 mA
voltage drop Vd	< 2 VDC
output function	light / dark operate
output circuit	push-pull
output current	< 100 mA
short circuit protection	yes
reverse polarity protection	yes

**mechanical data**

width / diameter	19,6 mm
height / length	51 mm
depth	34,3 mm
type	rectangular
housing material	stainless steel 1.4404 (V4A)
front (optics)	PMMA
connection types	connector M12

**ambient conditions**

operating temperature	-30 ... +60 °C
protection class	IP 68/69K & proTect+
storage temperature	-30 ... +70 °C

**order reference**

order reference	sensing distance adjustment
<b>FNDR 14G6901/S14</b>	Teach-in
<b>FNDR 14G6901/S14/IO</b>	Teach-in and IO-Link

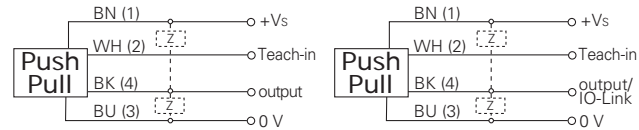
**connection diagrams****connectors and mating connectors**

ESG 34AY0200 Connector M12, 4 pin, straight, 2 m, V4A-PP

ESW 33AY0200 Connector M12, 4 pin, angular, 2 m, V4A-PP

additional cable connectors and field wireable connectors: see accessories

**Accessories**

11046278 Mounting bracket series 14 washdown

11046279 Sensofix series 14 washdown

for details: see accessories section

**remarks**

Sensor FDA compliant and Ecolab approved  
 IO-Link: output signal, service status, object presence  
 sensitivity adjustable: via Teach-in wire input  
 LSR = Liquid Silicon Rubber



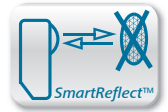

dimension drawing

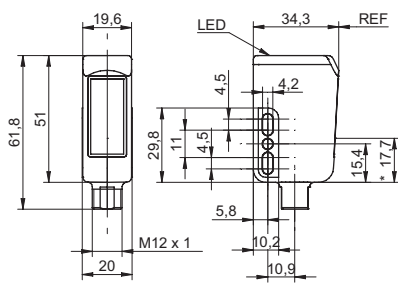

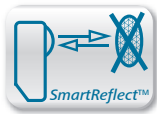

Sde = 50 ... 800 mm

IO-Link



- hygienic design
- IO-Link
- remote Teach-in

**general data**

type	light barrier
special type	hygienic design
version	standard object detection
light source	pulsed point source LED
background position Sde	50 ... 800 mm on V4A
scanning range Sa	96% Sde
alignment / soiled lens indicator	flashing light indicator
power on indication	LED green
output indicator	LED red
wave length	660 nm
approvals/certificates	Ecolab EHEDG

**electrical data**

response time / release time	< 1,8 ms
voltage supply range +Vs	10 ... 30 VDC
current consumption max. (no load)	40 mA
current consumption typ.	35 mA
voltage drop Vd	< 2 VDC
output function	light / dark operate
output circuit	push-pull
output current	< 100 mA
short circuit protection	yes
reverse polarity protection	yes

**mechanical data**

width / diameter	19,6 mm
height / length	52,2 mm
depth	34,3 mm
type	rectangular
housing material	stainless steel 1.4404 (V4A)
front (optics)	PMMA

**ambient conditions**

operating temperature	-30 ... +60 °C
protection class	IP 68/69K & proTect+
storage temperature	-30 ... +70 °C

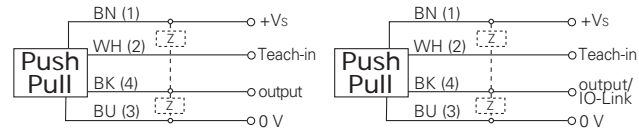
**connection diagrams****connectors and mating connectors**

ESG 34AY0200 Connector M12, 4 pin, straight, 2 m, V4A-PP

ESW 33AY0200 Connector M12, 4 pin, angular, 2 m, V4A-PP

additional cable connectors and field wireable connectors: see accessories

**Accessories**HI17-1H Mounting for sensors in hygienic design Ø 17 mm  
for details: see accessories section**remarks**

Sensor FDA compliant, EHEDG certified and Ecolab approved  
 IO-Link: output signal, service status, object presence  
 sensitivity adjustable: via Teach-in wire input  
 LSR = Liquid Silicon Rubber

order reference	connection types	sensing distance adjustment
FNDH 14G6901	cable 4 pin, 2 m	Teach-in
FNDH 14G6901/IO	cable 4 pin, 2 m	Teach-in and IO-Link
FNDH 14G6901/KS34A	flylead connector M12, L=300 mm	Teach-in
FNDH 14G6901/KS34A/IO	flylead connector M12, L=300 mm	Teach-in and IO-Link

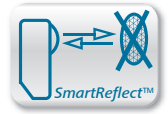

dimension drawings

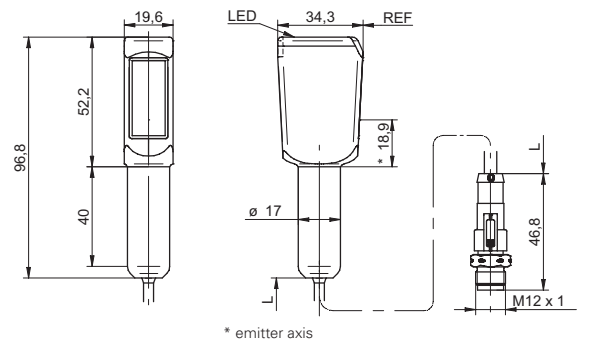
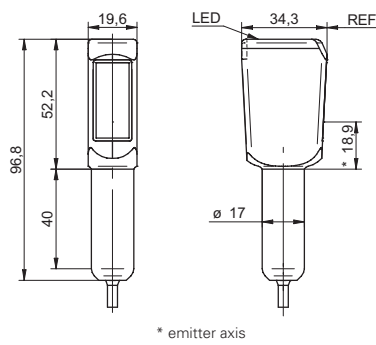

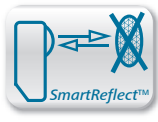

Sde = 60 ... 600 mm



- washdown design
- PinPoint LED
- IO-Link

#### general data

type	light barrier
special type	Washdown design
version	standard object detection
light source	pulsed PinPoint LED
background position Sde	60 ... 600 mm
scanning range Sa	90% ... 85% Sde
power on indication	LED green
light indicator	LED yellow
sensing distance adjustment	Teach-in and IO-Link
wave length	630 nm
suppression of reciprocal influence	yes
alignment optical axis	< 1°
approvals/certificates	Ecolab

#### electrical data

response time / release time	< 0,49 ms
voltage supply range +Vs	10 ... 30 VDC
current consumption max. (no load)	40 mA
current consumption typ.	30 mA
voltage drop Vd	< 3 VDC
output function	light / dark operate
output circuit	push-pull
output current	< 100 mA
short circuit protection	yes
reverse polarity protection	yes

#### mechanical data

width / diameter	20,2 mm
height / length	47,2 mm
depth	37,7 mm
type	rectangular
housing material	stainless steel 1.4404 (V4A)
front (optics)	PMMA
connection types	connector M12 4 pin

#### ambient conditions

operating temperature	-25 ... +60 °C
protection class	IP 68/69K & proTect+

#### order reference

O500W.SP-11125098

#### connection diagram

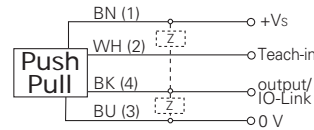

#### connectors and mating connectors

ESG 34AY0200	Connector M12, 4 pin, straight, 2 m, V4A-PP
ESW 33AY0200	Connector M12, 4 pin, angular, 2 m, V4A-PP

additional cable connectors and field wireable connectors: see accessories

#### Accessories

11092246	Mounting bracket O500/U500 (L design)
11111164	Mounting bracket O500/U500 - Retrofit for sensors series 30
11099942	Sensofix O500/U500

for details: see accessories section

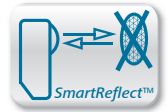

beam characteristic (typically)

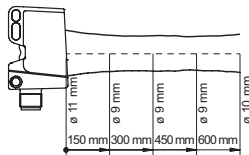

dimension drawing

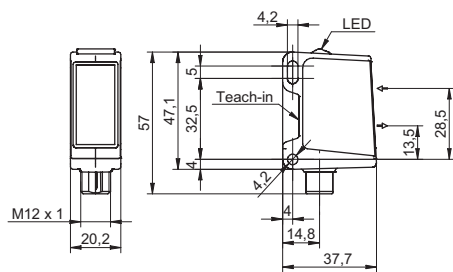

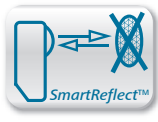

Sde = 60 ... 600 mm



- washdown design
- PinPoint LED
- IO-Link

**general data**

type	light barrier
special type	Washdown design
version	standard object detection
light source	pulsed PinPoint LED
power on indication	LED green
light indicator	LED yellow
sensing distance adjustment	Teach-in and IO-Link
wave length	630 nm
suppression of reciprocal influence	yes
alignment optical axis	< 1°
approvals/certificates	Ecolab

**electrical data**

response time / release time	< 0,49 ms
voltage supply range +Vs	10 ... 30 VDC
current consumption max. (no load)	40 mA
current consumption typ.	30 mA
voltage drop Vd	< 3 VDC
output function	light / dark operate
output circuit	push-pull
output current	< 100 mA
short circuit protection	yes
reverse polarity protection	yes

**mechanical data**

width / diameter	20,2 mm
height / length	47,9 mm
depth	37,7 mm
type	rectangular
housing material	stainless steel 1.4404 (V4A)
front (optics)	PMMA
connection types	connector M12 4 pin

**ambient conditions**

operating temperature	-25 ... +60 °C
protection class	IP 68/69K & proTect+

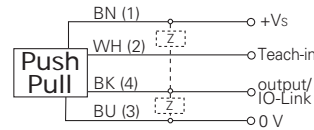
**connection diagram****connectors and mating connectors**

ESG 34AY0200 Connector M12, 4 pin, straight, 2 m, V4A-PP

ESW 33AY0200 Connector M12, 4 pin, angular, 2 m, V4A-PP

additional cable connectors and field wireable connectors: see accessories

**Accessories**

11092246	Mounting bracket O500/U500 (L design)
11111164	Mounting bracket O500/U500 - Retrofit for sensors series 30
11099942	Sensofix O500/U500
10134964	Mounting bracket series 14 (L design)
10149011	Sensofix series 14
11137318	Teach Pen for sensors in metal housing
11141124	Teach Pen for sensors in metal housing (USA, CAN, JP)

for details: see accessories section

order reference	background position Sde	scanning range Sa
O500W.SP-11137002	60 ... 600 mm	90% ... 85% Sde
O500W.SP-11137003	60 ... 800 mm	90% ... 80% Sde

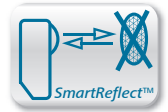

beam characteristic (typically)

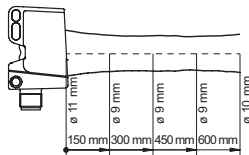

dimension drawing

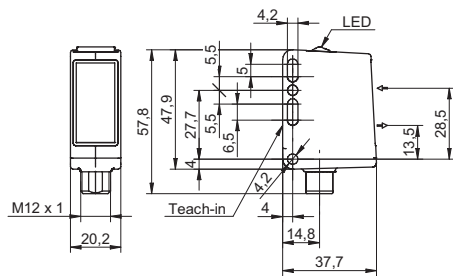

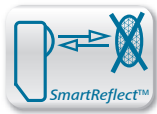

Sde = 60 ... 600 mm



- hygienic design
- PinPoint LED
- IO-Link

**general data**

type	light barrier
special type	hygienic design
version	standard object detection
light source	pulsed PinPoint LED
background position Sde	60 ... 600 mm
scanning range Sa	90% ... 85% Sde
power on indication	LED green
light indicator	LED yellow
sensing distance adjustment	Teach-in and IO-Link
wave length	630 nm
suppression of reciprocal influence	yes
alignment optical axis	< 1°
approvals/certificates	Ecolab

**electrical data**

response time / release time	< 0,49 ms
voltage supply range +Vs	10 ... 30 VDC
current consumption max. (no load)	40 mA
current consumption typ.	30 mA
voltage drop Vd	< 3 VDC
output function	light / dark operate
output circuit	push-pull
output current	< 100 mA
short circuit protection	yes
reverse polarity protection	yes

**mechanical data**

width / diameter	20,2 mm
height / length	47,7 mm
depth	36,4 mm
type	rectangular
housing material	stainless steel 1.4404 (V4A)
front (optics)	PMMA

**ambient conditions**

operating temperature	-25 ... +60 °C
protection class	IP 68/69K & proTect+

**order reference**

<b>O500H.SP-11125106</b>	cable 4 pin, 2 m
<b>O500H.SP-11125107</b>	flylead connector M12, L=300 mm

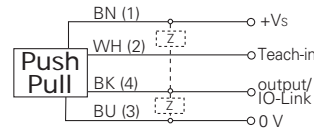
**connection types****connection diagram****connectors and mating connectors**

ESG 34AY0200	Connector M12, 4 pin, straight, 2 m, V4A-PP
ESW 33AY0200	Connector M12, 4 pin, angular, 2 m, V4A-PP

additional cable connectors and field wireable connectors: see accessories

**Accessories**

HI17-1H	Mounting for sensors in hygienic design Ø 17 mm
11137318	Teach Pen for sensors in metal housing
11141124	Teach Pen for sensors in metal housing (USA, CAN, JP)

for details: see accessories section



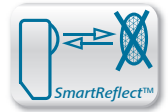

beam characteristic (typically)

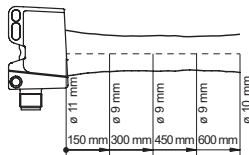

dimension drawings

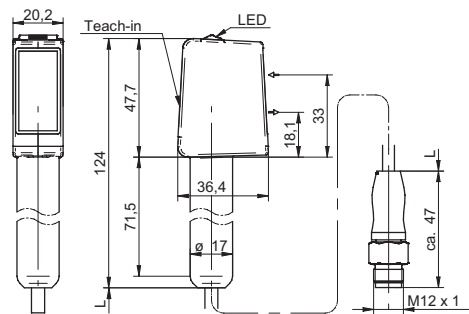
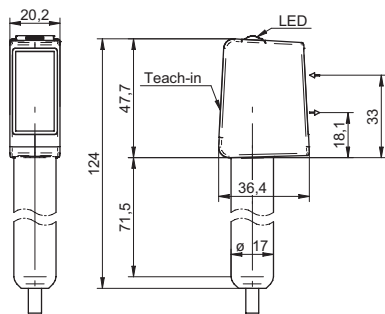

red light LED version

product family	FPCK 07	FPDK 07	FPDK 10	FPDM 12	O300.RP	O300.RR	FPDK 14
							
version	subminiature	subminiature	miniature	miniature	miniature	miniature	standard single lens optics
width / diameter	8 mm	8 mm	10,4 mm	12,4 mm	12,9 mm	12,9 mm	14,8 mm
actual range Sb	0,6 m	0,6 m	3,5 m	5 m	5 m	4 m	3,2 m 7 m
response time / release time	< 0,5 ms	< 0,5 ms	< 0,5 ms	< 1 ms	< 0,49 ms	< 0,49 ms	< 1 ms
light source	pulsed red LED	pulsed red LED	pulsed red LED	pulsed red LED	pulsed PinPoint LED	pulsed red LED	pulsed red LED
sensitivity adjustment	Teach-in	Teach-in	potentiometer, 240°	no	qTeach / remote qTeach	no	no
output circuit	NPN PNP	NPN PNP	NPN PNP	NPN PNP	push-pull NPN PNP	push-pull	NPN PNP
connection types	cable flylead connector	cable flylead connector	cable connector	cable connector	cable connector flylead connector	cable connector	cable connector
housing material	plastic	plastic	plastic	metal	plastic	plastic	plastic
protection class	IP 65	IP 65	IP 65 IP 67	IP 67	IP 67	IP 67	IP 67
<b>page</b>	<b>98</b>	<b>100</b>	<b>102</b>	<b>104</b>	<b>106</b>	<b>110</b>	<b>112</b>



O500.RP	O500.RR	FPDM 16	FPDK 20	FPAM 18	OR18.RR
					
standard	standard	standard	standard	standard	standard
18 mm	18 mm	15,4 mm	20 mm	18 mm	18 mm
7,5 m	7,5 m	7,3 m	5,5 m	3,2 m	3,5 m
< 0,49 ms	< 0,49 ms	< 1 ms	< 0,5 ms	< 1 ms	< 1 ms
pulsed PinPoint LED	pulsed red LED	pulsed red LED	pulsed red LED	pulsed red LED	pulsed red LED
qTeach / remote qTeach	no	potentiometer, 10 turn	potentiometer, 270°	no	potentiometer, 270°
push-pull NPN PNP	push-pull	NPN PNP	NPN PNP	NPN PNP	NPN PNP
cable connector	cable connector	cable connector	connector	cable connector	connector cable flylead connector
plastic	plastic	metal	plastic	metal	plastic
IP 67	IP 67	IP 67	IP 67	IP 67	IP 67
<b>114</b>	<b>116</b>	<b>118</b>	<b>120</b>	<b>122</b>	<b>124</b>





laser version

product family	OPDM 12	O300.RL	O300H.RL	O300W.RL	OPDK 14	OPDM 16	OR18.RL
							
version	miniature	miniature	miniature	miniature	standard	standard	standard
width / diameter	12,4 mm	12,9 mm	16,5 mm	16,5 mm	14,8 mm	15,4 mm	18 mm
actual range Sb	4,5 m 7 m	5 m	5 m	5 m	10 m	7,5 m 11 m	15 m
response time / release time	< 0,05 ms < 0,1 ms	< 0,1 ms	< 0,1 ms	< 0,1 ms	< 0,25 ms	< 0,1 ms	< 0,34 ms
light source	pulsed red laser diode	pulsed red laser diode	pulsed red laser diode	pulsed red laser diode	pulsed red laser diode	pulsed red laser diode	pulsed red laser diode
sensitivity adjustment	no	Teach-in and IO-Link qTeach	Teach-in and IO-Link	Teach-in and IO-Link	Teach-in	potentiometer, 270°	potentiometer, 270°
output circuit	NPN PNP	push-pull NPN PNP	push-pull	push-pull	PNP	PNP	NPN PNP
connection types	connector cable	cable connector	cable flylead connector	connector	cable connector	cable connector	cable connector
housing material	metal	plastic	metal	metal	plastic	metal	metal
protection class	IP 67	IP 67	IP 68/69K & proTect+	IP 68/69K & proTect+	IP 67	IP 67	IP 67
<b>page</b>	<b>126</b>	<b>128</b>	<b>130</b>	<b>132</b>	<b>134</b>	<b>136</b>	<b>138</b>









transparency detection

product family	O300.RP.T	O300W.RP.T	O300H.RP.T	FRDK 14	OPDK 14	FPDM 16	O500.RP.T
							
version	transparency object detection	transparency object detection	transparency object detection	for transparent objects	for transparent objects single lens optics	for transparent objects	transparency object detection
width / diameter	12,9 mm	16,5 mm	16,5 mm	14,8 mm	14,8 mm	15,4 mm	18 mm
actual range Sb	3,5 m	3,5 m	3,5 m	7 m	4,5 m	6 m	5,5 m
response time / release time	< 0,25 ms	< 0,25 ms	< 0,25 ms	< 0,1 ms	< 0,25 ms	< 2,5 ms	< 0,25 ms
sensitivity adjustment	Teach-in and IO-Link	Teach-in and IO-Link	Teach-in and IO-Link	Teach-in	Teach-in	Teach-in	Teach-in and IO-Link
output circuit	push-pull	push-pull	push-pull	NPN PNP	PNP	PNP	push-pull
connection types	cable connector	connector	cable flylead connector	cable connector	cable connector	connector	cable connector
housing material	plastic	metal	metal	plastic	plastic	metal	plastic
protection class	IP 67	IP 68/69K & proTect+	IP 68/69K & proTect+	IP 67	IP 67	IP 67	IP 67
<b>page</b>	<b>140</b>	<b>142</b>	<b>144</b>	<b>146</b>	<b>148</b>	<b>150</b>	<b>152</b>

O500W.RP.T	O500H.RP.T	OR18.RR.T	OR18W.RR.T
			
transparency object detection	transparency object detection	transparency object detection	transparency object detection
20,2 mm	20,2 mm	18 mm	18 mm
5,5 m	5,5 m	0,5 m	0,5 m
< 0,25 ms	< 0,25 ms	< 1 ms	< 1 ms
Teach-in and IO-Link	Teach-in and IO-Link	potentiometer, 270°	potentiometer, 270°
push-pull	push-pull	NPN PNP	NPN PNP
connector	cable flylead connector	connector	connector
metal	metal	plastic	metal
IP 68/69K & proTect+	IP 68/69K & proTect+	IP 67	IP 67/69K
<b>154</b>	<b>156</b>	<b>158</b>	<b>160</b>

stainless steel sensors in washdown or hygienic design

product family	O300W.RP	O300H.RP	FPDR 14	FPDH 14	O500W.RP	O500W.RP	O500H.RP
							
	miniature	miniature	standard	standard	standard	standard	standard
width / diameter	16,5 mm	16,5 mm	19,6 mm	19,6 mm	20,2 mm	20,2 mm	20,2 mm
actual range Sb	5 m	5 m	3 m	3 m	7,5 m	7,5 m	7,5 m
response time / release time	< 0,49 ms	< 0,49 ms	< 1 ms	< 1 ms	< 0,49 ms	< 0,49 ms	< 0,49 ms
light source	pulsed PinPoint LED	pulsed PinPoint LED	pulsed red LED	pulsed red LED	pulsed PinPoint LED	pulsed PinPoint LED	pulsed PinPoint LED
sensitivity adjustment	qTeach / remote	Teach-in: remote	no	no	qTeach / remote	Teach-in: remote	Teach-in: remote
output circuit	push-pull	push-pull	NPN PNP	NPN PNP	push-pull	push-pull	push-pull
connection types	connector	cable flylead connector	connector	cable flylead connector	connector	connector	cable flylead connector
housing material	metal	metal	metal	metal	metal	metal	metal
protection class	IP 68/69K & proTect+	IP 68/69K & proTect+	IP 68/69K & proTect+	IP 68/69K & proTect+	IP 68/69K & proTect+	IP 68/69K & proTect+	IP 68/69K & proTect+
<b>page</b>	<b>162</b>	<b>164</b>	<b>166</b>	<b>168</b>	<b>170</b>	<b>172</b>	<b>174</b>



OR18W.RR



standard

18 mm

3,5 m

< 1 ms

pulsed red LED

potentiometer,  
270°

NPN  
PNP

connector

metal

IP 67/69K

176



## General information

The emitter and receiver are installed in the same housing. The emitted infrared, red or laser light is returned by a triple reflector or a reflective film to the receiver. The output changes its state when the object breaks the light beam (sensor receives no light).

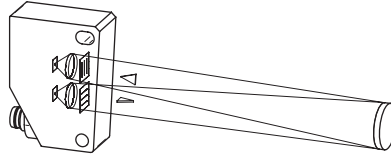

## Applications

- Stack height monitoring
- Detection of objects located at any position on a conveyor belt
- Detection of transparent objects
- Detection of glossy objects on a conveyor belt
- Retro-reflective laser sensors with single-lens optics allow the precise detection of objects through small openings and the smallest distances between the sensor and the reflector.

## Characteristics and advantages

### Polarizing filter

This filter allows objects to be detected regardless of the texture and color of the surface. Glossy and reflective objects are also reliably detected.

### Single-lens optics

Because the emitted and received beams are on the same axis, the direction of approach of the object is irrelevant, and it is possible to look through small openings. Reflectors can also be used in close-range without signal breakdown.

### Transparent objects

Special versions of retro-reflective sensors can also reliably detect transparent objects such as packaging films, PET bottles and glassware.

### Short response times

Retro-reflective laser sensors with response times of 0,05 ms and focused laser beams correctly detect the smallest, fast-moving objects (0,1 mm in diameter).

## Technology and operation

The polarizing filter permits the emitted light to pass in only one polarization plane. The triple reflector depolarizes the light on reflection. A part of the light reflected back to the receiver passes the second polarization filter, offset by 90°, and is detected by the receiver.

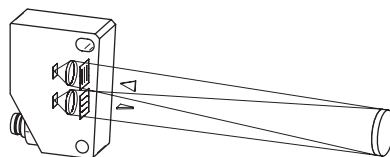



## Technology and operation

A glossy object in the light beam reflects the light without changing its polarization direction. This light cannot pass through the polarization filter in front of the receive. A glossy object therefore also breaks the light beam.

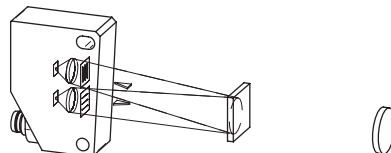

## Mounting and adjustment

Each sensor has a separate excess gain curve. As the operating reliability depends heavily on the ambient conditions, it must be ensured that the sensor operates with the highest possible excess signal gain.

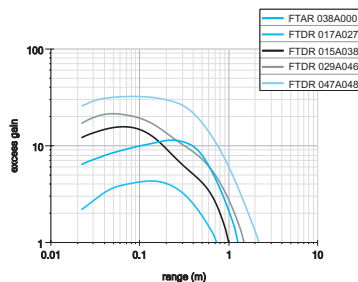

With narrow light beams as used in laser sensors, the size of the light spot on the reflector in relation to the triple structure is crucial factor when it comes to choosing the reflector or the reflective type. A special reflective type or reflector for laser sensors should be used for spot diameters of up to 1,5mm, while the use of reflectors with microstructures is recommended for spot diameters of up to 3 mm. It should also be ensured that the reflective type or reflector is not placed close to the focus.

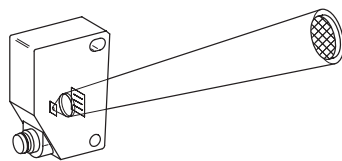

The reflector is aligned and centered.

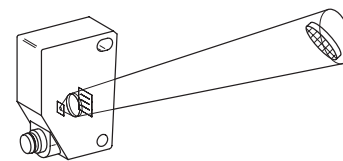

The reflector may not be tilted by more than 15°.

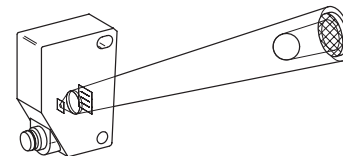
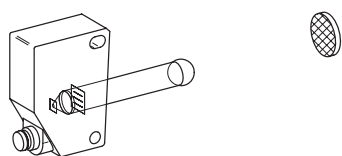

For a correct function, the object must cover the reflector or at least have the size of the beam diameter on the distance.

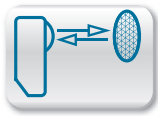

$S_b = 0,6 \text{ m}$



- compact housing
- sensing range adjustable via Teach-in
- suppression of mutual interference

#### general data

type	retro-reflective sensor
light source	pulsed red LED
actual range $S_b$	0,6 m
nominal range $S_n$	0,8 m
polarization filter	yes
alignment / soiled lens indicator	flashing light indicator
light indicator	LED green
output indicator	LED yellow
sensitivity adjustment	Teach-in
wave length	660 nm
suppression of reciprocal influence	yes

#### electrical data

response time / release time	< 0,5 ms
voltage supply range +Vs	10 ... 30 VDC
current consumption max. (no load)	25 mA
current consumption typ.	20 mA
voltage drop Vd	< 1,8 VDC
output function	light / dark operate
output current	< 100 mA
short circuit protection	yes
reverse polarity protection	yes

#### mechanical data

width / diameter	8 mm
height / length	17,8 mm
depth	12,6 mm
type	rectangular
housing material	plastic (PMMA, MABS, PA)
front (optics)	PMMA

#### ambient conditions

operating temperature	-20 ... +50 °C
protection class	IP 65

#### connection diagrams

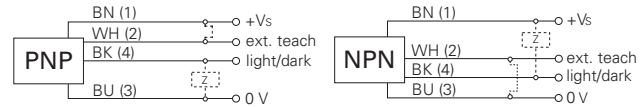

#### connectors and mating connectors

ESG 32AH0200	Connector M8, 4 pin, straight, 2 m
ESW 31AH0200	Connector M8, 4 pin, angular, 2 m

additional cable connectors and field wireable connectors: see accessories

#### Accessories

10150844	Minofix mounting 07
----------	---------------------

for details: see accessories section

order reference	connection types	output circuit
FPCK 07N6901	cable rear side, 2 m	NPN
FPCK 07N6901/KS35A	flylead connector M8 4 pin, L=200 mm	NPN
FPCK 07P6901	cable rear side, 2 m	PNP
FPCK 07P6901/KS35A	flylead connector M8 4 pin, L=200 mm	PNP

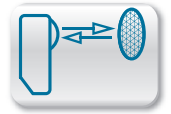

excess gain curves

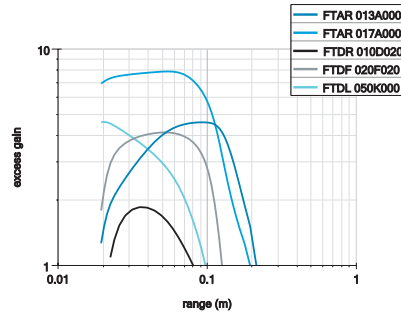
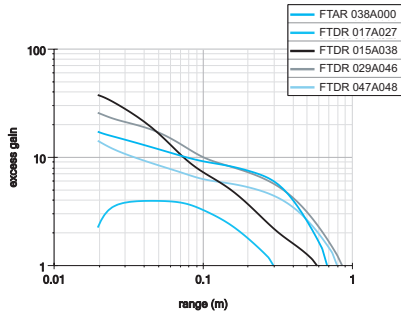

reflectors

FTAR 013A000	∅ 15 mm	Sn = 210 mm
FTAR 017A000	∅ 20,7 mm	Sn = 190 mm
FTAR 036A000	∅ 46 mm	Sn = 680 mm
FTDR 010D020	15 x 25 mm	Sn = 80 mm
FTDR 017A027	20 x 42 mm	Sn = 290 mm
FTDR 015A038	18 x 40 mm	Sn = 570 mm
FTDR 029A046	32,5 x 48 mm	Sn = 830 mm
FTDR 047A048	54 x 75 mm	Sn = 790 mm
FTDF 020F020	20 x 20 mm	Sn = 120 mm
FTDL 050K000/... m	tape 50x... mm	Sn = 97 mm

dimension drawings

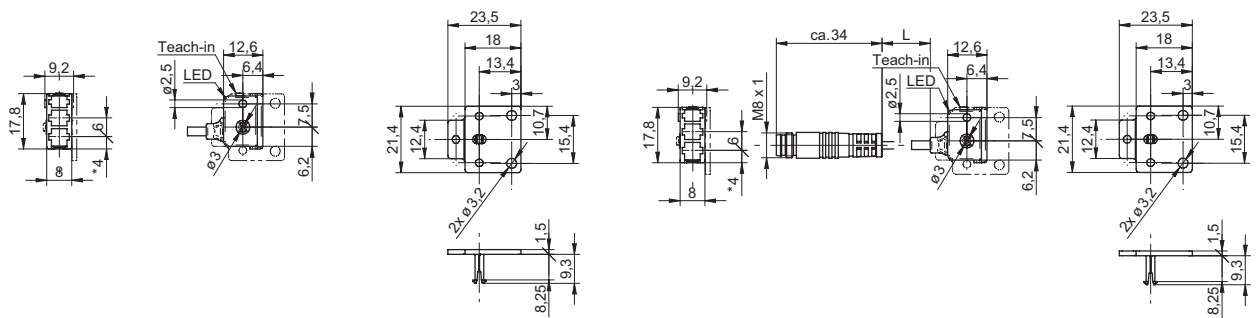

\* emitter axis

\* emitter axis cable length L = 200 mm

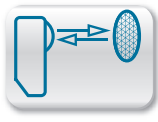

$S_b = 0,6 \text{ m}$

- compact housing
- sensing range adjustable via Teach-in
- suppression of mutual interference



#### general data

type	retro-reflective sensor
light source	pulsed red LED
actual range $S_b$	0,6 m
nominal range $S_n$	0,8 m
polarization filter	yes
alignment / soiled lens indicator	flashing light indicator
light indicator	LED green
output indicator	LED yellow
sensitivity adjustment	Teach-in
wave length	660 nm
suppression of reciprocal influence	yes

#### electrical data

response time / release time	< 0,5 ms
voltage supply range +Vs	10 ... 30 VDC
current consumption max. (no load)	25 mA
current consumption typ.	20 mA
voltage drop $V_d$	< 1,8 VDC
output function	light / dark operate
output current	< 100 mA
short circuit protection	yes
reverse polarity protection	yes

#### mechanical data

width / diameter	8 mm
height / length	17,8 mm
depth	12,6 mm
type	rectangular
housing material	plastic (PMMA, MABS, PA)
front (optics)	PMMA

#### ambient conditions

operating temperature	-20 ... +50 °C
protection class	IP 65

#### connection diagrams



#### connectors and mating connectors

ESG 32AH0200	Connector M8, 4 pin, straight, 2 m
ESW 31AH0200	Connector M8, 4 pin, angular, 2 m

additional cable connectors and field wireable connectors: see accessories

#### Accessories

10150844	Minofix mounting 07
----------	---------------------

for details: see accessories section

order reference	connection types	output circuit
FPDK 07N6901	cable bottom side, 2 m	NPN
FPDK 07N6901/KS35A	flylead connector M8 4 pin, L=200 mm	NPN
FPDK 07P6901	cable bottom side, 2 m	PNP
FPDK 07P6901/KS35A	flylead connector M8 4 pin, L=200 mm	PNP

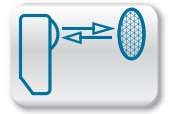

excess gain curves

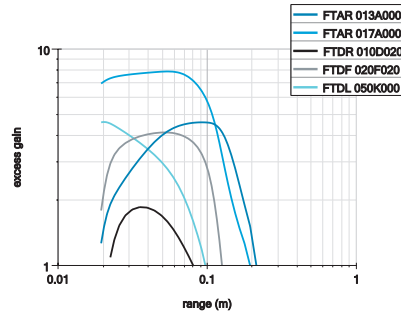
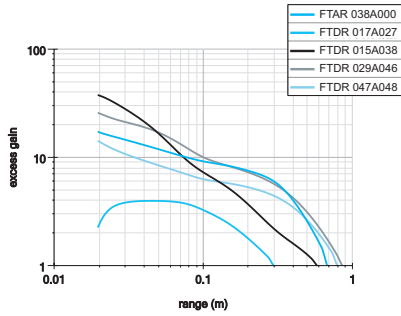

reflectors

FTAR 013A000	∅ 15 mm	Sn = 210 mm
FTAR 017A000	∅ 20,7 mm	Sn = 190 mm
FTAR 036A000	∅ 46 mm	Sn = 680 mm
FTDR 010D020	15 x 25 mm	Sn = 80 mm
FTDR 017A027	20 x 42 mm	Sn = 290 mm
FTDR 015A038	18 x 40 mm	Sn = 570 mm
FTDR 029A046	32,5 x 48 mm	Sn = 830 mm
FTDR 047A048	54 x 75 mm	Sn = 790 mm
FTDF 020F020	20 x 20 mm	Sn = 120 mm
FTDL 050K000/... m	tape 50x... mm	Sn = 97 mm

dimension drawings

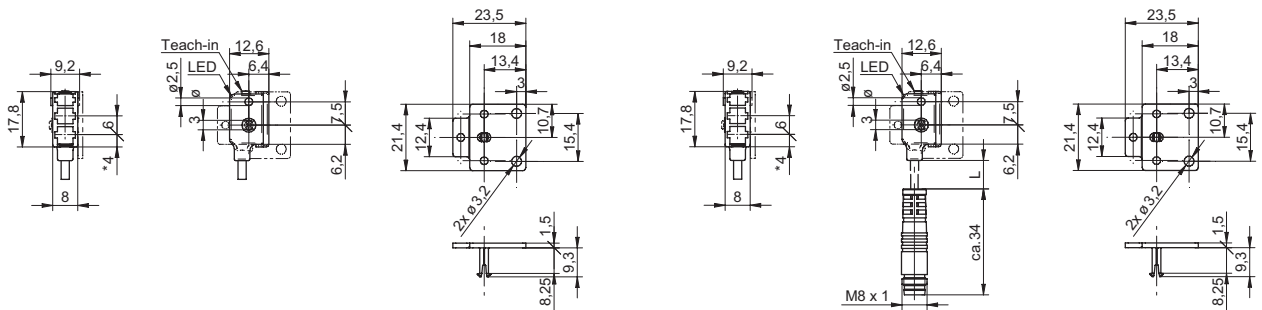

\* emitter axis

\* emitter axis cable length L = 200 mm

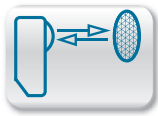

Sb = 3,5 m

- compact housing
- polarization filter to detect shiny objects
- suppression of mutual interference



**general data**

type	retro-reflective sensor
light source	pulsed red LED
actual range Sb	3,5 m
nominal range Sn	4 m
polarization filter	yes
alignment / soiled lens indicator	flashing light indicator
light indicator	LED yellow
wave length	660 nm
suppression of reciprocal influence	yes

**electrical data**

response time / release time	< 0,5 ms
voltage supply range +Vs	10 ... 30 VDC
current consumption max. (no load)	25 mA
current consumption typ.	20 mA
voltage drop Vd	< 1,8 VDC
output function	light / dark operate
output current	< 100 mA
short circuit protection	yes
reverse polarity protection	yes

**mechanical data**

width / diameter	10,4 mm
height / length	27 mm
depth	16,3 mm
type	rectangular
housing material	plastic (ASA)
front (optics)	PMMA

**ambient conditions**

operating temperature	-25 ... +65 °C
-----------------------	----------------

**connection diagrams**



**connectors and mating connectors**

ESG 32AH0200	Connector M8, 4 pin, straight, 2 m
ESW 31AH0200	Connector M8, 4 pin, angular, 2 m

additional cable connectors and field wireable connectors: see accessories

**Accessories**

10150326	Sensofix series 10 / series 20
10114501	Mounting bracket series 10 (U design)
10133792	Mounting bracket series 10 (L design)
10162083	Mounting panel for sensors series 10
10118798	Mounting bracket series 10

for details: see accessories section

order reference	connection types	output circuit	sensitivity adjustment	protection class
FPDK 10N5130	cable 4 pin, 2 m	NPN	no	IP 65
FPDK 10N5130/S35A	connector M8 4 pin	NPN	no	IP 67
FPDK 10N5135	cable 4 pin, 2 m	NPN	potentiometer, 240°	IP 65
FPDK 10N5135/S35A	connector M8 4 pin	NPN	potentiometer, 240°	IP 67
FPDK 10P5130	cable 4 pin, 2 m	PNP	no	IP 65
FPDK 10P5130/S35A	connector M8 4 pin	PNP	no	IP 67
FPDK 10P5135	cable 4 pin, 2 m	PNP	potentiometer, 240°	IP 65
FPDK 10P5135/S35A	connector M8 4 pin	PNP	potentiometer, 240°	IP 67



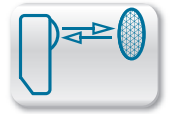

excess gain curves

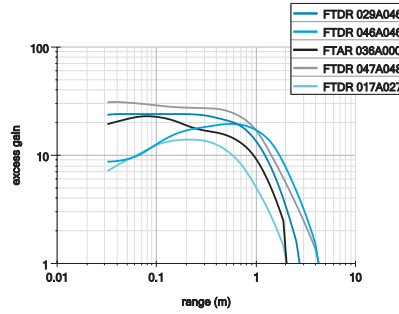
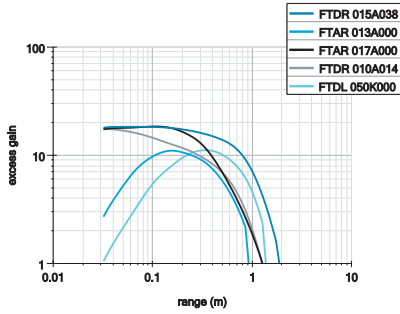

reflectors

FTAR 013A000	∅ 15 mm	Sh = 0,9 m
FTAR 017A000	∅ 20,7 mm	Sh = 1,2 m
FTAR 036A000	∅ 46 mm	Sh = 2 m
FTDR 010D014	12,8 x 16,8 mm	Sh = 1,2 m
FTDR 017A027	20 x 42 mm	Sh = 2 m
FTDR 015A038	18 x 40 mm	Sh = 1,8 m
FTDR 029A046	32,5 x 48 mm	Sh = 2,7 m
FTDR 047A048	54 x 75 mm	Sh = 4 m
FTDL 050K000/... m	tape 50 x ... mm	Sh = 1,3 m

dimension drawings

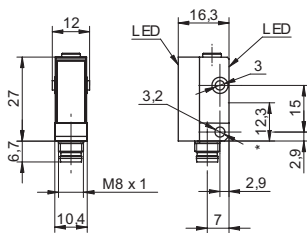

\* emitter axis

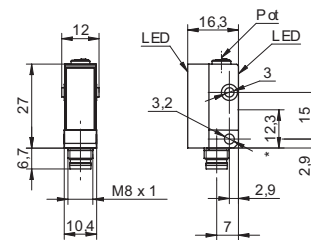

\* emitter axis

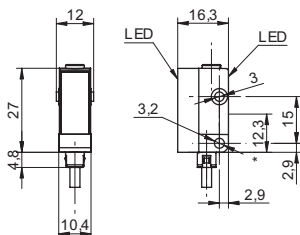

\* emitter axis

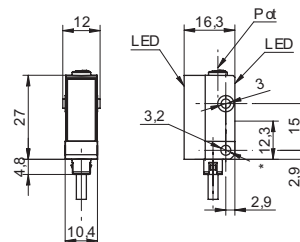

\* emitter axis

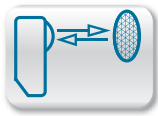

S<sub>b</sub> = 5 m

- rugged miniature metal housing
- polarization filter to detect shiny objects
- available with alarm output



**general data**

type	retro-reflective sensor
light source	pulsed red LED
actual range S <sub>b</sub>	5 m
nominal range S <sub>n</sub>	5,2 m
polarization filter	yes
alignment / soiled lens indicator	flashing light indicator
light indicator	LED yellow
sensitivity adjustment	no
wave length	660 nm
suppression of reciprocal influence	yes

**electrical data**

response time / release time	< 1 ms
voltage supply range +Vs	10 ... 30 VDC
current consumption max. (no load)	35 mA
current consumption typ.	25 mA
voltage drop V <sub>d</sub>	< 1,8 VDC
output current	< 100 mA
short circuit protection	yes
reverse polarity protection	yes

**mechanical data**

width / diameter	12,4 mm
height / length	35 mm
depth	35 mm
type	rectangular
housing material	die-cast zinc
front (optics)	PMMA

**ambient conditions**

operating temperature	-25 ... +65 °C
protection class	IP 67

**connection diagrams**

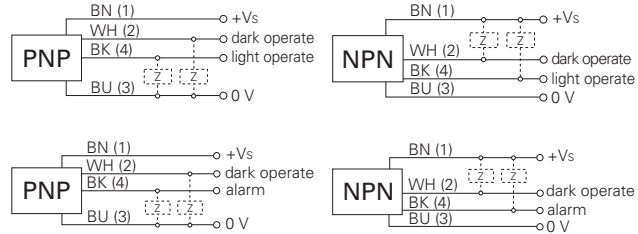

**connectors and mating connectors**

ESG 32AH0200	Connector M8, 4 pin, straight, 2 m
ESW 31AH0200	Connector M8, 4 pin, angular, 2 m
additional cable connectors and field wireable connectors: see accessories	

**Accessories**

10150328	Sensofix series 12
10113873	Mounting bracket series 12 (L design)
for details: see accessories section	

order reference	connection types	output circuit	output function
FPDM 12N3401	cable 4 pin, 2 m	NPN	alarm output dark
FPDM 12N3401/S35A	connector M8 4 pin	NPN	alarm output dark
FPDM 12N5101	cable 4 pin, 2 m	NPN	light / dark operate
FPDM 12N5101/S35A	connector M8 4 pin	NPN	light / dark operate
FPDM 12P3401	cable 4 pin, 2 m	PNP	alarm output dark
FPDM 12P3401/S35A	connector M8 4 pin	PNP	alarm output dark
FPDM 12P5101	cable 4 pin, 2 m	PNP	light / dark operate
FPDM 12P5101/S35A	connector M8 4 pin	PNP	light / dark operate

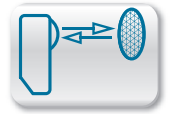

excess gain curves

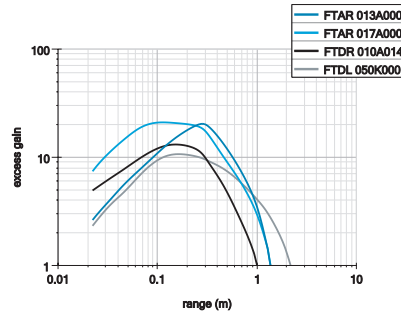
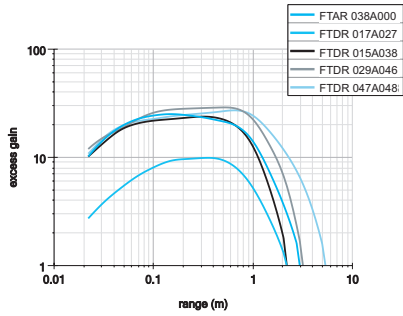

reflectors

FTAR 013A000	∅ 15 mm	Sn = 1,2 m
FTAR 017A000	∅ 20,7 mm	Sn = 1,2 m
FTAR 036A000	∅ 46 mm	Sn = 2,9 m
FTDR 010D014	12,8 x 16,8 mm	Sn = 1 m
FTDR 017A027	20 x 42 mm	Sn = 2,1 m
FTDR 015A038	18 x 40 mm	Sn = 2,1 m
FTDR 029A046	32,5 x 48 mm	Sn = 3,1 m
FTDR 047A048	54 x 75 mm	Sn = 5,2 m
FTDL 050K000/... m	tape 50 x ... mm	Sn = 2,1 m

dimension drawings

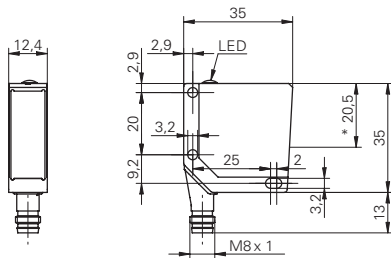

\* emitter axis

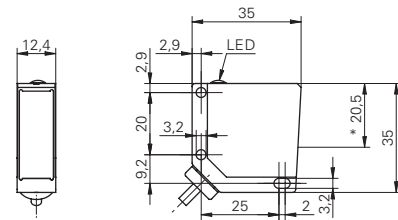

\* emitter axis

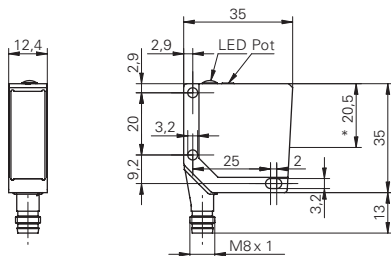

\* emitter axis

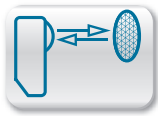

S<sub>b</sub> = 5 m

- One inch class
- PinPoint LED
- polarization filter to detect shiny objects



**general data**

type	retro-reflective sensor
light source	pulsed PinPoint LED
actual range S <sub>b</sub>	5 m
nominal range S <sub>n</sub>	6 m
polarization filter	yes
light indicator	LED yellow
power on indication	LED green
wave length	630 nm
suppression of reciprocal influence	yes
alignment optical axis	< 2°

**electrical data**

response time / release time	< 0,49 ms
voltage supply range +Vs	10 ... 30 VDC
current consumption max. (no load)	35 mA
current consumption typ.	25 mA
voltage drop V <sub>d</sub>	< 3 VDC
output current	< 100 mA
short circuit protection	yes
reverse polarity protection	yes

**mechanical data**

width / diameter	12,9 mm
height / length	32,3 mm
depth	23 mm
type	rectangular
housing material	plastic (ASA, PMMA)
front (optics)	PMMA

**ambient conditions**

operating temperature	-25 ... +60 °C
protection class	IP 67

**connection diagrams**

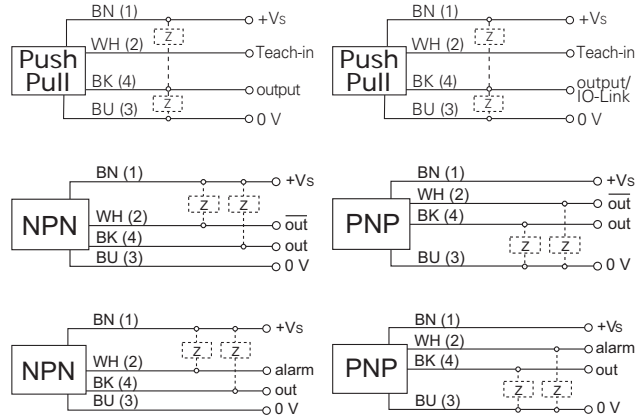

**connectors and mating connectors**

ESG 32AH0200	Connector M8, 4 pin, straight, 2 m
ESW 31AH0200	Connector M8, 4 pin, angular, 2 m
ESG 34AH0200	Connector M12, 4 pin, straight, 2 m
ESW 33AH0200	Connector M12, 4 pin, angular, 2 m

additional cable connectors and field wireable connectors: see accessories

**Accessories**

11104963	Sensofix O300
11102423	Mounting bracket O300 (L design)
11124807	Mounting bracket O300 - Retrofit for sensors series 20

for details: see accessories section

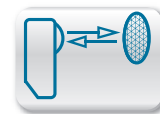

order reference	connection types	output circuit	output function	sensitivity adjustment
<b>O300.RP-11120107</b>	cable 4 pin, 2 m	push-pull	light / dark operate	qTeach / remote
<b>O300.RP-11110449</b>	connector M8 4 pin	push-pull	light / dark operate	qTeach / remote
<b>O300.RP-11143019</b>	flylead connector M8, L=200 mm	push-pull	light / dark operate	qTeach / remote
<b>O300.RP-11120129</b>	flylead connector M12, L=200 mm	push-pull	light / dark operate	qTeach / remote
<b>O300.RP-11120110</b>	cable 4 pin, 2 m	NPN complementary	light / dark operate	qTeach
<b>O300.RP-11110447</b>	connector M8 4 pin	NPN complementary	light / dark operate	qTeach
<b>O300.RP-11120112</b>	cable 4 pin, 2 m	NPN	light / dark operate, alarm	qTeach
<b>O300.RP-11110448</b>	connector M8 4 pin	NPN	light / dark operate, alarm	qTeach
<b>O300.RP-11120120</b>	cable 4 pin, 2 m	PNP complementary	light / dark operate	qTeach
<b>O300.RP-11110445</b>	connector M8 4 pin	PNP complementary	light / dark operate	qTeach
<b>O300.RP-11120121</b>	cable 4 pin, 2 m	PNP	light / dark operate, alarm	qTeach
<b>O300.RP-11110446</b>	connector M8 4 pin	PNP	light / dark operate, alarm	qTeach

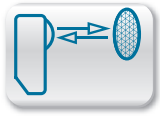

Sb = 5 m

O300.RP

Retro-reflective sensors

excess gain curves

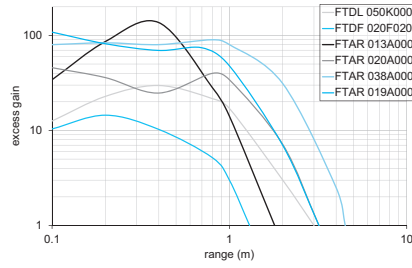
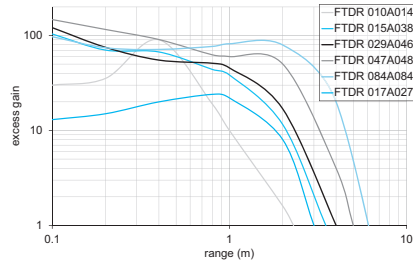

beam characteristic (typically)

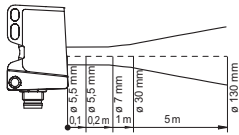

dimension drawings

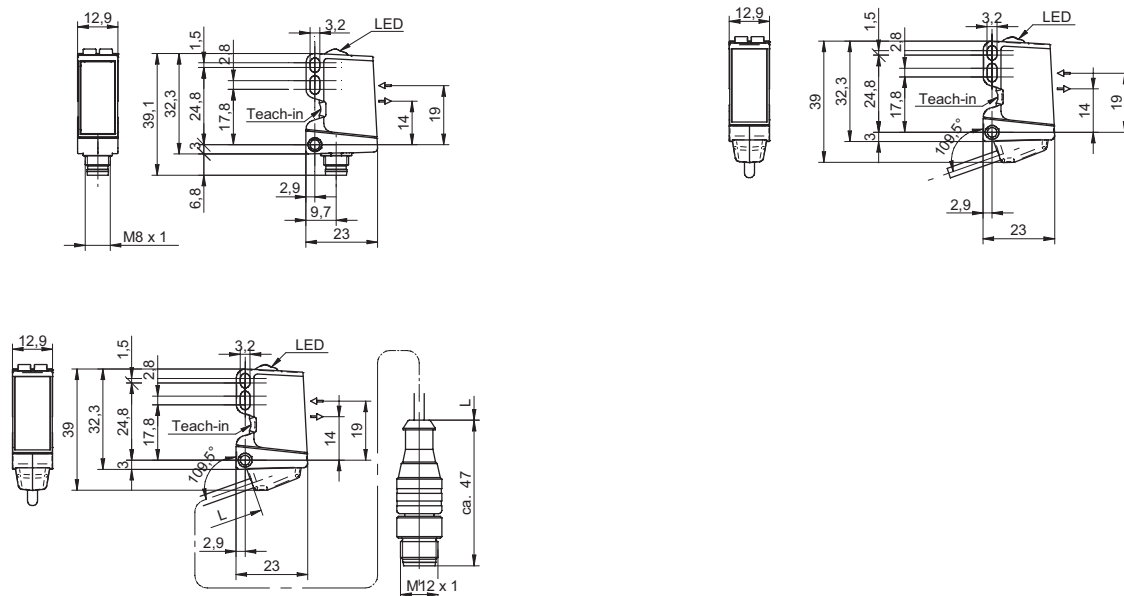

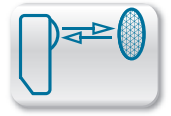

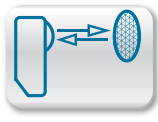

Sb = 4 m

- One inch class
- polarization filter to detect shiny objects

**general data**

type	retro-reflective sensor
light source	pulsed red LED
actual range Sb	4 m
nominal range Sn	5 m
polarization filter	yes
light indicator	LED yellow
power on indication	LED green
sensitivity adjustment	no
wave length	630 nm
suppression of reciprocal influence	yes
alignment optical axis	< 2°

**electrical data**

response time / release time	< 0,49 ms
voltage supply range +Vs	10 ... 30 VDC
current consumption max. (no load)	30 mA
current consumption typ.	30 mA
voltage drop Vd	< 3 VDC
output circuit	push-pull
output current	< 100 mA
short circuit protection	yes
reverse polarity protection	yes

**mechanical data**

width / diameter	12,9 mm
height / length	32,3 mm
depth	23 mm
type	rectangular
housing material	plastic (ASA, PMMA)
front (optics)	PMMA

**ambient conditions**

operating temperature	-25 ... +60 °C
protection class	IP 67

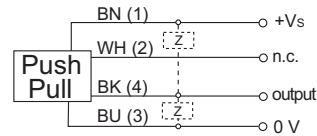
**connection diagram****connectors and mating connectors**

ESG 32AH0200	Connector M8, 4 pin, straight, 2 m
ESW 31AH0200	Connector M8, 4 pin, angular, 2 m

additional cable connectors and field wireable connectors: see accessories

**Accessories**

11104963	Sensofix O300
11102423	Mounting bracket O300 (L design)
11124807	Mounting bracket O300 - Retrofit for sensors series 20

for details: see accessories section

order reference	connection types	output function
O300.RR-11120118	cable 4 pin, 2 m	dark operate
O300.RR-11110444	connector M8 4 pin	dark operate
O300.RR-11120114	cable 4 pin, 2 m	light operate
O300.RR-11110443	connector M8 4 pin	light operate



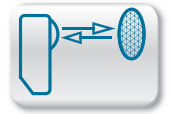

excess gain curves

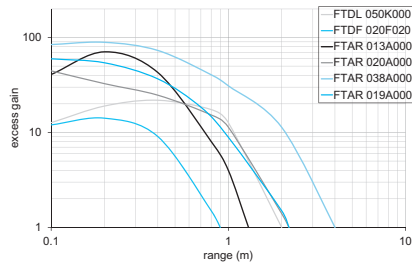
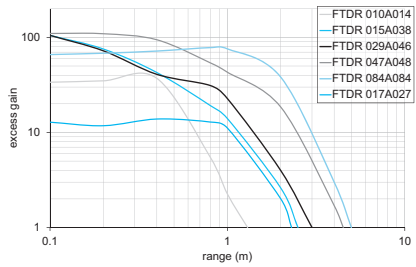

beam characteristic (typically)

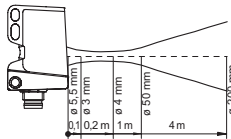

dimension drawings

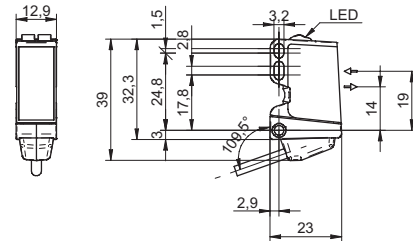
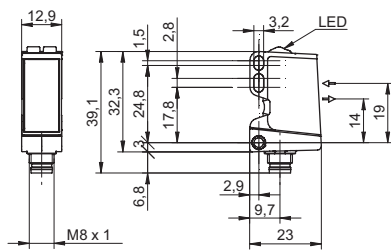

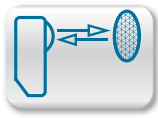

Sb = 7 m

- polarization filter to detect shiny objects
- single lens optics (FPDK 14x5111/S35A)
- suppression of mutual interference



**general data**

type	retro-reflective sensor
light source	pulsed red LED
polarization filter	yes
alignment / soiled lens indicator	flashing light indicator
light indicator	LED yellow
sensitivity adjustment	no
wave length	660 nm
suppression of reciprocal influence	yes

**actual range Sb = 3,2 m**

version	single lens optics
nominal range Sn	3,8 m

**actual range Sb = 7 m**

nominal range Sn	7,2 m
------------------	-------

**electrical data**

response time / release time	< 1 ms
voltage supply range +Vs	10 ... 30 VDC
current consumption max. (no load)	25 mA
current consumption typ.	20 mA
voltage drop Vd	< 1,8 VDC
output function	light / dark operate
output current	< 100 mA
short circuit protection	yes
reverse polarity protection	yes

**mechanical data**

width / diameter	14,8 mm
height / length	43 mm
depth	31 mm
type	rectangular
housing material	plastic (ASA, MABS)
front (optics)	PMMA

**ambient conditions**

operating temperature	-25 ... +65 °C
protection class	IP 67

**connection diagrams**



**connectors and mating connectors**

ESG 34AH0200	Connector M12, 4 pin, straight, 2 m
ESW 33AH0200	Connector M12, 4 pin, angular, 2 m
ESG 32AH0200	Connector M8, 4 pin, straight, 2 m
ESW 31AH0200	Connector M8, 4 pin, angular, 2 m

additional cable connectors and field wireable connectors: see accessories

**Accessories**

10149011	Sensofix series 14
10134964	Mounting bracket series 14 (L design)

for details: see accessories section

order reference	actual range Sb	connection types	output circuit
FPDK 14N5101	7 m	cable 4 pin, 2 m	NPN
FPDK 14N5101/S14	7 m	connector M12 4 pin	NPN
FPDK 14N5101/S35A	7 m	connector M8 4 pin	NPN
FPDK 14N5111	3,2 m	cable 4 pin, 2 m	NPN
FPDK 14N5111/S14	3,2 m	connector M12 4 pin	NPN
FPDK 14N5111/S35A	3,2 m	connector M8 4 pin	NPN
FPDK 14P5101	7 m	cable 4 pin, 2 m	PNP
FPDK 14P5101/S14	7 m	connector M12 4 pin	PNP
FPDK 14P5101/S35A	7 m	connector M8 4 pin	PNP
FPDK 14P5111	3,2 m	cable 4 pin, 2 m	PNP
FPDK 14P5111/S14	3,2 m	connector M12 4 pin	PNP
FPDK 14P5111/S35A	3,2 m	connector M8 4 pin	PNP

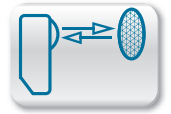

excess gain curves

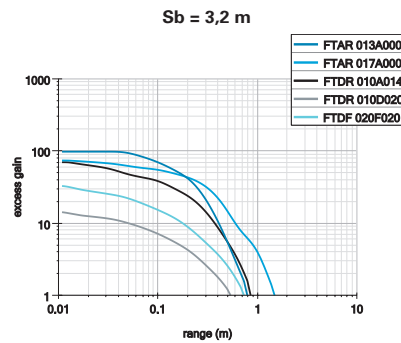
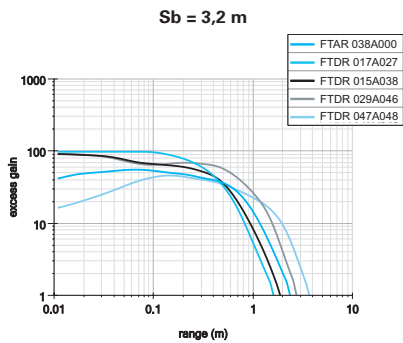
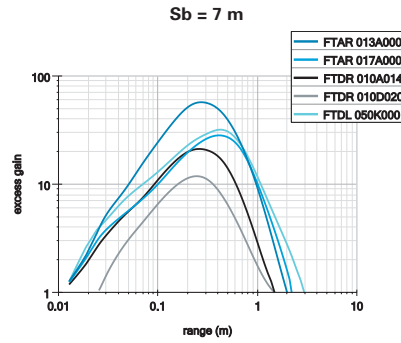
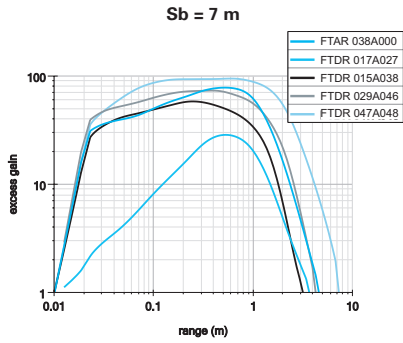

reflectors

FTAR 013A000	∅ 15 mm	Sn = 2 m
FTAR 017A000	∅ 20,7 mm	Sn = 2,1 m
FTAR 036A000	∅ 46 mm	Sn = 4,5 m
FTDR 010D14	12,8 x 16,8 mm	Sn = 1,4 m
FTDR 010D020	15 x 25 mm	Sn = 1,4 m
FTDR 017A027	20 x 42 mm	Sn = 3,6 m
FTDR 015A038	18 x 40 mm	Sn = 3,1 m
FTDR 029A046	32,5 x 48 mm	Sn = 4,2 m
FTDR 047A048	54 x 75 mm	Sn = 7,2 m
FTDL 050K000/... m	tape 50 x ... mm	Sn = 2,9 m

FTAR 013A000	∅ 15 mm	Sn = 0,8 m
FTAR 017A000	∅ 20,7 mm	Sn = 1,4 m
FTAR 036A000	∅ 46 mm	Sn = 2,2 m
FTDR 010D14	12,8 x 16,8 mm	Sn = 0,8 m
FTDR 010D020	15 x 25 mm	Sn = 0,5 m
FTDR 017A027	20 x 42 mm	Sn = 1,5 m
FTDR 015A038	18 x 40 mm	Sn = 1,8 m
FTDR 029A046	32,5 x 48 mm	Sn = 2,8 m
FTDR 047A048	54 x 75 mm	Sn = 3,8 m
FTDF 020F020	20 x 20 mm	Sn = 0,7 m

dimension drawings

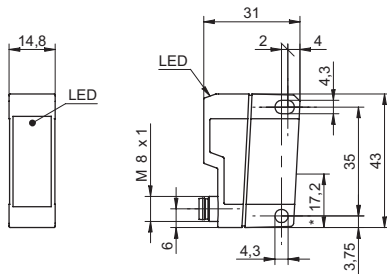

\* emitter axis FPKD 14x5101/S35A

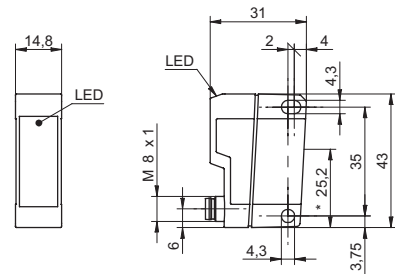

\* emitter and receiver axis FPKD 14x5111... single lens optics

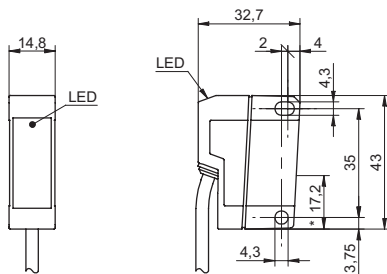

\* emitter axis FPKD 14x5101

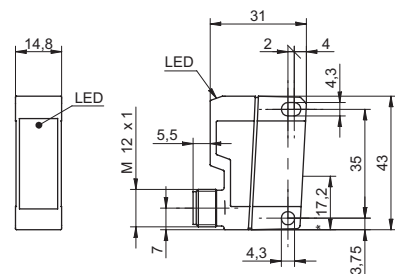

\* emitter axis FPKD 14x5101/S14

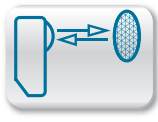

S<sub>b</sub> = 7,5 m

- PinPoint LED
- polarization filter to detect shiny objects
- small beam diameter



**general data**

type	retro-reflective sensor
light source	pulsed PinPoint LED
actual range S <sub>b</sub>	7,5 m
nominal range S <sub>n</sub>	8 m
polarization filter	yes
light indicator	LED yellow
power on indication	LED green
wave length	630 nm
suppression of reciprocal influence	yes
alignment optical axis	< 1°

**electrical data**

response time / release time	< 0,49 ms
voltage supply range +Vs	10 ... 30 VDC
current consumption max. (no load)	40 mA
current consumption typ.	30 mA
voltage drop V <sub>d</sub>	< 3 VDC
output function	light / dark operate
output current	< 100 mA
short circuit protection	yes
reverse polarity protection	yes

**mechanical data**

width / diameter	18 mm
height / length	45 mm
depth	32 mm
type	rectangular
housing material	plastic (ASA, PMMA)
front (optics)	PMMA

**ambient conditions**

operating temperature	-25 ... +60 °C
protection class	IP 67

**connection diagrams**

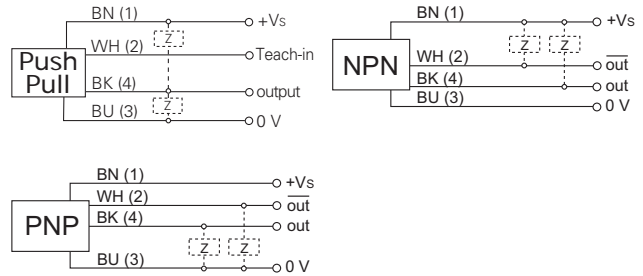

**connectors and mating connectors**

ESG 34AH0200	Connector M12, 4 pin, straight, 2 m
ESW 33AH0200	Connector M12, 4 pin, angular, 2 m
additional cable connectors and field wireable connectors: see accessories	

**Accessories**

11099942	Sensofix O500/U500
11092246	Mounting bracket O500/U500 (L design)
11111164	Mounting bracket O500/U500 - Retrofit for sensors series 30

for details: see accessories section

order reference	connection types	output circuit	sensitivity adjustment
O500.RP-11096103	cable 4 pin, 2 m	push-pull	qTeach / remote
O500.RP-11096098	connector M12 4 pin	push-pull	qTeach / remote
O500.RP-11096101	cable 4 pin, 2 m	NPN complementary	qTeach
O500.RP-11096096	connector M12 4 pin	NPN complementary	qTeach
O500.RP-11096099	cable 4 pin, 2 m	PNP complementary	qTeach
O500.RP-11096094	connector M12 4 pin	PNP complementary	qTeach

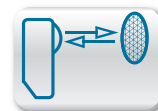

excess gain curves

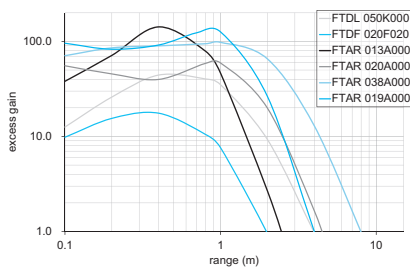
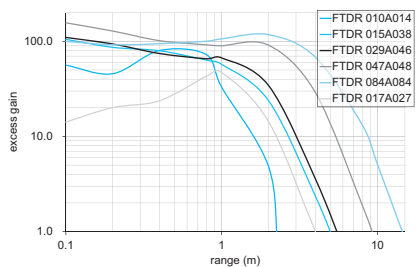

beam characteristic (typically)

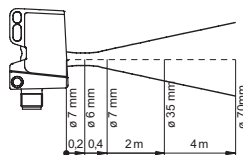

dimension drawings

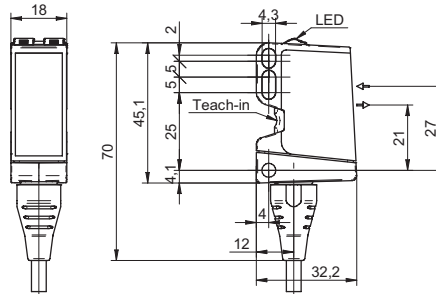
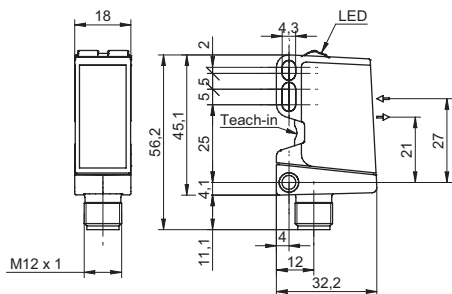

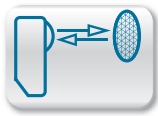

Sb = 7,5 m

- polarization filter to detect shiny objects



**general data**

type	retro-reflective sensor
light source	pulsed red LED
actual range Sb	7,5 m
nominal range Sn	8 m
polarization filter	yes
light indicator	LED yellow
power on indication	LED green
sensitivity adjustment	no
wave length	630 nm
suppression of reciprocal influence	yes
alignment optical axis	< 1°

**electrical data**

response time / release time	< 0,49 ms
voltage supply range +Vs	10 ... 30 VDC
current consumption max. (no load)	40 mA
current consumption typ.	30 mA
voltage drop Vd	< 3 VDC
output circuit	push-pull
output current	< 100 mA
short circuit protection	yes
reverse polarity protection	yes

**mechanical data**

width / diameter	18 mm
height / length	45 mm
depth	32 mm
type	rectangular
housing material	plastic (ASA, PMMA)
front (optics)	PMMA

**ambient conditions**

operating temperature	-25 ... +60 °C
protection class	IP 67

**connection diagram**

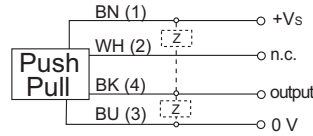

**connectors and mating connectors**

ESG 34SH0200	Connector M12, 3 pin, straight, 2 m
ESW 33SH0200	Connector M12, 3 pin, angular, 2 m
additional cable connectors and field wireable connectors: see accessories	

**Accessories**

11099942	Sensofix O500/U500
11092246	Mounting bracket O500/U500 (L design)
11111164	Mounting bracket O500/U500 - Retrofit for sensors series 30

for details: see accessories section

order reference	connection types	output function
O500.RR-11096093	cable 3 pin, 2 m	dark operate
O500.RR-11096091	connector M12 3 pin	dark operate
O500.RR-11096092	cable 3 pin, 2 m	light operate
O500.RR-11096090	connector M12 3 pin	light operate

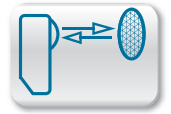

excess gain curves

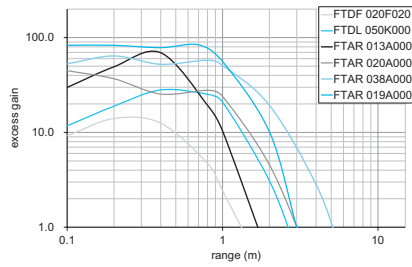
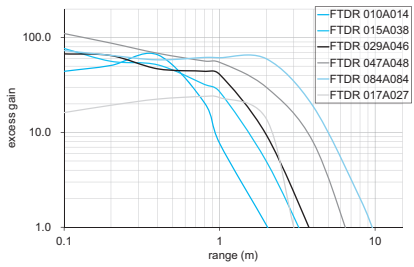

beam characteristic (typically)

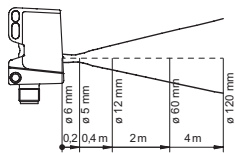

dimension drawings

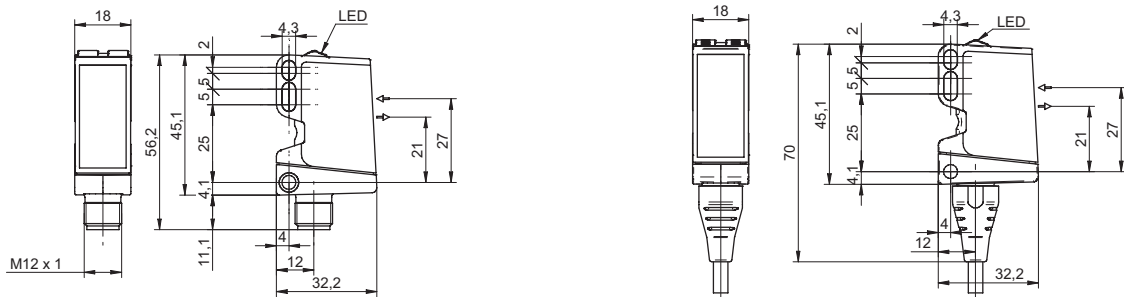

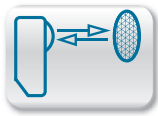

S<sub>b</sub> = 7,3 m

- rugged metal housing
- sensing range adjustable via potentiometer
- polarization filter to detect shiny objects



**general data**

type	retro-reflective sensor
light source	pulsed red LED
actual range S <sub>b</sub>	7,3 m
nominal range S <sub>n</sub>	8,5 m
polarization filter	yes
alignment / soiled lens indicator	flashing light indicator
light indicator	LED yellow
wave length	660 nm
suppression of reciprocal influence	yes

**electrical data**

response time / release time	< 1 ms
voltage supply range +Vs	10 ... 30 VDC
current consumption max. (no load)	36 mA
current consumption typ.	26 mA
voltage drop V <sub>d</sub>	< 1,8 VDC
output function	light / dark operate
output current	< 200 mA
short circuit protection	yes
reverse polarity protection	yes

**mechanical data**

width / diameter	15,4 mm
height / length	50 mm
depth	50 mm
type	rectangular
housing material	die-cast zinc
front (optics)	PMMA

**ambient conditions**

operating temperature	-25 ... +65 °C
protection class	IP 67

**connection diagrams**



**connectors and mating connectors**

ESG 34AH0200	Connector M12, 4 pin, straight, 2 m
ESW 33AH0200	Connector M12, 4 pin, angular, 2 m

additional cable connectors and field wireable connectors: see accessories

**Accessories**

10151721	Sensofix series 16
10113917	Mounting bracket series 16 (L design)
10116407	Lens cleaning air nozzle bracket

for details: see accessories section

order reference	connection types	output circuit	sensitivity adjustment
FPDM 16N5101	cable 4 pin, 2 m	NPN	no
FPDM 16N5101/S14	connector M12 4 pin	NPN	no
FPDM 16P5101	cable 4 pin, 2 m	PNP	no
FPDM 16P5101/S14	connector M12 4 pin	PNP	no
FPDM 16P5105	cable 4 pin, 2 m	PNP	potentiometer, 10 turn
FPDM 16P5105/S14	connector M12 4 pin	PNP	potentiometer, 10 turn



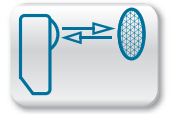

excess gain curves

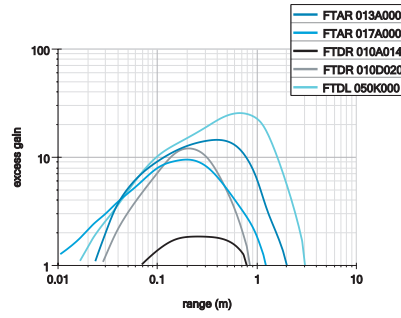
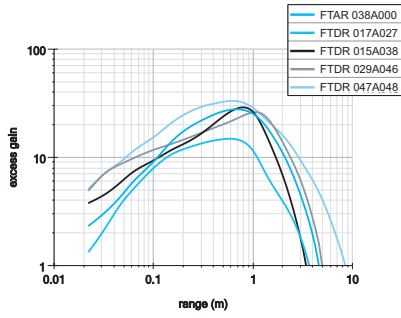

reflectors

FTAR 013A000	∅ 15 mm	Sn = 2 m
FTAR 017A000	∅ 20,7 mm	Sn = 1,1 m
FTAR 036A000	∅ 46 mm	Sn = 4,5 m
FTDR 010D014	12,8 x 16,8 mm	Sn = 0,8 m
FTDR 010D020	15 x 25 mm	Sn = 0,8 m
FTDR 017A027	20 x 42 mm	Sn = 3,6 m
FTDR 015A038	18 x 40 mm	Sn = 3,2 m
FTDR 029A046	32,5 x 48 mm	Sn = 5 m
FTDR 047A048	54 x 75 mm	Sn = 8,5 m
FTDL 050K000/... m	tape 50 x ... mm	Sn = 3 m

dimension drawings

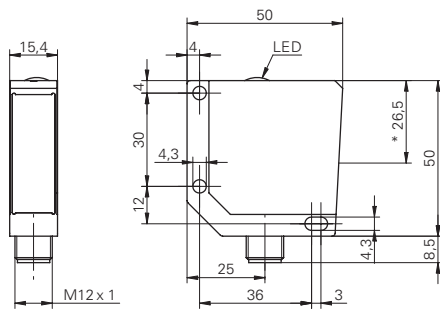

\* emitter axis

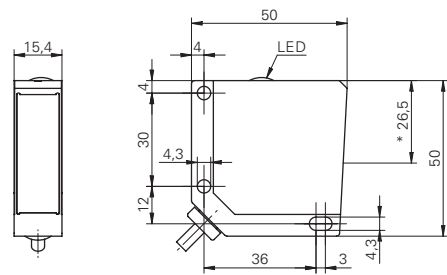

\* emitter axis

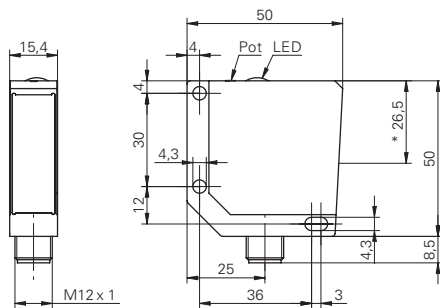

\* emitter axis

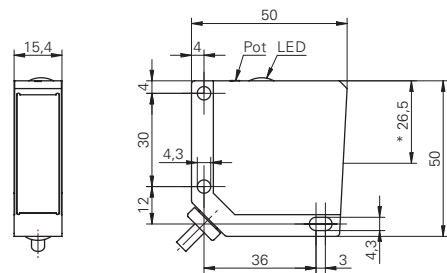

\* emitter axis

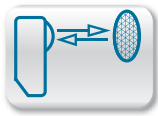

Sb = 5,5 m

- cross-technology housing concept
- polarization filter to detect shiny objects
- small mounting depth



**general data**

type	retro-reflective sensor
light source	pulsed red LED
actual range Sb	5,5 m
nominal range Sn	6,8 m
polarization filter	yes
alignment / soiled lens indicator	flashing light indicator
light indicator	LED yellow
sensitivity adjustment	potentiometer, 270°
wave length	660 nm
suppression of reciprocal influence	yes

**electrical data**

response time / release time	< 0,5 ms
voltage supply range +Vs	10 ... 30 VDC
current consumption max. (no load)	25 mA
current consumption typ.	22 mA
voltage drop Vd	< 1,8 VDC
output function	light / dark operate
output current	< 100 mA
short circuit protection	yes
reverse polarity protection	yes

**mechanical data**

width / diameter	20 mm
height / length	42 mm
depth	15 mm
type	rectangular
housing material	plastic (PBT-ASA)
front (optics)	PMMA
connection types	connector M8 4 pin

**ambient conditions**

operating temperature	-25 ... +65 °C
protection class	IP 67

**order reference**

order reference	output circuit
FPDK 20N5101/S35A	NPN
FPDK 20P5101/S35A	PNP

**connection diagrams**



**connectors and mating connectors**

ESG 32AH0200	Connector M8, 4 pin, straight, 2 m
ESW 31AH0200	Connector M8, 4 pin, angular, 2 m

additional cable connectors and field wireable connectors: see accessories

**Accessories**

10150326	Sensofix series 10 / series 20
----------	--------------------------------

for details: see accessories section

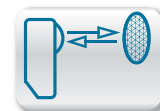

## excess gain curves

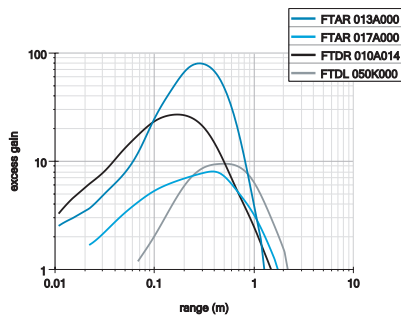
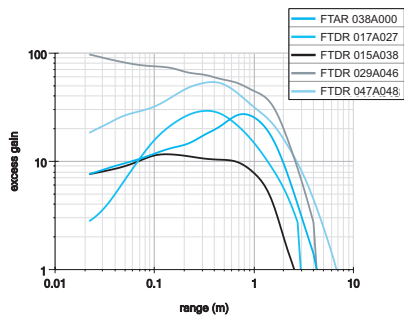

## reflectors

FTAR 013A000	∅ 15 mm	Sn = 1,2 m
FTAR 017A000	∅ 20,7 mm	Sn = 1,8 m
FTAR 036A000	∅ 46 mm	Sn = 4,2 m
FTDR 010D014	12,8 x 16,8 mm	Sn = 1,3 m
FTDR 017A027	20 x 42 mm	Sn = 3 m
FTDR 015A038	18 x 40 mm	Sn = 2,4 m
FTDR 029A046	32,5 x 48 mm	Sn = 4,2 m
FTDR 047A048	54 x 75 mm	Sn = 6,8 m
FTDL 050K000/... m	tape 50 x ... mm	Sn = 2,1 m

## dimension drawing

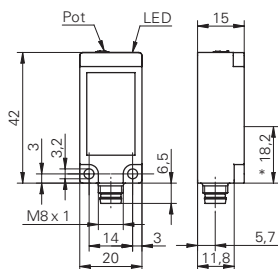

\* emitter axis

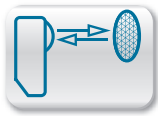

Sb = 3,2 m

- rugged metal housing
- polarization filter to detect shiny objects



**general data**

type	retro-reflective sensor
light source	pulsed red LED
actual range Sb	3,2 m
nominal range Sn	4 m
polarization filter	yes
alignment / soiled lens indicator	flashing light indicator
light indicator	LED yellow
sensitivity adjustment	no
wave length	660 nm
suppression of reciprocal influence	yes

**electrical data**

response time / release time	< 1 ms
voltage supply range +Vs	10 ... 30 VDC
current consumption max. (no load)	35 mA
current consumption typ.	22 mA
voltage drop Vd	< 1,8 VDC
output function	dark operate
output current	< 200 mA
short circuit protection	yes
reverse polarity protection	yes

**mechanical data**

width / diameter	18 mm
type	cylindrical threaded
housing material	brass nickel plated / PC
front (optics)	PMMA

**ambient conditions**

operating temperature	-25 ... +55 °C
protection class	IP 67

**connection diagrams**

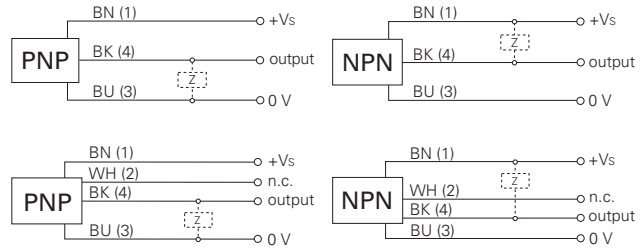

**connectors and mating connectors**

ESG 34AH0200	Connector M12, 4 pin, straight, 2 m
ESW 33AH0200	Connector M12, 4 pin, angular, 2 m
additional cable connectors and field wireable connectors: see accessories	

**Accessories**

10151658	Sensofix series 18
10103068	Glass cover series 18
10107250	Doubling lens series 18 FZAM 18
10115913	Cap nut glass cover and doubling lens for sensors series 18

for details: see accessories section

order reference	connection types	height / length	output circuit
FPAM 18N3151	cable 3 pin, 2 m	57 mm	NPN
FPAM 18N3151/S14	connector M12 4 pin	67 mm	NPN
FPAM 18P3151	cable 3 pin, 2 m	57 mm	PNP
FPAM 18P3151/S14	connector M12 4 pin	67 mm	PNP

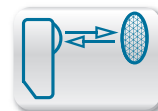

excess gain curves

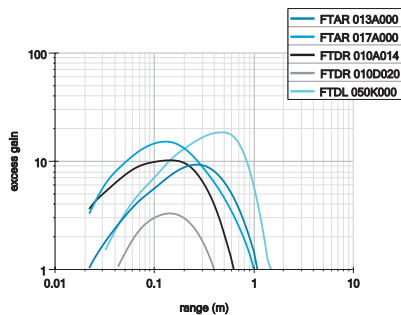
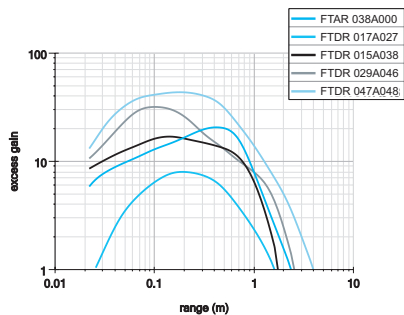

reflectors

FTAR 013A000	∅ 15 mm	Sn = 1,1 m
FTAR 017A000	∅ 20,7 mm	Sn = 1 m
FTAR 036A000	∅ 46 mm	Sn = 2,2 m
FTDR 010D014	12,8 x 16,8 mm	Sn = 0,6 m
FTDR 010D020	15 x 25 mm	Sn = 0,4 m
FTDR 017A027	20 x 42 mm	Sn = 1,6 m
FTDR 015A038	18 x 40 mm	Sn = 1,7 m
FTDR 029A046	32,5 x 48 mm	Sn = 2,3 m
FTDR 047A048	54 x 75 mm	Sn = 4 m
FTDL 050K000/... m	tape 50 x ... mm	Sn = 1,4 m

dimension drawings

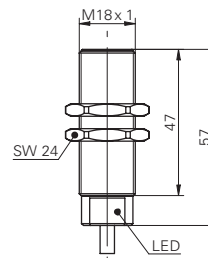
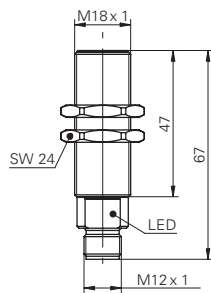

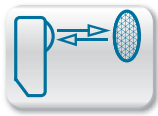

S<sub>b</sub> = 3,5 m

- polarization filter to detect shiny objects
- sensitivity adjustable via potentiometer
- suppression of mutual interference



**general data**

type	retro-reflective sensor
light source	pulsed red LED
actual range S <sub>b</sub>	3,5 m
nominal range S <sub>n</sub>	4,5 m
polarization filter	yes
alignment / soiled lens indicator	LED green
output indicator	LED yellow
wave length	660 nm
suppression of reciprocal influence	yes

**electrical data**

response time / release time	< 1 ms
voltage supply range +Vs	12 ... 30 VDC
current consumption max. (no load)	40 mA
current consumption typ.	30 mA
voltage drop V <sub>d</sub>	< 2 VDC
output function	light / dark operate
output current	< 100 mA
short circuit protection	yes
reverse polarity protection	yes

**mechanical data**

width / diameter	18 mm
type	cylindrical threaded
housing material	plastic (ABS TERLURAN)
front (optics)	PMMA

**ambient conditions**

operating temperature	-25 ... +55 °C
protection class	IP 67

**connection diagrams**

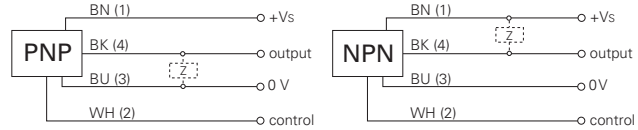

**connectors and mating connectors**

ESG 34AH0200	Connector M12, 4 pin, straight, 2 m
ESW 33AH0200	Connector M12, 4 pin, angular, 2 m

additional cable connectors and field wireable connectors: see accessories

**Accessories**

10151658	Sensofix series 18
ZADAP-M18.STANDARD	Mounting bracket series 18
ZADAP-M18.SHORT	Mounting bracket short series 18 (L design)
ZADAP-M18.LONG	Mounting bracket long series 18 (L design)
ZADAP-M18.SWING	Mounting bracket for adjustment for sensors series 18
ZADAP-M18.MICRO	Mounting bracket for adjustment for sensors series 18
ZPART-M18.NUT	Clamping nut for sensors Ø 18 mm

for details: see accessories section

order reference	connection types	height / length	output circuit	sensitivity adjustment
OR18.RR-11157781	connector M12 4 pin	67,2 mm	NPN	potentiometer, 270°
OR18.RR-11157782	cable 4 pin, 2 m	44,8 mm	NPN	no
OR18.RR-11157783	flylead connector M12 4 pin, L=100 mm	44,8 mm	NPN	no
OR18.RR-11157680	connector M12 4 pin	67,2 mm	PNP	potentiometer, 270°
OR18.RR-11157768	cable 4 pin, 2 m	44,8 mm	PNP	no
OR18.RR-11157780	flylead connector M12 4 pin, L=100 mm	44,8 mm	PNP	no

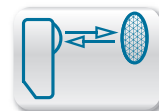

excess gain curves

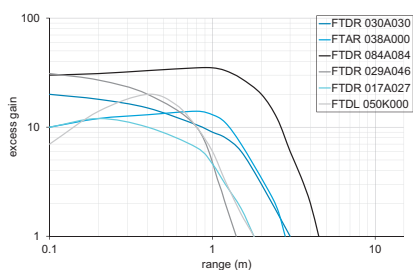
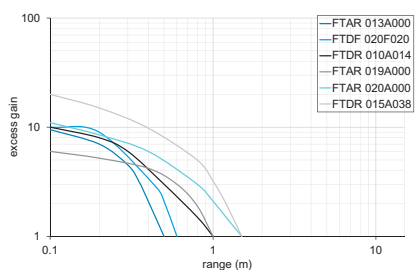

dimension drawings

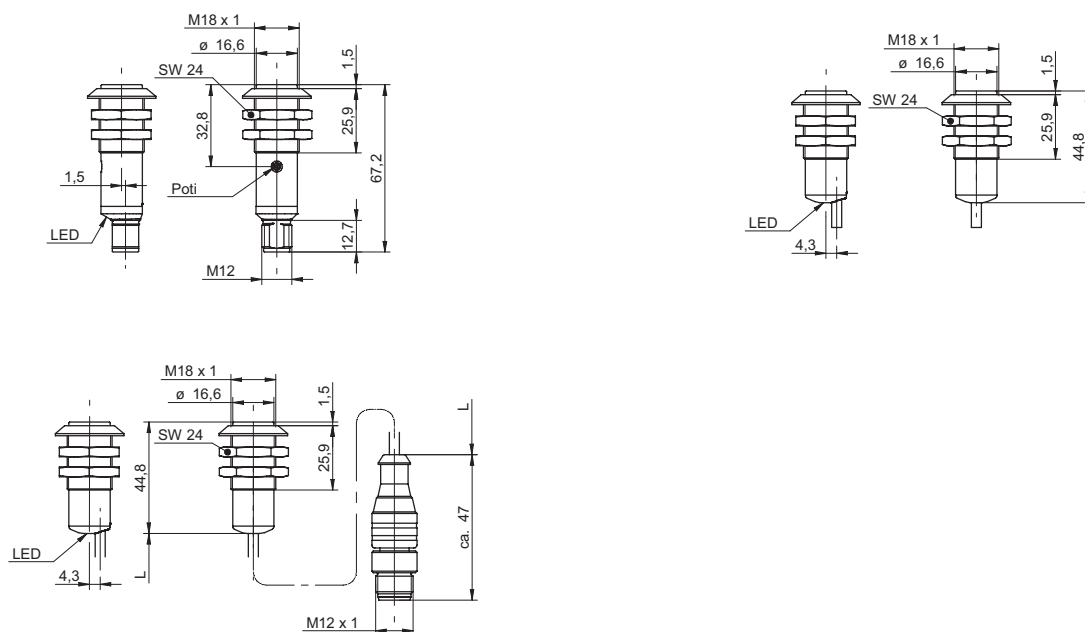

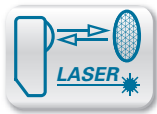

Sb = 7 m

- rugged miniature metal housing
- single lens optics
- short response time



**general data**

type	retro-reflective laser sensor
version	single lens optics
light source	pulsed red laser diode
repeat accuracy	< 0,1 mm at laser focus
polarization filter	yes
alignment / soiled lens indicator	flashing light indicator
light indicator	LED yellow
power on indication	LED green
sensitivity adjustment	no
laser class	2
wave length	650 nm

**actual range Sb = 4,5 m**

nominal range Sn	5 m
------------------	-----

**actual range Sb = 7 m**

nominal range Sn	8 m
------------------	-----

**electrical data**

voltage supply range +Vs	10 ... 30 VDC
current consumption max. (no load)	50 mA
current consumption typ.	40 mA
voltage drop Vd	< 1,8 VDC
output function	light / dark operate
output current	< 100 mA
short circuit protection	yes
reverse polarity protection	yes

**mechanical data**

width / diameter	12,4 mm
height / length	35 mm
depth	35 mm
type	rectangular
housing material	die-cast zinc
front (optics)	glass

**ambient conditions**

operating temperature	-10 ... +50 °C
protection class	IP 67

**connection diagrams**



**connectors and mating connectors**

ESG 32AH0200	Connector M8, 4 pin, straight, 2 m
ESW 31AH0200	Connector M8, 4 pin, angular, 2 m

additional cable connectors and field wireable connectors: see accessories

**Accessories**

10150328	Sensofix series 12
10113873	Mounting bracket series 12 (L design)

for details: see accessories section

**laser warning**

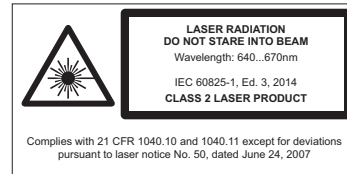

order reference	actual range Sb	connection types	output circuit	response time / release time	distance to focus
OPDM 12N5101/S35A	7 m	connector M8 4 pin	NPN	< 0,1 ms	400 mm
OPDM 12P5101	7 m	cable 4 pin, 2 m	PNP	< 0,1 ms	400 mm
OPDM 12P5101/S35A	7 m	connector M8 4 pin	PNP	< 0,1 ms	400 mm
OPDM 12P5102/S35A	4,5 m	connector M8 4 pin	PNP	< 0,1 ms	100 mm
OPDM 12P5103/S35A	7 m	connector M8 4 pin	PNP	< 0,1 ms	parallel beam
OPDM 12P5104/S35A	4,5 m	connector M8 4 pin	PNP	< 0,05 ms	100 mm



## excess gain curves

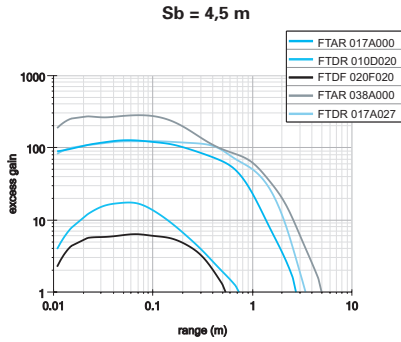
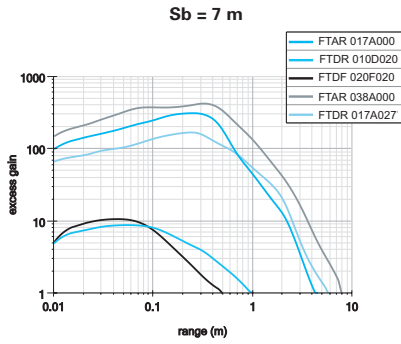

## reflectors

FTAR 017A000	∅ 20,7 mm	Sn = 4,1 m
FTAR 036A000	∅ 46 mm	Sn = 8 m
FTDR 010D020	15 x 25 mm	Sn = 0,95 m
FTDR 017A027	20 x 42 mm	Sn = 5,7 m
FTDF 020F020	20 x 20 mm	Sn = 0,5 m

FTAR 017A000	∅ 20,7 mm	Sn = 2,7 m
FTAR 036A000	∅ 46 mm	Sn = 5 m
FTDR 010D020	15 x 25 mm	Sn = 0,71 m
FTDR 017A027	20 x 42 mm	Sn = 3,2 m
FTDF 020F020	20 x 20 mm	Sn = 0,5 m

## beam characteristics (typically)

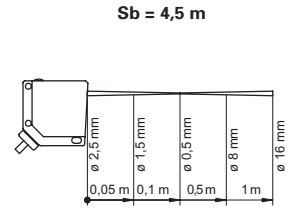
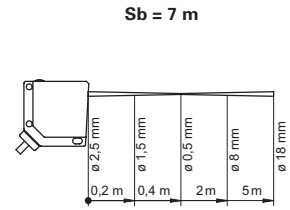

## dimension drawings

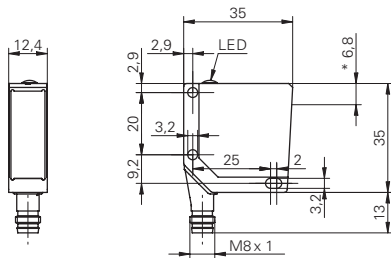

\* emitter and receiver axis

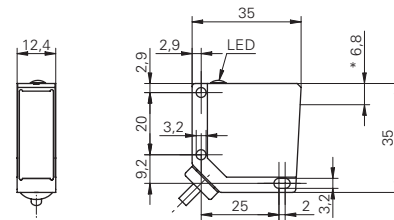

\* emitter and receiver axis

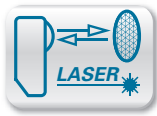

Sb = 5 m



- One inch class
- laser diode
- polarization filter to detect shiny objects

general data	
type	retro-reflective sensor
light source	pulsed red laser diode
actual range Sb	5 m
nominal range Sn	6 m
repeat accuracy	< 0,2 mm at 500 mm
polarization filter	yes
light indicator	LED yellow
power on indication	LED green
laser class	1
distance to focus	parallel beam
wave length	656 nm
suppression of reciprocal influence	yes
alignment optical axis	< 2°

electrical data	
response time / release time	< 0,1 ms
voltage supply range +Vs	11 ... 30 VDC
current consumption max. (no load)	30 mA
current consumption typ.	25 mA
voltage drop Vd	< 2,5 VDC
output function	light / dark operate
output current	< 100 mA
short circuit protection	yes
reverse polarity protection	yes

mechanical data	
width / diameter	12,9 mm
height / length	32,3 mm
depth	23 mm
type	rectangular
housing material	plastic (ASA, PMMA)
front (optics)	PMMA

ambient conditions	
operating temperature	-10 ... +60 °C
protection class	IP 67

connection diagrams

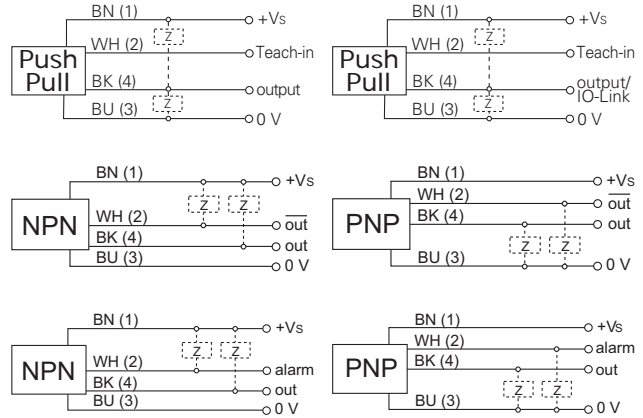

connectors and mating connectors

ESG 32AH0200	Connector M8, 4 pin, straight, 2 m
ESW 31AH0200	Connector M8, 4 pin, angular, 2 m

additional cable connectors and field wireable connectors: see accessories

Accessories

11104963	Sensofix O300
11102423	Mounting bracket O300 (L design)
11124807	Mounting bracket O300 - Retrofit for sensors series 20

for details: see accessories section

laser warning



IEC 60825-1/2014  
Complies with 21 CFR 1040.10 and 1040.11  
except for deviations pursuant to laser  
notice No. 50, dated June 24, 2007

order reference	connection types	output circuit	sensitivity adjustment
O300.RL-11172767	cable 4 pin, 2 m	push-pull	Teach-in and IO-Link
O300.RL-11172769	connector M8 4 pin	push-pull	Teach-in and IO-Link
O300.RL-11172800	cable 4 pin, 2 m	NPN complementary	qTeach
O300.RL-11172801	connector M8 4 pin	NPN complementary	qTeach
O300.RL-11172802	cable 4 pin, 2 m	PNP complementary	qTeach
O300.RL-11172803	connector M8 4 pin	PNP complementary	qTeach

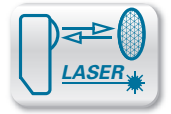

excess gain curves

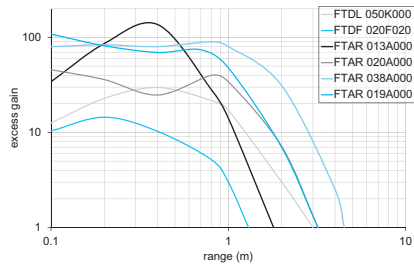
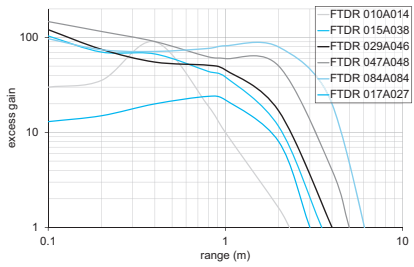

beam characteristic (typically)

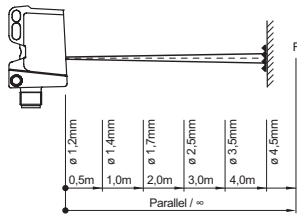

dimension drawings

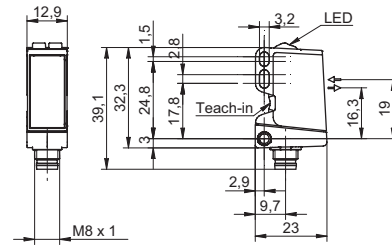
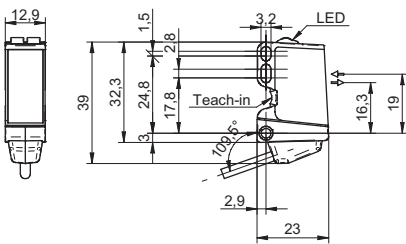

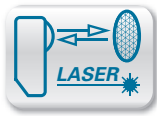

Sb = 5 m



- One inch class
- hygienic design
- laser diode

**general data**

type	retro-reflective sensor
special type	hygienic design
light source	pulsed red laser diode
actual range Sb	5 m
nominal range Sn	6 m
repeat accuracy	< 0,2 mm at 500 mm
polarization filter	yes
light indicator	LED yellow
power on indication	LED green
sensitivity adjustment	Teach-in and IO-Link
laser class	1
distance to focus	parallel beam
wave length	656 nm
suppression of reciprocal influence	yes
alignment optical axis	< 2°
approvals/certificates	Ecolab

**electrical data**

response time / release time	< 0,1 ms
voltage supply range +Vs	11 ... 30 VDC
current consumption max. (no load)	30 mA
current consumption typ.	25 mA
voltage drop Vd	< 2,5 VDC
output function	light / dark operate
output circuit	push-pull
output current	< 100 mA
short circuit protection	yes
reverse polarity protection	yes

**mechanical data**

width / diameter	16,5 mm
height / length	34,6 mm
depth	28,7 mm
type	rectangular
housing material	stainless steel 1.4404 (V4A)
front (optics)	PMMA

**ambient conditions**

operating temperature	-10 ... +60 °C
protection class	IP 68/69K & proTect+

**order reference**                      **connection types**

<b>O300H.RL-11172813</b>	cable 4 pin, 2 m
<b>O300H.RL-11172814</b>	flylead connector M8, L=200 mm

**connection diagrams**

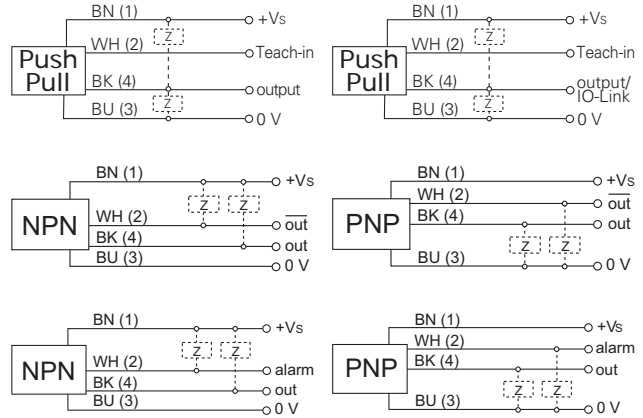

**connectors and mating connectors**

ESG 32AY0200	Connector M8, 4 pin, straight, 2 m, V4A-PP
ESW 31AY0200	Connector M8, 4 pin, angular, 2 m, V4A-PP

additional cable connectors and field wireable connectors: see accessories

**Accessories**

HI11-1H	Mounting for sensors in hygienic design Ø 11 mm
11137318	Teach Pen for sensors in metal housing
11141124	Teach Pen for sensors in metal housing (USA, CAN, JP)

for details: see accessories section

**laser warning**



IEC 60825-1/2014  
Complies with 21 CFR 1040.10 and 1040.11  
except for deviations pursuant to laser  
notice No. 50, dated June 24, 2007

O300H.RL Sb = 5 m

Retro-reflective sensors

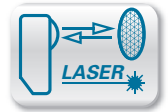

excess gain curves

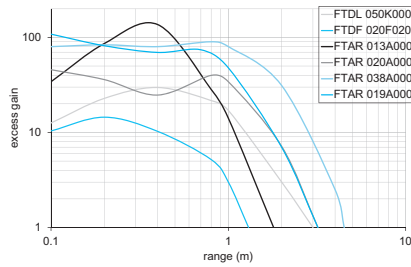
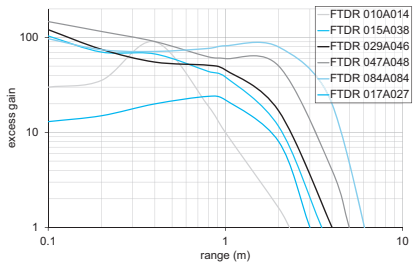

beam characteristic (typically)

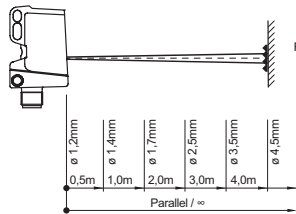

dimension drawings

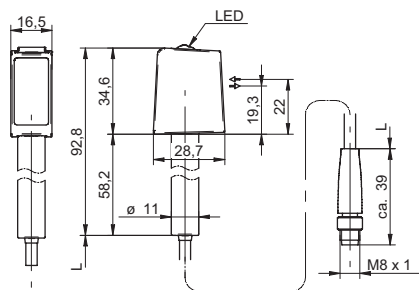
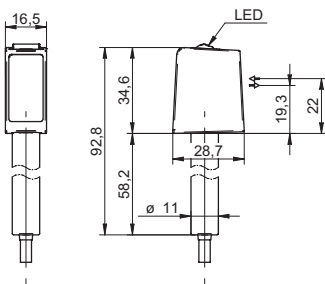

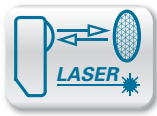

Sb = 5 m



- One inch class
- washdown design
- laser diode

**general data**

type	retro-reflective sensor
special type	Washdown design
light source	pulsed red laser diode
actual range Sb	5 m
nominal range Sn	6 m
repeat accuracy	< 0,2 mm at 500 mm
polarization filter	yes
light indicator	LED yellow
power on indication	LED green
sensitivity adjustment	Teach-in and IO-Link
laser class	1
distance to focus	parallel beam
wave length	656 nm
suppression of reciprocal influence	yes
alignment optical axis	< 2°
approvals/certificates	Ecolab

**electrical data**

response time / release time	< 0,1 ms
voltage supply range +Vs	11 ... 30 VDC
current consumption max. (no load)	30 mA
current consumption typ.	25 mA
voltage drop Vd	< 2,5 VDC
output function	light / dark operate
output circuit	push-pull
output current	< 100 mA
short circuit protection	yes
reverse polarity protection	yes

**mechanical data**

width / diameter	16,5 mm
height / length	34,7 mm
depth	28,2 mm
type	rectangular
housing material	stainless steel 1.4404 (V4A)
front (optics)	PMMA
connection types	connector M8 4 pin

**ambient conditions**

operating temperature	-10 ... +60 °C
protection class	IP 68/69K & proTect+

**order reference**

O300W.RL-11172815

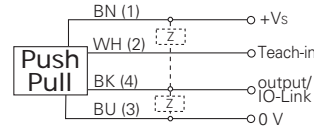
**connection diagram****connectors and mating connectors**

ESG 32AY0200	Connector M8, 4 pin, straight, 2 m, V4A-PP
ESW 31AY0200	Connector M8, 4 pin, angular, 2 m, V4A-PP

additional cable connectors and field wireable connectors: see accessories

**Accessories**

11104963	Sensofix O300
11102423	Mounting bracket O300 (L design)
11124807	Mounting bracket O300 - Retrofit for sensors series 20

for details: see accessories section

**laser warning**

**CLASS 1 LASER  
PRODUCT**

IEC 60825-1/2014  
Complies with 21 CFR 1040.10 and 1040.11  
except for deviations pursuant to laser  
notice No. 50, dated June 24, 2007

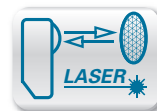

excess gain curves

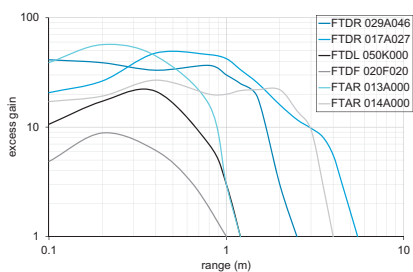
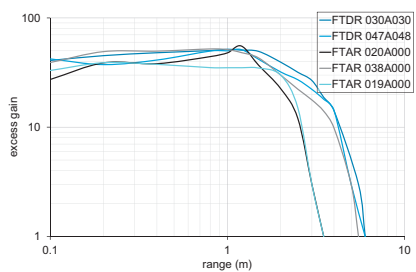

beam characteristic (typically)

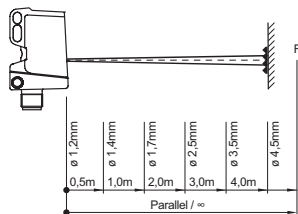

dimension drawing

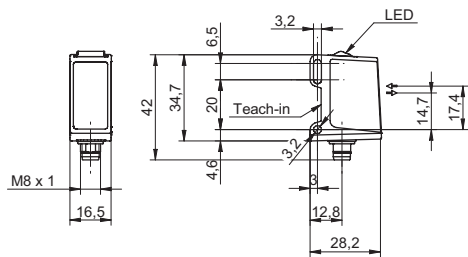

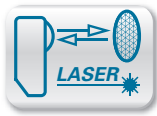

Sb = 10 m

- single lens optics
- long sensing range
- short response time



**general data**

type	retro-reflective laser sensor
version	single lens optics
light source	pulsed red laser diode
actual range Sb	10 m
nominal range Sn	11 m
repeat accuracy	< 0,1 mm at laser focus
polarization filter	yes
alignment / soiled lens indicator	flashing light indicator
light indicator	LED yellow
power on indication	LED green
sensitivity adjustment	Teach-in
laser class	1
distance to focus	400 mm
wave length	650 nm

**electrical data**

response time / release time	< 0,25 ms
voltage supply range +Vs	10 ... 30 VDC
current consumption max. (no load)	35 mA
current consumption typ.	25 mA
voltage drop Vd	< 2,2 VDC
output function	light / dark operate
output circuit	PNP
output current	< 100 mA
short circuit protection	yes
reverse polarity protection	yes

**mechanical data**

width / diameter	14,8 mm
height / length	43 mm
depth	31 mm
type	rectangular
housing material	plastic (ASA, MABS)
front (optics)	PMMA

**ambient conditions**

operating temperature	-10 ... +50 °C
protection class	IP 67

**order reference**

<b>OPDK 14P5901</b>	cable 4 pin, 2 m
<b>OPDK 14P5901/S14</b>	connector M12 4 pin
<b>OPDK 14P5901/S35A</b>	connector M8 4 pin

**connection types**

**connection diagrams**



**connectors and mating connectors**

ESG 34AH0200	Connector M12, 4 pin, straight, 2 m
ESW 33AH0200	Connector M12, 4 pin, angular, 2 m
ESG 32AH0200	Connector M8, 4 pin, straight, 2 m
ESW 31AH0200	Connector M8, 4 pin, angular, 2 m

additional cable connectors and field wireable connectors: see accessories

**Accessories**

10149011	Sensofix series 14
10134964	Mounting bracket series 14 (L design)

for details: see accessories section

**laser warning**



IEC 60825-1/2014  
Complies with 21 CFR 1040.10 and 1040.11  
except for deviations pursuant to laser  
notice No. 50, dated June 24, 2007



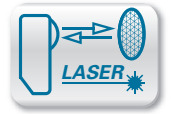

excess gain curves

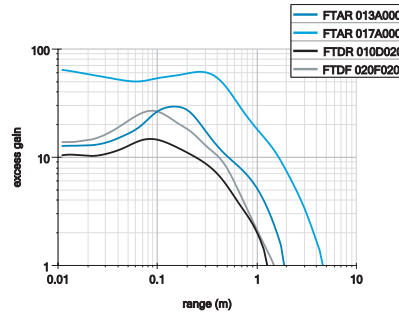
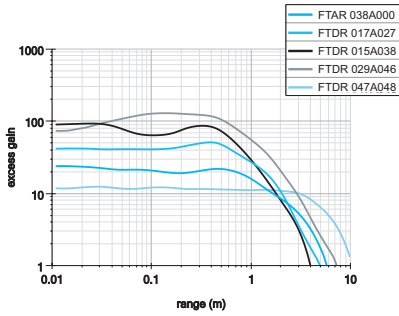

reflectors

FTAR 013A000	∅ 15 mm	Sn = 1,9 m
FTAR 017A000	∅ 20,7 mm	Sn = 4,4 m
FTAR 036A000	∅ 46 mm	Sn = 5,8 m
FTDR 010D020	15 x 25 mm	Sn = 1,1 m
FTDR 017A027	20 x 42 mm	Sn = 5 m
FTDR 015A038	18 x 40 mm	Sn = 4 m
FTDR 029A046	32,5 x 48 mm	Sn = 7,2 m
FTDR 047A048	54 x 75 mm	Sn = 11 m
FTDF 020F020	20 x 20 mm	Sn = 1,2 m

beam characteristic (typically)

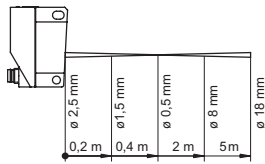

dimension drawings

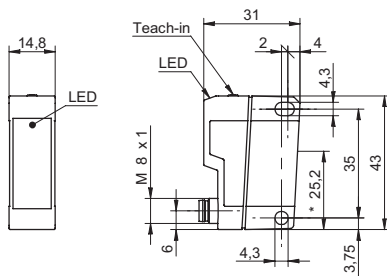

\* emitter and receiver axis

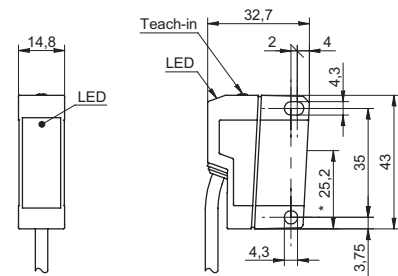

\* emitter and receiver axis

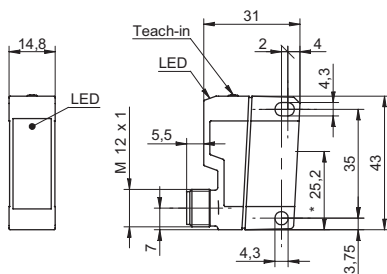

\* emitter and receiver axis

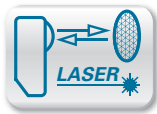
S<sub>b</sub> = 11 m

- rugged metal housing
- high repeatability
- short response time

**general data**

type	retro-reflective laser sensor
light source	pulsed red laser diode
polarization filter	yes
alignment / soiled lens indicator	flashing light indicator
light indicator	LED yellow
laser class	1
wave length	650 nm

**actual range S<sub>b</sub> = 7,5 m**

nominal range S <sub>n</sub>	8,3 m
repeat accuracy	< 0,1 mm at laser focus
sensitivity adjustment	potentiometer, 270°
distance to focus	80 mm

**actual range S<sub>b</sub> = 11 m**

nominal range S <sub>n</sub>	12 m
repeat accuracy	< 1,5 mm at 0 ... 0,5 m
sensitivity adjustment	no
distance to focus	400 mm

**electrical data**

response time / release time	< 0,1 ms
voltage supply range +Vs	10 ... 30 VDC
current consumption max. (no load)	70 mA
current consumption typ.	60 mA
voltage drop V <sub>d</sub>	< 2 VDC
output function	light / dark operate
output circuit	PNP
output current	< 200 mA
short circuit protection	yes
reverse polarity protection	yes

**mechanical data**

width / diameter	15,4 mm
height / length	50 mm
depth	50 mm
type	rectangular
housing material	die-cast zinc
front (optics)	glass

**ambient conditions**

operating temperature	-10 ... +50 °C
protection class	IP 67

order reference	actual range S <sub>b</sub>	connection types
OPDM 16P5102	11 m	cable 4 pin, 2 m
OPDM 16P5102/S14	11 m	connector M12 4 pin
OPDM 16P5103/S14	7,5 m	connector M12 4 pin

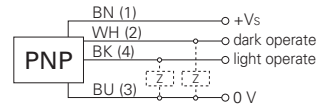
**connection diagram****connectors and mating connectors**

ESG 34AH0200 Connector M12, 4 pin, straight, 2 m

ESW 33AH0200 Connector M12, 4 pin, angular, 2 m

additional cable connectors and field wireable connectors: see accessories

**Accessories**

10151721 Sensofix series 16

10113917 Mounting bracket series 16 (L design)

10116407 Lens cleaning air nozzle bracket

for details: see accessories section

**laser warning**

**CLASS 1 LASER  
PRODUCT**

IEC 60825-1/2014  
Complies with 21 CFR 1040.10 and 1040.11  
except for deviations pursuant to laser  
notice No. 50, dated June 24, 2007

## excess gain curves

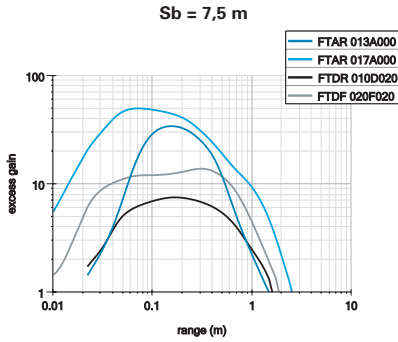
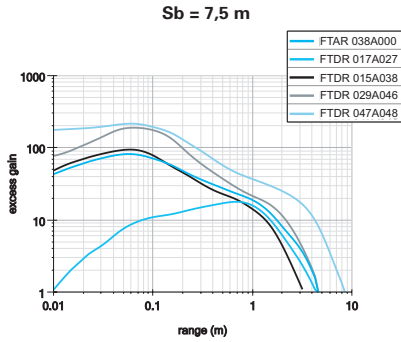
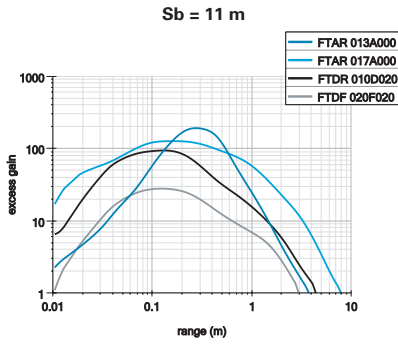
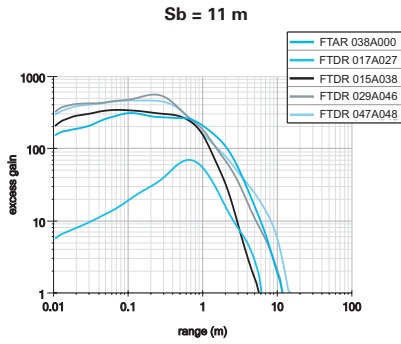

## reflectors

FTAR 013A000	∅ 15 mm	Sn = 1,3 m
FTAR 017A000	∅ 20,7 mm	Sn = 2,4 m
FTAR 036A000	∅ 46 mm	Sn = 4,4 m
FTDR 010D020	15 x 25 mm	Sn = 1,4 m
FTDR 017A027	20 x 42 mm	Sn = 4,4 m
FTDR 015A038	18 x 40 mm	Sn = 3,1 m
FTDR 029A046	32,5 x 48 mm	Sn = 4,4 m
FTDR 047A048	54 x 75 mm	Sn = 8,3 m
FTDF 020F020	20 x 20 mm	Sn = 1,8 m

FTAR 013A000	∅ 15 mm	Sn = 3,8 m
FTAR 017A000	∅ 20,7 mm	Sn = 8 m
FTAR 036A000	∅ 46 mm	Sn = 11 m
FTDR 010D020	15 x 25 mm	Sn = 4,2 m
FTDR 017A027	20 x 42 mm	Sn = 6 m
FTDR 015A038	18 x 40 mm	Sn = 5,5 m
FTDR 029A046	32,5 x 48 mm	Sn = 11 m
FTDR 047A048	54 x 75 mm	Sn = 12 m
FTDF 020F020	20 x 20 mm	Sn = 3 m

## beam characteristics (typically)

**Sb = 11 m**

**Sb = 7,5 m**

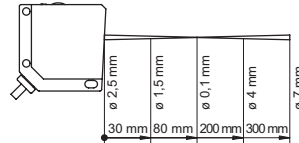
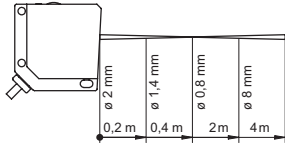

## dimension drawings

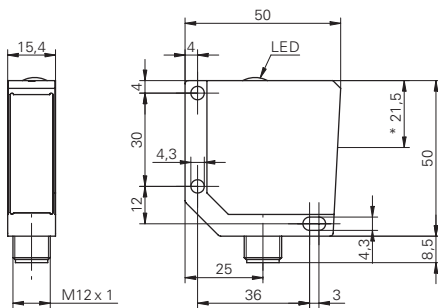

\* emitter axis

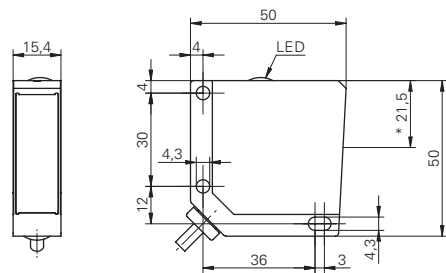

\* emitter axis

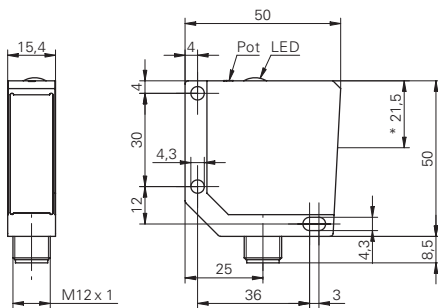

\* emitter axis

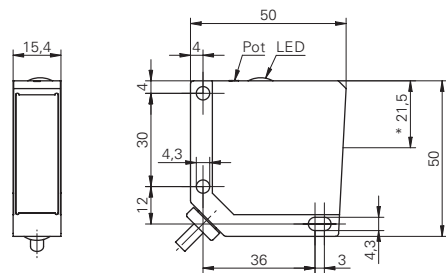

\* emitter axis

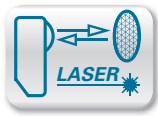

S<sub>b</sub> = 15 m

- short response time
- long range
- polarization filter to detect shiny objects



**general data**

type	retro-reflective sensor
light source	pulsed red laser diode
actual range S <sub>b</sub>	15 m
nominal range S <sub>n</sub>	16 m
polarization filter	yes
output indicator	LED yellow
power on indication	LED green
sensitivity adjustment	potentiometer, 270°
laser class	1
distance to focus	parallel beam
wave length	630 nm
suppression of reciprocal influence	yes

**electrical data**

response time / release time	< 0,34 ms
voltage supply range +Vs	10 ... 30 VDC
current consumption max. (no load)	45 mA
current consumption typ.	35 mA
voltage drop V <sub>d</sub>	< 2 VDC
output function	light / dark operate
output current	< 100 mA
short circuit protection	yes
reverse polarity protection	yes

**mechanical data**

width / diameter	18 mm
type	cylindrical threaded
housing material	brass nickel plated
front (optics)	PMMA

**ambient conditions**

operating temperature	-10 ... +55 °C
protection class	IP 67

**connection diagrams**



**connectors and mating connectors**

ESG 34AH0200	Connector M12, 4 pin, straight, 2 m
ESW 33AH0200	Connector M12, 4 pin, angular, 2 m

additional cable connectors and field wireable connectors: see accessories

**Accessories**

10151658	Sensofix series 18
ZADAP-M18.STANDARD	Mounting bracket series 18
ZADAP-M18.SHORT	Mounting bracket short series 18 (L design)
ZADAP-M18.LONG	Mounting bracket long series 18 (L design)
ZADAP-M18.SWING	Mounting bracket for adjustment for sensors series 18
ZADAP-M18.MICRO	Mounting bracket for adjustment for sensors series 18

for details: see accessories section

**laser warning**



IEC 60825-1/2014  
Complies with 21 CFR 1040.10 and 1040.11  
except for deviations pursuant to laser  
notice No. 50, dated June 24, 2007

order reference	connection types	height / length	output circuit
OR18.RL-11157787	cable 4 pin, 2 m	77 mm	NPN complementary
OR18.RL-11157786	connector M12 4 pin	81,5 mm	NPN complementary
OR18.RL-11157785	cable 4 pin, 2 m	77 mm	PNP complementary
OR18.RL-11157784	connector M12 4 pin	81,5 mm	PNP complementary

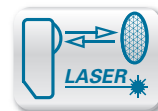

## excess gain curves

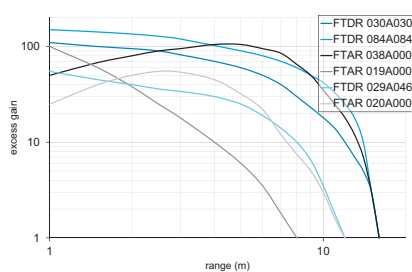
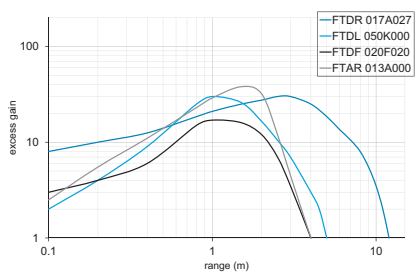

## beam characteristic (typically)

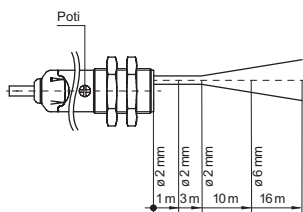

## dimension drawings

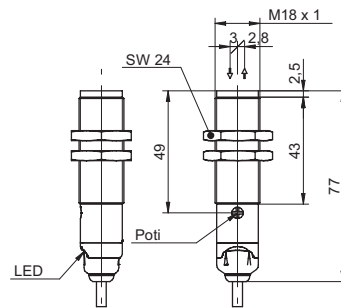
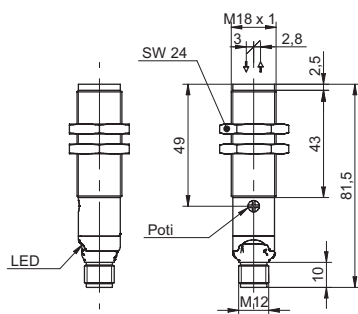

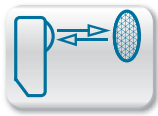

**S<sub>b</sub> = 3,5 m**

- One inch class
- PinPoint LED
- designed for detection of transparent objects



#### general data

type	retro-reflective sensor
version	transparency object detection
light source	pulsed PinPoint LED
actual range S <sub>b</sub>	3,5 m
nominal range S <sub>n</sub>	4 m
polarization filter	yes
minimal signal attenuation	10 % / 20 % / 30 %
light indicator	LED yellow
power on indication	LED green
sensitivity adjustment	Teach-in and IO-Link
wave length	630 nm
suppression of reciprocal influence	yes
alignment optical axis	< 2°

#### electrical data

response time / release time	< 0,25 ms
voltage supply range +Vs	10 ... 30 VDC
current consumption max. (no load)	35 mA
current consumption typ.	30 mA
voltage drop V <sub>d</sub>	< 3 VDC
output function	light / dark operate
output circuit	push-pull
output current	< 100 mA
short circuit protection	yes
reverse polarity protection	yes

#### mechanical data

width / diameter	12,9 mm
height / length	32,3 mm
depth	23 mm
type	rectangular
housing material	plastic (ASA, PMMA)
front (optics)	PMMA

#### ambient conditions

operating temperature	-25 ... +60 °C
protection class	IP 67

#### order reference

<b>O300.RP.T-11157331</b>	cable 4 pin, 2 m
<b>O300.RP.T-11157334</b>	connector M8 4 pin

#### connection types

#### connection diagram

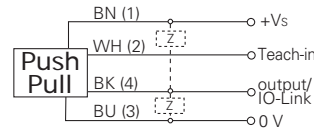

#### connectors and mating connectors

ESG 32AH0200	Connector M8, 4 pin, straight, 2 m
ESW 31AH0200	Connector M8, 4 pin, angular, 2 m

additional cable connectors and field wireable connectors: see accessories

#### Accessories

11104963	Sensofix O300
11102423	Mounting bracket O300 (L design)
11124807	Mounting bracket O300 - Retrofit for sensors series 20

for details: see accessories section

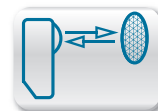

excess gain curves

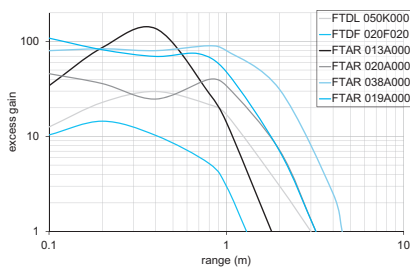
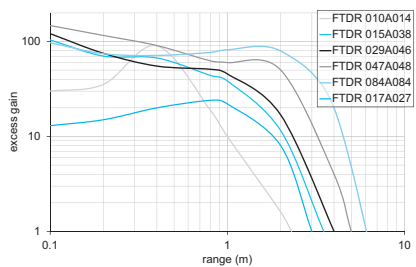

beam characteristic (typically)

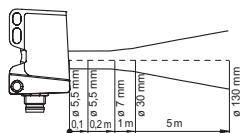

dimension drawings

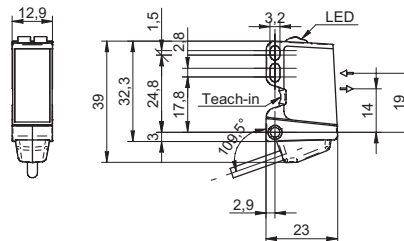
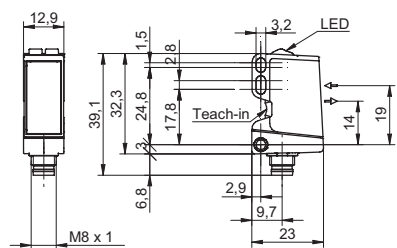

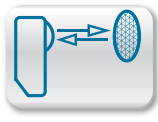

**S<sub>b</sub> = 3,5 m**

- One inch class
- washdown design
- designed for detection of transparent objects



#### general data

type	retro-reflective sensor
special type	Washdown design
version	transparency object detection
light source	pulsed PinPoint LED
actual range S <sub>b</sub>	3,5 m
nominal range S <sub>n</sub>	4 m
polarization filter	yes
minimal signal attenuation	10 % / 20 % / 30 %
light indicator	LED yellow
power on indication	LED green
sensitivity adjustment	Teach-in and IO-Link
wave length	630 nm
suppression of reciprocal influence	yes
alignment optical axis	< 2°
approvals/certificates	Ecolab

#### electrical data

response time / release time	< 0,25 ms
voltage supply range +Vs	10 ... 30 VDC
current consumption max. (no load)	35 mA
current consumption typ.	30 mA
voltage drop V <sub>d</sub>	< 3 VDC
output function	light / dark operate
output circuit	push-pull
output current	< 100 mA
short circuit protection	yes
reverse polarity protection	yes

#### mechanical data

width / diameter	16,5 mm
height / length	34,7 mm
depth	28,2 mm
type	rectangular
housing material	stainless steel 1.4404 (V4A)
front (optics)	PMMA
connection types	connector M8 4 pin

#### ambient conditions

operating temperature	-25 ... +60 °C
protection class	IP 68/69K & proTect+

#### order reference

**O300W.RP.T-11157338**

#### connection diagram

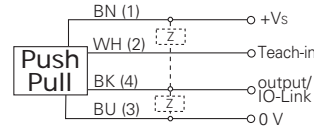

#### connectors and mating connectors

ESG 32AY0200	Connector M8, 4 pin, straight, 2 m, V4A-PP
ESW 31AY0200	Connector M8, 4 pin, angular, 2 m, V4A-PP

additional cable connectors and field wireable connectors: see accessories

#### Accessories

11104963	Sensofix O300
11102423	Mounting bracket O300 (L design)
11124807	Mounting bracket O300 - Retrofit for sensors series 20

for details: see accessories section



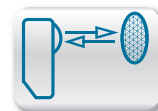

excess gain curves

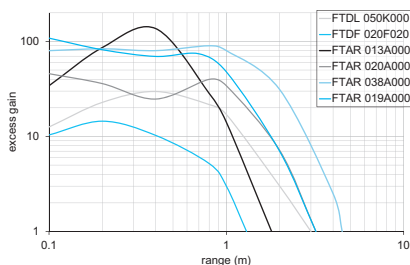
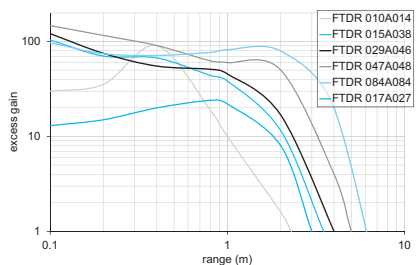

beam characteristic (typically)

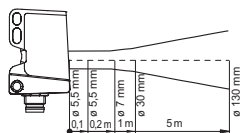

dimension drawing

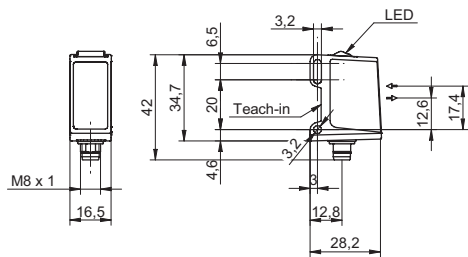

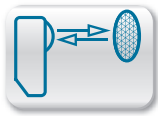

Sb = 3,5 m

- One inch class
- hygienic design
- designed for detection of transparent objects



**general data**

type	retro-reflective sensor
special type	hygienic design
version	transparency object detection
light source	pulsed PinPoint LED
actual range Sb	3,5 m
nominal range Sn	4 m
polarization filter	yes
minimal signal attenuation	10 % / 20 % / 30 %
light indicator	LED yellow
power on indication	LED green
sensitivity adjustment	Teach-in and IO-Link
wave length	630 nm
suppression of reciprocal influence	yes
alignment optical axis	< 2°
approvals/certificates	Ecolab

**electrical data**

response time / release time	< 0,25 ms
voltage supply range +Vs	10 ... 30 VDC
current consumption max. (no load)	35 mA
current consumption typ.	30 mA
voltage drop Vd	< 3 VDC
output function	light / dark operate
output circuit	push-pull
output current	< 100 mA
short circuit protection	yes
reverse polarity protection	yes

**mechanical data**

width / diameter	16,5 mm
height / length	34,6 mm
depth	28,7 mm
type	rectangular
housing material	stainless steel 1.4404 (V4A)
front (optics)	PMMA

**ambient conditions**

operating temperature	-25 ... +60 °C
protection class	IP 68/69K & proTect+

**order reference**

<b>O300H.RP.T-11157335</b>	cable 4 pin, 2 m
<b>O300H.RP.T-11157337</b>	flylead connector M8, L=200 mm

**connection types**

**connection diagram**

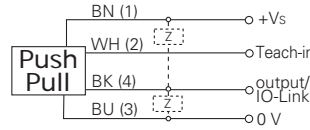

**connectors and mating connectors**

ESG 32AY0200	Connector M8, 4 pin, straight, 2 m, V4A-PP
ESW 31AY0200	Connector M8, 4 pin, angular, 2 m, V4A-PP

additional cable connectors and field wireable connectors: see accessories

**Accessories**

HI11-1H	Mounting for sensors in hygienic design Ø 11 mm
11137318	Teach Pen for sensors in metal housing
11141124	Teach Pen for sensors in metal housing (USA, CAN, JP)

for details: see accessories section

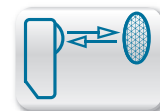

excess gain curves

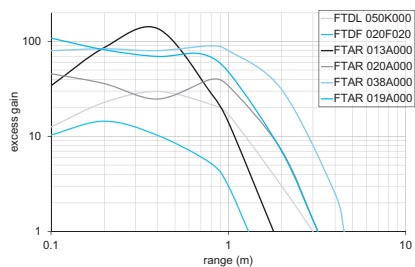
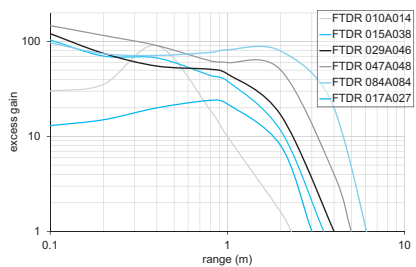

beam characteristic (typically)

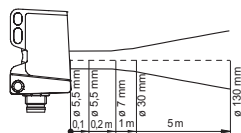

dimension drawings

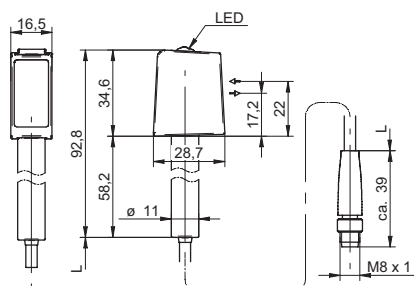
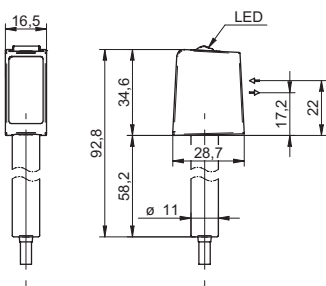

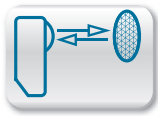

$S_b = 7\text{ m}$

- designed for detection of transparent objects
- sensitivity adjustable via Teach-in
- short response time



#### general data

type	retro-reflective sensor
version	for transparent objects
light source	pulsed red LED
actual range $S_b$	7 m
nominal range $S_n$	8 m
polarization filter	no
light indicator	LED yellow
sensitivity adjustment	Teach-in
wave length	660 nm

#### electrical data

response time / release time	< 0,1 ms
teach-in signal time	> 500 $\mu$ s
adaption time	< 20 ms
voltage supply range +Vs	10 ... 30 VDC
current consumption max. (no load)	40 mA
current consumption typ.	35 mA
voltage drop Vd	< 2,2 VDC
output function	light / dark operate switchable
output current	< 100 mA
short circuit protection	yes
reverse polarity protection	yes

#### mechanical data

width / diameter	14,8 mm
height / length	43 mm
depth	31 mm
type	rectangular
housing material	plastic (ASA, MABS)
front (optics)	PMMA

#### ambient conditions

operating temperature	-25 ... +65 °C
protection class	IP 67

#### connection diagrams



#### connectors and mating connectors

ESG 34AH0200	Connector M12, 4 pin, straight, 2 m
ESW 33AH0200	Connector M12, 4 pin, angular, 2 m
ESG 32AH0200	Connector M8, 4 pin, straight, 2 m
ESW 31AH0200	Connector M8, 4 pin, angular, 2 m

additional cable connectors and field wireable connectors: see accessories

#### Accessories

10149011	Sensofix series 14
10134964	Mounting bracket series 14 (L design)

for details: see accessories section

order reference	connection types	output circuit
FRDK 14N6901	cable 4 pin, 2 m	NPN
FRDK 14N6901/S14	connector M12 4 pin	NPN
FRDK 14N6901/S35A	connector M8 4 pin	NPN
FRDK 14P6901	cable 4 pin, 2 m	PNP
FRDK 14P6901/S14	connector M12 4 pin	PNP
FRDK 14P6901/S35A	connector M8 4 pin	PNP

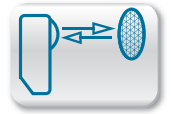

excess gain curves

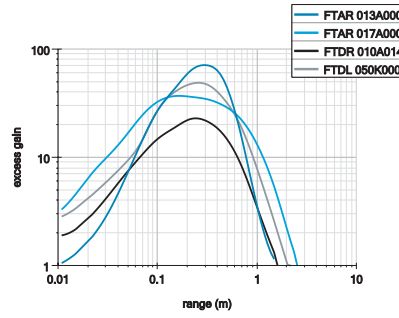
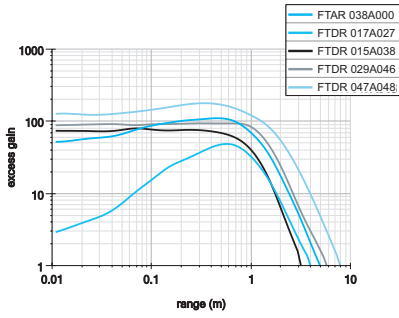

reflectors

FTAR 013A000	∅ 15 mm	Sn = 1,7 m
FTAR 017A000	∅ 20,7 mm	Sn = 2,4 m
FTAR 036A000	∅ 46 mm	Sn = 5 m
FTDR 010A014	12,8 x 16,8 mm	Sn = 1,7 m
FTDR 017A027	20 x 42 mm	Sn = 4 m
FTDR 015A038	18 x 40 mm	Sn = 2,1 m
FTDR 029A046	32,5 x 48 mm	Sn = 5,8 m
FTDR 047A048	54 x 75 mm	Sn = 8 m
FTDL 050K000/... m	tape 50 x ... mm	Sn = 2 m

dimension drawings

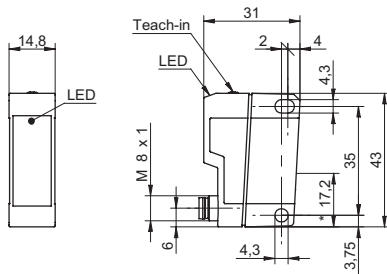

\* emitter axis

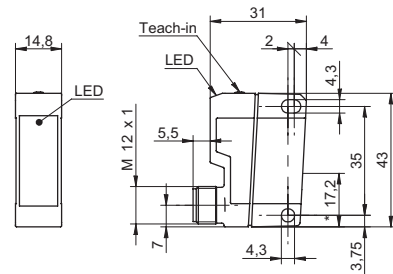

\* emitter axis

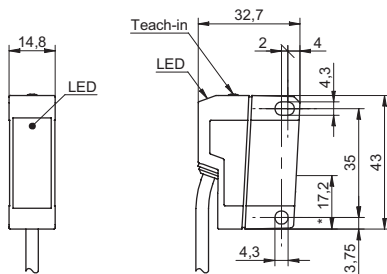

\* emitter axis

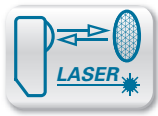

Sb = 4,5 m



- designed for detection of transparent objects
- single lens optics
- short response time

**general data**

type	retro-reflective laser sensor
version	for transparent objects single lens optics
light source	pulsed red laser diode
actual range Sb	4,5 m
nominal range Sn	5,2 m
repeat accuracy	< 0,1 mm at laser focus
polarization filter	yes
light indicator	LED yellow
power on indication	LED green
sensitivity adjustment	Teach-in
laser class	1
distance to focus	100 mm
wave length	650 nm

**electrical data**

response time / release time	< 0,25 ms
voltage supply range +Vs	10 ... 30 VDC
current consumption max. (no load)	35 mA
current consumption typ.	25 mA
voltage drop Vd	< 2,2 VDC
output circuit	PNP
output current	< 100 mA
short circuit protection	yes
reverse polarity protection	yes

**mechanical data**

width / diameter	14,8 mm
height / length	43 mm
depth	31 mm
type	rectangular
housing material	plastic (ASA, MABS)
front (optics)	PMMA

**ambient conditions**

operating temperature	-10 ... +50 °C
protection class	IP 67

**connection diagrams**



**connectors and mating connectors**

ESG 34AH0200	Connector M12, 4 pin, straight, 2 m
ESW 33AH0200	Connector M12, 4 pin, angular, 2 m
ESG 32AH0200	Connector M8, 4 pin, straight, 2 m
ESW 31AH0200	Connector M8, 4 pin, angular, 2 m

additional cable connectors and field wireable connectors: see accessories

**Accessories**

10149011	Sensofix series 14
10134964	Mounting bracket series 14 (L design)

for details: see accessories section

**laser warning**



IEC 60825-1/2014  
Complies with 21 CFR 1040.10 and 1040.11  
except for deviations pursuant to laser  
notice No. 50, dated June 24, 2007

order reference	connection types	output function	teach value stored after power-off
OPDK 14P1902	cable 4 pin, 2 m	light operate	volatile
OPDK 14P1902/S14	connector M12 4 pin	light operate	volatile
OPDK 14P1902/S35A	connector M8 4 pin	light operate	volatile
OPDK 14P1903	cable 4 pin, 2 m	light operate	non volatile
OPDK 14P1903/S14	connector M12 4 pin	light operate	non volatile
OPDK 14P1903/S35A	connector M8 4 pin	light operate	non volatile
OPDK 14P3902	cable 4 pin, 2 m	dark operate	volatile
OPDK 14P3902/S14	connector M12 4 pin	dark operate	volatile
OPDK 14P3902/S35A	connector M8 4 pin	dark operate	volatile
OPDK 14P3903	cable 4 pin, 2 m	dark operate	non volatile
OPDK 14P3903/S14	connector M12 4 pin	dark operate	non volatile
OPDK 14P3903/S35A	connector M8 4 pin	dark operate	non volatile

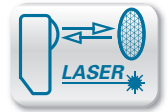

excess gain curves

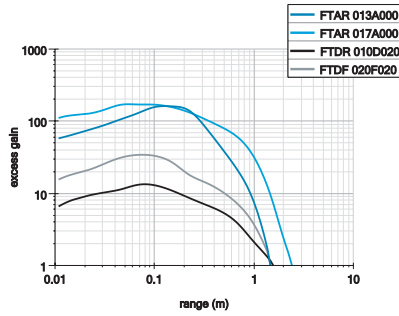
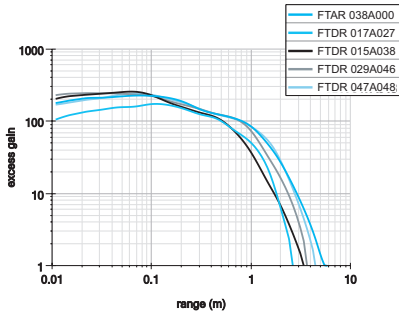

reflectors

FTAR 013A000	∅ 15 mm	Sn = 1,4 m
FTAR 017A000	∅ 20,7 mm	Sn = 2,2 m
FTAR 036A000	∅ 46 mm	Sn = 4,2 m
FTDR 010D020	15 x 25 mm	Sn = 1,4 m
FTDR 017A027	20 x 42 mm	Sn = 2,6 m
FTDR 015A038	18 x 40 mm	Sn = 3,2 m
FTDR 029A046	32,5 x 48 mm	Sn = 3,6 m
FTDR 047A048	54 x 75 mm	Sn = 5,2 m
FTDF 020F020	20 x 20 mm	Sn = 1,4 m

beam characteristic (typically)

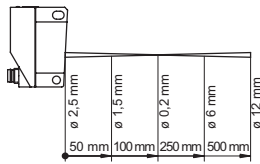

dimension drawings

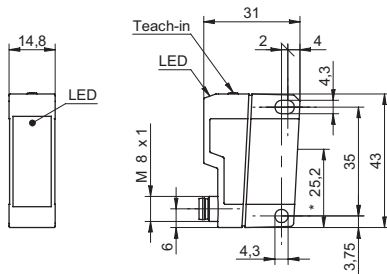

\* emitter and receiver axis

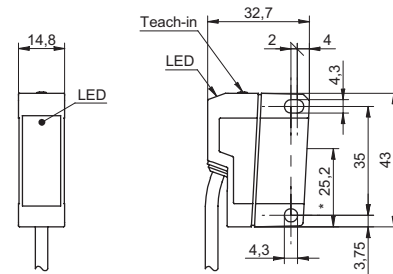

\* emitter and receiver axis

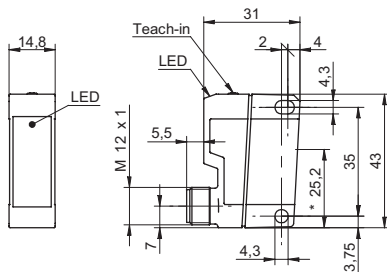

\* emitter and receiver axis

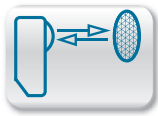

**S<sub>b</sub> = 6 m**

- rugged metal housing
- designed for detection of transparent objects
- sensitivity adjustable via Teach-in



#### general data

type	retro-reflective sensor
version	for transparent objects
light source	pulsed red LED
actual range S <sub>b</sub>	6 m
nominal range S <sub>n</sub>	7,2 m
polarization filter	yes
light indicator	LED yellow
sensitivity adjustment	Teach-in
wave length	660 nm

#### electrical data

response time / release time	< 2,5 ms
adaption time	< 25 ms
voltage supply range +Vs	10 ... 30 VDC
current consumption max. (no load)	50 mA
current consumption typ.	40 mA
voltage drop V <sub>d</sub>	< 1,8 VDC
output function	dark operate
output circuit	PNP
output current	< 200 mA
short circuit protection	yes
reverse polarity protection	yes

#### mechanical data

width / diameter	15,4 mm
height / length	50 mm
depth	50 mm
type	rectangular
housing material	die-cast zinc
front (optics)	PMMA
connection types	connector M12 4 pin

#### ambient conditions

operating temperature	-25 ... +65 °C
protection class	IP 67

#### order reference

**FPDM 16P3921/S14**

#### connection diagram

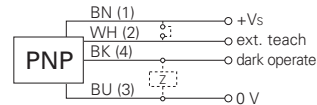

#### connectors and mating connectors

ESG 34AH0200	Connector M12, 4 pin, straight, 2 m
ESW 33AH0200	Connector M12, 4 pin, angular, 2 m

additional cable connectors and field wireable connectors: see accessories

#### Accessories

10151721	Sensofix series 16
10113917	Mounting bracket series 16 (L design)
10116407	Lens cleaning air nozzle bracket

for details: see accessories section



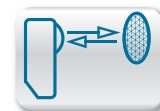

excess gain curves

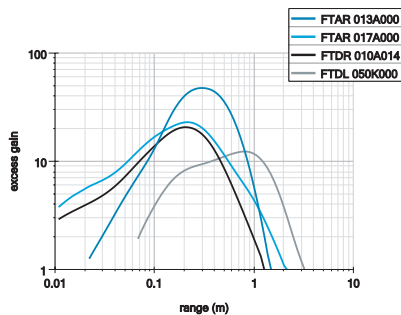
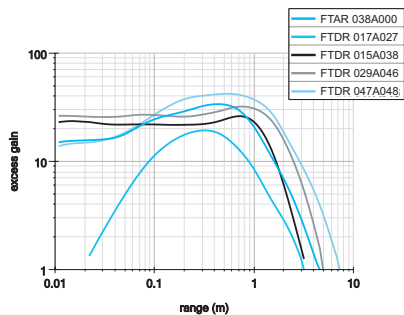

reflectors

FTAR 013A000	∅ 15 mm	Sn = 1,5 m
FTAR 017A000	∅ 20,7 mm	Sn = 2,1 m
FTAR 036A000	∅ 46 mm	Sn = 4,6 m
FTDR 010D014	12,8 x 16,8 mm	Sn = 1,3 m
FTDR 017A027	20 x 42 mm	Sn = 3,1 m
FTDR 015A038	18 x 40 mm	Sn = 3,2 m
FTDR 029A046	32,5 x 48 mm	Sn = 5 m
FTDR 047A048	54 x 75 mm	Sn = 7,2 m
FTDL 050K000/... m	tape 50 x ... mm	Sn = 3 m

dimension drawing

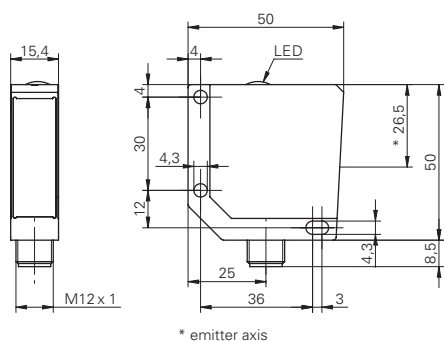

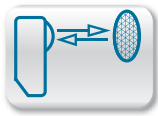

**S<sub>b</sub> = 5,5 m**

- PinPoint LED
- designed for detection of transparent objects
- polarization filter to detect shiny objects



### general data

type	retro-reflective sensor
version	transparency object detection
light source	pulsed PinPoint LED
actual range S <sub>b</sub>	5,5 m
nominal range S <sub>n</sub>	6 m
polarization filter	yes
minimal signal attenuation	10 % / 20 % / 30 %
light indicator	LED yellow
power on indication	LED green
sensitivity adjustment	Teach-in and IO-Link
wave length	630 nm
suppression of reciprocal influence	yes
alignment optical axis	< 1°

### electrical data

response time / release time	< 0,25 ms
voltage supply range +Vs	10 ... 30 VDC
current consumption max. (no load)	35 mA
current consumption typ.	30 mA
voltage drop V <sub>d</sub>	< 3 VDC
output function	light / dark operate
output circuit	push-pull
output current	< 100 mA
short circuit protection	yes
reverse polarity protection	yes

### mechanical data

width / diameter	18 mm
height / length	45 mm
depth	32 mm
type	rectangular
housing material	plastic (ASA, PMMA)
front (optics)	PMMA

### ambient conditions

operating temperature	-25 ... +60 °C
protection class	IP 67

### order reference

<b>O500.RP.T-11157339</b>	cable 4 pin, 2 m
<b>O500.RP.T-11157351</b>	connector M12 4 pin

### connection types

### connection diagram

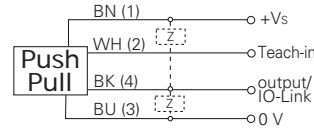

### connectors and mating connectors

ESG 34AH0200	Connector M12, 4 pin, straight, 2 m
ESW 33AH0200	Connector M12, 4 pin, angular, 2 m

additional cable connectors and field wireable connectors: see accessories

### Accessories

11099942	Sensofix O500/U500
11092246	Mounting bracket O500/U500 (L design)
11111164	Mounting bracket O500/U500 - Retrofit for sensors series 30

for details: see accessories section

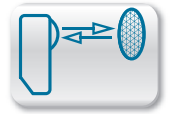

excess gain curves

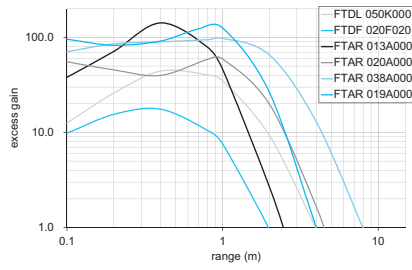
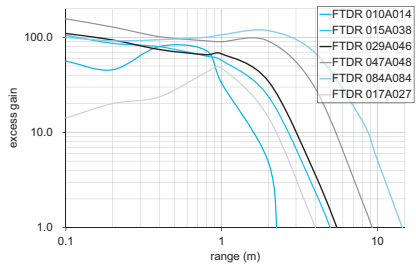

beam characteristic (typically)

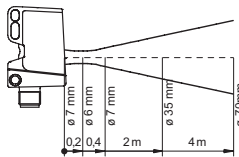

dimension drawings

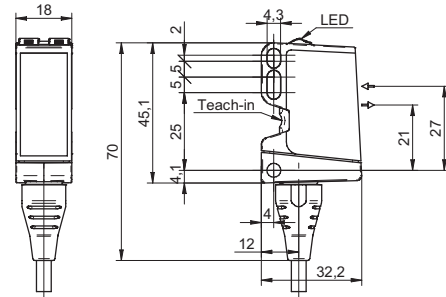
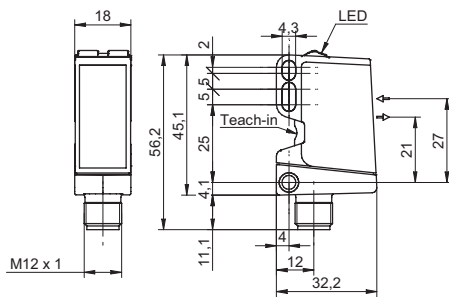

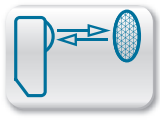

**S<sub>b</sub> = 5,5 m**



- washdown design
- PinPoint LED
- designed for detection of transparent objects

#### general data

type	retro-reflective sensor
special type	Washdown design
version	transparency object detection
light source	pulsed PinPoint LED
actual range S <sub>b</sub>	5,5 m
nominal range S <sub>n</sub>	6 m
polarization filter	yes
minimal signal attenuation	10 % / 20 % / 30 %
light indicator	LED yellow
power on indication	LED green
sensitivity adjustment	Teach-in and IO-Link
wave length	630 nm
suppression of reciprocal influence	yes
alignment optical axis	< 1°
approvals/certificates	Ecolab

#### electrical data

response time / release time	< 0,25 ms
voltage supply range +Vs	10 ... 30 VDC
current consumption max. (no load)	35 mA
current consumption typ.	30 mA
voltage drop V <sub>d</sub>	< 3 VDC
output function	light / dark operate
output circuit	push-pull
output current	< 100 mA
short circuit protection	yes
reverse polarity protection	yes

#### mechanical data

width / diameter	20,2 mm
height / length	47,2 mm
depth	37,7 mm
type	rectangular
housing material	stainless steel 1.4404 (V4A)
front (optics)	PMMA
connection types	connector M12 4 pin

#### ambient conditions

operating temperature	-25 ... +60 °C
protection class	IP 68/69K & proTect+

#### order reference

**O500W.RP.T-11157357**

#### connection diagram

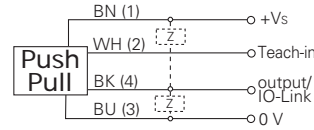

#### connectors and mating connectors

ESG 34AY0200	Connector M12, 4 pin, straight, 2 m, V4A-PP
ESW 33AY0200	Connector M12, 4 pin, angular, 2 m, V4A-PP

additional cable connectors and field wireable connectors: see accessories

#### Accessories

11092246	Mounting bracket O500/U500 (L design)
11111164	Mounting bracket O500/U500 - Retrofit for sensors series 30
11099942	Sensofix O500/U500

for details: see accessories section

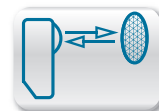

excess gain curves

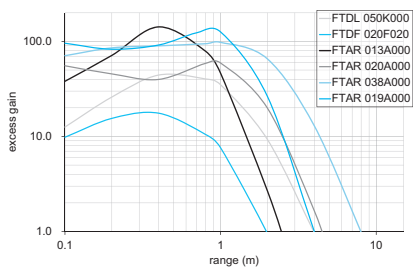
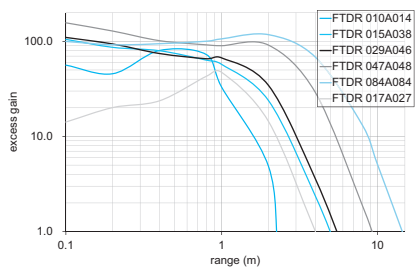

beam characteristic (typically)

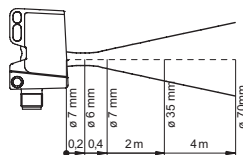

dimension drawing

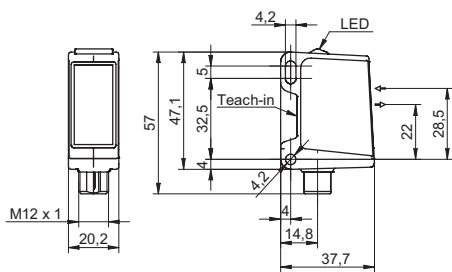

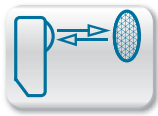

Sb = 5,5 m

- hygienic design
- PinPoint LED
- designed for detection of transparent objects



**general data**

type	retro-reflective sensor
special type	hygienic design
version	transparency object detection
light source	pulsed PinPoint LED
actual range Sb	5,5 m
nominal range Sn	6 m
polarization filter	yes
minimal signal attenuation	10 % / 20 % / 30 %
light indicator	LED yellow
power on indication	LED green
sensitivity adjustment	Teach-in and IO-Link
wave length	630 nm
suppression of reciprocal influence	yes
alignment optical axis	< 1°
approvals/certificates	Ecolab

**electrical data**

response time / release time	< 0,25 ms
voltage supply range +Vs	10 ... 30 VDC
current consumption max. (no load)	35 mA
current consumption typ.	30 mA
voltage drop Vd	< 3 VDC
output function	light / dark operate
output circuit	push-pull
output current	< 100 mA
short circuit protection	yes
reverse polarity protection	yes

**mechanical data**

width / diameter	20,2 mm
height / length	47,7 mm
depth	36,4 mm
type	rectangular
housing material	stainless steel 1.4404 (V4A)
front (optics)	PMMA

**ambient conditions**

operating temperature	-25 ... +60 °C
protection class	IP 68/69K & proTect+

**order reference**

<b>O500H.RP.T-11157354</b>	cable 4 pin, 2 m
<b>O500H.RP.T-11157356</b>	flylead connector M12, L=300 mm

**connection types**

**connection diagram**

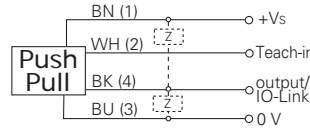

**connectors and mating connectors**

ESG 34AY0200	Connector M12, 4 pin, straight, 2 m, V4A-PP
ESW 33AY0200	Connector M12, 4 pin, angular, 2 m, V4A-PP

additional cable connectors and field wireable connectors: see accessories

**Accessories**

HI17-1H	Mounting for sensors in hygienic design Ø 17 mm
11137318	Teach Pen for sensors in metal housing
11141124	Teach Pen for sensors in metal housing (USA, CAN, JP)

for details: see accessories section

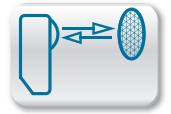

excess gain curves

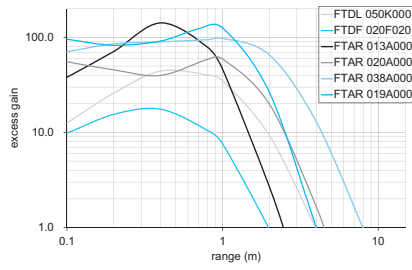
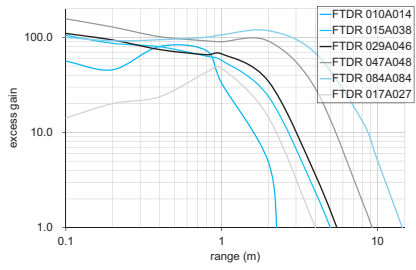

beam characteristic (typically)

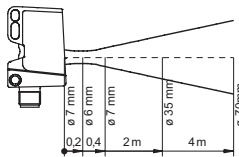

dimension drawings

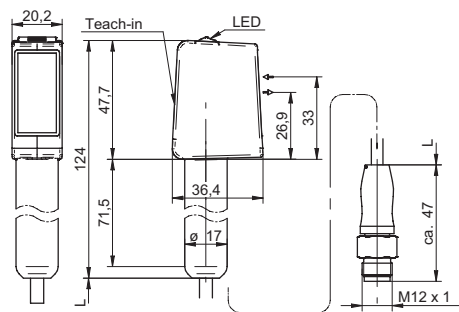
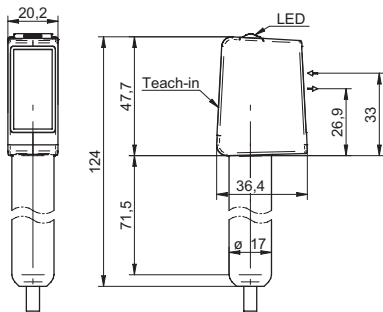

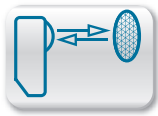

S<sub>b</sub> = 0.5 m

- designed for detection of transparent objects
- polarization filter to detect shiny objects
- sensitivity adjustable via potentiometer



**general data**

type	retro-reflective sensor
version	transparency object detection
light source	pulsed red LED
actual range S <sub>b</sub>	0,5 m
nominal range S <sub>n</sub>	0,8 m
polarization filter	yes
output indicator	LED yellow
sensitivity adjustment	potentiometer, 270°
wave length	660 nm
suppression of reciprocal influence	yes

**electrical data**

response time / release time	< 1 ms
voltage supply range +Vs	12 ... 30 VDC
current consumption max. (no load)	40 mA
current consumption typ.	30 mA
voltage drop V <sub>d</sub>	< 2 VDC
output function	light / dark operate
output current	< 100 mA
short circuit protection	yes
reverse polarity protection	yes

**mechanical data**

width / diameter	18 mm
height / length	67,2 mm
type	cylindrical threaded
housing material	plastic (ABS TERLURAN)
front (optics)	PMMA
connection types	connector M12 4 pin

**ambient conditions**

operating temperature	-25 ... +55 °C
protection class	IP 67

**order reference      output circuit**

<b>OR18.RR.T-11157789</b>	NPN
<b>OR18.RR.T-11157788</b>	PNP

**connection diagrams**

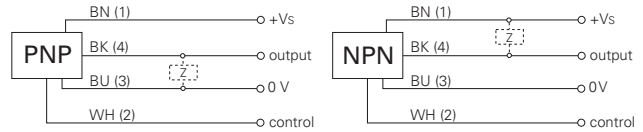

**connectors and mating connectors**

ESG 34AH0200	Connector M12, 4 pin, straight, 2 m
ESW 33AH0200	Connector M12, 4 pin, angular, 2 m

additional cable connectors and field wireable connectors: see accessories

**Accessories**

10151658	Sensofix series 18
ZADAP-M18.STANDARD	Mounting bracket series 18
ZADAP-M18.SHORT	Mounting bracket short series 18 (L design)
ZADAP-M18.LONG	Mounting bracket long series 18 (L design)
ZADAP-M18.SWING	Mounting bracket for adjustment for sensors series 18
ZADAP-M18.MICRO	Mounting bracket for adjustment for sensors series 18
ZPART-M18.NUT	Clamping nut for sensors Ø 18 mm

for details: see accessories section



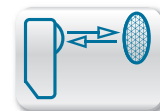

excess gain curve

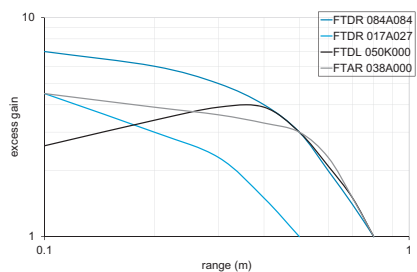

beam characteristic (typically)

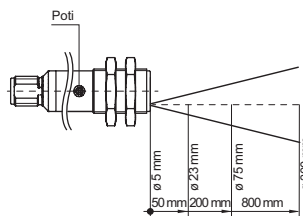

dimension drawing

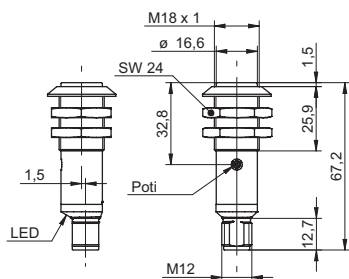

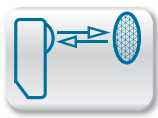

S<sub>b</sub> = 4 m



- washdown design
- designed for detection of transparent objects
- polarization filter to detect shiny objects

**general data**

type	retro-reflective sensor
special type	Washdown design
version	transparency object detection
light source	pulsed red LED
actual range S <sub>b</sub>	0,5 m
nominal range S <sub>n</sub>	0,8 m
polarization filter	yes
output indicator	LED yellow
sensitivity adjustment	potentiometer, 270°
wave length	660 nm
suppression of reciprocal influence	yes

**electrical data**

response time / release time	< 1 ms
voltage supply range +Vs	12 ... 30 VDC
current consumption max. (no load)	40 mA
current consumption typ.	30 mA
voltage drop V <sub>d</sub>	< 2 VDC
output function	light / dark operate
output current	< 100 mA
short circuit protection	yes
reverse polarity protection	yes

**mechanical data**

width / diameter	18 mm
height / length	67,2 mm
type	cylindrical threaded
housing material	stainless steel 1.4404 (V4A)
front (optics)	PMMA
connection types	connector M12 4 pin

**ambient conditions**

operating temperature	-25 ... +55 °C
protection class	IP 67/69K

**order reference**

<b>OR18W.RR.T-11157846</b>
<b>OR18W.RR.T-11157845</b>

**output circuit**

NPN
PNP

**connection diagrams**

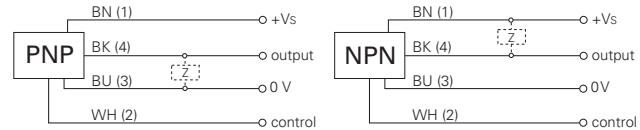

**connectors and mating connectors**

ESG 34AY0200	Connector M12, 4 pin, straight, 2 m, V4A-PP
ESW 33AY0200	Connector M12, 4 pin, angular, 2 m, V4A-PP

additional cable connectors and field wireable connectors: see accessories

**Accessories**

10151658	Sensofix series 18
ZADAP-M18.STANDARD	Mounting bracket series 18
ZADAP-M18.SHORT	Mounting bracket short series 18 (L design)
ZADAP-M18.LONG	Mounting bracket long series 18 (L design)
ZADAP-M18.SWING	Mounting bracket for adjustment for sensors series 18
ZADAP-M18.MICRO	Mounting bracket for adjustment for sensors series 18

for details: see accessories section

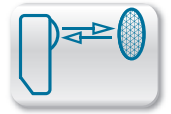

excess gain curve

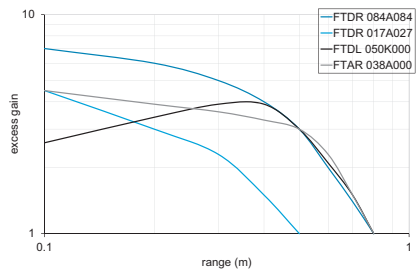

dimension drawing

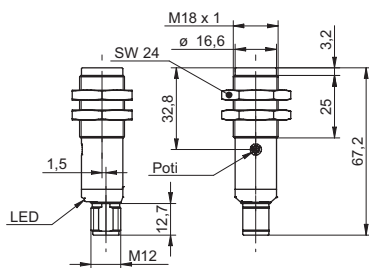

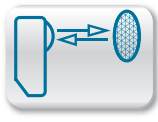
S<sub>b</sub> = 5 m

- One inch class
- washdown design
- PinPoint LED

**general data**

type	retro-reflective sensor
special type	Washdown design
light source	pulsed PinPoint LED
actual range S <sub>b</sub>	5 m
nominal range S <sub>n</sub>	6 m
polarization filter	yes
light indicator	LED yellow
power on indication	LED green
sensitivity adjustment	qTeach / remote
wave length	630 nm
suppression of reciprocal influence	yes
alignment optical axis	< 2°
approvals/certificates	Ecolab

**electrical data**

response time / release time	< 0,49 ms
voltage supply range +Vs	10 ... 30 VDC
current consumption max. (no load)	35 mA
current consumption typ.	25 mA
voltage drop V <sub>d</sub>	< 3 VDC
output function	light / dark operate
output circuit	push-pull
output current	< 100 mA
short circuit protection	yes
reverse polarity protection	yes

**mechanical data**

width / diameter	16,5 mm
height / length	34,7 mm
depth	28,2 mm
type	rectangular
housing material	stainless steel 1.4404 (V4A)
front (optics)	PMMA
connection types	connector M8 4 pin

**ambient conditions**

operating temperature	-25 ... +60 °C
protection class	IP 68/69K & proTect+

**order reference**

O300W.RP-1112720

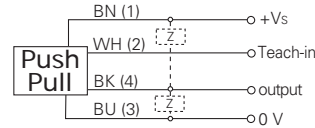
**connection diagram****connectors and mating connectors**

ESG 32AY0200 Connector M8, 4 pin, straight, 2 m, V4A-PP

ESW 31AY0200 Connector M8, 4 pin, angular, 2 m, V4A-PP

additional cable connectors and field wireable connectors: see accessories

**Accessories**

11104963 Sensofix O300

11102423 Mounting bracket O300 (L design)

11124807 Mounting bracket O300 - Retrofit for sensors series 20

for details: see accessories section

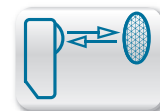

excess gain curves

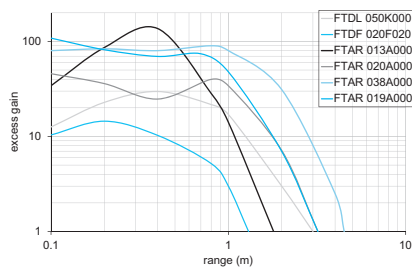
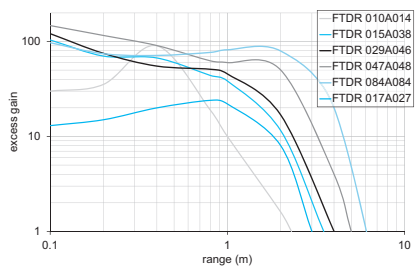

beam characteristic (typically)

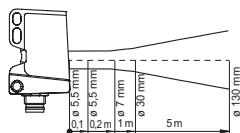

dimension drawing

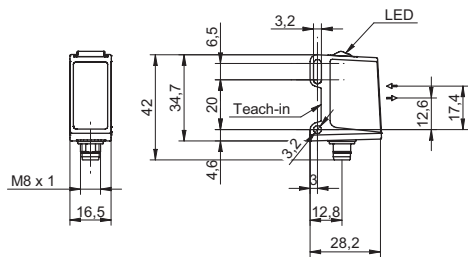

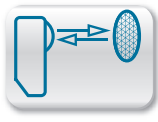
S<sub>b</sub> = 5 m

- One inch class
- hygienic design
- PinPoint LED

**general data**

type	retro-reflective sensor
special type	hygienic design
light source	pulsed PinPoint LED
actual range S <sub>b</sub>	5 m
nominal range S <sub>n</sub>	6 m
polarization filter	yes
light indicator	LED yellow
power on indication	LED green
sensitivity adjustment	Teach-in: remote
wave length	630 nm
suppression of reciprocal influence	yes
alignment optical axis	< 2°
approvals/certificates	Ecolab

**electrical data**

response time / release time	< 0,49 ms
voltage supply range +Vs	10 ... 30 VDC
current consumption max. (no load)	35 mA
current consumption typ.	25 mA
voltage drop V <sub>d</sub>	< 3 VDC
output function	light / dark operate
output circuit	push-pull
output current	< 100 mA
short circuit protection	yes
reverse polarity protection	yes

**mechanical data**

width / diameter	16,5 mm
height / length	34,6 mm
depth	28,7 mm
type	rectangular
housing material	stainless steel 1.4404 (V4A)
front (optics)	PMMA

**ambient conditions**

operating temperature	-25 ... +60 °C
protection class	IP 68/69K & proTect+

**order reference**

<b>O300H.RP-11127716</b>	cable 4 pin, 2 m
<b>O300H.RP-11157327</b>	flylead connector M8, L=200 mm

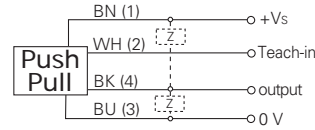
**connection diagram****connectors and mating connectors**

ESG 32AY0200 Connector M8, 4 pin, straight, 2 m, V4A-PP

ESW 31AY0200 Connector M8, 4 pin, angular, 2 m, V4A-PP

additional cable connectors and field wireable connectors: see accessories

**Accessories**

HI11-1H Mounting for sensors in hygienic design Ø 11 mm

11137318 Teach Pen for sensors in metal housing

11141124 Teach Pen for sensors in metal housing (USA, CAN, JP)

for details: see accessories section

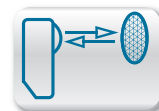

excess gain curves

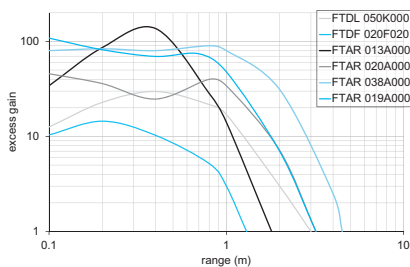
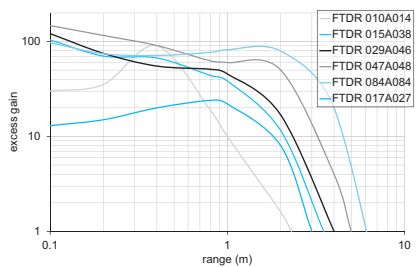

beam characteristic (typically)

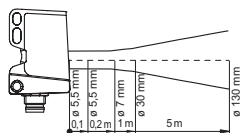

dimension drawings

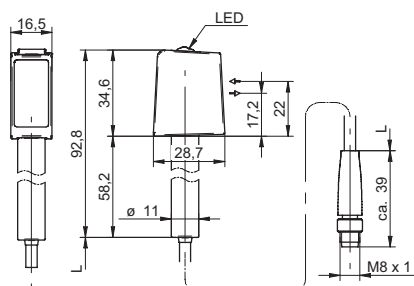
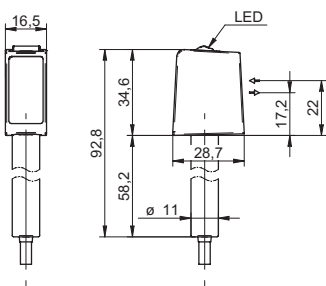

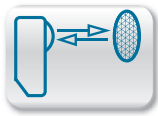

**S<sub>b</sub> = 3 m**



- washdown design
- Ecolab approved

#### general data

type	retro-reflective sensor
special type	Washdown design
light source	pulsed red LED
actual range S <sub>b</sub>	3 m
nominal range S <sub>n</sub>	3,5 m
polarization filter	yes
alignment / soiled lens indicator	flashing light indicator
light indicator	LED yellow
sensitivity adjustment	no
wave length	660 nm
suppression of reciprocal influence	yes
approvals/certificates	Ecolab

#### electrical data

response time / release time	< 1 ms
voltage supply range +Vs	10 ... 30 VDC
current consumption max. (no load)	25 mA
current consumption typ.	20 mA
voltage drop V <sub>d</sub>	< 1,8 VDC
output function	light / dark operate
output current	< 100 mA
short circuit protection	yes
reverse polarity protection	yes

#### mechanical data

width / diameter	19,6 mm
height / length	51 mm
depth	34,3 mm
type	rectangular
housing material	stainless steel 1.4404 (V4A)
front (optics)	PMMA
connection types	connector M12

#### ambient conditions

operating temperature	-30 ... +60 °C
protection class	IP 68/69K & proTect+
storage temperature	-30 ... +70 °C

#### order reference

order reference	output circuit
FPDR 14N5101/S14	NPN
FPDR 14P5101/S14	PNP

#### connection diagrams



#### connectors and mating connectors

ESG 34AY0200 Connector M12, 4 pin, straight, 2 m, V4A-PP

ESW 33AY0200 Connector M12, 4 pin, angular, 2 m, V4A-PP

additional cable connectors and field wireable connectors: see accessories

#### Accessories

11046278 Mounting bracket series 14 washdown

11046279 Sensofix series 14 washdown

for details: see accessories section

#### remarks

Sensor FDA compliant and Ecolab approved  
LSR = Liquid Silicon Rubber



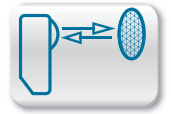

dimension drawing

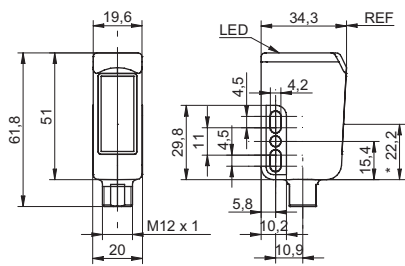

\* emitter axis

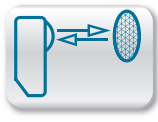

S<sub>b</sub> = 3 m

- hygienic design
- EHEDG certified



**general data**

type	retro-reflective sensor
special type	hygienic design
light source	pulsed red LED
actual range S <sub>b</sub>	3 m
nominal range S <sub>n</sub>	3,5 m
polarization filter	yes
alignment / soiled lens indicator	flashing light indicator
light indicator	LED yellow
sensitivity adjustment	no
wave length	660 nm
suppression of reciprocal influence	yes
approvals/certificates	Ecolab EHEDG

**electrical data**

response time / release time	< 1 ms
voltage supply range +Vs	10 ... 30 VDC
current consumption max. (no load)	25 mA
current consumption typ.	20 mA
voltage drop V <sub>d</sub>	< 1,8 VDC
output function	light / dark operate
output current	< 100 mA
short circuit protection	yes
reverse polarity protection	yes

**mechanical data**

width / diameter	19,6 mm
height / length	52,2 mm
depth	34,3 mm
type	rectangular
housing material	stainless steel 1.4404 (V4A)
front (optics)	PMMA

**ambient conditions**

operating temperature	-30 ... +60 °C
protection class	IP 68/69K & proTect+
storage temperature	-30 ... +70 °C

**connection diagrams**



**connectors and mating connectors**

ESG 34AY0200	Connector M12, 4 pin, straight, 2 m, V4A-PP
ESW 33AY0200	Connector M12, 4 pin, angular, 2 m, V4A-PP

additional cable connectors and field wireable connectors: see accessories

**Accessories**

HI17-1H	Mounting for sensors in hygienic design Ø 17 mm
---------	---

for details: see accessories section

**remarks**

Sensor FDA compliant, EHEDG certified and Ecolab approved  
LSR = Liquid Silicon Rubber

order reference	connection types	output circuit
FPDH 14N5101	cable 4 pin, 2 m	NPN
FPDH 14N5101/KS34A	flylead connector M12, L=300 mm	NPN
FPDH 14P5101	cable 4 pin, 2 m	PNP
FPDH 14P5101/KS34A	flylead connector M12, L=300 mm	PNP

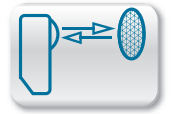

dimension drawings

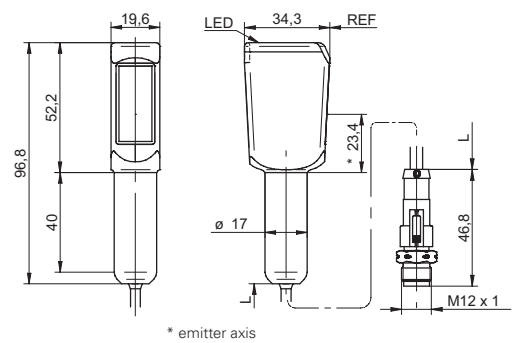
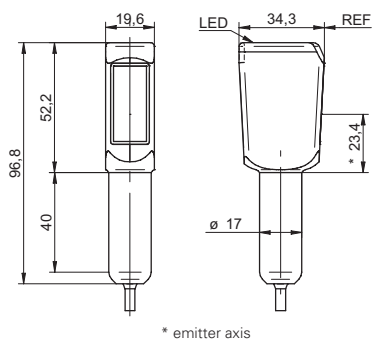

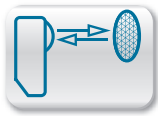

$S_b = 7,5 \text{ m}$



- washdown design
- PinPoint LED
- polarization filter to detect shiny objects

#### general data

type	retro-reflective sensor
special type	Washdown design
light source	pulsed PinPoint LED
actual range $S_b$	7,5 m
nominal range $S_n$	8 m
polarization filter	yes
light indicator	LED yellow
power on indication	LED green
sensitivity adjustment	qTeach / remote
wave length	630 nm
suppression of reciprocal influence	yes
alignment optical axis	< 1°
approvals/certificates	Ecolab

#### electrical data

response time / release time	< 0,49 ms
voltage supply range +Vs	10 ... 30 VDC
current consumption max. (no load)	40 mA
current consumption typ.	30 mA
voltage drop $V_d$	< 3 VDC
output function	light / dark operate
output circuit	push-pull
output current	< 100 mA
short circuit protection	yes
reverse polarity protection	yes

#### mechanical data

width / diameter	20,2 mm
height / length	47,2 mm
depth	37,7 mm
type	rectangular
housing material	stainless steel 1.4404 (V4A)
front (optics)	PMMA
connection types	connector M12 4 pin

#### ambient conditions

operating temperature	-25 ... +60 °C
protection class	IP 68/69K & proTect+

#### order reference

O500W.RP-11107745

#### connection diagram

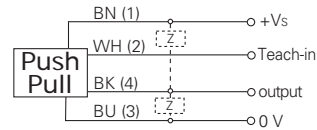

#### connectors and mating connectors

ESG 34AY0200	Connector M12, 4 pin, straight, 2 m, V4A-PP
ESW 33AY0200	Connector M12, 4 pin, angular, 2 m, V4A-PP

additional cable connectors and field wireable connectors: see accessories

#### Accessories

11092246	Mounting bracket O500/U500 (L design)
11111164	Mounting bracket O500/U500 - Retrofit for sensors series 30
11099942	Sensofix O500/U500

for details: see accessories section

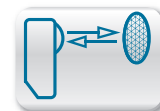

excess gain curves

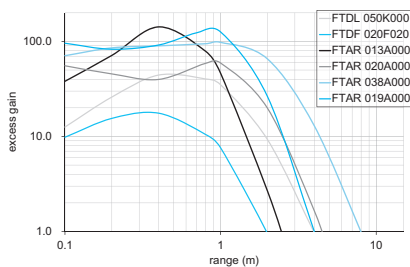
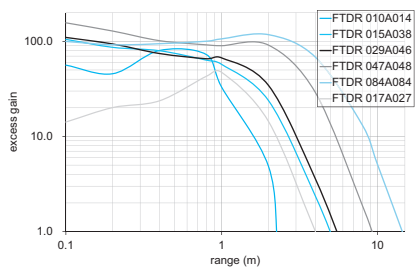

beam characteristic (typically)

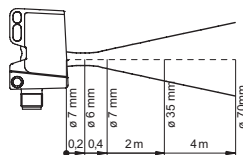

dimension drawing

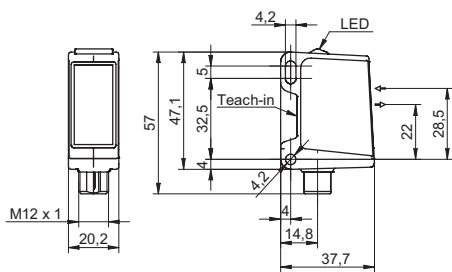

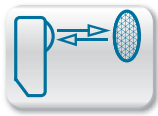

$S_b = 7,5 \text{ m}$



- washdown design
- PinPoint LED
- polarization filter to detect shiny objects

#### general data

type	retro-reflective sensor
special type	Washdown design
light source	pulsed PinPoint LED
actual range $S_b$	7,5 m
nominal range $S_n$	8 m
polarization filter	yes
light indicator	LED yellow
power on indication	LED green
sensitivity adjustment	Teach-in: remote
wave length	630 nm
suppression of reciprocal influence	yes
alignment optical axis	< 1°
approvals/certificates	Ecolab

#### electrical data

response time / release time	< 0,49 ms
voltage supply range +Vs	10 ... 30 VDC
current consumption max. (no load)	40 mA
current consumption typ.	30 mA
voltage drop $V_d$	< 3 VDC
output function	light / dark operate
output circuit	push-pull
output current	< 100 mA
short circuit protection	yes
reverse polarity protection	yes

#### mechanical data

width / diameter	20,2 mm
height / length	47,2 mm
depth	37,7 mm
type	rectangular
housing material	stainless steel 1.4404 (V4A)
front (optics)	PMMA
connection types	connector M12 4 pin

#### ambient conditions

operating temperature	-25 ... +60 °C
protection class	IP 68/69K & proTect+

#### order reference

O500W.RP-11125066

#### connection diagram

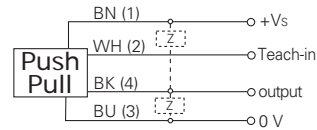

#### connectors and mating connectors

ESG 34AY0200	Connector M12, 4 pin, straight, 2 m, V4A-PP
ESW 33AY0200	Connector M12, 4 pin, angular, 2 m, V4A-PP

additional cable connectors and field wireable connectors: see accessories

#### Accessories

11092246	Mounting bracket O500/U500 (L design)
11111164	Mounting bracket O500/U500 - Retrofit for sensors series 30
11099942	Sensofix O500/U500
11137318	Teach Pen for sensors in metal housing
11141124	Teach Pen for sensors in metal housing (USA, CAN, JP)

for details: see accessories section

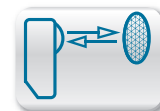

excess gain curves

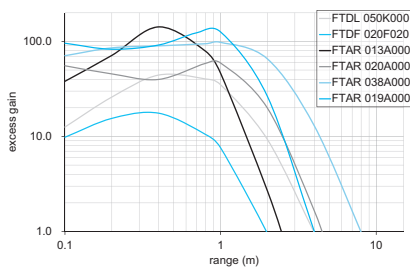
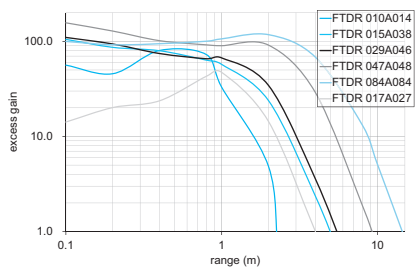

beam characteristic (typically)

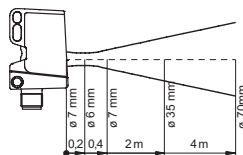

dimension drawing

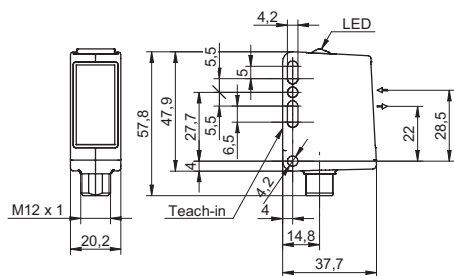

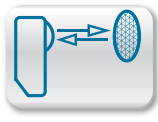

$S_b = 7,5 \text{ m}$

- hygienic design
- PinPoint LED
- polarization filter to detect shiny objects



#### general data

type	retro-reflective sensor
special type	hygienic design
light source	pulsed PinPoint LED
actual range $S_b$	7,5 m
nominal range $S_n$	8 m
polarization filter	yes
light indicator	LED yellow
power on indication	LED green
sensitivity adjustment	Teach-in: remote
wave length	630 nm
suppression of reciprocal influence	yes
alignment optical axis	< 1°
approvals/certificates	Ecolab

#### electrical data

response time / release time	< 0,49 ms
voltage supply range +Vs	10 ... 30 VDC
current consumption max. (no load)	40 mA
current consumption typ.	30 mA
voltage drop $V_d$	< 3 VDC
output function	light / dark operate
output circuit	push-pull
output current	< 100 mA
short circuit protection	yes
reverse polarity protection	yes

#### mechanical data

width / diameter	20,2 mm
height / length	47,7 mm
depth	36,4 mm
type	rectangular
housing material	stainless steel 1.4404 (V4A)
front (optics)	PMMA

#### ambient conditions

operating temperature	-25 ... +60 °C
protection class	IP 68/69K & proTect+

#### order reference

<b>O500H.RP-11107831</b>	cable 4 pin, 2 m
<b>O500H.RP-11107832</b>	flylead connector M12, L=300 mm

#### connection types

#### connection diagram

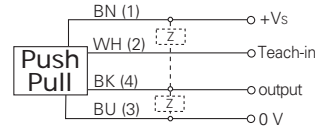

#### connectors and mating connectors

ESG 34AY0200	Connector M12, 4 pin, straight, 2 m, V4A-PP
ESW 33AY0200	Connector M12, 4 pin, angular, 2 m, V4A-PP

additional cable connectors and field wireable connectors: see accessories

#### Accessories

HI17-1H	Mounting for sensors in hygienic design Ø 17 mm
11137318	Teach Pen for sensors in metal housing
11141124	Teach Pen for sensors in metal housing (USA, CAN, JP)

for details: see accessories section



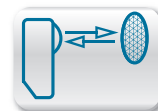

excess gain curves

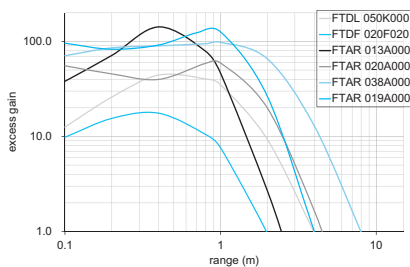
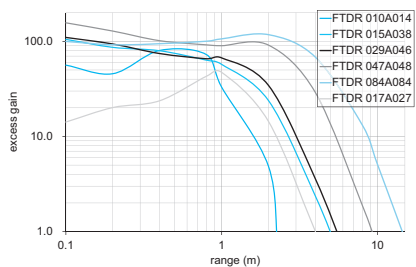

beam characteristic (typically)

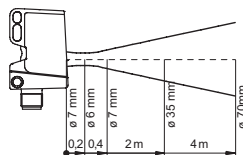

dimension drawings

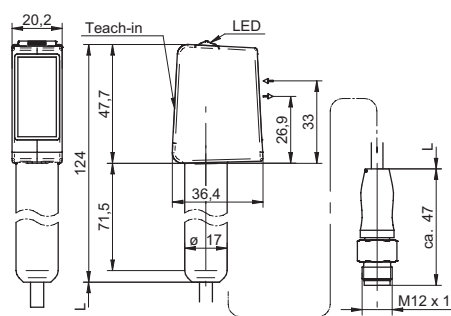
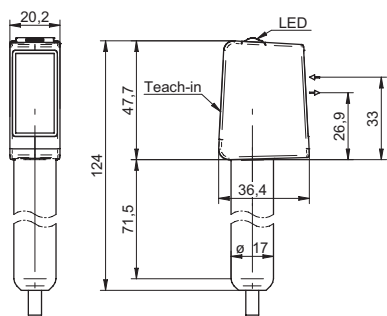

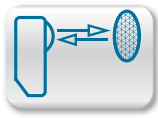

S<sub>b</sub> = 3,5 m

- washdown design
- polarization filter to detect shiny objects
- sensitivity adjustable via potentiometer



**general data**

type	retro-reflective sensor
special type	Washdown design
light source	pulsed red LED
actual range S <sub>b</sub>	3,5 m
nominal range S <sub>n</sub>	4,5 m
polarization filter	yes
alignment / soiled lens indicator	LED green
output indicator	LED yellow
sensitivity adjustment	potentiometer, 270°
wave length	660 nm
suppression of reciprocal influence	yes

**electrical data**

response time / release time	< 1 ms
voltage supply range +Vs	12 ... 30 VDC
current consumption max. (no load)	40 mA
current consumption typ.	30 mA
voltage drop V <sub>d</sub>	< 2 VDC
output function	light / dark operate
output current	< 100 mA
short circuit protection	yes
reverse polarity protection	yes

**mechanical data**

width / diameter	18 mm
height / length	67,2 mm
type	cylindrical threaded
housing material	stainless steel 1.4404 (V4A)
front (optics)	PMMA
connection types	connector M12 4 pin

**ambient conditions**

operating temperature	-25 ... +55 °C
protection class	IP 67/69K

**order reference      output circuit**

<b>OR18W.RR-11157844</b>	NPN
<b>OR18W.RR-11157843</b>	PNP

**connection diagrams**

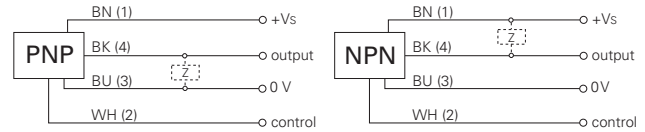

**connectors and mating connectors**

ESG 34AY0200	Connector M12, 4 pin, straight, 2 m, V4A-PP
ESW 33AY0200	Connector M12, 4 pin, angular, 2 m, V4A-PP

additional cable connectors and field wireable connectors: see accessories

**Accessories**

10151658	Sensofix series 18
ZADAP-M18.STANDARD	Mounting bracket series 18
ZADAP-M18.SHORT	Mounting bracket short series 18 (L design)
ZADAP-M18.LONG	Mounting bracket long series 18 (L design)
ZADAP-M18.SWING	Mounting bracket for adjustment for sensors series 18
ZADAP-M18.MICRO	Mounting bracket for adjustment for sensors series 18

for details: see accessories section

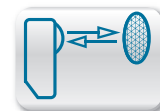



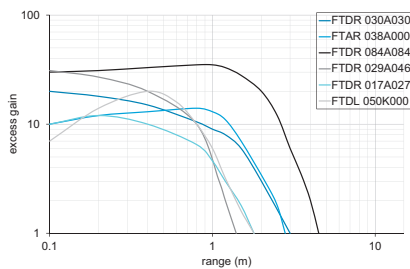
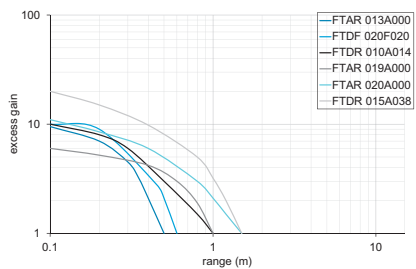

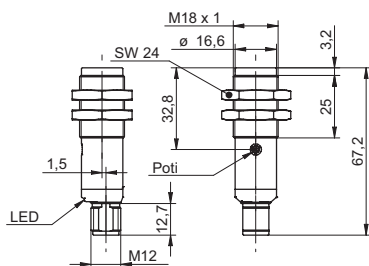

excess gain curves









dimension drawing







red light LED version





product family	FSCK 07 / FECK 07	FSDK 07 / FEDK 07	FSDM 08 / FEDM 08	FSDM 08 / FEDM 08	FSAM 08 / FEAM 08	FSDK 10 / FEDK 10	FSDM 12 / FEDM 12
							
width / diameter	8 mm	8 mm	8 mm	8 mm	8 mm	10,4 mm	12,4 mm
actual range Sb	2 m	2 m	0,7 m	2,5 m	2,5 m	5 m	6 m
response time / release time	< 0,5 ms	< 0,5 ms	< 2,5 ms	< 2,5 ms	< 2,5 ms	< 1,4 ms	< 1 ms
light source	pulsed red LED	pulsed red LED	pulsed infrared diode	pulsed infrared diode	pulsed infrared diode	pulsed red LED	pulsed red LED
sensitivity adjustment	Teach-in	Teach-in	no	no	no	potentiometer, 270°	no
output circuit	NPN PNP	NPN PNP	PNP	PNP	PNP	NPN PNP	PNP
connection types	cable flylead connector	cable flylead connector	cable connector	cable connector	cable connector	cable connector flylead connector	cable connector
housing material	plastic	plastic	metal	metal	metal	plastic	metal
protection class	IP 65	IP 65	IP 65	IP 65	IP 65	IP 65 IP 67	IP 67
<b>page</b>	<b>184</b>	<b>186</b>	<b>188</b>	<b>190</b>	<b>192</b>	<b>194</b>	<b>196</b>

laser version

product family	OSDK 10 / OEDK 10	O300.EL / O300.TL	O300W.EL / O300W.TL	O300H.EL / O300H.TL	OSDK 14 / OEDK 14	OR18.EL / OR18.TL
						
width / diameter	10,4 mm	12,9 mm	16,5 mm	16,5 mm	14,8 mm	18 mm
actual range Sb	8 m	40 m	40 m	40 m	8 m	55 m
response time / release time	< 0,2 ms	< 0,49 ms	< 0,49 ms	< 0,49 ms	< 0,5 ms	< 0,34 ms
light source	pulsed red laser diode	pulsed red laser diode	pulsed red laser diode	pulsed red laser diode	pulsed red laser diode	pulsed red laser diode
sensitivity adjustment	potentiometer, 270°	qTeach / remote qTeach	qTeach / remote	Teach-in: remote	no	potentiometer, 270°
output circuit	NPN PNP	push-pull NPN PNP	push-pull	push-pull	PNP	NPN PNP
connection types	cable connector	cable connector	connector	cable flylead connector	cable connector	cable connector
housing material	plastic	plastic	metal	metal	plastic	metal
protection class	IP 65 IP 67	IP 67	IP 68/69K & proTect+	IP 68/69K & proTect+	IP 67	IP 67
<b>page</b>	<b>206</b>	<b>208</b>	<b>212</b>	<b>216</b>	<b>220</b>	<b>222</b>

O300.ER / O300.TR	FSDK 14 / FEDK 14	O500.ER / O500.TR	OR18.EI / OR18.TI
			
12,9 mm	14,8 mm	18 mm	18 mm
10 m	12 m	25 m	13 m
< 0,49 ms	< 1,2 ms	< 0,49 ms	< 2 ms
pulsed red LED	pulsed red LED	pulsed red LED	pulsed infrared diode
qTeach / remote qTeach	no	qTeach / remote qTeach	potentiometer, 270°
push-pull NPN PNP	NPN PNP	push-pull NPN PNP	NPN PNP
cable connector	cable connector	cable connector	connector cable flylead connector
plastic	plastic	plastic	plastic
IP 67	IP 67	IP 67	IP 67
<b>198</b>	<b>200</b>	<b>202</b>	<b>204</b>

stainless steel sensors in washdown or hygienic design

product family	O300W.ER / O300W.TR	O300H.ER / O300H.TR	O500W.ER / O500W.TR	O500H.ER / O500H.TR	OR18W.EI / OR18W.TI
					
width / diameter	16,5 mm	16,5 mm	20,2 mm	20,2 mm	18 mm
actual range Sb	10 m	10 m	25 m	25 m	13 m
response time / release time	< 0,49 ms	< 0,49 ms	< 0,49 ms	< 0,49 ms	< 2 ms
light source	pulsed red LED	pulsed red LED	pulsed red LED	pulsed red LED	pulsed infrared diode
sensitivity adjustment	qTeach / remote	Teach-in: remote	qTeach / remote	Teach-in: remote	potentiometer, 270°
output circuit	push-pull	push-pull	push-pull	push-pull	NPN PNP
connection types	connector	cable flylead connector	connector	cable flylead connector	connector
housing material	metal	metal	metal	metal	metal
protection class	IP 68/69K & proTect+	IP 68/69K & proTect+	IP 68/69K & proTect+	IP 68/69K & proTect+	IP 67/69K
<b>page</b>	<b>224</b>	<b>226</b>	<b>228</b>	<b>230</b>	<b>232</b>





## General information

An emitter in a separate housing transmits the light to a separate receiver. The object is detected when it breaks the emitted beam.

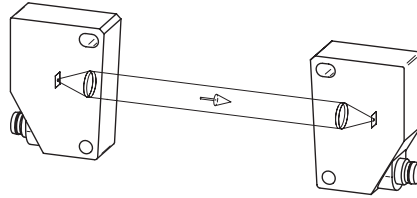

## Applications

- Detection of objects at a great distance – through beam sensors have the longest ranges.
- Monitoring of doors and entrances
- Due to the good repeatability throughout the entire range, positioning of objects
- Reliable detection of high-gloss objects such as mirrors, wafers or chrome-plated surfaces

## Characteristics and advantages

- Due to the separated configuration, long ranges with large signal excess gain can be achieved in comparison with equivalent retro-reflective systems. Through beam sensors are therefore most suitable for operation in unfavorable ambient conditions such as dirt, dust and moisture.
- The clearly defined, consistent active zone permits highly constant repeatability throughout the entire sensing distance.
- The switching point is independent of the surface properties of the object.





## Technology and operation

The active area (A) of a through beam sensor is equal to the diameter of the lens of the receiver or emitter. The acceptance zone (B) of the emitter and receiver is larger. However, this is only important for adjustment and for operation close to glossy surfaces. With focused through beam laser sensors, the active area is the diameter of the laser beam if this is smaller than the receiver lens or the front opening at the receiver end.

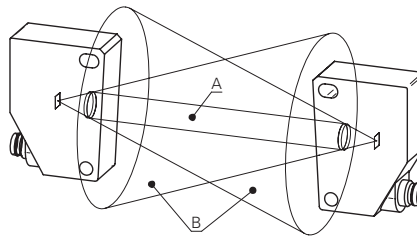

## Mounting and adjustment

The emitter and receiver must be aimed at each other. The narrower the angle of radiation and reception, the more accurately this must be conducted.

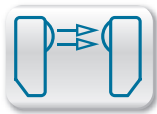

$S_b = 2\text{ m}$



- compact housing
- sensing range adjustable via Teach-in
- test input

#### general data

type	through beam sensor
actual range $S_b$	2 m
nominal range $S_n$	2,5 m

#### receiver

alignment / soiled lens indicator	flashing light indicator
light indicator	LED green
output indicator	LED yellow
sensitivity adjustment	Teach-in

#### emitter

light source	pulsed red LED
wave length	660 nm

#### electrical data

voltage supply range +Vs	10 ... 30 VDC
current consumption max. (no load)	20 mA
reverse polarity protection	yes

#### receiver

response time / release time	< 0,5 ms
current consumption typ.	20 mA
voltage drop Vd	< 1,8 VDC
output function	light / dark operate
output current	< 100 mA
short circuit protection	yes

#### emitter

current consumption typ.	12 mA
--------------------------	-------

#### mechanical data

width / diameter	8 mm
height / length	16,2 mm
depth	10,8 mm
type	rectangular
housing material	plastic (PMMA, MABS, PA)
front (optics)	PMMA

#### ambient conditions

operating temperature	-20 ... +50 °C
protection class	IP 65

#### connection diagrams

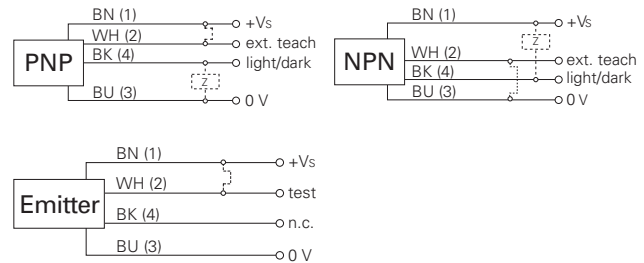

#### connectors and mating connectors

ESG 32AH0200 Connector M8, 4 pin, straight, 2 m

ESW 31AH0200 Connector M8, 4 pin, angular, 2 m

additional cable connectors and field wireable connectors: see accessories

#### Accessories

10150844 Minifix mounting 07

for details: see accessories section

order reference	emitter / receiver	connection types	output circuit
FECK 07N6901	receiver	cable rear side, 2 m	NPN
FECK 07N6901/KS35A	receiver	flylead connector M8 4 pin, L=200 mm	NPN
FECK 07P6901	receiver	cable rear side, 2 m	PNP
FECK 07P6901/KS35A	receiver	flylead connector M8 4 pin, L=200 mm	PNP
FSCK 07D9601	emitter	cable rear side, 2 m	-
FSCK 07D9601/KS35A	emitter	flylead connector M8 4 pin, L=200 mm	-

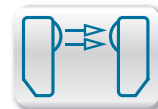

## excess gain curve

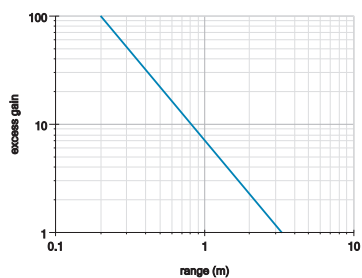

## dimension drawings

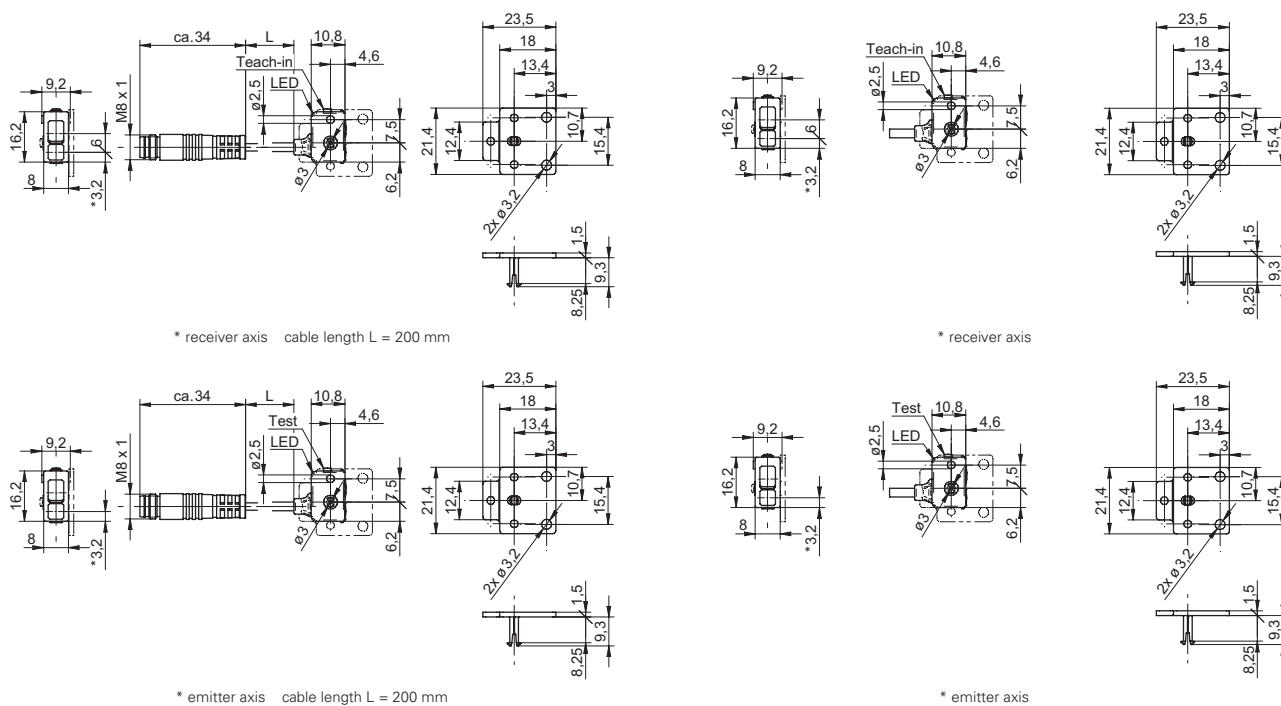

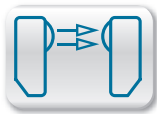
 $S_b = 2\text{ m}$ 

- compact housing
- sensitivity adjustment via Teach-in
- test input



#### general data

type	through beam sensor
actual range $S_b$	2 m
nominal range $S_n$	2,5 m

#### receiver

alignment / soiled lens indicator	flashing light indicator
light indicator	LED green
output indicator	LED yellow
sensitivity adjustment	Teach-in

#### emitter

light source	pulsed red LED
wave length	660 nm

#### electrical data

voltage supply range +Vs	10 ... 30 VDC
current consumption max. (no load)	20 mA
reverse polarity protection	yes

#### receiver

response time / release time	< 0,5 ms
current consumption typ.	20 mA
voltage drop Vd	< 1,8 VDC
output function	light / dark operate
output current	< 100 mA
short circuit protection	yes

#### emitter

current consumption typ.	12 mA
--------------------------	-------

#### mechanical data

width / diameter	8 mm
height / length	16,2 mm
depth	10,8 mm
type	rectangular
housing material	plastic (PMMA, MABS, PA)
front (optics)	PMMA

#### ambient conditions

operating temperature	-20 ... +50 °C
protection class	IP 65

#### connection diagrams

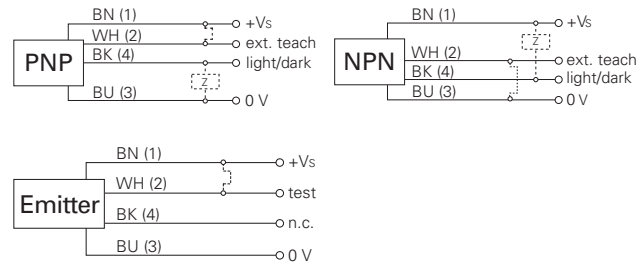

#### connectors and mating connectors

ESG 32AH0200 Connector M8, 4 pin, straight, 2 m

ESW 31AH0200 Connector M8, 4 pin, angular, 2 m

additional cable connectors and field wireable connectors: see accessories

#### Accessories

10150844 Minifix mounting 07

for details: see accessories section

order reference	emitter / receiver	connection types	output circuit
FEDK 07N6901	receiver	cable bottom side, 2 m	NPN
FEDK 07N6901/KS35A	receiver	flylead connector M8 4 pin, L=200 mm	NPN
FEDK 07P6901	receiver	cable bottom side, 2 m	PNP
FEDK 07P6901/KS35A	receiver	flylead connector M8 4 pin, L=200 mm	PNP
FSDK 07D9601	emitter	cable bottom side, 2 m	-
FSDK 07D9601/KS35A	emitter	flylead connector M8 4 pin, L=200 mm	-

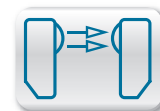

## excess gain curve

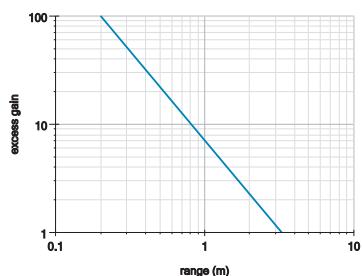

## dimension drawings

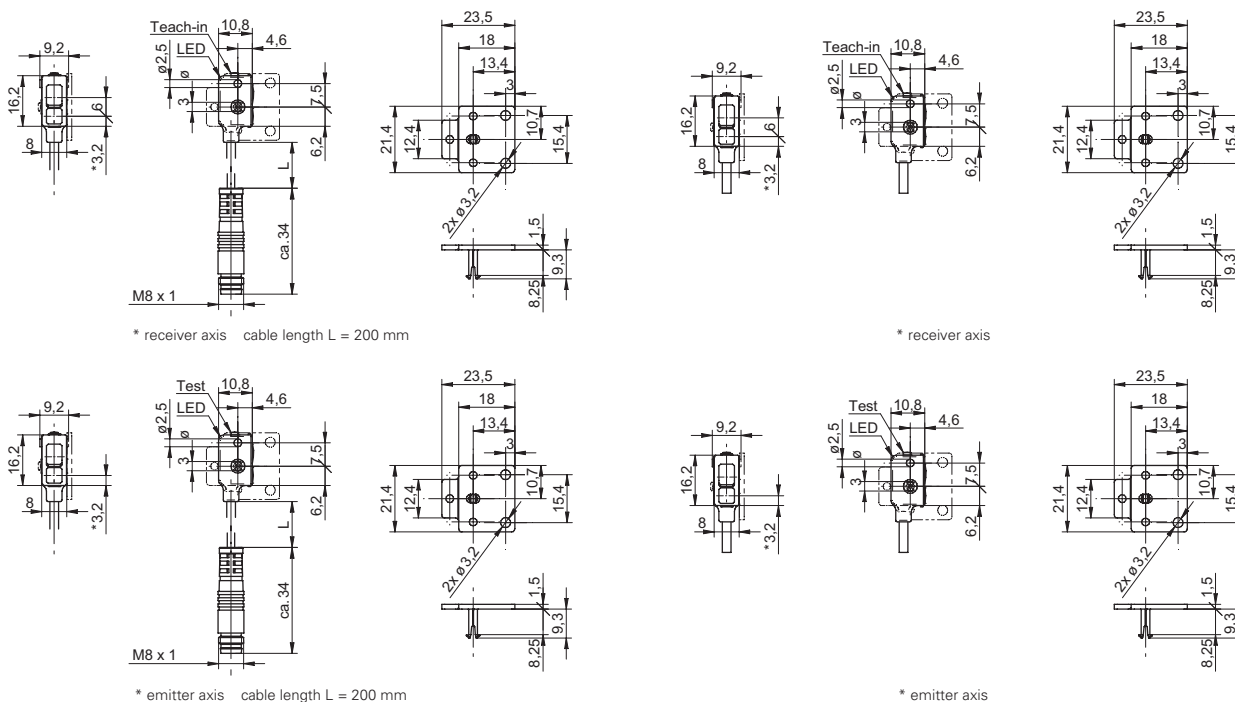

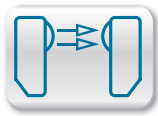

$S_b = 0,7 \text{ m}$

- subminiature metal housing
- small rectangular design



#### general data

type	through beam sensor
actual range $S_b$	0,7 m
nominal range $S_n$	1 m

#### receiver

alignment / soiled lens indicator	flashing light indicator
light indicator	LED red
sensitivity adjustment	no

#### emitter

light source	pulsed infrared diode
wave length	880 nm

#### electrical data

voltage supply range +Vs	10 ... 30 VDC
reverse polarity protection	yes

#### receiver

response time / release time	< 2,5 ms
current consumption max. (no load)	24 mA
current consumption typ.	24 mA
voltage drop Vd	< 2 VDC
output circuit	PNP
output current	< 100 mA
short circuit protection	yes

#### emitter

current consumption max. (no load)	48 mA
current consumption typ.	17 mA

#### mechanical data

width / diameter	8 mm
height / length	58 mm
depth	12 mm
type	rectangular
housing material	aluminum anodized
front (optics)	PC

#### ambient conditions

operating temperature	-25 ... +65 °C
protection class	IP 65

#### connection diagrams

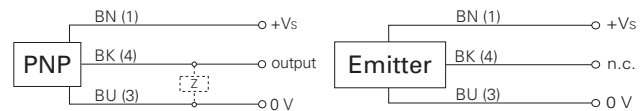

#### connectors and mating connectors

ESG 32SH0200 Connector M8, 3 pin, straight, 2 m

ESW 31SH0200 Connector M8, 3 pin, angular, 2 m

additional cable connectors and field wireable connectors: see accessories

order reference	emitter / receiver	connection types	output function
FEDM 08P1001	receiver	cable 3 pin, 2 m	light operate
FEDM 08P1001/S35L	receiver	connector M8, 3 pin	light operate
FEDM 08P3001	receiver	cable 3 pin, 2 m	dark operate
FEDM 08P3001/S35L	receiver	connector M8, 3 pin	dark operate
FSDM 08D9001	emitter	cable 3 pin, 2 m	-
FSDM 08D9001/S35	emitter	connector M8, 3 pin	-

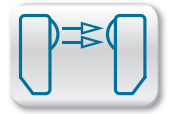

excess gain curve

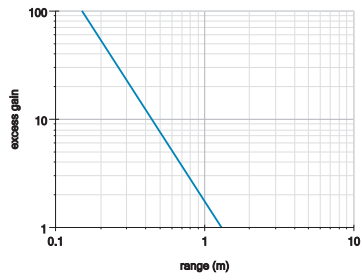

dimension drawings

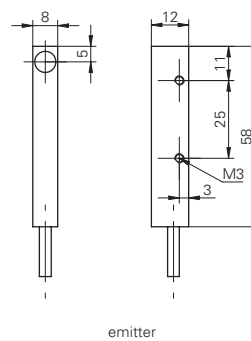
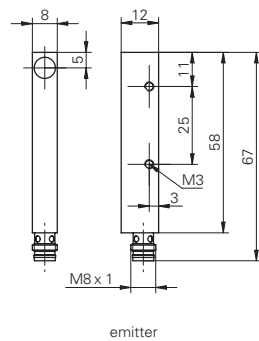
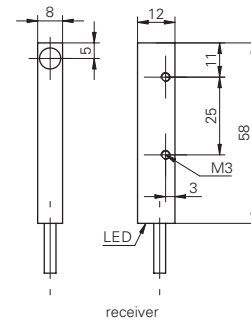
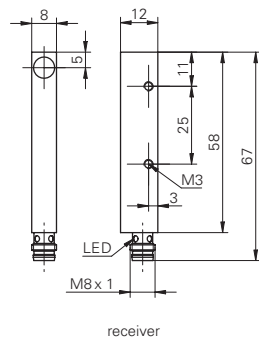

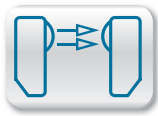

$S_b = 2,5 \text{ m}$

- subminiature metal housing
- small rectangular design



general data	
type	through beam sensor
actual range $S_b$	2,5 m
nominal range $S_n$	3 m

receiver	
alignment / soiled lens indicator	flashing light indicator
light indicator	LED red
sensitivity adjustment	no

emitter	
light source	pulsed infrared diode
wave length	880 nm

electrical data	
voltage supply range +Vs	10 ... 30 VDC
reverse polarity protection	yes

receiver	
response time / release time	< 2,5 ms
current consumption max. (no load)	24 mA
current consumption typ.	24 mA
voltage drop Vd	< 2 VDC
output circuit	PNP
output current	< 100 mA
short circuit protection	yes

emitter	
current consumption max. (no load)	48 mA
current consumption typ.	17 mA

mechanical data	
width / diameter	8 mm
height / length	58 mm
depth	15 mm
type	rectangular
housing material	aluminum anodized
front (optics)	PC

ambient conditions	
operating temperature	-25 ... +65 °C
protection class	IP 65

#### connection diagrams

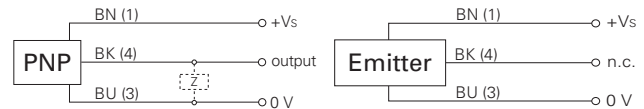

#### connectors and mating connectors

ESG 32SH0200 Connector M8, 3 pin, straight, 2 m

ESW 31SH0200 Connector M8, 3 pin, angular, 2 m

additional cable connectors and field wireable connectors: see accessories

order reference	emitter / receiver	connection types	output function
FEDM 08P1002	receiver	cable 3 pin, 2 m	light operate
FEDM 08P1002/S35L	receiver	connector M8, 3 pin	light operate
FEDM 08P3002	receiver	cable 3 pin, 2 m	dark operate
FEDM 08P3002/S35L	receiver	connector M8, 3 pin	dark operate
FSDM 08D9002	emitter	cable 3 pin, 2 m	-
FSDM 08D9002/S35	emitter	connector M8, 3 pin	-



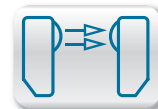

excess gain curve

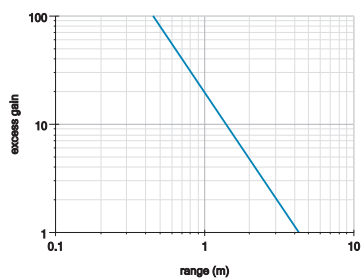

dimension drawings

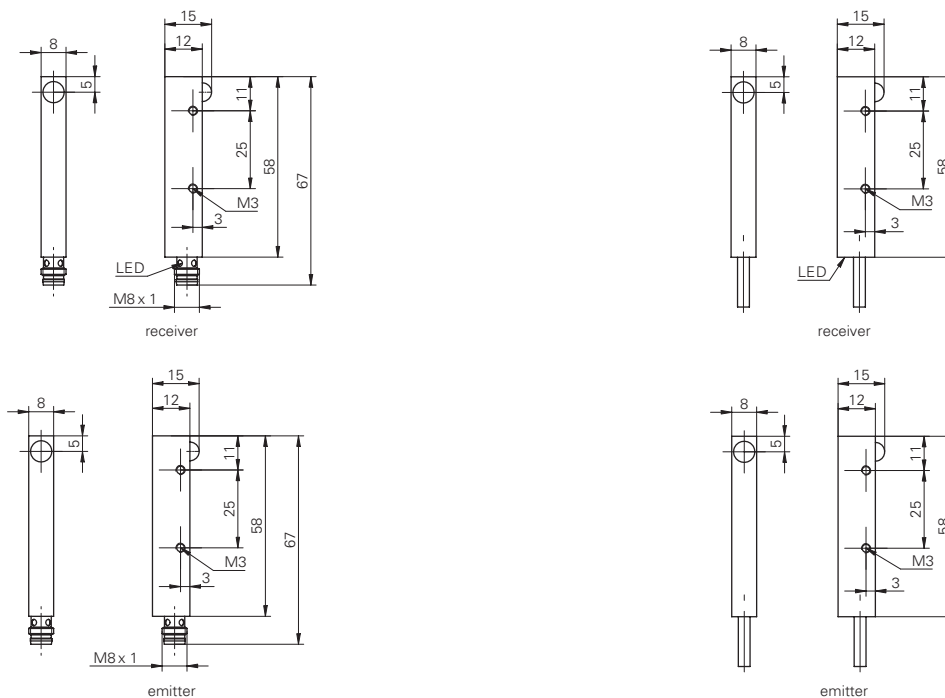

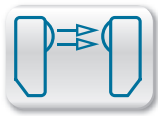

**S<sub>b</sub> = 2,5 m**

- subminiature metal housing
- cylindrical design

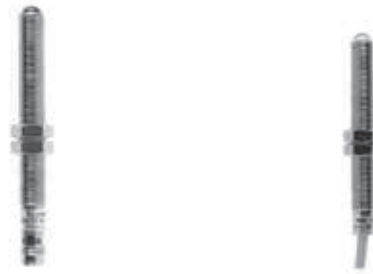

#### general data

type	through beam sensor
actual range S <sub>b</sub>	2,5 m
nominal range S <sub>n</sub>	3 m

#### receiver

alignment / soiled lens indicator	flashing light indicator
light indicator	LED red
sensitivity adjustment	no

#### emitter

light source	pulsed infrared diode
wave length	880 nm

#### electrical data

voltage supply range +Vs	10 ... 30 VDC
reverse polarity protection	yes

#### receiver

response time / release time	< 2,5 ms
current consumption max. (no load)	24 mA
current consumption typ.	24 mA
voltage drop V <sub>d</sub>	< 2 VDC
output circuit	PNP
output current	< 100 mA
short circuit protection	yes

#### emitter

current consumption max. (no load)	48 mA
current consumption typ.	17 mA

#### mechanical data

width / diameter	8 mm
type	cylindrical threaded
housing material	brass nickel plated
front (optics)	PC

#### ambient conditions

operating temperature	-25 ... +65 °C
protection class	IP 65

#### connection diagrams

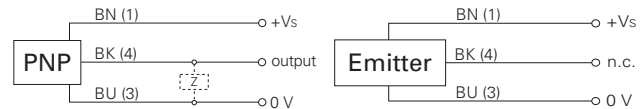

#### connectors and mating connectors

ESG 32SH0200 Connector M8, 3 pin, straight, 2 m

ESW 31SH0200 Connector M8, 3 pin, angular, 2 m

additional cable connectors and field wireable connectors: see accessories

#### Accessories

10151719 Sensofix series 08 round

for details: see accessories section

order reference	emitter / receiver	connection types	height / length	output function
FEAM 08P1002	receiver	cable 3 pin, 2 m	59 mm	light operate
FEAM 08P1002/S35L	receiver	connector M8, 3 pin	75,5 mm	light operate
FEAM 08P3002	receiver	cable 3 pin, 2 m	59 mm	dark operate
FEAM 08P3002/S35L	receiver	connector M8, 3 pin	75,5 mm	dark operate
FSAM 08D9002	emitter	cable 3 pin, 2 m	59 mm	-
FSAM 08D9002/S35	emitter	connector M8, 3 pin	75,5 mm	-

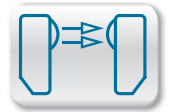

excess gain curve

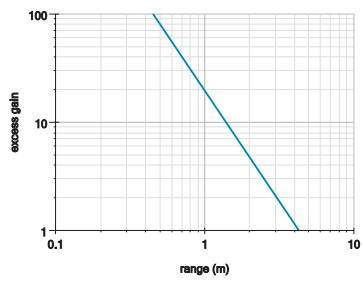

dimension drawings

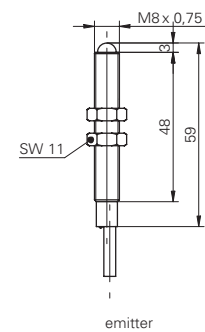
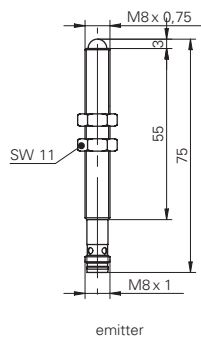
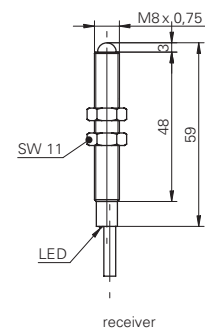
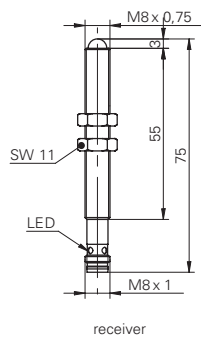

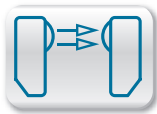

**S<sub>b</sub> = 5 m**

- compact housing
- sensitivity adjustment via potentiometer
- test input



#### general data

type	through beam sensor
actual range S <sub>b</sub>	5 m
nominal range S <sub>n</sub>	6 m

#### receiver

alignment / soiled lens indicator	flashing light indicator
light indicator	LED yellow
sensitivity adjustment	potentiometer, 270°

#### emitter

light source	pulsed red LED
wave length	660 nm

#### electrical data

voltage supply range +V <sub>s</sub>	10 ... 30 VDC
reverse polarity protection	yes

#### receiver

response time / release time	< 1,4 ms
current consumption max. (no load)	16 mA
current consumption typ.	16 mA
voltage drop V <sub>d</sub>	< 1,8 VDC
output current	< 100 mA
short circuit protection	yes

#### emitter

current consumption max. (no load)	23 mA
current consumption typ.	15 mA

#### mechanical data

width / diameter	10,4 mm
height / length	27 mm
depth	14 mm
type	rectangular
housing material	plastic (ASA)
front (optics)	PMMA

#### ambient conditions

operating temperature	-25 ... +65 °C
-----------------------	----------------

#### connection diagrams

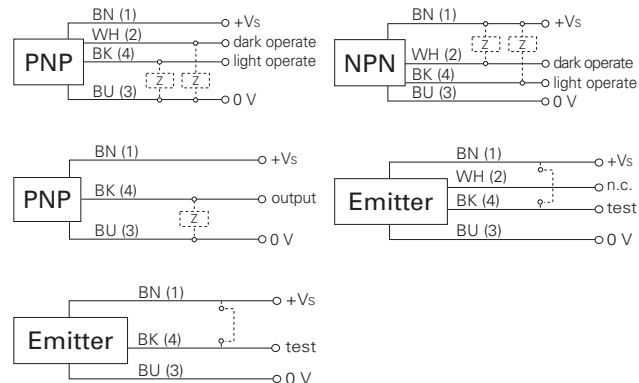

#### connectors and mating connectors

ESG 32AH0200	Connector M8, 4 pin, straight, 2 m
ESW 31AH0200	Connector M8, 4 pin, angular, 2 m
ESG 32SH0200	Connector M8, 3 pin, straight, 2 m
ESW 31SH0200	Connector M8, 3 pin, angular, 2 m

additional cable connectors and field wireable connectors: see accessories

#### Accessories

10150326	Sensofix series 10 / series 20
10114501	Mounting bracket series 10 (U design)
10133792	Mounting bracket series 10 (L design)

for details: see accessories section

order reference	emitter / receiver	connection types	output circuit	output function	protection class
FEDK 10N5101	receiver	cable 4 pin, 2 m	NPN	light / dark operate	IP 65
FEDK 10N5101/S35A	receiver	connector M8 4 pin	NPN	light / dark operate	IP 67
FEDK 10P1101/KS35	receiver	flylead connector M8 3 pin	PNP	light operate	IP 65
FEDK 10P3101/KS35	receiver	flylead connector M8 3 pin	PNP	dark operate	IP 65
FEDK 10P5101	receiver	cable 4 pin, 2 m	PNP	light / dark operate	IP 65
FEDK 10P5101/S35A	receiver	connector M8 4 pin	PNP	light / dark operate	IP 67
FSDK 10D9001/KS35	emitter	flylead connector M8 3 pin	-	-	IP 65
FSDK 10D9601	emitter	cable 4 pin, 2 m	-	-	IP 65
FSDK 10D9601/S35A	emitter	connector M8 4 pin	-	-	IP 67

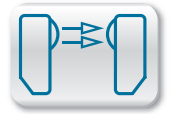

## excess gain curve

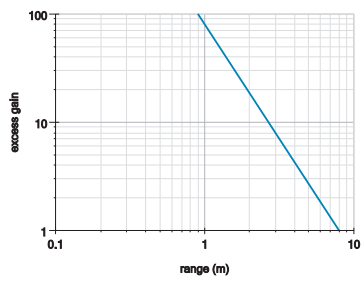

## dimension drawings

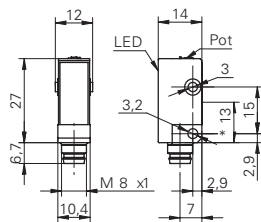

\* receiver axis

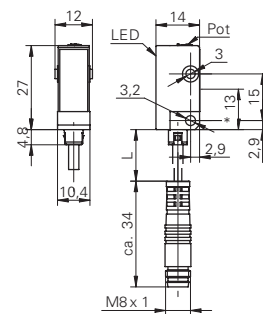

\* receiver axis cable length L = 200 mm

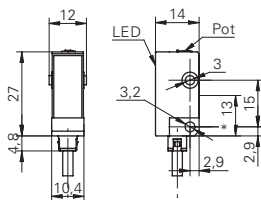

\* receiver axis

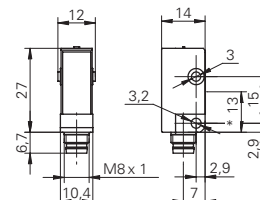

\* emitter axis

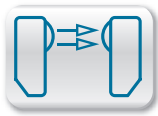

**S<sub>b</sub> = 6 m**

- rugged miniature metal housing
- test input



FSDM 12 / FEDM 12 S<sub>b</sub> = 6 m

general data	
type	through beam sensor
actual range S <sub>b</sub>	6 m
nominal range S <sub>n</sub>	7,5 m
receiver	
alignment / soiled lens indicator	flashing light indicator
light indicator	LED yellow
sensitivity adjustment	no
emitter	
light source	pulsed red LED
wave length	660 nm
electrical data	
voltage supply range +Vs	10 ... 30 VDC
reverse polarity protection	yes
receiver	
response time / release time	< 1 ms
current consumption max. (no load)	17 mA
current consumption typ.	17 mA
voltage drop V <sub>d</sub>	< 1,8 VDC
output function	light / dark operate
output circuit	PNP
output current	< 100 mA
short circuit protection	yes
emitter	
current consumption max. (no load)	30 mA
current consumption typ.	18 mA
mechanical data	
width / diameter	12,4 mm
height / length	35 mm
depth	35 mm
type	rectangular
housing material	die-cast zinc
front (optics)	PMMA
ambient conditions	
operating temperature	-25 ... +65 °C
protection class	IP 67

### connection diagrams

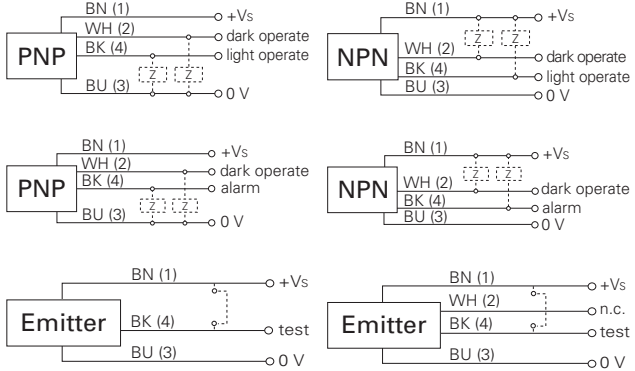

### connectors and mating connectors

ESG 32AH0200	Connector M8, 4 pin, straight, 2 m
ESW 31AH0200	Connector M8, 4 pin, angular, 2 m

additional cable connectors and field wireable connectors: see accessories

### Accessories

10150328	Sensofix series 12
10113873	Mounting bracket series 12 (L design)

for details: see accessories section

order reference	emitter / receiver	connection types
FEDM 12P5101	receiver	cable 4 pin, 2 m
FEDM 12P5101/S35A	receiver	connector M8 4 pin
FSDM 12D9601	emitter	cable 3 pin, 2 m
FSDM 12D9601/S35A	emitter	connector M8 4 pin

Through beam sensors

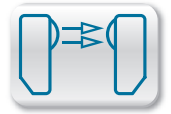

excess gain curve

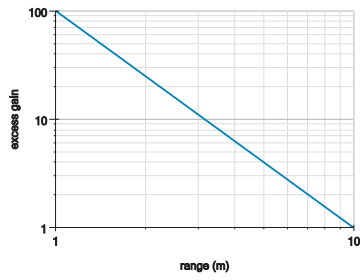

dimension drawings

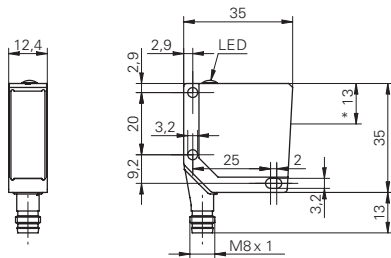

\* receiver axis

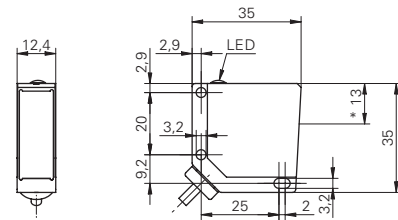

\* receiver axis

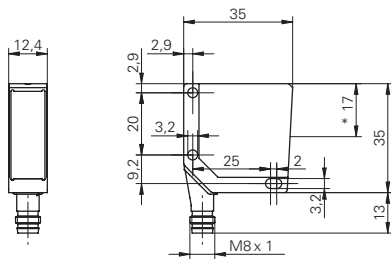

\* emitter axis

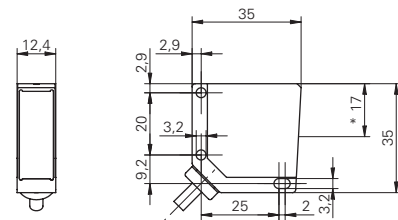

\* emitter axis

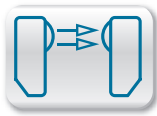
S<sub>b</sub> = 10 m

- One inch class
- sensitivity adjustment via Teach-in
- test input

**general data**

type	through beam sensor
actual range S <sub>b</sub>	10 m
nominal range S <sub>n</sub>	15 m
power on indication	LED green
alignment optical axis	< 2°

**receiver**

alignment / soiled lens indicator	flashing light indicator
light indicator	LED yellow

**emitter**

light source	pulsed red LED
wave length	645 nm

**electrical data**

voltage supply range +Vs	10 ... 30 VDC
current consumption max. (no load)	40 mA
current consumption typ.	30 mA
reverse polarity protection	yes

**receiver**

response time / release time	< 0,49 ms
voltage drop V <sub>d</sub>	< 3 VDC
output function	light / dark operate
output current	< 100 mA
short circuit protection	yes

**mechanical data**

width / diameter	12,9 mm
height / length	32,3 mm
depth	23 mm
type	rectangular
housing material	plastic (ASA, PMMA)
front (optics)	PMMA

**ambient conditions**

operating temperature	-25 ... +60 °C
protection class	IP 67

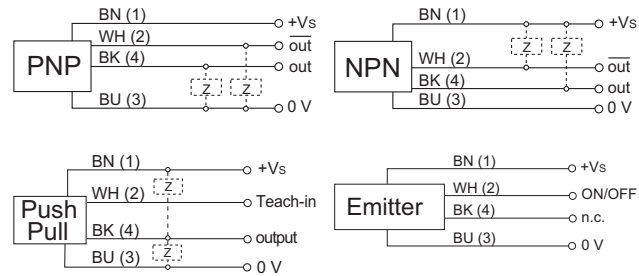
**connection diagrams****connectors and mating connectors**

ESG 32AH0200 Connector M8, 4 pin, straight, 2 m

ESW 31AH0200 Connector M8, 4 pin, angular, 2 m

additional cable connectors and field wireable connectors: see accessories

**Accessories**

11104963	Sensofix O300
11102423	Mounting bracket O300 (L design)
11124807	Mounting bracket O300 - Retrofit for sensors series 20

for details: see accessories section

order reference	emitter / receiver	connection types	output circuit	sensitivity adjustment
O300.ER-11167265	receiver	cable 4 pin, 2 m	push-pull	qTeach / remote
O300.ER-11128044	receiver	connector M8 4 pin	push-pull	qTeach / remote
O300.ER-11167266	receiver	cable 4 pin, 2 m	NPN complementary	qTeach
O300.ER-11128055	receiver	connector M8 4 pin	NPN complementary	qTeach
O300.ER-11167267	receiver	cable 4 pin, 2 m	PNP complementary	qTeach
O300.ER-11128047	receiver	connector M8 4 pin	PNP complementary	qTeach
O300.TR-11167264	emitter	cable 4 pin, 2 m	-	-
O300.TR-11128022	emitter	connector M8 4 pin	-	-



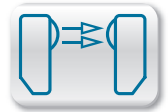

excess gain curve

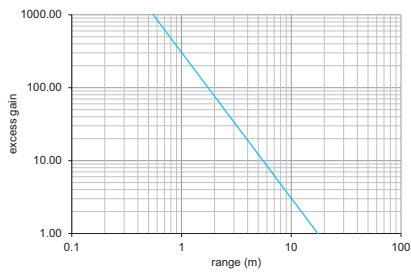

beam characteristic (typically)

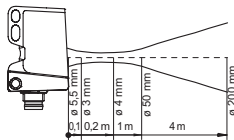

dimension drawings

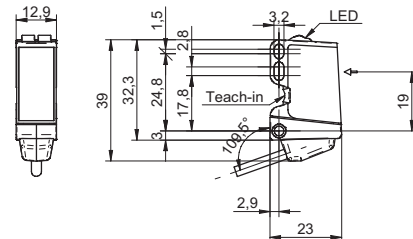
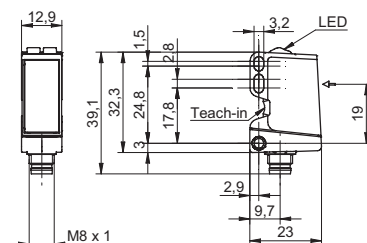
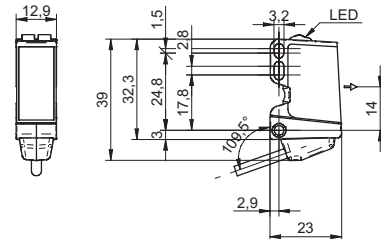
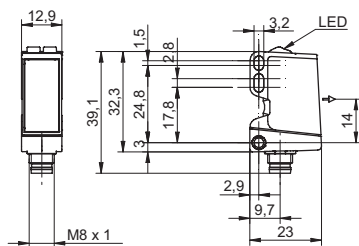

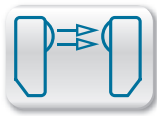

$S_b = 12\text{ m}$

- long range
- test input



#### general data

type	through beam sensor
actual range $S_b$	12 m
nominal range $S_n$	15 m

#### receiver

alignment / soiled lens indicator	flashing light indicator
light indicator	LED yellow
sensitivity adjustment	no

#### emitter

light source	pulsed red LED
wave length	660 nm

#### electrical data

voltage supply range +Vs	10 ... 30 VDC
current consumption max. (no load)	20 mA
reverse polarity protection	yes

#### receiver

response time / release time	< 1,2 ms
current consumption typ.	20 mA
voltage drop Vd	< 1,8 VDC
output function	light / dark operate
output current	< 100 mA
short circuit protection	yes

#### emitter

current consumption typ.	12 mA
--------------------------	-------

#### mechanical data

width / diameter	14,8 mm
height / length	43 mm
depth	31 mm
type	rectangular
housing material	plastic (ASA, MABS)
front (optics)	PMMA

#### ambient conditions

operating temperature	-25 ... +65 °C
protection class	IP 67

#### connection diagrams

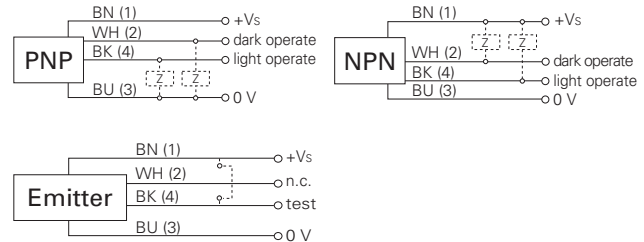

#### connectors and mating connectors

ESG 34AH0200	Connector M12, 4 pin, straight, 2 m
ESW 33AH0200	Connector M12, 4 pin, angular, 2 m
ESG 32AH0200	Connector M8, 4 pin, straight, 2 m
ESW 31AH0200	Connector M8, 4 pin, angular, 2 m

additional cable connectors and field wireable connectors: see accessories

#### Accessories

10149011	Sensofix series 14
10134964	Mounting bracket series 14 (L design)
10144075	Slot aperture stickers series 14

for details: see accessories section

order reference	emitter / receiver	connection types	output circuit
FEDK 14N5101	receiver	cable 4 pin, 2 m	NPN
FEDK 14N5101/S14	receiver	connector M12 4 pin	NPN
FEDK 14N5101/S35A	receiver	connector M8 4 pin	NPN
FEDK 14P5101	receiver	cable 4 pin, 2 m	PNP
FEDK 14P5101/S14	receiver	connector M12 4 pin	PNP
FEDK 14P5101/S35A	receiver	connector M8 4 pin	PNP
FSDK 14D9601	emitter	cable 4 pin, 2 m	-
FSDK 14D9601/S14	emitter	connector M12 4 pin	-
FSDK 14D9601/S35A	emitter	connector M8 4 pin	-

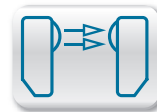

## excess gain curve

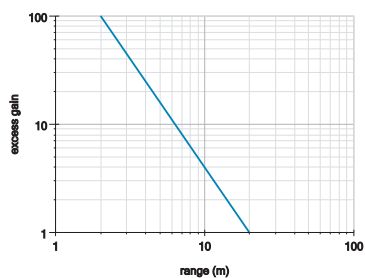

## dimension drawings

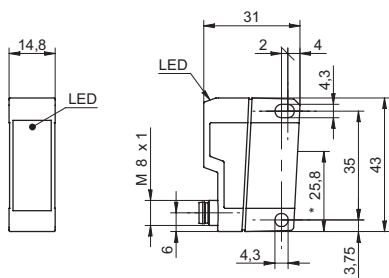

\* emitter and receiver axis

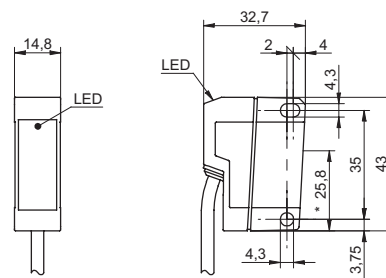

\* emitter and receiver axis

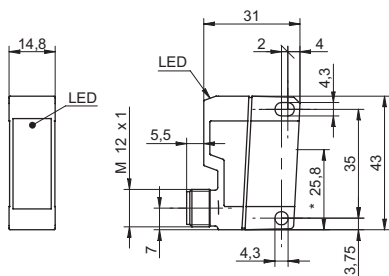

\* emitter and receiver axis

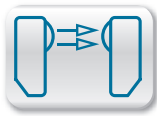
S<sub>b</sub> = 25 m

- long range
- sensitivity adjustment via Teach-in
- test input

**general data**

type	through beam sensor
actual range S <sub>b</sub>	25 m
nominal range S <sub>n</sub>	40 m
power on indication	LED green
alignment optical axis	< 1°

**receiver**

alignment / soiled lens indicator	flashing light indicator
light indicator	LED yellow

**emitter**

light source	pulsed red LED
wave length	645 nm

**electrical data**

response time / release time	< 0,49 ms
voltage supply range +Vs	10 ... 30 VDC
current consumption max. (no load)	40 mA
current consumption typ.	30 mA
reverse polarity protection	yes

**receiver**

voltage drop V <sub>d</sub>	< 3 VDC
output function	light / dark operate
output current	< 100 mA
short circuit protection	yes

**mechanical data**

width / diameter	18 mm
height / length	45 mm
depth	32 mm
type	rectangular
housing material	plastic (ASA, PMMA)
front (optics)	PMMA

**ambient conditions**

operating temperature	-25 ... +60 °C
protection class	IP 67

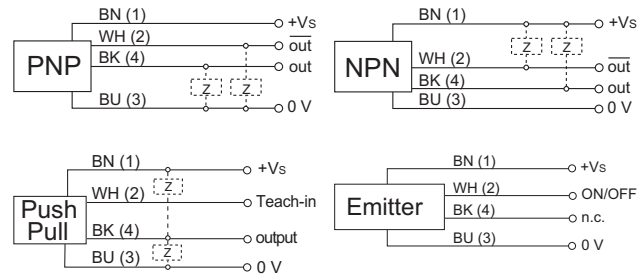
**connection diagrams****connectors and mating connectors**

ESG 34AH0200 Connector M12, 4 pin, straight, 2 m

ESW 33AH0200 Connector M12, 4 pin, angular, 2 m

additional cable connectors and field wireable connectors: see accessories

**Accessories**

11099942	Sensofix O500/U500
11092246	Mounting bracket O500/U500 (L design)
11111164	Mounting bracket O500/U500 - Retrofit for sensors series 30

for details: see accessories section

order reference	emitter / receiver	connection types	output circuit	sensitivity adjustment
O500.ER-11167280	receiver	cable 4 pin, 2 m	push-pull	qTeach / remote
O500.ER-11128072	receiver	connector M12 4 pin	push-pull	qTeach / remote
O500.ER-11167281	receiver	cable 4 pin, 2 m	NPN complementary	qTeach
O500.ER-11128078	receiver	connector M12 4 pin	NPN complementary	qTeach
O500.ER-11167282	receiver	cable 4 pin, 2 m	PNP complementary	qTeach
O500.ER-11128075	receiver	connector M12 4 pin	PNP complementary	qTeach
O500.TR-11167269	emitter	cable 4 pin, 2 m	-	-
O500.TR-11128041	emitter	connector M12 4 pin	-	-

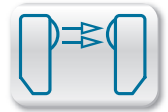

excess gain curve

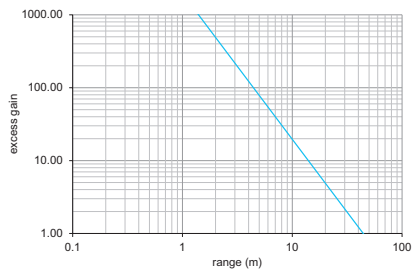

beam characteristic (typically)

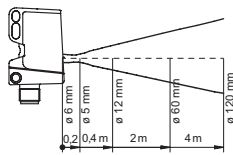

dimension drawings

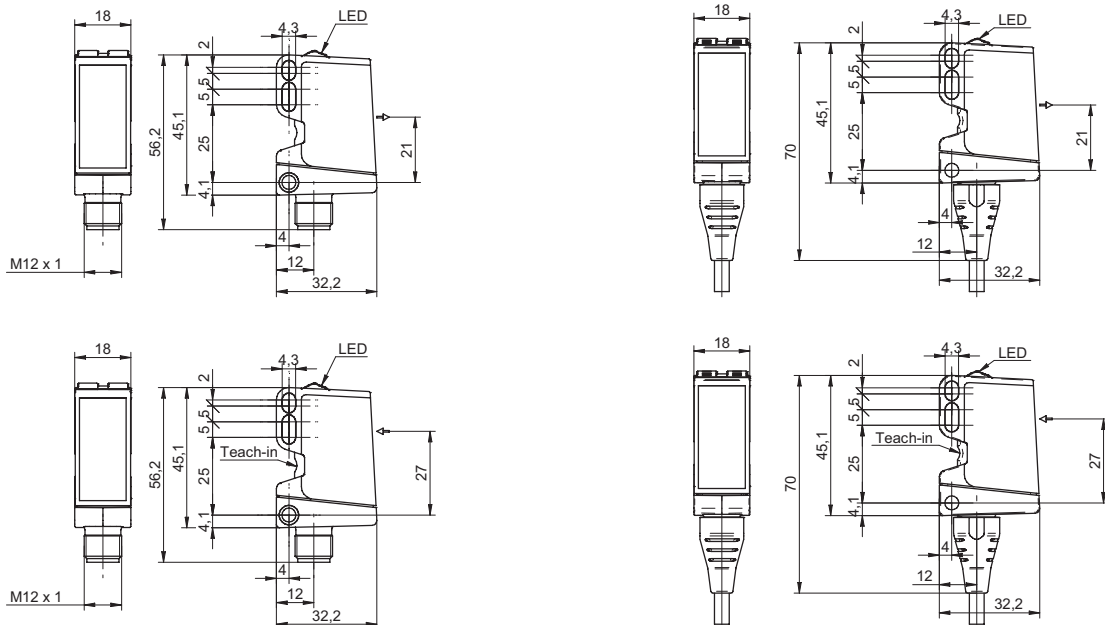

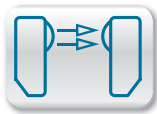

**S<sub>b</sub> = 13 m**



- sensitivity adjustment via potentiometer
- test input

### general data

type	through beam sensor
actual range S <sub>b</sub>	13 m
nominal range S <sub>n</sub>	20 m

### receiver

alignment / soiled lens indicator	LED green
output indicator	LED yellow

### emitter

light source	pulsed infrared diode
power on indication	LED green
wave length	880 nm

### electrical data

voltage supply range +V <sub>s</sub>	12 ... 30 VDC
current consumption max. (no load)	40 mA
current consumption typ.	30 mA
reverse polarity protection	yes

### receiver

response time / release time	< 2 ms
voltage drop V <sub>d</sub>	< 2 VDC
output function	light / dark operate
output current	< 100 mA
short circuit protection	yes

### mechanical data

width / diameter	18 mm
type	cylindrical threaded
housing material	plastic (ABS TERLURAN)
front (optics)	PMMA

### ambient conditions

operating temperature	-25 ... +55 °C
protection class	IP 67

### connection diagrams

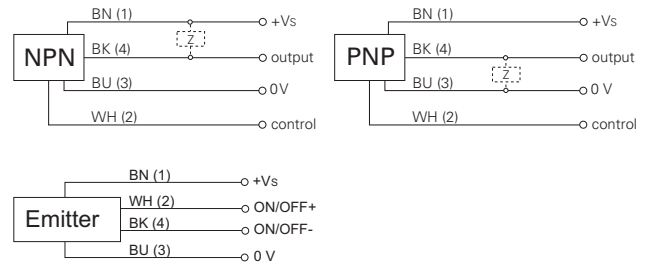

### connectors and mating connectors

ESG 34AH0200	Connector M12, 4 pin, straight, 2 m
ESW 33AH0200	Connector M12, 4 pin, angular, 2 m

additional cable connectors and field wireable connectors: see accessories

### Accessories

10151658	Sensofix series 18
ZADAP-M18.STANDARD	Mounting bracket series 18
ZADAP-M18.SHORT	Mounting bracket short series 18 (L design)
ZADAP-M18.LONG	Mounting bracket long series 18 (L design)
ZADAP-M18.SWING	Mounting bracket for adjustment for sensors series 18
ZADAP-M18.MICRO	Mounting bracket for adjustment for sensors series 18
ZPART-M18.NUT	Clamping nut for sensors Ø 18 mm

for details: see accessories section

order reference	emitter / receiver	connection types	height / length	output circuit	sensitivity adjustment	emission power adjustment
OR18.EI-11157814	receiver	connector M12 4 pin	67,2 mm	NPN	potentiometer, 270°	-
OR18.EI-11157815	receiver	cable 4 pin, 2 m	44,8 mm	NPN	no	-
OR18.EI-11157816	receiver	flylead connector M12 4 pin, L=100 mm	44,8 mm	NPN	no	-
OR18.EI-11157811	receiver	connector M12 4 pin	67,2 mm	PNP	potentiometer, 270°	-
OR18.EI-11157812	receiver	cable 4 pin, 2 m	44,8 mm	PNP	no	-
OR18.EI-11157813	receiver	flylead connector M12 4 pin, L=100 mm	44,8 mm	PNP	no	-
OR18.TI-11157821	emitter	connector M12 4 pin	67,2 mm	-	-	potentiometer, 270°
OR18.TI-11157823	emitter	cable 4 pin, 2 m	44,8 mm	-	-	no
OR18.TI-11157825	emitter	flylead connector M12 4 pin, L=100 mm	44,8 mm	-	-	no

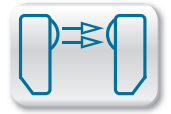

dimension drawings

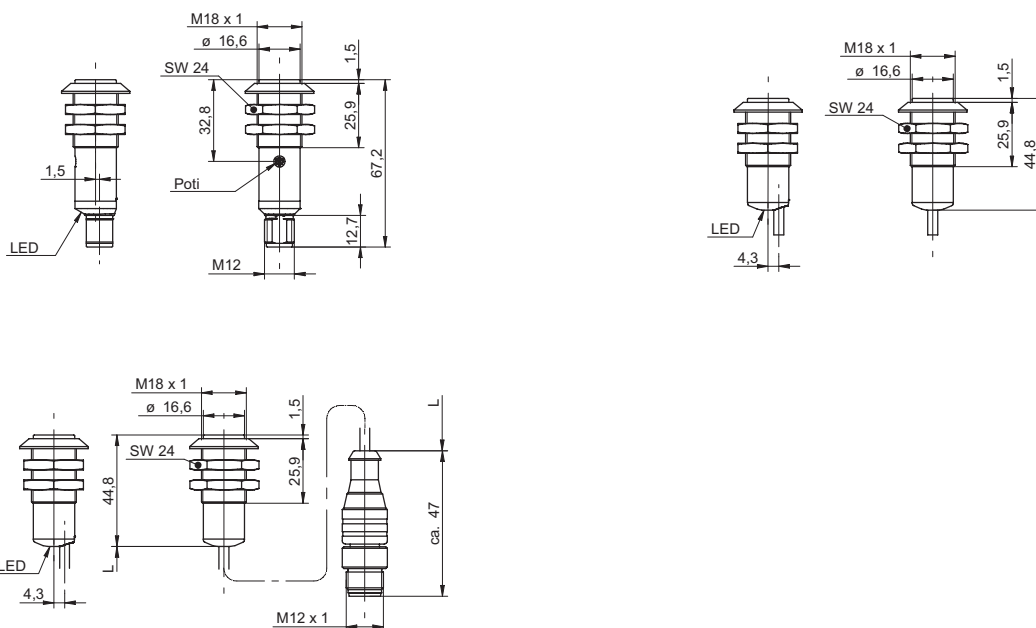

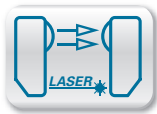
S<sub>b</sub> = 8 m

- long range
- short response time



general data	
type	through beam laser sensor
actual range S <sub>b</sub>	8 m
nominal range S <sub>n</sub>	10 m
receiver	
alignment / soiled lens indicator	flashing light indicator
light indicator	LED yellow
sensitivity adjustment	potentiometer, 270°
emitter	
light source	pulsed red laser diode
laser class	1
distance to focus	parallel beam
wave length	650 nm
electrical data	
voltage supply range +Vs	11 ... 30 VDC
reverse polarity protection	yes
receiver	
response time / release time	< 0,2 ms
current consumption max. (no load)	16 mA
current consumption typ.	16 mA
voltage drop V <sub>d</sub>	< 1,8 VDC
output function	light / dark operate
output current	< 100 mA
short circuit protection	yes
emitter	
current consumption max. (no load)	30 mA
current consumption typ.	25 mA
mechanical data	
width / diameter	10,4 mm
height / length	27 mm
type	rectangular
housing material	plastic (ASA)
front (optics)	PMMA
receiver	
depth	14 mm
emitter	
depth	16,3 mm
ambient conditions	
operating temperature	-10 ... +50 °C

## connection diagrams

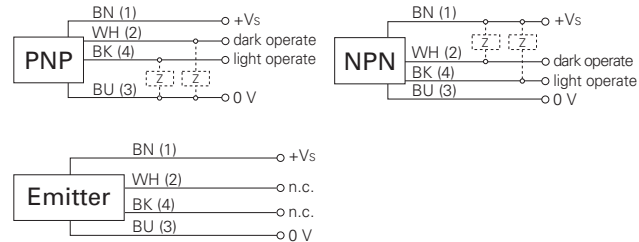

## connectors and mating connectors

ESG 32AH0200 Connector M8, 4 pin, straight, 2 m

ESW 31AH0200 Connector M8, 4 pin, angular, 2 m

additional cable connectors and field wireable connectors: see accessories

## Accessories

10150326 Sensofix series 10 / series 20

10114501 Mounting bracket series 10 (U design)

10133792 Mounting bracket series 10 (L design)

for details: see accessories section

## laser warning

**CLASS 1 LASER  
PRODUCT**

IEC 60825-1/2014  
Complies with 21 CFR 1040.10 and 1040.11  
except for deviations pursuant to laser  
notice No. 50, dated June 24, 2007

order reference	emitter / receiver	connection types	output circuit	protection class
OEDK 10N5105	receiver	cable 4 pin, 2 m	NPN	IP 65
OEDK 10N5105/S35A	receiver	connector M8 4 pin	NPN	IP 67
OEDK 10P5105	receiver	cable 4 pin, 2 m	PNP	IP 65
OEDK 10P5105/S35A	receiver	connector M8 4 pin	PNP	IP 67
OSDK 10D9005	emitter	cable 4 pin, 2 m	-	IP 65
OSDK 10D9005/S35A	emitter	connector M8 4 pin	-	IP 67



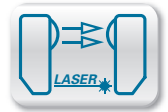

excess gain curve

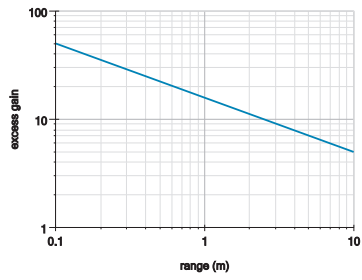

beam characteristic (typically)

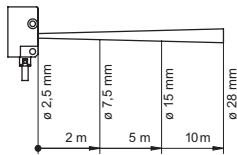

dimension drawings

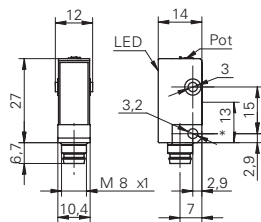

\* receiver axis

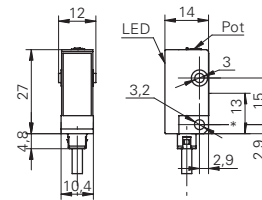

\* receiver axis

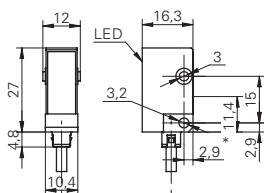

\* emitter axis

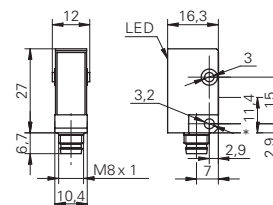

\* emitter axis

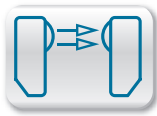
S<sub>b</sub> = 40 m

- One inch class
- long range
- short response time

**general data**

type	through beam sensor
actual range S <sub>b</sub>	40 m
nominal range S <sub>n</sub>	75 m
power on indication	LED green
alignment optical axis	< 2°

**receiver**

alignment / soiled lens indicator	flashing light indicator
light indicator	LED yellow

**emitter**

light source	pulsed red laser diode
laser class	1
distance to focus	parallel beam
wave length	656 nm

**electrical data**

reverse polarity protection	yes
-----------------------------	-----

**receiver**

response time / release time	< 0,49 ms
voltage supply range +Vs	10 ... 30 VDC
current consumption max. (no load)	40 mA
current consumption typ.	30 mA
voltage drop V <sub>d</sub>	< 3 VDC
output function	light / dark operate
output current	< 100 mA
short circuit protection	yes

**emitter**

voltage supply range +Vs	11 ... 30 VDC
current consumption max. (no load)	30 mA
current consumption typ.	25 mA

**mechanical data**

width / diameter	12,9 mm
height / length	32,3 mm
depth	23 mm
type	rectangular
housing material	plastic (ASA, PMMA)
front (optics)	PMMA

**ambient conditions**

protection class	IP 67
------------------	-------

**receiver**

operating temperature	-25 ... +60 °C
-----------------------	----------------

**emitter**

operating temperature	-10 ... +60 °C
-----------------------	----------------

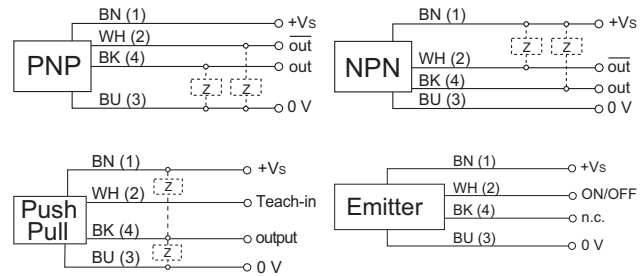
**connection diagrams****connectors and mating connectors**

ESG 32AH0200 Connector M8, 4 pin, straight, 2 m

ESW 31AH0200 Connector M8, 4 pin, angular, 2 m

additional cable connectors and field wireable connectors: see accessories

**Accessories**

11104963	Sensofix O300
11102423	Mounting bracket O300 (L design)
11124807	Mounting bracket O300 - Retrofit for sensors series 20

for details: see accessories section

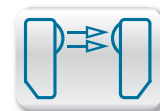

order reference	emitter / receiver	connection types	output circuit	sensitivity adjustment
O300.EL-11176842	receiver	cable 4 pin, 2 m	push-pull	qTeach / remote
O300.EL-11176843	receiver	connector M8 4 pin	push-pull	qTeach / remote
O300.EL-11181069	receiver	cable 4 pin, 2 m	NPN complementary	qTeach
O300.EL-11181080	receiver	connector M8 4 pin	NPN complementary	qTeach
O300.EL-11181081	receiver	cable 4 pin, 2 m	PNP complementary	qTeach
O300.EL-11181082	receiver	connector M8 4 pin	PNP complementary	qTeach
O300.TL-11176844	emitter	cable 4 pin, 2 m	-	-
O300.TL-11176845	emitter	connector M8 4 pin	-	-

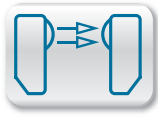

O300.EL / O300.TL Sb = 40 m

excess gain curve

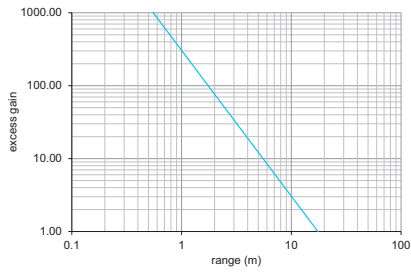

beam characteristic (typically)

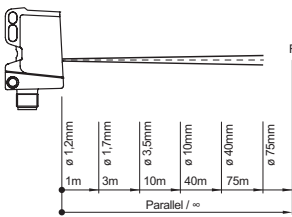

dimension drawings

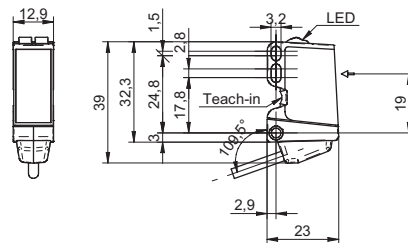
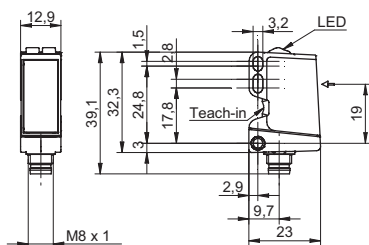
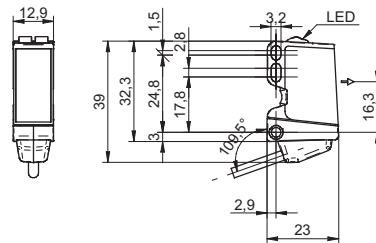
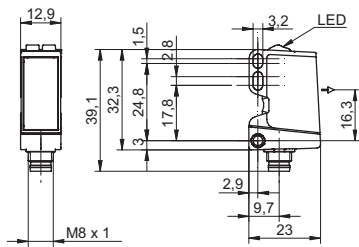

Through beam sensors

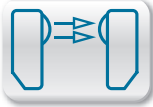

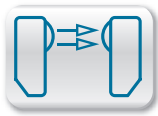
S<sub>b</sub> = 40 m

- washdown design
- long range
- short response time

**general data**

type	through beam sensor
special type	Washdown design
actual range S <sub>b</sub>	40 m
nominal range S <sub>n</sub>	75 m
power on indication	LED green
alignment optical axis	< 2°
approvals/certificates	Ecolab

**receiver**

alignment / soiled lens indicator	flashing light indicator
light indicator	LED yellow
sensitivity adjustment	qTeach / remote

**emitter**

light source	pulsed red laser diode
laser class	1
distance to focus	parallel beam
wave length	656 nm

**electrical data**

reverse polarity protection	yes
-----------------------------	-----

**receiver**

response time / release time	< 0,49 ms
voltage supply range +Vs	10 ... 30 VDC
current consumption max. (no load)	40 mA
current consumption typ.	30 mA
voltage drop V <sub>d</sub>	< 3 VDC
output function	light / dark operate
output circuit	push-pull
output current	< 100 mA
short circuit protection	yes

**emitter**

voltage supply range +Vs	11 ... 30 VDC
current consumption max. (no load)	30 mA
current consumption typ.	25 mA

**mechanical data**

width / diameter	16,5 mm
height / length	34,7 mm
depth	28,2 mm
type	rectangular
housing material	stainless steel 1.4404 (V4A)
front (optics)	PMMA
connection types	connector M8 4 pin

**ambient conditions**

protection class	IP 68/69K & proTect+
------------------	----------------------

**receiver**

operating temperature	-25 ... +60 °C
-----------------------	----------------

**emitter**

operating temperature	-10 ... +60 °C
-----------------------	----------------

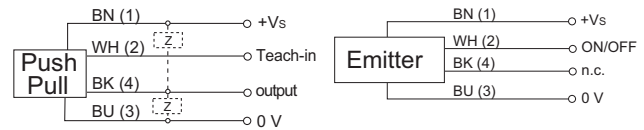
**connection diagrams****connectors and mating connectors**

ESG 32AY0200	Connector M8, 4 pin, straight, 2 m, V4A-PP
ESW 31AY0200	Connector M8, 4 pin, angular, 2 m, V4A-PP

additional cable connectors and field wireable connectors: see accessories

**Accessories**

11104963	Sensofix O300
11102423	Mounting bracket O300 (L design)
11124807	Mounting bracket O300 - Retrofit for sensors series 20

for details: see accessories section

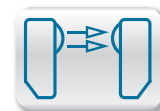

order reference	emitter / receiver
O300W.EL-11181085	receiver
O300W.TL-11181228	emitter

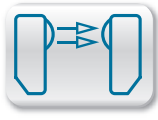

O300W.EL / O300W.TL Sb = 40 m

excess gain curve

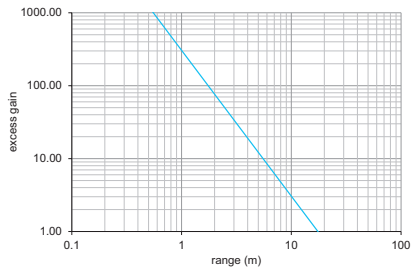

beam characteristic (typically)

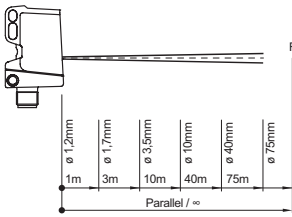

dimension drawings

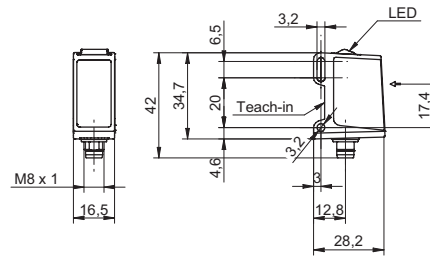
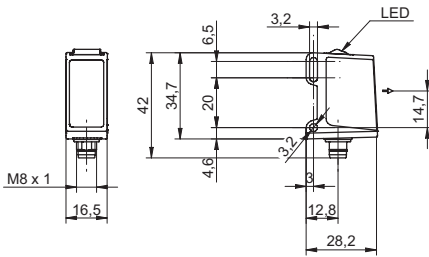



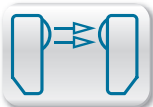

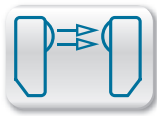

Sb = 40 m

- hygienic design
- long range
- short response time

**general data**

type	through beam sensor
special type	hygienic design
actual range Sb	40 m
nominal range Sn	75 m
power on indication	LED green
alignment optical axis	< 2°
approvals/certificates	Ecolab

**receiver**

alignment / soiled lens indicator	flashing light indicator
light indicator	LED yellow
sensitivity adjustment	Teach-in: remote

**emitter**

light source	pulsed red laser diode
laser class	1
distance to focus	parallel beam
wave length	656 nm

**electrical data**

reverse polarity protection	yes
-----------------------------	-----

**receiver**

response time / release time	< 0,49 ms
voltage supply range +Vs	10 ... 30 VDC
current consumption max. (no load)	40 mA
current consumption typ.	30 mA
voltage drop Vd	< 3 VDC
output function	light / dark operate
output circuit	push-pull
output current	< 100 mA
short circuit protection	yes

**emitter**

voltage supply range +Vs	11 ... 30 VDC
current consumption max. (no load)	30 mA
current consumption typ.	25 mA

**mechanical data**

width / diameter	16,5 mm
height / length	34,6 mm
depth	28,7 mm
type	rectangular
housing material	stainless steel 1.4404 (V4A)
front (optics)	PMMA

**ambient conditions**

protection class	IP 68/69K & proTect+
------------------	----------------------

**receiver**

operating temperature	-25 ... +60 °C
-----------------------	----------------

**emitter**

operating temperature	-10 ... +60 °C
-----------------------	----------------

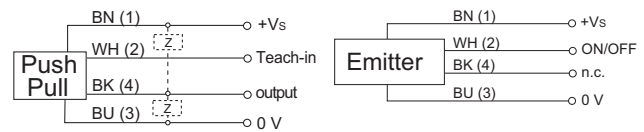
**connection diagrams****connectors and mating connectors**

ESG 32AY0200	Connector M8, 4 pin, straight, 2 m, V4A-PP
ESW 31AY0200	Connector M8, 4 pin, angular, 2 m, V4A-PP

additional cable connectors and field wireable connectors: see accessories

**Accessories**

HI11-1H	Mounting for sensors in hygienic design Ø 11 mm
11137318	Teach Pen for sensors in metal housing
11141124	Teach Pen for sensors in metal housing (USA, CAN, JP)

for details: see accessories section

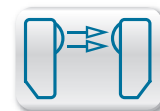

order reference	emitter / receiver	connection types
O300H.EL-11181083	receiver	cable 4 pin, 2 m
O300H.EL-11181084	receiver	flylead connector M8, L=200 mm
O300H.TL-11181225	emitter	cable 4 pin, 2 m
O300H.TL-11181227	emitter	flylead connector M8, L=200 mm

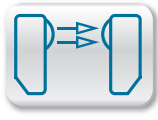

excess gain curve

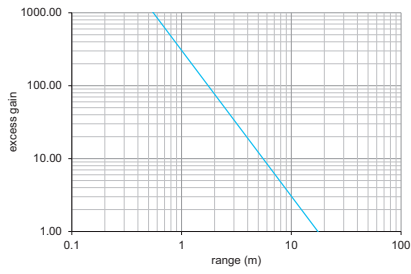

beam characteristic (typically)

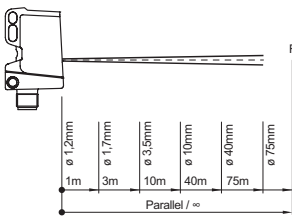

dimension drawings

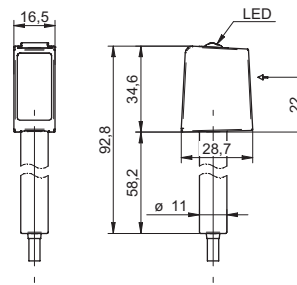
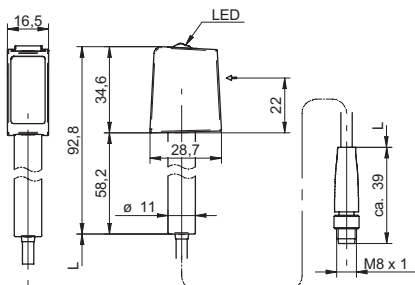
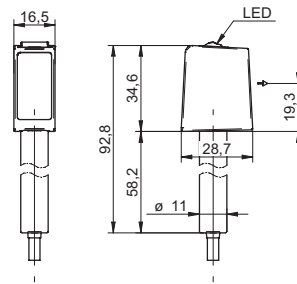
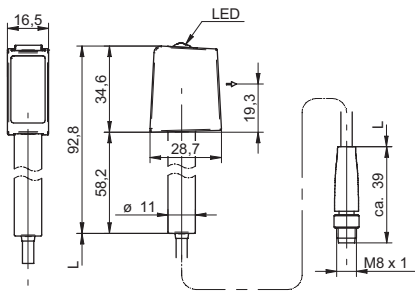

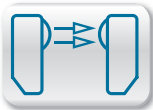

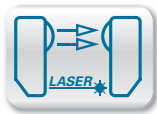
S<sub>b</sub> = 8 m

- long range
- short response time

**general data**

type	through beam laser sensor
actual range S <sub>b</sub>	8 m
nominal range S <sub>n</sub>	10 m

**receiver**

alignment / soiled lens indicator	flashing light indicator
light indicator	LED yellow
sensitivity adjustment	no

**emitter**

light source	pulsed red laser diode
power on indication	LED green
laser class	1
distance to focus	parallel beam
wave length	650 nm

**electrical data**

voltage supply range +V <sub>s</sub>	10 ... 30 VDC
reverse polarity protection	yes

**receiver**

response time / release time	< 0,5 ms
current consumption max. (no load)	20 mA
current consumption typ.	20 mA
voltage drop V <sub>d</sub>	< 1,8 VDC
output function	light / dark operate
output circuit	PNP
output current	< 100 mA
short circuit protection	yes

**emitter**

current consumption max. (no load)	35 mA
current consumption typ.	25 mA

**mechanical data**

width / diameter	14,8 mm
height / length	43 mm
depth	31 mm
type	rectangular
housing material	plastic (ASA, MABS)
front (optics)	PMMA

**ambient conditions**

protection class	IP 67
------------------	-------

**receiver**

operating temperature	-25 ... +65 °C
-----------------------	----------------

**emitter**

operating temperature	10 ... +50 °C
-----------------------	---------------

**order reference emitter / receiver connection types**

order reference	emitter / receiver	connection types
OEDK 14P5101	receiver	cable 4 pin, 2 m
OEDK 14P5101/S14	receiver	connector M12 4 pin
OEDK 14P5101/S35A	receiver	connector M8 4 pin
OSDK 14D9001	emitter	cable 4 pin, 2 m
OSDK 14D9001/S14	emitter	connector M12 4 pin
OSDK 14D9001/S35A	emitter	connector M8 4 pin

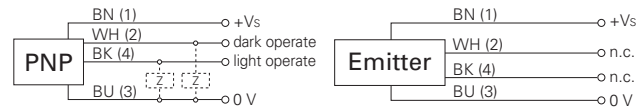
**connection diagrams****connectors and mating connectors**

ESG 34AH0200	Connector M12, 4 pin, straight, 2 m
ESW 33AH0200	Connector M12, 4 pin, angular, 2 m
ESG 32AH0200	Connector M8, 4 pin, straight, 2 m
ESW 31AH0200	Connector M8, 4 pin, angular, 2 m

additional cable connectors and field wireable connectors: see accessories

**Accessories**

10149011	Sensofix series 14
10134964	Mounting bracket series 14 (L design)

for details: see accessories section

**laser warning**

**CLASS 1 LASER  
PRODUCT**

IEC 60825-1/2014  
Complies with 21 CFR 1040.10 and 1040.11  
except for deviations pursuant to laser  
notice No. 50, dated June 24, 2007

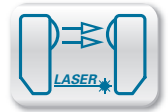

### excess gain curve

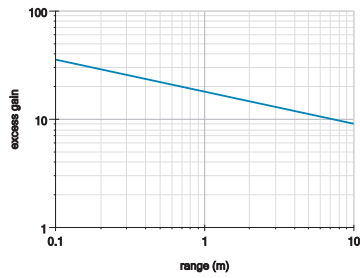

### beam characteristic (typically)

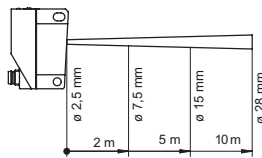

### dimension drawings

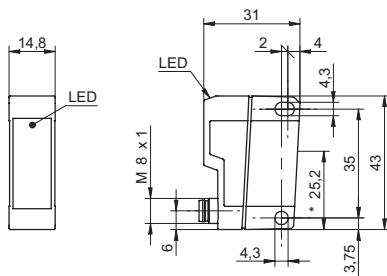

\* emitter and receiver axis

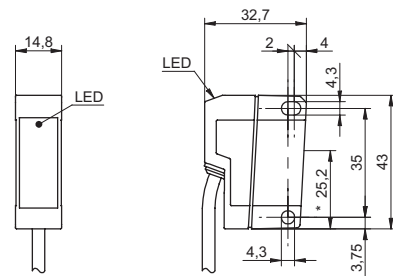

\* emitter and receiver axis

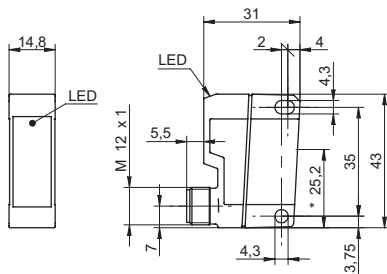

\* emitter and receiver axis

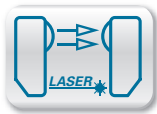
S<sub>b</sub> = 55 m

- long range
- short response time
- test input

**general data**

type	through beam sensor
actual range S <sub>b</sub>	55 m
nominal range S <sub>n</sub>	60 m
power on indication	LED green

**receiver**

output indicator	LED yellow
sensitivity adjustment	potentiometer, 270°

**emitter**

light source	pulsed red laser diode
emission power adjustment	no
laser class	1
distance to focus	parallel beam
wave length	630 nm

**electrical data**

voltage supply range +Vs	10 ... 30 VDC
current consumption max. (no load)	45 mA
current consumption typ.	35 mA
reverse polarity protection	yes

**receiver**

response time / release time	< 0,34 ms
voltage drop V <sub>d</sub>	< 2 VDC
output function	light / dark operate
output current	< 100 mA
short circuit protection	yes

**mechanical data**

width / diameter	18 mm
type	cylindrical threaded
housing material	brass nickel plated
front (optics)	PMMA

**ambient conditions**

operating temperature	-10 ... +55 °C
protection class	IP 67

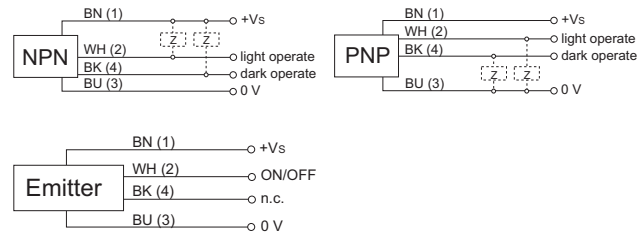
**connection diagrams****connectors and mating connectors**

ESG 34AH0200	Connector M12, 4 pin, straight, 2 m
ESW 33AH0200	Connector M12, 4 pin, angular, 2 m

additional cable connectors and field wireable connectors: see accessories

**Accessories**

10151658	Sensofix series 18
ZADAP-M18.STANDARD	Mounting bracket series 18
ZADAP-M18.SHORT	Mounting bracket short series 18 (L design)
ZADAP-M18.LONG	Mounting bracket long series 18 (L design)
ZADAP-M18.SWING	Mounting bracket for adjustment for sensors series 18
ZADAP-M18.MICRO	Mounting bracket for adjustment for sensors series 18

for details: see accessories section

**laser warning**

**CLASS 1 LASER  
PRODUCT**

IEC 60825-1/2014  
Complies with 21 CFR 1040.10 and 1040.11  
except for deviations pursuant to laser  
notice No. 50, dated June 24, 2007

order reference	emitter / receiver	connection types	height / length	output circuit
OR18.EL-11157820	receiver	cable 4 pin, 2 m	77 mm	NPN complementary
OR18.EL-11157819	receiver	connector M12 4 pin	81,5 mm	NPN complementary
OR18.EL-11157818	receiver	cable 4 pin, 2 m	77 mm	PNP complementary
OR18.EL-11157817	receiver	connector M12 4 pin	81,5 mm	PNP complementary
OR18.TL-11157840	emitter	cable 4 pin, 2 m	67 mm	-
OR18.TL-11157829	emitter	connector M12 4 pin	71,5 mm	-



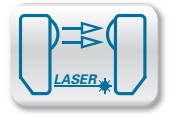

dimension drawings

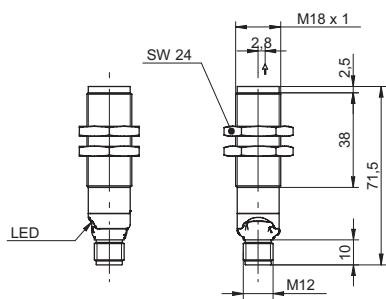

emitter

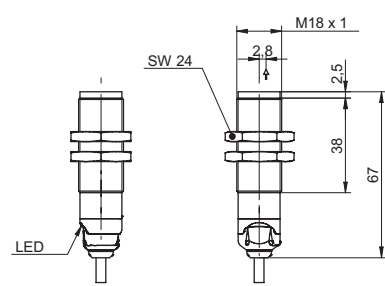

emitter

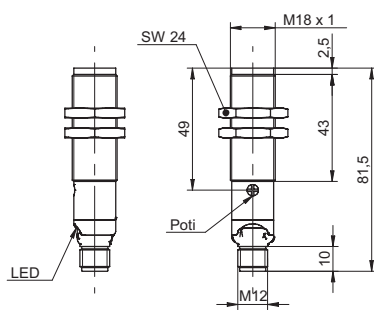

receiver

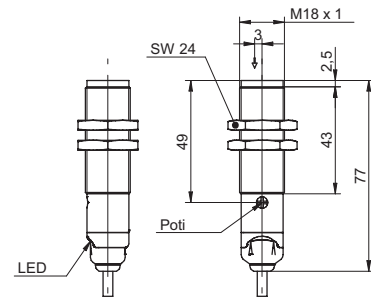

receiver

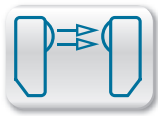
S<sub>b</sub> = 10 m

- washdown design
- short response time
- test input

**general data**

type	through beam sensor
special type	Washdown design
actual range S <sub>b</sub>	10 m
nominal range S <sub>n</sub>	15 m
power on indication	LED green
alignment optical axis	< 2°
approvals/certificates	Ecolab

**receiver**

alignment / soiled lens indicator	flashing light indicator
light indicator	LED yellow
sensitivity adjustment	qTeach / remote

**emitter**

light source	pulsed red LED
wave length	645 nm

**electrical data**

voltage supply range +Vs	10 ... 30 VDC
current consumption max. (no load)	40 mA
current consumption typ.	30 mA
reverse polarity protection	yes

**receiver**

response time / release time	< 0,49 ms
voltage drop V <sub>d</sub>	< 3 VDC
output function	light / dark operate
output circuit	push-pull
output current	< 100 mA
short circuit protection	yes

**mechanical data**

width / diameter	16,5 mm
height / length	34,7 mm
depth	28,2 mm
type	rectangular
housing material	stainless steel 1.4404 (V4A)
front (optics)	PMMA
connection types	connector M8 4 pin

**ambient conditions**

operating temperature	-25 ... +60 °C
protection class	IP 68/69K & proTect+

**order reference**

order reference	emitter / receiver
O300W.ER-11167301	receiver
O300W.TR-11167300	emitter

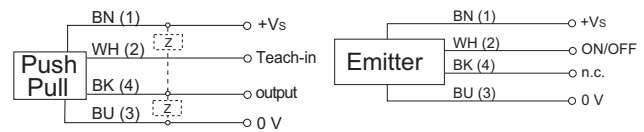
**connection diagrams****connectors and mating connectors**

ESG 32AY0200	Connector M8, 4 pin, straight, 2 m, V4A-PP
ESW 31AY0200	Connector M8, 4 pin, angular, 2 m, V4A-PP

additional cable connectors and field wireable connectors: see accessories

**Accessories**

11104963	Sensofix O300
11102423	Mounting bracket O300 (L design)
11124807	Mounting bracket O300 - Retrofit for sensors series 20

for details: see accessories section

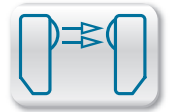

excess gain curve

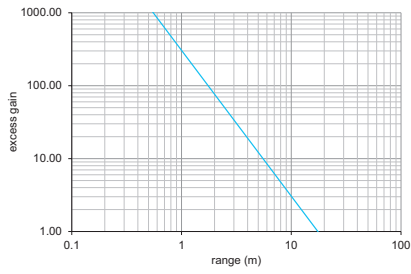

beam characteristic (typically)

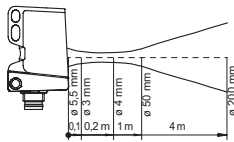

dimension drawings

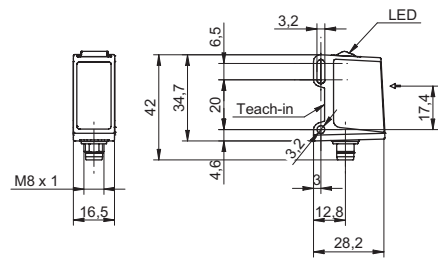
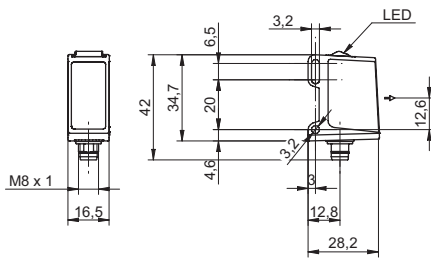

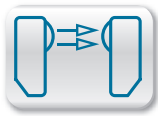
S<sub>b</sub> = 10 m

- hygienic design
- short response time
- test input

**general data**

type	through beam sensor
special type	hygienic design
actual range S <sub>b</sub>	10 m
nominal range S <sub>n</sub>	15 m
power on indication	LED green
alignment optical axis	< 2°
approvals/certificates	Ecolab

**receiver**

alignment / soiled lens indicator	flashing light indicator
light indicator	LED yellow
sensitivity adjustment	Teach-in: remote

**emitter**

light source	pulsed red LED
wave length	645 nm

**electrical data**

voltage supply range +Vs	10 ... 30 VDC
current consumption max. (no load)	40 mA
current consumption typ.	30 mA
reverse polarity protection	yes

**receiver**

response time / release time	< 0,49 ms
voltage drop V <sub>d</sub>	< 3 VDC
output function	light / dark operate
output circuit	push-pull
output current	< 100 mA
short circuit protection	yes

**mechanical data**

width / diameter	16,5 mm
height / length	34,6 mm
depth	28,7 mm
type	rectangular
housing material	stainless steel 1.4404 (V4A)
front (optics)	PMMA

**ambient conditions**

operating temperature	-25 ... +60 °C
protection class	IP 68/69K & proTect+

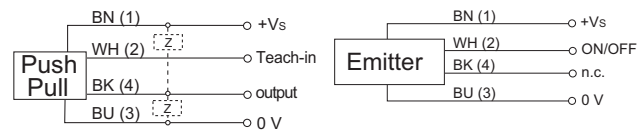
**connection diagrams****connectors and mating connectors**

ESG 32AY0200	Connector M8, 4 pin, straight, 2 m, V4A-PP
ESW 31AY0200	Connector M8, 4 pin, angular, 2 m, V4A-PP

additional cable connectors and field wireable connectors: see accessories

**Accessories**

HI11-1H	Mounting for sensors in hygienic design Ø 11 mm
11137318	Teach Pen for sensors in metal housing
11141124	Teach Pen for sensors in metal housing (USA, CAN, JP)

for details: see accessories section

order reference	emitter / receiver	connection types
O300H.ER-11167293	receiver	cable 4 pin, 2 m
O300H.ER-11167294	receiver	flylead connector M8, L=200 mm
O300H.TR-11167291	emitter	cable 4 pin, 2 m
O300H.TR-11167292	emitter	flylead connector M8, L=200 mm

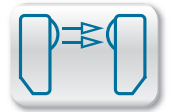

excess gain curve

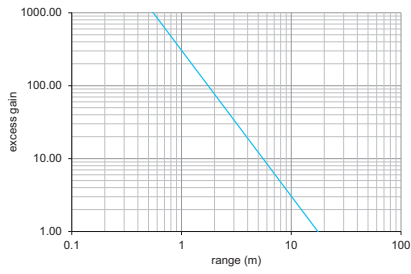

beam characteristic (typically)

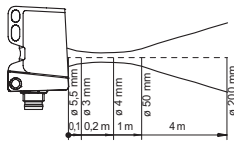

dimension drawings

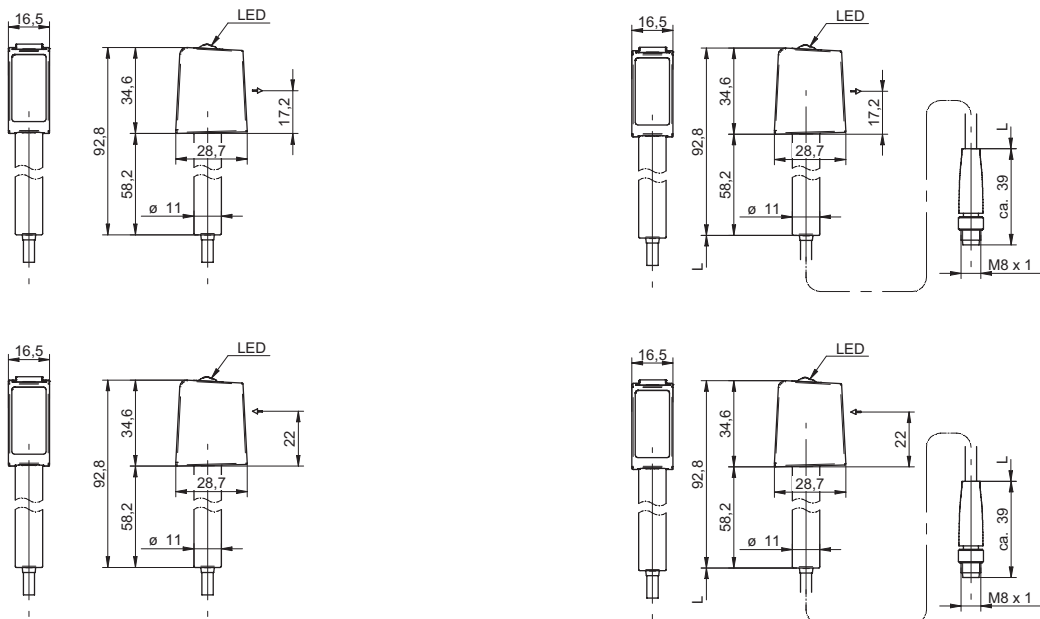

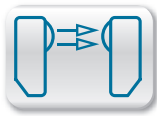
S<sub>b</sub> = 25 m

- washdown design
- long range
- short response time

**general data**

type	through beam sensor
special type	Washdown design
actual range S <sub>b</sub>	25 m
nominal range S <sub>n</sub>	40 m
power on indication	LED green
alignment optical axis	< 1°
approvals/certificates	Ecolab

**receiver**

alignment / soiled lens indicator	flashing light indicator
light indicator	LED yellow
sensitivity adjustment	qTeach / remote

**emitter**

light source	pulsed red LED
wave length	645 nm

**electrical data**

response time / release time	< 0,49 ms
voltage supply range +Vs	10 ... 30 VDC
current consumption max. (no load)	40 mA
current consumption typ.	30 mA
reverse polarity protection	yes

**receiver**

voltage drop V <sub>d</sub>	< 3 VDC
output function	light / dark operate
output circuit	push-pull
output current	< 100 mA
short circuit protection	yes

**mechanical data**

width / diameter	20,2 mm
height / length	47,2 mm
depth	37,7 mm
type	rectangular
housing material	stainless steel 1.4404 (V4A)
front (optics)	PMMA
connection types	connector M12 4 pin

**ambient conditions**

operating temperature	-25 ... +60 °C
protection class	IP 68/69K & proTect+

**order reference**

order reference	emitter / receiver
O500W.ER-11167303	receiver
O500W.TR-11167302	emitter

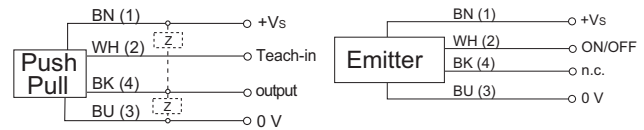
**connection diagrams****connectors and mating connectors**

ESG 34AY0200	Connector M12, 4 pin, straight, 2 m, V4A-PP
ESW 33AY0200	Connector M12, 4 pin, angular, 2 m, V4A-PP

additional cable connectors and field wireable connectors: see accessories

**Accessories**

11099942	Sensofix O500/U500
11092246	Mounting bracket O500/U500 (L design)
11111164	Mounting bracket O500/U500 - Retrofit for sensors series 30

for details: see accessories section

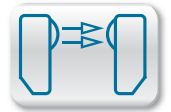

excess gain curve

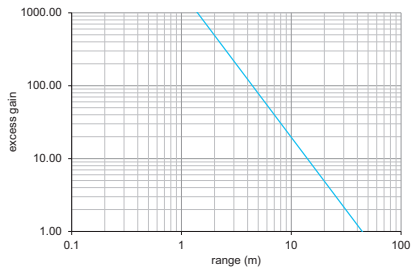

beam characteristic (typically)

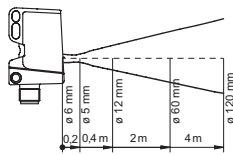

dimension drawings

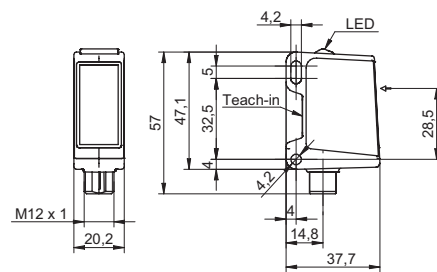
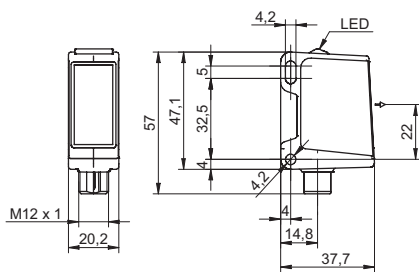

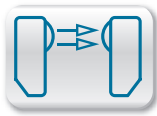
S<sub>b</sub> = 25 m

- hygienic design
- long range
- short response time

**general data**

type	through beam sensor
special type	hygienic design
actual range S <sub>b</sub>	25 m
nominal range S <sub>n</sub>	40 m
power on indication	LED green
alignment optical axis	< 1°
approvals/certificates	Ecolab

**receiver**

alignment / soiled lens indicator	flashing light indicator
light indicator	LED yellow
sensitivity adjustment	Teach-in: remote

**emitter**

light source	pulsed red LED
wave length	645 nm

**electrical data**

response time / release time	< 0,49 ms
voltage supply range +Vs	10 ... 30 VDC
current consumption max. (no load)	40 mA
current consumption typ.	30 mA
reverse polarity protection	yes

**receiver**

voltage drop V <sub>d</sub>	< 3 VDC
output function	light / dark operate
output circuit	push-pull
output current	< 100 mA
short circuit protection	yes

**mechanical data**

width / diameter	20,2 mm
height / length	47,7 mm
depth	36,4 mm
type	rectangular
housing material	stainless steel 1.4404 (V4A)
front (optics)	PMMA

**ambient conditions**

operating temperature	-25 ... +60 °C
protection class	IP 68/69K & proTect+

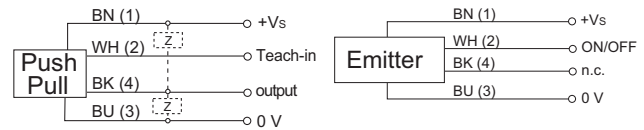
**connection diagrams****connectors and mating connectors**

ESG 34AY0200	Connector M12, 4 pin, straight, 2 m, V4A-PP
ESW 33AY0200	Connector M12, 4 pin, angular, 2 m, V4A-PP

additional cable connectors and field wireable connectors: see accessories

**Accessories**

HI17-1H	Mounting for sensors in hygienic design Ø 17 mm
11137318	Teach Pen for sensors in metal housing
11141124	Teach Pen for sensors in metal housing (USA, CAN, JP)

for details: see accessories section

order reference	emitter / receiver	connection types
O500H.ER-11167297	receiver	cable 4 pin, 2 m
O500H.ER-11167299	receiver	flylead connector M12, L=200 mm
O500H.TR-11167295	emitter	cable 4 pin, 2 m
O500H.TR-11167296	emitter	flylead connector M12, L=200 mm



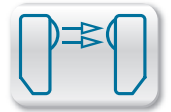

excess gain curve

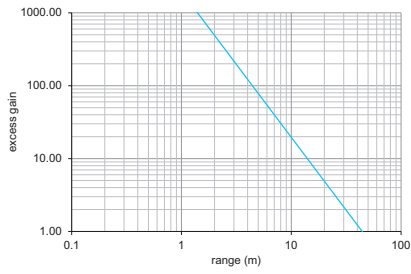

beam characteristic (typically)

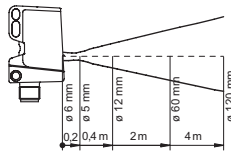

dimension drawings

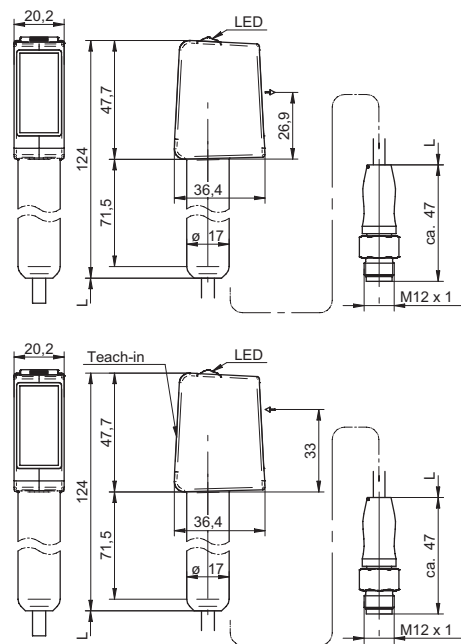
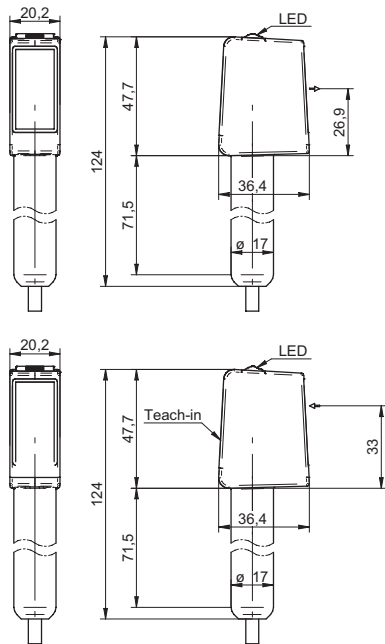

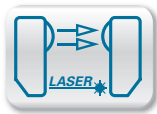

**S<sub>b</sub> = 13 m**

- washdown design
- sensitivity adjustment via potentiometer



### general data

type	through beam sensor
special type	Washdown design
actual range S <sub>b</sub>	13 m
nominal range S <sub>n</sub>	20 m

### receiver

alignment / soiled lens indicator	LED green
output indicator	LED yellow
sensitivity adjustment	potentiometer, 270°

### emitter

light source	pulsed infrared diode
power on indication	LED green
emission power adjustment	potentiometer, 270°
wave length	880 nm

### electrical data

voltage supply range +Vs	12 ... 30 VDC
current consumption max. (no load)	40 mA
current consumption typ.	30 mA
reverse polarity protection	yes

### receiver

response time / release time	< 2 ms
voltage drop V <sub>d</sub>	< 2 VDC
output function	light / dark operate
output current	< 100 mA
short circuit protection	yes

### mechanical data

width / diameter	18 mm
height / length	67,2 mm
type	cylindrical threaded
housing material	stainless steel 1.4404 (V4A)
front (optics)	PMMA
connection types	connector M12 4 pin

### ambient conditions

operating temperature	-25 ... +55 °C
protection class	IP 67/69K

### connection diagrams

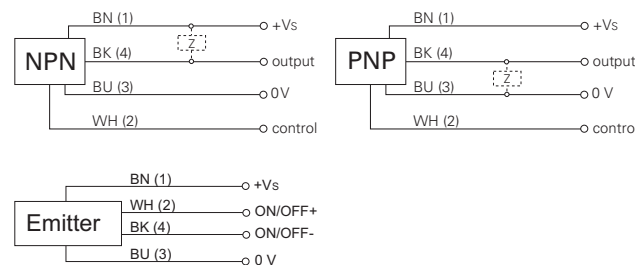

### connectors and mating connectors

ESG 34AY0200	Connector M12, 4 pin, straight, 2 m, V4A-PP
ESW 33AY0200	Connector M12, 4 pin, angular, 2 m, V4A-PP

additional cable connectors and field wireable connectors: see accessories

### Accessories

10151658	Sensofix series 18
ZADAP-M18.STANDARD	Mounting bracket series 18
ZADAP-M18.SHORT	Mounting bracket short series 18 (L design)
ZADAP-M18.LONG	Mounting bracket long series 18 (L design)
ZADAP-M18.SWING	Mounting bracket for adjustment for sensors series 18
ZADAP-M18.MICRO	Mounting bracket for adjustment for sensors series 18

for details: see accessories section

### laser warning



IEC 60825-1/2014  
Complies with 21 CFR 1040.10 and 1040.11  
except for deviations pursuant to laser  
notice No. 50, dated June 24, 2007

### order reference

order reference	emitter / receiver	output circuit
OR18W.EI-11157854	receiver	NPN
OR18W.EI-11157851	receiver	PNP
OR18W.TI-11157855	emitter	-

OR18W.EI / OR18W.TI S<sub>b</sub> = 13 m



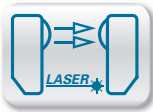

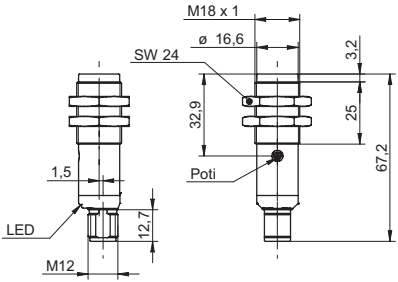

Through beam sensors



dimension drawing





## red light LED version

product family	FGUM 020	FGUM 030	FGUM 030	FGUM 050	FGUM 050	FGUM 080	FGUM 080
							
width / diameter	40 mm	50 mm	50 mm	70 mm	70 mm	100 mm	100 mm
fork width Sb	20 mm	30 mm	30 mm	50 mm	50 mm	80 mm	80 mm
response time / release time	< 0,125 ms	< 0,125 ms	< 0,166 ms	< 0,125 ms	< 0,166 ms	< 0,125 ms	< 0,166 ms
light source	pulsed red LED	pulsed red LED	pulsed red LED	pulsed red LED	pulsed red LED	pulsed red LED	pulsed red LED
sensitivity adjustment	potentiometer, 270°	potentiometer, 270°	Teach-in: button / remote	potentiometer, 270°	Teach-in: button / remote	potentiometer, 270°	Teach-in: button / remote
output circuit	PNP	PNP	PNP	PNP	PNP	PNP	PNP
connection types	connector	connector	connector	connector	connector	connector	connector
housing material	metal	metal	metal	metal	metal	metal	metal
protection class	IP 67	IP 67	IP 67	IP 67	IP 67	IP 67	IP 67
<b>page</b>	<b>239</b>	<b>240</b>	<b>241</b>	<b>242</b>	<b>243</b>	<b>244</b>	<b>245</b>

## laser version

product family	OGUM 030 Basic	OGUM 030 Performance	OGUM 050 Basic	OGUM 050 Performance	OGUM 080 Basic	OGUM 080 Performance	OGUM 120 Basic
							
width / diameter	50 mm	60 mm	70 mm	80 mm	100 mm	110 mm	144 mm
fork width Sb	30 mm	30 mm	50 mm	50 mm	80 mm	80 mm	120 mm
response time / release time	< 0,166 ms	< 0,166 ms	< 0,166 ms	< 0,166 ms	< 0,166 ms	< 0,166 ms	< 0,166 ms
light source	pulsed red laser diode	pulsed red laser diode	pulsed red laser diode	pulsed red laser diode	pulsed red laser diode	pulsed red laser diode	pulsed red laser diode
sensitivity adjustment	potentiometer, 270°	potentiometer, 270°	potentiometer, 270°	potentiometer, 270°	potentiometer, 270°	potentiometer, 270°	potentiometer, 270°
output circuit	PNP	PNP	PNP	PNP	PNP	PNP	PNP
connection types	connector	connector	connector	connector	connector	connector	connector
housing material	metal	metal	metal	metal	metal	metal	metal
protection class	IP 67	IP 67	IP 67	IP 67	IP 67	IP 67	IP 67
<b>page</b>	<b>250</b>	<b>251</b>	<b>252</b>	<b>253</b>	<b>254</b>	<b>255</b>	<b>256</b>

FGUM 120	FGLM 050	FGLM 080	FGLM 120
			
144 mm	75 mm	105 mm	150 mm
120 mm	60 mm	100 mm	158 mm
< 0,25 ms	< 0,125 ms	< 0,125 ms	< 0,25 ms
pulsed red LED	pulsed red LED	pulsed red LED	pulsed red LED
potentiometer, 270°	potentiometer, 270°	potentiometer, 270°	potentiometer, 270°
PNP	PNP	PNP	PNP
connector	connector	connector	connector
metal	metal	metal	metal
IP 67	IP 67	IP 67	IP 67
<b>246</b>	<b>247</b>	<b>248</b>	<b>249</b>

## OGUM 120 Performance



150 mm
120 mm
< 0,166 ms
pulsed red laser diode
potentiometer, 270°
PNP
connector
metal
IP 67
<b>257</b>



## Introduction

Fork and angle sensors comprise an emitter and a receiver optimally aligned to one another and installed in a torsionally rigid metal housing. This enables highly accurate scanning and positioning of objects, as is required in automatic feeders, vibration conveyors and other applications, while high repeatability is ensured by precise collimator optics. Equipped with a laser light source, fork sensors can even position the very smallest of parts in the micron range. Time-consuming alignment and adjustment usually required for through beam sensors is unnecessary. Compared to through beam sensors, the electric wiring features just one cable connection.

## Typical applications

Thanks to their simple handling and optimally aligned optics, fork and angle sensors are extremely versatile. To enable optimum installation, different fork widths as well as U- and L-shaped versions are available.

### Scanning and positioning

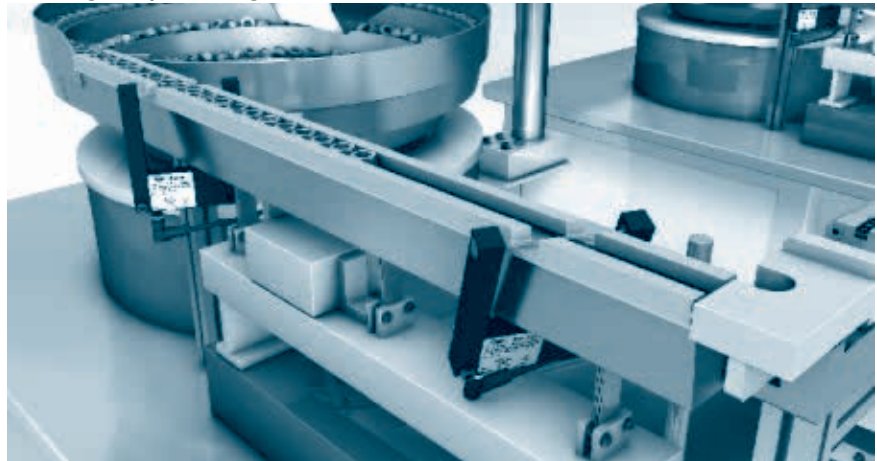

Scanning very small objects down to 50  $\mu\text{m}$  in an automatic feeder

### Stack height monitoring



Monitoring CD sheet stack heights



## Features and benefits

### Easy installation and adjustment

The emitter and receiver are already optimally aligned to one another in a torsionally rigid metal housing.

### Innovative shapes

The special L-shape of the angle sensor enables optimum approach towards the optical axis.

### Fast processes

Switching frequencies of up to 50 kHz allow rotational speed measurements.

### Rugged

Use possible even in harsh ambient conditions thanks to metal housing and protection class IP 67.

## Technology and function

Fork and angle sensors as well as through beam sensors are founded on the same basic principle.

The scratch-resistant, mineral glass collimator optics used in the fork and angle sensors FGUM/ FGLM and OGUM produces a homogeneous, very narrow light beam. This feature gives the sensor its high detection accuracy, which is guaranteed over the entire beam range from all sides.

The largest laser fork sensor can reliably and repeatedly detect a 50 µm object over the entire 120 mm range.

The virtually parallel light beam and the small beam angle of the receiver optics make it possible to install the fork and angle sensors side by side without affecting each other and even produce, for example, small light barriers.

Sensitivity adjustment features a choice of two different adjustment methods – easy manual adjustment of sensitivity using a potentiometer or variable adjustment options by automatic teach-in.

### Potentiometer

Easy sensitivity adjustment thanks to mechanical 270° potentiometer directly on the fork sensor.

### Teach-in

The teach-in function enables rapid and easy commissioning in the field. The teach-in operation can be performed using the integrated teach-in button or the external teach-in cable.



## Mounting and adjustment

The almost parallel light beam and the small beam angle of the receiver optics make it possible to install the sensors side by side without affecting each other and even construct, for example, small light barriers.

Attach the fork and angle sensors so that the object can pass freely through the scanning range. The receiver side should be protected from direct exposure to external light sources.

### **Potentiometer adjustment**

Sensitivity is highest when the potentiometer is turned fully counterclockwise, enabling the smallest possible parts to be scanned with minimal power of the beam.

When the potentiometer is turned fully clockwise, sensitivity is lowest, so only larger parts are scanned. The power of the beam is highest and the fork/angle sensor has high excess gain to combat dirt.

### **Teach-in adjustment**

The dynamic teach-in facility enables the sensor to calculate the optimum sensitivity level during operation, resulting in new potential applications.

For example, the smallest objects can be taught in without precise positioning simply by passing the light beam.

To initiate the dynamic teach-in procedure, the yellow teach-in button must be held down for 2 seconds. At least two objects should pass the light beam of the fork sensor during the following 2-4 seconds of the active teach-in phase. The LED indicates the active teach-in phase by flashing rapidly. If the teach-in procedure was completed successfully, this is clearly and visibly indicated by two flashes of the LED.

The active teach-in phase can be defined individually using an external teach-in facility. The longer a pulse is applied to the external teach-in cable, the longer the sensor teaches in its surrounding. When the external teach-in facility is employed, the teach-in button can also be automatically disabled.

### **Adjustment of light/dark switching**

The output functions NO (dark-switching) and NC (light-switching) can be adjusted using a rotary switch. The required switch position is indicated on the type plate. To prevent accidental switching, the rotary switch is covered by a rubber cap.

**Important:** always set the switch for the output function fully clockwise or counterclockwise. Intermediate positions lead to undefined output states.





**S<sub>b</sub> = 20 mm**



- sensitivity adjustable via potentiometer
- fork width 20 mm
- rugged metal housing

#### general data

type	through beam sensor
object size	> 0,4 mm
repeat accuracy	< 0,02 mm
hysteresis	< 0,1 mm
ambient light immunity	< 50 kLux
sensitivity adjustment	potentiometer, 270°
light source	pulsed red LED
wave length	660 nm
light indicator	LED yellow

#### electrical data

response time / release time	< 0,125 ms
switching frequency	< 4 kHz
voltage supply range +Vs	10 ... 35 VDC
current consumption max. (no load)	30 mA
output function	light / dark operate switchable
output circuit	PNP
voltage drop V <sub>d</sub>	< 2,8 VDC
output current	< 200 mA
short circuit protection	yes
reverse polarity protection	yes

#### mechanical data

width / diameter	40 mm
fork width S <sub>b</sub>	20 mm
height / length	50 mm
penetration depth	25 mm
depth	10 mm
type	U profile
housing material	die-cast zinc
connection types	connector M8, 3 pin

#### ambient conditions

operating temperature	-10 ... +60 °C
protection class	IP 67

#### connectors and mating connectors

ESG 32SH0200	Connector M8, 3 pin, straight, 2 m
ESW 31SH0200	Connector M8, 3 pin, angular, 2 m
additional cable connectors and field wireable connectors: see accessories	

#### order reference

**FGUM 020P8001/S35L**

#### dimension drawing

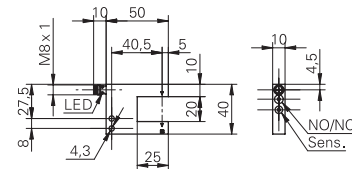

#### connection diagram

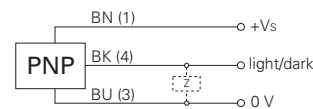

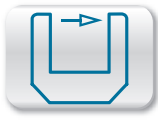

Sb = 30 mm



- sensitivity adjustable via potentiometer
- fork width 30 mm
- rugged metal housing

**general data**

type	through beam sensor
object size	> 0,5 mm
repeat accuracy	< 0,02 mm
hysteresis	< 0,25 mm
ambient light immunity	< 140 kLux
sensitivity adjustment	potentiometer, 270°
light source	pulsed red LED
wave length	660 nm
light indicator	LED yellow

**electrical data**

response time / release time	< 0,125 ms
switching frequency	< 4 kHz
voltage supply range +Vs	10 ... 35 VDC
current consumption max. (no load)	30 mA
output function	light / dark operate switchable
output circuit	PNP
voltage drop Vd	< 2,8 VDC
output current	< 200 mA
short circuit protection	yes
reverse polarity protection	yes

**mechanical data**

width / diameter	50 mm
fork width Sb	30 mm
height / length	60 mm
penetration depth	35 mm
depth	10 mm
type	U profile
housing material	die-cast zinc
connection types	connector M8, 3 pin

**ambient conditions**

operating temperature	-10 ... +60 °C
protection class	IP 67

**connectors and mating connectors**

ESG 32SH0200	Connector M8, 3 pin, straight, 2 m
ESW 31SH0200	Connector M8, 3 pin, angular, 2 m
additional cable connectors and field wireable connectors: see accessories	

**order reference**

FGUM 030P8001/S35L

**dimension drawing**

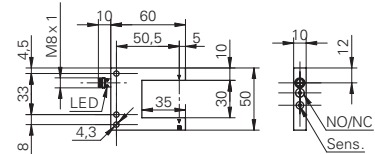

**connection diagram**

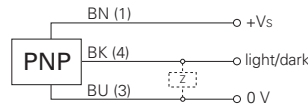



Sb = 30 mm



- sensitivity adjustable via Teach-in
- smallest detectable object 0,3 mm
- rugged metal housing

**general data**

type	through beam sensor
object size	> 0,3 mm
repeat accuracy	< 0,03 mm
hysteresis	< 0,1 mm
ambient light immunity	< 20 kLux
sensitivity adjustment	Teach-in: button / remote
light source	pulsed red LED
wave length	660 nm
light indicator	LED yellow

**electrical data**

response time / release time	< 0,166 ms
switching frequency	< 3 kHz
voltage supply range +Vs	10 ... 35 VDC
current consumption max. (no load)	30 mA
output function	light / dark operate switchable
output circuit	PNP
voltage drop Vd	< 2 VDC
output current	< 200 mA
short circuit protection	yes
reverse polarity protection	yes

**mechanical data**

width / diameter	50 mm
fork width Sb	30 mm
height / length	60 mm
penetration depth	35 mm
depth	10 mm
type	U profile
housing material	die-cast zinc
connection types	connector M8

**ambient conditions**

operating temperature	-10 ... +60 °C
protection class	IP 67

**connectors and mating connectors**

ESG 32SH0200	Connector M8, 3 pin, straight, 2 m
ESW 31SH0200	Connector M8, 3 pin, angular, 2 m
additional cable connectors and field wireable connectors: see accessories	

**order reference**

FGUM 030P6901/S35A

**dimension drawing**

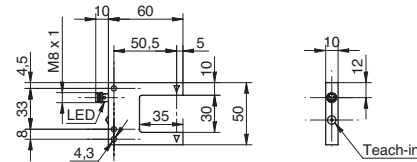

**connection diagram**

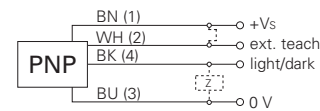

FGUM 030 Sb = 30 mm Fork and angle sensors

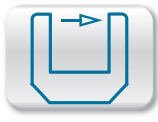

Sb = 50 mm



- sensitivity adjustable via potentiometer
- fork width 50 mm
- rugged metal housing

**general data**

type	through beam sensor
object size	> 0,5 mm
repeat accuracy	< 0,04 mm
hysteresis	< 0,25 mm
ambient light immunity	< 80 kLux
sensitivity adjustment	potentiometer, 270°
light source	pulsed red LED
wave length	660 nm
light indicator	LED yellow

**electrical data**

response time / release time	< 0,125 ms
switching frequency	< 4 kHz
voltage supply range +Vs	10 ... 35 VDC
current consumption max. (no load)	30 mA
output function	light / dark operate switchable
output circuit	PNP
voltage drop Vd	< 2,8 VDC
output current	< 200 mA
short circuit protection	yes
reverse polarity protection	yes

**mechanical data**

width / diameter	70 mm
fork width Sb	50 mm
height / length	80 mm
penetration depth	55 mm
depth	10 mm
type	U profile
housing material	die-cast zinc
connection types	connector M8, 3 pin

**ambient conditions**

operating temperature	-10 ... +60 °C
protection class	IP 67

**connectors and mating connectors**

ESG 32SH0200	Connector M8, 3 pin, straight, 2 m
ESW 31SH0200	Connector M8, 3 pin, angular, 2 m
additional cable connectors and field wireable connectors: see accessories	

**order reference**

FGUM 050P8001/S35L

**dimension drawing**

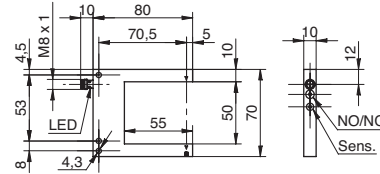

**connection diagram**

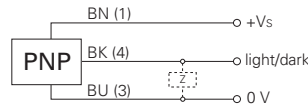



**S<sub>b</sub> = 50 mm**

- sensitivity adjustable via Teach-in
- smallest detectable object 0,3 mm
- rugged metal housing



### general data

type	through beam sensor
object size	> 0,3 mm
repeat accuracy	< 0,03 mm
hysteresis	< 0,1 mm
ambient light immunity	< 20 kLux
sensitivity adjustment	Teach-in: button / remote
light source	pulsed red LED
wave length	660 nm
light indicator	LED yellow

### electrical data

response time / release time	< 0,166 ms
switching frequency	< 3 kHz
voltage supply range +Vs	10 ... 35 VDC
current consumption max. (no load)	30 mA
output function	light / dark operate switchable
output circuit	PNP
voltage drop V <sub>d</sub>	< 2 VDC
output current	< 200 mA
short circuit protection	yes
reverse polarity protection	yes

### mechanical data

width / diameter	70 mm
fork width S <sub>b</sub>	50 mm
height / length	80 mm
penetration depth	55 mm
depth	10 mm
type	U profile
housing material	die-cast zinc
connection types	connector M8

### ambient conditions

operating temperature	-10 ... +60 °C
protection class	IP 67

### connectors and mating connectors

ESG 32SH0200	Connector M8, 3 pin, straight, 2 m
ESW 31SH0200	Connector M8, 3 pin, angular, 2 m
additional cable connectors and field wireable connectors: see accessories	

### order reference

**FGUM 050P6901/S35A**

### dimension drawing

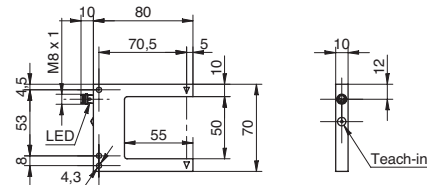

### connection diagram

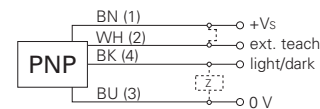

FGUM 050 S<sub>b</sub> = 50 mm Fork and angle sensors



**S<sub>b</sub> = 80 mm**



- sensitivity adjustable via potentiometer
- fork width 80 mm
- rugged metal housing

#### general data

type	through beam sensor
object size	> 0,5 mm
repeat accuracy	< 0,06 mm
hysteresis	< 0,25 mm
ambient light immunity	< 80 kLux
sensitivity adjustment	potentiometer, 270°
light source	pulsed red LED
wave length	660 nm
light indicator	LED yellow

#### electrical data

response time / release time	< 0,125 ms
switching frequency	< 4 kHz
voltage supply range +Vs	10 ... 35 VDC
current consumption max. (no load)	30 mA
output function	light / dark operate switchable
output circuit	PNP
voltage drop V <sub>d</sub>	< 2,8 VDC
output current	< 200 mA
short circuit protection	yes
reverse polarity protection	yes

#### mechanical data

width / diameter	100 mm
fork width S <sub>b</sub>	80 mm
height / length	80 mm
penetration depth	55 mm
depth	10 mm
type	U profile
housing material	die-cast zinc
connection types	connector M8, 3 pin

#### ambient conditions

operating temperature	-10 ... +60 °C
protection class	IP 67

#### connectors and mating connectors

ESG 32SH0200	Connector M8, 3 pin, straight, 2 m
ESW 31SH0200	Connector M8, 3 pin, angular, 2 m
additional cable connectors and field wireable connectors: see accessories	

#### order reference

**FGUM 080P8001/S35L**

#### dimension drawing

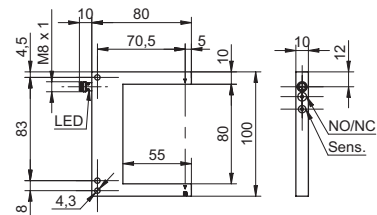

#### connection diagram

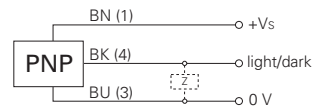



**S<sub>b</sub> = 80 mm**

- sensitivity adjustable via Teach-in
- smallest detectable object 0,3 mm
- rugged metal housing



### general data

type	through beam sensor
object size	> 0,3 mm
repeat accuracy	< 0,03 mm
hysteresis	< 0,1 mm
ambient light immunity	< 20 kLux
sensitivity adjustment	Teach-in: button / remote
light source	pulsed red LED
wave length	660 nm
light indicator	LED yellow

### electrical data

response time / release time	< 0,166 ms
switching frequency	< 3 kHz
voltage supply range +Vs	10 ... 35 VDC
current consumption max. (no load)	30 mA
output function	light / dark operate switchable
output circuit	PNP
voltage drop V <sub>d</sub>	< 2 VDC
output current	< 200 mA
short circuit protection	yes
reverse polarity protection	yes

### mechanical data

width / diameter	100 mm
fork width S <sub>b</sub>	80 mm
height / length	80 mm
penetration depth	55 mm
depth	10 mm
type	U profile
housing material	die-cast zinc
connection types	connector M8

### ambient conditions

operating temperature	-10 ... +60 °C
protection class	IP 67

### connectors and mating connectors

ESG 32SH0200	Connector M8, 3 pin, straight, 2 m
ESW 31SH0200	Connector M8, 3 pin, angular, 2 m
additional cable connectors and field wireable connectors: see accessories	

### order reference

**FGUM 080P6901/S35A**

### dimension drawing

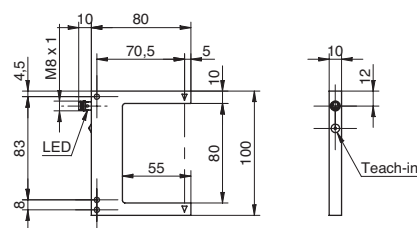

### connection diagram

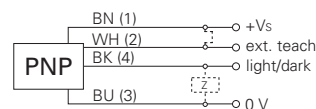

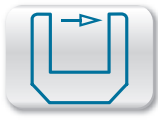

Sb = 120 mm



- sensitivity adjustable via potentiometer
- fork width 120 mm
- rugged metal housing

**general data**

type	through beam sensor
object size	> 0,8 mm
repeat accuracy	< 0,06 mm
hysteresis	< 0,25 mm
ambient light immunity	< 50 kLux
sensitivity adjustment	potentiometer, 270°
light source	pulsed red LED
wave length	660 nm
light indicator	LED yellow

**electrical data**

response time / release time	< 0,25 ms
switching frequency	< 2 kHz
voltage supply range +Vs	10 ... 35 VDC
current consumption max. (no load)	40 mA
output function	light / dark operate switchable
output circuit	PNP
voltage drop Vd	< 2,8 VDC
output current	< 200 mA
short circuit protection	yes
reverse polarity protection	yes

**mechanical data**

width / diameter	144 mm
fork width Sb	120 mm
height / length	90 mm
penetration depth	60 mm
depth	12 mm
type	U profile
housing material	die-cast zinc
connection types	connector M8, 3 pin

**ambient conditions**

operating temperature	-10 ... +60 °C
protection class	IP 67

**connectors and mating connectors**

ESG 32SH0200	Connector M8, 3 pin, straight, 2 m
ESW 31SH0200	Connector M8, 3 pin, angular, 2 m
additional cable connectors and field wireable connectors: see accessories	

**order reference**

FGUM 120P8001/S35L

**dimension drawing**

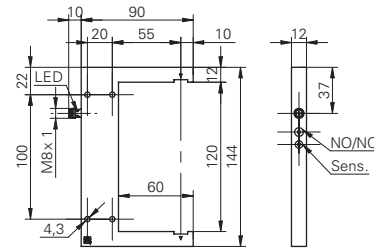

**connection diagram**

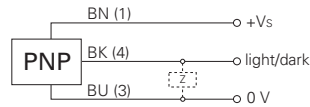





**S<sub>b</sub> = 60 mm**



- optical axis approachable in x-, y- and z-direction
- smallest detectable object 0,5 mm
- rugged metal housing

### general data

type	through beam sensor
object size	> 0,5 mm
repeat accuracy	< 0,06 mm
hysteresis	< 0,25 mm
ambient light immunity	< 80 kLux
sensitivity adjustment	potentiometer, 270°
light source	pulsed red LED
wave length	660 nm
light indicator	LED yellow

### electrical data

response time / release time	< 0,125 ms
switching frequency	< 4 kHz
voltage supply range +Vs	10 ... 35 VDC
current consumption max. (no load)	30 mA
output function	light / dark operate switchable
output circuit	PNP
voltage drop V <sub>d</sub>	< 2,8 VDC
output current	< 200 mA
short circuit protection	yes
reverse polarity protection	yes

### mechanical data

width / diameter	75 mm
fork width S <sub>b</sub>	60 mm
height / length	75 mm
penetration depth	50 mm
depth	10 mm
type	L profile
housing material	die-cast zinc
connection types	connector M8, 3 pin

### ambient conditions

operating temperature	-10 ... +60 °C
protection class	IP 67

### connectors and mating connectors

ESG 32SH0200	Connector M8, 3 pin, straight, 2 m
ESW 31SH0200	Connector M8, 3 pin, angular, 2 m
additional cable connectors and field wireable connectors: see accessories	

### order reference

**FGLM 050P8001/S35L**

### dimension drawing

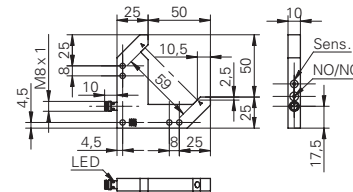

### connection diagram

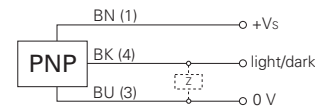

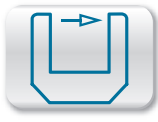

Sb = 100 mm



- optical axis approachable in x-, y- and z-direction
- smallest detectable object 0,7 mm
- rugged metal housing

**general data**

type	through beam sensor
object size	> 0,7 mm
repeat accuracy	< 0,06 mm
hysteresis	< 0,25 mm
ambient light immunity	< 70 kLux
sensitivity adjustment	potentiometer, 270°
light source	pulsed red LED
wave length	660 nm
light indicator	LED yellow

**electrical data**

response time / release time	< 0,125 ms
switching frequency	< 4 kHz
voltage supply range +Vs	10 ... 35 VDC
current consumption max. (no load)	30 mA
output function	light / dark operate switchable
output circuit	PNP
voltage drop Vd	< 2,8 VDC
output current	< 200 mA
short circuit protection	yes
reverse polarity protection	yes

**mechanical data**

width / diameter	105 mm
fork width Sb	100 mm
height / length	105 mm
penetration depth	80 mm
depth	10 mm
type	L profile
housing material	die-cast zinc
connection types	connector M8, 3 pin

**ambient conditions**

operating temperature	-10 ... +60 °C
protection class	IP 67

**connectors and mating connectors**

ESG 32SH0200	Connector M8, 3 pin, straight, 2 m
ESW 31SH0200	Connector M8, 3 pin, angular, 2 m
additional cable connectors and field wireable connectors: see accessories	

**order reference**

FGLM 080P8001/S35L

**dimension drawing**

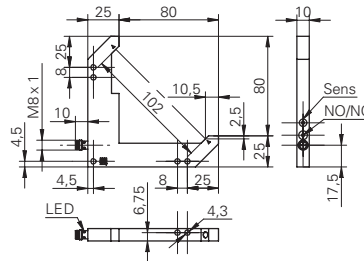

**connection diagram**

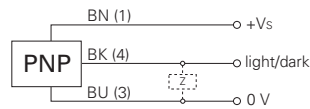



Sb = 158 mm



- optical axis approachable in x-, y- and z-direction
- smallest detectable object 1 mm
- rugged metal housing

**general data**

type	through beam sensor
object size	> 1 mm
repeat accuracy	< 0,06 mm
hysteresis	< 0,25 mm
ambient light immunity	< 50 kLux
sensitivity adjustment	potentiometer, 270°
light source	pulsed red LED
wave length	660 nm
light indicator	LED yellow

**electrical data**

response time / release time	< 0,25 ms
switching frequency	< 2 kHz
voltage supply range +Vs	10 ... 35 VDC
current consumption max. (no load)	40 mA
output function	light / dark operate switchable
output circuit	PNP
voltage drop Vd	< 2,8 VDC
output current	< 200 mA
short circuit protection	yes
reverse polarity protection	yes

**mechanical data**

width / diameter	150 mm
fork width Sb	158 mm
height / length	150 mm
penetration depth	120 mm
depth	12 mm
type	L profile
housing material	die-cast zinc
connection types	connector M8, 3 pin

**ambient conditions**

operating temperature	-10 ... +60 °C
protection class	IP 67

**connectors and mating connectors**

ESG 32SH0200	Connector M8, 3 pin, straight, 2 m
ESW 31SH0200	Connector M8, 3 pin, angular, 2 m
additional cable connectors and field wireable connectors: see accessories	

**order reference**

FGLM 120P8001/S35L

**dimension drawing**

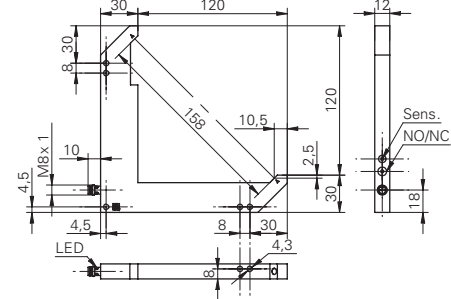

**connection diagram**

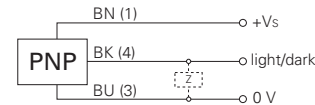

FGLM 120 Sb = 158 mm Fork and angle sensors

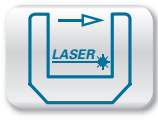

Sb = 30 mm



- laser fork sensor in rugged metal housing
- smallest detectable object 0,1 mm
- high repeatability of 0,02 mm

**general data**

type	through beam sensor
object size	> 0,1 mm
repeat accuracy	< 0,02 mm
hysteresis	< 0,05 mm
ambient light immunity	< 5 kLux
sensitivity adjustment	potentiometer, 270°
light source	pulsed red laser diode
wave length	670 nm
laser class	1
light indicator	LED yellow

**electrical data**

response time / release time	< 0,166 ms
switching frequency	< 3 kHz
voltage supply range +Vs	10 ... 30 VDC
current consumption max. (no load)	30 mA
output function	light / dark operate switchable
output circuit	PNP
voltage drop Vd	< 2,8 VDC
output current	< 200 mA
short circuit protection	yes
reverse polarity protection	yes

**mechanical data**

width / diameter	50 mm
fork width Sb	30 mm
height / length	60 mm
penetration depth	35 mm
depth	10 mm
type	U profile
housing material	die-cast zinc
connection types	connector M8, 3 pin

**ambient conditions**

operating temperature	5 ... +45 °C
protection class	IP 67

**connectors and mating connectors**

ESG 32SH0200	Connector M8, 3 pin, straight, 2 m
ESW 31SH0200	Connector M8, 3 pin, angular, 2 m
additional cable connectors and field wireable connectors: see accessories	

**Accessories**

10161959	Converter PNP/NPN - M8 x 1
11163236	Adapter for pulse stretching M8
for details: see accessories section	

**dimension drawing**

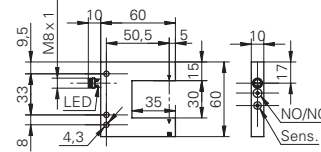

**connection diagram**

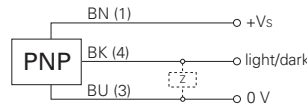

**laser warning**



IEC 60825-1/2014  
Complies with 21 CFR 1040.10 and 1040.11  
except for deviations pursuant to laser  
notice No. 50, dated June 24, 2007

**order reference**

OGUM 030P8002/S35L

OGUM 030 Basic Sb = 30 mm Fork and angle sensors

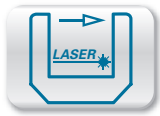

**S<sub>b</sub> = 30 mm**

- precise laser fork sensor in rugged metal housing
- smallest detectable object 0,05 mm
- very high repeatability of 0,01 mm



### general data

type	through beam sensor
object size	> 0,05 mm
repeat accuracy	< 0,01 mm
hysteresis	< 0,02 mm
ambient light immunity	< 100 kLux
sensitivity adjustment	potentiometer, 270°
light source	pulsed red laser diode
wave length	670 nm
laser class	1
light indicator	LED yellow

### electrical data

response time / release time	< 0,166 ms
switching frequency	< 3 kHz
voltage supply range +Vs	10 ... 30 VDC
current consumption max. (no load)	30 mA
output function	light / dark operate switchable
output circuit	PNP
voltage drop V <sub>d</sub>	< 2,8 VDC
output current	< 200 mA
short circuit protection	yes
reverse polarity protection	yes

### mechanical data

width / diameter	60 mm
fork width S <sub>b</sub>	30 mm
height / length	60 mm
penetration depth	35 mm
depth	10 mm
type	U profile
housing material	aluminum anodized
connection types	connector M8, 3 pin

### ambient conditions

operating temperature	5 ... +45 °C
protection class	IP 67

### connectors and mating connectors

ESG 32SH0200	Connector M8, 3 pin, straight, 2 m
ESW 31SH0200	Connector M8, 3 pin, angular, 2 m
additional cable connectors and field wireable connectors: see accessories	

### order reference

**OGUM 030P8001/S35L**

### dimension drawing

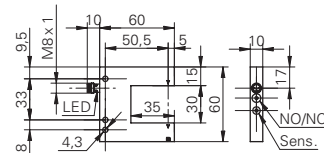

### connection diagram

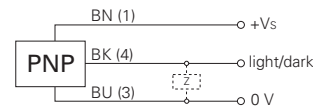

### laser warning

**CLASS 1 LASER PRODUCT**

IEC 60825-1/2014  
Complies with 21 CFR 1040.10 and 1040.11  
except for deviations pursuant to laser  
notice No. 50, dated June 24, 2007

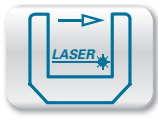

Sb = 50 mm



- laser fork sensor in rugged metal housing
- smallest detectable object 0,1 mm
- high repeatability of 0,02 mm

**general data**

type	through beam sensor
object size	> 0,1 mm
repeat accuracy	< 0,02 mm
hysteresis	< 0,05 mm
ambient light immunity	< 5 kLux
sensitivity adjustment	potentiometer, 270°
light source	pulsed red laser diode
wave length	670 nm
laser class	1
light indicator	LED yellow

**electrical data**

response time / release time	< 0,166 ms
switching frequency	< 3 kHz
voltage supply range +Vs	10 ... 30 VDC
current consumption max. (no load)	30 mA
output function	light / dark operate switchable
output circuit	PNP
voltage drop Vd	< 2,8 VDC
output current	< 200 mA
short circuit protection	yes
reverse polarity protection	yes

**mechanical data**

width / diameter	70 mm
fork width Sb	50 mm
height / length	80 mm
penetration depth	55 mm
depth	10 mm
type	U profile
housing material	die-cast zinc
connection types	connector M8, 3 pin

**ambient conditions**

operating temperature	5 ... +45 °C
protection class	IP 67

**connectors and mating connectors**

ESG 32SH0200	Connector M8, 3 pin, straight, 2 m
ESW 31SH0200	Connector M8, 3 pin, angular, 2 m
additional cable connectors and field wireable connectors: see accessories	

**Accessories**

10161959	Converter PNP/NPN - M8 x 1
11163236	Adapter for pulse stretching M8
for details: see accessories section	

**order reference**

OGUM 050P8002/S35L

**dimension drawing**

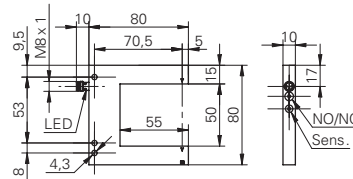

**connection diagram**

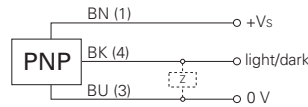

**laser warning**

**CLASS 1 LASER PRODUCT**

IEC 60825-1/2014  
Complies with 21 CFR 1040.10 and 1040.11  
except for deviations pursuant to laser  
notice No. 50, dated June 24, 2007

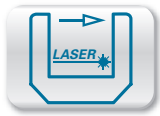

Sb = 50 mm

- precise laser fork sensor in rugged metal housing
- smallest detectable object 0,05 mm
- very high repeatability of 0,01 mm



**general data**

type	through beam sensor
object size	> 0,05 mm
repeat accuracy	< 0,01 mm
hysteresis	< 0,02 mm
ambient light immunity	< 100 kLux
sensitivity adjustment	potentiometer, 270°
light source	pulsed red laser diode
wave length	670 nm
laser class	1
light indicator	LED yellow

**electrical data**

response time / release time	< 0,166 ms
switching frequency	< 3 kHz
voltage supply range +Vs	10 ... 30 VDC
current consumption max. (no load)	30 mA
output function	light / dark operate switchable
output circuit	PNP
voltage drop Vd	< 2,8 VDC
output current	< 200 mA
short circuit protection	yes
reverse polarity protection	yes

**mechanical data**

width / diameter	80 mm
fork width Sb	50 mm
height / length	80 mm
penetration depth	55 mm
depth	10 mm
type	U profile
housing material	aluminum anodized
connection types	connector M8, 3 pin

**ambient conditions**

operating temperature	5 ... +45 °C
protection class	IP 67

**connectors and mating connectors**

ESG 32SH0200	Connector M8, 3 pin, straight, 2 m
ESW 31SH0200	Connector M8, 3 pin, angular, 2 m
additional cable connectors and field wireable connectors: see accessories	

**order reference**

**OGUM 050P8001/S35L**

**dimension drawing**

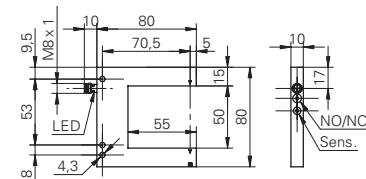

**connection diagram**

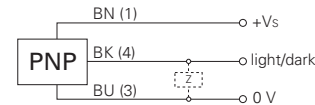

**laser warning**

**CLASS 1 LASER PRODUCT**

IEC 60825-1/2014  
Complies with 21 CFR 1040.10 and 1040.11  
except for deviations pursuant to laser  
notice No. 50, dated June 24, 2007

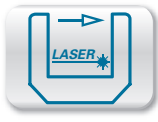

Sb = 80 mm

- laser fork sensor in rugged metal housing
- smallest detectable object 0,1 mm
- repeatability of 0,02 mm



**general data**

type	through beam sensor
object size	> 0,2 mm
repeat accuracy	< 0,02 mm
hysteresis	< 0,05 mm
ambient light immunity	< 5 kLux
sensitivity adjustment	potentiometer, 270°
light source	pulsed red laser diode
wave length	670 nm
laser class	1
light indicator	LED yellow

**electrical data**

response time / release time	< 0,166 ms
switching frequency	< 3 kHz
voltage supply range +Vs	10 ... 30 VDC
current consumption max. (no load)	30 mA
output function	light / dark operate switchable
output circuit	PNP
voltage drop Vd	< 2,8 VDC
output current	< 200 mA
short circuit protection	yes
reverse polarity protection	yes

**mechanical data**

width / diameter	100 mm
fork width Sb	80 mm
height / length	80 mm
penetration depth	55 mm
depth	10 mm
type	U profile
housing material	die-cast zinc
connection types	connector M8, 3 pin

**ambient conditions**

operating temperature	5 ... +45 °C
protection class	IP 67

**connectors and mating connectors**

ESG 32SH0200	Connector M8, 3 pin, straight, 2 m
ESW 31SH0200	Connector M8, 3 pin, angular, 2 m
additional cable connectors and field wireable connectors: see accessories	

**Accessories**

10161959	Converter PNP/NPN - M8 x 1
11163236	Adapter for pulse stretching M8
for details: see accessories section	

**order reference**

OGUM 080P8002/S35L

**dimension drawing**

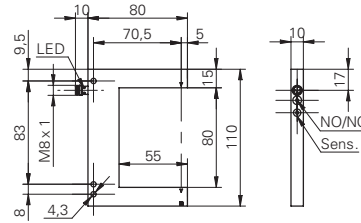

**connection diagram**

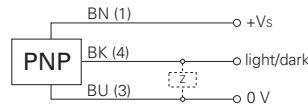

**laser warning**



IEC 60825-1/2014  
Complies with 21 CFR 1040.10 and 1040.11  
except for deviations pursuant to laser  
notice No. 50, dated June 24, 2007



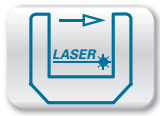

**S<sub>b</sub> = 80 mm**

- precise laser fork sensor in rugged metal housing
- smallest detectable object 0,05 mm
- very high repeatability of 0,01 mm



### general data

type	through beam sensor
object size	> 0,05 mm
repeat accuracy	< 0,01 mm
hysteresis	< 0,02 mm
ambient light immunity	< 100 kLux
sensitivity adjustment	potentiometer, 270°
light source	pulsed red laser diode
wave length	670 nm
laser class	1
light indicator	LED yellow

### electrical data

response time / release time	< 0,166 ms
switching frequency	< 3 kHz
voltage supply range +Vs	10 ... 30 VDC
current consumption max. (no load)	30 mA
output function	light / dark operate switchable
output circuit	PNP
voltage drop V <sub>d</sub>	< 2,8 VDC
output current	< 200 mA
short circuit protection	yes
reverse polarity protection	yes

### mechanical data

width / diameter	110 mm
fork width S <sub>b</sub>	80 mm
height / length	80 mm
penetration depth	55 mm
depth	10 mm
type	U profile
housing material	aluminum anodized
connection types	connector M8, 3 pin

### ambient conditions

operating temperature	5 ... +45 °C
protection class	IP 67

### connectors and mating connectors

ESG 32SH0200	Connector M8, 3 pin, straight, 2 m
ESW 31SH0200	Connector M8, 3 pin, angular, 2 m
additional cable connectors and field wireable connectors: see accessories	

### order reference

**OGUM 080P8001/S35L**

### dimension drawing

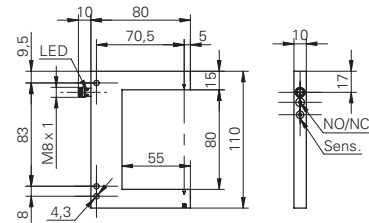

### connection diagram

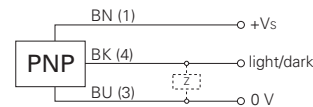

### laser warning

**CLASS 1 LASER PRODUCT**

IEC 60825-1/2014  
Complies with 21 CFR 1040.10 and 1040.11  
except for deviations pursuant to laser  
notice No. 50, dated June 24, 2007

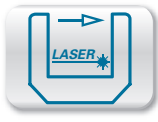

Sb = 120 mm

- laser fork sensor in rugged metal housing
- smallest detectable object 0,1 mm
- repeatability of 0,02 mm



**general data**

type	through beam sensor
object size	> 0,2 mm
repeat accuracy	< 0,02 mm
hysteresis	< 0,05 mm
ambient light immunity	< 5 kLux
sensitivity adjustment	potentiometer, 270°
light source	pulsed red laser diode
wave length	670 nm
laser class	1
light indicator	LED yellow

**electrical data**

response time / release time	< 0,166 ms
switching frequency	< 3 kHz
voltage supply range +Vs	10 ... 30 VDC
current consumption max. (no load)	30 mA
output function	light / dark operate switchable
output circuit	PNP
voltage drop Vd	< 2,8 VDC
output current	< 200 mA
short circuit protection	yes
reverse polarity protection	yes

**mechanical data**

width / diameter	144 mm
fork width Sb	120 mm
height / length	90 mm
penetration depth	60 mm
depth	12 mm
type	U profile
housing material	die-cast zinc
connection types	connector M8, 3 pin

**ambient conditions**

operating temperature	5 ... +45 °C
protection class	IP 67

**connectors and mating connectors**

ESG 32SH0200	Connector M8, 3 pin, straight, 2 m
ESW 31SH0200	Connector M8, 3 pin, angular, 2 m
additional cable connectors and field wireable connectors: see accessories	

**Accessories**

10161959	Converter PNP/NPN - M8 x 1
11163236	Adapter for pulse stretching M8
for details: see accessories section	

**order reference**

OGUM 120P8002/S35L

**dimension drawing**

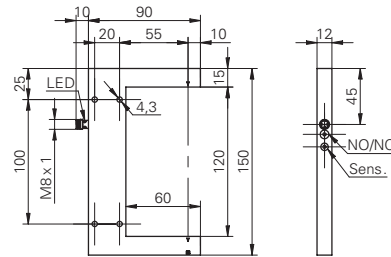

**connection diagram**

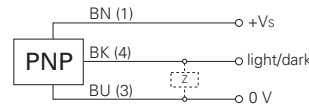

**laser warning**

**CLASS 1 LASER PRODUCT**

IEC 60825-1/2014  
Complies with 21 CFR 1040.10 and 1040.11  
except for deviations pursuant to laser  
notice No. 50, dated June 24, 2007

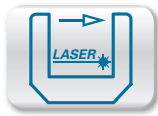

**S<sub>b</sub> = 120 mm**

- precise laser fork sensor in rugged metal housing
- smallest detectable object 0,05 mm
- very high repeatability of 0,01 mm



### general data

type	through beam sensor
object size	> 0,05 mm
repeat accuracy	< 0,01 mm
hysteresis	< 0,02 mm
ambient light immunity	< 100 kLux
sensitivity adjustment	potentiometer, 270°
light source	pulsed red laser diode
wave length	670 nm
laser class	1
light indicator	LED yellow

### electrical data

response time / release time	< 0,166 ms
switching frequency	< 3 kHz
voltage supply range +Vs	10 ... 30 VDC
current consumption max. (no load)	30 mA
output function	light / dark operate switchable
output circuit	PNP
voltage drop V <sub>d</sub>	< 2,8 VDC
output current	< 200 mA
short circuit protection	yes
reverse polarity protection	yes

### mechanical data

width / diameter	150 mm
fork width S <sub>b</sub>	120 mm
height / length	90 mm
penetration depth	60 mm
depth	12 mm
type	U profile
housing material	aluminum anodized
connection types	connector M8, 3 pin

### ambient conditions

operating temperature	5 ... +45 °C
protection class	IP 67

### connectors and mating connectors

ESG 32SH0200	Connector M8, 3 pin, straight, 2 m
ESW 31SH0200	Connector M8, 3 pin, angular, 2 m
additional cable connectors and field wireable connectors: see accessories	

### order reference

**OGUM 120P8001/S35L**

### dimension drawing

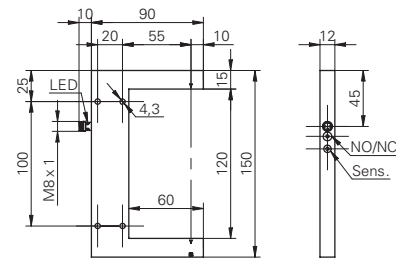

### connection diagram

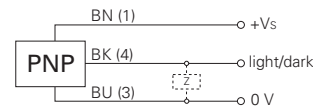



















### laser warning

**CLASS 1 LASER PRODUCT**









IEC 60825-1/2014  
Complies with 21 CFR 1040.10 and 1040.11  
except for deviations pursuant to laser  
notice No. 50, dated June 24, 2007

## red light LED version

product family	FHDK 04	FHCK 07	FHDK 07	FHDK 10	FHDK 10	FHDK 10	FHDK 10
							
	subminiature	<i>MINOS</i> subminiature	<i>MINOS</i> subminiature	miniature	miniature	miniature	miniature
version						point source LED	line beam
width / diameter	4 mm	8 mm	8 mm	10,4 mm	10,4 mm	10,4 mm	10,4 mm
sensing distance $T_w$	30 mm $\pm$ 2 mm 50 mm $\pm$ 3 mm	10 ... 60 mm	10 ... 60 mm	30 mm $\pm$ 2 mm 50 mm $\pm$ 3 mm 80 mm $\pm$ 8 mm	20 ... 120 mm	25 ... 120 mm	20 ... 80 mm
response time / release time	< 0,5 ms	< 0,5 ms	< 0,5 ms	< 1 ms	< 1 ms	< 1 ms	< 1 ms
light source	pulsed point source LED	pulsed red LED	pulsed red LED	pulsed red LED	pulsed red LED	pulsed point source LED	pulsed red LED
sensing distance adjustment		Teach-in	Teach-in		mechanical, 5 turn	mechanical, 5 turn	mechanical, 5 turn
output circuit	push-pull	NPN PNP	NPN PNP	push-pull	NPN PNP	NPN PNP	NPN PNP
connection types	cable fylead connector	cable fylead connector	cable fylead connector	cable connector	fylead connector cable connector	cable connector	cable connector
housing material	plastic	plastic	plastic	plastic	plastic	plastic	plastic
protection class	IP 65	IP 65	IP 65	IP 65 IP 67	IP 65 IP 67	IP 65 IP 67	IP 65 IP 67
<b>page</b>	<b>270</b>	<b>272</b>	<b>274</b>	<b>276</b>	<b>278</b>	<b>280</b>	<b>282</b>

FHDK 10	FHDM 12	O300.GP	O300.GP	O300.GR	O300.GR	O300.GI	FHDK 14	FHDK 14
								
miniature	miniature	miniature	miniature	miniature	miniature	miniature	standard	standard
for glass detection			line beam		line beam			
10,4 mm	12,4 mm	12,9 mm	12,9 mm	12,9 mm	12,9 mm	12,9 mm	14,8 mm	14,8 mm
10 ... 30 mm	15 ... 300 mm	30 ... 200 mm	30 ... 120 mm	30 ... 300 mm	30 ... 180 mm	30 ... 300 mm	20 ... 350 mm 30 ... 500 mm	40 ... 200 mm
< 1 ms	< 1 ms	< 0,49 ms	< 1,5 ms	< 1 ms	< 1,5 ms	< 0,49 ms	< 1 ms < 5 ms	< 0,5 ms
pulsed red LED	pulsed red LED	pulsed PinPoint LED	pulsed PinPoint LED	pulsed red LED	pulsed red LED	pulsed infrared diode	pulsed red LED	pulsed red LED
mechanical, 5 turn	mechanical, 5 turn	qTeach / external Teach-in and IO-Link qTeach qTeach / 1-Step Teach-in	Teach-in and IO-Link	qTeach qTeach / 1-Step Teach-in	qTeach	qTeach / external	mechanical, 10 turn	Teach-in
NPN PNP	NPN PNP	push-pull NPN PNP	push-pull	push-pull NPN PNP	push-pull	push-pull	NPN PNP	NPN PNP
connector	cable connector	cable connector flylead connector	cable connector	cable connector	cable connector	cable connector	cable connector	cable connector
plastic	metal	plastic	plastic	plastic	plastic	plastic	plastic	plastic
		 IO-Link	 IO-Link					
IP 67	IP 67	IP 67	IP 67	IP 67	IP 67	IP 67	IP 67	IP 67
<b>344</b>	<b>284</b>	<b>286</b>	<b>288</b>	<b>290</b>	<b>292</b>	<b>294</b>	<b>296</b>	<b>298</b>

## red light LED version

product family	FHDM 16	O500.GP	O500.GR	O500.GI	FHDK 20	OR18.GP	OR18.GR
							
version	standard	standard	standard	standard	standard	standard	standard
width / diameter	15,4 mm	18 mm	18 mm	18 mm	20 mm	18 mm	18 mm
sensing distance Tw	20 ... 450 mm 20 ... 600 mm	60 ... 400 mm	60 ... 550 mm	60 ... 550 mm	30 ... 200 mm	45 ... 200 mm	40 ... 120 mm
response time / release time	< 1 ms < 5 ms	< 0,49 ms	< 1 ms	< 0,49 ms	< 0,5 ms	< 0,49 ms	< 1 ms
light source	pulsed red LED	pulsed PinPoint LED	pulsed red LED	pulsed infrared diode	pulsed red LED	pulsed PinPoint LED	pulsed red LED
sensing distance adjustment	mechanical, 5 turn	qTeach / external Teach-in and IO-Link qTeach qTeach / 1-Step Teach-in	qTeach qTeach / 1-Step Teach-in	qTeach / external	Teach-in	qTeach / external qTeach	mechanical, 4 turn
output circuit	NPN PNP	push-pull NPN PNP	push-pull NPN PNP	push-pull	NPN PNP	push-pull NPN PNP	NPN PNP
connection types	cable connector	cable connector	cable connector	cable connector	connector	connector	connector
housing material	metal	plastic	plastic	plastic	plastic	metal	plastic
		 IO-Link					
protection class	IP 67	IP 67	IP 67	IP 67	IP 67	IP 67	IP 67
page	300	302	304	306	308	310	312

## OR18.GR.F



standard

fixed focus

18 mm

50 mm

< 0,5 ms

pulsed red LED

no

NPN  
PNP





cable  
flylead  
connector

plastic

IP 67

314

laser version

product family	OHDK 10	OHDK 10	OHDM 12	O300.GL	O300.GL	O300H.GL	O300W.GL
							
version	miniature	miniature	miniature	miniature	miniature	miniature	miniature
		line beam			line beam		
width / diameter	10,4 mm	10,4 mm	12,4 mm	12,9 mm	12,9 mm	16,5 mm	16,5 mm
sensing distance $T_w$	22 ... 130 mm	22 ... 130 mm	17 ... 120 mm	30 ... 250 mm	30 ... 120 mm	30 ... 250 mm	30 ... 250 mm
response time / release time	< 0,25 ms	< 0,25 ms		< 0,25 ms	< 1,5 ms	< 0,25 ms	< 0,25 ms
response time			< 1 ms				
release time			< 2,7 ms				
light source	pulsed red laser diode	pulsed red laser diode	pulsed red laser diode	pulsed red laser diode	pulsed red laser diode	pulsed red laser diode	pulsed red laser diode
sensing distance adjustment	mechanical, 5 turn	mechanical, 5 turn	Teach-in	Teach-in and IO-Link qTeach	Teach-in and IO-Link	Teach-in and IO-Link	Teach-in and IO-Link
output circuit	NPN PNP	NPN PNP	NPN PNP	push-pull NPN PNP	push-pull	push-pull	push-pull
connection types	cable connector	connector	connector	cable connector	cable connector	cable flylead connector	connector
housing material	plastic	plastic	metal	plastic	plastic	metal	metal
				 IO-Link	 IO-Link	 IO-Link	 IO-Link
protection class	IP 65 IP 67	IP 67	IP 67	IP 67	IP 67	IP 68/69K & proTect+	IP 68/69K & proTect+
page	316	318	320	322	324	326	328



OHDM 13	OHDK 14	OHDM 16	OHDM 16	OHDM 20	OHDK 25	OHDK 25
						
miniature	standard	standard	standard	standard	standard	standard
			wafer mapping sensor			
13,4 mm	14,8 mm	15,4 mm	15,4 mm	20,6 mm	23,4 mm	23,4 mm
50 ... 550 mm	20 ... 350 mm	25 ... 300 mm	123 ... 143 mm	210 ... 1500 mm	100 ... 900 mm	100 ... 1750 mm
	< 0,5 ms	< 0,1 ms < 0,6 ms	< 5 ms		< 10 ms	< 10 ms
< 5 ms				< 6 ms		
< 15 ms				< 18 ms		
pulsed red laser diode	pulsed red laser diode	pulsed red laser diode	pulsed red laser diode	pulsed red laser diode	pulsed red laser diode	pulsed red laser diode
Teach-in	mechanical, 9 turn	mechanical, 8 turn	no	Teach-in	Teach-in	Teach-in
NPN PNP	NPN PNP	NPN PNP	NPN PNP	PNP	push-pull	push-pull
connector	cable connector	cable connector	cable	connector	cable connector	cable connector
metal	plastic	metal	metal	metal	plastic	plastic
IP 67	IP 67	IP 67	IP 67	IP 67	IP 67	IP 67
<b>330</b>	<b>332</b>	<b>334</b>	<b>336</b>	<b>338</b>	<b>340</b>	<b>342</b>

## transparency detection

product family	FHDK 10
----------------	---------





version	for glass detection
width / diameter	10,4 mm
sensing distance $T_w$	10 ... 30 mm
response time / release time	< 1 ms
sensing distance adjustment	mechanical, 5 turn
output circuit	NPN PNP
connection types	connector
housing material	plastic
protection class	IP 67

page	344
------	-----



## stainless steel sensors in washdown or hygienic design

product family	O300W.GP	O300H.GP	FHDR 14	FHDH 14	O500H.GP	O500W.GP	O500W.GP (Retro)
							
	miniature	miniature	standard	standard	standard	standard	standard
width / diameter	16,5 mm	16,5 mm	19,6 mm	19,6 mm	20,2 mm	20,2 mm	20,2 mm
sensing distance $T_w$	30 ... 200 mm	30 ... 200 mm	50 ... 400 mm	50 ... 400 mm	60 ... 400 mm	60 ... 400 mm	60 ... 400 mm
response time / release time	< 0,49 ms	< 0,49 ms	< 1,8 ms	< 1,8 ms	< 0,49 ms	< 0,49 ms	< 0,49 ms
light source	pulsed PinPoint LED	pulsed PinPoint LED	pulsed red LED	pulsed red LED	pulsed PinPoint LED	pulsed PinPoint LED	pulsed PinPoint LED
sensitivity adjustment			IO-Link	IO-Link			
sensing distance adjustment	Teach-in and IO-Link	Teach-in and IO-Link	Teach-in	Teach-in	Teach-in and IO-Link	Teach-in and IO-Link	Teach-in and IO-Link
output circuit	push-pull	push-pull	push-pull	push-pull	push-pull	push-pull	push-pull
connection types	connector	cable flylead connector	connector	cable flylead connector	cable flylead connector	connector	connector
housing material	metal	metal	metal	metal	metal	metal	metal
	 IO-Link	 IO-Link	 IO-Link	 IO-Link	 IO-Link	 IO-Link	 IO-Link
protection class	IP 68/69K & proTect+	IP 68/69K & proTect+	IP 68/69K & proTect+	IP 68/69K & proTect+	IP 68/69K & proTect+	IP 68/69K & proTect+	IP 68/69K & proTect+
page	346	348	350	352	354	356	358

OR18W.GR



standard

18 mm

40 ... 120 mm

< 1 ms

pulsed red LED

mechanical, 4  
turn

NPN  
PNP

connector

metal

IP 67/69K

360



## General information

By using the triangulation principle, diffuse sensors with background suppression not only measure the light intensity reflected by the target, but also determine the distance of the object from the sensor. In this way, objects with the minimum size of the light beam located within the adjustable sensing distance can be detected regardless of their color and surface.

The diffuse sensors with background suppression and laser light source were developed specifically for applications in which exact positioning is important. With the precisely focused beam, even very small objects such as the wires of a resistor or threads can be clearly detected or counted.

## Applications

- Detection of boxes, metal and plastic parts lying on a base such as a conveyor belt, table or transport trolley from above
- Detection of bulk materials or other non-transparent materials in a container
- Counting of different-colored objects such as plastic bottles or printed packages
- Reliable presence monitoring of assembly parts, even with objects moving in the background

## Characteristics and advantages

### Adjustable sensing distance

The switching point can be adjusted accurately between the object and the interfering background using a set screw or Teach-in method

### Largely independent of color

The sensing distance remains constant even if the color of the objects changes. Readjustment is therefore unnecessary. Objects changing in the background also have no effect.

### Small spot size

Laser sensors can detect objects with a size of just 0,1 mm. Sensors with pinpoint diodes have a spot of only 2 mm diameter at the focus.

### Red light emitters

Visible red light permits simple adjustment of the sensor to small objects by eye.

### Short response time

Small, quickly moving objects are reliably detected due to the short response time.

## Technology and operation

The sensors are based on the triangulation principle. Only the angle of the light reflected back from the object determines the distance at which the sensor responds. The amount of reflected light is far less important.

The schematic sketch below shows that receiver R1 receives the light reflected back from the object T1 (acute angle of incidence) and receiver R2 the light reflected back from the background T2 (shallow angle of incidence). The transition from R1 to R2 determines the sensing distance.

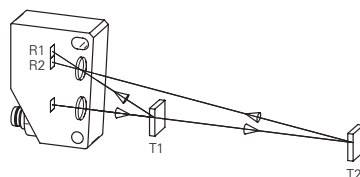



## Mounting and adjustment

The diffuse sensor must be aimed at the object. The sensing distance must be set to a distance between the target and the background. The background must be located behind the adjusted sensing distance by at least the distance of the sensing distance reduction of the sensor to black.

For diffuse sensors with background suppression, the sensing range diagram is specified for the optimum adjustment. This indicates the sensing range reduction as a function of the sensing range to white for different degrees of remission.

This means the distance by which the sensing distance to black or gray is reduced in comparison with white. When the adjusted sensing range to white is entered on the X axis of the diagram, the reduction of the sensing distance to black or gray can be read off on the Y axis. The sensing distance reduction also indicates the minimum distance a black or gray object must be separated from a white background.

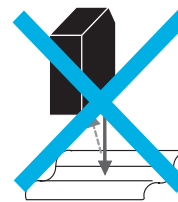
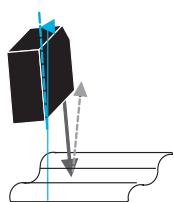
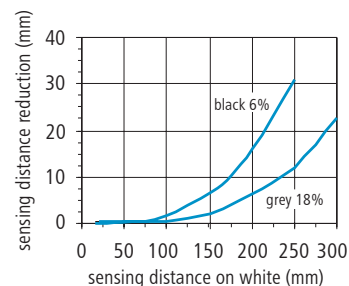

The direct reflection from glossy or reflective objects must not impinge on the receiver. This can be avoided by slightly tilting the sensor.

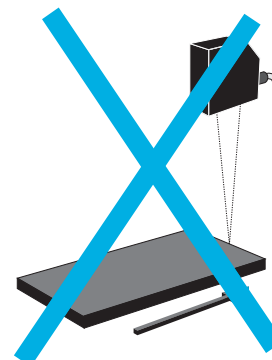
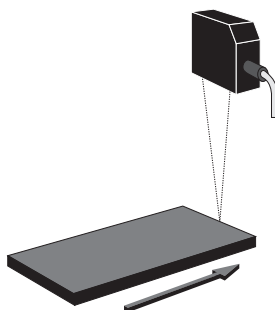

It should be ensured that the object to be detected approaches the active area of the sensor from the side, which avoids malfunctions caused by deflection of the light beam at edges.

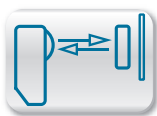

Tw = 50 mm



- compact housing
- small beam diameter
- push-pull output

**general data**

type	background suppression
light source	pulsed point source LED
alignment / soiled lens indicator	flashing light indicator
light indicator	LED yellow
wave length	660 nm
beam diameter	2 mm
suppression of reciprocal influence	yes

**electrical data**

response time / release time	< 0,5 ms
voltage supply range +Vs	11 ... 30 VDC
current consumption max. (no load)	30 mA
current consumption typ.	20 mA
voltage drop Vd	< 2 VDC
output circuit	push-pull
output current	< 50 mA
short circuit protection	yes
reverse polarity protection	yes, supply only

**mechanical data**

width / diameter	4 mm
height / length	44,8 mm
depth	6,2 mm
type	rectangular
housing material	plastic (ASA)
front (optics)	PMMA

**ambient conditions**

operating temperature	-10 ... +50 °C
protection class	IP 65

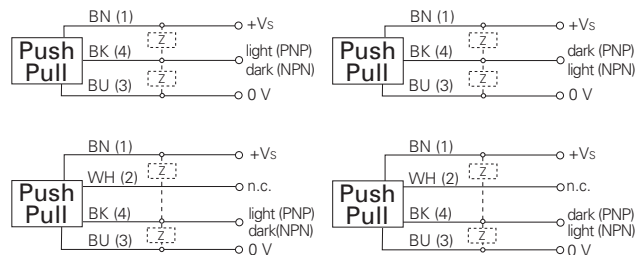
**connection diagrams****connectors and mating connectors**

ESG 32AH0200 Connector M8, 4 pin, straight, 2 m

ESW 31AH0200 Connector M8, 4 pin, angular, 2 m

additional cable connectors and field wireable connectors: see accessories

**Accessories**

10163196 Mounting brad FHDK 04

10163299 Bracket for profiles FHDK 04

for details: see accessories section

order reference	sensing distance Tw	connection types	output function
FHDK 04G6101	30 mm ±2 mm	cable 3 pin, 2 m	light operate
FHDK 04G6101/KS35A	30 mm ±2 mm	flylead connector M8 4 pin, L=200 mm	light operate
FHDK 04G6102	50 mm ±3 mm	cable 3 pin, 2 m	light operate
FHDK 04G6102/KS35A	50 mm ±3 mm	flylead connector M8 4 pin, L=200 mm	light operate
FHDK 04G6111	30 mm ±2 mm	cable 3 pin, 2 m	dark operate
FHDK 04G6111/KS35A	30 mm ±2 mm	flylead connector M8 4 pin, L=200 mm	dark operate
FHDK 04G6112	50 mm ±3 mm	cable 3 pin, 2 m	dark operate
FHDK 04G6112/KS35A	50 mm ±3 mm	flylead connector M8 4 pin, L=200 mm	dark operate



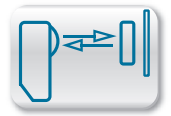

## sensing distance diagrams

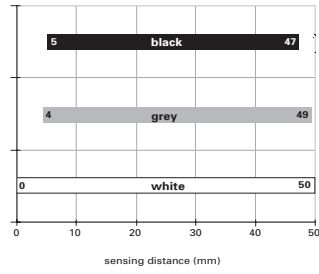

## dimension drawings

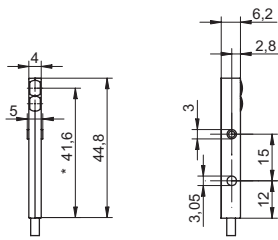

\* emitter axis

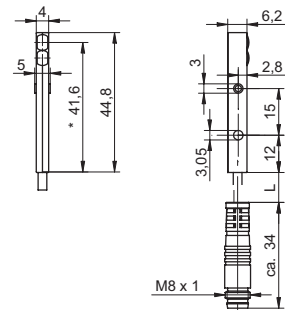

\* emitter axis cable length L = 200 mm

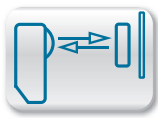

$T_w = 10 \dots 60 \text{ mm}$



- compact housing
- sensing distance adjustable via Teach-in
- suppression of mutual optical interference

#### general data

type	background suppression
light source	pulsed red LED
sensing distance $T_w$	10 ... 60 mm
sensing range $T_b$ (at $T_w$ max.)	2 ... 60 mm
sensing range $T_b$ (at $T_w$ min.)	5 ... 10 mm
alignment / soiled lens indicator	flashing light indicator
light indicator	LED green
output indicator	LED yellow
sensing distance adjustment	Teach-in
wave length	660 nm
suppression of reciprocal influence	yes

#### electrical data

response time / release time	< 0,5 ms
voltage supply range +Vs	10 ... 30 VDC
current consumption max. (no load)	25 mA
current consumption typ.	20 mA
voltage drop $V_d$	< 1,8 VDC
output function	light / dark operate
output current	< 100 mA
short circuit protection	yes
reverse polarity protection	yes

#### mechanical data

width / diameter	8 mm
height / length	16,2 mm
depth	10,8 mm
type	rectangular
housing material	plastic (PMMA, MABS, PA)
front (optics)	PMMA

#### ambient conditions

operating temperature	-20 ... +50 °C
protection class	IP 65

#### connection diagrams



#### connectors and mating connectors

ESG 32AH0200	Connector M8, 4 pin, straight, 2 m
ESW 31AH0200	Connector M8, 4 pin, angular, 2 m

additional cable connectors and field wireable connectors: see accessories

#### Accessories

10150844	Minofix mounting 07
----------	---------------------

for details: see accessories section

order reference	connection types	output circuit
FHCK 07N6901	cable rear side, 2 m	NPN
FHCK 07N6901/KS35A	flylead connector M8 4 pin, L=200 mm	NPN
FHCK 07P6901	cable rear side, 2 m	PNP
FHCK 07P6901/KS35A	flylead connector M8 4 pin, L=200 mm	PNP

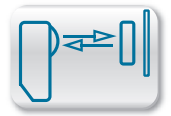

sensing distance diagram

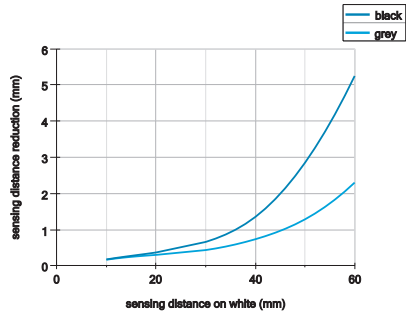

dimension drawings

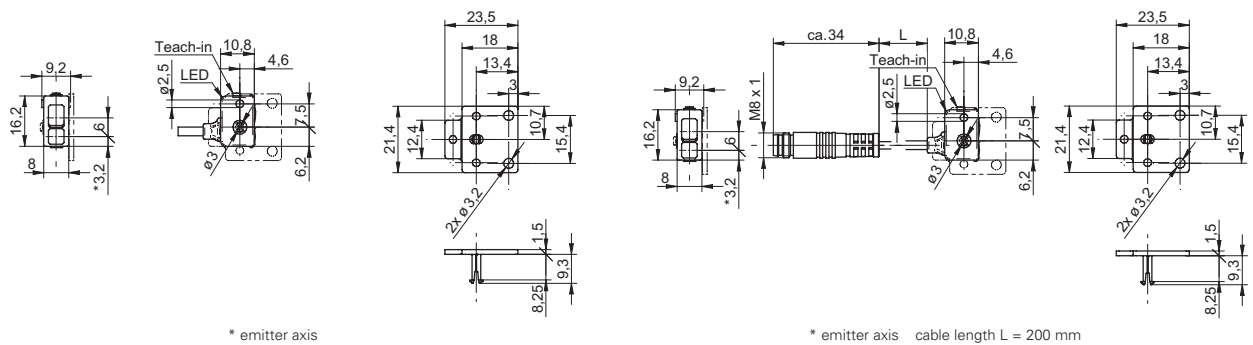

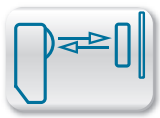

$T_w = 10 \dots 60 \text{ mm}$



- compact housing
- sensing distance adjustable via Teach-in
- suppression of mutual optical interference

#### general data

type	background suppression
light source	pulsed red LED
sensing distance $T_w$	10 ... 60 mm
sensing range $T_b$ (at $T_w$ max.)	2 ... 60 mm
sensing range $T_b$ (at $T_w$ min.)	5 ... 10 mm
alignment / soiled lens indicator	flashing light indicator
light indicator	LED green
output indicator	LED yellow
sensing distance adjustment	Teach-in
wave length	660 nm
suppression of reciprocal influence	yes

#### electrical data

response time / release time	< 0,5 ms
voltage supply range +Vs	10 ... 30 VDC
current consumption max. (no load)	25 mA
current consumption typ.	20 mA
voltage drop $V_d$	< 1,8 VDC
output function	light / dark operate
output current	< 100 mA
short circuit protection	yes
reverse polarity protection	yes

#### mechanical data

width / diameter	8 mm
height / length	16,2 mm
depth	10,8 mm
type	rectangular
housing material	plastic (PMMA, MABS, PA)
front (optics)	PMMA

#### ambient conditions

operating temperature	-20 ... +50 °C
protection class	IP 65

#### connection diagrams



#### connectors and mating connectors

ESG 32AH0200	Connector M8, 4 pin, straight, 2 m
ESW 31AH0200	Connector M8, 4 pin, angular, 2 m

additional cable connectors and field wireable connectors: see accessories

#### Accessories

10150844	Minofix mounting 07
----------	---------------------

for details: see accessories section

order reference	connection types	output circuit
FHDK 07N6901	cable bottom side, 2 m	NPN
FHDK 07N6901/KS35A	flylead connector M8 4 pin, L=200 mm	NPN
FHDK 07P6901	cable bottom side, 2 m	PNP
FHDK 07P6901/KS35A	flylead connector M8 4 pin, L=200 mm	PNP



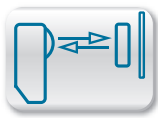

Tw = 80 mm

- compact housing
- fixed sensing distance
- push-pull output

**general data**

type	background suppression
light source	pulsed red LED
alignment / soiled lens indicator	flashing light indicator
light indicator	LED yellow
wave length	660 nm
suppression of reciprocal influence	yes

**electrical data**

response time / release time	< 1 ms
voltage supply range +Vs	10 ... 30 VDC
current consumption max. (no load)	25 mA
current consumption typ.	18 mA
voltage drop Vd	< 1,8 VDC
output function	light / dark operate
output circuit	push-pull
output current	< 50 mA
short circuit protection	yes
reverse polarity protection	yes

**mechanical data**

width / diameter	10,4 mm
height / length	27 mm
depth	14,7 mm
type	rectangular
housing material	plastic (ASA)
front (optics)	PMMA

**ambient conditions**

operating temperature	-25 ... +65 °C
-----------------------	----------------

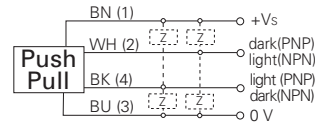
**connection diagram****connectors and mating connectors**

ESG 32AH0200	Connector M8, 4 pin, straight, 2 m
ESW 31AH0200	Connector M8, 4 pin, angular, 2 m

additional cable connectors and field wireable connectors: see accessories

**Accessories**

10150326	Sensofix series 10 / series 20
10114501	Mounting bracket series 10 (U design)
10133792	Mounting bracket series 10 (L design)
10162083	Mounting panel for sensors series 10
10118798	Mounting bracket series 10

for details: see accessories section

order reference	sensing distance Tw	connection types	protection class
FHDK 10G5120	30 mm ±2 mm	cable 4 pin, 2 m	IP 65
FHDK 10G5120/S35A	30 mm ±2 mm	connector M8 4 pin	IP 67
FHDK 10G5121	50 mm ±3 mm	cable 4 pin, 2 m	IP 65
FHDK 10G5121/S35A	50 mm ±3 mm	connector M8 4 pin	IP 67
FHDK 10G5122	80 mm ±8 mm	cable 4 pin, 2 m	IP 65
FHDK 10G5122/S35A	80 mm ±8 mm	connector M8 4 pin	IP 67

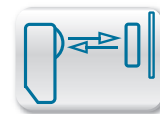

## sensing distance diagrams

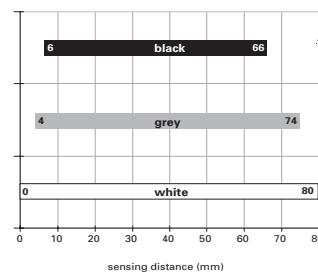
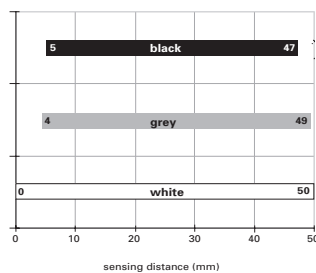

## dimension drawings

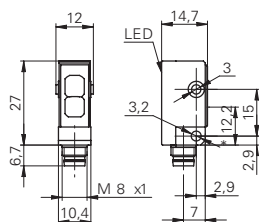

\* emitter axis

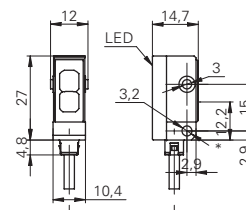

\* emitter axis

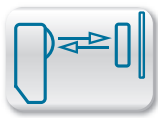

$T_w = 20 \dots 120 \text{ mm}$

- compact housing
- large sensing range
- sensing distance adjustable via potentiometer

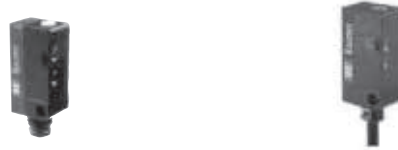

#### general data

type	background suppression
light source	pulsed red LED
sensing distance $T_w$	20 ... 120 mm
sensing range $T_b$ (at $T_w$ max.)	5 ... 120 mm
sensing range $T_b$ (at $T_w$ min.)	5 ... 20 mm
alignment / soiled lens indicator	flashing light indicator
light indicator	LED yellow
sensing distance adjustment	mechanical, 5 turn
distance to focus	35 ... 45 mm
wave length	660 nm
beam diameter	4 mm at focus
suppression of reciprocal influence	yes

#### electrical data

response time / release time	< 1 ms
voltage supply range +Vs	10 ... 30 VDC
current consumption max. (no load)	30 mA
current consumption typ.	20 mA
voltage drop $V_d$	< 1,8 VDC
output current	< 100 mA
short circuit protection	yes
reverse polarity protection	yes

#### mechanical data

width / diameter	10,4 mm
height / length	27 mm
depth	14 mm
type	rectangular
housing material	plastic (ASA)
front (optics)	PMMA

#### ambient conditions

operating temperature	-25 ... +65 °C
-----------------------	----------------

#### connection diagrams

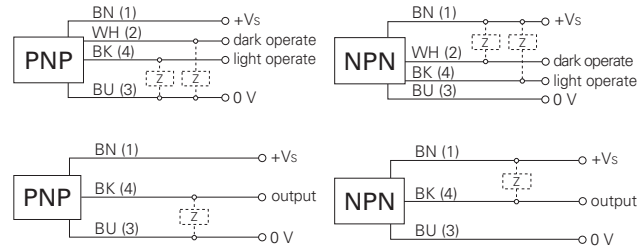

#### connectors and mating connectors

ESG 32SH0200	Connector M8, 3 pin, straight, 2 m
ESW 31SH0200	Connector M8, 3 pin, angular, 2 m
ESG 32AH0200	Connector M8, 4 pin, straight, 2 m
ESW 31AH0200	Connector M8, 4 pin, angular, 2 m

additional cable connectors and field wireable connectors: see accessories

#### Accessories

10150326	Sensofix series 10 / series 20
10114501	Mounting bracket series 10 (U design)
10133792	Mounting bracket series 10 (L design)
10162083	Mounting panel for sensors series 10
10118798	Mounting bracket series 10

for details: see accessories section

order reference	connection types	output circuit	output function	protection class
FHDK 10N1101/KS35	flylead connector M8 3 pin	NPN	light operate	IP 65
FHDK 10N5101	cable 4 pin, 2 m	NPN	light / dark operate	IP 65
FHDK 10N5101/S35A	connector M8 4 pin	NPN	light / dark operate	IP 67
FHDK 10P1101/KS35	flylead connector M8 3 pin	PNP	light operate	IP 65
FHDK 10P5101	cable 4 pin, 2 m	PNP	light / dark operate	IP 65
FHDK 10P5101/S35A	connector M8 4 pin	PNP	light / dark operate	IP 67



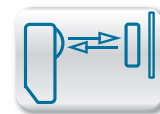

## sensing distance diagram

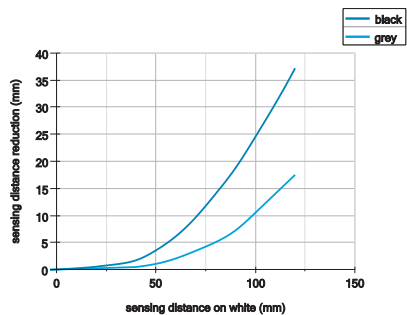

## dimension drawings

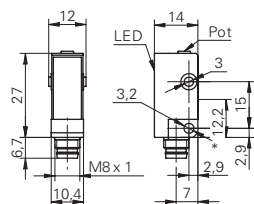

\* emitter axis

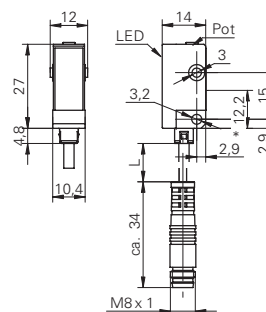

\* emitter axis cable length L = 200 mm

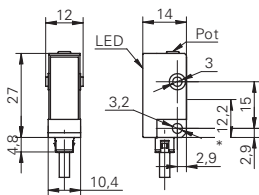

\* emitter axis

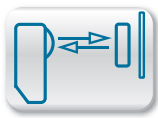

$T_w = 20 \dots 120 \text{ mm}$

- compact housing
- small beam diameter
- sensing distance adjustable via potentiometer



#### general data

type	background suppression
version	point source LED
light source	pulsed point source LED
sensing distance $T_w$	25 ... 120 mm
sensing range $T_b$ (at $T_w$ max.)	5 ... 120 mm
sensing range $T_b$ (at $T_w$ min.)	5 ... 25 mm
alignment / soiled lens indicator	flashing light indicator
light indicator	LED yellow
sensing distance adjustment	mechanical, 5 turn
distance to focus	35 ... 45 mm
wave length	660 nm
beam diameter	2 mm at focus
suppression of reciprocal influence	yes

#### electrical data

response time / release time	< 1 ms
voltage supply range +Vs	10 ... 30 VDC
current consumption max. (no load)	30 mA
current consumption typ.	20 mA
voltage drop $V_d$	< 1,8 VDC
output function	light / dark operate
output current	< 100 mA
short circuit protection	yes
reverse polarity protection	yes

#### mechanical data

width / diameter	10,4 mm
height / length	27 mm
depth	14 mm
type	rectangular
housing material	plastic (ASA)
front (optics)	PMMA

#### ambient conditions

operating temperature	-25 ... +65 °C
-----------------------	----------------

#### connection diagrams



#### connectors and mating connectors

ESG 32AH0200	Connector M8, 4 pin, straight, 2 m
ESW 31AH0200	Connector M8, 4 pin, angular, 2 m

additional cable connectors and field wireable connectors: see accessories

#### Accessories

10150326	Sensofix series 10 / series 20
10114501	Mounting bracket series 10 (U design)
10133792	Mounting bracket series 10 (L design)
10162083	Mounting panel for sensors series 10
10118798	Mounting bracket series 10

for details: see accessories section

order reference	connection types	output circuit	protection class
<b>FHDK 10N5110</b>	cable 4 pin, 2 m	NPN	IP 65
<b>FHDK 10N5110/S35A</b>	connector M8 4 pin	NPN	IP 67
<b>FHDK 10P5110</b>	cable 4 pin, 2 m	PNP	IP 65
<b>FHDK 10P5110/S35A</b>	connector M8 4 pin	PNP	IP 67

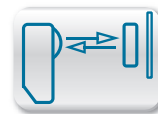

## sensing distance diagram

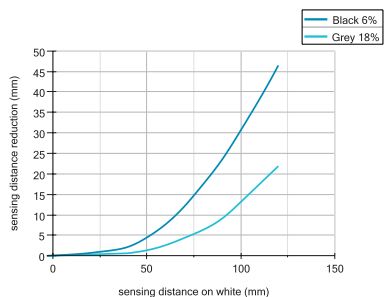

## dimension drawings

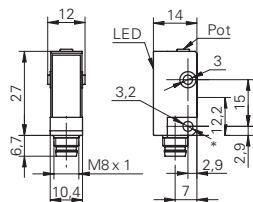

\* emitter axis

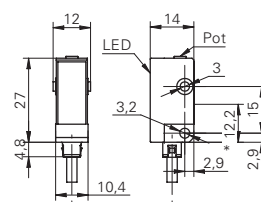

\* emitter axis cable length L = 200 mm

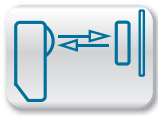

$T_w = 20 \dots 80 \text{ mm}$

- compact housing
- with line beam
- sensing distance adjustable via potentiometer



#### general data

type	background suppression
version	line beam
light source	pulsed red LED
sensing distance $T_w$	20 ... 80 mm
sensing range $T_b$ (at $T_w$ max.)	5 ... 80 mm
sensing range $T_b$ (at $T_w$ min.)	5 ... 20 mm
alignment / soiled lens indicator	flashing light indicator
light indicator	LED yellow
sensing distance adjustment	mechanical, 5 turn
wave length	660 nm
suppression of reciprocal influence	yes

#### electrical data

response time / release time	< 1 ms
voltage supply range +Vs	10 ... 30 VDC
current consumption max. (no load)	30 mA
current consumption typ.	20 mA
voltage drop Vd	< 1,8 VDC
output function	light / dark operate
output current	< 100 mA
short circuit protection	yes
reverse polarity protection	yes

#### mechanical data

width / diameter	10,4 mm
height / length	27 mm
depth	14 mm
type	rectangular
housing material	plastic (ASA)
front (optics)	PMMA

#### ambient conditions

operating temperature	-25 ... +65 °C
-----------------------	----------------

#### connection diagrams



#### connectors and mating connectors

ESG 32AH0200	Connector M8, 4 pin, straight, 2 m
ESW 31AH0200	Connector M8, 4 pin, angular, 2 m

additional cable connectors and field wireable connectors: see accessories

#### Accessories

10150326	Sensofix series 10 / series 20
10114501	Mounting bracket series 10 (U design)
10133792	Mounting bracket series 10 (L design)
10162083	Mounting panel for sensors series 10
10118798	Mounting bracket series 10

for details: see accessories section

order reference	connection types	output circuit	protection class
FHDK 10N5150	cable 4 pin, 2 m	NPN	IP 65
FHDK 10N5150/S35A	connector M8 4 pin	NPN	IP 67
FHDK 10P5150	cable 4 pin, 2 m	PNP	IP 65
FHDK 10P5150/S35A	connector M8 4 pin	PNP	IP 67

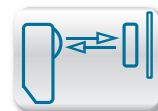

## sensing distance diagram

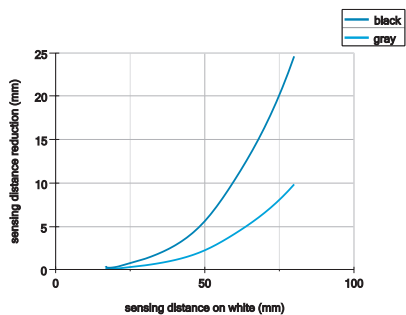

## beam characteristic (typically)

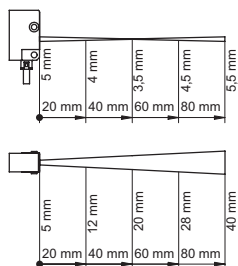

## dimension drawings

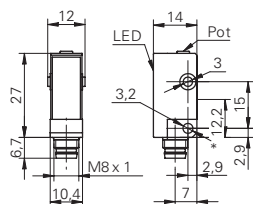

\* emitter axis

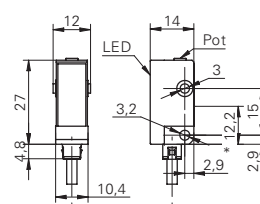

\* emitter axis

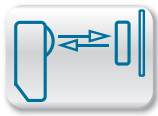

Tw = 15 ... 300 mm

- rugged miniature metal housing
- sensing distance adjustable via potentiometer
- suppression of mutual optical interference



**general data**

type	background suppression
light source	pulsed red LED
sensing distance Tw	15 ... 300 mm
sensing range Tb (at Tw max.)	15 ... 300 mm
sensing range Tb (at Tw min.)	5 ... 15 mm
light indicator	LED yellow
sensing distance adjustment	mechanical, 5 turn
wave length	660 nm
suppression of reciprocal influence	yes

**electrical data**

response time / release time	< 1 ms
voltage supply range +Vs	10 ... 30 VDC
current consumption max. (no load)	35 mA
current consumption typ.	25 mA
voltage drop Vd	< 1,8 VDC
output function	light / dark operate
output current	< 100 mA
short circuit protection	yes
reverse polarity protection	yes

**mechanical data**

width / diameter	12,4 mm
height / length	35 mm
depth	35 mm
type	rectangular
housing material	die-cast zinc
front (optics)	PMMA

**ambient conditions**

operating temperature	-25 ... +65 °C
protection class	IP 67

**connection diagrams**



**connectors and mating connectors**

ESG 32AH0200	Connector M8, 4 pin, straight, 2 m
ESW 31AH0200	Connector M8, 4 pin, angular, 2 m

additional cable connectors and field wireable connectors: see accessories

**Accessories**

10150328	Sensofix series 12
10113873	Mounting bracket series 12 (L design)

for details: see accessories section

**order reference**

order reference	connection types	output circuit
FHDM 12N5001	cable 4 pin, 2 m	NPN
FHDM 12N5001/S35A	connector M8 4 pin	NPN
FHDM 12P5001	cable 4 pin, 2 m	PNP
FHDM 12P5001/S35A	connector M8 4 pin	PNP

Diffuse sensors with background suppression FHDM 12 Tw = 15 ... 300 mm

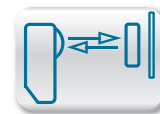

## sensing distance diagram

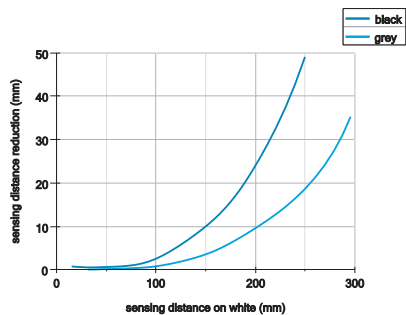

## dimension drawings

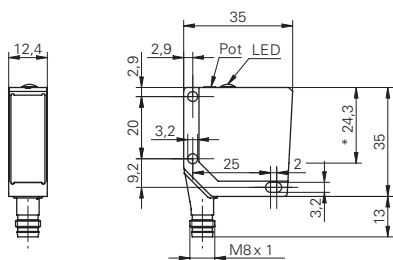

\* emitter axis

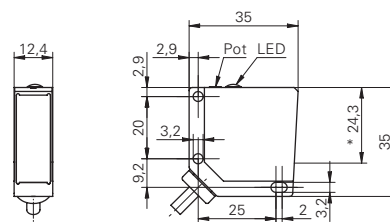

\* emitter axis

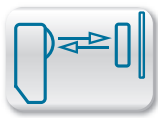

Tw = 200 mm

IO-Link

- One inch class
- PinPoint LED
- small beam diameter



### general data

type	background suppression
light source	pulsed PinPoint LED
sensing distance Tw	30 ... 200 mm
sensing range Tb	15 ... 200 mm
power on indication	LED green
light indicator	LED yellow
wave length	630 nm
suppression of reciprocal influence	yes
alignment optical axis	< 2°

### electrical data

response time / release time	< 0,49 ms
voltage supply range +Vs	10 ... 30 VDC
current consumption max. (no load)	45 mA
current consumption typ.	30 mA
voltage drop Vd	< 3 VDC
output function	light / dark operate
output current	< 100 mA
short circuit protection	yes
reverse polarity protection	yes

### mechanical data

width / diameter	12,9 mm
height / length	32,3 mm
depth	23 mm
type	rectangular
housing material	plastic (ASA, PMMA)
front (optics)	PMMA

### ambient conditions

operating temperature	-25 ... +60 °C
protection class	IP 67

### connection diagrams

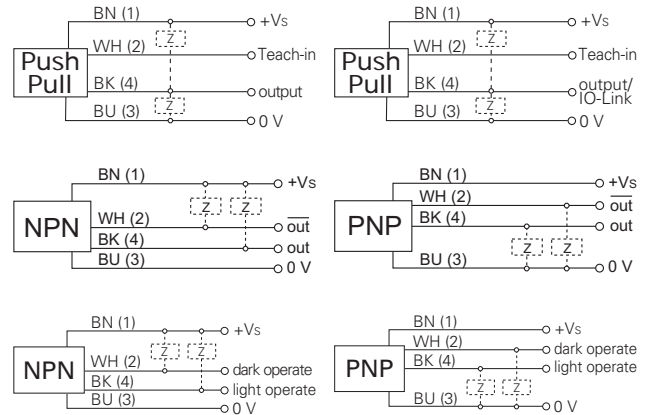

### connectors and mating connectors

ESG 32AH0200	Connector M8, 4 pin, straight, 2 m
ESW 31AH0200	Connector M8, 4 pin, angular, 2 m
ESG 34AH0200	Connector M12, 4 pin, straight, 2 m
ESW 33AH0200	Connector M12, 4 pin, angular, 2 m

additional cable connectors and field wireable connectors: see accessories

### Accessories

11104963	Sensofix O300
11102423	Mounting bracket O300 (L design)
11124807	Mounting bracket O300 - Retrofit for sensors series 20

for details: see accessories section

order reference	connection types	output circuit	sensing distance adjustment
O300.GP-11120101	cable 4 pin, 2 m	push-pull	qTeach / external
O300.GP-11110415	connector M8 4 pin	push-pull	qTeach / external
O300.GP-11143644	flylead connector M8, L=200 mm	push-pull	qTeach / external
O300.GP-11125058	cable 4 pin, 2 m	push-pull	Teach-in and IO-Link
O300.GP-11125023	connector M8 4 pin	push-pull	Teach-in and IO-Link
O300.GP-11120103	cable 4 pin, 2 m	NPN complementary	qTeach
O300.GP-11135827	cable 4 pin, 2 m	NPN complementary	qTeach / 1-Step Teach-in
O300.GP-11135828	connector M8 4 pin	NPN complementary	qTeach / 1-Step Teach-in
O300.GP-11110442	connector M8 4 pin	NPN complementary	qTeach
O300.GP-11120104	cable 4 pin, 2 m	PNP complementary	qTeach
O300.GP-11135829	cable 4 pin, 2 m	PNP complementary	qTeach / 1-Step Teach-in
O300.GP-11135850	connector M8 4 pin	PNP complementary	qTeach / 1-Step Teach-in
O300.GP-11110441	connector M8 4 pin	PNP complementary	qTeach
O300.GP-11147416	flylead connector M12, L=200 mm	PNP complementary	qTeach



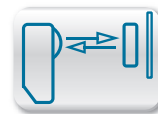

## sensing distance diagrams

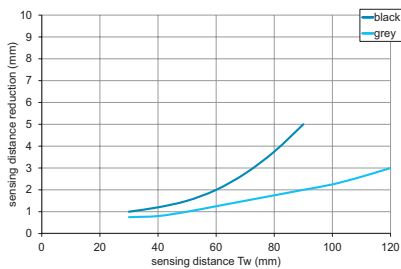
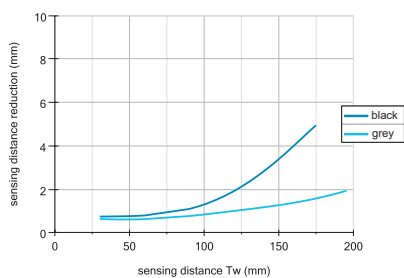

## beam characteristic (typically)

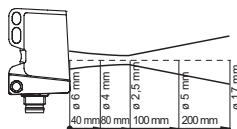

## dimension drawings

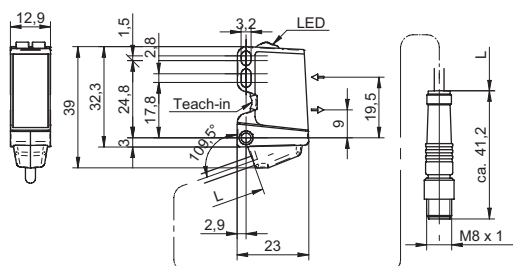
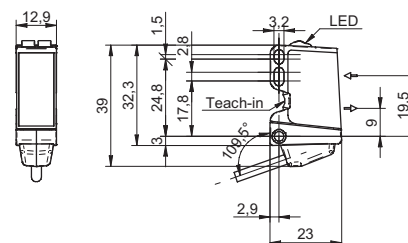
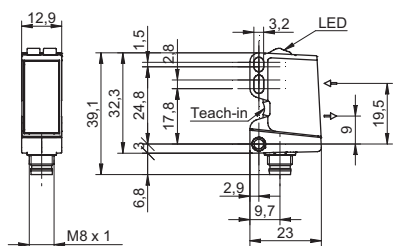

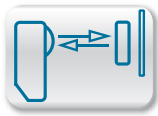

Tw = 120 mm

- One inch class
- PinPoint LED
- line 5 x 67 mm

**general data**

type	background suppression
version	line beam
light source	pulsed PinPoint LED
sensing distance Tw	30 ... 120 mm
sensing range Tb	15 ... 120 mm
power on indication	LED green
light indicator	LED yellow
sensing distance adjustment	Teach-in and IO-Link
wave length	630 nm
suppression of reciprocal influence	yes
beam type	line
alignment optical axis	< 2°

**electrical data**

response time / release time	< 1,5 ms
voltage supply range +Vs	10 ... 30 VDC
current consumption max. (no load)	45 mA
current consumption typ.	30 mA
voltage drop Vd	< 3 VDC
output function	light / dark operate
output circuit	push-pull
output current	< 100 mA
short circuit protection	yes
reverse polarity protection	yes

**mechanical data**

width / diameter	12,9 mm
height / length	32,3 mm
depth	23 mm
type	rectangular
housing material	plastic (ASA, PMMA)
front (optics)	PMMA

**ambient conditions**

operating temperature	-25 ... +60 °C
protection class	IP 67

**order reference**

<b>O300.GP-11199038</b>	cable 4 pin, 2 m
<b>O300.GP-11199039</b>	connector M8 4 pin

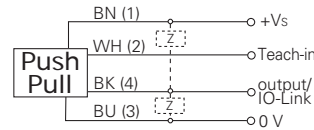
**connection types****connection diagram****connectors and mating connectors**

ESG 32AH0200	Connector M8, 4 pin, straight, 2 m
ESW 31AH0200	Connector M8, 4 pin, angular, 2 m

additional cable connectors and field wireable connectors: see accessories

**Accessories**

11104963	Sensofix O300
11102423	Mounting bracket O300 (L design)
11124807	Mounting bracket O300 - Retrofit for sensors series 20

for details: see accessories section

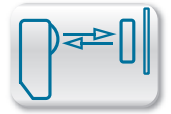

## sensing distance diagram

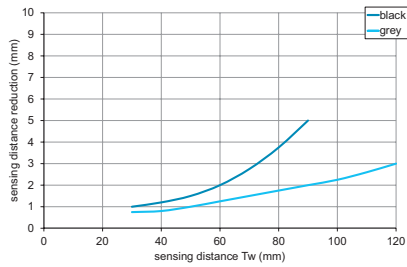

## beam characteristic (typically)

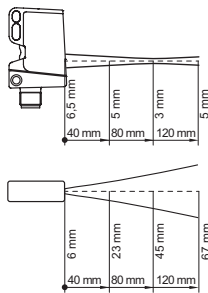

## dimension drawings

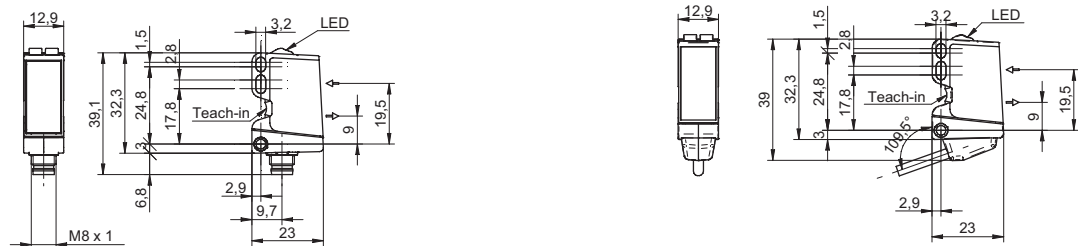

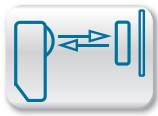

Tw = 300 mm

- One inch class
- qTeach



**general data**

type	background suppression
light source	pulsed red LED
sensing distance Tw	30 ... 300 mm
sensing range Tb	15 ... 300 mm
power on indication	LED green
light indicator	LED yellow
wave length	630 nm
suppression of reciprocal influence	yes
alignment optical axis	< 2°

**electrical data**

response time / release time	< 1 ms
voltage supply range +Vs	10 ... 30 VDC
current consumption max. (no load)	45 mA
current consumption typ.	30 mA
voltage drop Vd	< 3 VDC
output function	light / dark operate
output current	< 100 mA
short circuit protection	yes
reverse polarity protection	yes

**mechanical data**

width / diameter	12,9 mm
height / length	32,3 mm
depth	23 mm
type	rectangular
housing material	plastic (ASA, PMMA)
front (optics)	PMMA

**ambient conditions**

operating temperature	-25 ... +60 °C
protection class	IP 67

**connection diagrams**

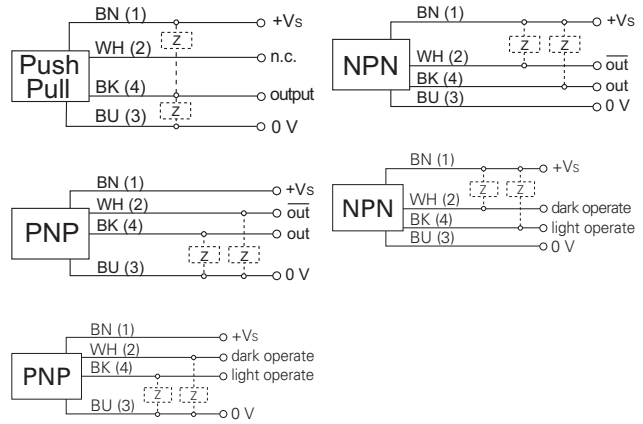

**connectors and mating connectors**

ESG 32AH0200	Connector M8, 4 pin, straight, 2 m
ESW 31AH0200	Connector M8, 4 pin, angular, 2 m

additional cable connectors and field wireable connectors: see accessories

**Accessories**

11104963	Sensofix O300
11102423	Mounting bracket O300 (L design)
11124807	Mounting bracket O300 - Retrofit for sensors series 20

for details: see accessories section

order reference	connection types	output circuit	sensing distance adjustment
O300.GR-11120106	cable 4 pin, 2 m	push-pull	qTeach
O300.GR-11110414	connector M8 4 pin	push-pull	qTeach
O300.GR-11135876	cable 4 pin, 2 m	NPN complementary	qTeach
O300.GR-11135882	cable 4 pin, 2 m	NPN complementary	qTeach / 1-Step Teach-in
O300.GR-11128552	connector M8 4 pin	NPN complementary	qTeach / 1-Step Teach-in
O300.GR-11135879	connector M8 4 pin	NPN complementary	qTeach
O300.GR-11135880	cable 4 pin, 2 m	PNP complementary	qTeach
O300.GR-11135883	cable 4 pin, 2 m	PNP complementary	qTeach / 1-Step Teach-in
O300.GR-11135885	connector M8 4 pin	PNP complementary	qTeach / 1-Step Teach-in
O300.GR-11135881	connector M8 4 pin	PNP complementary	qTeach

O300.GR Tw = 300 mm Diffuse sensors with background suppression

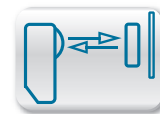

## sensing distance diagrams

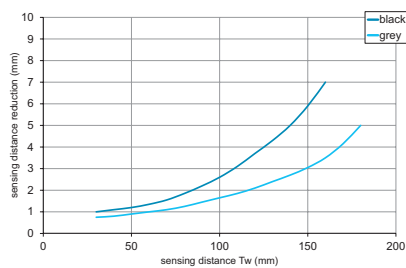
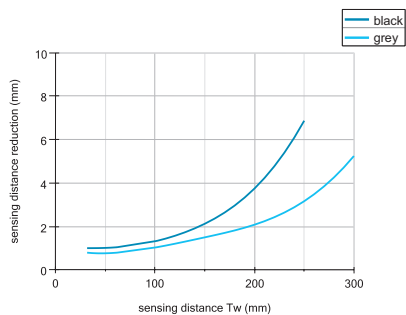

## beam characteristic (typically)

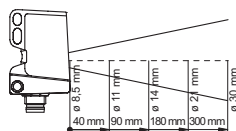

## dimension drawings

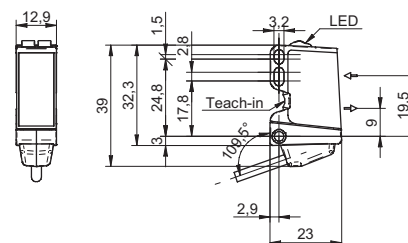
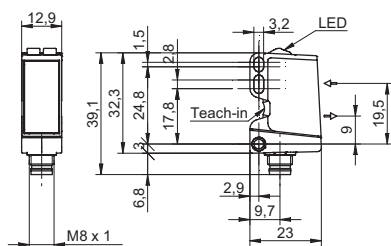

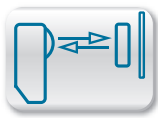

Tw = 180 mm

- One inch class
- red light LED
- line 21 x 100 mm

**general data**

type	background suppression
version	line beam
light source	pulsed red LED
sensing distance Tw	30 ... 180 mm
sensing range Tb	15 ... 180 mm
power on indication	LED green
light indicator	LED yellow
sensing distance adjustment	qTeach
wave length	630 nm
suppression of reciprocal influence	yes
beam type	line
alignment optical axis	< 2°

**electrical data**

response time / release time	< 1,5 ms
voltage supply range +Vs	10 ... 30 VDC
current consumption max. (no load)	45 mA
current consumption typ.	30 mA
voltage drop Vd	< 3 VDC
output function	light / dark operate
output circuit	push-pull
output current	< 100 mA
short circuit protection	yes
reverse polarity protection	yes

**mechanical data**

width / diameter	12,9 mm
height / length	32,3 mm
depth	23 mm
type	rectangular
housing material	plastic (ASA, PMMA)
front (optics)	PMMA

**ambient conditions**

operating temperature	-25 ... +60 °C
protection class	IP 67

**order reference**

<b>O300.GR-11199071</b>	cable 4 pin, 2 m
<b>O300.GR-11199072</b>	connector M8 4 pin

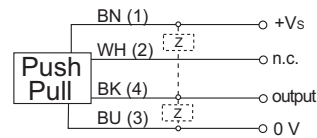
**connection types****connection diagram****connectors and mating connectors**

ESG 32AH0200	Connector M8, 4 pin, straight, 2 m
ESW 31AH0200	Connector M8, 4 pin, angular, 2 m
additional cable connectors and field wireable connectors: see accessories	

**Accessories**

11104963	Sensofix O300
11102423	Mounting bracket O300 (L design)
11124807	Mounting bracket O300 - Retrofit for sensors series 20

for details: see accessories section

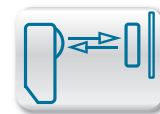

## sensing distance diagram

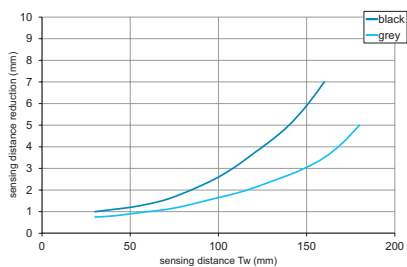

## beam characteristic (typically)

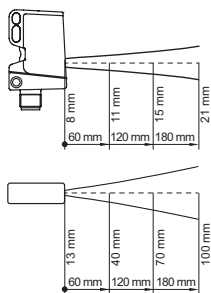

## dimension drawings



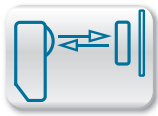

Tw = 300 mm

- One inch class
- infrared LED
- short response time

**general data**

type	background suppression
light source	pulsed infrared diode
sensing distance Tw	30 ... 300 mm
sensing range Tb	15 ... 300 mm
power on indication	LED green
light indicator	LED yellow
sensing distance adjustment	qTeach / external
wave length	860 nm
suppression of reciprocal influence	yes
alignment optical axis	< 2°

**electrical data**

response time / release time	< 0,49 ms
voltage supply range +Vs	10 ... 30 VDC
current consumption max. (no load)	45 mA
current consumption typ.	30 mA
voltage drop Vd	< 3 VDC
output function	light / dark operate
output circuit	push-pull
output current	< 100 mA
short circuit protection	yes
reverse polarity protection	yes

**mechanical data**

width / diameter	12,9 mm
height / length	32,3 mm
depth	23 mm
type	rectangular
housing material	plastic (ASA, PMMA)
front (optics)	PMMA

**ambient conditions**

operating temperature	-25 ... +60 °C
protection class	IP 67

**order reference**

order reference	connection types
O300.GI-11128081	cable 4 pin, 2 m
O300.GI-11121712	connector M8 4 pin

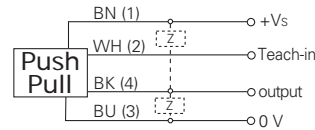
**connection diagram****connectors and mating connectors**

ESG 32AH0200	Connector M8, 4 pin, straight, 2 m
ESW 31AH0200	Connector M8, 4 pin, angular, 2 m

additional cable connectors and field wireable connectors: see accessories

**Accessories**

11104963	Sensofix O300
11102423	Mounting bracket O300 (L design)
11124807	Mounting bracket O300 - Retrofit for sensors series 20

for details: see accessories section



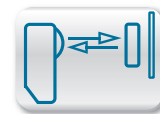

## sensing distance diagram

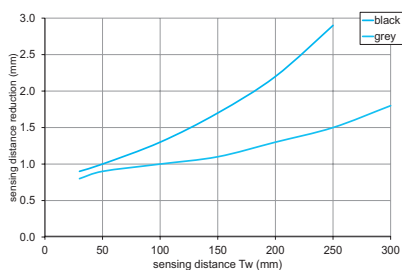

## beam characteristic (typically)

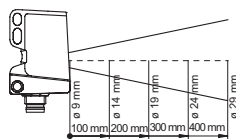

## dimension drawings

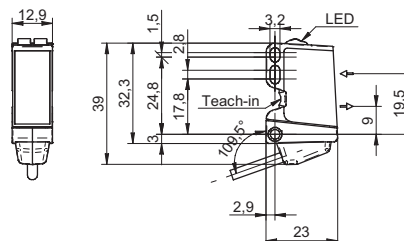
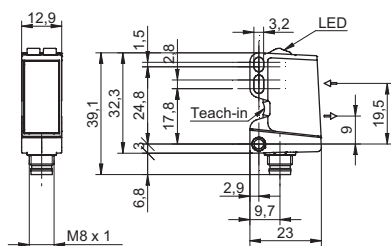

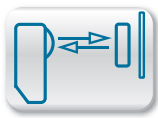

$T_w = 20 \dots 500 \text{ mm}$

- long range
- sensing distance adjustable via potentiometer
- suppression of mutual optical interference



#### general data

type	background suppression
light source	pulsed red LED
alignment / soiled lens indicator	flashing light indicator
light indicator	LED yellow
sensing distance adjustment	mechanical, 10 turn
wave length	660 nm
suppression of reciprocal influence	yes

#### sensing distance $T_w = 20 \dots 350 \text{ mm}$

sensing range $T_b$ (at $T_w$ max.)	20 ... 350 mm
sensing range $T_b$ (at $T_w$ min.)	5 ... 20 mm

#### sensing distance $T_w = 30 \dots 500 \text{ mm}$

sensing range $T_b$ (at $T_w$ max.)	30 ... 500 mm
sensing range $T_b$ (at $T_w$ min.)	5 ... 30 mm

#### electrical data

voltage supply range +Vs	10 ... 30 VDC
current consumption max. (no load)	30 mA
current consumption typ.	25 mA
voltage drop $V_d$	< 1,8 VDC
output function	light / dark operate
output current	< 100 mA
short circuit protection	yes
reverse polarity protection	yes

#### mechanical data

width / diameter	14,8 mm
height / length	43 mm
type	rectangular
housing material	plastic (ASA, MABS)
front (optics)	PMMA

#### ambient conditions

operating temperature	-25 ... +65 °C
protection class	IP 67

#### connection diagrams



#### connectors and mating connectors

ESG 34AH0200	Connector M12, 4 pin, straight, 2 m
ESW 33AH0200	Connector M12, 4 pin, angular, 2 m
ESG 32AH0200	Connector M8, 4 pin, straight, 2 m
ESW 31AH0200	Connector M8, 4 pin, angular, 2 m

additional cable connectors and field wireable connectors: see accessories

#### Accessories

10149011	Sensofix series 14
10134964	Mounting bracket series 14 (L design)

for details: see accessories section

order reference	sensing distance $T_w$	connection types	output circuit	response time / release time	depth
FHDK 14N5101	20 ... 350 mm	cable 4 pin, 2 m	NPN	< 1 ms	32,7 mm
FHDK 14N5101/S14	20 ... 350 mm	connector M12 4 pin	NPN	< 1 ms	31 mm
FHDK 14N5101/S35A	20 ... 350 mm	connector M8 4 pin	NPN	< 1 ms	31 mm
FHDK 14N5104	30 ... 500 mm	cable 4 pin, 2 m	NPN	< 5 ms	32,7 mm
FHDK 14N5104/S14	30 ... 500 mm	connector M12 4 pin	NPN	< 5 ms	31 mm
FHDK 14N5104/S35A	30 ... 500 mm	connector M8 4 pin	NPN	< 5 ms	31 mm
FHDK 14P5101	20 ... 350 mm	cable 4 pin, 2 m	PNP	< 1 ms	32,7 mm
FHDK 14P5101/S14	20 ... 350 mm	connector M12 4 pin	PNP	< 1 ms	31 mm
FHDK 14P5101/S35A	20 ... 350 mm	connector M8 4 pin	PNP	< 1 ms	31 mm
FHDK 14P5104	30 ... 500 mm	cable 4 pin, 2 m	PNP	< 5 ms	32,7 mm
FHDK 14P5104/S14	30 ... 500 mm	connector M12 4 pin	PNP	< 5 ms	31 mm
FHDK 14P5104/S35A	30 ... 500 mm	connector M8 4 pin	PNP	< 5 ms	31 mm

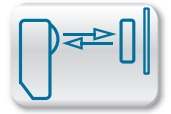

## sensing distance diagrams

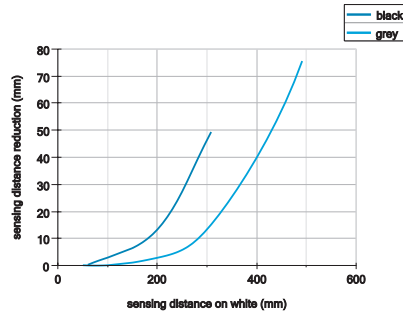
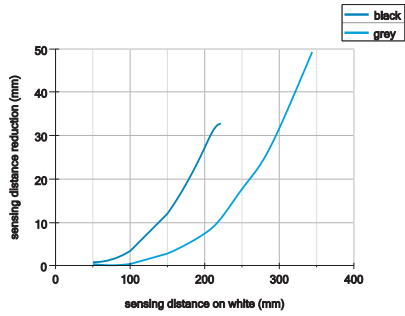

## dimension drawings

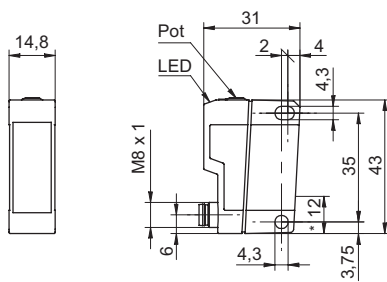

\* emitter axis

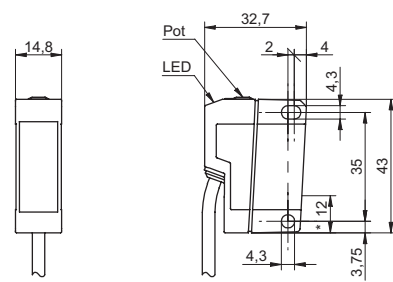

\* emitter axis

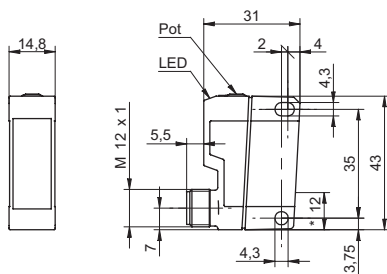

\* emitter axis

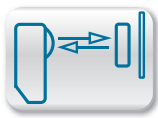

$T_w = 40 \dots 200 \text{ mm}$



- short response time
- sensing distance adjustable via Teach-in
- suppression of mutual optical interference

#### general data

type	background suppression
light source	pulsed red LED
sensing distance $T_w$	40 ... 200 mm
sensing range $T_b$ (at $T_w$ max.)	20 ... 200 mm
sensing range $T_b$ (at $T_w$ min.)	12 ... 40 mm
alignment / soiled lens indicator	flashing light indicator
light indicator	LED green
output indicator	LED yellow
sensing distance adjustment	Teach-in
wave length	660 nm
suppression of reciprocal influence	yes

#### electrical data

response time / release time	< 0,5 ms
voltage supply range +Vs	10 ... 30 VDC
current consumption max. (no load)	40 mA
current consumption typ.	35 mA
voltage drop Vd	< 1,8 VDC
output function	light / dark operate
output current	< 100 mA
short circuit protection	yes
reverse polarity protection	yes

#### mechanical data

width / diameter	14,8 mm
height / length	43 mm
type	rectangular
housing material	plastic (ASA, MABS)
front (optics)	PMMA

#### ambient conditions

operating temperature	-25 ... +65 °C
protection class	IP 67

#### connection diagrams

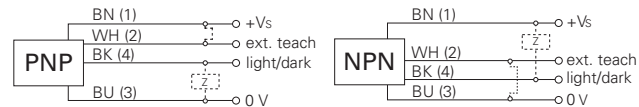

#### connectors and mating connectors

ESG 34AH0200	Connector M12, 4 pin, straight, 2 m
ESW 33AH0200	Connector M12, 4 pin, angular, 2 m
ESG 32AH0200	Connector M8, 4 pin, straight, 2 m
ESW 31AH0200	Connector M8, 4 pin, angular, 2 m

additional cable connectors and field wireable connectors: see accessories

#### Accessories

10149011	Sensofix series 14
10134964	Mounting bracket series 14 (L design)

for details: see accessories section

order reference	connection types	output circuit	depth
FHDK 14N6901	cable 4 pin, 2 m	NPN	32,7 mm
FHDK 14N6901/S14	connector M12 4 pin	NPN	31 mm
FHDK 14N6901/S35A	connector M8 4 pin	NPN	31 mm
FHDK 14P6901	cable 4 pin, 2 m	PNP	32,7 mm
FHDK 14P6901/S14	connector M12 4 pin	PNP	31 mm
FHDK 14P6901/S35A	connector M8 4 pin	PNP	31 mm

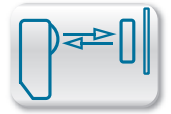

## sensing distance diagram

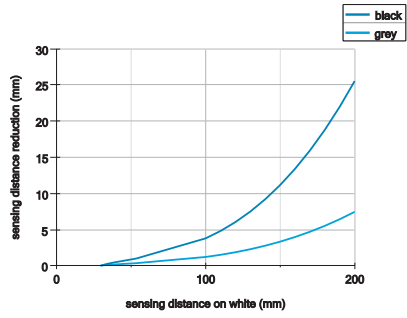

## dimension drawing

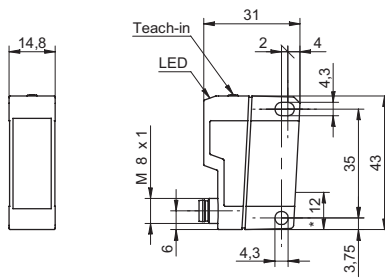

\* emitter axis

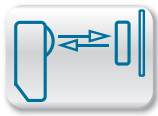

Tw = 20 ... 600 mm

- rugged metal housing
- sensing distance adjustable via potentiometer
- suppression of mutual optical interference



**general data**

type	background suppression
light source	pulsed red LED
sensing range Tb (at Tw min.)	5 ... 20 mm
light indicator	LED yellow
sensing distance adjustment	mechanical, 5 turn
wave length	660 nm
suppression of reciprocal influence	yes

**sensing distance Tw = 20 ... 450 mm**

sensing range Tb (at Tw max.)	20 ... 450 mm
-------------------------------	---------------

**sensing distance Tw = 20 ... 600 mm**

sensing range Tb (at Tw max.)	20 ... 600 mm
-------------------------------	---------------

**electrical data**

voltage supply range +Vs	10 ... 30 VDC
current consumption max. (no load)	41 mA
current consumption typ.	29 mA
voltage drop Vd	< 1,8 VDC
output function	light / dark operate
output current	< 200 mA
short circuit protection	yes
reverse polarity protection	yes

**mechanical data**

width / diameter	15,4 mm
height / length	50 mm
depth	50 mm
type	rectangular
housing material	die-cast zinc
front (optics)	PMMA

**ambient conditions**

operating temperature	-25 ... +65 °C
protection class	IP 67

**connection diagrams**



**connectors and mating connectors**

ESG 34AH0200	Connector M12, 4 pin, straight, 2 m
ESW 33AH0200	Connector M12, 4 pin, angular, 2 m

additional cable connectors and field wireable connectors: see accessories

**Accessories**

10151721	Sensofix series 16
10113917	Mounting bracket series 16 (L design)
10116407	Lens cleaning air nozzle bracket

for details: see accessories section

order reference	sensing distance Tw	connection types	output circuit	response time / release time
FHDM 16N5001	20 ... 450 mm	cable 4 pin, 2 m	NPN	< 1 ms
FHDM 16N5001/S14	20 ... 450 mm	connector M12 4 pin	NPN	< 1 ms
FHDM 16N5004	20 ... 600 mm	cable 4 pin, 2 m	NPN	< 5 ms
FHDM 16N5004/S14	20 ... 600 mm	connector M12 4 pin	NPN	< 5 ms
FHDM 16P5001	20 ... 450 mm	cable 4 pin, 2 m	PNP	< 1 ms
FHDM 16P5001/S14	20 ... 450 mm	connector M12 4 pin	PNP	< 1 ms
FHDM 16P5004	20 ... 600 mm	cable 4 pin, 2 m	PNP	< 5 ms
FHDM 16P5004/S14	20 ... 600 mm	connector M12 4 pin	PNP	< 5 ms

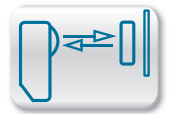

## sensing distance diagrams

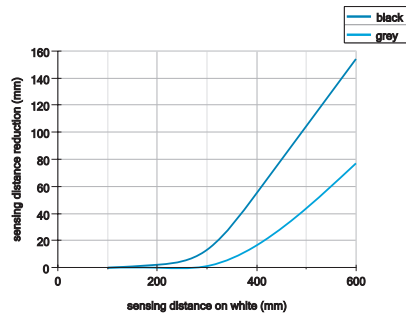
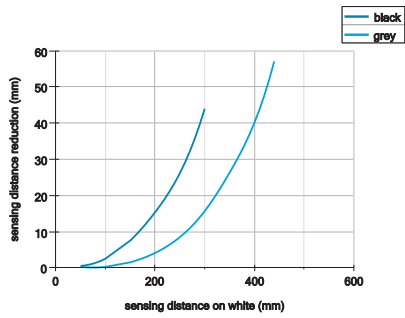

## dimension drawings

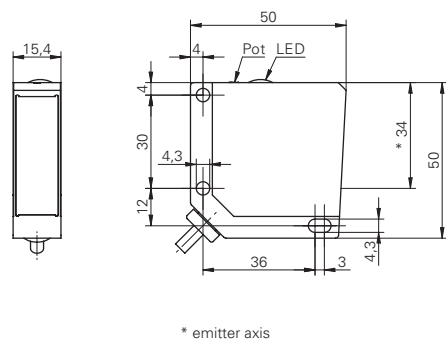
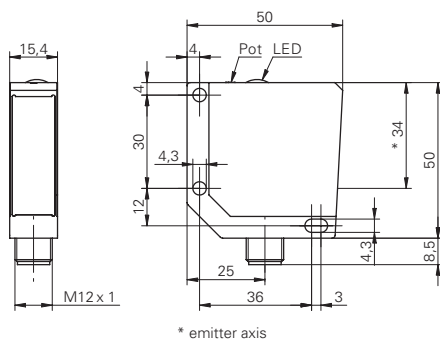

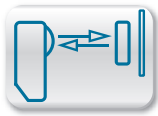

Tw = 400 mm

IO-Link

- PinPoint LED
- small beam diameter
- short response time



### general data

type	background suppression
light source	pulsed PinPoint LED
sensing distance Tw	60 ... 400 mm
sensing range Tb	30 ... 400 mm
power on indication	LED green
light indicator	LED yellow
wave length	630 nm
suppression of reciprocal influence	yes
alignment optical axis	< 1°

### electrical data

response time / release time	< 0,49 ms
voltage supply range +Vs	10 ... 30 VDC
current consumption max. (no load)	40 mA
current consumption typ.	30 mA
voltage drop Vd	< 3 VDC
output function	light / dark operate
output current	< 100 mA
short circuit protection	yes
reverse polarity protection	yes

### mechanical data

width / diameter	18 mm
height / length	45 mm
depth	32 mm
type	rectangular
housing material	plastic (ASA, PMMA)
front (optics)	PMMA

### ambient conditions

operating temperature	-25 ... +60 °C
protection class	IP 67

### connection diagrams

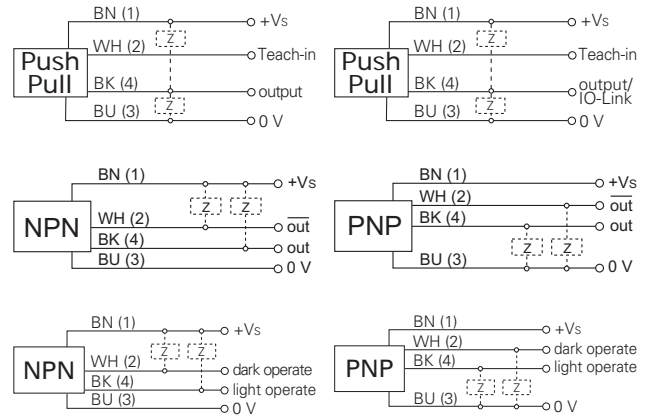

### connectors and mating connectors

ESG 34AH0200	Connector M12, 4 pin, straight, 2 m
ESW 33AH0200	Connector M12, 4 pin, angular, 2 m

additional cable connectors and field wireable connectors: see accessories

### Accessories

11099942	Sensofix O500/U500
11092246	Mounting bracket O500/U500 (L design)
11111164	Mounting bracket O500/U500 - Retrofit for sensors series 30

for details: see accessories section

order reference	connection types	output circuit	sensing distance adjustment
O500.GP-11096067	cable 4 pin, 2 m	push-pull	qTeach / external
O500.GP-11096064	connector M12 4 pin	push-pull	qTeach / external
O500.GP-11125084	cable 4 pin, 2 m	push-pull	Teach-in and IO-Link
O500.GP-11125079	connector M12 4 pin	push-pull	Teach-in and IO-Link
O500.GP-11096069	cable 4 pin, 2 m	NPN complementary	qTeach
O500.GP-11135857	cable 4 pin, 2 m	NPN complementary	qTeach / 1-Step Teach-in
O500.GP-11135859	connector M12 4 pin	NPN complementary	qTeach / 1-Step Teach-in
O500.GP-11096066	connector M12 4 pin	NPN complementary	qTeach
O500.GP-11096068	cable 4 pin, 2 m	PNP complementary	qTeach
O500.GP-11135861	cable 4 pin, 2 m	PNP complementary	qTeach / 1-Step Teach-in
O500.GP-11135862	connector M12 4 pin	PNP complementary	qTeach / 1-Step Teach-in
O500.GP-11096065	connector M12 4 pin	PNP complementary	qTeach



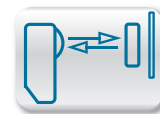

## sensing distance diagram

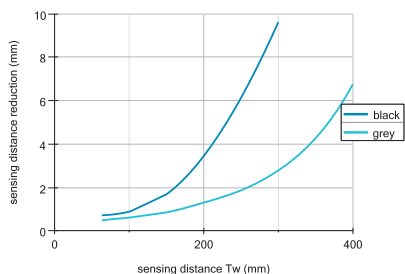

## beam characteristic (typically)

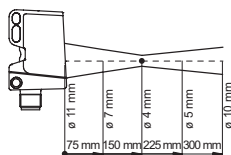

## dimension drawings

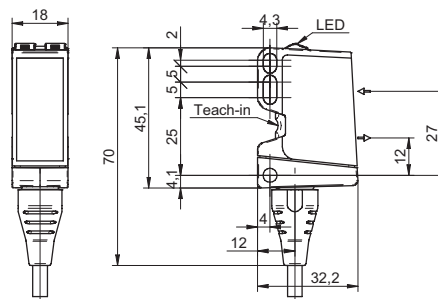
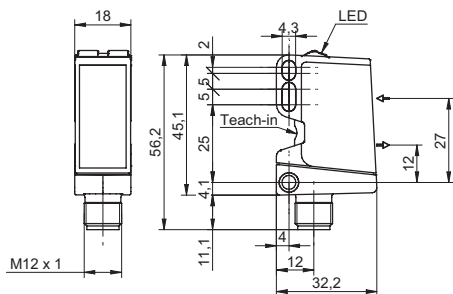

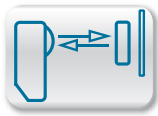

Tw = 600 mm

- qTeach



**general data**

type	background suppression
light source	pulsed red LED
sensing distance Tw	60 ... 550 mm
sensing range Tb	30 ... 600 mm
power on indication	LED green
light indicator	LED yellow
wave length	630 nm
suppression of reciprocal influence	yes
alignment optical axis	< 1°

**electrical data**

response time / release time	< 1 ms
voltage supply range +Vs	10 ... 30 VDC
current consumption max. (no load)	40 mA
current consumption typ.	30 mA
voltage drop Vd	< 3 VDC
output function	light / dark operate
output current	< 100 mA
short circuit protection	yes
reverse polarity protection	yes

**mechanical data**

width / diameter	18 mm
height / length	45 mm
depth	32 mm
type	rectangular
housing material	plastic (ASA, PMMA)
front (optics)	PMMA

**ambient conditions**

operating temperature	-25 ... +60 °C
protection class	IP 67

**connection diagrams**

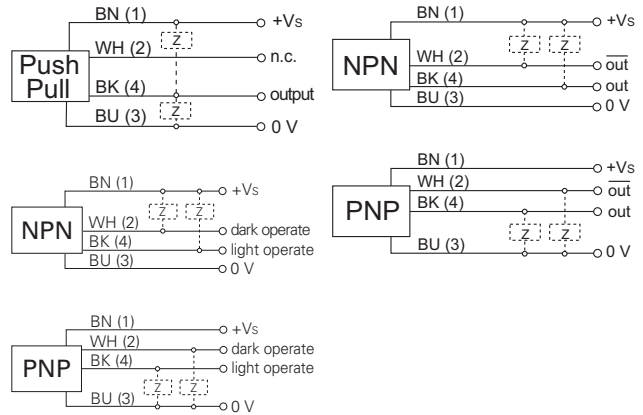

**connectors and mating connectors**

ESG 34SH0200	Connector M12, 3 pin, straight, 2 m
ESW 33SH0200	Connector M12, 3 pin, angular, 2 m
ESG 34AH0200	Connector M12, 4 pin, straight, 2 m
ESW 33AH0200	Connector M12, 4 pin, angular, 2 m

additional cable connectors and field wireable connectors: see accessories

**Accessories**

11099942	Sensofix O500/U500
11092246	Mounting bracket O500/U500 (L design)
11111164	Mounting bracket O500/U500 - Retrofit for sensors series 30

for details: see accessories section

order reference	connection types	output circuit	sensing distance adjustment
O500.GR-11096063	cable 3 pin, 2 m	push-pull	qTeach
O500.GR-11096062	connector M12 3 pin	push-pull	qTeach
O500.GR-11135886	cable 4 pin, 2 m	NPN complementary	qTeach
O500.GR-11135889	cable 4 pin, 2 m	NPN complementary	qTeach / 1-Step Teach-in
O500.GR-11135863	connector M12 4 pin	NPN complementary	qTeach / 1-Step Teach-in
O500.GR-11123121	connector M12 4 pin	NPN complementary	qTeach
O500.GR-11135888	cable 4 pin, 2 m	PNP complementary	qTeach
O500.GR-11135891	cable 4 pin, 2 m	PNP complementary	qTeach / 1-Step Teach-in
O500.GR-11135864	connector M12 4 pin	PNP complementary	qTeach / 1-Step Teach-in
O500.GR-11123131	connector M12 4 pin	PNP complementary	qTeach

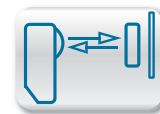

## sensing distance diagram

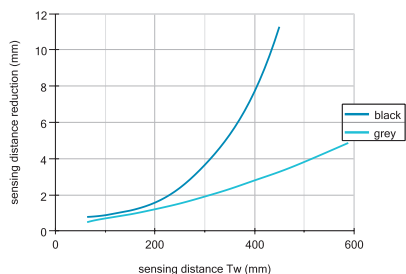

## beam characteristic (typically)

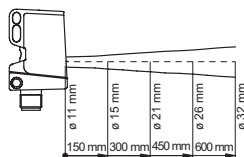

## dimension drawings

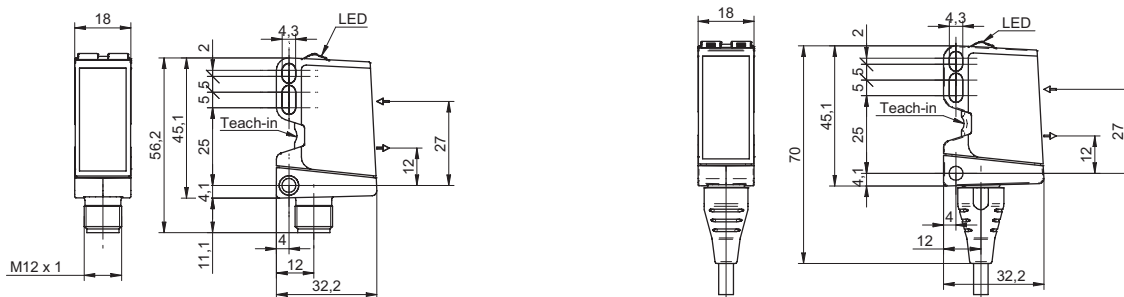

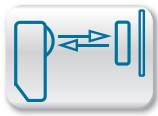

Tw = 600 mm

- infrared LED
- short response time
- qTeach



**general data**

type	background suppression
light source	pulsed infrared diode
sensing distance Tw	60 ... 550 mm
sensing range Tb	30 ... 600 mm
power on indication	LED green
light indicator	LED yellow
sensing distance adjustment	qTeach / external
wave length	860 nm
suppression of reciprocal influence	yes
alignment optical axis	< 1°

**electrical data**

response time / release time	< 0,49 ms
voltage supply range +Vs	10 ... 30 VDC
current consumption max. (no load)	40 mA
current consumption typ.	30 mA
voltage drop Vd	< 3 VDC
output function	light / dark operate
output circuit	push-pull
output current	< 100 mA
short circuit protection	yes
reverse polarity protection	yes

**mechanical data**

width / diameter	18 mm
height / length	45 mm
depth	32 mm
type	rectangular
housing material	plastic (ASA, PMMA)
front (optics)	PMMA

**ambient conditions**

operating temperature	-25 ... +60 °C
protection class	IP 67

**order reference**                      **connection types**

<b>O500.GI-11128082</b>	cable 4 pin, 2 m
<b>O500.GI-11120203</b>	connector M12 4 pin

**connection diagram**

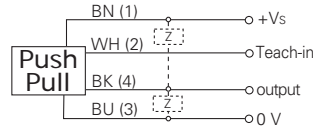

**connectors and mating connectors**

ESG 34SH0200	Connector M12, 3 pin, straight, 2 m
ESW 33SH0200	Connector M12, 3 pin, angular, 2 m

additional cable connectors and field wireable connectors: see accessories

**Accessories**

11099942	Sensofix O500/U500
11092246	Mounting bracket O500/U500 (L design)
11111164	Mounting bracket O500/U500 - Retrofit for sensors series 30

for details: see accessories section

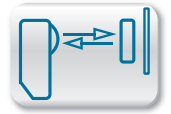

## sensing distance diagram

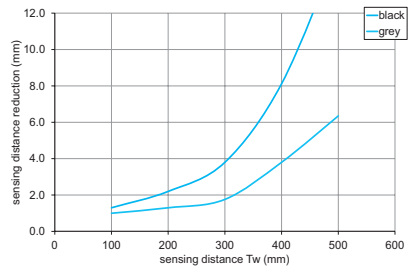

## beam characteristic (typically)

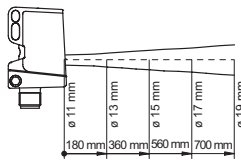

## dimension drawings

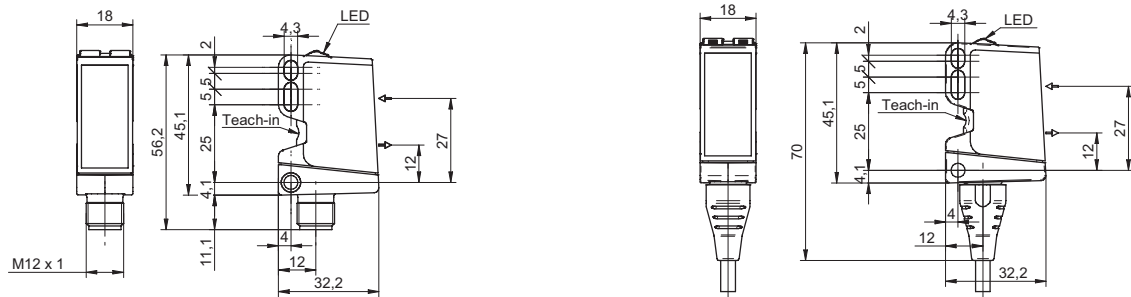

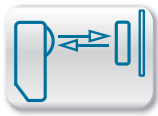

Tw = 30 ... 200 mm



- cross-technology housing concept
- sensing distance adjustable via Teach-in
- small mounting depth

**general data**

type	background suppression
light source	pulsed red LED
sensing distance Tw	30 ... 200 mm
sensing range Tb (at Tw max.)	2 ... 200 mm
sensing range Tb (at Tw min.)	12 ... 30 mm
alignment / soiled lens indicator	flashing light indicator
light indicator	LED green
output indicator	LED yellow
sensing distance adjustment	Teach-in
wave length	660 nm
suppression of reciprocal influence	yes

**electrical data**

response time / release time	< 0,5 ms
voltage supply range +Vs	12 ... 30 VDC
current consumption max. (no load)	48 mA
current consumption typ.	28 mA
voltage drop Vd	< 1,8 VDC
output function	light / dark operate
output current	< 100 mA
short circuit protection	yes
reverse polarity protection	yes

**mechanical data**

width / diameter	20 mm
height / length	42 mm
depth	15 mm
type	rectangular
housing material	plastic (PBT-ASA)
front (optics)	PMMA
connection types	connector M8 4 pin

**ambient conditions**

operating temperature	-25 ... +65 °C
protection class	IP 67

**order reference      output circuit**

<b>FHDK 20N6901/S35A</b>	NPN
<b>FHDK 20P6901/S35A</b>	PNP

**connection diagrams**



**connectors and mating connectors**

ESG 32AH0200	Connector M8, 4 pin, straight, 2 m
ESW 31AH0200	Connector M8, 4 pin, angular, 2 m

additional cable connectors and field wireable connectors: see accessories

**Accessories**

10150326	Sensofix series 10 / series 20
----------	--------------------------------

for details: see accessories section

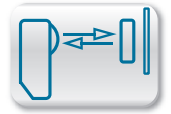

## sensing distance diagram

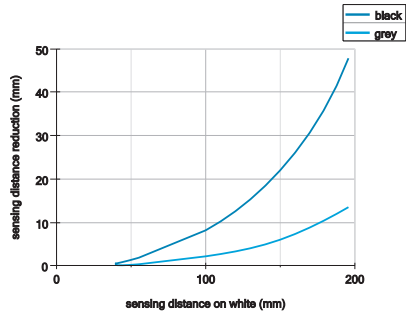

## dimension drawing

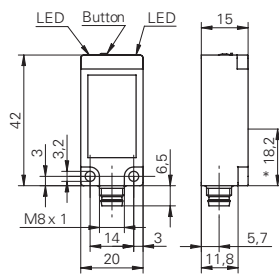

\* emitter axis

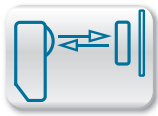

Tw = 200 mm



- PinPoint LED
- small beam diameter
- short response time

**general data**

type	background suppression
light source	pulsed PinPoint LED
sensing distance Tw	45 ... 200 mm
sensing range Tb	20 ... 200 mm
power on indication	LED green
light indicator	LED yellow
wave length	630 nm
suppression of reciprocal influence	yes

**electrical data**

response time / release time	< 0,49 ms
voltage supply range +Vs	10 ... 30 VDC
current consumption max. (no load)	45 mA
current consumption typ.	30 mA
voltage drop Vd	< 3 VDC
output function	light / dark operate
output current	< 100 mA
short circuit protection	yes
reverse polarity protection	yes

**mechanical data**

width / diameter	18 mm
height / length	65 mm
type	cylindrical threaded
housing material	brass nickel plated
front (optics)	PA
connection types	connector M12 4 pin

**ambient conditions**

operating temperature	-25 ... +60 °C
protection class	IP 67

**connection diagrams**

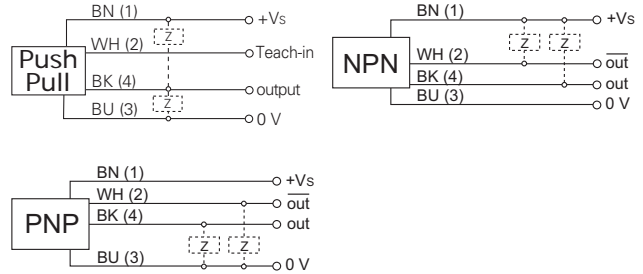

**connectors and mating connectors**

ESG 34AH0200	Connector M12, 4 pin, straight, 2 m
ESW 33AH0200	Connector M12, 4 pin, angular, 2 m
additional cable connectors and field wireable connectors: see accessories	

**Accessories**

10151658	Sensofix series 18
ZADAP-M18.STANDARD	Mounting bracket series 18
ZADAP-M18.SHORT	Mounting bracket short series 18 (L design)
ZADAP-M18.LONG	Mounting bracket long series 18 (L design)
ZADAP-M18.SWING	Mounting bracket for adjustment for sensors series 18
ZADAP-M18.MICRO	Mounting bracket for adjustment for sensors series 18

for details: see accessories section

order reference	output circuit	sensing distance adjustment
OR18.GP-11128094	push-pull	qTeach / external
OR18.GP-11129327	NPN complementary	qTeach
OR18.GP-11129323	PNP complementary	qTeach

OR18.GP Tw = 200 mm Diffuse sensors with background suppression



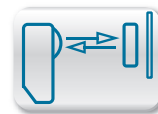

## sensing distance diagram

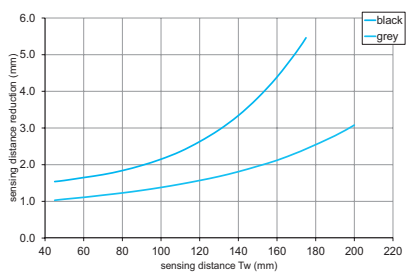

## beam characteristic (typically)

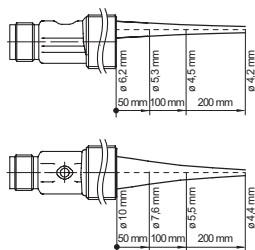

## dimension drawing

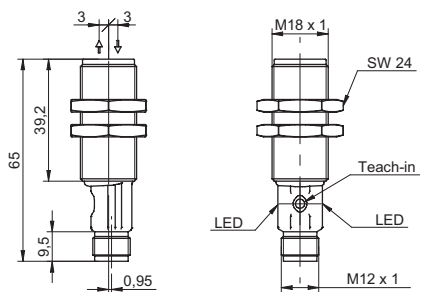

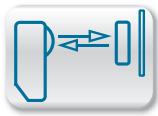

Tw = 120 mm



- sensing distance adjustable via potentiometer

#### general data

type	background suppression
light source	pulsed red LED
sensing distance Tw	40 ... 120 mm
sensing range Tb	5 ... 120 mm
power on indication	LED green
output indicator	LED yellow
sensing distance adjustment	mechanical, 4 turn
wave length	660 nm

#### electrical data

response time / release time	< 1 ms
voltage supply range +Vs	12 ... 30 VDC
current consumption max. (no load)	40 mA
current consumption typ.	30 mA
voltage drop Vd	< 2 VDC
output function	light / dark operate
output current	< 100 mA
short circuit protection	yes
reverse polarity protection	yes

#### mechanical data

width / diameter	18 mm
height / length	71,9 mm
type	cylindrical threaded
housing material	plastic (ABS TERLURAN)
front (optics)	PMMA
connection types	connector M12 4 pin

#### ambient conditions

operating temperature	-25 ... +55 °C
protection class	IP 67

#### order reference

order reference	output circuit
OR18.GR-11157842	NPN
OR18.GR-11157841	PNP

#### connection diagrams

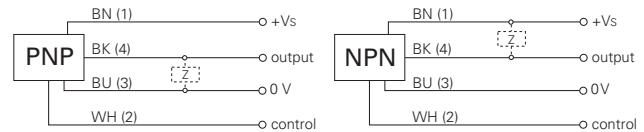

#### connectors and mating connectors

ESG 34AH0200 Connector M12, 4 pin, straight, 2 m

ESW 33AH0200 Connector M12, 4 pin, angular, 2 m

additional cable connectors and field wireable connectors: see accessories

#### Accessories

10151658	Sensofix series 18
ZADAP-M18.STANDARD	Mounting bracket series 18
ZADAP-M18.SHORT	Mounting bracket short series 18 (L design)
ZADAP-M18.LONG	Mounting bracket long series 18 (L design)
ZADAP-M18.SWING	Mounting bracket for adjustment for sensors series 18
ZADAP-M18.MICRO	Mounting bracket for adjustment for sensors series 18
ZPART-M18.NUT	Clamping nut for sensors Ø 18 mm

for details: see accessories section

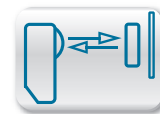

## sensing distance diagram

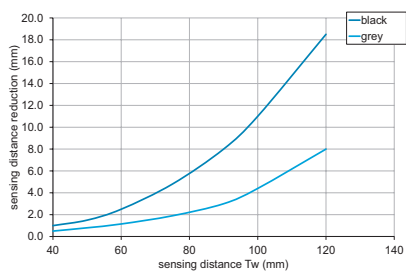

## beam characteristic (typically)

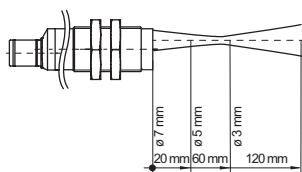

## dimension drawing

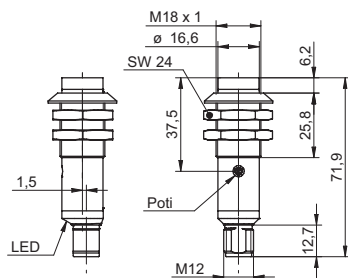

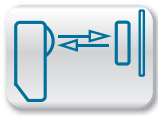

Tw = 120 mm



- fixed sensing distance
- small beam diameter

**general data**

type	background suppression
version	fixed focus
light source	pulsed red LED
sensing distance Tw	50 mm
sensing range Tb	10 ... 50 mm
output indicator	LED yellow
sensing distance adjustment	no
wave length	660 nm

**electrical data**

response time / release time	< 0,5 ms
voltage supply range +Vs	12 ... 30 VDC
current consumption max. (no load)	40 mA
current consumption typ.	30 mA
voltage drop Vd	< 2 VDC
output function	light / dark operate
output current	< 100 mA
short circuit protection	yes
reverse polarity protection	yes

**mechanical data**

width / diameter	18 mm
height / length	48,3 mm
type	cylindrical threaded
housing material	plastic (ABS TERLURAN)
front (optics)	PMMA

**ambient conditions**

operating temperature	-25 ... +55 °C
protection class	IP 67

**connection diagrams**

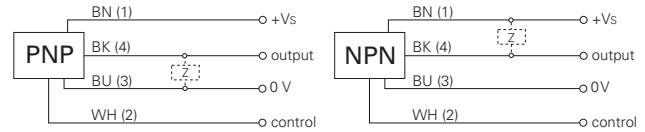

**connectors and mating connectors**

ESG 34AH0200	Connector M12, 4 pin, straight, 2 m
ESW 33AH0200	Connector M12, 4 pin, angular, 2 m

additional cable connectors and field wireable connectors: see accessories

**Accessories**

10151658	Sensofix series 18
ZADAP-M18.STANDARD	Mounting bracket series 18
ZADAP-M18.SHORT	Mounting bracket short series 18 (L design)
ZADAP-M18.LONG	Mounting bracket long series 18 (L design)
ZADAP-M18.SWING	Mounting bracket for adjustment for sensors series 18
ZADAP-M18.MICRO	Mounting bracket for adjustment for sensors series 18
ZPART-M18.NUT	Clamping nut for sensors Ø 18 mm

for details: see accessories section

order reference	connection types	output circuit
OR18.GR.F-11157809	cable 4 pin, 2 m	NPN
OR18.GR.F-11157810	flylead connector M12 4 pin, L=100 mm	NPN
OR18.GR.F-11157807	cable 4 pin, 2 m	PNP
OR18.GR.F-11157808	flylead connector M12 4 pin, L=100 mm	PNP

OR18.GR.F Tw = 120 mm

Diffuse sensors with background suppression

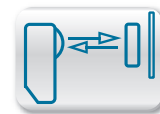

## sensing distance diagram

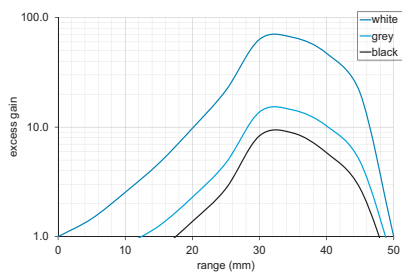

## beam characteristic (typically)

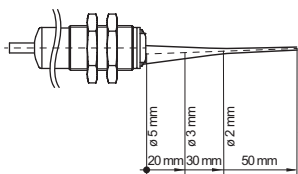

## dimension drawings

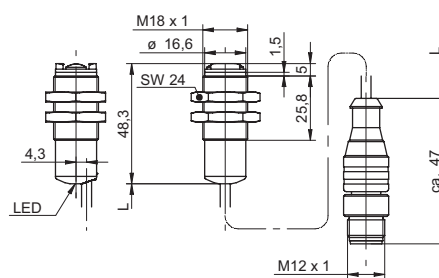
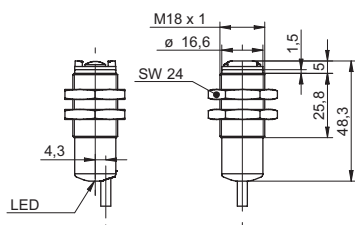

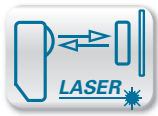

$T_w = 22 \dots 130 \text{ mm}$

- compact housing
- high repeatability
- sensing distance adjustable via potentiometer



#### general data

type	background suppression
light source	pulsed red laser diode
sensing distance $T_w$	22 ... 130 mm
sensing range $T_b$ (at $T_w$ max.)	3 ... 130 mm
sensing range $T_b$ (at $T_w$ min.)	3 ... 22 mm
repeat accuracy	< 0,2 mm at laser focus
power on indication	LED green
light indicator	LED yellow
sensing distance adjustment	mechanical, 5 turn
laser class	2
distance to focus	40 mm
wave length	650 nm
suppression of reciprocal influence	yes

#### electrical data

response time / release time	< 0,25 ms
voltage supply range +Vs	11 ... 30 VDC
current consumption max. (no load)	30 mA
current consumption typ.	25 mA
voltage drop $V_d$	< 1,8 VDC
output function	light / dark operate
short circuit protection	yes
reverse polarity protection	yes, supply only

#### mechanical data

width / diameter	10,4 mm
height / length	27 mm
depth	16,3 mm
type	rectangular
housing material	plastic (ASA)
front (optics)	PMMA

#### ambient conditions

operating temperature	-10 ... +50 °C
-----------------------	----------------

#### connection diagrams



#### connectors and mating connectors

ESG 32AH0200	Connector M8, 4 pin, straight, 2 m
ESW 31AH0200	Connector M8, 4 pin, angular, 2 m

additional cable connectors and field wireable connectors: see accessories

#### Accessories

10150326	Sensofix series 10 / series 20
10114501	Mounting bracket series 10 (U design)
10133792	Mounting bracket series 10 (L design)
10162083	Mounting panel for sensors series 10
10118798	Mounting bracket series 10

for details: see accessories section

#### laser warning

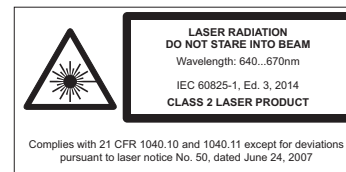

order reference	connection types	output circuit	protection class	output current
<b>OHDK 10N5101</b>	cable 4 pin, 2 m	NPN	IP 65	< 70 mA
<b>OHDK 10N5101/S35A</b>	connector M8 4 pin	NPN	IP 67	< 70 mA
<b>OHDK 10P5101</b>	cable 4 pin, 2 m	PNP	IP 65	< 100 mA
<b>OHDK 10P5101/S35A</b>	connector M8 4 pin	PNP	IP 67	< 100 mA

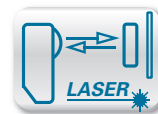

## sensing distance diagram

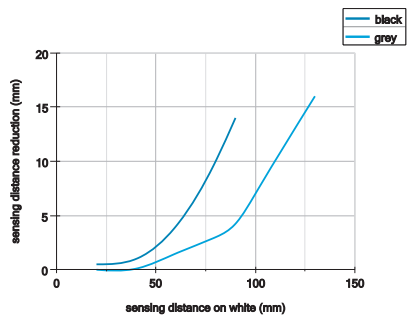

## beam characteristic (typically)

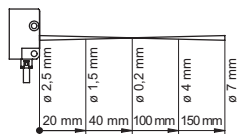

## dimension drawings

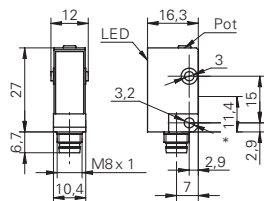

\* emitter axis

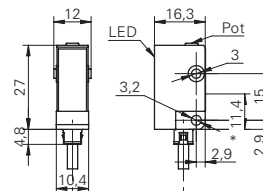

\* emitter axis

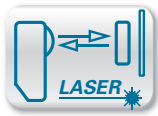

Tw = 22 ... 130 mm

- compact housing
- line beam
- sensing distance adjustable via potentiometer



**general data**

type	background suppression
version	line beam
light source	pulsed red laser diode
sensing distance Tw	22 ... 130 mm
sensing range Tb (at Tw max.)	3 ... 130 mm
sensing range Tb (at Tw min.)	3 ... 22 mm
repeat accuracy	< 0,2 mm at laser focus
power on indication	LED green
light indicator	LED yellow
sensing distance adjustment	mechanical, 5 turn
laser class	1
distance to focus	40 mm
wave length	650 nm
suppression of reciprocal influence	yes

**electrical data**

response time / release time	< 0,25 ms
voltage supply range +Vs	11 ... 30 VDC
current consumption max. (no load)	30 mA
current consumption typ.	25 mA
voltage drop Vd	< 1,8 VDC
output function	light / dark operate
short circuit protection	yes
reverse polarity protection	yes, supply only

**mechanical data**

width / diameter	10,4 mm
height / length	27 mm
depth	16,3 mm
type	rectangular
housing material	plastic (ASA)
front (optics)	PMMA
connection types	connector M8 4 pin

**ambient conditions**

operating temperature	-10 ... +50 °C
protection class	IP 67

**order reference**      **output circuit**      **output current**

<b>OHDK 10N5150/S35A</b>	NPN	< 70 mA
<b>OHDK 10P5150/S35A</b>	PNP	< 100 mA

**connection diagrams**



**connectors and mating connectors**

ESG 32AH0200	Connector M8, 4 pin, straight, 2 m
ESW 31AH0200	Connector M8, 4 pin, angular, 2 m

additional cable connectors and field wireable connectors: see accessories

**Accessories**

10150326	Sensofix series 10 / series 20
10114501	Mounting bracket series 10 (U design)
10133792	Mounting bracket series 10 (L design)
10162083	Mounting panel for sensors series 10
10118798	Mounting bracket series 10

for details: see accessories section

**laser warning**



IEC 60825-1/2014  
Complies with 21 CFR 1040.10 and 1040.11  
except for deviations pursuant to laser  
notice No. 50, dated June 24, 2007

OHDK 10 Tw = 22 ... 130 mm

Diffuse sensors with background suppression



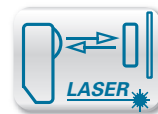

## sensing distance diagram

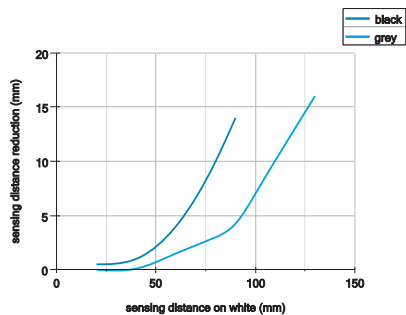

## beam characteristic (typically)

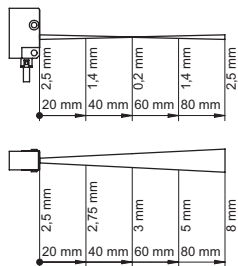

## dimension drawing

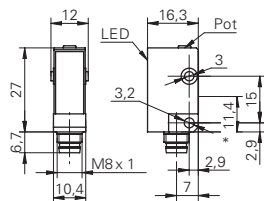

\* emitter axis

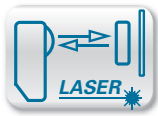

Tw = 17 ... 120 mm



- rugged miniature metal housing
- negligible black/white difference
- teachable sensing distance

**general data**

type	background suppression
light source	pulsed red laser diode
sensing distance Tw	17 ... 120 mm
sensing range Tb (at Tw max.)	16 ... 120 mm
sensing range Tb (at Tw min.)	16 ... 17 mm
power on indication	LED green
light indicator	LED red
sensing distance adjustment	Teach-in
laser class	2
wave length	675 nm
beam diameter	0,9 ... 0,5 mm

**electrical data**

response time	< 1 ms
release time	< 2,7 ms
voltage supply range +Vs	12 ... 28 VDC
current consumption max. (no load)	80 mA
current consumption typ.	40 mA
voltage drop Vd	< 2,8 VDC
output function	light / dark operate
output current	< 100 mA
short circuit protection	yes
reverse polarity protection	yes, Vs to GND

**mechanical data**

width / diameter	12,4 mm
height / length	37 mm
depth	34,5 mm
type	rectangular
housing material	die-cast zinc
front (optics)	glass
connection types	connector M8 4 pin

**ambient conditions**

operating temperature	0 ... +50 °C
protection class	IP 67

**order reference**

OHDM 12N6901/S35A
OHDM 12P6901/S35A

**output circuit**

NPN
PNP

**connection diagrams**



**connectors and mating connectors**

ESG 32AH0200	Connector M8, 4 pin, straight, 2 m
ESW 31AH0200	Connector M8, 4 pin, angular, 2 m

additional cable connectors and field wireable connectors: see accessories

**Accessories**

10150328	Sensofix series 12
10113873	Mounting bracket series 12 (L design)

for details: see accessories section

**laser warning**

Complies with 21 CFR 1040.10 and 1040.11 except for deviations pursuant to laser notice No. 50, dated June 24, 2007

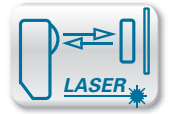

## sensing distance diagram

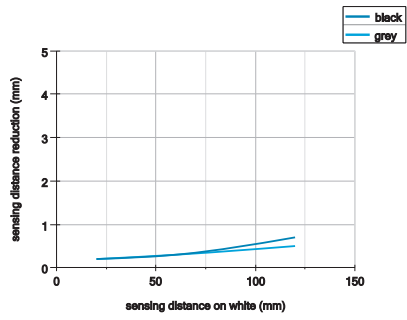

## dimension drawing

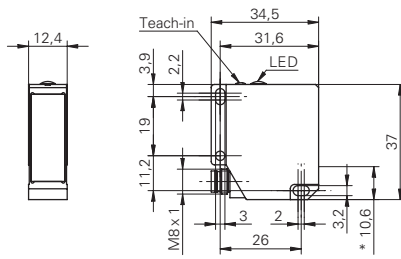

\* emitter axis

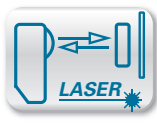

Tw = 250 mm

- One inch class
- laser diode
- very small beam diameter

**general data**

type	background suppression
light source	pulsed red laser diode
sensing distance Tw	30 ... 250 mm
sensing range Tb	15 ... 250 mm
repeat accuracy	< 0,1 mm at laser focus
power on indication	LED green
light indicator	LED yellow
laser class	1
distance to focus	80 mm
wave length	656 nm
suppression of reciprocal influence	yes
alignment optical axis	< 2°

**electrical data**

response time / release time	< 0,25 ms
voltage supply range +Vs	11 ... 30 VDC
current consumption max. (no load)	30 mA
current consumption typ.	25 mA
voltage drop Vd	< 2,5 VDC
output function	light / dark operate
output current	< 100 mA
short circuit protection	yes
reverse polarity protection	yes

**mechanical data**

width / diameter	12,9 mm
height / length	32,3 mm
depth	23 mm
type	rectangular
housing material	plastic (ASA, PMMA)
front (optics)	PMMA

**ambient conditions**

operating temperature	-10 ... +60 °C
protection class	IP 67

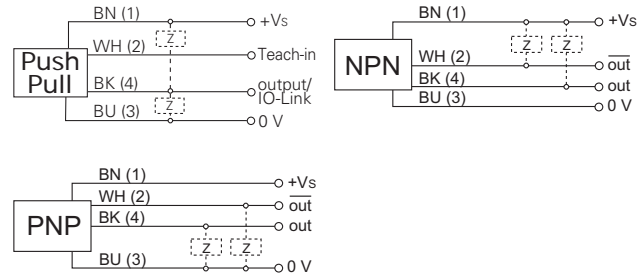
**connection diagrams****connectors and mating connectors**

ESG 32AH0200 Connector M8, 4 pin, straight, 2 m

ESW 31AH0200 Connector M8, 4 pin, angular, 2 m

additional cable connectors and field wireable connectors: see accessories

**Accessories**

11104963	Sensofix O300
11102423	Mounting bracket O300 (L design)
11124807	Mounting bracket O300 - Retrofit for sensors series 20

for details: see accessories section

**laser warning**

**CLASS 1 LASER  
PRODUCT**

IEC 60825-1/2014  
Complies with 21 CFR 1040.10 and 1040.11  
except for deviations pursuant to laser  
notice No. 50, dated June 24, 2007

order reference	connection types	output circuit	sensing distance adjustment
O300.GL-11171740	cable 4 pin, 2 m	push-pull	Teach-in and IO-Link
O300.GL-11171741	connector M8 4 pin	push-pull	Teach-in and IO-Link
O300.GL-11171745	cable 4 pin, 2 m	NPN complementary	qTeach
O300.GL-11171742	connector M8 4 pin	NPN complementary	qTeach
O300.GL-11171747	cable 4 pin, 2 m	PNP complementary	qTeach
O300.GL-11171748	connector M8 4 pin	PNP complementary	qTeach

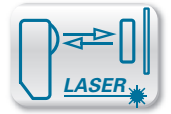

## sensing distance diagrams

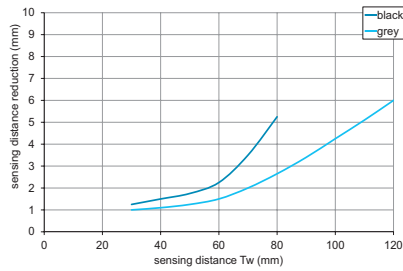
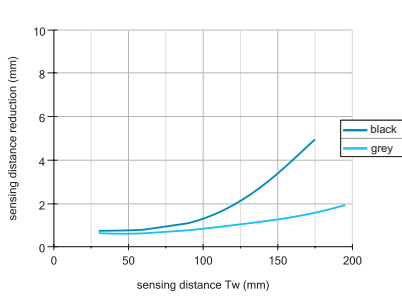

## beam characteristic (typically)

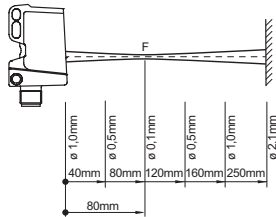

## dimension drawings

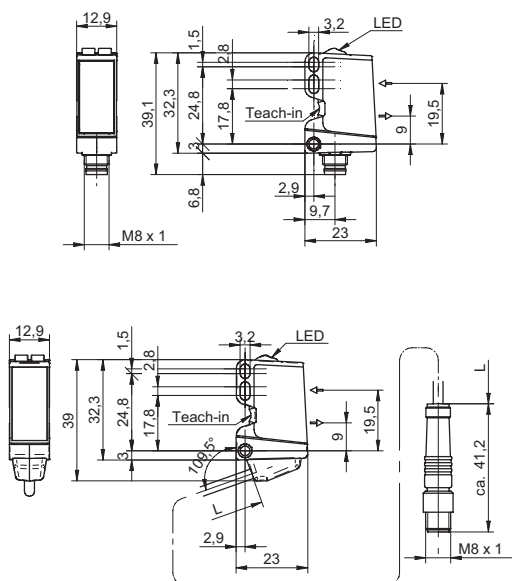

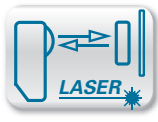

Tw = 120 mm

- One inch class
- laser diode
- line 0,75 x 67 mm

**general data**

type	background suppression
version	line beam
light source	pulsed red laser diode
sensing distance Tw	30 ... 120 mm
sensing range Tb	15 ... 120 mm
power on indication	LED green
light indicator	LED yellow
sensing distance adjustment	Teach-in and IO-Link
laser class	1
distance to focus	80 mm
wave length	656 nm
suppression of reciprocal influence	yes
beam type	line
alignment optical axis	< 2°

**electrical data**

response time / release time	< 1,5 ms
voltage supply range +Vs	11 ... 30 VDC
current consumption max. (no load)	30 mA
current consumption typ.	25 mA
voltage drop Vd	< 2,5 VDC
output function	light / dark operate
output circuit	push-pull
output current	< 100 mA
short circuit protection	yes
reverse polarity protection	yes

**mechanical data**

width / diameter	12,9 mm
height / length	32,3 mm
depth	23 mm
type	rectangular
housing material	plastic (ASA, PMMA)
front (optics)	PMMA

**ambient conditions**

operating temperature	-10 ... +60 °C
protection class	IP 67

**order reference**

O300.GL-11199070

**connection types**

cable 4 pin, 2 m

O300.GL-11196492

connector M8 4 pin

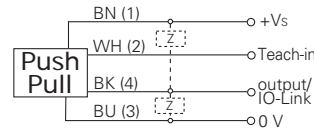
**connection diagram****connectors and mating connectors**

ESG 32AH0200	Connector M8, 4 pin, straight, 2 m
ESW 31AH0200	Connector M8, 4 pin, angular, 2 m

additional cable connectors and field wireable connectors: see accessories

**Accessories**

11104963	Sensofix O300
11102423	Mounting bracket O300 (L design)
11124807	Mounting bracket O300 - Retrofit for sensors series 20

for details: see accessories section

**laser warning**

**CLASS 1 LASER  
PRODUCT**

IEC 60825-1/2014  
Complies with 21 CFR 1040.10 and 1040.11  
except for deviations pursuant to laser  
notice No. 50, dated June 24, 2007

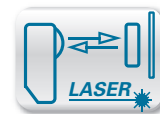

## sensing distance diagram

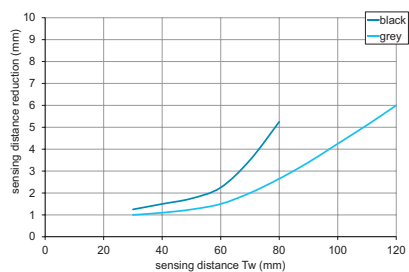

## beam characteristic (typically)

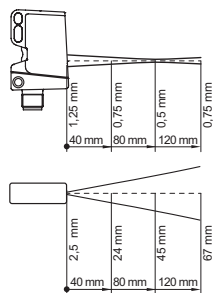

## dimension drawings



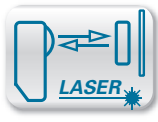

Tw = 250 mm



- One inch class
- hygienic design
- laser diode

**general data**

type	background suppression
special type	hygienic design
light source	pulsed red laser diode
sensing distance Tw	30 ... 250 mm
sensing range Tb	15 ... 250 mm
repeat accuracy	< 0,1 mm at laser focus
power on indication	LED green
light indicator	LED yellow
sensing distance adjustment	Teach-in and IO-Link
laser class	1
distance to focus	80 mm
wave length	656 nm
suppression of reciprocal influence	yes
alignment optical axis	< 2°
approvals/certificates	Ecolab

**electrical data**

response time / release time	< 0,25 ms
voltage supply range +Vs	11 ... 30 VDC
current consumption max. (no load)	30 mA
current consumption typ.	25 mA
voltage drop Vd	< 2,5 VDC
output function	light / dark operate
output circuit	push-pull
output current	< 100 mA
short circuit protection	yes
reverse polarity protection	yes

**mechanical data**

width / diameter	16,5 mm
height / length	34,6 mm
depth	28,7 mm
type	rectangular
housing material	stainless steel 1.4404 (V4A)
front (optics)	PMMA

**ambient conditions**

operating temperature	-10 ... +60 °C
protection class	IP 68/69K & proTect+

**order reference**

<b>O300H.GL-11171768</b>	cable 4 pin, 2 m
<b>O300H.GL-11171769</b>	flylead connector M8, L=200 mm

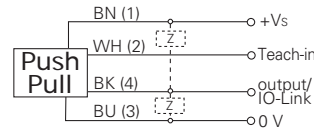
**connection types****connection diagram****connectors and mating connectors**

ESG 32AY0200 Connector M8, 4 pin, straight, 2 m, V4A-PP

ESW 31AY0200 Connector M8, 4 pin, angular, 2 m, V4A-PP

additional cable connectors and field wireable connectors: see accessories

**Accessories**

HI11-1H Mounting for sensors in hygienic design Ø 11 mm

11137318 Teach Pen for sensors in metal housing

11141124 Teach Pen for sensors in metal housing (USA, CAN, JP)

for details: see accessories section

**laser warning**

**CLASS 1 LASER  
PRODUCT**

IEC 60825-1/2014  
Complies with 21 CFR 1040.10 and 1040.11  
except for deviations pursuant to laser  
notice No. 50, dated June 24, 2007



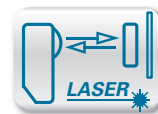

sensing distance diagram

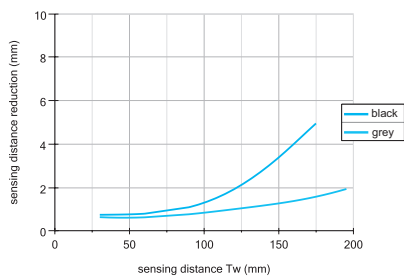

beam characteristic (typically)

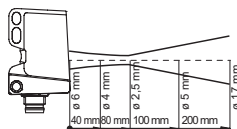

dimension drawings

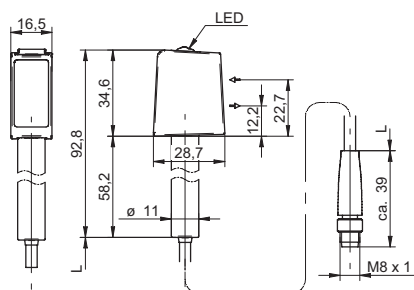
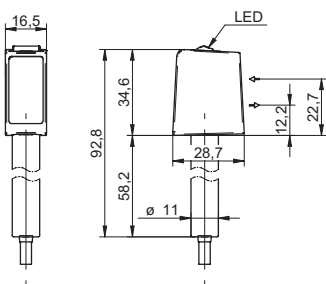

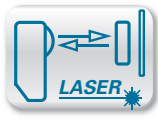

Tw = 250 mm



- One inch class
- washdown design
- laser diode

**general data**

type	background suppression
special type	Washdown design
light source	pulsed red laser diode
sensing distance Tw	30 ... 250 mm
sensing range Tb	15 ... 250 mm
repeat accuracy	< 0,1 mm at laser focus
power on indication	LED green
light indicator	LED yellow
sensing distance adjustment	Teach-in and IO-Link
laser class	1
distance to focus	80 mm
wave length	656 nm
suppression of reciprocal influence	yes
alignment optical axis	< 2°
approvals/certificates	Ecolab

**electrical data**

response time / release time	< 0,25 ms
voltage supply range +Vs	11 ... 30 VDC
current consumption max. (no load)	30 mA
current consumption typ.	25 mA
voltage drop Vd	< 2,5 VDC
output function	light / dark operate
output circuit	push-pull
output current	< 100 mA
short circuit protection	yes
reverse polarity protection	yes

**mechanical data**

width / diameter	16,5 mm
height / length	34,7 mm
depth	28,2 mm
type	rectangular
housing material	stainless steel 1.4404 (V4A)
front (optics)	PMMA
connection types	connector M8 4 pin

**ambient conditions**

operating temperature	-10 ... +60 °C
protection class	IP 68/69K & proTect+

**order reference**

O300W.GL-11171770

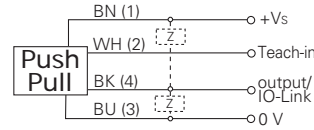
**connection diagram****connectors and mating connectors**

ESG 32AY0200 Connector M8, 4 pin, straight, 2 m, V4A-PP

ESW 31AY0200 Connector M8, 4 pin, angular, 2 m, V4A-PP

additional cable connectors and field wireable connectors: see accessories

**Accessories**

11104963	Sensofix O300
11102423	Mounting bracket O300 (L design)
11124807	Mounting bracket O300 - Retrofit for sensors series 20

for details: see accessories section

**laser warning**

**CLASS 1 LASER  
PRODUCT**

IEC 60825-1/2014  
Complies with 21 CFR 1040.10 and 1040.11  
except for deviations pursuant to laser  
notice No. 50, dated June 24, 2007

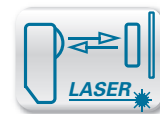

## sensing distance diagram

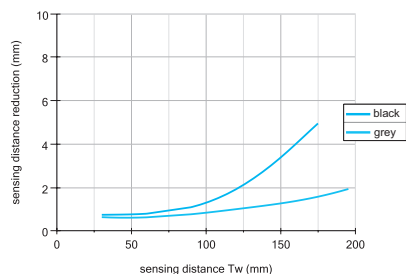

## beam characteristic (typically)

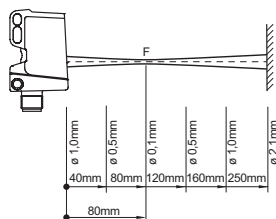

## dimension drawing

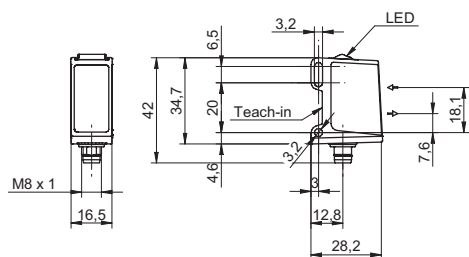

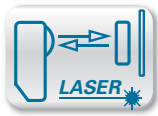

Tw = 50 ... 550 mm



- rugged metal housing
- negligible black/white difference
- teachable sensing distance

**general data**

type	background suppression
light source	pulsed red laser diode
sensing distance Tw	50 ... 550 mm
sensing range Tb (at Tw max.)	50 ... 550 mm
sensing range Tb (at Tw min.)	16 ... 17 mm
power on indication	LED green
light indicator	LED red
sensing distance adjustment	Teach-in
laser class	2

**electrical data**

response time	< 5 ms
release time	< 15 ms
voltage supply range +Vs	12 ... 28 VDC
current consumption max. (no load)	80 mA
current consumption typ.	40 mA
voltage drop Vd	< 2,8 VDC
output function	light / dark operate
output current	< 100 mA
short circuit protection	yes
reverse polarity protection	yes, Vs to GND

**mechanical data**

width / diameter	13,4 mm
height / length	48,2 mm
depth	40 mm
type	rectangular
housing material	aluminum
front (optics)	glass
connection types	connector M8 4 pin

**ambient conditions**

operating temperature	0 ... +50 °C
protection class	IP 67

**connection diagrams**



**connectors and mating connectors**

ESG 32AH0200	Connector M8, 4 pin, straight, 2 m
ESW 31AH0200	Connector M8, 4 pin, angular, 2 m

additional cable connectors and field wireable connectors: see accessories

**Accessories**

10161829	Sensofix series 13
10161695	Mounting bracket for sensors series 13 (L design)

for details: see accessories section

**laser warning**

order reference	output circuit	wave length	beam type	beam width	beam height	beam diameter
OHDM 13N6901/S35A	NPN	675 nm	point	-	-	1 mm
OHDM 13P6901/S35A	PNP	675 nm	point	-	-	1 mm
OHDM 13P6951/S35A	PNP	650 nm	line	2 mm	4 ... 13 mm	-



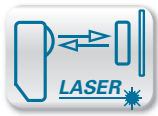

Tw = 20 ... 350 mm



- short response time
- high repeatability
- sensing distance adjustable via potentiometer

**general data**

type	background suppression
light source	pulsed red laser diode
sensing distance Tw	20 ... 350 mm
sensing range Tb (at Tw max.)	20 ... 350 mm
sensing range Tb (at Tw min.)	5 ... 20 mm
repeat accuracy	< 0,2 mm at laser focus
power on indication	LED green
light indicator	LED yellow
sensing distance adjustment	mechanical, 9 turn
laser class	2
distance to focus	115 mm
wave length	650 nm

**electrical data**

response time / release time	< 0,5 ms
voltage supply range +Vs	10 ... 30 VDC
current consumption max. (no load)	35 mA
current consumption typ.	25 mA
voltage drop Vd	< 2,2 VDC
output function	light / dark operate
output current	< 100 mA
short circuit protection	yes
reverse polarity protection	yes

**mechanical data**

width / diameter	14,8 mm
height / length	43 mm
type	rectangular
housing material	plastic (ASA, MABS)
front (optics)	PMMA

**ambient conditions**

operating temperature	-10 ... +50 °C
protection class	IP 67

**connection diagrams**



**connectors and mating connectors**

ESG 34AH0200	Connector M12, 4 pin, straight, 2 m
ESW 33AH0200	Connector M12, 4 pin, angular, 2 m
ESG 32AH0200	Connector M8, 4 pin, straight, 2 m
ESW 31AH0200	Connector M8, 4 pin, angular, 2 m

additional cable connectors and field wireable connectors: see accessories

**Accessories**

10149011	Sensofix series 14
10134964	Mounting bracket series 14 (L design)

for details: see accessories section

**laser warning**

order reference	connection types	output circuit	depth
OHDK 14N5101	cable 4 pin, 2 m	NPN	32,7 mm
OHDK 14N5101/S14	connector M12 4 pin	NPN	31 mm
OHDK 14N5101/S35A	connector M8 4 pin	NPN	31 mm
OHDK 14P5101	cable 4 pin, 2 m	PNP	32,7 mm
OHDK 14P5101/S14	connector M12 4 pin	PNP	31 mm
OHDK 14P5101/S35A	connector M8 4 pin	PNP	31 mm

OHDK 14 Tw = 20 ... 350 mm Diffuse sensors with background suppression



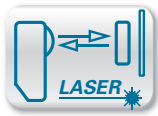

Tw = 25 ... 300 mm

- rugged metal housing
- long range
- high repeatability



**general data**

type	background suppression
light source	pulsed red laser diode
sensing distance Tw	25 ... 300 mm
sensing range Tb (at Tw max.)	40 ... 300 mm
sensing range Tb (at Tw min.)	5 ... 25 mm
repeat accuracy	< 0,1 mm at laser focus
output indicator	LED yellow
sensing distance adjustment	mechanical, 8 turn
laser class	2
wave length	650 nm

**electrical data**

voltage supply range +Vs	10 ... 30 VDC
current consumption max. (no load)	35 mA
current consumption typ.	25 mA
voltage drop Vd	< 2 VDC
output function	light / dark operate
output current	< 200 mA
short circuit protection	yes
reverse polarity protection	yes

**mechanical data**

width / diameter	15,4 mm
height / length	50 mm
depth	50 mm
type	rectangular
housing material	die-cast zinc
front (optics)	glass

**ambient conditions**

operating temperature	-10 ... +50 °C
protection class	IP 67

**connection diagrams**



**connectors and mating connectors**

ESG 34AH0200	Connector M12, 4 pin, straight, 2 m
ESW 33AH0200	Connector M12, 4 pin, angular, 2 m

additional cable connectors and field wireable connectors: see accessories

**Accessories**

10151721	Sensofix series 16
10113917	Mounting bracket series 16 (L design)
10116407	Lens cleaning air nozzle bracket

for details: see accessories section

**laser warning**

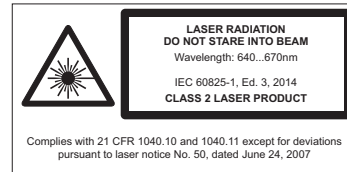

order reference	connection types	output circuit	response time / release time	distance to focus	suppression of reciprocal influence
OHDM 16N5001	cable 4 pin, 2 m	NPN	< 0,6 ms	80 mm	yes
OHDM 16N5001/S14	connector M12 4 pin	NPN	< 0,6 ms	80 mm	yes
OHDM 16P5001	cable 4 pin, 2 m	PNP	< 0,6 ms	80 mm	yes
OHDM 16P5001/S14	connector M12 4 pin	PNP	< 0,6 ms	80 mm	yes
OHDM 16P5002/S14	connector M12 4 pin	PNP	< 0,6 ms	40 mm	yes
OHDM 16P5012	cable 4 pin, 2 m	PNP	< 0,1 ms	60 mm	-
OHDM 16P5012/S14	connector M12 4 pin	PNP	< 0,1 ms	60 mm	-

OHDM 16 Tw = 25 ... 300 mm Diffuse sensors with background suppression



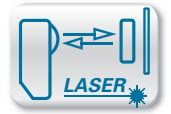

## sensing distance diagram

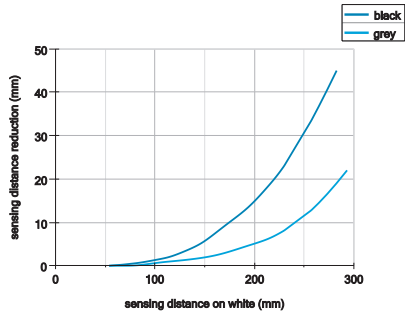

## beam characteristics (typically)

distance to laser focus = 80 mm

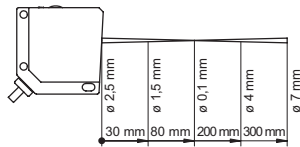

distance to laser focus = 40 mm

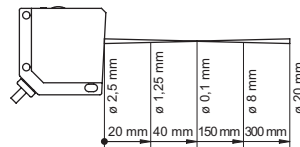

distance to laser focus = 60 mm

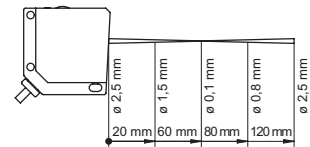

## dimension drawings

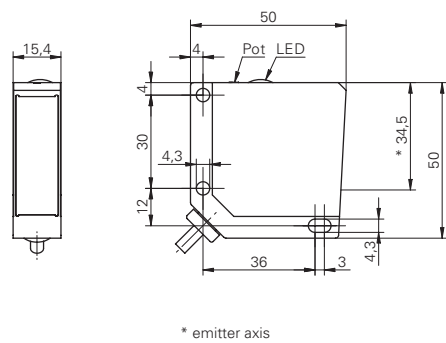
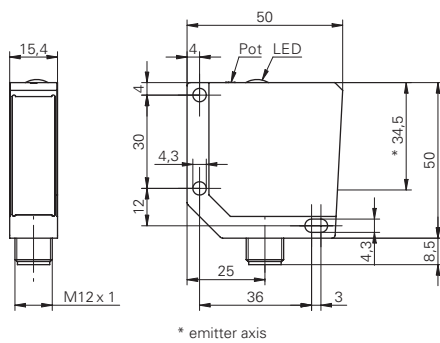

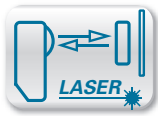

Tw = 133 mm

- for lateral detection of wafer edges
- very long range
- laser sensor in rugged metal housing



**general data**

type	background suppression
version	wafer mapping sensor
light source	pulsed red laser diode
sensing distance Tw	123 ... 143 mm
repeat accuracy	< 0,1 mm at laser focus
power on indication	LED green
output indicator	LED yellow
sensing distance adjustment	no
laser class	2
wave length	650 nm
suppression of reciprocal influence	yes

**electrical data**

response time / release time	< 5 ms
voltage supply range +Vs	10 ... 30 VDC
current consumption max. (no load)	35 mA
current consumption typ.	25 mA
voltage drop Vd	< 2 VDC
output function	light / dark operate
output current	< 200 mA
short circuit protection	yes
reverse polarity protection	yes

**mechanical data**

width / diameter	15,4 mm
height / length	50 mm
depth	50 mm
type	rectangular
housing material	die-cast zinc
front (optics)	glass
connection types	cabl 5 pin, 2 m

**ambient conditions**

operating temperature	-5 ... +50 °C
protection class	IP 67

**order reference      output circuit**

<b>OHDM 16N5651</b>	NPN
<b>OHDM 16P5651</b>	PNP

**connection diagrams**

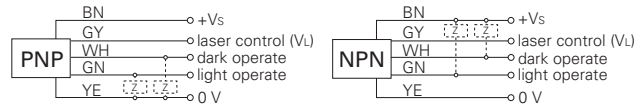

**Accessories**

10151721	Sensofix series 16
10113917	Mounting bracket series 16 (L design)
10116407	Lens cleaning air nozzle bracket

for details: see accessories section

**remarks**

Function laser control - input:  
 - Laser diode on VL < 1 V  
 - Laser diode off VL > Vs - 4 V or open

**laser warning**

Complies with 21 CFR 1040.10 and 1040.11 except for deviations pursuant to laser notice No. 50, dated June 24, 2007

OHDM 16 Tw = 133 mm

Diffuse sensors with background suppression

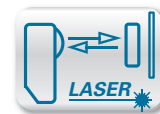

## beam characteristics (typically)

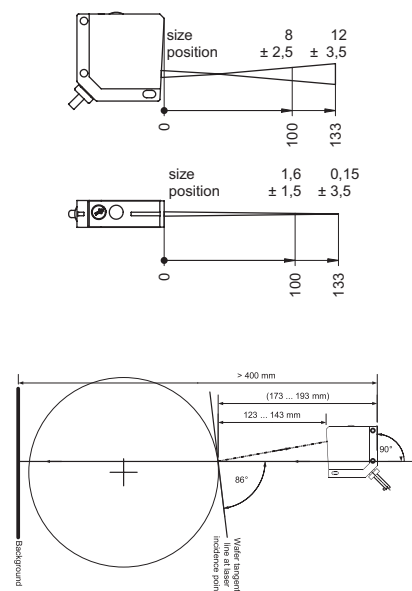

## dimension drawing

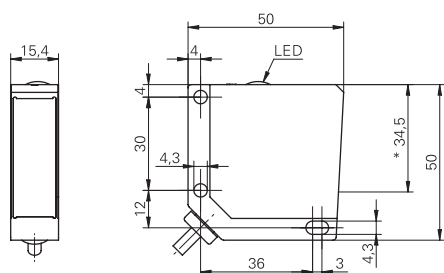

\* emitter axis

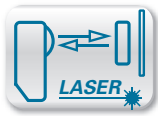

$T_w = 210 \dots 1500 \text{ mm}$

- long range
- negligible black/white difference
- two teachable sensing distances



#### general data

type	background suppression
light source	pulsed red laser diode
sensing distance $T_w$	210 ... 1500 mm
sensing range $T_b$ (at $T_w$ max.)	200 ... 1500 mm
sensing range $T_b$ (at $T_w$ min.)	200 ... 210 mm
power on indication	LED green
light indicator	LED red
sensing distance adjustment	Teach-in
laser class	2
wave length	650 nm
beam diameter	2 mm

#### electrical data

response time	< 6 ms
release time	< 18 ms
voltage supply range +Vs	12 ... 28 VDC
current consumption max. (no load)	100 mA
voltage drop Vd	< 5 VDC
output function	light / dark operate
output circuit	PNP
output current	< 20 mA
short circuit protection	yes
reverse polarity protection	yes, Vs to GND

#### mechanical data

width / diameter	20,6 mm
height / length	65 mm
depth	50 mm
type	rectangular
housing material	die-cast zinc
front (optics)	glass
connection types	connector M12 5 pin

#### ambient conditions

operating temperature	0 ... +50 °C
protection class	IP 67

#### order reference

OHDM 20P6990/S14C

#### connection diagram

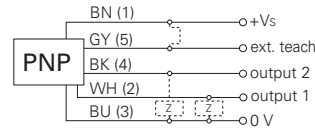

#### connectors and mating connectors

ESG 34CH0200 Connector M12, 5 pin, straight, 2 m

ESW 33CH0200 Connector M12, 5 pin, angular, 2 m

ESW 33CH0500 Connector M12, 5 pin, angular, 5 m

additional cable connectors and field wireable connectors: see accessories

#### Accessories

11010227 Mounting bracket OxDM 20

10156878 Protector cap OxDM 20

for details: see accessories section

#### laser warning

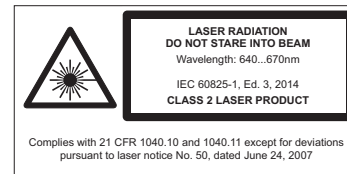

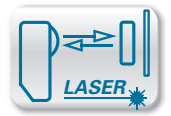

## sensing distance diagram

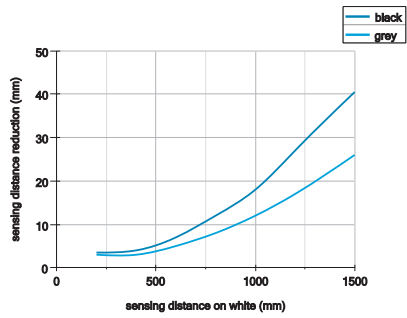

## dimension drawing

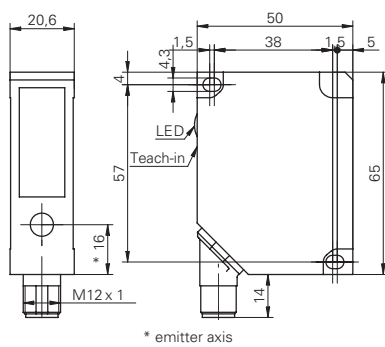

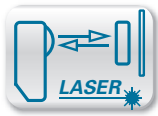

Tw = 100 ... 900 mm



- qTeach
- no black/white difference

#### general data

type	background suppression
light source	pulsed red laser diode
sensing distance Tw	100 ... 900 mm
sensing range Tb	100 ... 900 mm
power on indication	LED green
light indicator	LED yellow
sensing distance adjustment	Teach-in
laser class	1
wave length	656 nm
beam diameter	3,7 ... 13 mm
black/white shift	0%

#### electrical data

response time / release time	< 10 ms
voltage supply range +Vs	10 ... 30 VDC
current consumption max. (no load)	80 mA
voltage drop Vd	< 3,5 VDC
output function	light / dark operate
output circuit	push-pull
output current	< 100 mA
short circuit protection	yes
reverse polarity protection	yes

#### mechanical data

width / diameter	23,4 mm
height / length	63 mm
depth	45 mm
type	rectangular
housing material	plastic (SAN LURAN 378P)
front (optics)	PMMA

#### ambient conditions

operating temperature	0 ... +50 °C
protection class	IP 67
storage temperature	-10 ... +70 °C

#### order reference

**OHDK 25G6921**  
**OHDK 25G6921/S14**

#### connection types

cable, 2 m  
connector M12 5 pin

#### connection diagram

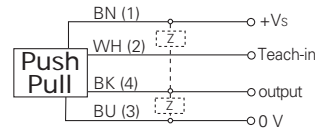

#### connectors and mating connectors

ESG 34AH0200 Connector M12, 4 pin, straight, 2 m

ESW 33AH0200 Connector M12, 4 pin, angular, 2 m

additional cable connectors and field wireable connectors: see accessories

#### Accessories

11077517 Mounting bracket for sensors series 25 (L design)  
for details: see accessories section

#### laser warning

**CLASS 1 LASER  
PRODUCT**

IEC 60825-1/2014  
Complies with 21 CFR 1040.10 and 1040.11  
except for deviations pursuant to laser  
notice No. 50, dated June 24, 2007

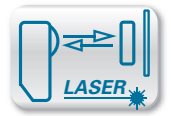

## sensing distance diagram

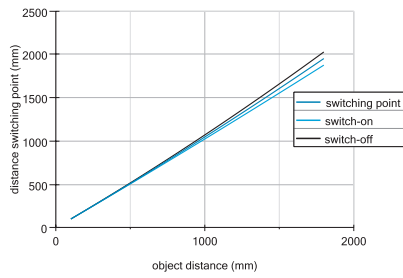

## dimension drawing

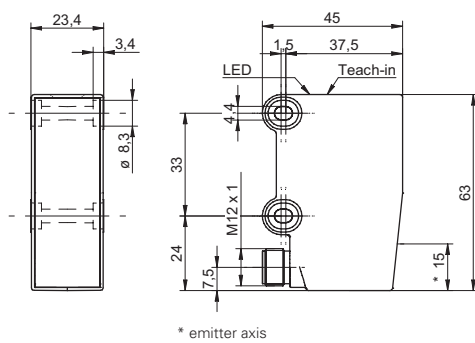

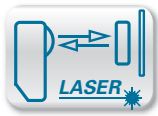

Tw = 100 ... 1750 mm



- qTeach
- no black/white difference
- 1 or 2 switching outputs

**general data**

type	background suppression
light source	pulsed red laser diode
sensing distance Tw	100 ... 1750 mm
sensing range Tb	100 ... 1750 mm
power on indication	LED green
light indicator	LED yellow
sensing distance adjustment	Teach-in
laser class	1
wave length	656 nm
beam diameter	3,7 ... 22 mm
black/white shift	0%

**electrical data**

response time / release time	< 10 ms
voltage supply range +Vs	10 ... 30 VDC
current consumption max. (no load)	80 mA
voltage drop Vd	< 3,5 VDC
output function	light / dark operate
output circuit	push-pull
output current	< 100 mA
short circuit protection	yes
reverse polarity protection	yes

**mechanical data**

width / diameter	23,4 mm
height / length	63 mm
depth	45 mm
type	rectangular
housing material	plastic (SAN LURAN 378P)
front (optics)	PMMA

**ambient conditions**

operating temperature	0 ... +50 °C
protection class	IP 67
storage temperature	-10 ... +70 °C

**connection diagrams**

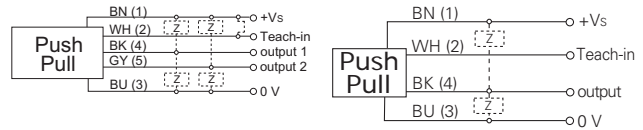

**connectors and mating connectors**

ESG 34AH0200	Connector M12, 4 pin, straight, 2 m
ESW 33AH0200	Connector M12, 4 pin, angular, 2 m
ESG 34CH0200	Connector M12, 5 pin, straight, 2 m
ESW 33CH0200	Connector M12, 5 pin, angular, 2 m
ESW 33CH0500	Connector M12, 5 pin, angular, 5 m

additional cable connectors and field wireable connectors: see accessories

**Accessories**

11077517	Mounting bracket for sensors series 25 (L design)
----------	---

for details: see accessories section

**laser warning**



IEC 60825-1/2014  
Complies with 21 CFR 1040.10 and 1040.11  
except for deviations pursuant to laser  
notice No. 50, dated June 24, 2007

**order reference**

order reference	connection types	number of outputs
OHDK 25G6911	cable, 2 m	1
OHDK 25G6911/S14	connector M12 5 pin	1
OHDK 25G6912	cable, 2 m	2
OHDK 25G6912/S14C	connector M12 5 pin	2

OHDK 25 Tw = 100 ... 1750 mm

Diffuse sensors with background suppression



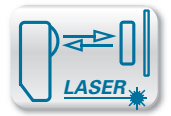

## sensing distance diagram

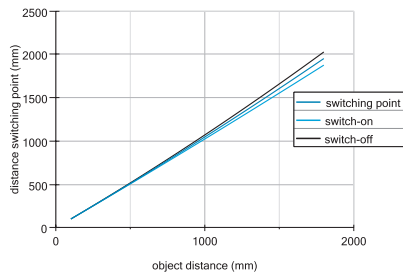

## dimension drawing

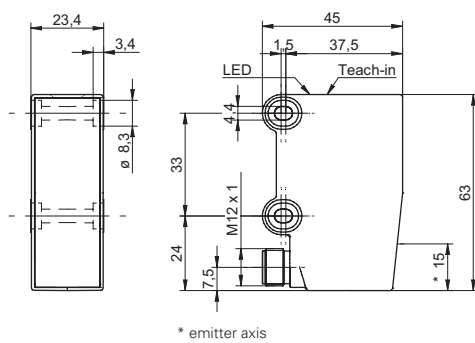

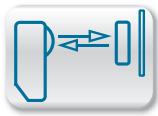

Tw = 10 ... 30 mm



- compact housing
- optimized for glass detection
- sensing distance adjustable via potentiometer

**general data**

type	background suppression
version	for glass detection
light source	pulsed red LED
sensing distance Tw	10 ... 30 mm
sensing range Tb (at Tw max.)	3 ... 30 mm
alignment / soiled lens indicator	flashing light indicator
light indicator	LED yellow
sensing distance adjustment	mechanical, 5 turn
wave length	660 nm
suppression of reciprocal influence	yes

**electrical data**

response time / release time	< 1 ms
voltage supply range +Vs	10 ... 30 VDC
current consumption max. (no load)	30 mA
current consumption typ.	20 mA
voltage drop Vd	< 1,8 VDC
output function	light / dark operate
output current	< 100 mA
short circuit protection	yes
reverse polarity protection	yes

**mechanical data**

width / diameter	10,4 mm
height / length	27 mm
depth	14 mm
type	rectangular
housing material	plastic (ASA)
front (optics)	PMMA
connection types	connector M8 4 pin

**ambient conditions**

operating temperature	-25 ... +65 °C
protection class	IP 67

**order reference      output circuit**

<b>FHDK 10N5160/S35A</b>	NPN
<b>FHDK 10P5160/S35A</b>	PNP

**connection diagrams**



**connectors and mating connectors**

ESG 32AH0200	Connector M8, 4 pin, straight, 2 m
ESW 31AH0200	Connector M8, 4 pin, angular, 2 m

additional cable connectors and field wireable connectors: see accessories

**Accessories**

10150326	Sensofix series 10 / series 20
10114501	Mounting bracket series 10 (U design)
10133792	Mounting bracket series 10 (L design)
10162083	Mounting panel for sensors series 10
10118798	Mounting bracket series 10

for details: see accessories section

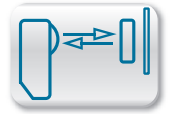

## sensing distance diagrams

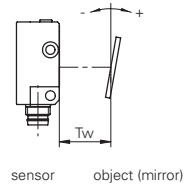
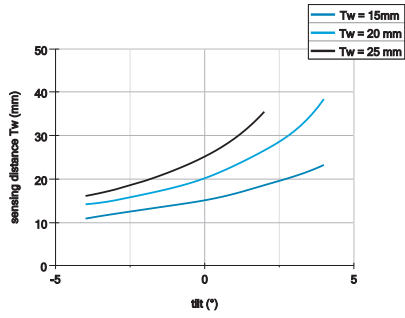

## dimension drawing

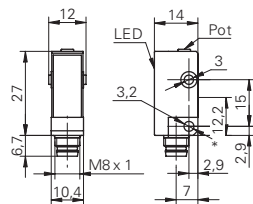

\* emitter axis

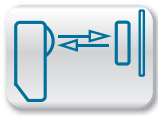

Tw = 200 mm



- One inch class
- washdown design
- PinPoint LED

#### general data

type	background suppression
special type	Washdown design
light source	pulsed PinPoint LED
sensing distance Tw	30 ... 200 mm
sensing range Tb	15 ... 200 mm
power on indication	LED green
light indicator	LED yellow
sensing distance adjustment	Teach-in and IO-Link
wave length	630 nm
suppression of reciprocal influence	yes
alignment optical axis	< 2°
approvals/certificates	Ecolab

#### electrical data

response time / release time	< 0,49 ms
voltage supply range +Vs	10 ... 30 VDC
current consumption max. (no load)	45 mA
current consumption typ.	30 mA
voltage drop Vd	< 3 VDC
output function	light / dark operate
output circuit	push-pull
output current	< 100 mA
short circuit protection	yes
reverse polarity protection	yes

#### mechanical data

width / diameter	16,5 mm
height / length	34,7 mm
depth	28,2 mm
type	rectangular
housing material	stainless steel 1.4404 (V4A)
front (optics)	PMMA
connection types	connector M8 4 pin

#### ambient conditions

operating temperature	-25 ... +60 °C
protection class	IP 68/69K & proTect+

#### order reference

O300W.GP-11127755

#### connection diagram

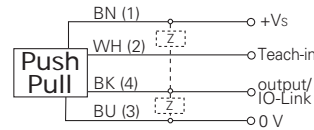

#### connectors and mating connectors

ESG 32AY0200	Connector M8, 4 pin, straight, 2 m, V4A-PP
ESW 31AY0200	Connector M8, 4 pin, angular, 2 m, V4A-PP

additional cable connectors and field wireable connectors: see accessories

#### Accessories

11104963	Sensofix O300
11102423	Mounting bracket O300 (L design)
11124807	Mounting bracket O300 - Retrofit for sensors series 20

for details: see accessories section

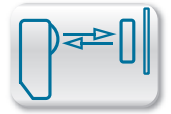

## sensing distance diagram

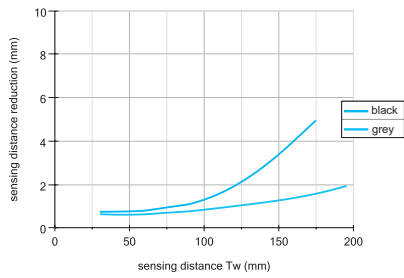

## beam characteristic (typically)

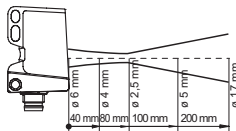

## dimension drawing

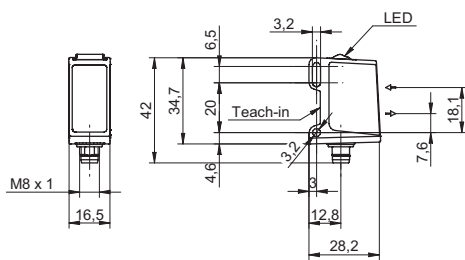

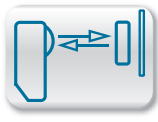

Tw = 200 mm

- One inch class
- hygienic design
- PinPoint LED

**general data**

type	background suppression
special type	hygienic design
light source	pulsed PinPoint LED
sensing distance Tw	30 ... 200 mm
sensing range Tb	15 ... 200 mm
power on indication	LED green
light indicator	LED yellow
sensing distance adjustment	Teach-in and IO-Link
wave length	630 nm
suppression of reciprocal influence	yes
alignment optical axis	< 2°
approvals/certificates	Ecolab

**electrical data**

response time / release time	< 0,49 ms
voltage supply range +Vs	10 ... 30 VDC
current consumption max. (no load)	45 mA
current consumption typ.	30 mA
voltage drop Vd	< 3 VDC
output function	light / dark operate
output circuit	push-pull
output current	< 100 mA
short circuit protection	yes
reverse polarity protection	yes

**mechanical data**

width / diameter	16,5 mm
height / length	34,6 mm
depth	28,7 mm
type	rectangular
housing material	stainless steel 1.4404 (V4A)
front (optics)	PMMA

**ambient conditions**

operating temperature	-25 ... +60 °C
protection class	IP 68/69K & proTect+

**order reference**

<b>O300H.GP-11127745</b>	cable 4 pin, 2 m
<b>O300H.GP-11157157</b>	flylead connector M8, L=200 mm

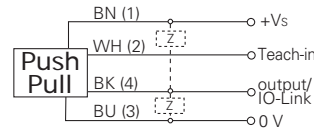
**connection types****connection diagram****connectors and mating connectors**

ESG 32AY0200	Connector M8, 4 pin, straight, 2 m, V4A-PP
ESW 31AY0200	Connector M8, 4 pin, angular, 2 m, V4A-PP

additional cable connectors and field wireable connectors: see accessories

**Accessories**

HI11-1H	Mounting for sensors in hygienic design Ø 11 mm
11137318	Teach Pen for sensors in metal housing
11141124	Teach Pen for sensors in metal housing (USA, CAN, JP)

for details: see accessories section

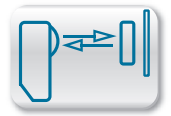

sensing distance diagram

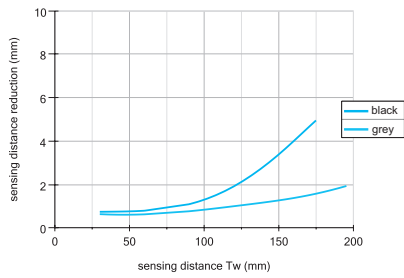

beam characteristic (typically)

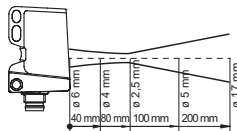

dimension drawings

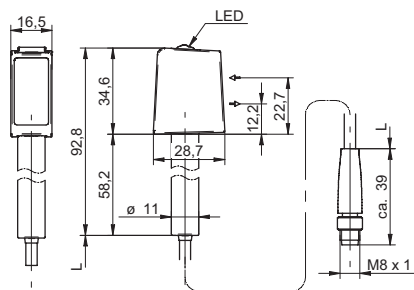
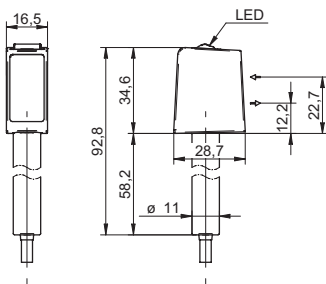

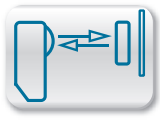

Tw = 50 ... 400 mm

- washdown design
- IO-Link
- Remote Teach-in

**general data**

type	background suppression
special type	Washdown design
light source	pulsed red LED
sensing distance Tw	50 ... 400 mm
sensing range Tb (at Tw max.)	20 ... 400 mm
sensing range Tb (at Tw min.)	20 ... 50 mm
power on indication	LED green
output indicator	LED red
sensing distance adjustment	Teach-in
wave length	660 nm
approvals/certificates	Ecolab

**electrical data**

response time / release time	< 1,8 ms
voltage supply range +Vs	10 ... 30 VDC
current consumption max. (no load)	40 mA
current consumption typ.	35 mA
voltage drop Vd	< 2 VDC
output function	light / dark operate
output circuit	push-pull
output current	< 100 mA
short circuit protection	yes
reverse polarity protection	yes

**mechanical data**

width / diameter	19,6 mm
height / length	51 mm
depth	34,3 mm
type	rectangular
housing material	stainless steel 1.4404 (V4A)
front (optics)	PMMA
connection types	connector M12

**ambient conditions**

operating temperature	-30 ... +60 °C
protection class	IP 68/69K & proTect+
storage temperature	-30 ... +70 °C

**order reference**

order reference	sensitivity adjustment
FHDR 14G6901/S14	-
FHDR 14G6901/S14/IO	IO-Link

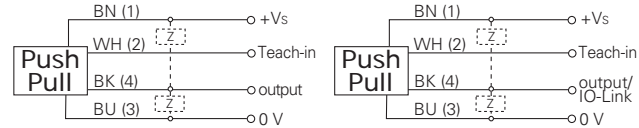
**connection diagrams****connectors and mating connectors**

ESG 34AY0200 Connector M12, 4 pin, straight, 2 m, V4A-PP

ESW 33AY0200 Connector M12, 4 pin, angular, 2 m, V4A-PP

additional cable connectors and field wireable connectors: see accessories

**Accessories**

11046278 Mounting bracket series 14 washdown

11046279 Sensofix series 14 washdown

for details: see accessories section

**remarks**

Sensor FDA compliant and Ecolab approved  
 IO-Link: output signal, service status, object presence  
 sensitivity adjustable: via Teach-in wire input  
 LSR = Liquid Silicon Rubber



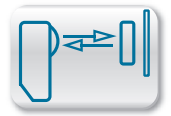

## sensing distance diagram

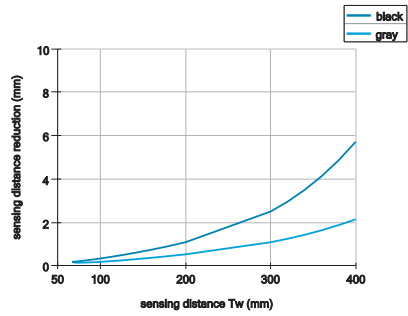

## dimension drawing

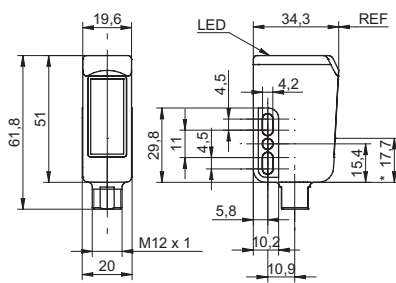

\* emitter axis

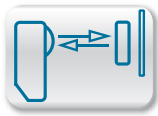

Tw = 50 ... 400 mm



- hygienic design
- remote Teach-in

**general data**

type	background suppression
special type	hygienic design
light source	pulsed red LED
sensing distance Tw	50 ... 400 mm
sensing range Tb (at Tw max.)	20 ... 400 mm
sensing range Tb (at Tw min.)	20 ... 50 mm
power on indication	LED green
output indicator	LED red
sensing distance adjustment	Teach-in
wave length	660 nm
approvals/certificates	Ecolab EHEDG

**electrical data**

response time / release time	< 1,8 ms
voltage supply range +Vs	10 ... 30 VDC
current consumption max. (no load)	40 mA
current consumption typ.	35 mA
voltage drop Vd	< 2 VDC
output function	light / dark operate
output circuit	push-pull
output current	< 100 mA
short circuit protection	yes
reverse polarity protection	yes

**mechanical data**

width / diameter	19,6 mm
height / length	52,2 mm
depth	34,3 mm
type	rectangular
housing material	stainless steel 1.4404 (V4A)
front (optics)	PMMA

**ambient conditions**

operating temperature	-30 ... +60 °C
protection class	IP 68/69K & proTect+
storage temperature	-30 ... +70 °C

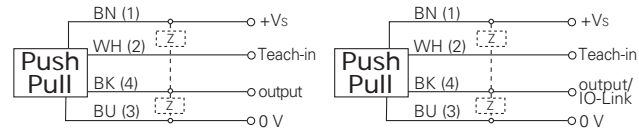
**connection diagrams****connectors and mating connectors**

ESG 34AY0200 Connector M12, 4 pin, straight, 2 m, V4A-PP

ESW 33AY0200 Connector M12, 4 pin, angular, 2 m, V4A-PP

additional cable connectors and field wireable connectors: see accessories

**Accessories**HI17-1H Mounting for sensors in hygienic design Ø 17 mm  
for details: see accessories section**remarks**

Sensor FDA compliant, EHEDG certified and Ecolab approved  
 IO-Link: output signal, service status, object presence  
 sensitivity adjustable: via Teach-in wire input  
 LSR = Liquid Silicon Rubber

order reference	connection types	sensitivity adjustment
FHDH 14G6901	cable 4 pin, 2 m	-
FHDH 14G6901/IO	cable 4 pin, 2 m	IO-Link
FHDH 14G6901/KS34A	flylead connector M12, L=300 mm	-
FHDH 14G6901/KS34A/IO	flylead connector M12, L=300 mm	IO-Link

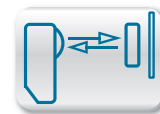

sensing distance diagram

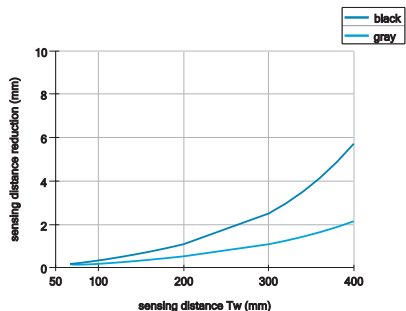

dimension drawings

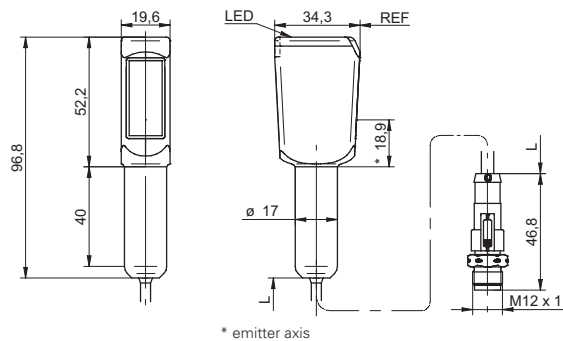
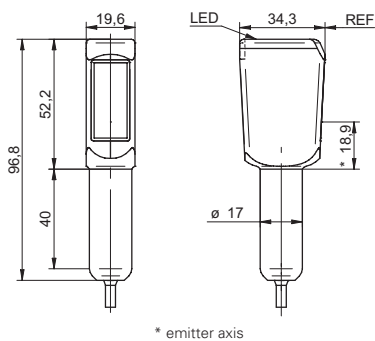

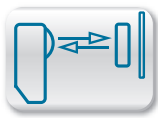

Tw = 400 mm

- hygienic design
- PinPoint LED
- small beam diameter

**general data**

type	background suppression
special type	hygienic design
light source	pulsed PinPoint LED
sensing distance Tw	60 ... 400 mm
sensing range Tb	30 ... 400 mm
power on indication	LED green
light indicator	LED yellow
sensing distance adjustment	Teach-in and IO-Link
wave length	630 nm
suppression of reciprocal influence	yes
alignment optical axis	< 1°
approvals/certificates	Ecolab

**electrical data**

response time / release time	< 0,49 ms
voltage supply range +Vs	10 ... 30 VDC
current consumption max. (no load)	40 mA
current consumption typ.	30 mA
voltage drop Vd	< 3 VDC
output function	light / dark operate
output circuit	push-pull
output current	< 100 mA
short circuit protection	yes
reverse polarity protection	yes

**mechanical data**

width / diameter	20,2 mm
height / length	47,7 mm
depth	36,4 mm
type	rectangular
housing material	stainless steel 1.4404 (V4A)
front (optics)	PMMA

**ambient conditions**

operating temperature	-25 ... +60 °C
protection class	IP 68/69K & proTect+

**order reference**

order reference	connection types
O500H.GP-11125101	cable 4 pin, 2 m
O500H.GP-11125102	flylead connector M12, L=300 mm

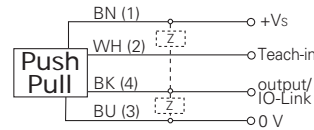
**connection diagram****connectors and mating connectors**

ESG 34AY0200	Connector M12, 4 pin, straight, 2 m, V4A-PP
ESW 33AY0200	Connector M12, 4 pin, angular, 2 m, V4A-PP

additional cable connectors and field wireable connectors: see accessories

**Accessories**

HI17-1H	Mounting for sensors in hygienic design Ø 17 mm
11137318	Teach Pen for sensors in metal housing
11141124	Teach Pen for sensors in metal housing (USA, CAN, JP)

for details: see accessories section

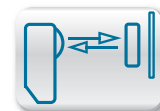

## sensing distance diagram

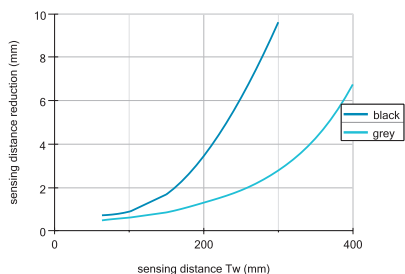

## beam characteristic (typically)

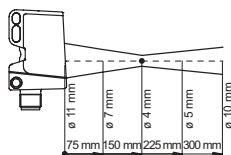

## dimension drawings

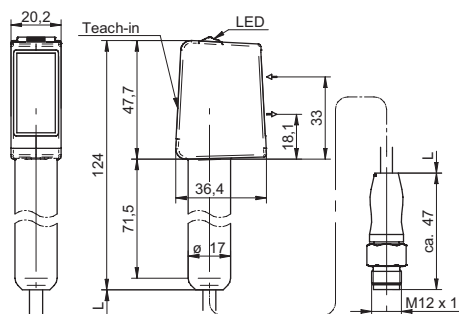
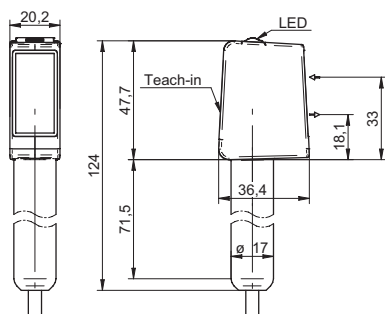

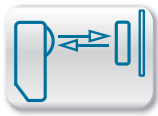

Tw = 400 mm



- washdown design
- PinPoint LED
- small beam diameter

#### general data

type	background suppression
special type	Washdown design
light source	pulsed PinPoint LED
sensing distance Tw	60 ... 400 mm
sensing range Tb	30 ... 400 mm
power on indication	LED green
light indicator	LED yellow
sensing distance adjustment	Teach-in and IO-Link
wave length	630 nm
suppression of reciprocal influence	yes
alignment optical axis	< 1°
approvals/certificates	Ecolab

#### electrical data

response time / release time	< 0,49 ms
voltage supply range +Vs	10 ... 30 VDC
current consumption max. (no load)	40 mA
current consumption typ.	30 mA
voltage drop Vd	< 3 VDC
output function	light / dark operate
output circuit	push-pull
output current	< 100 mA
short circuit protection	yes
reverse polarity protection	yes

#### mechanical data

width / diameter	20,2 mm
height / length	47,2 mm
depth	37,7 mm
type	rectangular
housing material	stainless steel 1.4404 (V4A)
front (optics)	PMMA
connection types	connector M12 4 pin

#### ambient conditions

operating temperature	-25 ... +60 °C
protection class	IP 68/69K & proTect+

#### order reference

O500W.GP-11125092

#### connection diagram

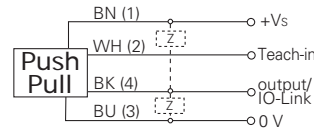

#### connectors and mating connectors

ESG 34AY0200	Connector M12, 4 pin, straight, 2 m, V4A-PP
ESW 33AY0200	Connector M12, 4 pin, angular, 2 m, V4A-PP

additional cable connectors and field wireable connectors: see accessories

#### Accessories

11092246	Mounting bracket O500/U500 (L design)
11111164	Mounting bracket O500/U500 - Retrofit for sensors series 30
11099942	Sensofix O500/U500

for details: see accessories section

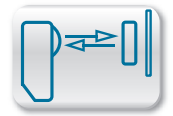

sensing distance diagram

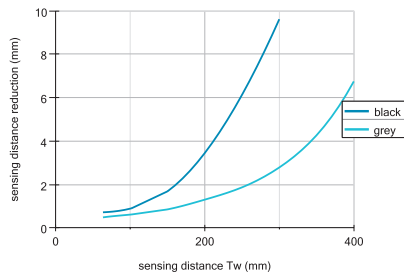

beam characteristic (typically)

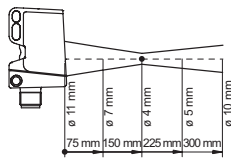

dimension drawing

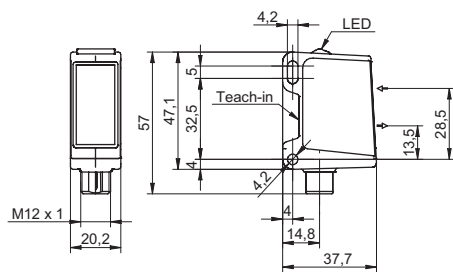

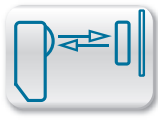

Tw = 400 mm



- washdown design
- PinPoint LED
- small beam diameter

**general data**

type	background suppression
special type	Washdown design
light source	pulsed PinPoint LED
sensing distance Tw	60 ... 400 mm
sensing range Tb	30 ... 400 mm
power on indication	LED green
light indicator	LED yellow
sensing distance adjustment	Teach-in and IO-Link
wave length	630 nm
suppression of reciprocal influence	yes
alignment optical axis	< 1°
approvals/certificates	Ecolab

**electrical data**

response time / release time	< 0,49 ms
voltage supply range +Vs	10 ... 30 VDC
current consumption max. (no load)	40 mA
current consumption typ.	30 mA
voltage drop Vd	< 3 VDC
output function	light / dark operate
output circuit	push-pull
output current	< 100 mA
short circuit protection	yes
reverse polarity protection	yes

**mechanical data**

width / diameter	20,2 mm
height / length	47,9 mm
depth	37,7 mm
type	rectangular
housing material	stainless steel 1.4404 (V4A)
front (optics)	PMMA
connection types	connector M12 4 pin

**ambient conditions**

operating temperature	-25 ... +60 °C
protection class	IP 68/69K & proTect+

**order reference**

O500W.GP-11137000

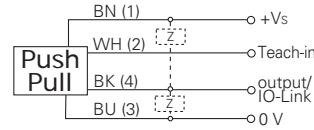
**connection diagram****connectors and mating connectors**

ESG 34AY0200 Connector M12, 4 pin, straight, 2 m, V4A-PP

ESW 33AY0200 Connector M12, 4 pin, angular, 2 m, V4A-PP

additional cable connectors and field wireable connectors: see accessories

**Accessories**

11092246	Mounting bracket O500/U500 (L design)
11111164	Mounting bracket O500/U500 - Retrofit for sensors series 30
11099942	Sensofix O500/U500
10134964	Mounting bracket series 14 (L design)
10149011	Sensofix series 14
11137318	Teach Pen for sensors in metal housing
11141124	Teach Pen for sensors in metal housing (USA, CAN, JP)

for details: see accessories section



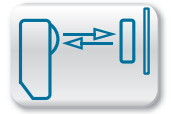

sensing distance diagram

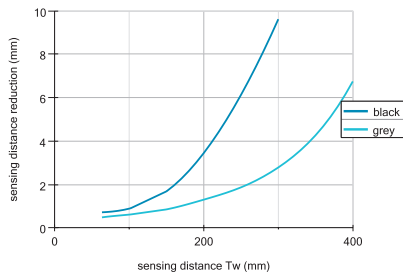

beam characteristic (typically)

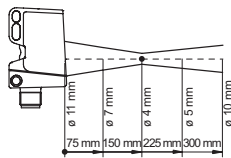

dimension drawing

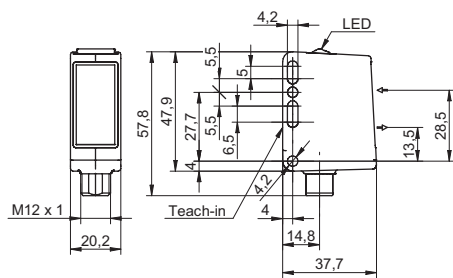

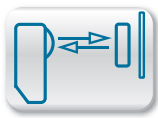

Tw = 120 mm



- washdown design
- sensing distance adjustable via potentiometer

**general data**

type	background suppression
special type	Washdown design
light source	pulsed red LED
sensing distance Tw	40 ... 120 mm
sensing range Tb	5 ... 120 mm
power on indication	LED green
output indicator	LED yellow
sensing distance adjustment	mechanical, 4 turn
wave length	660 nm
suppression of reciprocal influence	no

**electrical data**

response time / release time	< 1 ms
voltage supply range +Vs	12 ... 30 VDC
current consumption max. (no load)	40 mA
current consumption typ.	30 mA
voltage drop Vd	< 2 VDC
output function	light / dark operate
output current	< 100 mA
short circuit protection	yes
reverse polarity protection	yes

**mechanical data**

width / diameter	18 mm
height / length	71,9 mm
type	cylindrical threaded
housing material	stainless steel 1.4404 (V4A), plastic (ABS TERLURAN)
front (optics)	PMMA
connection types	connector M12 4 pin

**ambient conditions**

operating temperature	-25 ... +55 °C
protection class	IP 67/69K

**order reference**

OR18W.GR-11157857

**output circuit**

NPN

OR18W.GR-11157856

PNP

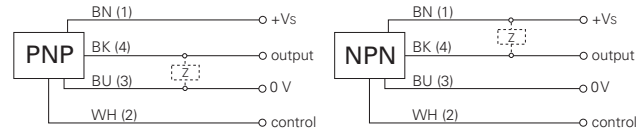
**connection diagrams****connectors and mating connectors**

ESG 34AY0200	Connector M12, 4 pin, straight, 2 m, V4A-PP
ESW 33AY0200	Connector M12, 4 pin, angular, 2 m, V4A-PP

additional cable connectors and field wireable connectors: see accessories

**Accessories**

10151658	Sensofix series 18
ZADAP-M18.STANDARD	Mounting bracket series 18
ZADAP-M18.SHORT	Mounting bracket short series 18 (L design)
ZADAP-M18.LONG	Mounting bracket long series 18 (L design)
ZADAP-M18.SWING	Mounting bracket for adjustment for sensors series 18
ZADAP-M18.MICRO	Mounting bracket for adjustment for sensors series 18

for details: see accessories section

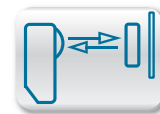

## sensing distance diagram

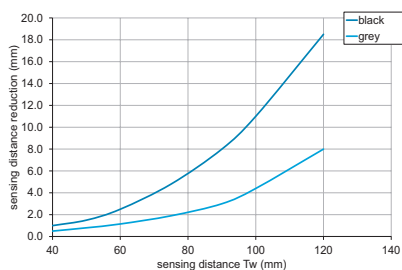

## beam characteristic (typically)

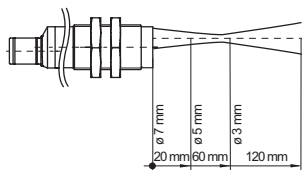

## dimension drawing

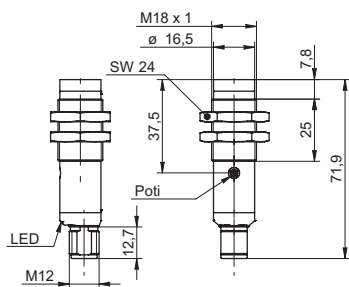

## red light LED version

product family	FZCK 07	FZDK 07	FZDM 08	FZDK 10	FZDK 14	FZDM 16	FZDK 20
							
	<i>MINOS</i>	<i>MINOS</i>					
	subminiature	subminiature	subminiature	miniature	standard	standard	standard
width / diameter	8 mm	8 mm	8 mm	10,4 mm	14,8 mm	15,4 mm	20 mm
sensing distance Tv	20 ... 150 mm	20 ... 150 mm	< 40 mm < 80 mm	5 ... 200 mm	5 ... 600 mm	0 ... 400 mm	5 ... 500 mm
response time / release time	< 0,5 ms	< 0,5 ms	< 1 ms	< 1 ms	< 1 ms	< 1 ms	< 0,5 ms
light source	pulsed red LED	pulsed red LED	pulsed infrared diode	pulsed red LED	pulsed red LED	pulsed infrared diode	pulsed red LED
sensitivity adjustment	Teach-in	Teach-in	no	potentiometer, 270°	potentiometer, 270°	potentiometer, 270°	potentiometer, 270°
sensing distance adjustment							
output circuit	NPN PNP	NPN PNP	PNP	NPN PNP	NPN PNP	NPN PNP	NPN PNP
connection types	cable flylead connector	cable flylead connector	cable connector	flylead connector cable connector	cable connector	cable connector	connector
housing material	plastic	plastic	metal	plastic	plastic	metal	plastic
protection class	IP 65	IP 65	IP 65	IP 65 IP 67	IP 67	IP 67	IP 67
<b>page</b>	<b>370</b>	<b>372</b>	<b>374</b>	<b>376</b>	<b>378</b>	<b>380</b>	<b>382</b>

O300.ZR	O500.ZR	FZAM 08	FZAM 12	OR18.ZI	FZAM 18	FZAM 18	FZAM 18	FZAM 30
								
miniature	standard	subminiature	miniature	standard	standard	standard	standard	standard
12,9 mm	18 mm	8 mm	12 mm	18 mm	18 mm	18 mm	18 mm	30 mm
10 ... 400 mm	20 ... 600 mm	< 40 mm < 80 mm	30 ... 200 mm	0 ... 80 mm 0 ... 300 mm 0 ... 800 mm	60 ... 430 mm	20 ... 150 mm	60 ... 430 mm	100 ... 700 mm 300 ... 1500 mm
< 1 ms	< 1 ms	< 1 ms	< 1 ms	< 1 ms	< 1 ms	< 0,5 ms	< 1 ms	< 0,25 ms < 2,5 ms
pulsed red LED	pulsed red LED	pulsed infrared diode	pulsed infrared diode	pulsed infrared diode	pulsed infrared diode	pulsed infrared diode	pulsed infrared diode	pulsed infrared diode
		no	potentiometer, 270°		Teach-in	potentiometer, 15 turn	potentiometer, 270°	potentiometer, 15 turn
qTeach	qTeach			potentiometer, 270°				
push-pull	push-pull	PNP	NPN PNP	NPN PNP	NPN PNP	NPN PNP	NPN PNP	NPN PNP
cable connector	cable connector	cable connector	connector cable	connector cable flylead connector	cable connector	cable	cable connector	cable
plastic	plastic	metal	metal	plastic	metal	metal	metal	metal
IP 67	IP 67	IP 65	IP 65	IP 67	IP 67	IP 65	IP 67	IP 65
<b>384</b>	<b>386</b>	<b>388</b>	<b>390</b>	<b>392</b>	<b>394</b>	<b>396</b>	<b>398</b>	<b>400</b>

## red light LED version

product family	OR18W.ZI
----------------	----------





	standard
width / diameter	18 mm
sensing distance Tw	0 ... 300 mm 0 ... 800 mm
response time / release time	< 1 ms
light source	pulsed infrared diode
sensing distance adjustment	potentiometer, 270°
output circuit	NPN PNP
connection types	connector
housing material	metal
protection class	IP 67/69K

page	402
------	-----



laser version

product family	OZDK 10	OZDK 10	O300.ZL	OZDK 14	OZDM 16	OZDM 16	OR18.ZL
							
version	miniature	miniature	miniature	standard	standard	standard	standard
width / diameter	10,4 mm	10,4 mm	12,9 mm	14,8 mm	15,4 mm	15,4 mm	18 mm
sensing distance $T_w$	3 ... 150 mm	3 ... 150 mm	10 ... 250 mm	20 ... 300 mm	0 ... 250 mm	0 ... 250 mm	10 ... 300 mm
response time / release time	< 0,05 ms	< 0,05 ms	< 0,1 ms	< 0,15 ms	< 0,05 ms	< 0,1 ms	< 0,34 ms
light source	pulsed red laser diode	pulsed red laser diode	pulsed red laser diode	pulsed red laser diode	pulsed red laser diode	pulsed red laser diode	pulsed red laser diode
sensitivity adjustment	potentiometer, 5 turn	potentiometer, 5 turn		Teach-in	potentiometer, 14 turn	potentiometer, 14 turn	
sensing distance adjustment			Teach-in and IO-Link qTeach				potentiometer, 270°
output circuit	NPN PNP	NPN PNP	push-pull NPN PNP	NPN PNP	NPN PNP	PNP	NPN PNP
connection types	cable connector	cable connector	cable connector	connector cable	cable connector	cable connector	cable connector
housing material	plastic	plastic	plastic	plastic	metal	metal	metal
	 <b>IO-Link</b>						
protection class	IP 65 IP 67	IP 65 IP 67	IP 67	IP 67	IP 67	IP 67	IP 67
<b>page</b>	<b>404</b>	<b>406</b>	<b>408</b>	<b>410</b>	<b>412</b>	<b>414</b>	<b>416</b>







## General information

The emitter and receiver are in the same housing. The emitted infrared, red or laser light is reflected directly by the target back to the sensor. If the target reflects sufficiently well, the received light causes the sensor to switch.

## Applications

- Differentiation and sorting of objects, e.g. by size, degree of reflection etc.
- Counting of objects
- Presence check, e.g. of a paper stack.

## Characteristics and advantages

- Exploitation of the reflection from the target
  - Suitable to discern black from white
  - Relatively large active range
  - Simple installation (only one sensor)
  - Short response time
- The sensing distance depends largely on the reflective properties of the object surface.
- Positioning and monitoring with just one sensor.

## Technology and operation

The light shining on the target is largely diffused and reflected back in all directions. A very small part of this remitted light is observed by the receiver. If the target reflects sufficiently well, the received light causes the sensor to switch.

As the sensor operates with the reflection from the materials, the surface properties, color and gloss have a great influence on the switching distance.

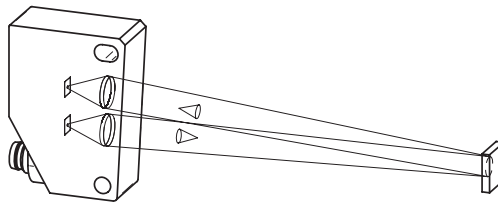



## Mounting and adjustment

With diffuse sensors operating by the intensity difference principle, the relative receiving signal is specified. This represents the signal level received from a white object as a function of the distance. Using this diagram, the sensing range can be determined for an object which is not white. The correction factor of the respective material is required for this purpose.

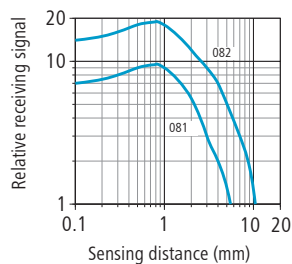

### Correction factor

The material and surface properties of the object (representing the reflectivity) influence the switching distance of a diffuse sensor with intensity difference. To determine the corrected switching distance, the following values must therefore be applied to the relative receiving signal (KFs) or in approximation to the distance (KFd).

Material	KFs	KFd
Kodak test card	100 %	100 %
Pale, planed wood	80 %	90 %
Rough wood	20 %	45 %
Drawn aluminum	25 %	50 %
Cardboard, matte black	7 %	26 %

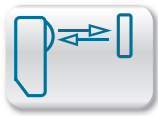

$T_w = 20 \dots 150 \text{ mm}$



- compact housing
- sensitivity adjustable via Teach-in
- suppression of mutual optical interference

#### general data

type	intensity difference
light source	pulsed red LED
sensing distance $T_w$	20 ... 150 mm
alignment / soiled lens indicator	flashing light indicator
light indicator	LED green
output indicator	LED yellow
sensitivity adjustment	Teach-in
wave length	660 nm
suppression of reciprocal influence	yes

#### electrical data

response time / release time	< 0,5 ms
voltage supply range +Vs	10 ... 30 VDC
current consumption max. (no load)	25 mA
current consumption typ.	20 mA
voltage drop Vd	< 1,8 VDC
output function	light / dark operate
output current	< 100 mA
short circuit protection	yes
reverse polarity protection	yes

#### mechanical data

width / diameter	8 mm
height / length	16,2 mm
depth	10,8 mm
type	rectangular
housing material	plastic (PMMA, MABS, PA)
front (optics)	PMMA

#### ambient conditions

operating temperature	-20 ... +50 °C
protection class	IP 65

#### connection diagrams

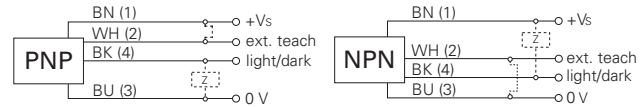

#### connectors and mating connectors

ESG 32AH0200	Connector M8, 4 pin, straight, 2 m
ESW 31AH0200	Connector M8, 4 pin, angular, 2 m

additional cable connectors and field wireable connectors: see accessories

#### Accessories

10150844	Minifix mounting 07
----------	---------------------

for details: see accessories section

order reference	connection types	output circuit
FZCK 07N6901	cable rear side, 2 m	NPN
FZCK 07N6901/KS35A	flylead connector M8 4 pin, L=200 mm	NPN
FZCK 07P6901	cable rear side, 2 m	PNP
FZCK 07P6901/KS35A	flylead connector M8 4 pin, L=200 mm	PNP

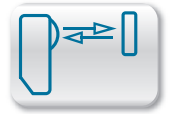

relative receiving signal

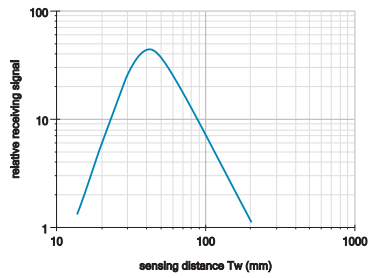

dimension drawings

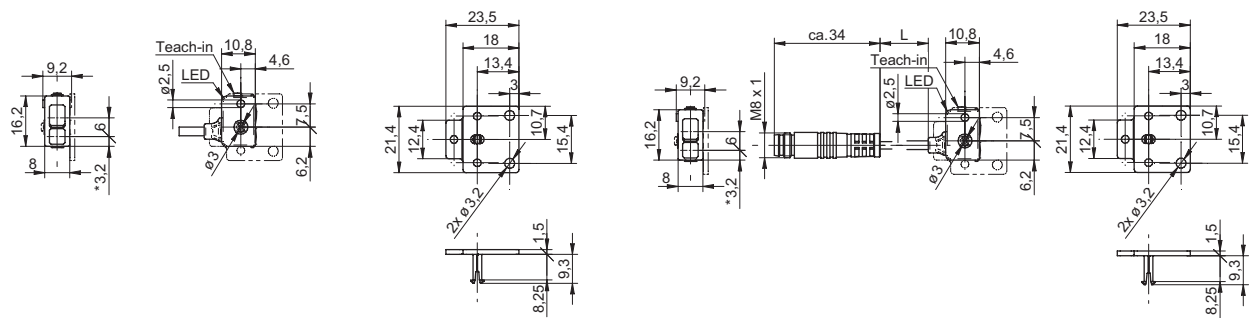

\* emitter axis

\* emitter axis cable length  $L = 200$  mm

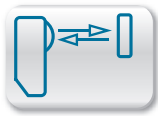

$T_w = 20 \dots 150 \text{ mm}$



- compact housing
- sensitivity adjustable via Teach-in
- suppression of mutual optical interference

#### general data

type	intensity difference
light source	pulsed red LED
sensing distance $T_w$	20 ... 150 mm
alignment / soiled lens indicator	flashing light indicator
light indicator	LED green
output indicator	LED yellow
sensitivity adjustment	Teach-in
wave length	660 nm
suppression of reciprocal influence	yes

#### electrical data

response time / release time	< 0,5 ms
voltage supply range +Vs	10 ... 30 VDC
current consumption max. (no load)	25 mA
current consumption typ.	20 mA
voltage drop Vd	< 1,8 VDC
output function	light / dark operate
output current	< 100 mA
short circuit protection	yes
reverse polarity protection	yes

#### mechanical data

width / diameter	8 mm
height / length	16,2 mm
depth	10,8 mm
type	rectangular
housing material	plastic (PMMA, MABS, PA)
front (optics)	PMMA

#### ambient conditions

operating temperature	-20 ... +50 °C
protection class	IP 65

#### connection diagrams



#### connectors and mating connectors

ESG 32AH0200	Connector M8, 4 pin, straight, 2 m
ESW 31AH0200	Connector M8, 4 pin, angular, 2 m

additional cable connectors and field wireable connectors: see accessories

#### Accessories

10150844	Minifix mounting 07
----------	---------------------

for details: see accessories section

order reference	connection types	output circuit
FZDK 07N6901	cable bottom side, 2 m	NPN
FZDK 07N6901/KS35A	flylead connector M8 4 pin, L=200 mm	NPN
FZDK 07P6901	cable bottom side, 2 m	PNP
FZDK 07P6901/KS35A	flylead connector M8 4 pin, L=200 mm	PNP

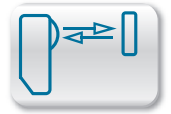

relative receiving signal

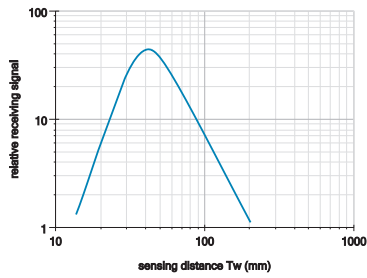

dimension drawings

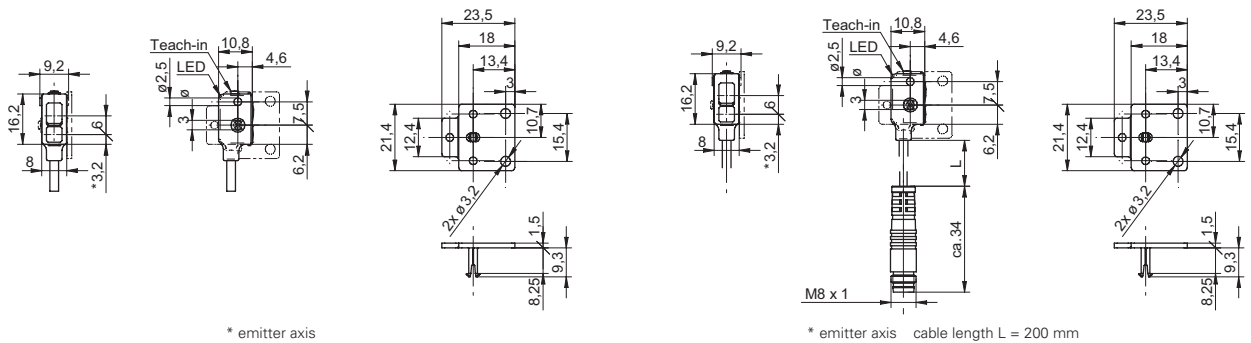

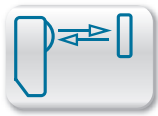

$T_w = 80 \text{ mm}$

- subminiature metal housing
- fixed sensing distance



#### general data

type	intensity difference
light source	pulsed infrared diode
alignment / soiled lens indicator	flashing light indicator
light indicator	LED red
sensitivity adjustment	no
wave length	880 nm
suppression of reciprocal influence	yes

#### electrical data

response time / release time	< 1 ms
voltage supply range +Vs	10 ... 30 VDC
current consumption max. (no load)	42 mA
current consumption typ.	20 mA
voltage drop Vd	< 2 VDC
output circuit	PNP
output current	< 100 mA
short circuit protection	yes
reverse polarity protection	yes

#### mechanical data

width / diameter	8 mm
height / length	58 mm
depth	12 mm
type	rectangular
housing material	aluminum anodized
front (optics)	PC

#### ambient conditions

operating temperature	-25 ... +65 °C
protection class	IP 65

#### connection diagram

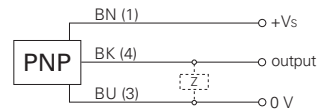

#### connectors and mating connectors

ESG 32SH0200	Connector M8, 3 pin, straight, 2 m
ESW 31SH0200	Connector M8, 3 pin, angular, 2 m
additional cable connectors and field wireable connectors: see accessories	

order reference	sensing distance $T_w$	connection types	output function
FZDM 08P1001	< 40 mm	cable 3 pin, 2 m	light operate
FZDM 08P1001/S35L	< 40 mm	connector M8, 3 pin	light operate
FZDM 08P1002	< 80 mm	cable 3 pin, 2 m	light operate
FZDM 08P1002/S35L	< 80 mm	connector M8, 3 pin	light operate
FZDM 08P3001	< 40 mm	cable 3 pin, 2 m	dark operate
FZDM 08P3001/S35L	< 40 mm	connector M8, 3 pin	dark operate
FZDM 08P3002	< 80 mm	cable 3 pin, 2 m	dark operate
FZDM 08P3002/S35L	< 80 mm	connector M8, 3 pin	dark operate



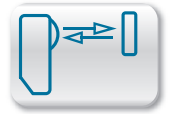

## relative receiving signals

Tw < 40 mm

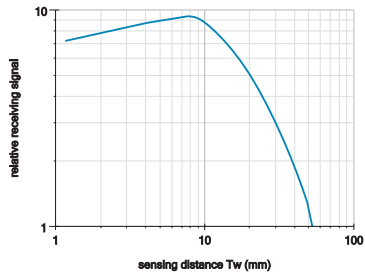

Tw < 80 mm

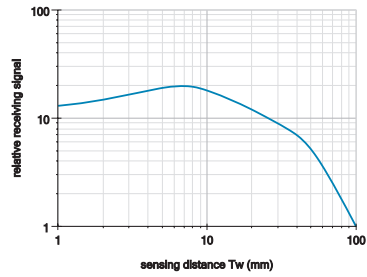

## dimension drawings

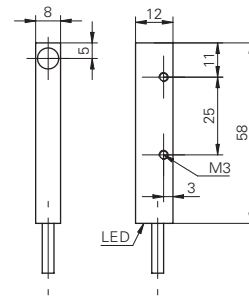
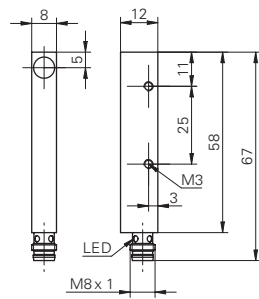

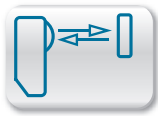

Tw = 5 ... 200 mm

- compact housing
- sensing distance adjustable via potentiometer



**general data**

type	intensity difference
light source	pulsed red LED
sensing distance Tw	5 ... 200 mm
alignment / soiled lens indicator	flashing light indicator
light indicator	LED yellow
sensitivity adjustment	potentiometer, 270°
wave length	660 nm
suppression of reciprocal influence	yes

**electrical data**

response time / release time	< 1 ms
voltage supply range +Vs	10 ... 30 VDC
current consumption max. (no load)	30 mA
current consumption typ.	20 mA
voltage drop Vd	< 1,8 VDC
output current	< 100 mA
short circuit protection	yes
reverse polarity protection	yes

**mechanical data**

width / diameter	10,4 mm
height / length	27 mm
depth	14 mm
type	rectangular
housing material	plastic (ASA)
front (optics)	PMMA

**ambient conditions**

operating temperature	-25 ... +65 °C
-----------------------	----------------

**connection diagrams**

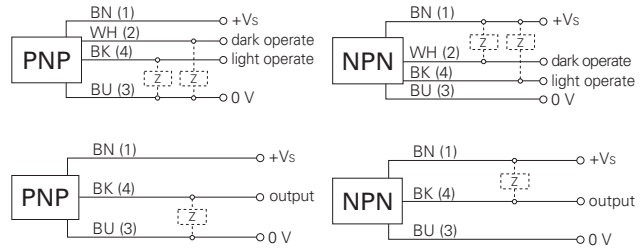

**connectors and mating connectors**

ESG 32SH0200	Connector M8, 3 pin, straight, 2 m
ESW 31SH0200	Connector M8, 3 pin, angular, 2 m
ESG 32AH0200	Connector M8, 4 pin, straight, 2 m
ESW 31AH0200	Connector M8, 4 pin, angular, 2 m

additional cable connectors and field wireable connectors: see accessories

**Accessories**

10150326	Sensofix series 10 / series 20
10114501	Mounting bracket series 10 (U design)
10133792	Mounting bracket series 10 (L design)
10162083	Mounting panel for sensors series 10
10118798	Mounting bracket series 10

for details: see accessories section

order reference	connection types	output circuit	output function	protection class
FZDK 10N1101/KS35	flylead connector M8 3 pin	NPN	light operate	IP 65
FZDK 10N5101	cable 4 pin, 2 m	NPN	light / dark operate	IP 65
FZDK 10N5101/S35A	connector M8 4 pin	NPN	light / dark operate	IP 67
FZDK 10P1101/KS35	flylead connector M8 3 pin	PNP	light operate	IP 65
FZDK 10P5101	cable 4 pin, 2 m	PNP	light / dark operate	IP 65
FZDK 10P5101/S35A	connector M8 4 pin	PNP	light / dark operate	IP 67

FZDK 10 Tw = 5 ... 200 mm

Diffuse sensors with intensity difference

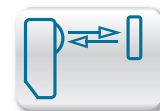

## relative receiving signal

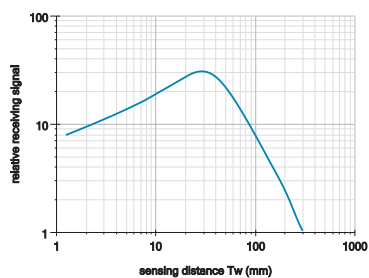

## dimension drawings

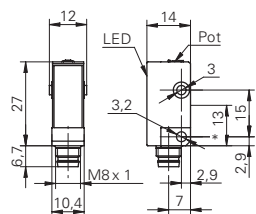

\* emitter axis

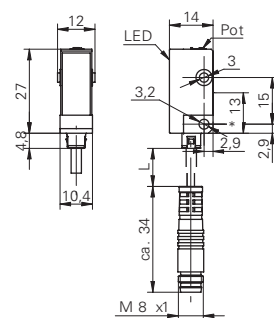

\* emitter axis cable length  $L = 200$  mm

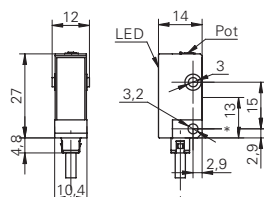

\* emitter axis

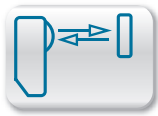

Tw = 5 ... 600 mm

- long range
- sensing distance adjustable via potentiometer
- suppression of mutual optical interference



**general data**

type	intensity difference
light source	pulsed red LED
sensing distance Tw	5 ... 600 mm
alignment / soiled lens indicator	flashing light indicator
light indicator	LED yellow
sensitivity adjustment	potentiometer, 270°
wave length	660 nm
suppression of reciprocal influence	yes

**electrical data**

response time / release time	< 1 ms
voltage supply range +Vs	10 ... 30 VDC
current consumption max. (no load)	25 mA
current consumption typ.	20 mA
voltage drop Vd	< 1,8 VDC
output function	light / dark operate
output current	< 100 mA
short circuit protection	yes
reverse polarity protection	yes

**mechanical data**

width / diameter	14,8 mm
height / length	43 mm
depth	31 mm
type	rectangular
housing material	plastic (ASA, MABS)
front (optics)	PMMA

**ambient conditions**

operating temperature	-25 ... +65 °C
protection class	IP 67

**connection diagrams**



**connectors and mating connectors**

ESG 32AH0200	Connector M8, 4 pin, straight, 2 m
ESW 31AH0200	Connector M8, 4 pin, angular, 2 m
ESG 34AH0200	Connector M12, 4 pin, straight, 2 m
ESW 33AH0200	Connector M12, 4 pin, angular, 2 m

additional cable connectors and field wireable connectors: see accessories

**Accessories**

10149011	Sensofix series 14
10134964	Mounting bracket series 14 (L design)

for details: see accessories section

order reference	connection types	output circuit
FZDK 14N5101	cable 4 pin, 2 m	NPN
FZDK 14N5101/S35A	connector M8 4 pin	NPN
FZDK 14P5101	cable 4 pin, 2 m	PNP
FZDK 14P5101/S14	connector M12 4 pin	PNP
FZDK 14P5101/S35A	connector M8 4 pin	PNP

FZDK 14 Tw = 5 ... 600 mm

Diffuse sensors with intensity difference



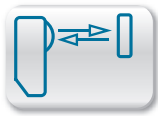

$T_w = 0 \dots 400 \text{ mm}$

- rugged metal housing
- sensing distance adjustable via potentiometer



#### general data

type	intensity difference
light source	pulsed infrared diode
sensing distance $T_w$	0 ... 400 mm
alignment / soiled lens indicator	flashing light indicator
light indicator	LED yellow
sensitivity adjustment	potentiometer, 270°
wave length	880 nm
suppression of reciprocal influence	yes

#### electrical data

response time / release time	< 1 ms
voltage supply range +Vs	10 ... 30 VDC
current consumption max. (no load)	41 mA
current consumption typ.	29 mA
voltage drop Vd	< 1,8 VDC
output function	light / dark operate
output current	< 200 mA
short circuit protection	yes
reverse polarity protection	yes

#### mechanical data

width / diameter	15,4 mm
height / length	50 mm
depth	50 mm
type	rectangular
housing material	die-cast zinc
front (optics)	PMMA

#### ambient conditions

operating temperature	-25 ... +65 °C
protection class	IP 67

order reference	connection types	output circuit
FZDM 16N5101	cable 4 pin, 2 m	NPN
FZDM 16N5101/S14	connector M12 4 pin	NPN
FZDM 16P5101	cable 4 pin, 2 m	PNP
FZDM 16P5101/S14	connector M12 4 pin	PNP

#### connection diagrams



#### connectors and mating connectors

ESG 34AH0200 Connector M12, 4 pin, straight, 2 m

ESW 33AH0200 Connector M12, 4 pin, angular, 2 m

additional cable connectors and field wireable connectors: see accessories

#### Accessories

10151721 Sensofix series 16

10113917 Mounting bracket series 16 (L design)

10116407 Lens cleaning air nozzle bracket

for details: see accessories section

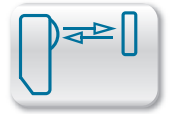

## relative receiving signal

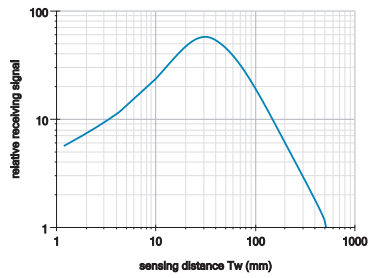

## dimension drawings

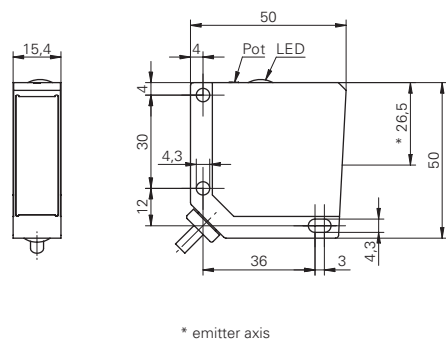
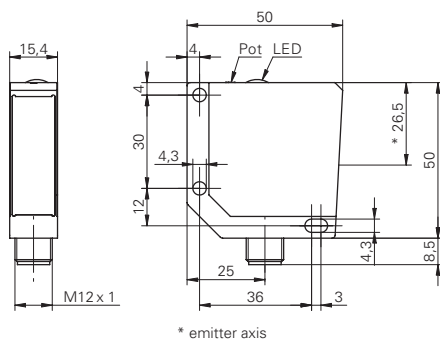

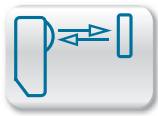

Tw = 5 ... 500 mm



- cross-technology housing concept
- sensing distance adjustable via potentiometer
- small mounting depth

**general data**

type	intensity difference
light source	pulsed red LED
sensing distance Tw	5 ... 500 mm
alignment / soiled lens indicator	flashing light indicator
light indicator	LED yellow
sensitivity adjustment	potentiometer, 270°
wave length	660 nm
suppression of reciprocal influence	yes

**electrical data**

response time / release time	< 0,5 ms
voltage supply range +Vs	10 ... 30 VDC
current consumption max. (no load)	25 mA
current consumption typ.	22 mA
voltage drop Vd	< 1,8 VDC
output function	light / dark operate
output current	< 100 mA
short circuit protection	yes
reverse polarity protection	yes

**mechanical data**

width / diameter	20 mm
height / length	42 mm
depth	15 mm
type	rectangular
housing material	plastic (PBT-ASA)
front (optics)	PMMA
connection types	connector M8 4 pin

**ambient conditions**

operating temperature	-25 ... +65 °C
protection class	IP 67

**order reference      output circuit**

FZDK 20N5101/S35A	NPN
FZDK 20P5101/S35A	PNP

**connection diagrams**



**connectors and mating connectors**

ESG 32AH0200	Connector M8, 4 pin, straight, 2 m
ESW 31AH0200	Connector M8, 4 pin, angular, 2 m

additional cable connectors and field wireable connectors: see accessories

**Accessories**

10150326	Sensofix series 10 / series 20
----------	--------------------------------

for details: see accessories section

FZDK 20 Tw = 5 ... 500 mm

Diffuse sensors with intensity difference



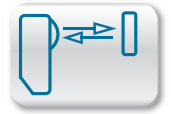

## relative receiving signal

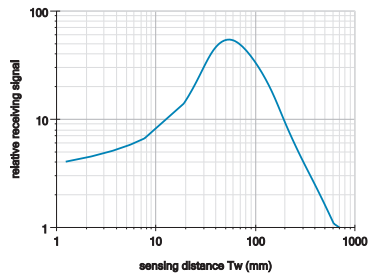

## dimension drawing

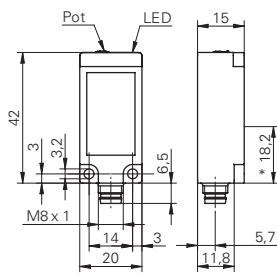

\* emitter axis

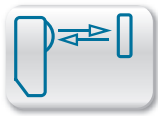

Tw = 400 mm



- One inch class
- qTeach

**general data**

type	intensity difference
light source	pulsed red LED
sensing distance Tw	10 ... 400 mm
power on indication	LED green
light indicator	LED yellow
sensing distance adjustment	qTeach
wave length	630 nm
suppression of reciprocal influence	yes
alignment optical axis	< 2°

**electrical data**

response time / release time	< 1 ms
voltage supply range +Vs	10 ... 30 VDC
current consumption max. (no load)	45 mA
current consumption typ.	30 mA
voltage drop Vd	< 3 VDC
output function	light / dark operate
output circuit	push-pull
output current	< 100 mA
short circuit protection	yes
reverse polarity protection	yes

**mechanical data**

width / diameter	12,9 mm
height / length	32,3 mm
depth	23 mm
type	rectangular
housing material	plastic (ASA, PMMA)
front (optics)	PMMA

**ambient conditions**

operating temperature	-25 ... +60 °C
protection class	IP 67

**order reference**

order reference	connection types
O300.ZR-11128017	cable 4 pin, 2 m
O300.ZR-11128014	connector M8 4 pin

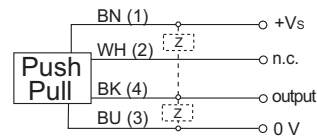
**connection diagram****connectors and mating connectors**

ESG 32AH0200	Connector M8, 4 pin, straight, 2 m
ESW 31AH0200	Connector M8, 4 pin, angular, 2 m

additional cable connectors and field wireable connectors: see accessories

**Accessories**

11104963	Sensofix O300
11102423	Mounting bracket O300 (L design)
11124807	Mounting bracket O300 - Retrofit for sensors series 20

for details: see accessories section

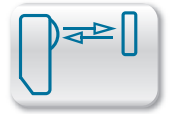

## relative receiving signal

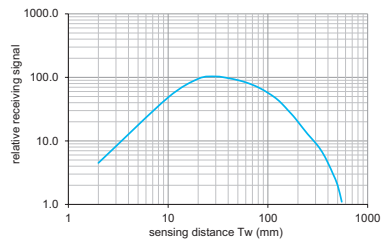

## beam characteristic (typically)

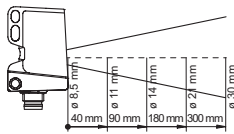

## dimension drawings



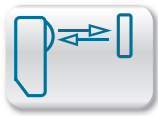

Tw = 600 mm

- qTeach

**general data**

type	intensity difference
light source	pulsed red LED
sensing distance Tw	20 ... 600 mm
power on indication	LED green
light indicator	LED yellow
sensing distance adjustment	qTeach
wave length	630 nm
suppression of reciprocal influence	yes
alignment optical axis	< 1°

**electrical data**

response time / release time	< 1 ms
voltage supply range +Vs	10 ... 30 VDC
current consumption max. (no load)	40 mA
current consumption typ.	30 mA
voltage drop Vd	< 3 VDC
output function	light / dark operate
output circuit	push-pull
output current	< 100 mA
short circuit protection	yes
reverse polarity protection	yes

**mechanical data**

width / diameter	18 mm
height / length	45 mm
depth	32 mm
type	rectangular
housing material	plastic (ASA, PMMA)
front (optics)	PMMA

**ambient conditions**

operating temperature	-25 ... +60 °C
protection class	IP 67

**order reference**

order reference	connection types
O500.ZR-11128020	cable 3 pin, 2 m
O500.ZR-11128018	connector M12 3 pin

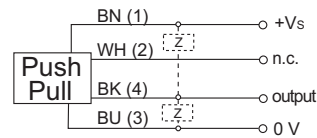
**connection diagram****connectors and mating connectors**

ESG 34SH0200 Connector M12, 3 pin, straight, 2 m

ESW 33SH0200 Connector M12, 3 pin, angular, 2 m

additional cable connectors and field wireable connectors: see accessories

**Accessories**

11099942	Sensofix O500/U500
11092246	Mounting bracket O500/U500 (L design)
11111164	Mounting bracket O500/U500 - Retrofit for sensors series 30

for details: see accessories section

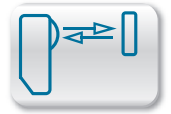

## relative receiving signal

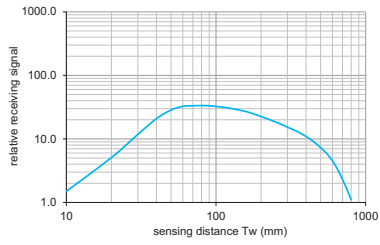

## beam characteristic (typically)

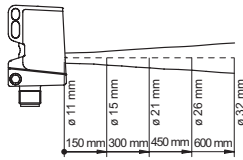

## dimension drawings

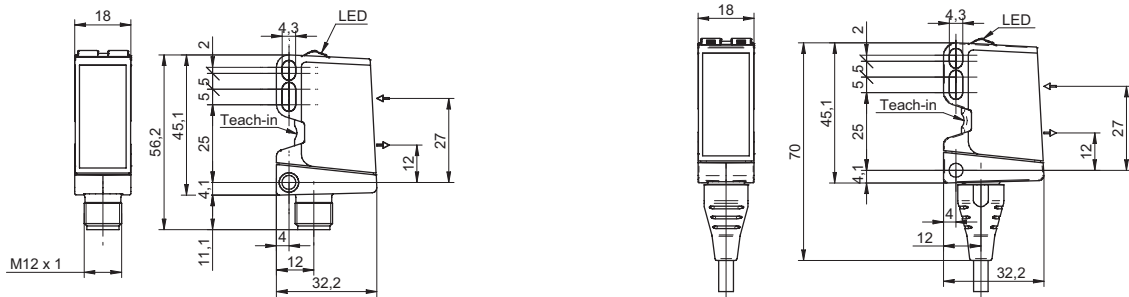

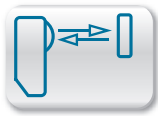

$T_w = 80 \text{ mm}$



- subminiature metal housing
- fixed sensing distance

#### general data

type	intensity difference
light source	pulsed infrared diode
alignment / soiled lens indicator	flashing light indicator
light indicator	LED red
sensitivity adjustment	no
wave length	880 nm
suppression of reciprocal influence	yes

#### electrical data

response time / release time	< 1 ms
voltage supply range +Vs	10 ... 30 VDC
current consumption max. (no load)	42 mA
current consumption typ.	20 mA
voltage drop Vd	< 2 VDC
output circuit	PNP
output current	< 100 mA
short circuit protection	yes
reverse polarity protection	yes

#### mechanical data

width / diameter	8 mm
type	cylindrical threaded
housing material	brass nickel plated
front (optics)	PC

#### ambient conditions

operating temperature	-25 ... +65 °C
protection class	IP 65

#### connection diagram

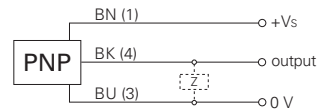

#### connectors and mating connectors

ESG 32SH0200	Connector M8, 3 pin, straight, 2 m
ESW 31SH0200	Connector M8, 3 pin, angular, 2 m
additional cable connectors and field wireable connectors: see accessories	

#### Accessories

10151719	Sensofix series 08 round
for details: see accessories section	

order reference	sensing distance $T_w$	height / length	connection types	output function
FZAM 08P1001	< 40 mm	56 mm	cable 3 pin, 2 m	light operate
FZAM 08P1001/S35L	< 40 mm	73 mm	connector M8, 3 pin	light operate
FZAM 08P1002	< 80 mm	56 mm	cable 3 pin, 2 m	light operate
FZAM 08P1002/S35L	< 80 mm	73 mm	connector M8, 3 pin	light operate
FZAM 08P3001	< 40 mm	56 mm	cable 3 pin, 2 m	dark operate
FZAM 08P3001/S35L	< 40 mm	73 mm	connector M8, 3 pin	dark operate
FZAM 08P3002	< 80 mm	56 mm	cable 3 pin, 2 m	dark operate
FZAM 08P3002/S35L	< 80 mm	73 mm	connector M8, 3 pin	dark operate

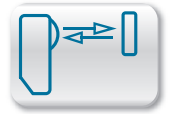

## relative receiving signals

Tw < 40 mm

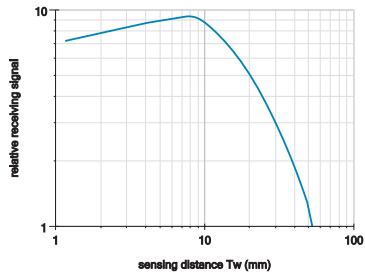

Tw < 80 mm

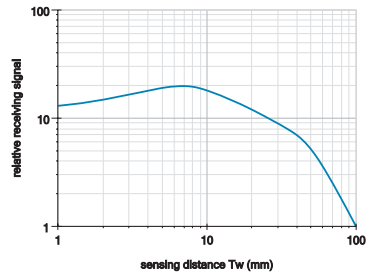

## dimension drawings

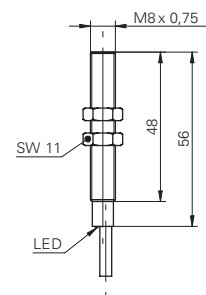
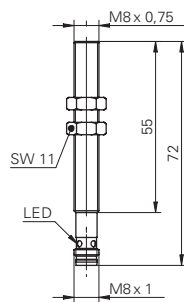

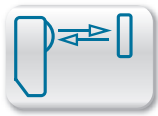

**Tw = 30 ... 200 mm**



- rugged metal housing
- sensing distance adjustable via potentiometer
- suppression of mutual optical interference

### general data

type	intensity difference
light source	pulsed infrared diode
sensing distance Tw	30 ... 200 mm
alignment / soiled lens indicator	flashing light indicator
light indicator	LED yellow
sensitivity adjustment	potentiometer, 270°
wave length	880 nm
suppression of reciprocal influence	yes

### electrical data

response time / release time	< 1 ms
voltage supply range +Vs	10 ... 30 VDC
current consumption max. (no load)	42 mA
current consumption typ.	24 mA
voltage drop Vd	< 1,8 VDC
output current	< 200 mA
short circuit protection	yes
reverse polarity protection	yes

### mechanical data

width / diameter	12 mm
type	cylindrical threaded
housing material	brass nickel plated
front (optics)	PC

### ambient conditions

operating temperature	-25 ... +65 °C
protection class	IP 65

### connection diagrams

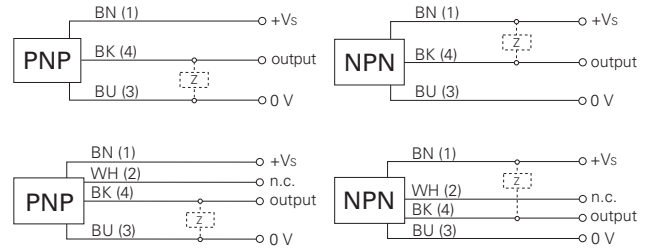

### connectors and mating connectors

ESG 34AH0200	Connector M12, 4 pin, straight, 2 m
ESW 33AH0200	Connector M12, 4 pin, angular, 2 m
additional cable connectors and field wireable connectors: see accessories	

### Accessories

10151720	Sensofix series 12 round
for details: see accessories section	

order reference	height / length	connection types	output circuit	output function
FZAM 12N1104/S14	80 mm	connector M12 4 pin	NPN	light operate
FZAM 12N3104	70 mm	cable 3 pin, 2 m	NPN	dark operate
FZAM 12N3104/S14	80 mm	connector M12 4 pin	NPN	dark operate
FZAM 12P1104	70 mm	cable 3 pin, 2 m	PNP	light operate
FZAM 12P1104/S14	80 mm	connector M12 4 pin	PNP	light operate
FZAM 12P3104	70 mm	cable 3 pin, 2 m	PNP	dark operate
FZAM 12P3104/S14	80 mm	connector M12 4 pin	PNP	dark operate



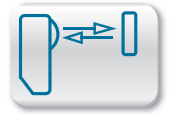

## relative receiving signal

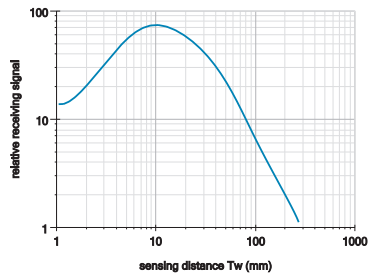

## dimension drawings

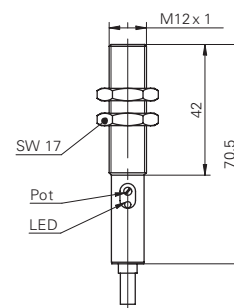
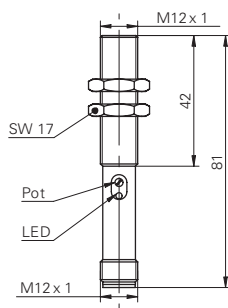

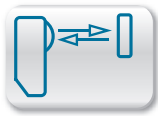

**Tw = 800 mm**



- infrared LED
- long range
- sensing distance adjustable via potentiometer

### general data

type	intensity difference
light source	pulsed infrared diode
alignment / soiled lens indicator	LED green
output indicator	LED yellow
wave length	880 nm
suppression of reciprocal influence	yes

### electrical data

response time / release time	< 1 ms
voltage supply range +Vs	12 ... 30 VDC
current consumption max. (no load)	40 mA
current consumption typ.	30 mA
voltage drop Vd	< 2 VDC
output function	light / dark operate
output current	< 100 mA
short circuit protection	yes
reverse polarity protection	yes

### mechanical data

width / diameter	18 mm
type	cylindrical threaded
housing material	plastic (ABS TERLURAN)
front (optics)	PMMA

### ambient conditions

operating temperature	-25 ... +55 °C
protection class	IP 67

### connection diagrams

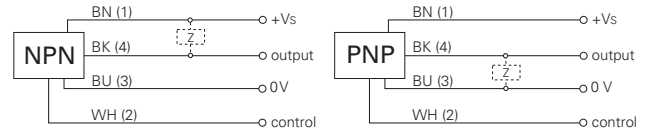

### connectors and mating connectors

ESG 34SH0200	Connector M12, 3 pin, straight, 2 m
ESW 33SH0200	Connector M12, 3 pin, angular, 2 m
additional cable connectors and field wireable connectors: see accessories	

### Accessories

10151658	Sensofix series 18
ZADAP-M18.STANDARD	Mounting bracket series 18
ZADAP-M18.SHORT	Mounting bracket short series 18 (L design)
ZADAP-M18.LONG	Mounting bracket long series 18 (L design)
ZADAP-M18.SWING	Mounting bracket for adjustment for sensors series 18
ZADAP-M18.MICRO	Mounting bracket for adjustment for sensors series 18
ZPART-M18.NUT	Clamping nut for sensors Ø 18 mm
for details: see accessories section	

order reference	sensing distance Tw	height / length	connection types	output circuit	sensing distance adjustment
OR18.ZI-11157801	0 ... 800 mm	67,2 mm	connector M12 4 pin	NPN	potentiometer, 270°
OR18.ZI-11157797	0 ... 300 mm	67,2 mm	connector M12 4 pin	NPN	potentiometer, 270°
OR18.ZI-11157792	0 ... 80 mm	44,8 mm	cable 4 pin, 2 m	NPN	no
OR18.ZI-11157798	0 ... 300 mm	44,8 mm	cable 4 pin, 2 m	NPN	no
OR18.ZI-11157793	0 ... 80 mm	44,8 mm	flylead connector M12 4 pin, L=100 mm	NPN	no
OR18.ZI-11157799	0 ... 300 mm	44,8 mm	flylead connector M12 4 pin, L=100 mm	NPN	no
OR18.ZI-11157800	0 ... 800 mm	67,2 mm	connector M12 4 pin	PNP	potentiometer, 270°
OR18.ZI-11157794	0 ... 300 mm	67,2 mm	connector M12 4 pin	PNP	potentiometer, 270°
OR18.ZI-11157790	0 ... 80 mm	44,8 mm	cable 4 pin, 2 m	PNP	no
OR18.ZI-11157795	0 ... 300 mm	44,8 mm	cable 4 pin, 2 m	PNP	no
OR18.ZI-11157791	0 ... 80 mm	44,8 mm	flylead connector M12 4 pin, L=100 mm	PNP	no
OR18.ZI-11157796	0 ... 300 mm	44,8 mm	flylead connector M12 4 pin, L=100 mm	PNP	no

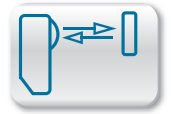

## relative receiving signals

Tw = 0 ... 300 mm

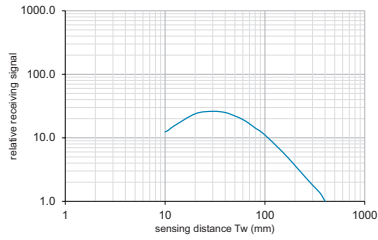

Tw = 0 ... 800 mm

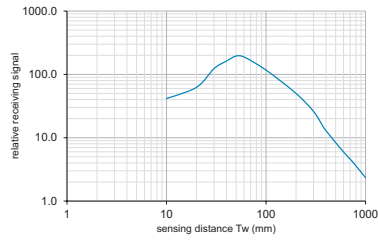

Tw = 0 ... 80 mm

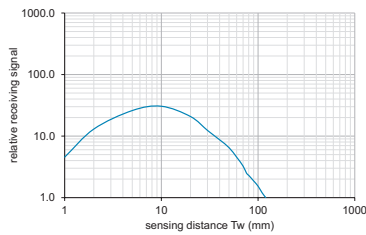

## dimension drawings

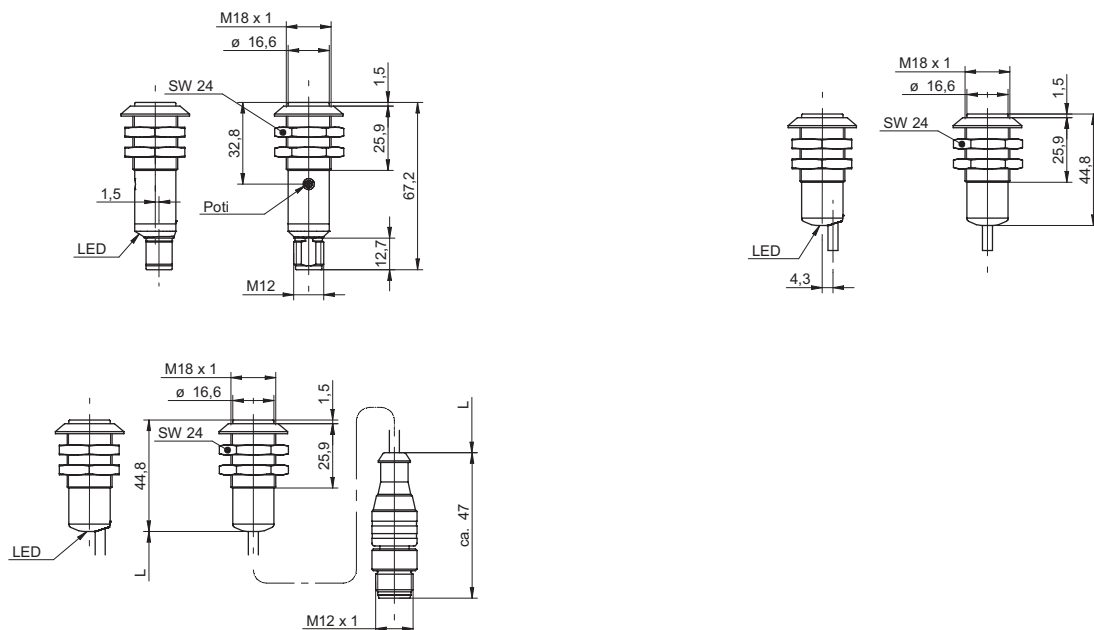

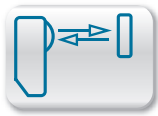

Tw = 60 ... 430 mm

- with alarm output
- sensing distance adjustable via Teach-in
- extended sensing distance with lens



**general data**

type	intensity difference
light source	pulsed infrared diode
sensing distance Tw	60 ... 430 mm
sensing distance Tw (with doubling lense)	80 ... 800 mm
alignment / soiled lens indicator	flashing light indicator
light indicator	LED green
output indicator	LED yellow
sensitivity adjustment	Teach-in
wave length	880 nm
suppression of reciprocal influence	yes

**electrical data**

response time / release time	< 1 ms
voltage supply range +Vs	10 ... 30 VDC
current consumption max. (no load)	55 mA
current consumption typ.	40 mA
voltage drop Vd	< 1,8 VDC
output function	light / dark operate, alarm
output current	< 200 mA
short circuit protection	yes
reverse polarity protection	yes

**mechanical data**

width / diameter	18 mm
type	cylindrical threaded
housing material	brass nickel plated / PC
front (optics)	PC

**ambient conditions**

operating temperature	-25 ... +55 °C
protection class	IP 67

**connection diagrams**



**connectors and mating connectors**

ESG 34AH0200	Connector M12, 4 pin, straight, 2 m
ESW 33AH0200	Connector M12, 4 pin, angular, 2 m

additional cable connectors and field wireable connectors: see accessories

**Accessories**

10151658	Sensofix series 18
10103068	Glass cover series 18
10107250	Doubling lens series 18 FZAM 18
10115913	Cap nut glass cover and doubling lens for sensors series 18

for details: see accessories section

**remarks**

With doubling lens / cap nut, the sensing distance can be doubled.

order reference	height / length	connection types	output circuit
FZAM 18N6460	50 mm	cable 4 pin, 2 m	NPN
FZAM 18N6460/S14	60 mm	connector M12 4 pin	NPN
FZAM 18P6460	50 mm	cable 4 pin, 2 m	PNP
FZAM 18P6460/S14	60 mm	connector M12 4 pin	PNP

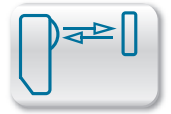

relative receiving signal

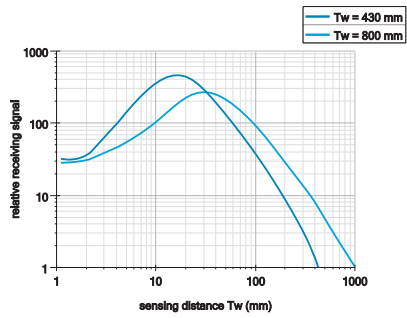

dimension drawings

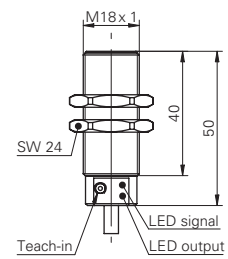
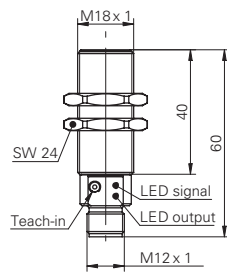

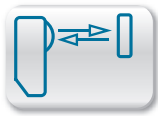

$T_w = 20 \dots 150 \text{ mm}$



- rugged metal housing
- sensing distance adjustable with potentiometer (axial)
- extended sensing distance with lens

general data	
type	intensity difference
light source	pulsed infrared diode
sensing distance $T_w$	20 ... 150 mm
sensing distance $T_w$ (with doubling lens)	30 ... 280 mm
alignment / soiled lens indicator	flashing light indicator
light indicator	LED yellow
sensitivity adjustment	potentiometer, 15 turn
wave length	880 nm
suppression of reciprocal influence	yes

electrical data	
response time / release time	< 0,5 ms
voltage supply range +Vs	10 ... 30 VDC
current consumption max. (no load)	45 mA
current consumption typ.	30 mA
voltage drop Vd	< 1,8 VDC
output function	light operate
output current	< 200 mA
short circuit protection	yes
reverse polarity protection	yes

mechanical data	
width / diameter	18 mm
height / length	50 mm
type	cylindrical threaded
housing material	brass nickel plated / PC
front (optics)	PC
connection types	cable 3 pin, 2 m

ambient conditions	
operating temperature	-25 ... +55 °C
protection class	IP 65

order reference	output circuit
FZAM 18N1155	NPN
FZAM 18P1155	PNP

connection diagrams

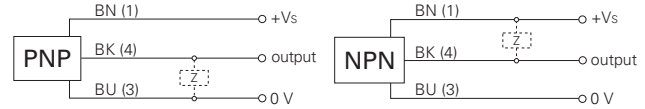

Accessories

10151658	Sensofix series 18
10103068	Glass cover series 18
10107250	Doubling lens series 18 FZAM 18
10115913	Cap nut glass cover and doubling lens for sensors series 18

for details: see accessories section

remarks

With doubling lens / cap nut, the sensing distance can be doubled.

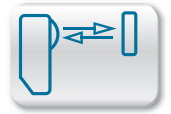

relative receiving signal

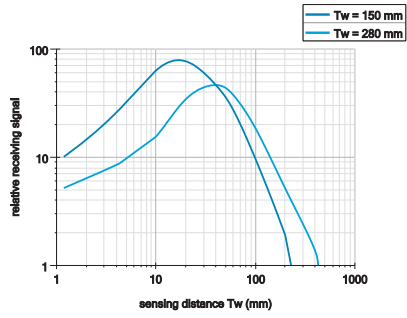

dimension drawing

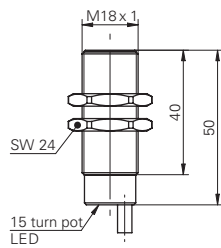

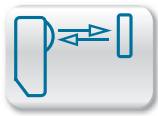

Tw = 60 ... 430 mm



- rugged metal housing
- sensing distance adjustable with radially mounted potentiometer
- extended sensing distance with lens

**general data**

type	intensity difference
light source	pulsed infrared diode
sensing distance Tw	60 ... 430 mm
sensing distance Tw (with doubling lense)	80 ... 800 mm
alignment / soiled lens indicator	flashing light indicator
light indicator	LED yellow
sensitivity adjustment	potentiometer, 270°
wave length	880 nm
suppression of reciprocal influence	yes

**electrical data**

response time / release time	< 1 ms
voltage supply range +Vs	10 ... 30 VDC
current consumption max. (no load)	45 mA
current consumption typ.	30 mA
voltage drop Vd	< 1,8 VDC
output function	light operate
output current	< 200 mA
short circuit protection	yes
reverse polarity protection	yes

**mechanical data**

width / diameter	18 mm
type	cylindrical threaded
housing material	brass nickel plated / PC
front (optics)	PC

**ambient conditions**

operating temperature	-25 ... +55 °C
protection class	IP 67

**connection diagrams**

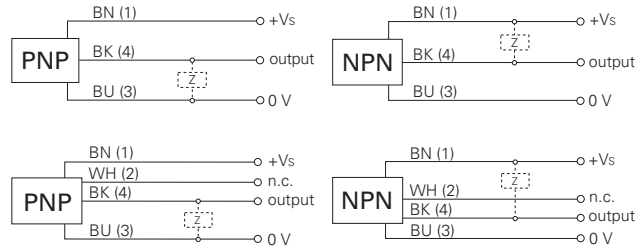

**connectors and mating connectors**

ESG 34AH0200	Connector M12, 4 pin, straight, 2 m
ESW 33AH0200	Connector M12, 4 pin, angular, 2 m
additional cable connectors and field wireable connectors: see accessories	

**Accessories**

10151658	Sensofix series 18
10103068	Glass cover series 18
10107250	Doubling lens series 18 FZAM 18
10115913	Cap nut glass cover and doubling lens for sensors series 18

for details: see accessories section

**remarks**

With doubling lens / cap nut, the sensing distance can be doubled.

order reference	height / length	connection types	output circuit
FZAM 18N1150	50 mm	cable 3 pin, 2 m	NPN
FZAM 18N1150/S14	60 mm	connector M12 4 pin	NPN
FZAM 18P1150	50 mm	cable 3 pin, 2 m	PNP
FZAM 18P1150/S14	60 mm	connector M12 4 pin	PNP



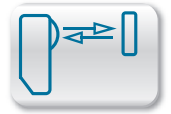

## relative receiving signal

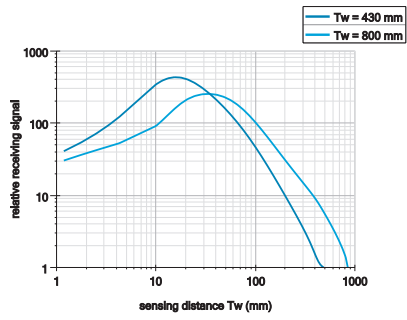

## dimension drawings

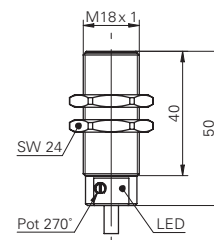
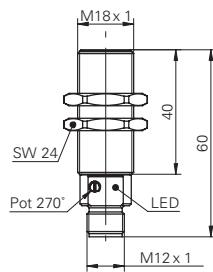

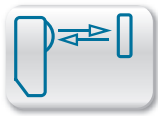

Tw = 100 ... 1500 mm



- rugged metal housing
- long sensing range

**general data**

type	intensity difference
light source	pulsed infrared diode
alignment / soiled lens indicator	flashing light indicator
light indicator	LED yellow
sensitivity adjustment	potentiometer, 15 turn
wave length	880 nm

**electrical data**

voltage supply range +Vs	10 ... 30 VDC
current consumption max. (no load)	60 mA
current consumption typ.	50 mA
voltage drop Vd	< 2,5 VDC
output function	light / dark operate
output current	< 100 mA
short circuit protection	yes
reverse polarity protection	yes

**mechanical data**

width / diameter	30 mm
height / length	66 mm
type	cylindrical threaded
housing material	brass nickel plated
front (optics)	PC
connection types	cablе 4 pin, 2 m

**ambient conditions**

operating temperature	0 ... +65 °C
protection class	IP 65

**connection diagrams**



**Accessories**

11200030	Sensofix series 30
ZADAP-M30.STANDARD	Mounting bracket series 30
ZADAP-M30.LONG	Mounting bracket long series 30 (L design)
10103226	Glass cover series 30
10107408	Doubling lens series 30 FZAM 30
10102801	Cap nut glass cover for sensors series 30

for details: see accessories section

order reference	sensing distance Tw	output circuit	response time / release time
FZAM 30N5002	300 ... 1500 mm	NPN	< 2,5 ms
FZAM 30P5002	300 ... 1500 mm	PNP	< 2,5 ms
FZAM 30P5003	100 ... 700 mm	PNP	< 0,25 ms

FZAM 30 Tw = 100 ... 1500 mm

Diffuse sensors with intensity difference

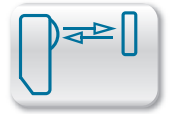

## relative receiving signals

Tw = 300 ... 1500 mm

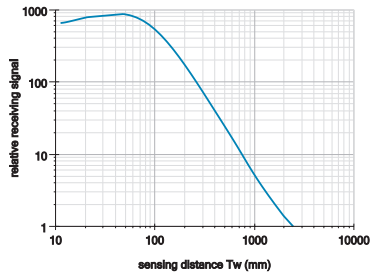

Tw = 100 ... 700 mm

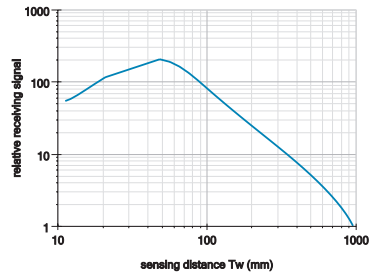

## dimension drawing

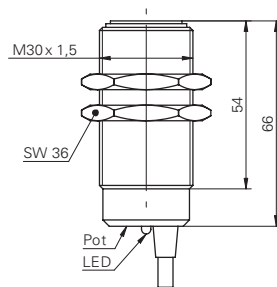

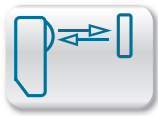

Tw = 1000 mm



- washdown design
- infrared LED
- long range

**general data**

type	intensity difference
special type	Washdown design
light source	pulsed infrared diode
alignment / soiled lens indicator	LED green
output indicator	LED yellow
sensing distance adjustment	potentiometer, 270°
wave length	880 nm
suppression of reciprocal influence	yes

**electrical data**

response time / release time	< 1 ms
voltage supply range +Vs	12 ... 30 VDC
current consumption max. (no load)	40 mA
current consumption typ.	30 mA
voltage drop Vd	< 2 VDC
output function	light / dark operate
output current	< 100 mA
short circuit protection	yes
reverse polarity protection	yes

**mechanical data**

width / diameter	18 mm
height / length	67,2 mm
type	cylindrical threaded
housing material	stainless steel 1.4404 (V4A)
front (optics)	PMMA
connection types	connector M12 4 pin

**ambient conditions**

operating temperature	-25 ... +55 °C
protection class	IP 67/69K

order reference	sensing distance Tw	output circuit
OR18W.ZI-11157850	0 ... 800 mm	NPN
OR18W.ZI-11157848	0 ... 300 mm	NPN
OR18W.ZI-11157849	0 ... 800 mm	PNP
OR18W.ZI-11157847	0 ... 300 mm	PNP

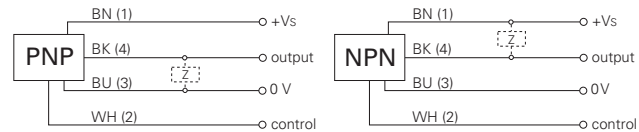
**connection diagrams****connectors and mating connectors**

ESG 34AY0200	Connector M12, 4 pin, straight, 2 m, V4A-PP
ESW 33AY0200	Connector M12, 4 pin, angular, 2 m, V4A-PP

additional cable connectors and field wireable connectors: see accessories

**Accessories**

10151658	Sensofix series 18
ZADAP-M18.STANDARD	Mounting bracket series 18
ZADAP-M18.SHORT	Mounting bracket short series 18 (L design)
ZADAP-M18.LONG	Mounting bracket long series 18 (L design)
ZADAP-M18.SWING	Mounting bracket for adjustment for sensors series 18
ZADAP-M18.MICRO	Mounting bracket for adjustment for sensors series 18

for details: see accessories section

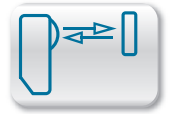

## relative receiving signals

Tw = 0 ... 300 mm

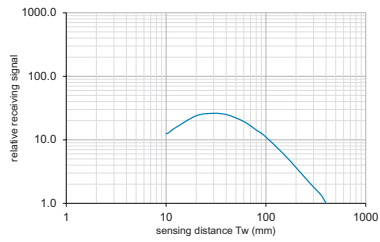

Tw = 0 ... 800 mm

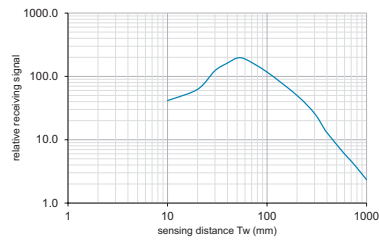

## beam characteristic (typically)

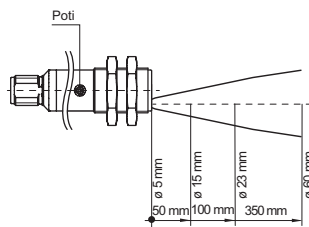

## dimension drawing

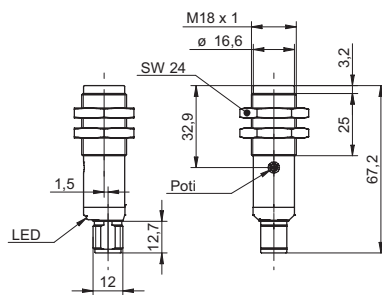

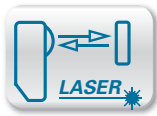

Tw = 3 ... 150 mm

- compact housing
- high repeatability
- very short response time



**general data**

type	intensity difference
light source	pulsed red laser diode
sensing distance Tw	3 ... 150 mm
optimum operating distance	20 ... 40 mm
detectable remission difference (on grey)	> 8 %
repeat accuracy	< 0,2 mm at laser focus
power on indication	LED green
light indicator	LED yellow
sensitivity adjustment	potentiometer, 5 turn
laser class	2
distance to focus	40 mm
wave length	650 nm

**electrical data**

response time / release time	< 0,05 ms
voltage supply range +Vs	10 ... 30 VDC
current consumption max. (no load)	50 mA
current consumption typ.	40 mA
voltage drop Vd	< 1,8 VDC
output function	light / dark operate
output current	< 100 mA
short circuit protection	yes
reverse polarity protection	yes

**mechanical data**

width / diameter	10,4 mm
height / length	27 mm
depth	16,3 mm
type	rectangular
housing material	plastic (ASA)
front (optics)	PMMA

**ambient conditions**

operating temperature	-10 ... +50 °C
-----------------------	----------------

**connection diagrams**



**connectors and mating connectors**

ESG 32AH0200	Connector M8, 4 pin, straight, 2 m
ESW 31AH0200	Connector M8, 4 pin, angular, 2 m

additional cable connectors and field wireable connectors: see accessories

**Accessories**

10150326	Sensofix series 10 / series 20
10114501	Mounting bracket series 10 (U design)
10133792	Mounting bracket series 10 (L design)
10162083	Mounting panel for sensors series 10
10118798	Mounting bracket series 10

for details: see accessories section

**laser warning**

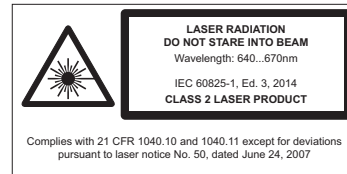

order reference	connection types	output circuit	protection class
OZDK 10N5101	cable 4 pin, 2 m	NPN	IP 65
OZDK 10N5101/S35A	connector M8 4 pin	NPN	IP 67
OZDK 10P5101	cable 4 pin, 2 m	PNP	IP 65
OZDK 10P5101/S35A	connector M8 4 pin	PNP	IP 67

OZDK 10 Tw = 3 ... 150 mm

Diffuse sensors with intensity difference

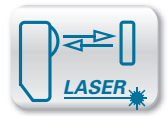

## relative receiving signal

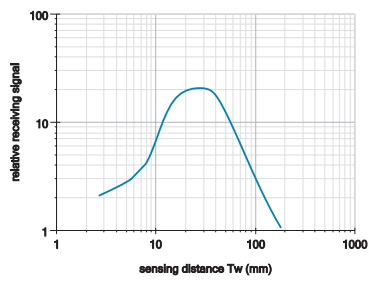

## beam characteristic (typically)

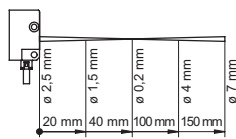

## dimension drawings

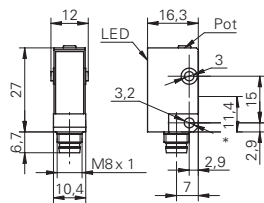

\* emitter axis

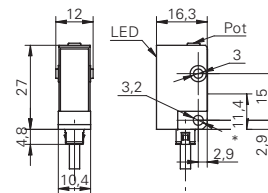

\* emitter axis

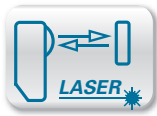

Tw = 3 ... 150 mm

- compact housing
- line beam
- very short response time



**general data**

type	intensity difference
version	line beam
light source	pulsed red laser diode
sensing distance Tw	3 ... 150 mm
optimum operating distance	35 ... 45 mm
repeat accuracy	< 0,2 mm at laser focus
power on indication	LED green
light indicator	LED yellow
sensitivity adjustment	potentiometer, 5 turn
laser class	1
distance to focus	40 mm
wave length	650 nm

**electrical data**

response time / release time	< 0,05 ms
voltage supply range +Vs	10 ... 30 VDC
current consumption max. (no load)	50 mA
current consumption typ.	40 mA
voltage drop Vd	< 1,8 VDC
output function	light / dark operate
output current	< 100 mA
short circuit protection	yes
reverse polarity protection	yes

**mechanical data**

width / diameter	10,4 mm
height / length	27 mm
depth	16,3 mm
type	rectangular
housing material	plastic (ASA)
front (optics)	PMMA

**ambient conditions**

operating temperature	-10 ... +50 °C
-----------------------	----------------

**connection diagrams**



**connectors and mating connectors**

ESG 32AH0200	Connector M8, 4 pin, straight, 2 m
ESW 31AH0200	Connector M8, 4 pin, angular, 2 m

additional cable connectors and field wireable connectors: see accessories

**Accessories**

10150326	Sensofix series 10 / series 20
10114501	Mounting bracket series 10 (U design)
10133792	Mounting bracket series 10 (L design)
10162083	Mounting panel for sensors series 10
10118798	Mounting bracket series 10

for details: see accessories section

**laser warning**



IEC 60825-1/2014  
Complies with 21 CFR 1040.10 and 1040.11  
except for deviations pursuant to laser  
notice No. 50, dated June 24, 2007

order reference	connection types	output circuit	protection class
OZDK 10N5150	cable 4 pin, 2 m	NPN	IP 65
OZDK 10N5150/S35A	connector M8 4 pin	NPN	IP 67
OZDK 10P5150	cable 4 pin, 2 m	PNP	IP 65
OZDK 10P5150/S35A	connector M8 4 pin	PNP	IP 67



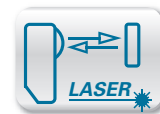

## relative receiving signal

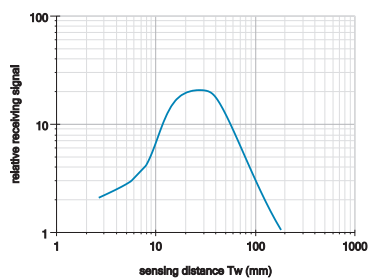

## beam characteristic (typically)

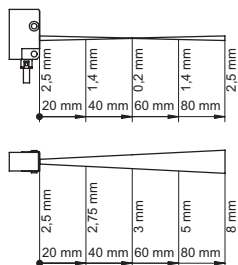

## dimension drawings

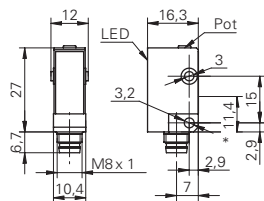

\* emitter axis

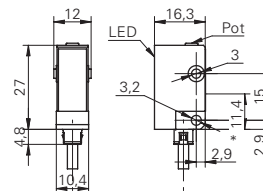

\* emitter axis

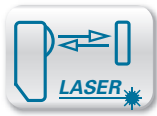

Tw = 250 mm



- One inch class
- laser diode
- short response time

**general data**

type	intensity difference
light source	pulsed red laser diode
sensing distance Tw	10 ... 250 mm
repeat accuracy	< 0,1 mm at laser focus
power on indication	LED green
light indicator	LED yellow
laser class	1
distance to focus	80 mm
wave length	656 nm
suppression of reciprocal influence	yes
alignment optical axis	< 2°

**electrical data**

response time / release time	< 0,1 ms
voltage supply range +Vs	11 ... 30 VDC
current consumption max. (no load)	30 mA
current consumption typ.	25 mA
voltage drop Vd	< 2,5 VDC
output function	light / dark operate
output current	< 100 mA
short circuit protection	yes
reverse polarity protection	yes

**mechanical data**

width / diameter	12,9 mm
height / length	32,3 mm
depth	23 mm
type	rectangular
housing material	plastic (ASA, PMMA)
front (optics)	PMMA

**ambient conditions**

operating temperature	-10 ... +60 °C
protection class	IP 67

**connection diagrams**

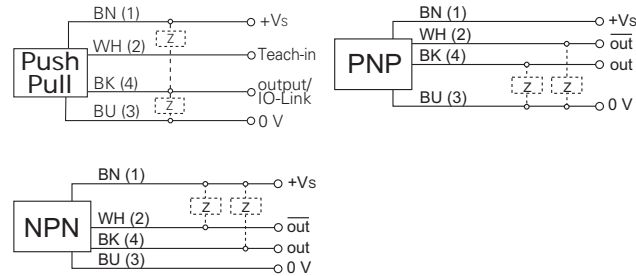

**connectors and mating connectors**

ESG 32AH0200	Connector M8, 4 pin, straight, 2 m
ESW 31AH0200	Connector M8, 4 pin, angular, 2 m

additional cable connectors and field wireable connectors: see accessories

**Accessories**

11104963	Sensofix O300
11102423	Mounting bracket O300 (L design)
11124807	Mounting bracket O300 - Retrofit for sensors series 20

for details: see accessories section

**laser warning**



IEC 60825-1/2014  
 Complies with 21 CFR 1040.10 and 1040.11  
 except for deviations pursuant to laser  
 notice No. 50, dated June 24, 2007

order reference	connection types	output circuit	sensing distance adjustment
O300.ZL-11176829	cable 4 pin, 2 m	push-pull	Teach-in and IO-Link
O300.ZL-11176840	connector M8 4 pin	push-pull	Teach-in and IO-Link
O300.ZL-11181086	cable 4 pin, 2 m	NPN complementary	qTeach
O300.ZL-11181087	connector M8 4 pin	NPN complementary	qTeach
O300.ZL-11181088	cable 4 pin, 2 m	PNP complementary	qTeach
O300.ZL-11181089	connector M8 4 pin	PNP complementary	qTeach

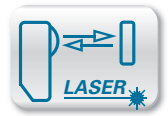

## relative receiving signal

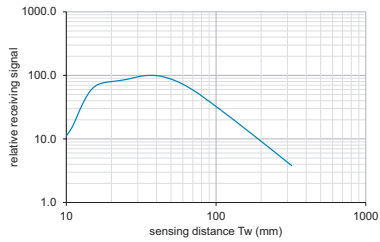

## beam characteristic (typically)

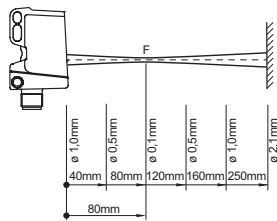

## dimension drawings

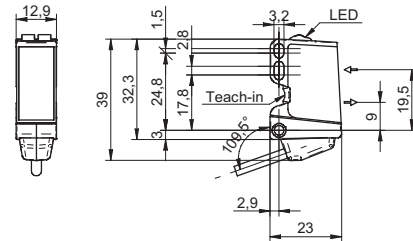
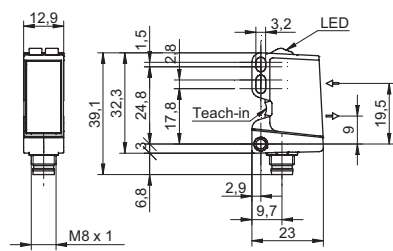

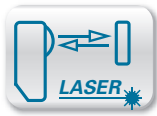

Tw = 20 ... 300 mm



- very short response time
- high repeatability
- sensing distance adjustable via Teach-in

**general data**

type	intensity difference
light source	pulsed red laser diode
sensing distance Tw	20 ... 300 mm
repeat accuracy	< 0,2 mm at laser focus
alignment / soiled lens indicator	flashing light indicator
power on indication	LED green
light indicator	LED yellow
sensitivity adjustment	Teach-in
laser class	2
distance to focus	115 mm
wave length	650 nm

**electrical data**

response time / release time	< 0,15 ms
voltage supply range +Vs	10 ... 30 VDC
current consumption max. (no load)	35 mA
current consumption typ.	25 mA
voltage drop Vd	< 2,2 VDC
output function	light operate
output current	< 100 mA
short circuit protection	yes
reverse polarity protection	yes

**mechanical data**

width / diameter	14,8 mm
height / length	43 mm
depth	31 mm
type	rectangular
housing material	plastic (ASA, MABS)
front (optics)	PMMA

**ambient conditions**

operating temperature	-10 ... +50 °C
protection class	IP 67

**connection diagrams**



**connectors and mating connectors**

ESG 34AH0200	Connector M12, 4 pin, straight, 2 m
ESW 33AH0200	Connector M12, 4 pin, angular, 2 m
ESG 32AH0200	Connector M8, 4 pin, straight, 2 m
ESW 31AH0200	Connector M8, 4 pin, angular, 2 m

additional cable connectors and field wireable connectors: see accessories

**Accessories**

10149011	Sensofix series 14
10134964	Mounting bracket series 14 (L design)

for details: see accessories section

**laser warning**

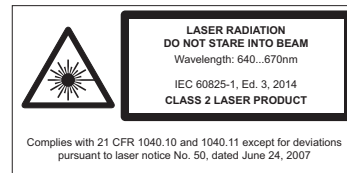

order reference	connection types	output circuit
OZDK 14N1901/S14	connector M12 4 pin	NPN
OZDK 14P1901	cable 4 pin, 2 m	PNP
OZDK 14P1901/S14	connector M12 4 pin	PNP
OZDK 14P1901/S35A	connector M8 4 pin	PNP

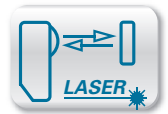

## relative receiving signal

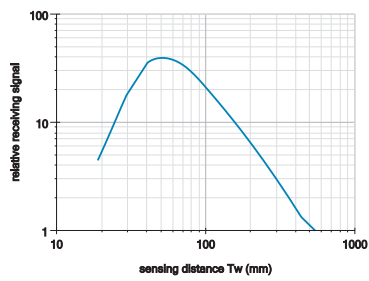

## beam characteristic (typically)

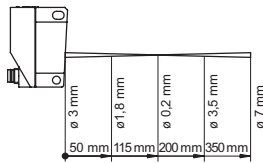

## dimension drawings

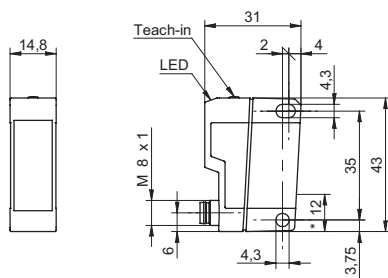

\* emitter axis

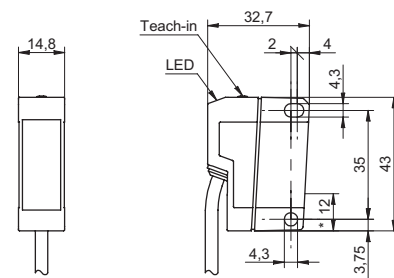

\* emitter axis

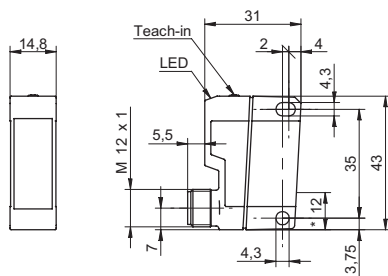

\* emitter axis

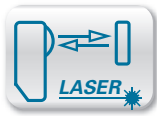

Tw = 0 ... 250 mm



- rugged metal housing
- high repeatability
- very short response time

**general data**

type	intensity difference
light source	pulsed red laser diode
sensing distance Tw	0 ... 250 mm
optimum operating distance	40 ... 80 mm
detectable remission difference (on grey)	> 8 %
repeat accuracy	< 0,1 mm at laser focus
output indicator	LED yellow
sensitivity adjustment	potentiometer, 14 turn
laser class	1
distance to focus	80 mm
wave length	675 nm

**electrical data**

response time / release time	< 0,05 ms
voltage supply range +Vs	12 ... 30 VDC
current consumption max. (no load)	65 mA
current consumption typ.	60 mA
voltage drop Vd	< 2 VDC
output current	< 200 mA
short circuit protection	yes
reverse polarity protection	yes

**mechanical data**

width / diameter	15,4 mm
height / length	50 mm
depth	50 mm
type	rectangular
housing material	die-cast zinc
front (optics)	glass

**ambient conditions**

operating temperature	-10 ... +50 °C
protection class	IP 67

**connection diagrams**

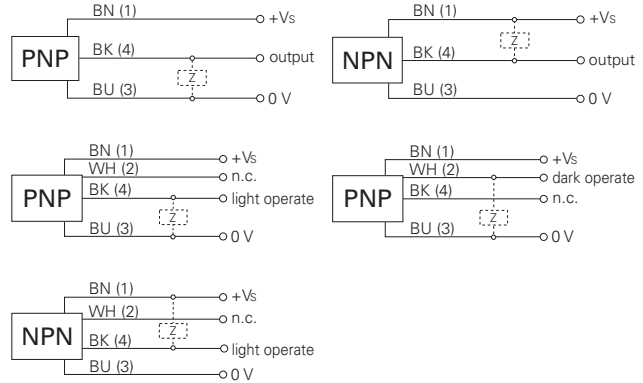

**connectors and mating connectors**

ESG 34AH0200	Connector M12, 4 pin, straight, 2 m
ESW 33AH0200	Connector M12, 4 pin, angular, 2 m

additional cable connectors and field wireable connectors: see accessories

**Accessories**

10151721	Sensofix series 16
10113917	Mounting bracket series 16 (L design)
10116407	Lens cleaning air nozzle bracket

for details: see accessories section

**laser warning**



IEC 60825-1/2014  
Complies with 21 CFR 1040.10 and 1040.11  
except for deviations pursuant to laser  
notice No. 50, dated June 24, 2007

order reference	connection types	output circuit	output function
OZDM 16N1001	cable 3 pin, 2 m	NPN	light operate
OZDM 16N1001/S14	connector M12 4 pin	NPN	light operate
OZDM 16P1001	cable 3 pin, 2 m	PNP	light operate
OZDM 16P1001/S14	connector M12 4 pin	PNP	light operate
OZDM 16P3001	cable 3 pin, 2 m	PNP	dark operate
OZDM 16P3001/S14	connector M12 4 pin	PNP	dark operate

OZDM 16 Tw = 0 ... 250 mm Diffuse sensors with intensity difference

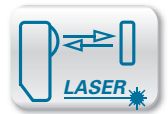

## relative receiving signal

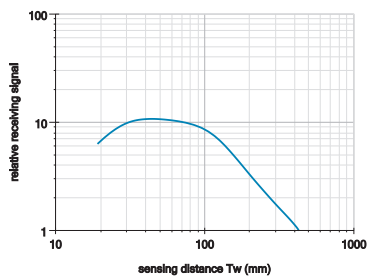

## beam characteristic (typically)

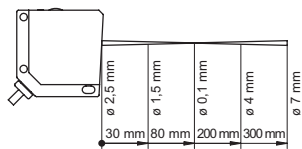

## dimension drawings

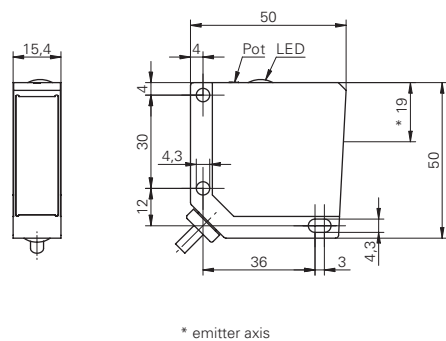
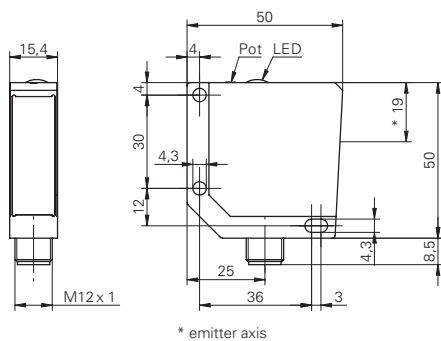

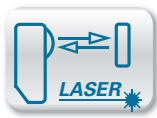

$T_w = 0 \dots 250 \text{ mm}$



- with analog output
- high repeatability
- very short response time

#### general data

type	intensity difference
light source	pulsed red laser diode
sensing distance $T_w$	0 ... 250 mm
optimum operating distance	40 ... 80 mm
detectable remission difference (on grey)	> 8 %
repeat accuracy	< 0,1 mm at laser focus
output indicator	LED yellow
sensitivity adjustment	potentiometer, 14 turn
laser class	1
distance to focus	80 mm
wave length	675 nm

#### electrical data

response time / release time	< 0,1 ms
voltage supply range +Vs	12 ... 30 VDC
current consumption max. (no load)	65 mA
current consumption typ.	60 mA
voltage drop Vd	< 2 VDC
output function	light operate
output circuit	PNP / analog 4 ... 20 mA
output current	< 200 mA
short circuit protection	yes
reverse polarity protection	yes

#### mechanical data

width / diameter	15,4 mm
height / length	50 mm
depth	50 mm
type	rectangular
housing material	die-cast zinc
front (optics)	glass

#### ambient conditions

operating temperature	-10 ... +50 °C
protection class	IP 67

#### order reference

order reference	connection types
OZDM 16P1901	cable 4 pin, 2 m
OZDM 16P1901/S14	connector M12 4 pin

#### connection diagram

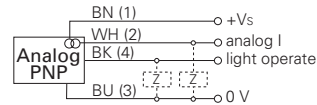

#### connectors and mating connectors

ESG 34AH0200 Connector M12, 4 pin, straight, 2 m

ESW 33AH0200 Connector M12, 4 pin, angular, 2 m

additional cable connectors and field wireable connectors: see accessories

#### Accessories

10151721 Sensofix series 16

10113917 Mounting bracket series 16 (L design)

10116407 Lens cleaning air nozzle bracket

for details: see accessories section

#### laser warning

**CLASS 1 LASER  
PRODUCT**

IEC 60825-1/2014  
Complies with 21 CFR 1040.10 and 1040.11  
except for deviations pursuant to laser  
notice No. 50, dated June 24, 2007



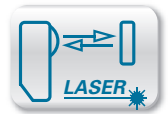

## signal progression

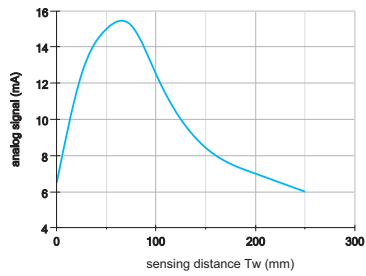

## beam characteristic (typically)

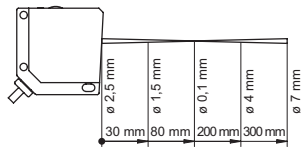

## dimension drawings

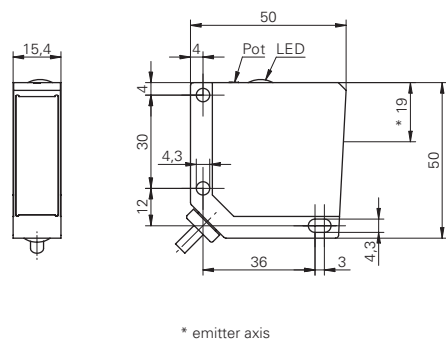
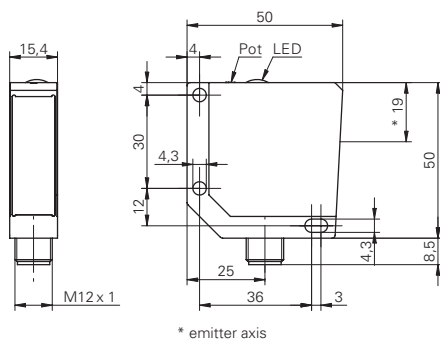

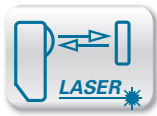

Tw = 300 mm

- short response time
- sensing distance adjustable via potentiometer
- suppression of mutual optical interference



**general data**

type	intensity difference
light source	pulsed red laser diode
sensing distance Tw	10 ... 300 mm
power on indication	LED green
output indicator	LED yellow
sensing distance adjustment	potentiometer, 270°
laser class	1
distance to focus	100 mm
wave length	630 nm
suppression of reciprocal influence	yes

**electrical data**

response time / release time	< 0,34 ms
voltage supply range +Vs	10 ... 30 VDC
current consumption max. (no load)	45 mA
current consumption typ.	35 mA
voltage drop Vd	< 2 VDC
output function	light / dark operate
output current	< 100 mA
short circuit protection	yes
reverse polarity protection	yes

**mechanical data**

width / diameter	18 mm
type	cylindrical threaded
housing material	brass nickel plated
front (optics)	PMMA

**ambient conditions**

operating temperature	-10 ... +55 °C
protection class	IP 67

**connection diagram**

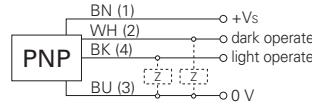

**connectors and mating connectors**

ESG 34SH0200	Connector M12, 3 pin, straight, 2 m
ESW 33SH0200	Connector M12, 3 pin, angular, 2 m
additional cable connectors and field wireable connectors: see accessories	

**Accessories**

10151658	Sensofix series 18
ZADAP-M18.STANDARD	Mounting bracket series 18
ZADAP-M18.SHORT	Mounting bracket short series 18 (L design)
ZADAP-M18.LONG	Mounting bracket long series 18 (L design)
ZADAP-M18.SWING	Mounting bracket for adjustment for sensors series 18
ZADAP-M18.MICRO	Mounting bracket for adjustment for sensors series 18

for details: see accessories section

**laser warning**



IEC 60825-1/2014  
Complies with 21 CFR 1040.10 and 1040.11  
except for deviations pursuant to laser  
notice No. 50, dated June 24, 2007

order reference	height / length	connection types	output circuit
OR18.ZL-11157806	77 mm	cable 4 pin, 2 m	NPN complementary
OR18.ZL-11157805	81,5 mm	connector M12 4 pin	NPN complementary
OR18.ZL-11157803	77 mm	cable 4 pin, 2 m	PNP complementary
OR18.ZL-11157802	81,5 mm	connector M12 4 pin	PNP complementary

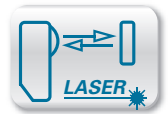

## relative receiving signal

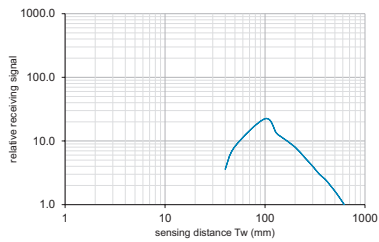

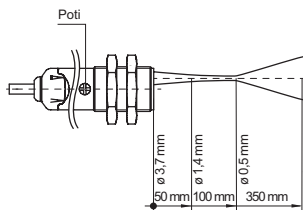

## beam characteristic (typically)

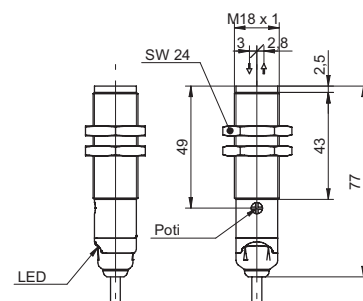
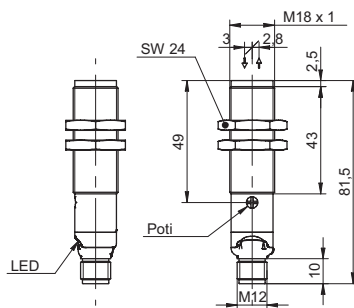

## dimension drawings



product family	FKDM 22	FKDM 22	FKDM 22
			
	<i>LOGIPAL</i>	<i>LOGIPAL</i>	<i>LOGIPAL</i>
sensing distance $T_w$	40 mm	40 mm	25 mm
sensor channels	4 (teachable)	2 (teachable)	4 (teachable)
size of measuring spot	3 mm x 5 mm	3 mm x 5 mm	0,7 mm x 1,3 mm
response time / release time	< 0,34 ms	< 0,34 ms	< 0,34 ms
light source	LED red / green / blue	LED red / green / blue	LED red / green / blue
output circuit	NPN PNP	NPN PNP	PNP
device plug	connector M12, 8 pin, rotatable	connector M12, 8 pin, rotatable	connector M12, 8 pin, rotatable
page	420	421	422



## General information

With the *LOGIPAL* color detection sensor, you can now use the color as a solution for sorting, quality monitoring and automation in your processes.

## Applications

- Objects can be monitored and sorted by colored marks.
- The correct color of objects can be inspected or the objects can be sorted by their color.

## Characteristics and advantages

- **Simple operation:**  
Four different colors can be programmed with just three buttons.
- **Finest color graduation:**  
One of five tolerance stages can be chosen for each color.
- **Short response time:**  
With a response time of only 0,34 ms, high detection rates can be achieved.
- **Synchronization input:**  
Allows controlled measurement of the color.
- **External Teach-in input:**  
Allows complete remote control of all Teach-in functions by serial data transfer. An RS 232 interface transducer with galvanic isolation is available as an accessory.

## Technology and operation

The sensor operates by the three-stage principle, meaning that it emits the three colors red, green and blue and then measures the color proportions of the three colors reflected by the object.

The color of an object is programmed in the Teach-in procedure. If the sensor recognizes this color again during operation, it activates the corresponding output. Optional tolerances permit it to detect large or small differences in color.

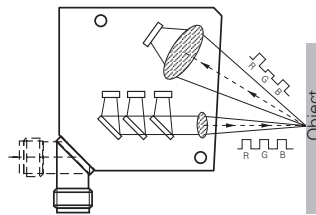

## Mounting and adjustment

The use of the color sensor is as simple as for a diffuse sensor. Only the points below must be observed.

- For glossy objects, tilt the sensor to the side by approve. 15 °.
- If you wish to detect very fine differences in color, the sensing distance of 40 mm ha to be adhered.

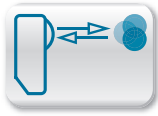

Tw = 40 mm



- up to 4 colors can be distinguished properly
- spot size 3 x 5 mm
- rugged metal housing

**general data**

sensing distance Tw	40 mm
sensor channels	4 (teachable)
tolerance ranges	5-step teachable (LEDs)
size of measuring spot	3 mm x 5 mm
light source	LED red / green / blue
signal display (Teach)	LED orange
channel status display	LED yellow per channel
power on indication	LED green

**electrical data**

response time / release time	< 0,34 ms
voltage supply range +Vs	10 ... 30 VDC
power consumption	< 2 W
output function	light operate
voltage drop Vd	< 1,8 VDC
output current (per channel)	< 100 mA
remote Teach-In input	protocol with return signal through channel 1-output
level (sync., teach)	high: 2/3 Vs...Vs low: 0 V...1/3 Vs
short circuit protection	yes
reverse polarity protection	yes

**mechanical data**

width / diameter	22,9 mm
type	rectangular
housing material	die-cast zinc
front (optics)	glass
device plug	connector M12, 8 pin, rotatable

**ambient conditions**

operating temperature	-10 ... +55 °C
protection class	IP 67

**connectors and mating connectors**

ESG 34FH0200G Connector M12, 8 pin, straight, 2 m, shielded  
 ESW 33FH1000G Connector M12, 8 pin, angular, 10 m, shielded  
 additional cable connectors and field wireable connectors: see accessories

**Accessories**

10126220 Mounting bracket series 22 L design  
 for details: see accessories section

**remarks**

Complete remote control of the sensor is possible using the "Ext. Teach" input. The converter RS 232 is necessary.

**dimension drawing**

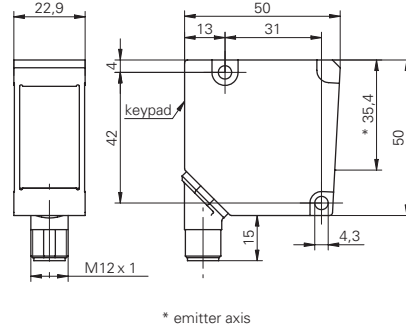

**connection diagrams**

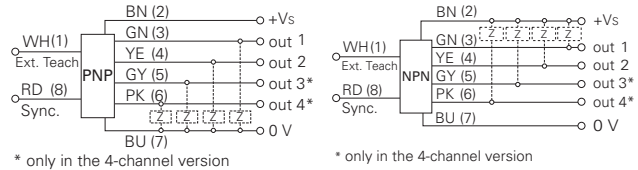

FKDM 22 Tw = 40 mm

Color sensors LOGIPAL

order reference	output circuit	sync. input
FKDM 22N1901/S14F	NPN	high active
FKDM 22P1901/S14F	PNP	low active

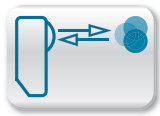

Tw = 40 mm



- up to 2 colors can be distinguished properly
- spot size 3 x 5 mm
- rugged metal housing

**general data**

sensing distance Tw	40 mm
sensor channels	2 (teachable)
tolerance ranges	5-step teachable (LEDs)
size of measuring spot	3 mm x 5 mm
light source	LED red / green / blue
signal display (Teach)	LED orange
channel status display	LED yellow per channel
power on indication	LED green

**electrical data**

response time / release time	< 0,34 ms
voltage supply range +Vs	10 ... 30 VDC
power consumption	< 2 W
voltage drop Vd	< 1,8 VDC
output current (per channel)	< 100 mA
remote Teach-In input	protocol with return signal through channel 1-output
level (sync., teach)	high: 2/3 Vs...Vs low: 0 V...1/3 Vs
short circuit protection	yes
reverse polarity protection	yes

**mechanical data**

width / diameter	22,9 mm
type	rectangular
housing material	die-cast zinc
front (optics)	glass
device plug	connector M12, 8 pin, rotatable

**ambient conditions**

operating temperature	-10 ... +55 °C
protection class	IP 67

**connectors and mating connectors**

ESG 34FH0200G Connector M12, 8 pin, straight, 2 m, shielded  
 ESW 33FH1000G Connector M12, 8 pin, angular, 10 m, shielded  
 additional cable connectors and field wireable connectors: see accessories

**Accessories**

10126220 Mounting bracket series 22 L design  
 for details: see accessories section

**remarks**

Complete remote control of the sensor is possible using the "Ext. Teach" input. The converter RS 232 is necessary.

**dimension drawing**

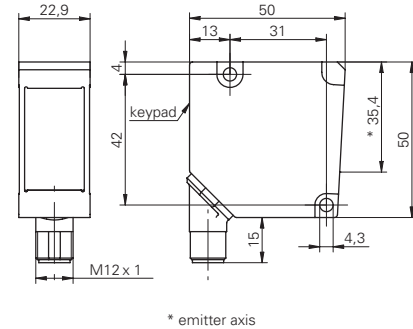

**connection diagrams**

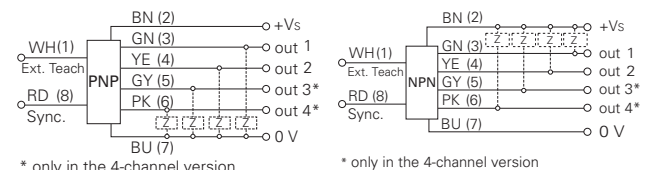

order reference	output circuit	output function	sync. input
FKDM 22N1902/S14F	NPN	light operate	high active
FKDM 22P1902/S14F	PNP	light operate	low active
FKDM 22P3902/S14F	PNP	dark operate	low active

FKDM 22 Tw = 40 mm Color sensors LOGIPAL

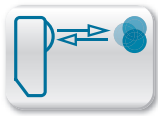

Tw = 25 mm



- up to 4 colors can be distinguished properly
- spot size 0,7 x 1,3 mm
- rugged metal housing

**general data**

sensing distance Tw	25 mm
sensor channels	4 (teachable)
tolerance ranges	5-step teachable (LEDs)
size of measuring spot	0,7 mm x 1,3 mm
light source	LED red / green / blue
signal display (Teach)	LED orange
channel status display	LED yellow per channel
power on indication	LED green

**electrical data**

response time / release time	< 0,34 ms
voltage supply range +Vs	10 ... 30 VDC
power consumption	< 2 W
output circuit	PNP
output function	light operate
voltage drop Vd	< 1,8 VDC
output current (per channel)	< 100 mA
remote Teach-In input	protocol with return signal through channel 1-output
sync. input	low active
level (sync., teach)	high: 2/3 Vs...Vs low: 0 V...1/3 Vs
short circuit protection	yes
reverse polarity protection	yes

**mechanical data**

width / diameter	22,9 mm
type	rectangular
housing material	aluminum anodized
front (optics)	glass
device plug	connector M12, 8 pin, rotatable

**ambient conditions**

operating temperature	-10 ... +55 °C
protection class	IP 67

**connectors and mating connectors**

ESG 34FH0200G	Connector M12, 8 pin, straight, 2 m, shielded
ESW 33FH1000G	Connector M12, 8 pin, angular, 10 m, shielded
additional cable connectors and field wireable connectors: see accessories	

**Accessories**

10126220	Mounting bracket series 22 L design
for details: see accessories section	

**remarks**

Complete remote control of the sensor is possible using the "Ext. Teach" input. The converter RS 232 is necessary.

**order reference**

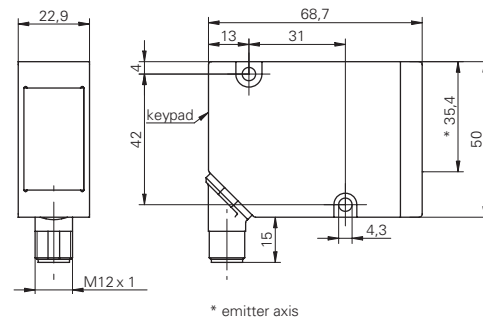
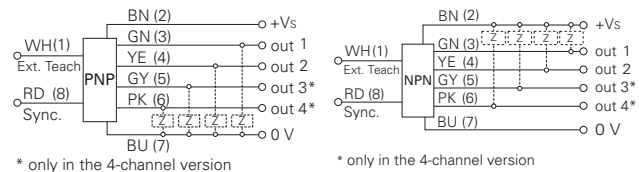

FKDM 22P1911/S14F

**dimension drawing****connection diagrams**





## white light version

product family	FKDH 14	FKDK 14	FKDR 14
			
type	diffuse contrast sensor	diffuse contrast sensor	diffuse contrast sensor
width / diameter	19,6 mm	14,8 mm	19,6 mm
sensing distance $T_w$	12,5 mm $\pm$ 2 mm	12,5 mm $\pm$ 2 mm	12,5 mm $\pm$ 2 mm
response time / release time	< 0,05 ms	< 0,05 ms	< 0,05 ms
light source	white LED	white LED	white LED
sensitivity adjustment	Teach-in	Teach-in	Teach-in
output circuit	push-pull	push-pull	push-pull
connection types	cable flylead connector	cable connector	connector
housing material	metal	plastic	metal
<b>page</b>	<b>426</b>	<b>428</b>	<b>430</b>

## laser version

product family	OZDK 10	OZDK 10	OZDK 14	OZDM 16	OZDM 16
					
type	diffuse contrast sensor	diffuse contrast sensor	diffuse contrast sensor	diffuse contrast sensor	diffuse contrast sensor
width / diameter	10,4 mm	10,4 mm	14,8 mm	15,4 mm	15,4 mm
sensing distance $T_w$	3 ... 150 mm	3 ... 150 mm	20 ... 300 mm	0 ... 250 mm	0 ... 250 mm
response time / release time	< 0,05 ms	< 0,05 ms	< 0,15 ms	< 0,1 ms	< 0,05 ms
light source	pulsed red laser diode	pulsed red laser diode	pulsed red laser diode	pulsed red laser diode	pulsed red laser diode
sensitivity adjustment	potentiometer, 5 turn	potentiometer, 5 turn	Teach-in	potentiometer, 14 turn	potentiometer, 14 turn
output circuit	NPN PNP	NPN PNP	NPN PNP	PNP	NPN PNP
connection types	cable connector	cable connector	connector cable	cable connector	cable connector
housing material	plastic	plastic	plastic	metal	metal
<b>page</b>	<b>432</b>	<b>434</b>	<b>436</b>	<b>438</b>	<b>440</b>



## General information

Diffuse contrast sensors can detect finest differences in contrast. Contrasts arise when surfaces bear bright and dark areas (e.g. a dark color mark on a bright primary color), or by structures on a surface (e.g. a weld seam).

## Applications

- Recognize print marks (FKDK 14)  
Print marks (or color marks) are usually dark-colored marks on a light background. The marks differ from the background in brightness and often in color.
- Detect edges, seams, grooves (laser sensors)  
If a surface is observed from an oblique angle, the reflection behavior changes at an indentation, which to the sensor is equivalent to a contrast difference.

## Characteristics and advantages

- White light sensor  
The narrow white light line allows precise detection of color marks
- Laser sensors  
Thanks to the focused beam, even the slightest edge up to 0.1 mm in height can be detected.
- Fast response time  
Very short response times up to 50  $\mu$ s allow "real time" recording of marks and thus increase the process accuracy.
- Sensor with analog signal  
Allows to import desired nominal values and to detect deviations thereof.

## Technology and operation

Diffuse contrast sensors are based on the intensity difference principle with a clearly defined small light spot. At the ideal operating distance the sensor is optimized so that the finest contrast differences are detected almost independent of small changes in distance. The graph "Relative signal reception" was measured on white paper.

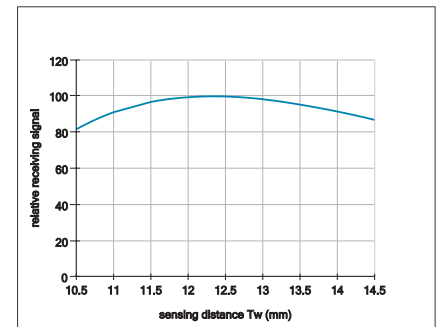

## Mounting and adjustment

The sensor should usually be mounted inclined by 5° to 20° to the object surface, especially when shiny material is scanned. When scanning edges, grooves or indentations, the sensor must be aligned so that the direct reflection is detected when the indentation, groove, or edge enters the light beam.

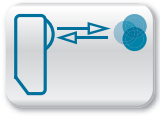

$T_w = 12.5 \text{ mm}$

- hygiene design
- very short response time
- White light



#### general data

type	diffuse contrast sensor
special type	hygienic design
light source	white LED
sensing distance $T_w$	12,5 mm $\pm$ 2 mm
light indicator	LED green
output indicator	LED yellow
sensitivity adjustment	Teach-in
distance to focus	12,5 mm
beam height	3 mm
beam width	1 mm
approvals/certificates	Ecolab EHEDG

#### electrical data

response time / release time	< 0,05 ms
voltage supply range +Vs	18 ... 30 VDC
current consumption max. (no load)	50 mA
current consumption typ.	40 mA
voltage drop Vd	< 3 VDC
output function	light / dark operate
output circuit	push-pull
output current	< 100 mA
short circuit protection	yes
reverse polarity protection	yes

#### mechanical data

width / diameter	19,6 mm
height / length	52,2 mm
depth	34,3 mm
type	rectangular
housing material	stainless steel 1.4404 (V4A)
front (optics)	PMMA

#### ambient conditions

operating temperature	-25 ... +60 °C
protection class	IP 68/69K & proTect+

#### order reference

<b>FKDH 14G6901</b>	cable 4 pin, 2 m
<b>FKDH 14G6901/KS34A</b>	flylead connector M12, L=300 mm

#### connection types

#### connection diagram

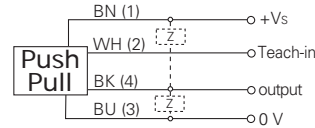

#### connectors and mating connectors

ESG 34AY0200 Connector M12, 4 pin, straight, 2 m, V4A-PP

ESW 33AY0200 Connector M12, 4 pin, angular, 2 m, V4A-PP

additional cable connectors and field wireable connectors: see accessories

#### Accessories

HI17-1H Mounting for sensors in hygienic design  $\varnothing$  17 mm  
for details: see accessories section

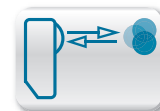

relative receiving signal

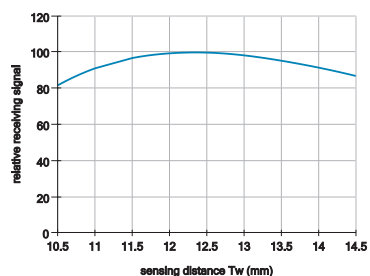

dimension drawings

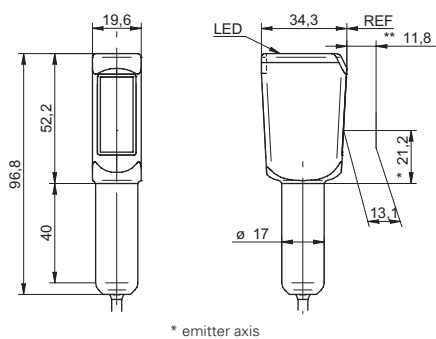

\* emitter axis

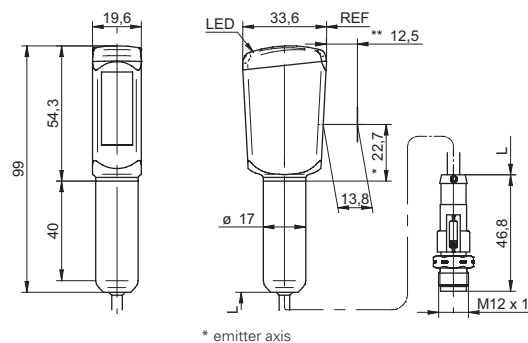

\* emitter axis

FKDH 14 Tw = 12.5 mm

Diffuse contrast sensors

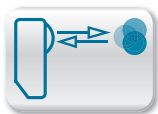

$T_w = 12.5 \text{ mm}$

- very short response time
- white light



#### general data

type	diffuse contrast sensor
light source	white LED
sensing distance $T_w$	12,5 mm $\pm$ 2 mm
light indicator	LED green
output indicator	LED yellow
sensitivity adjustment	Teach-in
distance to focus	12,5 mm
beam height	3 mm
beam width	1 mm

#### electrical data

response time / release time	< 0,05 ms
voltage supply range +Vs	18 ... 30 VDC
current consumption max. (no load)	50 mA
current consumption typ.	40 mA
voltage drop Vd	< 3 VDC
output function	light / dark operate
output circuit	push-pull
output current	< 100 mA
short circuit protection	yes
reverse polarity protection	yes

#### mechanical data

width / diameter	14,8 mm
height / length	43 mm
depth	31 mm
type	rectangular
housing material	plastic (ASA, MABS)
front (optics)	PMMA

#### ambient conditions

operating temperature	-25 ... +65 °C
protection class	IP 67

#### order reference

order reference	connection types
FKDK 14G6901	cable 4 pin, 2 m
FKDK 14G6901/S14	connector M12 4 pin
FKDK 14G6901/S35A	connector M8 4 pin

#### connection diagram

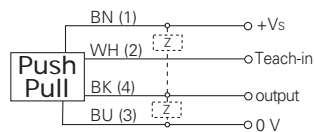

#### connectors and mating connectors

ESG 34AH0200	Connector M12, 4 pin, straight, 2 m
ESW 33AH0200	Connector M12, 4 pin, angular, 2 m
ESG 32AH0200	Connector M8, 4 pin, straight, 2 m
ESW 31AH0200	Connector M8, 4 pin, angular, 2 m

additional cable connectors and field wireable connectors: see accessories

#### Accessories

10134964	Mounting bracket series 14 (L design)
10149011	Sensofix series 14

for details: see accessories section

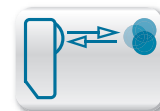

relative receiving signal

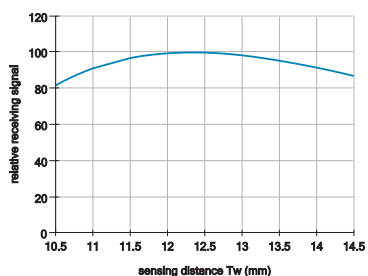

dimension drawings

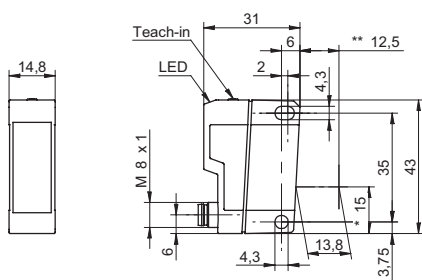

\* emitter axis

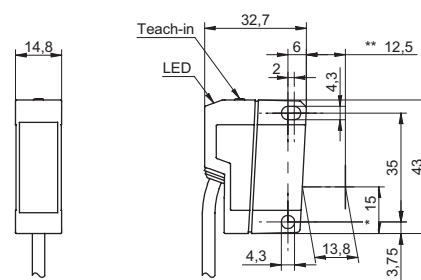

\* emitter axis

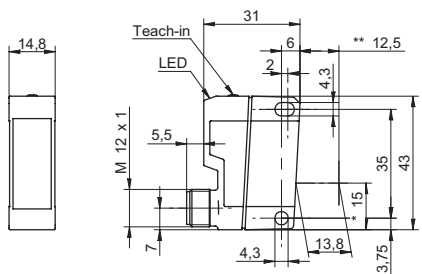

\* emitter axis

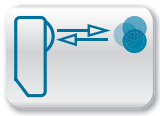

$T_w = 12.5 \text{ mm}$



- washdown design
- very short response time
- White light

#### general data

type	diffuse contrast sensor
special type	Washdown design
light source	white LED
sensing distance $T_w$	12,5 mm $\pm$ 2 mm
light indicator	LED green
output indicator	LED yellow
sensitivity adjustment	Teach-in
distance to focus	12,5 mm
beam height	3 mm
beam width	1 mm
approvals/certificates	Ecolab

#### electrical data

response time / release time	< 0,05 ms
voltage supply range +Vs	18 ... 30 VDC
current consumption max. (no load)	50 mA
current consumption typ.	40 mA
voltage drop Vd	< 3 VDC
output function	light / dark operate
output circuit	push-pull
output current	< 100 mA
short circuit protection	yes
reverse polarity protection	yes

#### mechanical data

width / diameter	19,6 mm
height / length	51 mm
depth	34,3 mm
type	rectangular
housing material	stainless steel 1.4404 (V4A)
front (optics)	PMMA
connection types	connector M12

#### ambient conditions

operating temperature	-25 ... +60 °C
protection class	IP 68/69K & proTect+

#### order reference

FKDR 14G6901/S14

#### connection diagram

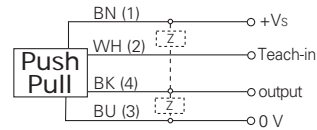

#### Accessories

10134964	Mounting bracket series 14 (L design)
10149011	Sensofix series 14

for details: see accessories section



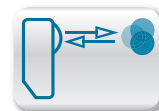

relative receiving signal

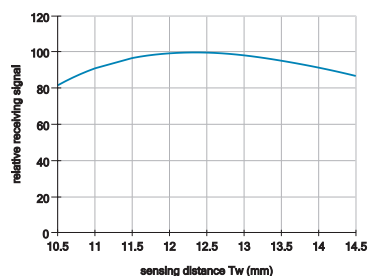

dimension drawing

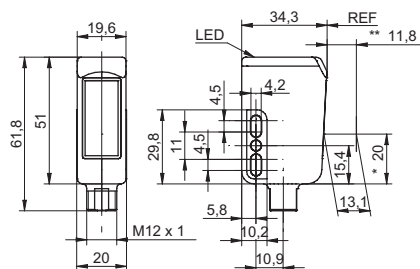

\* emitter axis

FKDR 14 Tw = 12.5 mm

Diffuse contrast sensors

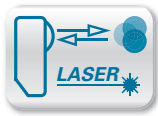

Tw = 3 ... 150 mm

- compact housing
- high repeatability
- very short response time

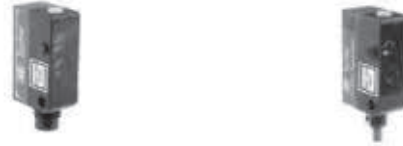

**general data**

type	diffuse contrast sensor
version	line beam
light source	pulsed red laser diode
sensing distance Tw	3 ... 150 mm
optimum operating distance	35 ... 45 mm
repeat accuracy	< 0,2 mm at laser focus
power on indication	LED green
light indicator	LED yellow
sensitivity adjustment	potentiometer, 5 turn
laser class	1
distance to focus	40 mm
wave length	650 nm

**electrical data**

response time / release time	< 0,05 ms
voltage supply range +Vs	10 ... 30 VDC
current consumption max. (no load)	50 mA
current consumption typ.	40 mA
voltage drop Vd	< 1,8 VDC
output function	light / dark operate
output current	< 100 mA
short circuit protection	yes
reverse polarity protection	yes

**mechanical data**

width / diameter	10,4 mm
height / length	27 mm
depth	16,3 mm
type	rectangular
housing material	plastic (ASA)
front (optics)	PMMA

**ambient conditions**

operating temperature	-10 ... +50 °C
-----------------------	----------------

**connection diagrams**



**connectors and mating connectors**

ESG 32AH0200	Connector M8, 4 pin, straight, 2 m
ESW 31AH0200	Connector M8, 4 pin, angular, 2 m

additional cable connectors and field wireable connectors: see accessories

**Accessories**

10150326	Sensofix series 10 / series 20
10114501	Mounting bracket series 10 (U design)
10133792	Mounting bracket series 10 (L design)
10162083	Mounting panel for sensors series 10
10118798	Mounting bracket series 10

for details: see accessories section

**laser warning**



IEC 60825-1/2014  
Complies with 21 CFR 1040.10 and 1040.11  
except for deviations pursuant to laser  
notice No. 50, dated June 24, 2007

order reference	connection types	output circuit	protection class
OZDK 10N5150	cable 4 pin, 2 m	NPN	IP 65
OZDK 10N5150/S35A	connector M8 4 pin	NPN	IP 67
OZDK 10P5150	cable 4 pin, 2 m	PNP	IP 65
OZDK 10P5150/S35A	connector M8 4 pin	PNP	IP 67

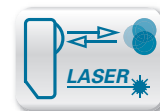

relative receiving signal

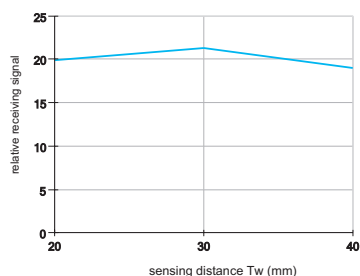

beam characteristic (typically)

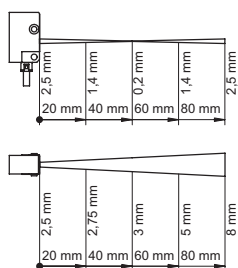

dimension drawings

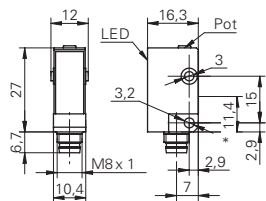

\* emitter axis

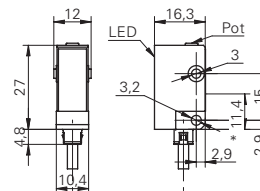

\* emitter axis

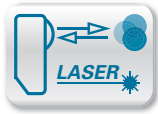

Tw = 3 ... 150 mm

- compact housing
- high repeatability
- very short response time



**general data**

type	diffuse contrast sensor
light source	pulsed red laser diode
sensing distance Tw	3 ... 150 mm
optimum operating distance	20 ... 40 mm
detectable remission difference (on grey)	> 8 %
repeat accuracy	< 0,2 mm at laser focus
power on indication	LED green
light indicator	LED yellow
sensitivity adjustment	potentiometer, 5 turn
laser class	2
distance to focus	40 mm
wave length	650 nm

**electrical data**

response time / release time	< 0,05 ms
voltage supply range +Vs	10 ... 30 VDC
current consumption max. (no load)	50 mA
current consumption typ.	40 mA
voltage drop Vd	< 1,8 VDC
output function	light / dark operate
output current	< 100 mA
short circuit protection	yes
reverse polarity protection	yes

**mechanical data**

width / diameter	10,4 mm
height / length	27 mm
depth	16,3 mm
type	rectangular
housing material	plastic (ASA)
front (optics)	PMMA

**ambient conditions**

operating temperature	-10 ... +50 °C
-----------------------	----------------

**connection diagrams**



**connectors and mating connectors**

ESG 32AH0200	Connector M8, 4 pin, straight, 2 m
ESW 31AH0200	Connector M8, 4 pin, angular, 2 m

additional cable connectors and field wireable connectors: see accessories

**Accessories**

10150326	Sensofix series 10 / series 20
10114501	Mounting bracket series 10 (U design)
10133792	Mounting bracket series 10 (L design)
10162083	Mounting panel for sensors series 10
10118798	Mounting bracket series 10

for details: see accessories section

**laser warning**

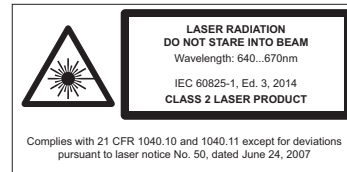

Complies with 21 CFR 1040.10 and 1040.11 except for deviations pursuant to laser notice No. 50, dated June 24, 2007

order reference	connection types	output circuit	protection class
OZDK 10N5101	cable 4 pin, 2 m	NPN	IP 65
OZDK 10N5101/S35A	connector M8 4 pin	NPN	IP 67
OZDK 10P5101	cable 4 pin, 2 m	PNP	IP 65
OZDK 10P5101/S35A	connector M8 4 pin	PNP	IP 67

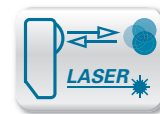

relative receiving signal

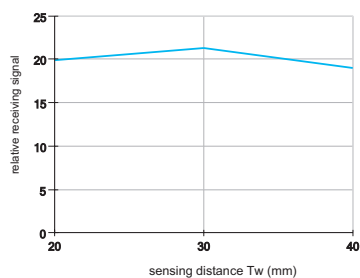

beam characteristic (typically)

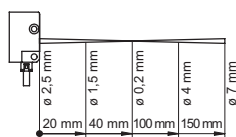

dimension drawings

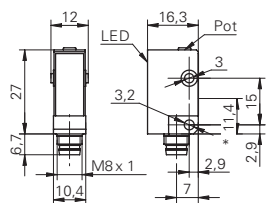

\* emitter axis

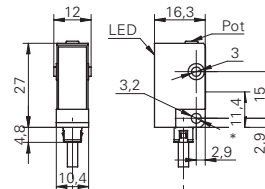

\* emitter axis

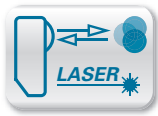

Tw = 20 ... 300 mm



- very short response time
- high repeatability
- sensing distance adjustable via Teach-in

**general data**

type	diffuse contrast sensor
light source	pulsed red laser diode
sensing distance Tw	20 ... 300 mm
optimum operating distance	40 ... 60 mm
repeat accuracy	< 0,2 mm at laser focus
alignment / soiled lens indicator	flashing light indicator
power on indication	LED green
light indicator	LED yellow
sensitivity adjustment	Teach-in
laser class	2
distance to focus	115 mm
wave length	650 nm

**electrical data**

response time / release time	< 0,15 ms
voltage supply range +Vs	10 ... 30 VDC
current consumption max. (no load)	35 mA
current consumption typ.	25 mA
voltage drop Vd	< 2,2 VDC
output function	light operate
output current	< 100 mA
short circuit protection	yes
reverse polarity protection	yes

**mechanical data**

width / diameter	14,8 mm
height / length	43 mm
depth	31 mm
type	rectangular
housing material	plastic (ASA, MABS)
front (optics)	PMMA

**ambient conditions**

operating temperature	-10 ... +50 °C
protection class	IP 67

**connection diagrams**



**connectors and mating connectors**

ESG 34AH0200	Connector M12, 4 pin, straight, 2 m
ESW 33AH0200	Connector M12, 4 pin, angular, 2 m
ESG 32AH0200	Connector M8, 4 pin, straight, 2 m
ESW 31AH0200	Connector M8, 4 pin, angular, 2 m

additional cable connectors and field wireable connectors: see accessories

**Accessories**

10149011	Sensofix series 14
10134964	Mounting bracket series 14 (L design)

for details: see accessories section

**laser warning**

**order reference**

order reference	connection types	output circuit
OZDK 14N1901/S14	connector M12 4 pin	NPN
OZDK 14P1901	cable 4 pin, 2 m	PNP
OZDK 14P1901/S14	connector M12 4 pin	PNP
OZDK 14P1901/S35A	connector M8 4 pin	PNP

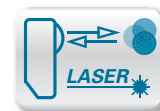

relative receiving signal

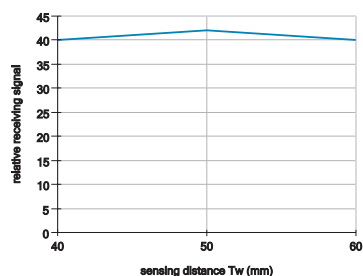

beam characteristic (typically)

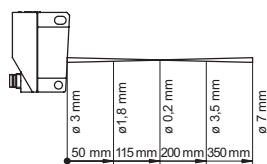

dimension drawings

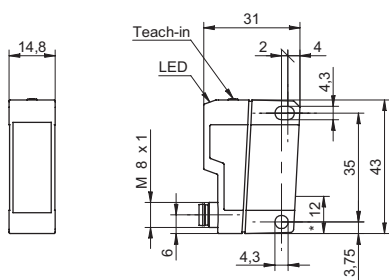

\* emitter axis

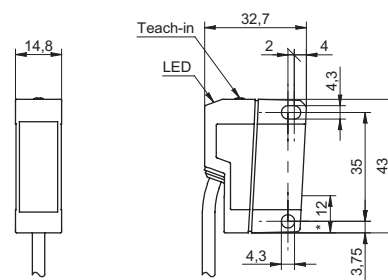

\* emitter axis

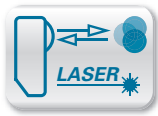

$T_w = 0 \dots 250 \text{ mm}$

- with analog output
- high repeatability
- very short response time



#### general data

type	diffuse contrast sensor
light source	pulsed red laser diode
sensing distance $T_w$	0 ... 250 mm
optimum operating distance	40 ... 80 mm
detectable remission difference (on grey)	> 8 %
repeat accuracy	< 0,1 mm at laser focus
output indicator	LED yellow
sensitivity adjustment	potentiometer, 14 turn
laser class	1
distance to focus	80 mm
wave length	650 nm

#### electrical data

response time / release time	< 0,1 ms
voltage supply range +Vs	12 ... 30 VDC
current consumption max. (no load)	65 mA
current consumption typ.	60 mA
voltage drop Vd	< 2 VDC
output function	light operate
output circuit	PNP / analog 4 ... 20 mA
output current	< 200 mA
short circuit protection	yes
reverse polarity protection	yes

#### mechanical data

width / diameter	15,4 mm
height / length	50 mm
depth	50 mm
type	rectangular
housing material	die-cast zinc
front (optics)	glass

#### ambient conditions

operating temperature	-10 ... +50 °C
protection class	IP 67

#### order reference

order reference	connection types
OZDM 16P1901	cable 4 pin, 2 m
OZDM 16P1901/S14	connector M12 4 pin

#### connection diagram

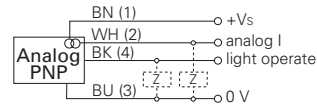

#### connectors and mating connectors

ESG 34AH0200 Connector M12, 4 pin, straight, 2 m

ESW 33AH0200 Connector M12, 4 pin, angular, 2 m

additional cable connectors and field wireable connectors: see accessories

#### Accessories

10151721 Sensofix series 16

10113917 Mounting bracket series 16 (L design)

for details: see accessories section

#### laser warning

**CLASS 1 LASER  
PRODUCT**

IEC 60825-1/2014

Complies with 21 CFR 1040.10 and 1040.11  
except for deviations pursuant to laser  
notice No. 50, dated June 24, 2007



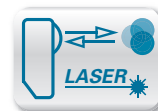

signal progression

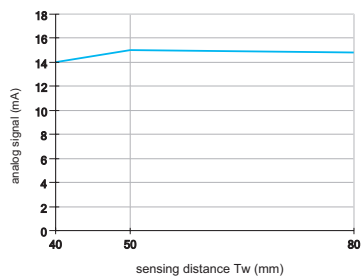

beam characteristic (typically)

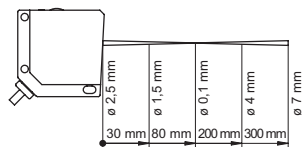

dimension drawings

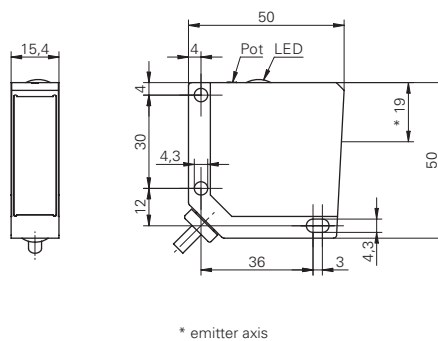
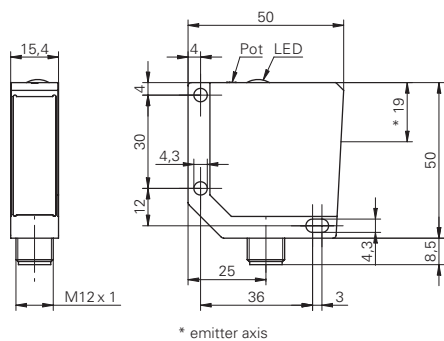

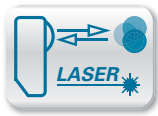

Tw = 0 ... 250 mm



- rugged metal housing
- high repeatability
- very short response time

**general data**

type	diffuse contrast sensor
light source	pulsed red laser diode
sensing distance Tw	0 ... 250 mm
optimum operating distance	40 ... 80 mm
detectable remission difference (on grey)	> 8 %
repeat accuracy	< 0,1 mm at laser focus
output indicator	LED yellow
sensitivity adjustment	potentiometer, 14 turn
laser class	1
distance to focus	80 mm
wave length	650 nm

**electrical data**

response time / release time	< 0,05 ms
voltage supply range +Vs	12 ... 30 VDC
current consumption max. (no load)	65 mA
current consumption typ.	60 mA
voltage drop Vd	< 2 VDC
output current	< 200 mA
short circuit protection	yes
reverse polarity protection	yes

**mechanical data**

width / diameter	15,4 mm
height / length	50 mm
depth	50 mm
type	rectangular
housing material	die-cast zinc
front (optics)	glass

**ambient conditions**

operating temperature	-10 ... +50 °C
protection class	IP 67

**connection diagrams**

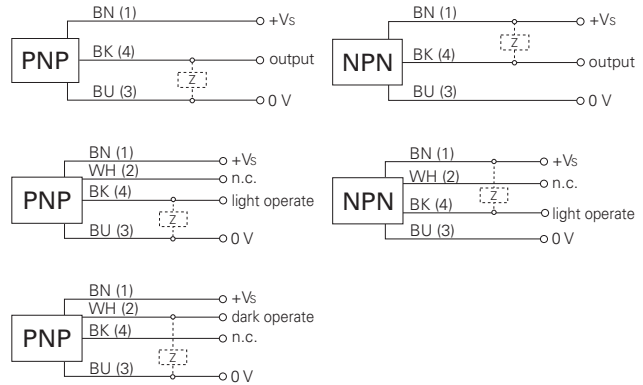

**connectors and mating connectors**

ESG 34AH0200	Connector M12, 4 pin, straight, 2 m
ESW 33AH0200	Connector M12, 4 pin, angular, 2 m

additional cable connectors and field wireable connectors: see accessories

**Accessories**

10151721	Sensofix series 16
10113917	Mounting bracket series 16 (L design)

for details: see accessories section

**laser warning**



IEC 60825-1/2014  
Complies with 21 CFR 1040.10 and 1040.11  
except for deviations pursuant to laser  
notice No. 50, dated June 24, 2007

order reference	connection types	output circuit	output function
OZDM 16N1001	cable 3 pin, 2 m	NPN	light operate
OZDM 16N1001/S14	connector M12 4 pin	NPN	light operate
OZDM 16P1001	cable 3 pin, 2 m	PNP	light operate
OZDM 16P1001/S14	connector M12 4 pin	PNP	light operate
OZDM 16P3001	cable 3 pin, 2 m	PNP	dark operate
OZDM 16P3001/S14	connector M12 4 pin	PNP	dark operate

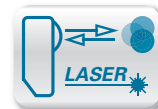

relative receiving signal

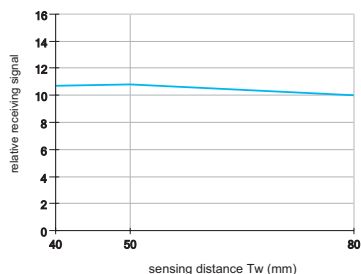



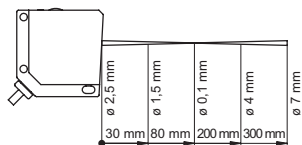

beam characteristic (typically)

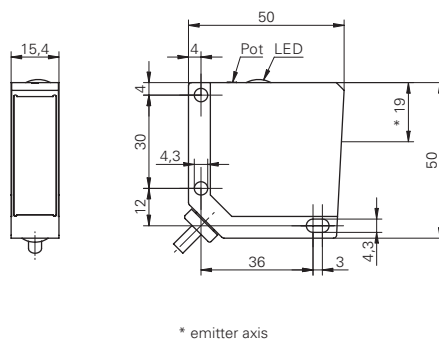
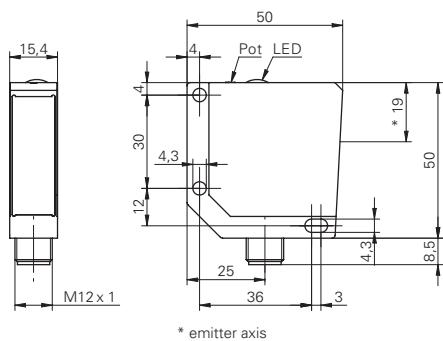

dimension drawings





product family	OBDM 12	OBDM 12	OBDM 12	OBDM 12	OBDM 12
					
type	step analysis	min./max. analysis	tolerance analysis	window analysis	2-point comparison
width / diameter	12,4 mm	12,4 mm	12,4 mm	12,4 mm	12,4 mm
sensing distance $T_w$	16 ... 120 mm	16 ... 120 mm	16 ... 120 mm	16 ... 120 mm	16 ... 120 mm
response time	< 5 ms	< 1 ms	< 1 ms	< 1 ms	< 1 ms
light source	pulsed red laser diode	pulsed red laser diode	pulsed red laser diode	pulsed red laser diode	pulsed red laser diode
output circuit	NPN PNP	NPN PNP	NPN PNP	NPN PNP	NPN PNP
connection types	connector	connector	connector	connector	connector
housing material	metal	metal	metal	metal	metal
page	448	449	450	451	452



## General information

The range of difference sensors opens new perspectives in the field of sensing. The patented functions provide the user with new, innovative solutions in the detection of objects, monitoring of tolerances or the comparison of object sizes and object positions. With the fine laser beam and the high insensitivity of the sensor to colors, objects are accurately detected. Five different sensors with different functions are available according to the application.

- Difference sensors with:
- Step analysis
  - Window analysis
  - Tolerance analysis
  - Min./max. analysis
  - 2-point comparisons

## Characteristics and advantages

### Difference evaluation

Distance measuring sensors with integrated logic for distance difference evaluation. Complex evaluation by the connected controller is no longer necessary, saving time and costs.

### Nominal difference teachable

With the standardized Teach-in process of Baumer, the nominal difference can be quickly and easily programmed.

### Switching output

The comparison of the actual and nominal difference is made internally by the sensors and is issued at the switching output as a simply assessed pass/fail signal.

## Applications and functions

### Difference sensors with step analysis

In step analysis, objects are detected by their height difference (stage) and reported in the form of a digital output signal.

The sensor evaluates the positive or negative height difference within a specified time window of max. 5 ms. If the height difference is greater than 50 % of the taught-in value, an impulse of at least 10 ms is issued at the output. When the value is less than 50 %, the sensor switches back to the OFF state. If height differences are smaller than 50 % of the taught value within the time window (e.g. fluctuation of the conveyor belt), the sensor remains in the OFF state.

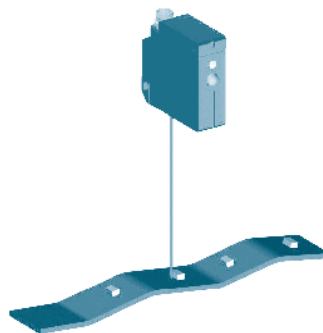

- The stage / edge from which the objects are detected can be adjusted (minimum object height 0,2 mm)
- Defined output impulse of 10 ms (can also be read by a normal PLC)
- Detection of objects on a fluctuating conveyor belt
- Detection of stages or edges
- Positioning of objects by an edge, regardless of the distance



## Applications and functions

### Difference sensors with min./max. analysis

With min./max. analysis, objects can be inspected and monitored according to their scanned contour or shape. The scanning of the objects is activated by an external control signal. At the end of a detection sequence, the measured values are evaluated and the difference between the minimum and maximum values is determined. If the difference exceeds a nominal difference previously taught into the sensor, this is reported in the form of an ON signal. This signal remains active until a new detection sequence is started. When this starts, the output returns to the OFF state. If the difference is smaller than the nominal difference, the output remains in the OFF state.



- Difference is detected regardless of the distance
- Start and stop of the measuring cycle can be determined independently
- Easily evaluated pass/fail signal
- Round true running or knock of wheels / discs can be checked regardless of the distance
- Deformation of plastic parts after cooling can be checked

### Difference sensors with tolerance analysis

The dimensional tolerance of objects can be determined by tolerance analysis. In the continuous detection of object distances, all measured values are checked to determine if it is between the specified maximum and minimum tolerances. In the case of if being between, an ON signal is issued at the output. If the distance remains within the tolerance range, the sensor remains in the OFF state.

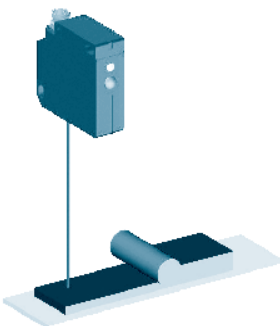

- Sensor form of a caliper gauge
- Simple monitoring of a distance with a tolerance range (pass/fail information)
- Tolerance range and nominal distance can be taught in separately
- Material thickness checking after a roller mill
- Material thickness checking for extruders



## Applications and functions

### Difference sensors with window analysis

With window analysis, objects can be classified by a specified switching window.

For this purpose, the switching window is specified in a simple Teach-in procedure with upper and lower limits. If an object is outside the defined limits, this is reported at the switching output.

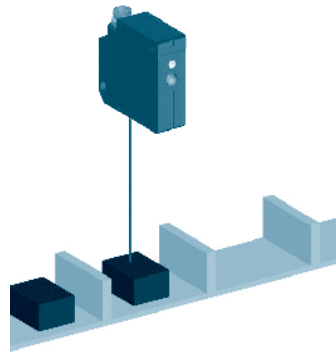

- Foreground and background suppression in a single sensor
- Positions can be taught in separately
- Smallest window 0,45 mm
- Interfering objects in the foreground and background can be suppressed
- Objects can be detected on a segmented conveyor belt

### Difference sensors with 2-point comparison

In a 2-point comparison, two distances detected at two specifically chosen times are measured and compared.

The choice of the time is made using a sync signal. The first distance is measured at the rising flank of the signal and the second distance at the falling flank of the signal. After the second distance was measured, the sensor evaluates the difference between the two distances and compares this with a previously taught-in maximum permissible deviation. If this difference is exceeded, the output switches to the ON state.

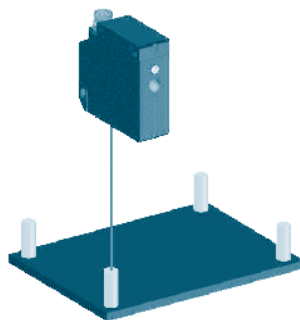

- Object heights can be compared regardless of the distance
- Deviation can be taught in (min. 0,3 mm)
- Measuring time can be determined separately by an external signal
- Checking the pressing depth of pins
- Comparison of the distances/heights of objects with a reference value





## Mounting and adjustment

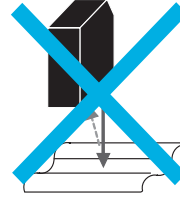
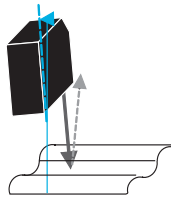

The direct reflection from glossy or reflective objects must not impinge on the receiver. This can be avoided by slightly tilting the sensor.

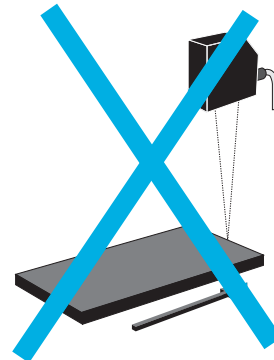
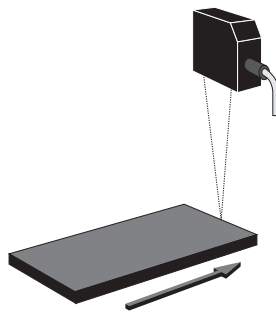

For optimum measurement results, the sensor must be installed at right angles to the movement of the object.

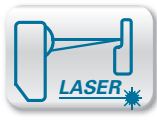

Tw = 16 ... 120 mm



- detection of edges
- reference steps adjustable
- min. output pulse 10 ms

**general data**

type	step analysis
sensing distance Tw	16 ... 120 mm
Teach-in range min.	> 0,2 mm
adjustment	Teach-in
power on indication	LED green
output indicator	LED red
light source	pulsed red laser diode
laser class	2
wave length	650 nm
beam diameter	0,5 ... 0,2 mm

**electrical data**

response time	< 5 ms
voltage supply range +Vs	12 ... 28 VDC
current consumption max. (no load)	80 mA
current consumption typ.	40 mA
output current	< 100 mA
output pulse length	10 ms
voltage drop Vd	< 2,8 VDC
reverse polarity protection	yes, Vs to GND
short circuit protection	yes

**mechanical data**

width / diameter	12,4 mm
height / length	37 mm
depth	34,5 mm
type	rectangular
front (optics)	glass
housing material	die-cast zinc
connection types	connector M8 4 pin

**ambient conditions**

operating temperature	0 ... +50 °C
protection class	IP 67

**connectors and mating connectors**

ESG 32AH0200	Connector M8, 4 pin, straight, 2 m
ESW 31AH0200	Connector M8, 4 pin, angular, 2 m
additional cable connectors and field wireable connectors: see accessories	

**Accessories**

10150328	Sensofix series 12
10113873	Mounting bracket series 12 (L design)
for details: see accessories section	

**dimension drawing**

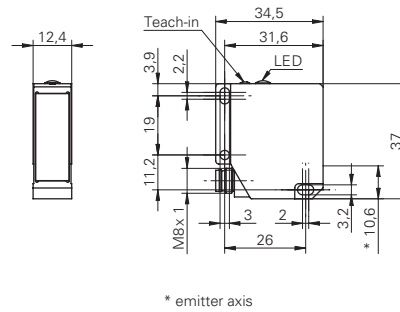

**connection diagrams**

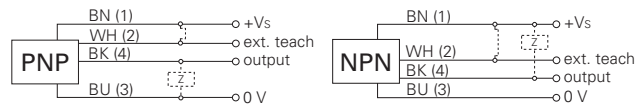

**min. detectable difference**

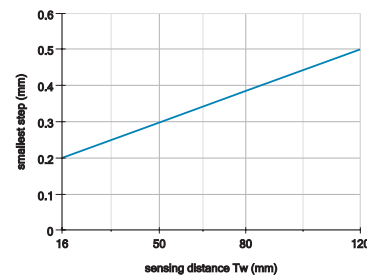

**laser warning**

**LASER RADIATION**  
**DO NOT STARE INTO BEAM**  
Wavelength: 640...670nm  
IEC 60825-1, Ed. 3, 2014  
**CLASS 2 LASER PRODUCT**

Complies with 21 CFR 1040.10 and 1040.11 except for deviations pursuant to laser notice No. 50, dated June 24, 2007

**order reference**

**output circuit**

<b>OBDM 12N6910/S35A</b>	NPN
<b>OBDM 12P6910/S35A</b>	PNP

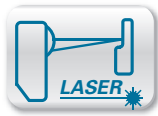

Tw = 16 ... 120 mm



- analysis of distance differences (min./max.)
- max. difference tolerance adjustable
- measuring time selectable

**general data**

type	min./max. analysis
sensing distance Tw	16 ... 120 mm
Teach-in range min.	> 0,3 mm
adjustment	Teach-in
power on indication	LED green
output indicator	LED red
light source	pulsed red laser diode
laser class	2
wave length	650 nm
beam diameter	0,5 ... 0,2 mm

**electrical data**

response time	< 1 ms
voltage supply range +Vs	12 ... 28 VDC
current consumption max. (no load)	80 mA
current consumption typ.	40 mA
output current	< 100 mA
voltage drop Vd	< 2,8 VDC
reverse polarity protection	yes, Vs to GND
short circuit protection	yes

**mechanical data**

width / diameter	12,4 mm
height / length	37 mm
depth	34,5 mm
type	rectangular
front (optics)	glass
housing material	die-cast zinc
connection types	connector M8 4 pin

**ambient conditions**

operating temperature	0 ... +50 °C
protection class	IP 67

**connectors and mating connectors**

ESG 32AH0200 Connector M8, 4 pin, straight, 2 m  
 ESW 31AH0200 Connector M8, 4 pin, angular, 2 m  
 additional cable connectors and field wireable connectors: see accessories

**Accessories**

10150328	Sensofix series 12
10113873	Mounting bracket series 12 (L design)

for details: see accessories section

order reference	output circuit
OBDM 12N6920/S35A	NPN
OBDM 12P6920/S35A	PNP

**dimension drawing**

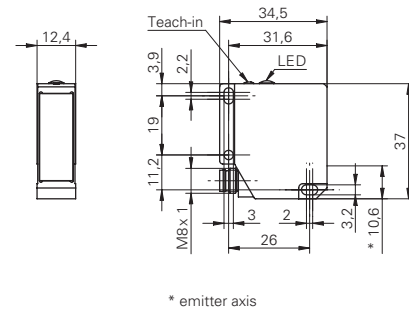

**connection diagrams**

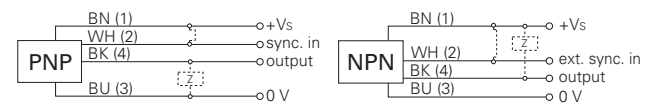

**min. detectable difference**

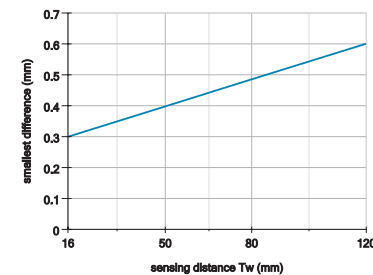

**laser warning**

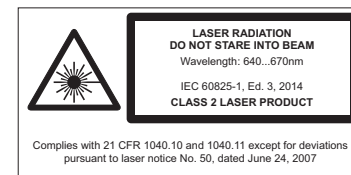

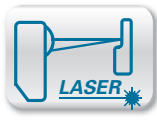

Tw = 16 ... 120 mm



- distance monitoring within a tolerance band
- nominal distance
- adjustable tolerance band

**general data**

type	tolerance analysis
sensing distance Tw	16 ... 120 mm
Teach-in range min.	> 0,4 mm
adjustment	Teach-in
power on indication	LED green
output indicator	LED red
light source	pulsed red laser diode
laser class	2
wave length	650 nm
beam diameter	0,5 ... 0,2 mm

**electrical data**

response time	< 1 ms
voltage supply range +Vs	12 ... 28 VDC
current consumption max. (no load)	80 mA
current consumption typ.	40 mA
output current	< 100 mA
voltage drop Vd	< 2,8 VDC
reverse polarity protection	yes, Vs to GND
short circuit protection	yes

**mechanical data**

width / diameter	12,4 mm
height / length	37 mm
depth	34,5 mm
type	rectangular
front (optics)	glass
housing material	die-cast zinc
connection types	connector M8 4 pin

**ambient conditions**

operating temperature	0 ... +50 °C
protection class	IP 67

**connectors and mating connectors**

ESG 32AH0200	Connector M8, 4 pin, straight, 2 m
ESW 31AH0200	Connector M8, 4 pin, angular, 2 m
additional cable connectors and field wireable connectors: see accessories	

**Accessories**

10150328	Sensofix series 12
10113873	Mounting bracket series 12 (L design)
for details: see accessories section	

**dimension drawing**

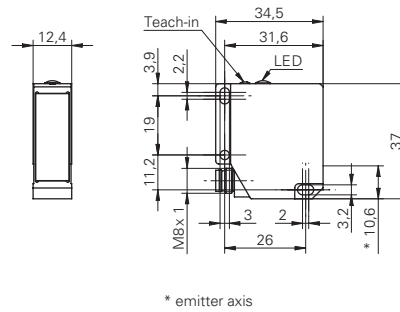

**connection diagrams**

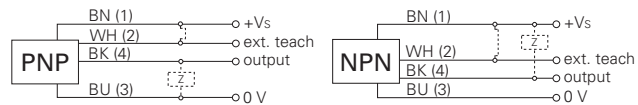

**min. detectable difference**

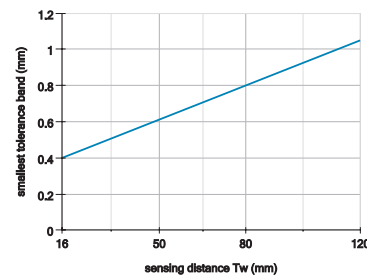

**laser warning**

**LASER RADIATION**  
DO NOT STARE INTO BEAM  
Wavelength: 640...670nm  
IEC 60825-1, Ed. 3, 2014  
**CLASS 2 LASER PRODUCT**

Complies with 21 CFR 1040.10 and 1040.11 except for deviations pursuant to laser notice No. 50, dated June 24, 2007

**order reference**

<b>OBDM 12N6930/S35A</b>	NPN
<b>OBDM 12P6930/S35A</b>	PNP

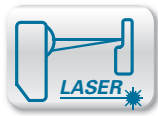

Tw = 16 ... 120 mm



- range switch (foreground / background suppression)
- adjustable window

**general data**

type	window analysis
sensing distance Tw	16 ... 120 mm
Teach-in range min.	> 0,4 mm
adjustment	Teach-in
power on indication	LED green
output indicator	LED red
light source	pulsed red laser diode
laser class	2
wave length	650 nm
beam diameter	0,5 ... 0,2 mm

**electrical data**

response time	< 1 ms
voltage supply range +Vs	12 ... 28 VDC
current consumption max. (no load)	80 mA
current consumption typ.	40 mA
output current	< 100 mA
voltage drop Vd	< 2,8 VDC
reverse polarity protection	yes, Vs to GND
short circuit protection	yes

**mechanical data**

width / diameter	12,4 mm
height / length	37 mm
depth	34,5 mm
type	rectangular
front (optics)	glass
housing material	die-cast zinc
connection types	connector M8 4 pin

**ambient conditions**

operating temperature	0 ... +50 °C
protection class	IP 67

**connectors and mating connectors**

ESG 32AH0200	Connector M8, 4 pin, straight, 2 m
ESW 31AH0200	Connector M8, 4 pin, angular, 2 m
additional cable connectors and field wireable connectors: see accessories	

**Accessories**

10150328	Sensofix series 12
10113873	Mounting bracket series 12 (L design)
for details: see accessories section	

**order reference      output circuit**

<b>OBDM 12N6940/S35A</b>	NPN
<b>OBDM 12P6940/S35A</b>	PNP

**dimension drawing**

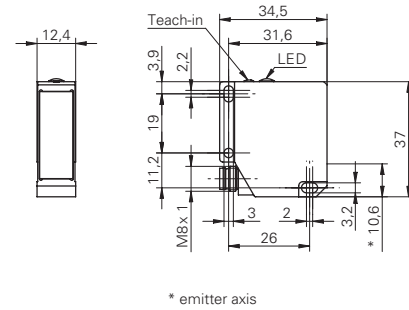

**connection diagrams**

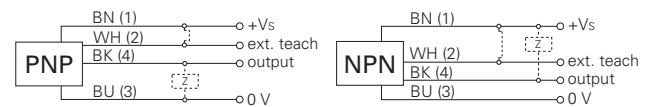

**min. detectable difference**

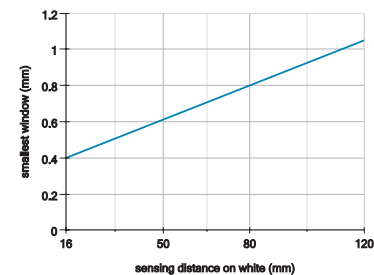

**laser warning**

**LASER RADIATION**  
**DO NOT STARE INTO BEAM**  
 Wavelength: 640...670nm  
 IEC 60825-1, Ed. 3, 2014  
**CLASS 2 LASER PRODUCT**

Complies with 21 CFR 1040.10 and 1040.11 except for deviations pursuant to laser notice No. 50, dated June 24, 2007

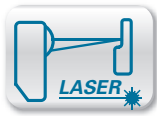

Tw = 16 ... 120 mm



- comparison of two distances
- max. tolerance adjustable
- specific measuring moment selectable

**general data**

type	2-point comparison
sensing distance Tw	16 ... 120 mm
Teach-in range min.	> 0,3 mm
adjustment	Teach-in
power on indication	LED green
output indicator	LED red
light source	pulsed red laser diode
laser class	2
wave length	650 nm
beam diameter	0,5 ... 0,2 mm

**electrical data**

response time	< 1 ms
voltage supply range +Vs	12 ... 28 VDC
current consumption max. (no load)	80 mA
current consumption typ.	40 mA
output current	< 100 mA
voltage drop Vd	< 2,8 VDC
reverse polarity protection	yes, Vs to GND
short circuit protection	yes

**mechanical data**

width / diameter	12,4 mm
height / length	37 mm
depth	34,5 mm
type	rectangular
front (optics)	glass
housing material	die-cast zinc
connection types	connector M8 4 pin

**ambient conditions**

operating temperature	0 ... +50 °C
protection class	IP 67

**connectors and mating connectors**

ESG 32AH0200	Connector M8, 4 pin, straight, 2 m
ESW 31AH0200	Connector M8, 4 pin, angular, 2 m
additional cable connectors and field wireable connectors: see accessories	

**Accessories**

10150328	Sensofix series 12
10113873	Mounting bracket series 12 (L design)
for details: see accessories section	

**dimension drawing**

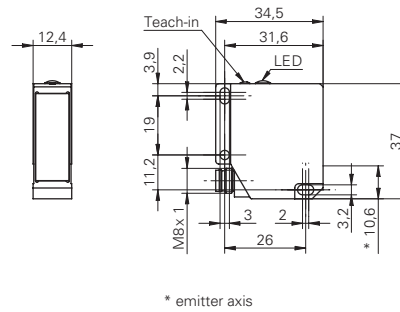

**connection diagrams**

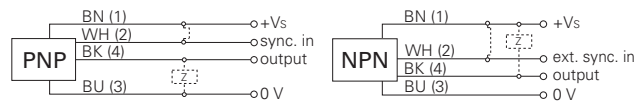

**min. detectable difference**

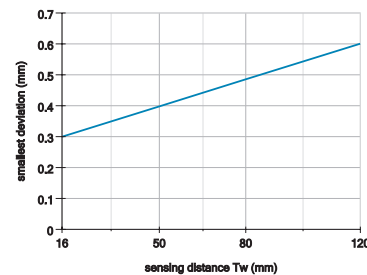

**laser warning**

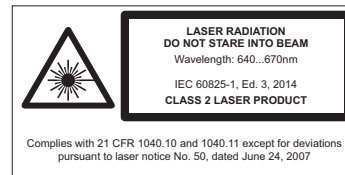

**order reference**

**output circuit**

OBDM 12N6950/S35A	NPN
OBDM 12P6950/S35A	PNP



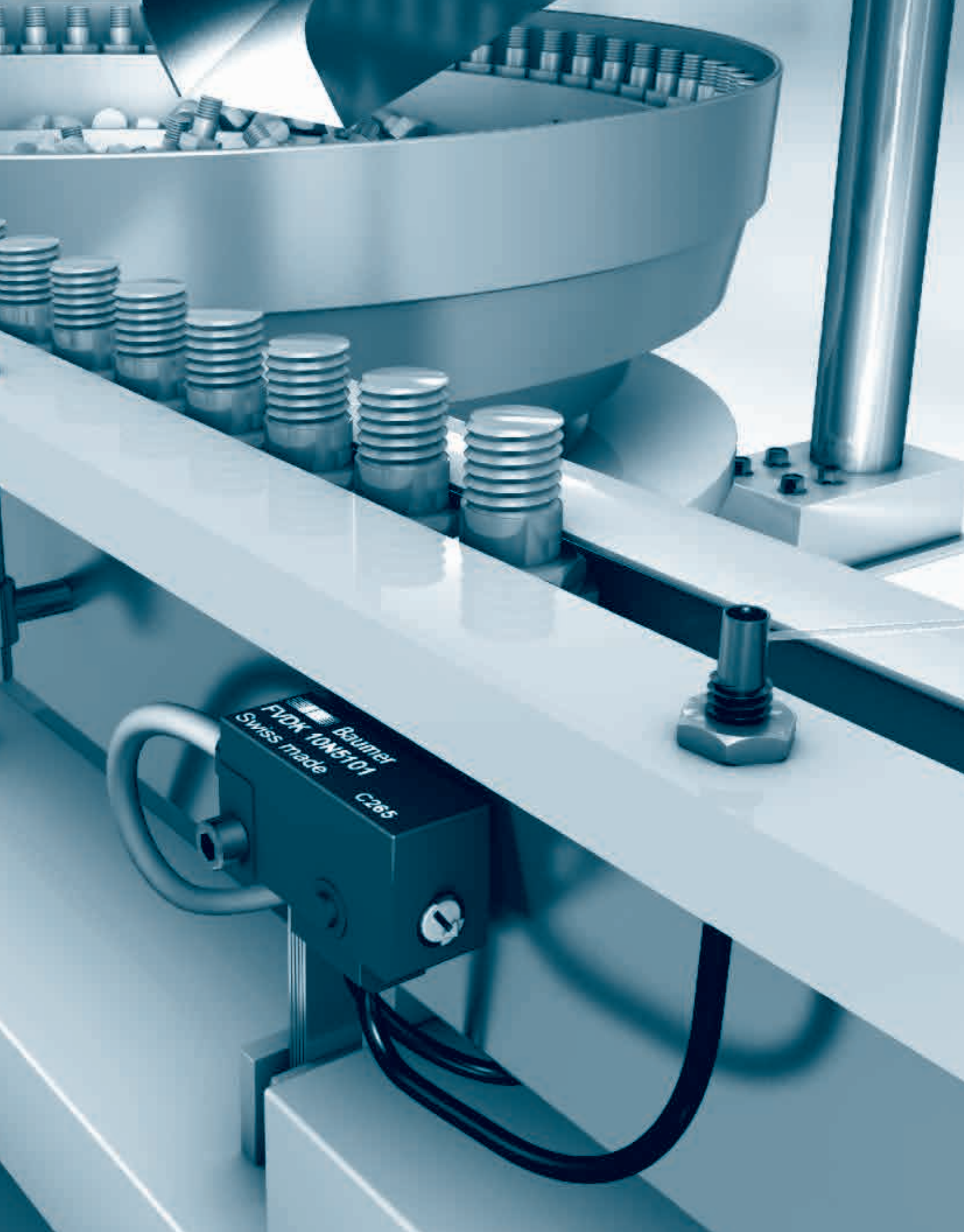















## Fiber optics and fiber optic sensors

Plastic fiber optic sensors	Page 456
Plastic fiber optics / Diffuse types	Page 473
Plastic fiber optics / Through beam types	Page 501
Glass fiber optic sensors	Page 533
Glass fiber optics / Diffuse types	Page 540
Glass fiber optics / Through beam types	Page 542

product family	FVDK 10	FVDK 12	FVDK 12	FVDK 22	FVDK 66	FVDK 66	FVDK 67
							
version		integrated alarm output	fast version	integrated alarm output	master slave		2 outputs
width / diameter	10,4 mm	12 mm	12 mm	22 mm	10 mm	10 mm	10 mm
actual range Sb (FSE 200C1002)	160 mm	320 mm	140 mm	320 mm	340 mm	340 mm	1200 mm
sensing distance Tw (FUE 200C1003)	45 mm	90 mm	40 mm	90 mm	130 mm	130 mm	300 mm
response time / release time	< 1 ms	< 1 ms	< 0,05 ms	< 1 ms	0,25 ... 1 ms	0,25 ... 1 ms	0,14 ... 5 ms
light source	pulsed red LED	pulsed red LED	pulsed red LED	pulsed red LED	pulsed red LED	pulsed red LED	pulsed red LED
output circuit	NPN PNP	PNP	PNP	PNP	NPN PNP	NPN PNP	NPN PNP
connection types	cable connector	cable connector	connector	cable connector	cable	cable connector	cable connector
housing material	plastic	plastic	plastic	plastic	plastic	plastic	plastic
<b>page</b>	<b>462</b>	<b>463</b>	<b>464</b>	<b>465</b>	<b>466</b>	<b>467</b>	<b>468</b>

product family	FVDK 67	FVDK 67	FVDK 80	FWDK 84
				
version	master slave		small hysteresis high sensitivity	
width / diameter	10 mm	10 mm	10 mm	10 mm
actual range Sb (FSE 200C1002)	1200 mm	1200 mm	240 mm 440 mm	90 mm
sensing distance Tw (FUE 200C1003)	300 mm	300 mm	70 mm 120 mm	25 mm
response time / release time	0,05 ... 5 ms 0,058 ... 5 ms	0,05 ... 5 ms 0,058 ... 5 ms	< 0,5 ms	1 ... 50 ms
light source	pulsed red LED	pulsed red LED	pulsed red LED	pulsed red LED
output circuit	NPN PNP	NPN PNP	NPN PNP	analog 1 ... 5 VDC
connection types	cable	cable connector flylead connector	cable flylead connector	cable
housing material	plastic	plastic	plastic	plastic
<b>page</b>	<b>469</b>	<b>470</b>	<b>471</b>	<b>472</b>





## General information

Fiber optics are the extended vision of conventional sensors and, due to their miniature construction, can be installed directly in the most difficult ambient conditions. As only light is conveyed, fiber optics are intrinsically safe, which adds to their range of applications.

Plastic fiber optics are characterized primarily by the properties of the employed raw material – the plastic. Advances in the manufacture of plastics permit bending radii of just 1 mm for the optical fibers, which is completely impossible for glass fibers. Fiber materials are now available which are extremely tolerant to bending and thereby make their use in drag chains possible.

## Typical applications

Due to their versatility, optical fibers can be used in the most diverse applications. The small, space-saving sensing heads are very suitable for use in very constricted conditions. It is also possible to monitor whole areas or execute precise positioning by the different arrangements of the fibers.

- Due to the light weight and space-saving construction, optical fibers can be integrated directly in pick & place tools
- Detection, differentiation and positioning of the most diverse objects
- Monitoring of whole areas with fiber optic arrays with linear fiber arrangement
- Use at high, low or constantly fluctuating ambient temperatures
- Detection of levels or leaks, including hazardous liquids
- Detection of transparent media such as glass, wafers or films with focused fiber optic reflective types

## Characteristics and advantages

### Independent of the environment

As only light is conveyed, electromagnetic fields, high or low temperatures have no effect on the functional reliability.

### Space-saving

The smallest sensing heads have a diameter of 1,5 mm and are only 10 mm long. With bending radii of just 1 mm, it is possible to integrate the eye of the sensor even in the most constricted places.

### Precise light spots

Fiber cross-sections of only 0,25 mm generate a fine core beam in fiber optic through beam types, whereas doubling lenses in fiber optic reflective types permit precise light spots of 0,1 mm.

### Application-specific fiber arrangement

The coaxial fiber arrangement permits optimum light distribution over the receiver fibers and thereby makes precise positioning of objects possible. Also, fiber optic arrays with a linear fiber arrangement allow a whole area to be monitored or the detection of randomly conveyed objects.

### Application feedback

Multi-digit displays integrated in the fiber optic sensors permit the stability of the application to be assessed and make fault analyses possible.

### Fast processes

Fiber optic sensors with response times of only 50 microseconds allow the detection of objects even in very fast processes.



## Technology and operation

The technology is based on intensity differences. The fiber optic through beam types detect an object breaking the light beam between the emitter and receiver. The fiber optic reflective types evaluate the amount of light reflected back from an object. The high-resolution analog/digital conversion in the fiber optic sensors permits very slight changes to be evaluated. This is important where the detection of small objects or differentiation of the finest contrasts is demanded.

Fundamentally, the fiber optics form a unit with the corresponding processing units, and the type of fiber optic head is mainly decisive for the detection of objects. The table below is intended to provide aid in understanding the large range of different sensing heads:

Version/type	Properties	Field of application	Example types
Standard	Large selection of different shapes. Economical	Standard applications, simple object detection	FUE 200C1003 FUE 200C1004
Coaxial	Homogenous light distribution over all receiver fibers. Lens adaptation possible	Optimally suited for positioning tasks. Highly accurate in combination with focusing lenses	FCE 200C1Y00 FCE 200D1Y00
Side light exit	90° light exit Reduced beam angle More installation space	Constricted conditions	FUE 200C4Y00 FSE 200C4002
Array	Linear arrangement of the fibers. Line lengths of 5,25 ... 21 mm. Reflective or through beam types	Detection of objects which cannot be precisely conveyed. Measurement of object sizes or edge positions	FUE 200C6Y00 FSE 200C6Y00
Longer range Parallel beam	Integrated lens Small beam angle Long range	Object detection and positioning over a long distance. No influencing by interfering objects close to the optical fiber	FLE 200C1Y00 FPE 200C1Y00
Highly flexible	Min. bending radius down to 1 mm Suitable for flexible installation	Constricted conditions	FUE 200E1Y00 FSE 200F6Y00
Bendable	Extremely bendable, designed for bending more than 1 million times.	For use in drag chains or on moving parts	FSE 200D1Y50
Small light spot	In combination with focusing lenses, a light spot of only 0,1mm can be produced.	Detection of very small objects Highly accurate edge positioning	FCE 050C1Y10 with lens 134544
Level detection	Special sensing tip to avoid liquid residues. Version for pipe/hose fitting	Detection of levels in different liquids, in or out of contact	FUL 200D2Y00 FSL 500C6Y00 FOC 500C6Y00
Spezial versions	Heat and cold resistant Chemical and oil resistant	For extreme environmental. Conditions such as chemical or aggressive surroundings or temperatures from -60 ... +350 °C	FUG 500C1Y00 FUC 200C2Y00



## Fiber optic sensors of the ranges FVDK 66 and FVDK 67 – versatile and multifunctional

The generation of multifunction fiber optic sensors is particularly suitable for handling processes, where very fast movements as well as exact positioning or the detection of very small objects are important. A single sensor undertakes the tasks which were formerly performed by many different sensors. The user can choose from 3 to 8 different operating modes from very short response time to high sensitivity to adapt the sensor optimally to his application. Despite the all-in-one concept, the requirement for simple operation is also fulfilled.

	FVDK 67	FVDK 66
Sensing range (FSE 200C1002)	1200 mm	340 mm
Sensing distance (FUE 200C1003)	300 mm	130 mm
Min. response time	50 µsec	250 µsec
Speed / sensing modes	5 levels	3 levels
Adjustment	Automatically via teach-in manually with +/- button	Automatically via teach-in manually with +/- button
Suppression of reciprocal influences	8 sensors	2 sensors
Long-term stability	yes	yes
Timer	On- or Off-Delay On- and Off-Delay One-Shot One-Shot and On-Delay	On- or Off-Delay
Available versions	Standard With external teach-in Master/Slave 2 switching outputs	Standard With external teach-in Master/Slave
Additional functions	Factory setup Rotate display Delay / freeze display Keylock Chemical and oil resistant	Factory setup Rotate display

### Reduced wiring

With the master/slave version up to 16 sensors can be connected together to one unit (consisting of one master and the appropriate number of slaves). Only the power of the master has to be wired. The slaves are supplied through the side plug. For maximum flexibility in the wiring of the individual sensor signals each slave has a single-core cable. Series 66 and 67 can be combined in any order.

### Application feedback

The application feedback is particularly important during commissioning if consistent detection is to be ensured. The switching point and the relative received signal are indicated simultaneously on the 2x4 digit display of the FVDK 67 range. With this information it can be determined at a glance whether the switching point has been optimally adjusted.

### Long-term stability

In both sensor series measures have been taken to ensure the long-term stability of the switching function. This is done either by compensating the aging of the emitting LED or by repositioning the switching threshold.



## Teach-in or potentiometer? Just simple operation

The fiber optic sensors of the FVDK 12, 22 and 60 ranges are characterized particularly by their simple handling. The sensitivity can be adjusted either with a potentiometer or a Teach-in button. Differently colored LEDs or simple displays provide the adjustment feedback. The sensor ranges differ primarily in their speed, sensitivity, hysteresis functions and supplementary functions such as timers, external Teach-in or logical output gates. However, all have the same thing in common: regardless of where the sensor is installed, the adjustment can be made practically without the need for operating instructions.



### Type FVDK 12

- Integrated, dynamic Teach-in allows the most reliable detection of moving objects or small parts for which it is difficult to find an exact Teach-in position
- High-speed version with a response time of only 50  $\mu$ s
- Integrated alarm output warns in advance of excessive soiling
- Protection class IP 65



### Type FVDK 22

- Two sensors in one housing reduces the necessary wiring
- The two integrated sensors do not interfere with each other
- It is possible to link the two outputs logically
- Version with external Teach-in from the controller

## Teach-in or potentiometer? Just simple operation



### Type FVDK 10

- Smallest fiber optic sensor
- Easy and quick sensitivity adjustment with potentiometer
- Protection against optical interference between up to 3 optical fibers

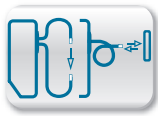

**S<sub>b</sub> = 160 mm**  
**T<sub>w</sub> = 45 mm**

- sensitivity adjustable via potentiometer
- suppression of mutual optical interference



**general data**

actual range S <sub>b</sub> (FSE 200C1002)	160 mm
sensing distance T <sub>w</sub> (FUE 200C1003)	45 mm
light source	pulsed red LED
light indicator	LED yellow
alignment / soiled lens indicator	flashing light indicator
adjustment	potentiometer, 270°
wave length	660 nm
suppression of reciprocal influence	yes

**electrical data**

response time / release time	< 1 ms
voltage supply range +V <sub>s</sub>	10 ... 30 VDC
current consumption max. (no load)	30 mA
current consumption typ.	20 mA
voltage drop V <sub>d</sub>	< 1,8 VDC
output function	light / dark operate
output current	< 100 mA
short circuit protection	yes
reverse polarity protection	yes

**mechanical data**

width / diameter	10,4 mm
height / length	27 mm
depth	14 mm
type	rectangular
housing material	plastic (ASA)

**ambient conditions**

operating temperature	-25 ... +55 °C
protection class	IP 40

**connectors and mating connectors**

ESG 32AH0200	Connector M8, 4 pin, straight, 2 m
ESW 31AH0200	Connector M8, 4 pin, angular, 2 m
additional cable connectors and field wireable connectors: see accessories	

**Accessories**

10150326	Sensofix series 10 / series 20
10114501	Mounting bracket series 10 (U design)
10133792	Mounting bracket series 10 (L design)
10162083	Mounting panel for sensors series 10
10118798	Mounting bracket series 10
for details: see accessories section	

**dimension drawings**

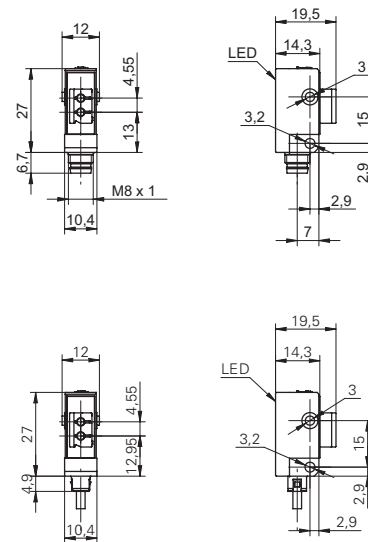

**connection diagrams**



order reference	output circuit	connection types
FVDK 10N5101	NPN	cable, 2 m
FVDK 10N5101/S35A	NPN	connector M8
FVDK 10P5101	PNP	cable, 2 m
FVDK 10P5101/S35A	PNP	connector M8

FVDK 10 S<sub>b</sub> = 160 mm, T<sub>w</sub> = 45 mm

Plastic fiber optic sensors



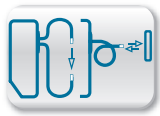

**S<sub>b</sub> = 320 mm**  
**T<sub>w</sub> = 90 mm**

- sensitivity adjustable via Teach-in
- integrated alarm output
- protection class IP 65



**general data**

actual range S <sub>b</sub> (FSE 200C1002)	320 mm
sensing distance T <sub>w</sub> (FUE 200C1003)	90 mm
light source	pulsed red LED
light indicator	LED green
alignment / soiled lens indicator	LED green, flashing
output indicator	LED yellow
adjustment	Teach-in
wave length	660 nm

**electrical data**

response time / release time	< 1 ms
voltage supply range +V <sub>s</sub>	10 ... 30 VDC
current consumption max. (no load)	46 mA
current consumption typ.	36 mA
voltage drop V <sub>d</sub>	< 1,8 VDC
output function	light / dark operate switchable
output circuit	PNP
output current	< 100 mA
short circuit protection	yes
reverse polarity protection	yes

**mechanical data**

width / diameter	12 mm
height / length	33,2 mm
depth	60 mm
type	rectangular
housing material	PBT / PC

**ambient conditions**

operating temperature	-25 ... +55 °C
protection class	IP 65

**connectors and mating connectors**

ESG 32AH0200	Connector M8, 4 pin, straight, 2 m
ESW 31AH0200	Connector M8, 4 pin, angular, 2 m
additional cable connectors and field wireable connectors: see accessories	

**Accessories**

10145702	Mounting bracket for fiber optic sensors series 12
for details: see accessories section	

**dimension drawings**

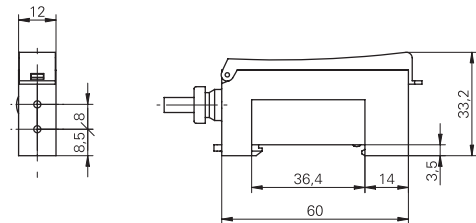
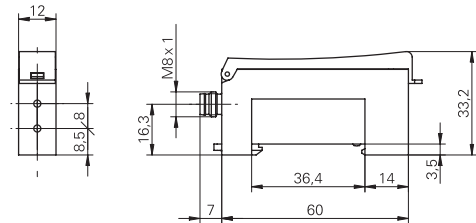

**connection diagrams**

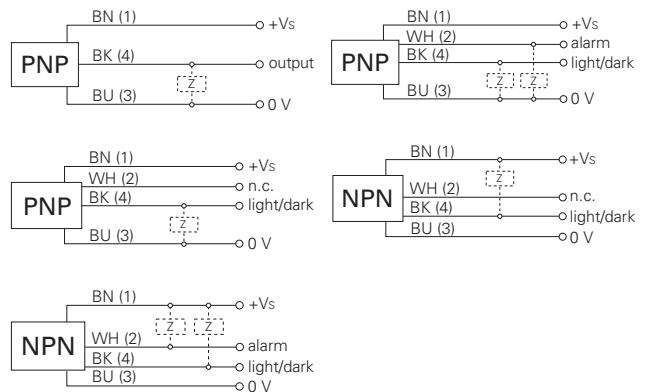

order reference	min. output pulse length	connection types	version
FVDK 12P6101	-	cable, 2 m	-
FVDK 12P6101/S35A	-	connector M8 4 pin	-
FVDK 12P6401	-	cable, 2 m	integrated alarm output
FVDK 12P6401/S35A	-	connector M8 4 pin	integrated alarm output
FVDK 12P6501/S35A	40 ms	connector M8 4 pin	integrated alarm output

FVDK 12 Sb = 320 mm, Tw = 90 mm

Plastic fiber optic sensors

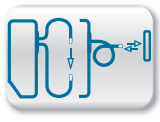

Sb = 140 mm



- short response time 50  $\mu$ s
- fast version < 0,05 ms
- integrated alarm output

**general data**

version	fast version
actual range Sb (FSE 200C1002)	140 mm
sensing distance Tw (FUE 200C1003)	40 mm
light source	pulsed red LED
light indicator	LED green
alignment / soiled lens indicator	LED green, flashing
output indicator	LED yellow
adjustment	Teach-in
wave length	660 nm

**electrical data**

response time / release time	< 0,05 ms
voltage supply range +Vs	10 ... 30 VDC
current consumption max. (no load)	45 mA
current consumption typ.	40 mA
voltage drop Vd	< 1,8 VDC
output function	light / dark operate switchable
output circuit	PNP
output current	< 100 mA
short circuit protection	yes
reverse polarity protection	yes

**mechanical data**

width / diameter	12 mm
height / length	33,2 mm
depth	60 mm
type	rectangular
housing material	PBT / PC
connection types	connector M8 4 pin

**ambient conditions**

operating temperature	-25 ... +55 °C
protection class	IP 65

**connectors and mating connectors**

ESG 32AH0200	Connector M8, 4 pin, straight, 2 m
ESW 31AH0200	Connector M8, 4 pin, angular, 2 m

additional cable connectors and field wireable connectors: see accessories

**Accessories**

10145702	Mounting bracket for fiber optic sensors series 12
----------	--

for details: see accessories section

**order reference**

FVDK 12P6410/S35A

**dimension drawing**

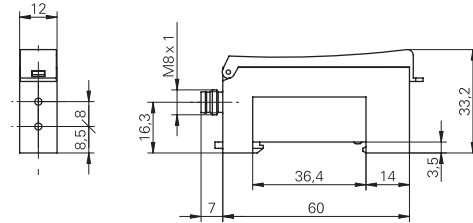

**connection diagram**

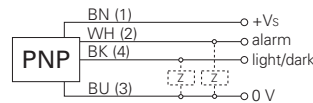

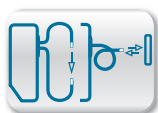

**Sb = 320 mm**  
**Tw = 90 mm**

- 2 sensors in one housing
- sensitivity adjustable via Teach-in
- optional logical output operation



**general data**

actual range Sb (FSE 200C1002)	320 mm
sensing distance Tw (FUE 200C1003)	90 mm
light source	pulsed red LED
light indicator	LED green
alignment / soiled lens indicator	LED green, flashing
output indicator	LED yellow
adjustment	Teach-in
wave length	660 nm
suppression of reciprocal influence	yes

**electrical data**

response time / release time	< 1 ms
voltage supply range +Vs	10 ... 30 VDC
current consumption max. (no load)	68 mA
current consumption typ.	50 mA
voltage drop Vd	< 1,8 VDC
output function	light / dark operate switchable
output circuit	PNP
output current	< 100 mA
short circuit protection	yes
reverse polarity protection	yes

**mechanical data**

width / diameter	22 mm
height / length	33,2 mm
depth	60 mm
type	rectangular
housing material	PBT / PC

**ambient conditions**

operating temperature	-25 ... +55 °C
protection class	IP 65

**connectors and mating connectors**

ESG 34CH0200	Connector M12, 5 pin, straight, 2 m
ESW 33CH0200	Connector M12, 5 pin, angular, 2 m
ESW 33CH0500	Connector M12, 5 pin, angular, 5 m

additional cable connectors and field wireable connectors: see accessories

**Accessories**

10125534	Mounting bracket for fiber optic sensors series 22
----------	--

for details: see accessories section

**dimension drawings**

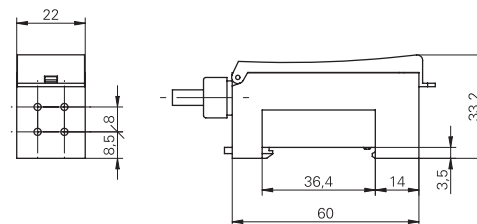
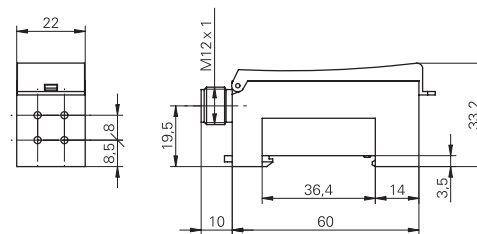

**connection diagrams**

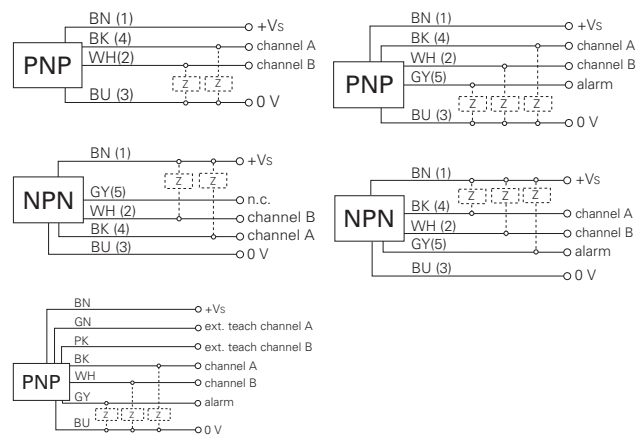

order reference	min. output pulse length	connection types	version
FVDK 22P6101	-	cable, 2 m	-
FVDK 22P6101/S14C	-	connector M12 5 pin	-
FVDK 22P6401	-	cable, 2 m	integrated alarm output
FVDK 22P6401/S14C	-	connector M12 5 pin	integrated alarm output
FVDK 22P6501/S14C	40 ms	connector M12 5 pin	integrated alarm output

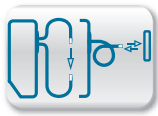

**S<sub>b</sub> = 340 mm**  
**T<sub>w</sub> = 130 mm**



- master/slave system with up to 15 extension units
- 2x4 digit display

**general data**

actual range S <sub>b</sub> (FSE 200C1002)	340 mm
sensing distance T <sub>w</sub> (FUE 200C1003)	130 mm
light source	pulsed red LED
light indicator	2 x 4-digit display
output indicator	LED yellow
adjustment	Teach-in
wave length	645 nm
suppression of reciprocal influence	yes

**electrical data**

response time / release time	0,25 ... 1 ms (adjustable)
voltage supply range +Vs	10,8 ... 26,4 VDC
current consumption max. (no load)	30 mA
voltage drop V <sub>d</sub>	< 2,1 VDC
output function	light / dark operate switchable
on / off delay	1 ... 5000 ms
output current	< 100 mA
short circuit protection	yes
reverse polarity protection	yes

**mechanical data**

width / diameter	10 mm
height / length	33,8 mm
depth	70,2 mm
type	rectangular
housing material	polycarbonate/ABS
connection types	cable, 2 m

**ambient conditions**

operating temperature	-20 ... +55 °C
protection class	IP 40

**Accessories**

10159806	Mounting bracket for fiber optic sensors series 60, 66, 67, 80
----------	--

for details: see accessories section

**dimension drawing**

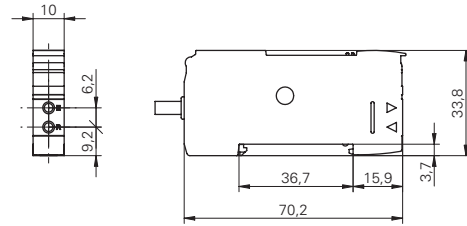

**connection diagrams**

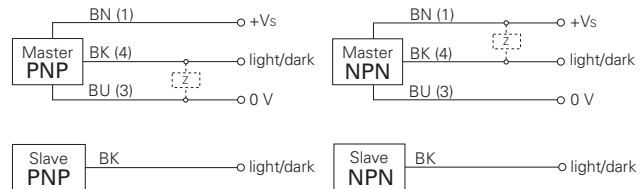

order reference	output circuit	version
FVDK 10N66YM	NPN	master
FVDK 10N66YS	NPN	slave
FVDK 10P66YM	PNP	master
FVDK 10P66YS	PNP	slave

FVDK 66 S<sub>b</sub> = 340 mm, T<sub>w</sub> = 130 mm

Plastic fiber optic sensors

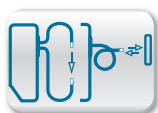

**Sb = 340 mm**  
**Tw = 130 mm**



- 2x4 digit display indicates the switching point and receiving light level
- easy operation

**general data**

actual range Sb (FSE 200C1002)	340 mm
sensing distance Tw (FUE 200C1003)	130 mm
light source	pulsed red LED
light indicator	2 x 4-digit display
output indicator	LED yellow
wave length	645 nm
suppression of reciprocal influence	yes

**electrical data**

response time / release time	0,25 ... 1 ms (adjustable)
voltage supply range +Vs	10,8 ... 26,4 VDC
current consumption max. (no load)	30 mA
voltage drop Vd	< 2,1 VDC
output function	light / dark operate switchable
on / off delay	1 ... 5000 ms
output current	< 100 mA
short circuit protection	yes
reverse polarity protection	yes

**mechanical data**

width / diameter	10 mm
height / length	33,8 mm
depth	70,2 mm
type	rectangular
housing material	polycarbonate/ABS

**ambient conditions**

operating temperature	-20 ... +55 °C
protection class	IP 40

**connectors and mating connectors**

ESG 32AH0200	Connector M8, 4 pin, straight, 2 m
ESW 31AH0200	Connector M8, 4 pin, angular, 2 m

additional cable connectors and field wireable connectors: see accessories

**Accessories**

10159806	Mounting bracket for fiber optic sensors series 60, 66, 67, 80
----------	--

for details: see accessories section

**dimension drawing**

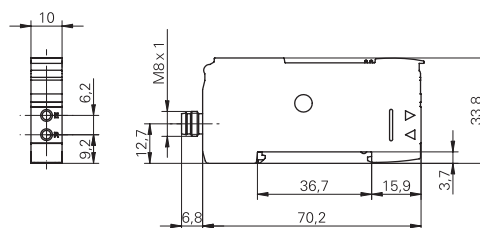

**connection diagrams**

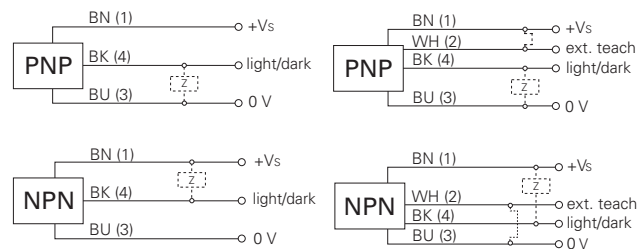

order reference	adjustment	output circuit	connection types
FVDK 10N66Y0	Teach-in	NPN	cable, 2 m
FVDK 10N66Y0/S35A	Teach-in	NPN	connector M8 4 pin
FVDK 10N66YR	Teach-in: button / external	NPN	cable, 2 m
FVDK 10P66Y0	Teach-in	PNP	cable, 2 m
FVDK 10P66Y0/S35A	Teach-in	PNP	connector M8 4 pin
FVDK 10P66YR	Teach-in: button / external	PNP	cable, 2 m

FVDK 66 Sb = 340 mm, Tw = 130 mm

Plastic fiber optic sensors

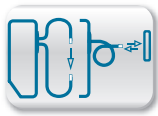

**S<sub>b</sub> = 1200 mm**  
**T<sub>w</sub> = 300 mm**



- 2 independently adjustable outputs
- suppression of mutual optical interference
- 2x4 digit display

**general data**

version	2 outputs
actual range S <sub>b</sub> (FSE 200C1002)	1200 mm
sensing distance T <sub>w</sub> (FUE 200C1003)	300 mm
light source	pulsed red LED
light indicator	2 x 4-digit display
output indicator	LED orange
adjustment	Teach-in
wave length	660 nm
suppression of reciprocal influence	yes

**electrical data**

response time / release time	0,14 ... 5 ms (adjustable)
voltage supply range +Vs	10,8 ... 26,4 VDC
current consumption max. (no load)	30 mA
voltage drop V <sub>d</sub>	< 2,1 VDC
output function	light / dark operate switchable
on / off delay	0,25 ... 20000 ms
min. output pulse length	0,25 ... 20000 ms
output current	< 30 mA
short circuit protection	yes
reverse polarity protection	yes

**mechanical data**

width / diameter	10 mm
height / length	33,8 mm
depth	70,2 mm
type	rectangular
housing material	polycarbonate/ABS

**ambient conditions**

operating temperature	-20 ... +55 °C
protection class	IP 40

**Accessories**

10159806	Mounting bracket for fiber optic sensors series 60, 66, 67, 80
----------	--

for details: see accessories section

**dimension drawings**

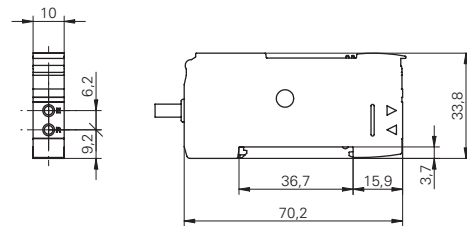
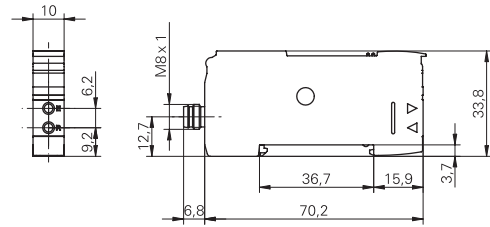

**connection diagrams**

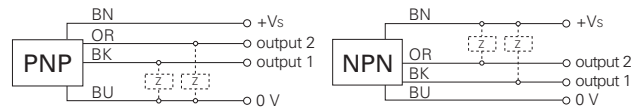

order reference	output circuit	connection types
FVDK 10N67Y2	NPN	cable, 2 m
FVDK 10P67Y2/S35A	PNP	connector M8 4 pin

FVDK 67 S<sub>b</sub> = 1200 mm, T<sub>w</sub> = 300 mm

Plastic fiber optic sensors

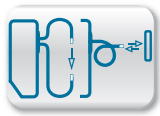

**Sb = 1200 mm**  
**Tw = 300 mm**



- master/slave system with up to 16 extension units
- integrated dynamic auto-teach-in function
- 2x4 digit display

**general data**

actual range Sb (FSE 200C1002)	1200 mm
sensing distance Tw (FUE 200C1003)	300 mm
light source	pulsed red LED
light indicator	2 x 4-digit display
output indicator	LED orange
adjustment	Teach-in
wave length	660 nm
suppression of reciprocal influence	yes

**electrical data**

voltage supply range +Vs	10,8 ... 26,4 VDC
current consumption max. (no load)	30 mA
voltage drop Vd	< 2,1 VDC
output function	light / dark operate switchable
on / off delay	0,25 ... 20000 ms
min. output pulse length	0,25 ... 20000 ms
output current	< 50 mA
short circuit protection	yes
reverse polarity protection	yes

**mechanical data**

width / diameter	10 mm
height / length	33,8 mm
depth	70,2 mm
type	rectangular
housing material	polycarbonate/ABS

**ambient conditions**

operating temperature	-20 ... +55 °C
protection class	IP 40

**Accessories**

10159806	Mounting bracket for fiber optic sensors series 60, 66, 67, 80
----------	--

for details: see accessories section

**dimension drawing**

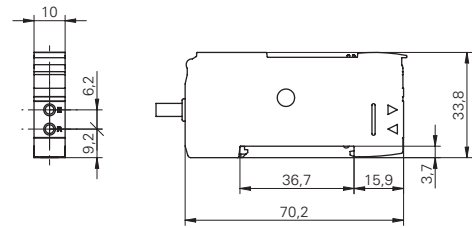

**connection diagrams**

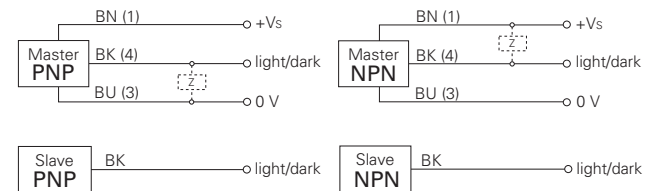

order reference	response time / release time	output circuit	connection types	version
FVDK 10N67YM	0,05 ... 5 ms (adjustable)	NPN	cable, 2 m	master
FVDK 10N67YS	0,05 ... 5 ms (adjustable)	NPN	cable (output only), 2 m	slave
FVDK 10P67YM	0,058 ... 5 ms (adjustable)	PNP	cable, 2 m	master
FVDK 10P67YS	0,058 ... 5 ms (adjustable)	PNP	cable (output only), 2 m	slave

FVDK 67 Sb = 1200 mm, Tw = 300 mm Plastic fiber optic sensors

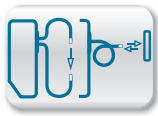

**S<sub>b</sub> = 1200 mm**  
**Tw = 300 mm**



- 2x4 digit display indicates the switching point and receiving light level
- versatile applicable due to 8 integrated operating

**general data**

actual range S <sub>b</sub> (FSE 200C1002)	1200 mm
sensing distance Tw (FUE 200C1003)	300 mm
light source	pulsed red LED
light indicator	2 x 4-digit display
output indicator	LED orange
wave length	660 nm
suppression of reciprocal influence	yes

**electrical data**

voltage supply range +Vs	10,8 ... 26,4 VDC
current consumption max. (no load)	30 mA
voltage drop V <sub>d</sub>	< 2,1 VDC
output function	light / dark operate switchable
on / off delay	0,25 ... 20000 ms
min. output pulse length	0,25 ... 20000 ms
short circuit protection	yes
reverse polarity protection	yes

**mechanical data**

width / diameter	10 mm
height / length	33,8 mm
depth	70,2 mm
type	rectangular
housing material	polycarbonate/ABS

**ambient conditions**

operating temperature	-20 ... +55 °C
protection class	IP 40

**connectors and mating connectors**

ESG 32AH0200	Connector M8, 4 pin, straight, 2 m
ESW 31AH0200	Connector M8, 4 pin, angular, 2 m

additional cable connectors and field wireable connectors: see accessories

**Accessories**

10159806	Mounting bracket for fiber optic sensors series 60, 66, 67, 80
----------	--

for details: see accessories section

**dimension drawings**

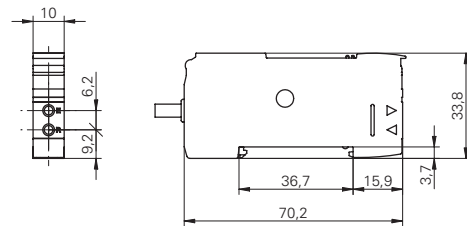
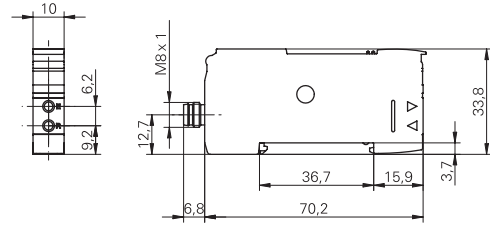

**connection diagrams**

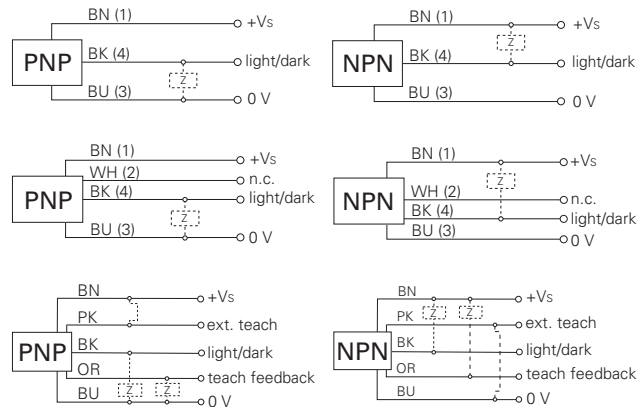

order reference	adjustment	response time / release time	output circuit	output current	connection types
FVDK 10N67Y0	Teach-in	0,05 ... 5 ms (adjustable)	NPN	< 100 mA	cable, 2 m
FVDK 10N67Y0/S35A	Teach-in	0,05 ... 5 ms (adjustable)	NPN	< 100 mA	connector M8 4 pin
FVDK 10N67YR	Teach-in: button / external	0,05 ... 5 ms (adjustable)	NPN	< 50 mA	cable, 2 m
FVDK 10P67Y0	Teach-in	0,058 ... 5 ms (adjustable)	PNP	< 100 mA	cable, 2 m
FVDK 10P67Y0/KS35A	Teach-in	0,058 ... 5 ms (adjustable)	PNP	< 100 mA	flylead connector M8 4 pin, L=200 mm
FVDK 10P67Y0/S35A	Teach-in	0,058 ... 5 ms (adjustable)	PNP	< 100 mA	connector M8 4 pin
FVDK 10P67YR	Teach-in: button / external	0,058 ... 5 ms (adjustable)	PNP	< 50 mA	cable, 2 m

FVDK 67 S<sub>b</sub> = 1200 mm, Tw = 300 mm

Plastic fiber optic sensors



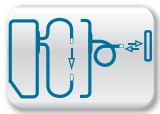

**S<sub>b</sub> = 440 mm**  
**T<sub>w</sub> = 120 mm**



- sensitivity adjustable via potentiometer
- fast and high sensitivity version available
- integrated alarm output

**general data**

light source	pulsed red LED
light indicator	LED green
alignment / soiled lens indicator	LED green, flashing
output indicator	LED red
adjustment	potentiometer
wave length	680 nm
suppression of reciprocal influence	yes

**electrical data**

response time / release time	< 0,5 ms
voltage supply range +Vs	10 ... 30 VDC
current consumption max. (no load)	35 mA
voltage drop V <sub>d</sub>	< 1 VDC
output function	light / dark operate switchable
off delay	40 ms
output current	< 100 mA
short circuit protection	yes
reverse polarity protection	yes

**mechanical data**

width / diameter	10 mm
height / length	29,7 mm
depth	60 mm
type	rectangular
housing material	polycarbonate/ABS

**ambient conditions**

operating temperature	-20 ... +60 °C
protection class	IP 40

**connectors and mating connectors**

ESG 32AH0200	Connector M8, 4 pin, straight, 2 m
ESW 31AH0200	Connector M8, 4 pin, angular, 2 m
additional cable connectors and field wireable connectors: see accessories	

**dimension drawings**

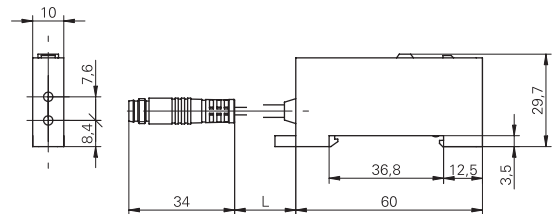
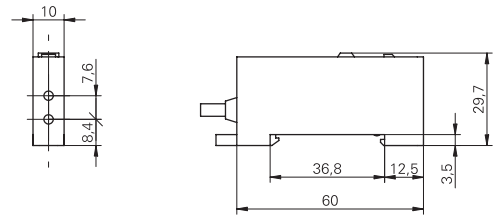

cable length L = 200 mm

**connection diagrams**



order reference	actual range S <sub>b</sub> (FSE 200C1002)	sensing distance T <sub>w</sub> (FUE 200C1003)	output circuit	connection types	version
FVDK 10N81Y0	240 mm	70 mm	NPN	cable, 2 m	small hysteresis
FVDK 10N83Y0	440 mm	120 mm	NPN	cable, 2 m	high sensitivity
FVDK 10P81Y0	240 mm	70 mm	PNP	cable, 2 m	small hysteresis
FVDK 10P81Y0/KS35A	240 mm	70 mm	PNP	flylead connector M8 4 pin, L=200 mm	small hysteresis
FVDK 10P83Y0	440 mm	120 mm	PNP	cable, 2 m	high sensitivity
FVDK 10P83Y0/KS35A	440 mm	120 mm	PNP	flylead connector M8 4 pin, L=200 mm	high sensitivity

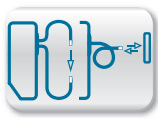

**S<sub>b</sub> = 90 mm**  
**T<sub>w</sub> = 25 mm**



- analog output 1 ... 5 VDC
- adjustable resolution

**general data**

actual range S <sub>b</sub> (FSE 200C1002)	90 mm
sensing distance T <sub>w</sub> (FUE 200C1003)	25 mm
light source	pulsed red LED
alignment / soiled lens indicator	LED red
output indicator	LED green
adjustment	potentiometer
resolution	0,3 ... 6 % (Full Scale)
wave length	680 nm

**electrical data**

response time / release time	1 ... 50 ms (adjustable)
voltage supply range +Vs	10,8 ... 26,4 VDC
current consumption max. (no load)	40 mA
output circuit	analog 1 ... 5 VDC
load resistance	> 10 kOhm
short circuit protection	yes
reverse polarity protection	yes

**mechanical data**

width / diameter	10 mm
height / length	29,7 mm
depth	60 mm
type	rectangular
housing material	polycarbonate/ABS
connection types	cable, 2 m

**ambient conditions**

operating temperature	-20 ... +60 °C
protection class	IP 40

**order reference**

**FWDK 10U84Y0**

**dimension drawing**

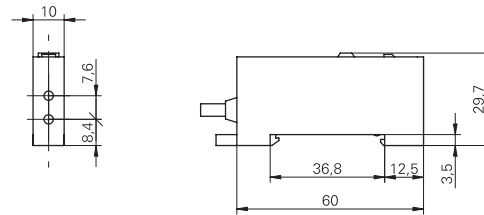

**connection diagram**

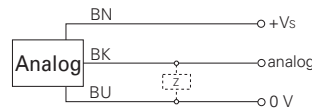

FWDK 84 S<sub>b</sub> = 90 mm, T<sub>w</sub> = 25 mm

Plastic fiber optic sensors



Tw = 1 ... 60 mm



- with thread
- coaxial

general data	
particular characteristics	coaxial
type	Diffuse sensors
sensing distance Tw	1 ... 60 mm
response time / release time	0,05 ... 5 ms
type of head (fiber optic cable)	cylindrical threaded (axial)
width / diameter (head)	3 mm
height / length (head)	23 mm
material (head)	stainless steel
bending radius	15 mm
cable jacket diameter	1,6 mm
material cable jacket	PE
material (fiber optic cable)	plastic
length (fiber optic cable)	500 mm
operating temperature	-30 ... +70 °C

Sensing distance/response time:  
For the definitive sensing distance/response time please see table below "fitting fiber optic sensors".

dimension drawing

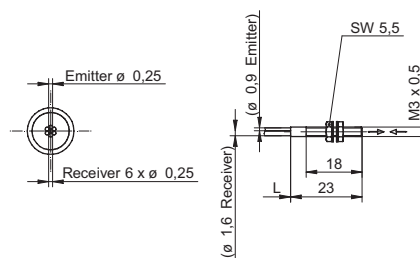

Accessories

10114652	Cutting tool for plastic fiber optics
10140260	Reduction tube
10134544	Focusing lens M3 ø 0,1 mm
10134543	Focusing lens M3 ø 0,4 m
10134542	Focusing lens M3 ø 2 mm

for details: see accessories section

fitting fiber optic sensors	sensing distance Tw (0,05 ms)	sensing distance Tw (0,25 ms)	sensing distance Tw (1 ms)	sensing distance Tw (5 ms)
FVDK 67 (standard version)	1 ... 9 mm (HS)	-	1 ... 45 mm (nL)	1 ... 60 mm (HP)
FVDK 67 (2 adjustable outputs)	1 ... 9 mm (HS)	-	1 ... 45 mm (nL)	1 ... 60 mm (HP)
FVDK 67 (master/slave)	1 ... 9 mm (HS)	-	1 ... 45 mm (nL)	1 ... 60 mm (HP)
FVDK 66 (standard version)	-	1 ... 15 mm (FT)	1 ... 25 mm (nL)	-
FVDK 66 (master/slave)	-	1 ... 15 mm (FT)	1 ... 25 mm (nL)	-
FVDK 22	-	-	1 ... 20 mm (nL)	-
FVDK 12	-	-	1 ... 20 mm (nL)	-
FVDK 12 (fast version)	1 ... 19 mm (HS)	-	-	-
FVDK 10	-	-	1 ... 10 mm (nL)	-
FWDK 84 (analog output)	-	-	1 ... 5 mm (nL)	-

operating modes  
 HS High Speed  
 FT fast  
 nL Standard  
 HP High Sensitivity

order reference
FCE 050C1Y10

FCE 050C1Y10 Tw = 1 ... 60 mm

Plastic fiber optics / Diffuse sensors



Tw = 1 ... 400 mm



- with thread
- coaxial

**general data**

particular characteristics	coaxial
type	Diffuse sensors
sensing distance Tw	1 ... 400 mm
response time / release time	0,05 ... 5 ms
type of head (fiber optic cable)	cylindrical threaded (axial)
width / diameter (head)	6 mm
height / length (head)	20 mm
material (head)	stainless steel
bending radius	20 mm
cable jacket diameter	2,2 mm
material cable jacket	PE
material (fiber optic cable)	plastic
length (fiber optic cable)	2000 mm
operating temperature	-30 ... +70 °C

**dimension drawing**

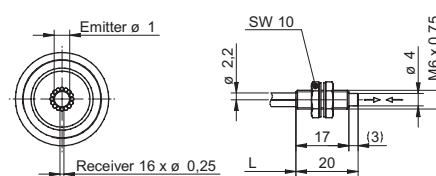

**Accessories**

10114652	Cutting tool for plastic fiber optics
10156738	Fiber optic cable extension 2 m
10158142	Fiber optic cable extension 5 m
10145523	Fiber optic cable extension 5 m hochflexibel

for details: see accessories section

Sensing distance/response time:  
For the definitive sensing distance/response time please see table below "fitting fiber optic sensors".

fitting fiber optic sensors	sensing distance Tw (0,05 ms)	sensing distance Tw (0,25 ms)	sensing distance Tw (1 ms)	sensing distance Tw (5 ms)
FVDK 67 (standard version)	1 ... 65 mm (HS)	-	1 ... 300 mm (nL)	1 ... 400 mm (HP)
FVDK 67 (2 adjustable outputs)	1 ... 65 mm (HS)	-	1 ... 300 mm (nL)	1 ... 400 mm (HP)
FVDK 67 (master/slave)	1 ... 65 mm (HS)	-	1 ... 300 mm (nL)	1 ... 400 mm (HP)
FVDK 66 (standard version)	-	1 ... 90 mm (FT)	1 ... 150 mm (nL)	-
FVDK 66 (master/slave)	-	1 ... 90 mm (FT)	1 ... 150 mm (nL)	-
FVDK 22	-	-	1 ... 90 mm (nL)	-
FVDK 12	-	-	1 ... 90 mm (nL)	-
FVDK 12 (fast version)	1 ... 85 mm (HS)	-	-	-
FVDK 10	-	-	1 ... 45 mm (nL)	-
FWDK 84 (analog output)	-	-	1 ... 25 mm (nL)	-

operating modes  
HS High Speed  
FT fast  
nL Standard  
HP High Sensitivity

**order reference**

FCE 200C1Y00

FCE 200C1Y00 Tw = 1 ... 400 mm

Plastic fiber optics / Diffuse sensors



Tw = 1 ... 110 mm



- with thread
- coaxial

general data	
particular characteristics	coaxial
type	Diffuse sensors
sensing distance Tw	1 ... 110 mm
response time / release time	0,05 ... 5 ms
type of head (fiber optic cable)	cylindrical threaded (axial)
width / diameter (head)	4 mm
height / length (head)	16 mm
material (head)	stainless steel
bending radius	15 mm
cable jacket diameter	1,25 mm
material cable jacket	PE
material (fiber optic cable)	plastic
length (fiber optic cable)	2000 mm
operating temperature	-30 ... +70 °C

**dimension drawing**

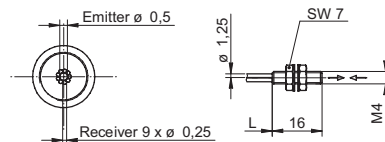

**Accessories**

10114652	Cutting tool for plastic fiber optics
10140260	Reduction tube
for details: see accessories section	

Sensing distance/response time:  
For the definitive sensing distance/response time please see table below "fitting fiber optic sensors".

fitting fiber optic sensors	sensing distance Tw (0,05 ms)	sensing distance Tw (0,25 ms)	sensing distance Tw (1 ms)	sensing distance Tw (5 ms)
FVDK 67 (standard version)	1 ... 12 mm (HS)	-	1 ... 80 mm (nL)	1 ... 110 mm (HP)
FVDK 67 (2 adjustable outputs)	1 ... 12 mm (HS)	-	1 ... 80 mm (nL)	1 ... 110 mm (HP)
FVDK 67 (master/slave)	1 ... 12 mm (HS)	-	1 ... 80 mm (nL)	1 ... 110 mm (HP)
FVDK 66 (standard version)	-	1 ... 20 mm (FT)	1 ... 35 mm (nL)	-
FVDK 66 (master/slave)	-	1 ... 20 mm (FT)	1 ... 35 mm (nL)	-
FVDK 22	-	-	1 ... 8 mm (nL)	-
FVDK 12	-	-	1 ... 8 mm (nL)	-
FVDK 12 (fast version)	1 ... 7 mm (HS)	-	-	-
FVDK 10	-	-	1 ... 16 mm (nL)	-
FWDK 84 (analog output)	-	-	1 ... 25 mm (nL)	-

operating modes  
 HS High Speed  
 FT fast  
 nL Standard  
 HP High Sensitivity

order reference
FCE 200C1Y01



Tw = 1 ... 86 mm



- with thread
- coaxial

**general data**

particular characteristics	coaxial
type	Diffuse sensors
sensing distance Tw	1 ... 86 mm
response time / release time	0,05 ... 5 ms
type of head (fiber optic cable)	cylindrical threaded (axial)
width / diameter (head)	3 mm
height / length (head)	18 mm
material (head)	stainless steel
bending radius	15 mm
cable jacket diameter	1 mm
material cable jacket	PE
material (fiber optic cable)	plastic
length (fiber optic cable)	2000 mm
operating temperature	-30 ... +70 °C

**dimension drawing**

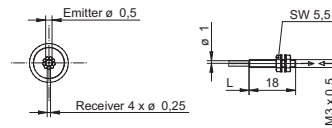

**Accessories**

10114652	Cutting tool for plastic fiber optics
10140260	Reduction tube
10134544	Focusing lens M3 ø 0,1 mm
10134543	Focusing lens M3 ø 0,4 mm
10134542	Focusing lens M3 ø 2 mm

for details: see accessories section

Sensing distance/response time:  
For the definitive sensing distance/response time please see table below "fitting fiber optic sensors".

fitting fiber optic sensors	sensing distance Tw (0,05 ms)	sensing distance Tw (0,25 ms)	sensing distance Tw (1 ms)	sensing distance Tw (5 ms)
FVDK 67 (standard version)	1 ... 14 mm (HS)	-	1 ... 65 mm (nL)	1 ... 86 mm (HP)
FVDK 67 (2 adjustable outputs)	1 ... 14 mm (HS)	-	1 ... 65 mm (nL)	1 ... 86 mm (HP)
FVDK 67 (master/slave)	1 ... 14 mm (HS)	-	1 ... 65 mm (nL)	1 ... 86 mm (HP)
FVDK 66 (standard version)	-	1 ... 21 mm (FT)	1 ... 35 mm (nL)	-
FVDK 66 (master/slave)	-	1 ... 21 mm (FT)	1 ... 35 mm (nL)	-
FVDK 22	-	-	1 ... 20 mm (nL)	-
FVDK 12	-	-	1 ... 20 mm (nL)	-
FVDK 12 (fast version)	1 ... 18 mm (HS)	-	-	-
FVDK 10	-	-	1 ... 10 mm (nL)	-
FWDK 84 (analog output)	-	-	1 ... 5 mm (nL)	-

operating modes  
HS High Speed  
FT fast  
nL Standard  
HP High Sensitivity

**order reference**

FCE 200D1Y00

FCE 200D1Y00 Tw = 1 ... 86 mm

Plastic fiber optics / Diffuse sensors



Tw = 1 ... 95 mm



- with thread
- coaxial

general data	
particular characteristics	coaxial
type	Diffuse sensors
sensing distance Tw	1 ... 95 mm
response time / release time	0,05 ... 5 ms
type of head (fiber optic cable)	cylindrical threaded (axial)
width / diameter (head)	3 mm
height / length (head)	12 mm
material (head)	stainless steel
bending radius	15 mm
cable jacket diameter	1 mm
material cable jacket	PE
material (fiber optic cable)	plastic
length (fiber optic cable)	2000 mm
operating temperature	-30 ... +70 °C

Sensing distance/response time:  
For the definitive sensing distance/response time please see table below "fitting fiber optic sensors".

dimension drawing

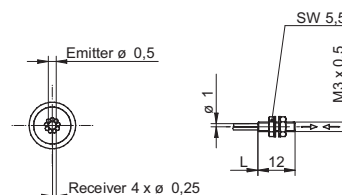

Accessories

10114652	Cutting tool for plastic fiber optics
10140260	Reduction tube
10134544	Focusing lens M3 ø 0,1 mm
10134543	Focusing lens M3 ø 0,4 mm
10134542	Focusing lens M3 ø 2 mm

for details: see accessories section

fitting fiber optic sensors	sensing distance Tw (0,05 ms)	sensing distance Tw (0,25 ms)	sensing distance Tw (1 ms)	sensing distance Tw (5 ms)
FVDK 67 (standard version)	1 ... 8 mm (HS)	-	1 ... 65 mm (nL)	1 ... 95 mm (HP)
FVDK 67 (2 adjustable outputs)	1 ... 8 mm (HS)	-	1 ... 65 mm (nL)	1 ... 95 mm (HP)
FVDK 67 (master/slave)	1 ... 8 mm (HS)	-	1 ... 65 mm (nL)	1 ... 95 mm (HP)
FVDK 66 (standard version)	-	1 ... 16 mm (FT)	1 ... 28 mm (nL)	-
FVDK 66 (master/slave)	-	1 ... 16 mm (FT)	1 ... 28 mm (nL)	-
FVDK 22	-	-	1 ... 20 mm (nL)	-
FVDK 12	-	-	1 ... 20 mm (nL)	-
FVDK 12 (fast version)	1 ... 18 mm (HS)	-	-	-
FVDK 10	-	-	1 ... 10 mm (nL)	-
FWDK 84 (analog output)	-	-	1 ... 5 mm (nL)	-

operating modes  
 HS High Speed  
 FT fast  
 nL Standard  
 HP High Sensitivity

order reference
FCE 200D1Y01



Tw = 1 ... 46 mm



- with thread
- coaxial

**general data**

particular characteristics	ultra flexible coaxial
type	Diffuse sensors
sensing distance Tw	1 ... 46 mm
response time / release time	0,05 ... 5 ms
type of head (fiber optic cable)	cylindrical threaded (axial)
width / diameter (head)	3 mm
height / length (head)	18 mm
material (head)	stainless steel
bending radius	4 mm
cable jacket diameter	1 mm
material cable jacket	PE
material (fiber optic cable)	plastic
length (fiber optic cable)	2000 mm
operating temperature	-30 ... +70 °C

**dimension drawing**

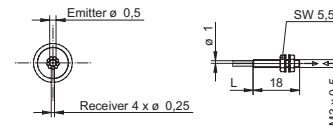

**Accessories**

10114652	Cutting tool for plastic fiber optics
10140260	Reduction tube
10134544	Focusing lens M3 ø 0,1 mm
10134543	Focusing lens M3 ø 0,4 mm
10134542	Focusing lens M3 ø 2 mm

for details: see accessories section

Sensing distance/response time:  
For the definitive sensing distance/response time please see table below "fitting fiber optic sensors".

fitting fiber optic sensors	sensing distance Tw (0,05 ms)	sensing distance Tw (0,25 ms)	sensing distance Tw (1 ms)	sensing distance Tw (5 ms)
FVDK 67 (standard version)	1 ... 7 mm (HS)	-	1 ... 35 mm (nL)	1 ... 46 mm (HP)
FVDK 67 (2 adjustable outputs)	1 ... 7 mm (HS)	-	1 ... 35 mm (nL)	1 ... 46 mm (HP)
FVDK 67 (master/slave)	1 ... 7 mm (HS)	-	1 ... 35 mm (nL)	1 ... 46 mm (HP)
FVDK 66 (standard version)	-	1 ... 10 mm (FT)	1 ... 18 mm (nL)	-
FVDK 66 (master/slave)	-	1 ... 10 mm (FT)	1 ... 18 mm (nL)	-
FVDK 22	-	-	1 ... 18 mm (nL)	-
FVDK 12	-	-	1 ... 18 mm (nL)	-
FVDK 12 (fast version)	1 ... 16 mm (HS)	-	-	-
FVDK 10	-	-	1 ... 8 mm (nL)	-
FWDK 84 (analog output)	-	-	1 ... 4 mm (nL)	-

operating modes  
 HS High Speed  
 FT fast  
 nL Standard  
 HP High Sensitivity

**order reference**

FCE 200E1Y00

FCE 200E1Y00 Tw = 1 ... 46 mm

Plastic fiber optics / Diffuse sensors





Tw = 1 ... 70 mm



- with thread
- coaxial

general data	
particular characteristics	parallel beam
type	Diffuse sensors
sensing distance Tw	1 ... 70 mm
response time / release time	0,05 ... 5 ms
type of head (fiber optic cable)	cylindrical threaded (axial)
width / diameter (head)	5 mm
height / length (head)	31,2 mm
material (head)	stainless steel
bending radius	15 mm
cable jacket diameter	1 mm
material cable jacket	PE
material (fiber optic cable)	plastic
length (fiber optic cable)	2000 mm
operating temperature	-30 ... +70 °C

**dimension drawing**

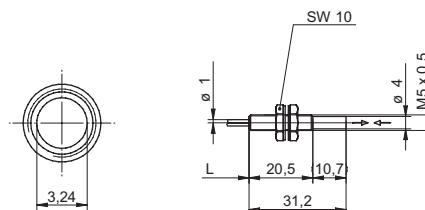

**Accessories**

10114652	Cutting tool for plastic fiber optics
10140260	Reduction tube
for details: see accessories section	

Sensing distance/response time:  
For the definitive sensing distance/response time please see table below "fitting fiber optic sensors".

fitting fiber optic sensors	sensing distance Tw (0,05 ms)	sensing distance Tw (0,25 ms)	sensing distance Tw (1 ms)	sensing distance Tw (5 ms)
FVDK 67 (standard version)	1 ... 8 mm (HS)	-	1 ... 60 mm (nL)	1 ... 70 mm (HP)
FVDK 67 (2 adjustable outputs)	1 ... 8 mm (HS)	-	1 ... 60 mm (nL)	1 ... 70 mm (HP)
FVDK 67 (master/slave)	1 ... 8 mm (HS)	-	1 ... 60 mm (nL)	1 ... 70 mm (HP)
FVDK 66 (standard version)	-	1 ... 16 mm (FT)	1 ... 20 mm (nL)	-
FVDK 66 (master/slave)	-	1 ... 16 mm (FT)	1 ... 20 mm (nL)	-
FVDK 22	-	-	1 ... 20 mm (nL)	-
FVDK 12	-	-	1 ... 20 mm (nL)	-
FVDK 12 (fast version)	1 ... 18 mm (HS)	-	-	-
FVDK 10	-	-	1 ... 10 mm (nL)	-
FWDK 84 (analog output)	-	-	1 ... 5 mm (nL)	-

operating modes  
HS High Speed  
FT fast  
nL Standard  
HP High Sensitivity

order reference
FKE 200D1Y00

FKE 200D1Y00 Tw = 1 ... 70 mm

Plastic fiber optics / Diffuse sensors



Tw = 1 ... 530 mm



- with thread
- long distance

**general data**

particular characteristics	long distance
type	Diffuse sensors
sensing distance Tw	1 ... 530 mm
response time / release time	0,05 ... 5 ms
type of head (fiber optic cable)	cylindrical threaded (axial)
width / diameter (head)	6 mm
height / length (head)	20 mm
material (head)	stainless steel
bending radius	20 mm
cable jacket diameter	2,2 mm
material cable jacket	PE
material (fiber optic cable)	plastic
length (fiber optic cable)	2000 mm
operating temperature	-30 ... +70 °C

**dimension drawing**

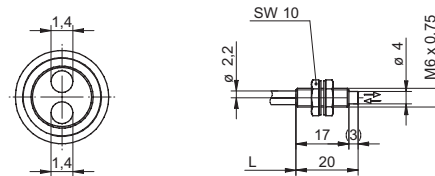

**Accessories**

10114652	Cutting tool for plastic fiber optics
10156738	Fiber optic cable extension 2 m
10158142	Fiber optic cable extension 5 m
10145523	Fiber optic cable extension 5 m hochflexibel

for details: see accessories section

Sensing distance/response time:  
For the definitive sensing distance/response time please see table below "fitting fiber optic sensors".

fitting fiber optic sensors	sensing distance Tw (0,05 ms)	sensing distance Tw (0,25 ms)	sensing distance Tw (1 ms)	sensing distance Tw (5 ms)
FVDK 67 (standard version)	1 ... 85 mm (HS)	-	1 ... 400 mm (nL)	1 ... 530 mm (HP)
FVDK 67 (2 adjustable outputs)	1 ... 85 mm (HS)	-	1 ... 400 mm (nL)	1 ... 530 mm (HP)
FVDK 67 (master/slave)	1 ... 85 mm (HS)	-	1 ... 400 mm (nL)	1 ... 530 mm (HP)
FVDK 66 (standard version)	-	1 ... 120 mm (FT)	1 ... 210 mm (nL)	-
FVDK 66 (master/slave)	-	1 ... 120 mm (FT)	1 ... 210 mm (nL)	-
FVDK 22	-	-	1 ... 160 mm (nL)	-
FVDK 12	-	-	1 ... 160 mm (nL)	-
FVDK 12 (fast version)	1 ... 150 mm (HS)	-	-	-
FVDK 10	-	-	1 ... 70 mm (nL)	-
FWDK 84 (analog output)	-	-	1 ... 45 mm (nL)	-

operating modes  
HS High Speed  
FT fast  
nL Standard  
HP High Sensitivity

**order reference**

FLE 200C1Y00

FLE 200C1Y00 Tw = 1 ... 530 mm Plastic fiber optics / Diffuse sensors



Tw = 1 ... 200 mm



- with thread
- long distance

general data	
particular characteristics	long distance
type	Diffuse sensors
sensing distance Tw	1 ... 200 mm
response time / release time	0,05 ... 5 ms
type of head (fiber optic cable)	cylindrical threaded (axial)
width / diameter (head)	4 mm
height / length (head)	15 mm
material (head)	stainless steel
bending radius	15 mm
cable jacket diameter	1 mm
material cable jacket	PE
material (fiber optic cable)	plastic
length (fiber optic cable)	2000 mm
operating temperature	-30 ... +70 °C

dimension drawing

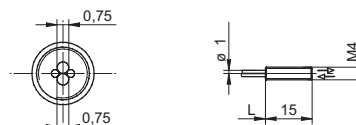

Accessories

10114652	Cutting tool for plastic fiber optics
10140260	Reduction tube
for details: see accessories section	

Sensing distance/response time:  
For the definitive sensing distance/response time please see table below "fitting fiber optic sensors".

fitting fiber optic sensors	sensing distance Tw (0,05 ms)	sensing distance Tw (0,25 ms)	sensing distance Tw (1 ms)	sensing distance Tw (5 ms)
FVDK 67 (standard version)	1 ... 32 mm (HS)	-	1 ... 150 mm (nL)	1 ... 200 mm (HP)
FVDK 67 (2 adjustable outputs)	1 ... 32 mm (HS)	-	1 ... 150 mm (nL)	1 ... 200 mm (HP)
FVDK 67 (master/slave)	1 ... 32 mm (HS)	-	1 ... 150 mm (nL)	1 ... 200 mm (HP)
FVDK 66 (standard version)	-	1 ... 46 mm (FT)	1 ... 75 mm (nL)	-
FVDK 66 (master/slave)	-	1 ... 46 mm (FT)	1 ... 75 mm (nL)	-
FVDK 22	-	-	1 ... 70 mm (nL)	-
FVDK 12	-	-	1 ... 70 mm (nL)	-
FVDK 12 (fast version)	1 ... 66 mm (HS)	-	-	-
FVDK 10	-	-	1 ... 40 mm (nL)	-
FWDK 84 (analog output)	-	-	1 ... 18 mm (nL)	-

operating modes  
 HS High Speed  
 FT fast  
 nL Standard  
 HP High Sensitivity

order reference
FLE 200D1Y00



- leakage monitoring



**general data**

type	Diffuse sensors (Leakage sensor)
measurement type	contact with medium
response time / release time	0,05 ... 5 ms
type of head (fiber optic cable)	cylindrical smooth (axial)
width / diameter (head)	13 mm
height / length (head)	30,9 mm
depth (head)	9,9 mm
material (head)	PFA
bending radius	20 mm
cable jacket diameter	2,2 mm
material cable jacket	PFA (chemically resistant)
material (fiber optic cable)	plastic
length (fiber optic cable)	5000 mm
operating temperature	-30 ... +70 °C

Sensing distance/response time:  
 For the definitive sensing distance/response time please see table below "fitting fiber optic sensors".

**fitting fiber optic sensors**

FVDK 67 (standard version)
FVDK 67 (2 adjustable outputs)
FVDK 67 (master/slave)
FVDK 66 (standard version)
FVDK 66 (master/slave)
FVDK 22
FVDK 12
FVDK 12 (fast version)
FVDK 10

operating modes  
 HS High Speed  
 FT fast  
 nL Standard  
 HP High Sensitivity

**order reference**

**FOC 500C6Y00**

**dimension drawing**

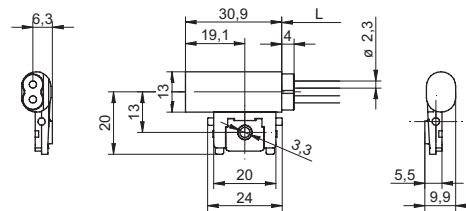

**Accessories**

10114652	Cutting tool for plastic fiber optics
10156738	Fiber optic cable extension 2 m
10158142	Fiber optic cable extension 5 m
10145523	Fiber optic cable extension 5 m hochflexibel

for details: see accessories section



Tw = 1 ... 200 mm



- Heat resistant
- with thread

general data	
particular characteristics	heat resistant
type	Diffuse sensors
sensing distance Tw	1 ... 200 mm
response time / release time	0,05 ... 5 ms
type of head (fiber optic cable)	cylindrical threaded (axial)
width / diameter (head)	6 mm
height / length (head)	20 mm
material (head)	stainless steel
bending radius	25 mm
cable jacket diameter	2,2 mm
material cable jacket	PE
material (fiber optic cable)	plastic
length (fiber optic cable)	2000 mm
operating temperature	-30 ... +105 °C

Sensing distance/response time:  
For the definitive sensing distance/response time please see table below "fitting fiber optic sensors".

dimension drawing

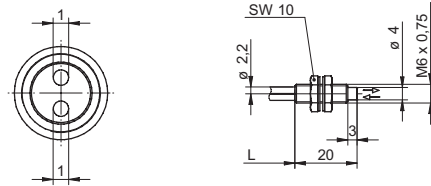

Accessories

10114652	Cutting tool for plastic fiber optics
10156738	Fiber optic cable extension 2 m
10158142	Fiber optic cable extension 5 m
10145523	Fiber optic cable extension 5 m hochflexibel

for details: see accessories section

fitting fiber optic sensors	sensing distance Tw (0,05 ms)	sensing distance Tw (0,25 ms)	sensing distance Tw (1 ms)	sensing distance Tw (5 ms)
FVDK 67 (standard version)	1 ... 43 mm (HS)	-	1 ... 190 mm (nL)	1 ... 200 mm (HP)
FVDK 67 (2 adjustable outputs)	1 ... 43 mm (HS)	-	1 ... 190 mm (nL)	1 ... 200 mm (HP)
FVDK 67 (master/slave)	1 ... 43 mm (HS)	-	1 ... 190 mm (nL)	1 ... 200 mm (HP)
FVDK 66 (standard version)	-	1 ... 55 mm (FT)	1 ... 100 mm (nL)	-
FVDK 66 (master/slave)	-	1 ... 55 mm (FT)	1 ... 100 mm (nL)	-
FVDK 22	-	-	1 ... 70 mm (nL)	-
FVDK 12	-	-	1 ... 70 mm (nL)	-
FVDK 12 (fast version)	1 ... 66 mm (HS)	-	-	-
FVDK 10	-	-	1 ... 40 mm (nL)	-
FWDK 84 (analog output)	-	-	1 ... 18 mm (nL)	-

operating modes  
 HS High Speed  
 FT fast  
 nL Standard  
 HP High Sensitivity

order reference
FUA 200C1Y00



Tw = 1 ... 400 mm



- Heat and cold resistant
- with thread

**general data**

particular characteristics	heat resistant
type	Diffuse sensors
sensing distance Tw	1 ... 400 mm
response time / release time	0,05 ... 5 ms
type of head (fiber optic cable)	cylindrical threaded (axial)
width / diameter (head)	6 mm
height / length (head)	17 mm
material (head)	stainless steel
bending radius	35 mm
cable jacket diameter	2,2 mm
material cable jacket	PE
material (fiber optic cable)	plastic
length (fiber optic cable)	2000 mm
operating temperature	-60 ... +150 °C

**dimension drawing**

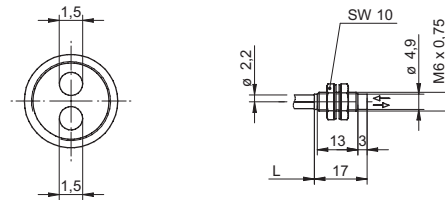

**Accessories**

10114652	Cutting tool for plastic fiber optics
10156738	Fiber optic cable extension 2 m
10158142	Fiber optic cable extension 5 m
10145523	Fiber optic cable extension 5 m hochflexibel

for details: see accessories section

Sensing distance/response time:  
For the definitive sensing distance/response time please see table below "fitting fiber optic sensors".

fitting fiber optic sensors	sensing distance Tw (0,05 ms)	sensing distance Tw (0,25 ms)	sensing distance Tw (1 ms)	sensing distance Tw (5 ms)
FVDK 67 (standard version)	1 ... 65 mm (HS)	-	1 ... 300 mm (nL)	1 ... 400 mm (HP)
FVDK 67 (2 adjustable outputs)	1 ... 65 mm (HS)	-	1 ... 300 mm (nL)	1 ... 400 mm (HP)
FVDK 67 (master/slave)	1 ... 42 mm (HS)	-	1 ... 300 mm (nL)	1 ... 400 mm (HP)
FVDK 66 (standard version)	-	1 ... 90 mm (FT)	1 ... 150 mm (nL)	-
FVDK 66 (master/slave)	-	1 ... 90 mm (FT)	1 ... 150 mm (nL)	-
FVDK 22	-	-	1 ... 110 mm (nL)	-
FVDK 12	-	-	1 ... 110 mm (nL)	-
FVDK 12 (fast version)	1 ... 103 mm (HS)	-	-	-
FVDK 10	-	-	1 ... 45 mm (nL)	-
FWDK 84 (analog output)	-	-	1 ... 28 mm (nL)	-

operating modes  
HS High Speed  
FT fast  
nL Standard  
HP High Sensitivity

**order reference**

FUB 200C1Y00

Plastic fiber optics / Diffuse sensors FUB 200C1Y00 Tw = 1 ... 400 mm



Tw = 1 ... 170 mm



- Chemically resistant
- Smooth sensing head

general data	
particular characteristics	chemically resistant
type	Diffuse sensors
sensing distance Tw	1 ... 170 mm
response time / release time	0,05 ... 5 ms
type of head (fiber optic cable)	cylindrical smooth (axial)
width / diameter (head)	6 mm
height / length (head)	16 mm
material (head)	stainless steel
bending radius	80 mm
cable jacket diameter	2,2 mm
material cable jacket	PFA (chemically resistant)
material (fiber optic cable)	plastic
length (fiber optic cable)	2000 mm
operating temperature	-30 ... +70 °C

Sensing distance/response time:  
For the definitive sensing distance/response time please see table below "fitting fiber optic sensors".

dimension drawing

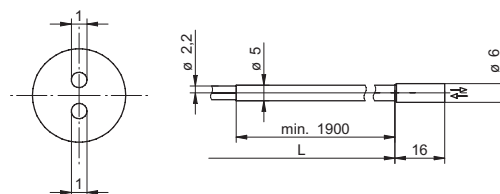

Accessories

10114652	Cutting tool for plastic fiber optics
10156738	Fiber optic cable extension 2 m
10158142	Fiber optic cable extension 5 m
10145523	Fiber optic cable extension 5 m hochflexibel

for details: see accessories section

fitting fiber optic sensors	sensing distance Tw (0,05 ms)	sensing distance Tw (0,25 ms)	sensing distance Tw (1 ms)	sensing distance Tw (5 ms)
FVDK 67 (standard version)	1 ... 28 mm (HS)	-	1 ... 130 mm (nL)	1 ... 170 mm (HP)
FVDK 67 (2 adjustable outputs)	1 ... 28 mm (HS)	-	1 ... 130 mm (nL)	1 ... 170 mm (HP)
FVDK 67 (master/slave)	1 ... 28 mm (HS)	-	1 ... 130 mm (nL)	1 ... 170 mm (HP)
FVDK 66 (standard version)	-	1 ... 42 mm (FT)	1 ... 70 mm (nL)	-
FVDK 66 (master/slave)	-	1 ... 42 mm (FT)	1 ... 70 mm (nL)	-
FVDK 22	-	-	1 ... 50 mm (nL)	-
FVDK 12	-	-	1 ... 50 mm (nL)	-
FVDK 12 (fast version)	1 ... 47 mm (HS)	-	-	-
FVDK 10	-	-	1 ... 35 mm (nL)	-
FWDK 84 (analog output)	-	-	1 ... 12 mm (nL)	-

operating modes  
 HS High Speed  
 FT fast  
 nL Standard  
 HP High Sensitivity

order reference
FUC 200C2Y00



Tw = 1 ... 300 mm



- with thread

**general data**

particular characteristics	standard
type	Diffuse sensors
sensing distance Tw	1 ... 300 mm
response time / release time	0,05 ... 5 ms
type of head (fiber optic cable)	cylindrical threaded (axial)
width / diameter (head)	6 mm
height / length (head)	24 mm
material (head)	brass
bending radius	15 mm
cable jacket diameter	2,2 mm
material cable jacket	PE
material (fiber optic cable)	plastic
length (fiber optic cable)	2000 mm
operating temperature	-30 ... +70 °C

**dimension drawing**

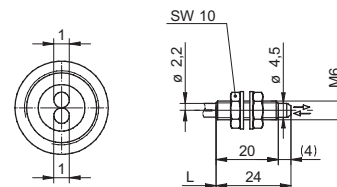

**Accessories**

10114652	Cutting tool for plastic fiber optics
10156738	Fiber optic cable extension 2 m
10158142	Fiber optic cable extension 5 m
10145523	Fiber optic cable extension 5 m hochflexibel

for details: see accessories section

Sensing distance/response time:  
For the definitive sensing distance/response time please see table below "fitting fiber optic sensors".

fitting fiber optic sensors	sensing distance Tw (0,05 ms)	sensing distance Tw (0,25 ms)	sensing distance Tw (1 ms)	sensing distance Tw (5 ms)
FVDK 67 (standard version)	1 ... 33 mm (HS)	-	1 ... 260 mm (nL)	1 ... 300 mm (HP)
FVDK 67 (2 adjustable outputs)	1 ... 33 mm (HS)	-	1 ... 260 mm (nL)	1 ... 300 mm (HP)
FVDK 67 (master/slave)	1 ... 33 mm (HS)	-	1 ... 260 mm (nL)	1 ... 300 mm (HP)
FVDK 66 (standard version)	-	1 ... 65 mm (FT)	1 ... 110 mm (nL)	-
FVDK 66 (master/slave)	-	1 ... 65 mm (FT)	1 ... 110 mm (nL)	-
FVDK 22	-	-	1 ... 90 mm (nL)	-
FVDK 12	-	-	1 ... 90 mm (nL)	-
FVDK 12 (fast version)	1 ... 84 mm (HS)	-	-	-
FVDK 10	-	-	1 ... 45 mm (nL)	-
FWDK 84 (analog output)	-	-	1 ... 25 mm (nL)	-

operating modes  
HS High Speed  
FT fast  
nL Standard  
HP High Sensitivity

**order reference**

FUE 200C1003

Plastic fiber optics / Diffuse sensors FUE 200C1003 Tw = 1 ... 300 mm





Tw = 1 ... 120 mm



- with thread

general data	
particular characteristics	standard
type	Diffuse sensors
sensing distance Tw	1 ... 120 mm
response time / release time	0,05 ... 5 ms
type of head (fiber optic cable)	cylindrical threaded (axial)
width / diameter (head)	4 mm
height / length (head)	20 mm
material (head)	brass
bending radius	8 mm
cable jacket diameter	1 mm
material cable jacket	PE
material (fiber optic cable)	plastic
length (fiber optic cable)	2000 mm
operating temperature	-30 ... +70 °C

dimension drawing

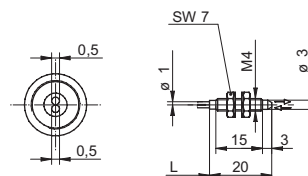

Accessories

10114652	Cutting tool for plastic fiber optics
10140260	Reduction tube
for details: see accessories section	

Sensing distance/response time:  
For the definitive sensing distance/response time please see table below "fitting fiber optic sensors".

fitting fiber optic sensors	sensing distance Tw (0,05 ms)	sensing distance Tw (0,25 ms)	sensing distance Tw (1 ms)	sensing distance Tw (5 ms)
FVDK 67 (standard version)	1 ... 12 mm (HS)	-	1 ... 100 mm (nL)	1 ... 120 mm (HP)
FVDK 67 (2 adjustable outputs)	1 ... 12 mm (HS)	-	1 ... 100 mm (nL)	1 ... 120 mm (HP)
FVDK 67 (master/slave)	1 ... 12 mm (HS)	-	1 ... 100 mm (nL)	1 ... 120 mm (HP)
FVDK 66 (standard version)	-	1 ... 26 mm (FT)	1 ... 45 mm (nL)	-
FVDK 66 (master/slave)	-	1 ... 26 mm (FT)	1 ... 45 mm (nL)	-
FVDK 22	-	-	1 ... 35 mm (nL)	-
FVDK 12	-	-	1 ... 35 mm (nL)	-
FVDK 12 (fast version)	1 ... 33 mm (HS)	-	-	-
FVDK 10	-	-	1 ... 18 mm (nL)	-
FWDK 84 (analog output)	-	-	1 ... 10 mm (nL)	-

operating modes  
HS High Speed  
FT fast  
nL Standard  
HP High Sensitivity

order reference
FUE 200C1004



Tw = 1 ... 120 mm



- with thread
- small sensing head

**general data**

particular characteristics	small sensing head sensing head can be bent once
type	Diffuse sensors
sensing distance Tw	1 ... 120 mm
response time / release time	0,05 ... 5 ms
type of head (fiber optic cable)	cylindrical threaded (axial)
width / diameter (head)	4 mm
height / length (head)	60,2 mm
material (head)	stainless steel / brass
bending radius	8 mm
cable jacket diameter	1,1 mm
material cable jacket	PE
material (fiber optic cable)	plastic
length (fiber optic cable)	2000 mm
operating temperature	-30 ... +70 °C

**dimension drawing**

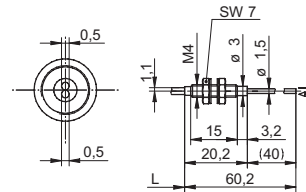

**Accessories**

10114652	Cutting tool for plastic fiber optics
10140260	Reduction tube
for details: see accessories section	

Sensing distance/response time:  
For the definitive sensing distance/response time please see table below "fitting fiber optic sensors".

fitting fiber optic sensors	sensing distance Tw (0,05 ms)	sensing distance Tw (0,25 ms)	sensing distance Tw (1 ms)	sensing distance Tw (5 ms)
FVDK 67 (standard version)	1 ... 12 mm (HS)	-	1 ... 100 mm (nL)	1 ... 120 mm (HP)
FVDK 67 (2 adjustable outputs)	1 ... 12 mm (HS)	-	1 ... 100 mm (nL)	1 ... 120 mm (HP)
FVDK 67 (master/slave)	1 ... 12 mm (HS)	-	1 ... 100 mm (nL)	1 ... 120 mm (HP)
FVDK 66 (standard version)	-	1 ... 26 mm (FT)	1 ... 45 mm (nL)	-
FVDK 66 (master/slave)	-	1 ... 26 mm (FT)	1 ... 45 mm (nL)	-
FVDK 22	-	-	1 ... 35 mm (nL)	-
FVDK 12	-	-	1 ... 35 mm (nL)	-
FVDK 12 (fast version)	1 ... 33 mm (HS)	-	-	-
FVDK 10	-	-	1 ... 18 mm (nL)	-
FWDK 84 (analog output)	-	-	1 ... 10 mm (nL)	-

operating modes  
 HS High Speed  
 FT fast  
 nL Standard  
 HP High Sensitivity

**order reference**

FUE 200C1012

FUE 200C1012 Tw = 1 ... 120 mm

Plastic fiber optics / Diffuse sensors



Tw = 1 ... 105 mm



- with thread

general data	
particular characteristics	standard
type	Diffuse sensors
sensing distance Tw	1 ... 105 mm
response time / release time	0,05 ... 5 ms
type of head (fiber optic cable)	cylindrical threaded (axial)
width / diameter (head)	3 mm
height / length (head)	11 mm
material (head)	stainless steel
bending radius	15 mm
cable jacket diameter	1 mm
material cable jacket	PE
material (fiber optic cable)	plastic
length (fiber optic cable)	2000 mm
operating temperature	-30 ... +70 °C

**dimension drawing**

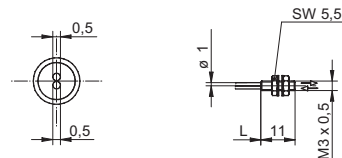

**Accessories**

10114652	Cutting tool for plastic fiber optics
10140260	Reduction tube
for details: see accessories section	

Sensing distance/response time:  
For the definitive sensing distance/response time please see table below "fitting fiber optic sensors".

fitting fiber optic sensors	sensing distance Tw (0,05 ms)	sensing distance Tw (0,25 ms)	sensing distance Tw (1 ms)	sensing distance Tw (5 ms)
FVDK 67 (standard version)	1 ... 12 mm (HS)	-	1 ... 80 mm (nL)	1 ... 105 mm (HP)
FVDK 67 (2 adjustable outputs)	1 ... 12 mm (HS)	-	1 ... 80 mm (nL)	1 ... 105 mm (HP)
FVDK 67 (master/slave)	1 ... 12 mm (HS)	-	1 ... 80 mm (nL)	1 ... 105 mm (HP)
FVDK 66 (standard version)	-	1 ... 25 mm (FT)	1 ... 43 mm (nL)	-
FVDK 66 (master/slave)	-	1 ... 25 mm (FT)	1 ... 43 mm (nL)	-
FVDK 22	-	-	1 ... 35 mm (nL)	-
FVDK 12	-	-	1 ... 35 mm (nL)	-
FVDK 12 (fast version)	1 ... 33 mm (HS)	-	-	-
FVDK 10	-	-	1 ... 18 mm (nL)	-
FWDK 84 (analog output)	-	-	1 ... 10 mm (nL)	-

operating modes  
HS High Speed  
FT fast  
nL Standard  
HP High Sensitivity

order reference
FUE 200D1Y00



Tw = 1 ... 20 mm



- Smooth sensing head

**general data**

particular characteristics	small sensing head
type	Diffuse sensors
sensing distance Tw	1 ... 20 mm
response time / release time	0,05 ... 5 ms
type of head (fiber optic cable)	cylindrical smooth (axial)
width / diameter (head)	3 mm
height / length (head)	30 mm
material (head)	stainless steel
bending radius	15 mm
cable jacket diameter	1 mm
material cable jacket	PE
material (fiber optic cable)	plastic
length (fiber optic cable)	500 mm
operating temperature	-30 ... +70 °C

**dimension drawing**

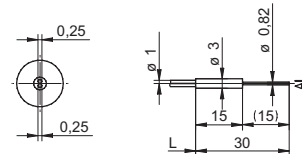

**Accessories**

10114652	Cutting tool for plastic fiber optics
10140260	Reduction tube
for details: see accessories section	

Sensing distance/response time:  
For the definitive sensing distance/response time please see table below "fitting fiber optic sensors".

fitting fiber optic sensors	sensing distance Tw (0,05 ms)	sensing distance Tw (0,25 ms)	sensing distance Tw (1 ms)	sensing distance Tw (5 ms)
FVDK 67 (standard version)	1 ... 2 mm (HS)	-	1 ... 16 mm (nL)	1 ... 20 mm (HP)
FVDK 67 (2 adjustable outputs)	1 ... 2 mm (HS)	-	1 ... 16 mm (nL)	1 ... 20 mm (HP)
FVDK 67 (master/slave)	1 ... 2 mm (HS)	-	1 ... 16 mm (nL)	1 ... 20 mm (HP)
FVDK 66 (standard version)	-	1 ... 2 mm (FT)	1 ... 4 mm (nL)	-
FVDK 66 (master/slave)	-	1 ... 2 mm (FT)	1 ... 4 mm (nL)	-
FVDK 22	-	-	1 ... 8 mm (nL)	-
FVDK 12	-	-	1 ... 8 mm (nL)	-
FVDK 12 (fast version)	1 ... 7 mm (HS)	-	-	-
FVDK 10	-	-	1 ... 3 mm (nL)	-
FWDK 84 (analog output)	-	-	1 ... 2 mm (nL)	-

operating modes  
HS High Speed  
FT fast  
nL Standard  
HP High Sensitivity

**order reference**

FUE 050C2Y10

FUE 050C2Y10 Tw = 1 ... 20 mm

Plastic fiber optics / Diffuse sensors



Tw = 1 ... 300 mm



- Smooth sensing head

general data	
particular characteristics	standard smooth sensing head without thread
type	Diffuse sensors
sensing distance Tw	1 ... 300 mm
response time / release time	0,05 ... 5 ms
type of head (fiber optic cable)	cylindrical smooth (axial)
width / diameter (head)	6 mm
height / length (head)	24 mm
material (head)	aluminum
bending radius	15 mm
cable jacket diameter	2,2 mm
material cable jacket	PE
material (fiber optic cable)	plastic
length (fiber optic cable)	2000 mm
operating temperature	-30 ... +70 °C

dimension drawing

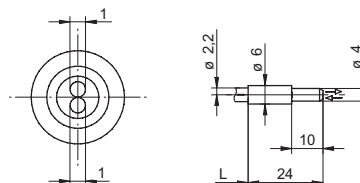

Accessories

10114652	Cutting tool for plastic fiber optics
10156738	Fiber optic cable extension 2 m
10158142	Fiber optic cable extension 5 m
10145523	Fiber optic cable extension 5 m hochflexibel

for details: see accessories section

Sensing distance/response time:  
For the definitive sensing distance/response time please see table below "fitting fiber optic sensors".

fitting fiber optic sensors	sensing distance Tw (0,05 ms)	sensing distance Tw (0,25 ms)	sensing distance Tw (1 ms)	sensing distance Tw (5 ms)
FVDK 67 (standard version)	1 ... 33 mm (HS)	-	1 ... 260 mm (nL)	1 ... 300 mm (HP)
FVDK 67 (2 adjustable outputs)	1 ... 33 mm (HS)	-	1 ... 260 mm (nL)	1 ... 300 mm (HP)
FVDK 67 (master/slave)	1 ... 33 mm (HS)	-	1 ... 260 mm (nL)	1 ... 300 mm (HP)
FVDK 66 (standard version)	-	1 ... 65 mm (FT)	1 ... 110 mm (nL)	-
FVDK 66 (master/slave)	-	1 ... 65 mm (FT)	1 ... 110 mm (nL)	-
FVDK 22	-	-	1 ... 90 mm (nL)	-
FVDK 12	-	-	1 ... 90 mm (nL)	-
FVDK 12 (fast version)	1 ... 84 mm (HS)	-	-	-
FVDK 10	-	-	1 ... 45 mm (nL)	-
FWDK 84 (analog output)	-	-	1 ... 25 mm (nL)	-

operating modes  
 HS High Speed  
 FT fast  
 nL Standard  
 HP High Sensitivity

order reference
FUE 200C2003

FUE 200C2003 Tw = 1 ... 300 mm

Plastic fiber optics / Diffuse sensors



Tw = 1 ... 120 mm



- Smooth sensing head

**general data**

particular characteristics	standard smooth sensing head without thread
type	Diffuse sensors
sensing distance Tw	1 ... 120 mm
response time / release time	0,05 ... 5 ms
type of head (fiber optic cable)	cylindrical smooth (axial)
width / diameter (head)	4 mm
height / length (head)	20 mm
material (head)	aluminum
bending radius	8 mm
cable jacket diameter	2 mm
material cable jacket	PE
material (fiber optic cable)	plastic
length (fiber optic cable)	2000 mm
operating temperature	-30 ... +70 °C

**dimension drawing**

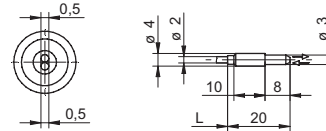

**Accessories**

10114652	Cutting tool for plastic fiber optics
10140260	Reduction tube
for details: see accessories section	

Sensing distance/response time:  
For the definitive sensing distance/response time please see table below "fitting fiber optic sensors".

fitting fiber optic sensors	sensing distance Tw (0,05 ms)	sensing distance Tw (0,25 ms)	sensing distance Tw (1 ms)	sensing distance Tw (5 ms)
FVDK 67 (standard version)	1 ... 12 mm (HS)	-	1 ... 100 mm (nL)	1 ... 120 mm (HP)
FVDK 67 (2 adjustable outputs)	1 ... 12 mm (HS)	-	1 ... 100 mm (nL)	1 ... 120 mm (HP)
FVDK 67 (master/slave)	1 ... 12 mm (HS)	-	1 ... 100 mm (nL)	1 ... 120 mm (HP)
FVDK 66 (standard version)	-	1 ... 26 mm (FT)	1 ... 45 mm (nL)	-
FVDK 66 (master/slave)	-	1 ... 26 mm (FT)	1 ... 45 mm (nL)	-
FVDK 22	-	-	1 ... 35 mm (nL)	-
FVDK 12	-	-	1 ... 35 mm (nL)	-
FVDK 12 (fast version)	1 ... 33 mm (HS)	-	-	-
FVDK 10	-	-	1 ... 18 mm (nL)	-
FWDK 84 (analog output)	-	-	1 ... 10 mm (nL)	-

operating modes  
 HS High Speed  
 FT fast  
 nL Standard  
 HP High Sensitivity

**order reference**

FUE 200C2004

FUE 200C2004 Tw = 1 ... 120 mm

Plastic fiber optics / Diffuse sensors



Tw = 1 ... 86 mm



- Smooth sensing head
- small sensing head

general data	
particular characteristics	small sensing head
type	Diffuse sensors
sensing distance Tw	1 ... 86 mm
response time / release time	0,05 ... 5 ms
type of head (fiber optic cable)	cylindrical smooth (axial)
width / diameter (head)	3 mm
height / length (head)	25 mm
material (head)	stainless steel
bending radius	15 mm
cable jacket diameter	1 mm
material cable jacket	PE
material (fiber optic cable)	plastic
length (fiber optic cable)	2000 mm
operating temperature	-30 ... +70 °C

**dimension drawing**

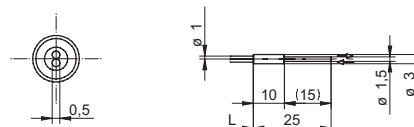

**Accessories**

10114652	Cutting tool for plastic fiber optics
10140260	Reduction tube
for details: see accessories section	

Sensing distance/response time:  
For the definitive sensing distance/response time please see table below "fitting fiber optic sensors".

fitting fiber optic sensors	sensing distance Tw (0,05 ms)	sensing distance Tw (0,25 ms)	sensing distance Tw (1 ms)	sensing distance Tw (5 ms)
FVDK 67 (standard version)	1 ... 14 mm (HS)	-	1 ... 65 mm (nL)	1 ... 86 mm (HP)
FVDK 67 (2 adjustable outputs)	1 ... 14 mm (HS)	-	1 ... 65 mm (nL)	1 ... 86 mm (HP)
FVDK 67 (master/slave)	1 ... 14 mm (HS)	-	1 ... 65 mm (nL)	1 ... 86 mm (HP)
FVDK 66 (standard version)	-	1 ... 21 mm (FT)	1 ... 35 mm (nL)	-
FVDK 66 (master/slave)	-	1 ... 21 mm (FT)	1 ... 35 mm (nL)	-
FVDK 22	-	-	1 ... 35 mm (nL)	-
FVDK 12	-	-	1 ... 35 mm (nL)	-
FVDK 12 (fast version)	1 ... 33 mm (HS)	-	-	-
FVDK 10	-	-	1 ... 18 mm (nL)	-
FWDK 84 (analog output)	-	-	1 ... 9 mm (nL)	-

operating modes  
 HS High Speed  
 FT fast  
 nL Standard  
 HP High Sensitivity

order reference
FUE 200C2Y00



Tw = 1 ... 105 mm



- Smooth sensing head

**general data**

particular characteristics	standard smooth sensing head without thread
type	Diffuse sensors
sensing distance Tw	1 ... 105 mm
response time / release time	0,05 ... 5 ms
type of head (fiber optic cable)	cylindrical smooth (axial)
width / diameter (head)	3 mm
height / length (head)	15 mm
material (head)	stainless steel
bending radius	15 mm
cable jacket diameter	1 mm
material cable jacket	PE
material (fiber optic cable)	plastic
length (fiber optic cable)	2000 mm
operating temperature	-30 ... +70 °C

**dimension drawing**

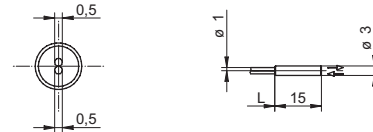

**Accessories**

10114652	Cutting tool for plastic fiber optics
10140260	Reduction tube
for details: see accessories section	

Sensing distance/response time:  
For the definitive sensing distance/response time please see table below "fitting fiber optic sensors".

fitting fiber optic sensors	sensing distance Tw (0,05 ms)	sensing distance Tw (0,25 ms)	sensing distance Tw (1 ms)	sensing distance Tw (5 ms)
FVDK 67 (standard version)	1 ... 17 mm (HS)	-	1 ... 80 mm (nL)	1 ... 105 mm (HP)
FVDK 67 (2 adjustable outputs)	1 ... 17 mm (HS)	-	1 ... 80 mm (nL)	1 ... 105 mm (HP)
FVDK 67 (master/slave)	1 ... 17 mm (HS)	-	1 ... 80 mm (nL)	1 ... 105 mm (HP)
FVDK 66 (standard version)	-	1 ... 25 mm (FT)	1 ... 43 mm (nL)	-
FVDK 66 (master/slave)	-	1 ... 25 mm (FT)	1 ... 43 mm (nL)	-
FVDK 22	-	-	1 ... 35 mm (nL)	-
FVDK 12	-	-	1 ... 35 mm (nL)	-
FVDK 12 (fast version)	1 ... 33 mm (HS)	-	-	-
FVDK 10	-	-	1 ... 18 mm (nL)	-

operating modes  
 HS High Speed  
 FT fast  
 nL Standard  
 HP High Sensitivity

**order reference**

FUE 200D2Y00

Plastic fiber optics / Diffuse sensors Tw = 1 ... 105 mm FUE 200D2Y00





Tw = 1 ... 40 mm



- Smooth sensing head
- side view

general data	
particular characteristics	side view
type	Diffuse sensors
sensing distance Tw	1 ... 40 mm
response time / release time	0,05 ... 5 ms
type of head (fiber optic cable)	cylindrical smooth (radial)
width / diameter (head)	3 mm
height / length (head)	55 mm
material (head)	brass nickel plated
bending radius	4 mm
cable jacket diameter	1 mm
material cable jacket	PE
material (fiber optic cable)	plastic
length (fiber optic cable)	2000 mm
operating temperature	-30 ... +70 °C

dimension drawing

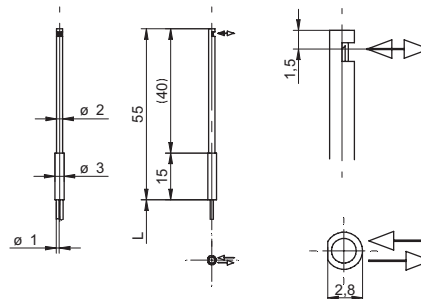

Accessories

10114652	Cutting tool for plastic fiber optics
10140260	Reduction tube
for details: see accessories section	

Sensing distance/response time:  
For the definitive sensing distance/response time please see table below "fitting fiber optic sensors".

fitting fiber optic sensors	sensing distance Tw (0,05 ms)	sensing distance Tw (0,25 ms)	sensing distance Tw (1 ms)	sensing distance Tw (5 ms)
FVDK 67 (standard version)	1 ... 6 mm (HS)	-	1 ... 30 mm (nL)	1 ... 40 mm (HP)
FVDK 67 (2 adjustable outputs)	1 ... 6 mm (HS)	-	1 ... 30 mm (nL)	1 ... 40 mm (HP)
FVDK 67 (master/slave)	1 ... 6 mm (HS)	-	1 ... 30 mm (nL)	1 ... 40 mm (HP)
FVDK 66 (standard version)	-	1 ... 10 mm (FT)	1 ... 17 mm (nL)	-
FVDK 66 (master/slave)	-	1 ... 10 mm (FT)	1 ... 17 mm (nL)	-
FVDK 22	-	-	1 ... 10 mm (nL)	-
FVDK 12	-	-	1 ... 10 mm (nL)	-
FVDK 12 (fast version)	1 ... 9 mm (HS)	-	-	-
FVDK 10	-	-	1 ... 5 mm (nL)	-
FWDK 84 (analog output)	-	-	1 ... 4 mm (nL)	-

operating modes  
 HS High Speed  
 FT fast  
 nL Standard  
 HP High Sensitivity

order reference
FUE 200C4Y00



Tw = 1 ... 265 mm



- Array
- Line length = Number of holes x hole spacing

**general data**

particular characteristics	side view
type	Diffuse sensors
sensing distance Tw	1 ... 265 mm
response time / release time	0,05 ... 5 ms
type of head (fiber optic cable)	rectangular, side view
width / diameter (head)	20,6 mm
height / length (head)	20,6 mm
depth (head)	5 mm
material (head)	stainless steel
bending radius	15 mm
cable jacket diameter	2,2 mm
material cable jacket	PE
material (fiber optic cable)	plastic
length (fiber optic cable)	2000 mm
operating temperature	-30 ... +70 °C

**dimension drawing**

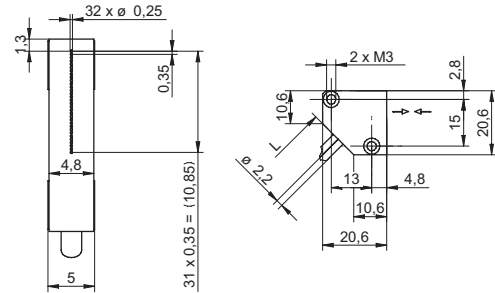

**Accessories**

10114652	Cutting tool for plastic fiber optics
10156738	Fiber optic cable extension 2 m
10158142	Fiber optic cable extension 5 m
10145523	Fiber optic cable extension 5 m hochflexibel

for details: see accessories section

Sensing distance/response time:  
For the definitive sensing distance/response time please see table below "fitting fiber optic sensors".

fitting fiber optic sensors	sensing distance Tw (0,05 ms)	sensing distance Tw (0,25 ms)	sensing distance Tw (1 ms)	sensing distance Tw (5 ms)
FVDK 67 (standard version)	1 ... 43 mm (HS)	-	1 ... 200 mm (nL)	1 ... 265 mm (HP)
FVDK 67 (2 adjustable outputs)	1 ... 43 mm (HS)	-	1 ... 200 mm (nL)	1 ... 265 mm (HP)
FVDK 67 (master/slave)	1 ... 43 mm (HS)	-	1 ... 200 mm (nL)	1 ... 265 mm (HP)
FVDK 66 (standard version)	-	1 ... 60 mm (FT)	1 ... 100 mm (nL)	-
FVDK 66 (master/slave)	-	1 ... 60 mm (FT)	1 ... 100 mm (nL)	-
FVDK 22	-	-	1 ... 80 mm (nL)	-
FVDK 12	-	-	1 ... 80 mm (nL)	-
FVDK 12 (fast version)	1 ... 75 mm (HS)	-	-	-
FVDK 10	-	-	1 ... 45 mm (nL)	-
FWDK 84 (analog output)	-	-	1 ... 20 mm (nL)	-

operating modes  
HS High Speed  
FT fast  
nL Standard  
HP High Sensitivity

**order reference**  
FUE 200C6Y00

FUE 200C6Y00 Tw = 1 ... 265 mm

Plastic fiber optics / Diffuse sensors



Tw = 1 ... 210 mm



- with thread
- ultra flexible

general data	
particular characteristics	ultra flexible
type	Diffuse sensors
sensing distance Tw	1 ... 210 mm
response time / release time	0,05 ... 5 ms
type of head (fiber optic cable)	cylindrical threaded (axial)
width / diameter (head)	6 mm
height / length (head)	20 mm
material (head)	stainless steel
bending radius	2 mm
cable jacket diameter	2,2 mm
material cable jacket	PE
material (fiber optic cable)	plastic
length (fiber optic cable)	2000 mm
operating temperature	-30 ... +70 °C

Sensing distance/response time:  
For the definitive sensing distance/response time please see table below "fitting fiber optic sensors".

dimension drawing

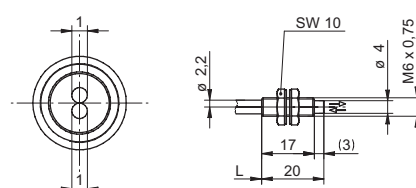

Accessories

10114652	Cutting tool for plastic fiber optics
10156738	Fiber optic cable extension 2 m
10158142	Fiber optic cable extension 5 m
10145523	Fiber optic cable extension 5 m hochflexibel

for details: see accessories section

fitting fiber optic sensors	sensing distance Tw (0,05 ms)	sensing distance Tw (0,25 ms)	sensing distance Tw (1 ms)	sensing distance Tw (5 ms)
FVDK 67 (standard version)	1 ... 34 mm (HS)	-	1 ... 160 mm (nL)	1 ... 210 mm (HP)
FVDK 67 (2 adjustable outputs)	1 ... 34 mm (HS)	-	1 ... 160 mm (nL)	1 ... 210 mm (HP)
FVDK 67 (master/slave)	1 ... 34 mm (HS)	-	1 ... 160 mm (nL)	1 ... 210 mm (HP)
FVDK 66 (standard version)	-	1 ... 50 mm (FT)	1 ... 85 mm (nL)	-
FVDK 66 (master/slave)	-	1 ... 50 mm (FT)	1 ... 85 mm (nL)	-
FVDK 22	-	-	1 ... 80 mm (nL)	-
FVDK 12	-	-	1 ... 60 mm (nL)	-
FVDK 12 (fast version)	1 ... 56 mm (HS)	-	-	-
FVDK 10	-	-	1 ... 38 mm (nL)	-
FWDK 84 (analog output)	-	-	1 ... 16 mm (nL)	-

operating modes  
 HS High Speed  
 FT fast  
 nL Standard  
 HP High Sensitivity

order reference
FUE 200E1Y00



Tw = 1 ... 20 mm



- with thread
- ultra flexible

**general data**

particular characteristics	ultra flexible
type	Diffuse sensors
sensing distance Tw	1 ... 20 mm
response time / release time	0,05 ... 5 ms
type of head (fiber optic cable)	cylindrical threaded (axial)
width / diameter (head)	3 mm
height / length (head)	10 mm
material (head)	stainless steel
bending radius	4 mm
cable jacket diameter	1 mm
material cable jacket	PE
material (fiber optic cable)	plastic
length (fiber optic cable)	2000 mm
operating temperature	-30 ... +70 °C

**dimension drawing**

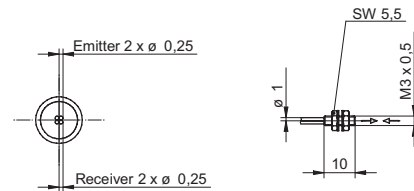

**Accessories**

10114652	Cutting tool for plastic fiber optics
10140260	Reduction tube
for details: see accessories section	

Sensing distance/response time:  
For the definitive sensing distance/response time please see table below "fitting fiber optic sensors".

fitting fiber optic sensors	sensing distance Tw (0,05 ms)	sensing distance Tw (0,25 ms)	sensing distance Tw (1 ms)	sensing distance Tw (5 ms)
FVDK 67 (standard version)	1 ... 3 mm (HS)	-	1 ... 15 mm (nL)	1 ... 20 mm (HP)
FVDK 67 (2 adjustable outputs)	1 ... 3 mm (HS)	-	1 ... 15 mm (nL)	1 ... 20 mm (HP)
FVDK 67 (master/slave)	1 ... 3 mm (HS)	-	1 ... 15 mm (nL)	1 ... 20 mm (HP)
FVDK 66 (standard version)	-	1 ... 5 mm (FT)	1 ... 8 mm (nL)	-
FVDK 66 (master/slave)	-	1 ... 5 mm (FT)	1 ... 8 mm (nL)	-
FVDK 22	-	-	1 ... 18 mm (nL)	-
FVDK 12	-	-	1 ... 15 mm (nL)	-
FVDK 12 (fast version)	1 ... 14 mm (HS)	-	-	-
FVDK 10	-	-	1 ... 6 mm (nL)	-
FWDK 84 (analog output)	-	-	1 ... 2 mm (nL)	-

operating modes  
HS High Speed  
FT fast  
nL Standard  
HP High Sensitivity

**order reference**

FUE 200F1Y00

FUE 200F1Y00 Tw = 1 ... 20 mm

Plastic fiber optics / Diffuse sensors



- Fill level detection
- Smooth sensing head

**general data**

type	Diffuse sensors (liquid level sensor)
measurement type	contact with medium
response time / release time	0,05 ... 5 ms
type of head (fiber optic cable)	cylindrical smooth (axial)
width / diameter (head)	4 mm
height / length (head)	15 mm
material (head)	PFA
bending radius	15 mm
cable jacket diameter	1 mm
material cable jacket	PFA (chemically resistant)
material (fiber optic cable)	plastic
length (fiber optic cable)	2000 mm
operating temperature	-30 ... +105 °C

**dimension drawing**

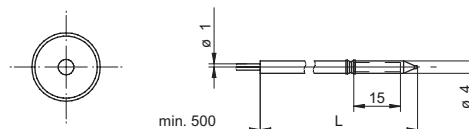

**Accessories**

10114652	Cutting tool for plastic fiber optics
10140260	Reduction tube
for details: see accessories section	

Sensing distance/response time:  
For the definitive sensing distance/response time please see table below "fitting fiber optic sensors".

fitting fiber optic sensors	sensing distance Tw (0,05 ms)	sensing distance Tw (0,25 ms)	sensing distance Tw (1 ms)	sensing distance Tw (5 ms)
FVDK 67 (standard version)	-	-	-	-
FVDK 67 (2 adjustable outputs)	-	-	-	-
FVDK 67 (master/slave)	-	-	-	-
FVDK 66 (standard version)	-	-	-	-
FVDK 66 (master/slave)	-	-	-	-
FVDK 22	-	-	-	-
FVDK 12	-	-	-	-
FVDK 12 (fast version)	-	-	-	-
FVDK 10	-	-	-	-

operating modes  
 HS High Speed  
 FT fast  
 nL Standard  
 HP High Sensitivity

**order reference**

**FUL 200D2Y00**



- Fill level detection
- Smooth sensing head

**general data**

type	Diffuse sensors (liquid level sensor)
measurement type	contact with medium
response time / release time	0,05 ... 5 ms
type of head (fiber optic cable)	cylindrical smooth (axial)
width / diameter (head)	4 mm
height / length (head)	15 mm
material (head)	PFA
bending radius	15 mm
cable jacket diameter	1 mm
material cable jacket	PFA (chemically resistant)
material (fiber optic cable)	plastic
length (fiber optic cable)	5000 mm
operating temperature	-30 ... +105 °C

**dimension drawing**

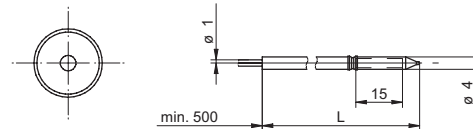

**Accessories**

10114652	Cutting tool for plastic fiber optics
10140260	Reduction tube
for details: see accessories section	

Sensing distance/response time:  
For the definitive sensing distance/response time please see table below "fitting fiber optic sensors".

fitting fiber optic sensors	sensing distance Tw (0,05 ms)	sensing distance Tw (0,25 ms)	sensing distance Tw (1 ms)	sensing distance Tw (5 ms)
FVDK 67 (standard version)	-	-	-	-
FVDK 67 (2 adjustable outputs)	-	-	-	-
FVDK 67 (master/slave)	-	-	-	-
FVDK 66 (standard version)	-	-	-	-
FVDK 66 (master/slave)	-	-	-	-
FVDK 22	-	-	-	-
FVDK 12	-	-	-	-
FVDK 12 (fast version)	-	-	-	-
FVDK 10	-	-	-	-

operating modes  
 HS High Speed  
 FT fast  
 nL Standard  
 HP High Sensitivity

**order reference**

**FUL 500D2Y00**



Sb = 4500 mm



- Chemical and oil proof
- Smooth sensing head

general data	
type	through beam sensor
actual range Sb	4500 mm
response time / release time	0,05 ... 5 ms
type of head (fiber optic cable)	cylindrical smooth (axial)
width / diameter (head)	5 mm
height / length (head)	14,7 mm
material (head)	stainless steel
bending radius	20 mm
cable jacket diameter	2,2 mm
material cable jacket	PFA (chemically resistant)
material (fiber optic cable)	plastic
length (fiber optic cable)	2000 mm
operating temperature	-30 ... +70 °C
exit angle	± 2°

dimension drawing

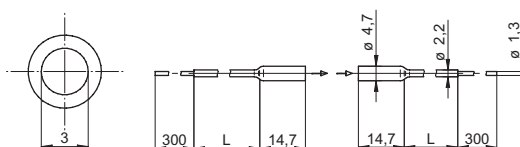

Accessories

10114652	Cutting tool for plastic fiber optics
for details: see accessories section	

Sensing distance/response time:  
For the definitive sensing distance/response time please see table below "fitting fiber optic sensors".

fitting fiber optic sensors	actual range Sb (0,05 ms)	actual range Sb (0,25 ms)	actual range Sb (1 ms)	actual range Sb (5 ms)
FVDK 67 (standard version)	750 mm (HS)	-	3000 mm (nL)	4500 mm (HP)
FVDK 67 (2 adjustable outputs)	750 mm (HS)	-	3000 mm (nL)	4500 mm (HP)
FVDK 67 (master/slave)	750 mm (HS)	-	3000 mm (nL)	4500 mm (HP)
FVDK 66 (standard version)	-	880 mm (FT)	1500 mm (nL)	-
FVDK 66 (master/slave)	-	880 mm (FT)	1500 mm (nL)	-
FVDK 22	-	-	1100 mm (nL)	-
FVDK 12	-	-	1100 mm (nL)	-
FVDK 12 (fast version)	1050 mm (HS)	-	-	-
FVDK 10	-	-	500 mm (nL)	-
FWDK 84 (analog output)	-	-	300 mm (nL)	-

operating modes  
 HS High Speed  
 FT fast  
 nL Standard  
 HP High Sensitivity

order reference
FLC 200D2Y00



Sb = 4140 mm



- with thread
- parallel beam

**general data**

particular characteristics	parallel beam
type	through beam sensor
actual range Sb	4140 mm
response time / release time	0,05 ... 5 ms
type of head (fiber optic cable)	cylindrical threaded (axial)
width / diameter (head)	4 mm
height / length (head)	28 mm
material (head)	stainless steel
bending radius	20 mm
cable jacket diameter	2,2 mm
material cable jacket	PE
material (fiber optic cable)	plastic
length (fiber optic cable)	2000 mm
operating temperature	-30 ... +70 °C
exit angle	± 2°

**dimension drawing**

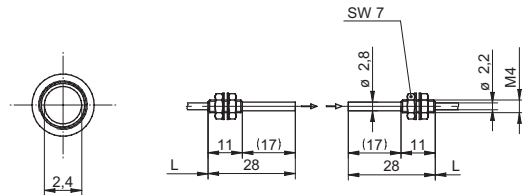

**Accessories**

10114652	Cutting tool for plastic fiber optics
10119911	Mounting bracket Ø 2,2 mm
10156738	Fiber optic cable extension 2 m
10158142	Fiber optic cable extension 5 m
10145523	Fiber optic cable extension 5 m hochflexibel

for details: see accessories section

Sensing distance/response time:  
For the definitive sensing distance/response time please see table below "fitting fiber optic sensors".

fitting fiber optic sensors	actual range Sb (0,05 ms)	actual range Sb (0,25 ms)	actual range Sb (1 ms)	actual range Sb (5 ms)
FVDK 67 (standard version)	690 mm (HS)	-	2760 mm (nL)	4140 mm (HP)
FVDK 67 (2 adjustable outputs)	690 mm (HS)	-	2760 mm (nL)	4140 mm (HP)
FVDK 67 (master/slave)	690 mm (HS)	-	2760 mm (nL)	4140 mm (HP)
FVDK 66 (standard version)	-	840 mm (FT)	1400 mm (nL)	-
FVDK 66 (master/slave)	-	840 mm (FT)	1400 mm (nL)	-
FVDK 22	-	-	1400 mm (nL)	-
FVDK 12	-	-	1400 mm (nL)	-
FVDK 12 (fast version)	1320 mm (HS)	-	-	-
FVDK 10	-	-	600 mm (nL)	-
FWDK 84 (analog output)	-	-	390 mm (nL)	-

operating modes  
HS High Speed  
FT fast  
nL Standard  
HP High Sensitivity

**order reference**  
FPE 200C1Y00

FPE 200C1Y00 Sb = 4140 mm

Plastic fiber optics / Through beam sensors





Sb = 3600 mm



- with thread
- parallel beam

general data	
particular characteristics	parallel beam
type	through beam sensor
actual range Sb	3600 mm
response time / release time	0,05 ... 5 ms
type of head (fiber optic cable)	cylindrical threaded (axial)
width / diameter (head)	4 mm
height / length (head)	28 mm
material (head)	stainless steel
bending radius	15 mm
cable jacket diameter	1 mm
material cable jacket	PE
material (fiber optic cable)	plastic
length (fiber optic cable)	2000 mm
operating temperature	-30 ... +70 °C
exit angle	± 1°

dimension drawing

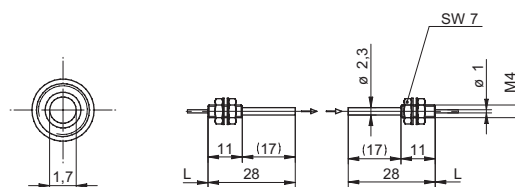

Accessories

10114652	Cutting tool for plastic fiber optics
10119912	Mounting bracket Ø 1,1 mm
10140260	Reduction tube
for details: see accessories section	

Sensing distance/response time:  
For the definitive sensing distance/response time please see table below "fitting fiber optic sensors".

fitting fiber optic sensors	actual range Sb (0,05 ms)	actual range Sb (0,25 ms)	actual range Sb (1 ms)	actual range Sb (5 ms)
FVDK 67 (standard version)	600 mm (HS)	-	2400 mm (nL)	3600 mm (HP)
FVDK 67 (2 adjustable outputs)	600 mm (HS)	-	2400 mm (nL)	3600 mm (HP)
FVDK 67 (master/slave)	600 mm (HS)	-	2400 mm (nL)	3600 mm (HP)
FVDK 66 (standard version)	-	730 mm (FT)	1200 mm (nL)	-
FVDK 66 (master/slave)	-	730 mm (FT)	1200 mm (nL)	-
FVDK 22	-	-	800 mm (nL)	-
FVDK 12	-	-	800 mm (nL)	-
FVDK 12 (fast version)	755 mm (HS)	-	-	-
FVDK 10	-	-	320 mm (nL)	-
FWDK 84 (analog output)	-	-	200 mm (nL)	-

operating modes  
HS High Speed  
FT fast  
nL Standard  
HP High Sensitivity

order reference
FPE 200D1Y00



Sb = 4500 mm



- Smooth sensing head
- parallel beam

**general data**

particular characteristics	parallel beam
type	through beam sensor
actual range Sb	4500 mm
response time / release time	0,05 ... 5 ms
type of head (fiber optic cable)	cylindrical smooth (radial)
width / diameter (head)	4 mm
height / length (head)	30 mm
material (head)	stainless steel
bending radius	30 mm
cable jacket diameter	2,2 mm
material cable jacket	PE
material (fiber optic cable)	plastic
length (fiber optic cable)	2000 mm
operating temperature	-30 ... +70 °C
exit angle	± 2°

**dimension drawing**

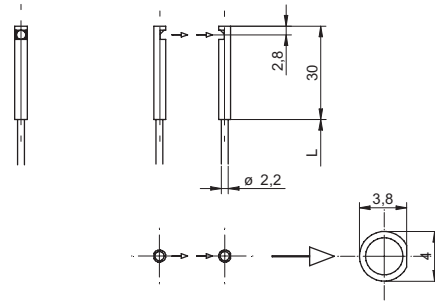

**Accessories**

10114652	Cutting tool for plastic fiber optics
10119911	Mounting bracket Ø 2,2 mm
10156738	Fiber optic cable extension 2 m
10158142	Fiber optic cable extension 5 m
10145523	Fiber optic cable extension 5 m hochflexibel

for details: see accessories section

Sensing distance/response time:  
For the definitive sensing distance/response time please see table below "fitting fiber optic sensors".

fitting fiber optic sensors	actual range Sb (0,05 ms)	actual range Sb (0,25 ms)	actual range Sb (1 ms)	actual range Sb (5 ms)
FVDK 67 (standard version)	750 mm (HS)	-	3000 mm (nL)	4500 mm (HP)
FVDK 67 (2 adjustable outputs)	750 mm (HS)	-	3000 mm (nL)	4500 mm (HP)
FVDK 67 (master/slave)	750 mm (HS)	-	3000 mm (nL)	4500 mm (HP)
FVDK 66 (standard version)	-	920 mm (FT)	1500 mm (nL)	-
FVDK 66 (master/slave)	-	920 mm (FT)	1500 mm (nL)	-
FVDK 22	-	-	1000 mm (nL)	-
FVDK 12	-	-	1000 mm (nL)	-
FVDK 12 (fast version)	945 mm (HS)	-	-	-
FVDK 10	-	-	400 mm (nL)	-
FWDK 84 (analog output)	-	-	200 mm (nL)	-

operating modes  
HS High Speed  
FT fast  
nL Standard  
HP High Sensitivity

**order reference**  
FPE 200C4Y00

FPE 200C4Y00 Sb = 4500 mm

Plastic fiber optics / Through beam sensors



Sb = 690 mm



- Heat resistant
- with thread

general data	
particular characteristics	heat resistant
type	through beam sensor
actual range Sb	690 mm
response time / release time	0,05 ... 5 ms
type of head (fiber optic cable)	cylindrical threaded (axial)
width / diameter (head)	4 mm
height / length (head)	14 mm
material (head)	stainless steel
bending radius	25 mm
cable jacket diameter	2,2 mm
material cable jacket	PE
material (fiber optic cable)	plastic
length (fiber optic cable)	2000 mm
operating temperature	-30 ... +105 °C

Sensing distance/response time:  
For the definitive sensing distance/response time please see table below "fitting fiber optic sensors".

dimension drawing

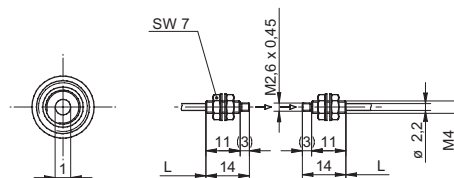

Accessories

10114652	Cutting tool for plastic fiber optics
10119911	Mounting bracket Ø 2,2 mm
10156738	Fiber optic cable extension 2 m
10158142	Fiber optic cable extension 5 m
10145523	Fiber optic cable extension 5 m hochflexibel
10134541	Doubling lens increases the actual range (paires)
10134540	Doubling lens increases the actual range (paires)

for details: see accessories section

fitting fiber optic sensors	actual range Sb (0,05 ms)	actual range Sb (0,25 ms)	actual range Sb (1 ms)	actual range Sb (5 ms)
FVDK 67 (standard version)	115 mm (HS)	-	460 mm (nL)	690 mm (HP)
FVDK 67 (2 adjustable outputs)	115 mm (HS)	-	460 mm (nL)	690 mm (HP)
FVDK 67 (master/slave)	115 mm (HS)	-	60 mm (nL)	690 mm (HP)
FVDK 66 (standard version)	-	140 mm (FT)	240 mm (nL)	-
FVDK 66 (master/slave)	-	140 mm (FT)	240 mm (nL)	-
FVDK 22	-	-	210 mm (nL)	-
FVDK 12	-	-	210 mm (nL)	-
FVDK 12 (fast version)	198 mm (HS)	-	-	-
FVDK 10	-	-	100 mm (nL)	-
FWDK 84 (analog output)	-	-	60 mm (nL)	-

operating modes  
 HS High Speed  
 FT fast  
 nL Standard  
 HP High Sensitivity

order reference
FSA 200C1Y00

FSA 200C1Y00 Sb = 690 mm

Plastic fiber optics / Through beam sensors



Sb = 1200 mm



- Heat resistant
- with thread

**general data**

particular characteristics	heat resistant
type	through beam sensor
actual range Sb	1200 mm
response time / release time	0,05 ... 5 ms
type of head (fiber optic cable)	cylindrical threaded (axial)
width / diameter (head)	4 mm
height / length (head)	17 mm
material (head)	stainless steel
bending radius	35 mm
cable jacket diameter	2,2 mm
material cable jacket	PE
material (fiber optic cable)	plastic
length (fiber optic cable)	2000 mm
operating temperature	-60 ... +150 °C

**dimension drawing**

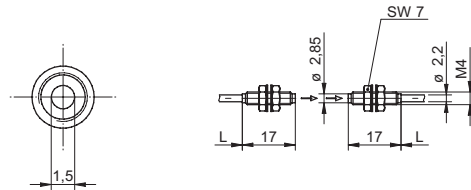

**Accessories**

10114652	Cutting tool for plastic fiber optics
10119911	Mounting bracket Ø 2,2 mm
10156738	Fiber optic cable extension 2 m
10158142	Fiber optic cable extension 5 m
10145523	Fiber optic cable extension 5 m hochflexibel

for details: see accessories section

Sensing distance/response time:  
For the definitive sensing distance/response time please see table below "fitting fiber optic sensors".

fitting fiber optic sensors	actual range Sb (0,05 ms)	actual range Sb (0,25 ms)	actual range Sb (1 ms)	actual range Sb (5 ms)
FVDK 67 (standard version)	200 mm (HS)	-	800 mm (nL)	1200 mm (HP)
FVDK 67 (2 adjustable outputs)	200 mm (HS)	-	800 mm (nL)	1200 mm (HP)
FVDK 67 (master/slave)	200 mm (HS)	-	800 mm (nL)	1200 mm (HP)
FVDK 66 (standard version)	-	240 mm (FT)	410 mm (nL)	-
FVDK 66 (master/slave)	-	240 mm (FT)	10 mm (nL)	-
FVDK 22	-	-	310 mm (nL)	-
FVDK 12	-	-	310 mm (nL)	-
FVDK 12 (fast version)	292 mm (HS)	-	-	-
FVDK 10	-	-	160 mm (nL)	-
FWDK 84 (analog output)	-	-	85 mm (nL)	-

operating modes  
HS High Speed  
FT fast  
nL Standard  
HP High Sensitivity

**order reference**  
FSB 200C1Y00

FSB 200C1Y00 Sb = 1200 mm

Plastic fiber optics / Through beam sensors



Sb = 1030 mm



- side view

general data	
particular characteristics	side view
type	through beam sensor
actual range Sb	1030 mm
response time / release time	0,05 ... 5 ms
type of head (fiber optic cable)	cylindrical smooth (radial)
width / diameter (head)	4,7 mm
height / length (head)	15,8 mm
material (head)	stainless steel
bending radius	20 mm
cable jacket diameter	2,2 mm
material cable jacket	PFA (chemically resistant)
material (fiber optic cable)	plastic
length (fiber optic cable)	2000 mm
operating temperature	-30 ... +70 °C

dimension drawing

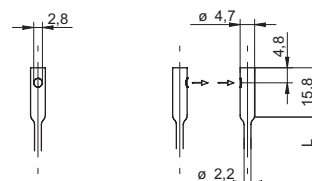

Accessories

10114652	Cutting tool for plastic fiber optics
for details: see accessories section	

Sensing distance/response time:  
For the definitive sensing distance/response time please see table below "fitting fiber optic sensors".

fitting fiber optic sensors	actual range Sb (0,05 ms)	actual range Sb (0,25 ms)	actual range Sb (1 ms)	actual range Sb (5 ms)
FVDK 67 (standard version)	170 mm (HS)	-	690 mm (nL)	1030 mm (HP)
FVDK 67 (2 adjustable outputs)	170 mm (HS)	-	690 mm (nL)	1030 mm (HP)
FVDK 67 (master/slave)	170 mm (HS)	-	690 mm (nL)	1030 mm (HP)
FVDK 66 (standard version)	-	210 mm (FT)	350 mm (nL)	-
FVDK 66 (master/slave)	-	210 mm (FT)	350 mm (nL)	-
FVDK 22	-	-	270 mm (nL)	-
FVDK 12	-	-	270 mm (nL)	-
FVDK 12 (fast version)	254 mm (HS)	-	-	-
FVDK 10	-	-	120 mm (nL)	-
FWDK 84 (analog output)	-	-	75 mm (nL)	-

operating modes  
HS High Speed  
FT fast  
nL Standard  
HP High Sensitivity

order reference
FSC 200C4Y00

FSC 200C4Y00 Sb = 1030 mm

Plastic fiber optics / Through beam sensors



**Sb = 1200 mm**



- with thread

**general data**

particular characteristics	standard
type	through beam sensor
actual range Sb	1200 mm
response time / release time	0,05 ... 5 ms
type of head (fiber optic cable)	cylindrical threaded (axial)
width / diameter (head)	4 mm
height / length (head)	20 mm
material (head)	brass
bending radius	15 mm
cable jacket diameter	2,2 mm
material cable jacket	PE
material (fiber optic cable)	plastic
length (fiber optic cable)	2000 mm
operating temperature	-30 ... +70 °C

**dimension drawing**

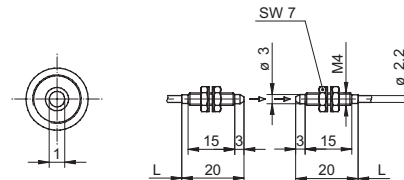

**Accessories**

10114652	Cutting tool for plastic fiber optics
10119911	Mounting bracket Ø 2,2 mm
10156738	Fiber optic cable extension 2 m
10158142	Fiber optic cable extension 5 m
10145523	Fiber optic cable extension 5 m hochflexibel
10119909	Doubling lens M4 increases the actual range (paires)

for details: see accessories section

Sensing distance/response time:  
For the definitive sensing distance/response time please see table below "fitting fiber optic sensors".

fitting fiber optic sensors	actual range Sb (0,05 ms)	actual range Sb (0,25 ms)	actual range Sb (1 ms)	actual range Sb (5 ms)
FVDK 67 (standard version)	130 mm (HS)	-	900 mm (nL)	1200 mm (HP)
FVDK 67 (2 adjustable outputs)	130 mm (HS)	-	900 mm (nL)	1200 mm (HP)
FVDK 67 (master/slave)	130 mm (HS)	-	900 mm (nL)	1200 mm (HP)
FVDK 66 (standard version)	-	220 mm (FT)	390 mm (nL)	-
FVDK 66 (master/slave)	-	220 mm (FT)	390 mm (nL)	-
FVDK 22	-	-	320 mm (nL)	-
FVDK 12	-	-	320 mm (nL)	-
FVDK 12 (fast version)	300 mm (HS)	-	-	-
FVDK 10	-	-	160 mm (nL)	-
FWDK 84 (analog output)	-	-	90 mm (nL)	-

operating modes  
HS High Speed  
FT fast  
nL Standard  
HP High Sensitivity

**order reference**

**FSE 200C1002**

FSE 200C1002 Sb = 1200 mm

Plastic fiber optics / Through beam sensors



Sb = 340 mm



- with thread

general data	
particular characteristics	standard
type	through beam sensor
actual range Sb	340 mm
response time / release time	0,05 ... 5 ms
type of head (fiber optic cable)	cylindrical threaded (axial)
width / diameter (head)	3 mm
height / length (head)	17 mm
material (head)	brass
bending radius	8 mm
cable jacket diameter	1 mm
material cable jacket	PE
material (fiber optic cable)	plastic
length (fiber optic cable)	2000 mm
operating temperature	-30 ... +70 °C

Sensing distance/response time:  
For the definitive sensing distance/response time please see table below "fitting fiber optic sensors".

dimension drawing

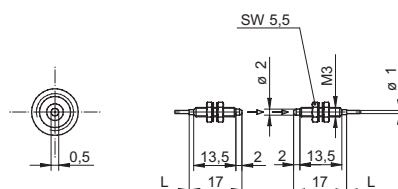

Accessories

10114652	Cutting tool for plastic fiber optics
10119912	Mounting bracket Ø 1,1 mm
10140260	Reduction tube
10119910	Doubling lens M3 increases the actual range (paires)
for details: see accessories section	

fitting fiber optic sensors	actual range Sb (0,05 ms)	actual range Sb (0,25 ms)	actual range Sb (1 ms)	actual range Sb (5 ms)
FVDK 67 (standard version)	40 mm (HS)	-	290 mm (nL)	340 mm (HP)
FVDK 67 (2 adjustable outputs)	40 mm (HS)	-	290 mm (nL)	340 mm (HP)
FVDK 67 (master/slave)	40 mm (HS)	-	290 mm (nL)	340 mm (HP)
FVDK 66 (standard version)	-	70 mm (FT)	125 mm (nL)	-
FVDK 66 (master/slave)	-	70 mm (FT)	125 mm (nL)	-
FVDK 22	-	-	100 mm (nL)	-
FVDK 12	-	-	100 mm (nL)	-
FVDK 12 (fast version)	94 mm (HS)	-	-	-
FVDK 10	-	-	50 mm (nL)	-
FWDK 84 (analog output)	-	-	28 mm (nL)	-

operating modes  
HS High Speed  
FT fast  
nL Standard  
HP High Sensitivity

order reference
FSE 200C1004

FSE 200C1004 Sb = 340 mm

Plastic fiber optics / Through beam sensors



Sb = 340 mm



- with thread
- small sensing head

**general data**

particular characteristics	small sensing head sensing head can be bent once
type	through beam sensor
actual range Sb	340 mm
response time / release time	0,05 ... 5 ms
type of head (fiber optic cable)	cylindrical threaded (axial)
width / diameter (head)	4 mm
height / length (head)	60,2 mm
material (head)	stainless steel / brass
bending radius	8 mm
cable jacket diameter	2,2 mm
material cable jacket	PE
material (fiber optic cable)	plastic
length (fiber optic cable)	2000 mm
operating temperature	-30 ... +70 °C

**dimension drawing**

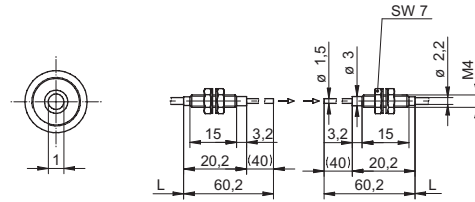

**Accessories**

10114652	Cutting tool for plastic fiber optics
for details: see accessories section	

Sensing distance/response time:  
For the definitive sensing distance/response time please see table below "fitting fiber optic sensors".

fitting fiber optic sensors	actual range Sb (0,05 ms)	actual range Sb (0,25 ms)	actual range Sb (1 ms)	actual range Sb (5 ms)
FVDK 67 (standard version)	40 mm (HS)	-	290 mm (nL)	340 mm (HP)
FVDK 67 (2 adjustable outputs)	40 mm (HS)	-	290 mm (nL)	340 mm (HP)
FVDK 67 (master/slave)	40 mm (HS)	-	290 mm (nL)	340 mm (HP)
FVDK 66 (standard version)	-	70 mm (FT)	125 mm (nL)	-
FVDK 66 (master/slave)	-	70 mm (FT)	125 mm (nL)	-
FVDK 22	-	-	100 mm (nL)	-
FVDK 12	-	-	100 mm (nL)	-
FVDK 12 (fast version)	94 mm (HS)	-	-	-
FVDK 10	-	-	50 mm (nL)	-
FWDK 84 (analog output)	-	-	28 mm (nL)	-

operating modes  
 HS High Speed  
 FT fast  
 nL Standard  
 HP High Sensitivity

**order reference**

FSE 200C1013

FSE 200C1013 Sb = 340 mm

Plastic fiber optics / Through beam sensors





Sb = 1200 mm



- with thread
- small sensing head

**general data**

particular characteristics	standard short sensing head
type	through beam sensor
actual range Sb	1200 mm
response time / release time	0,05 ... 5 ms
type of head (fiber optic cable)	cylindrical threaded (axial)
width / diameter (head)	4 mm
height / length (head)	14 mm
material (head)	stainless steel
bending radius	20 mm
cable jacket diameter	2,2 mm
material cable jacket	PE
material (fiber optic cable)	plastic
length (fiber optic cable)	2000 mm
operating temperature	-30 ... +70 °C

Sensing distance/response time:  
For the definitive sensing distance/response time please see table below "fitting fiber optic sensors".

**dimension drawing**

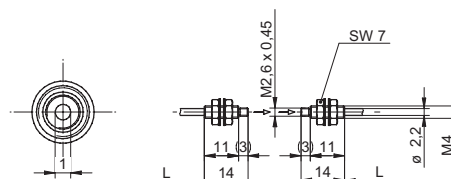

**Accessories**

10114652	Cutting tool for plastic fiber optics
10119911	Mounting bracket Ø 2,2 mm
10156738	Fiber optic cable extension 2 m
10158142	Fiber optic cable extension 5 m
10145523	Fiber optic cable extension 5 m hochflexibel
10134541	Doubling lens increases the actual range (paires)
10134540	Doubling lens increases the actual range (paires)

for details: see accessories section

fitting fiber optic sensors	actual range Sb (0,05 ms)	actual range Sb (0,25 ms)	actual range Sb (1 ms)	actual range Sb (5 ms)
FVDK 67 (standard version)	200 mm (HS)	-	800 mm (nL)	1200 mm (HP)
FVDK 67 (2 adjustable outputs)	200 mm (HS)	-	800 mm (nL)	1200 mm (HP)
FVDK 67 (master/slave)	200 mm (HS)	-	800 mm (nL)	1200 mm (HP)
FVDK 66 (standard version)	-	240 mm (FT)	410 mm (nL)	-
FVDK 66 (master/slave)	-	240 mm (FT)	390 mm (nL)	-
FVDK 22	-	-	320 mm (nL)	-
FVDK 12	-	-	320 mm (nL)	-
FVDK 12 (fast version)	300 mm (HS)	-	-	-
FVDK 10	-	-	160 mm (nL)	-
FWDK 84 (analog output)	-	-	90 mm (nL)	-

operating modes  
 HS High Speed  
 FT fast  
 nL Standard  
 HP High Sensitivity

**order reference**

FSE 200C1Y00



Sb = 180 mm



- with thread
- suitable for flexible cable carriers

**general data**

particular characteristics	suitable for flexible cable carriers
type	through beam sensor
actual range Sb	180 mm
response time / release time	0,05 ... 5 ms
type of head (fiber optic cable)	cylindrical threaded (axial)
width / diameter (head)	3 mm
height / length (head)	11 mm
material (head)	stainless steel
bending radius	4 mm
cable jacket diameter	1 mm
material cable jacket	PE
material (fiber optic cable)	plastic
length (fiber optic cable)	2000 mm
operating temperature	-30 ... +70 °C

**dimension drawing**

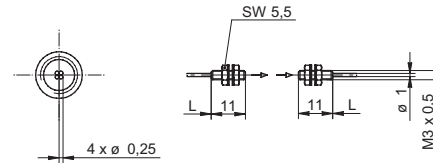

**Accessories**

10114652	Cutting tool for plastic fiber optics
10119912	Mounting bracket Ø 1,1 mm
10140260	Reduction tube
10119910	Doubling lens M3 increases the actual range (pairs)

for details: see accessories section

Sensing distance/response time:  
For the definitive sensing distance/response time please see table below "fitting fiber optic sensors".

fitting fiber optic sensors	actual range Sb (0,05 ms)	actual range Sb (0,25 ms)	actual range Sb (1 ms)	actual range Sb (5 ms)
FVDK 67 (standard version)	30 mm (HS)	-	120 mm (nL)	180 mm (HP)
FVDK 67 (2 adjustable outputs)	30 mm (HS)	-	120 mm (nL)	180 mm (HP)
FVDK 67 (master/slave)	30 mm (HS)	-	120 mm (nL)	180 mm (HP)
FVDK 66 (standard version)	-	38 mm (FT)	60 mm (nL)	-
FVDK 66 (master/slave)	-	38 mm (FT)	60 mm (nL)	-
FVDK 22	-	-	45 mm (nL)	-
FVDK 12	-	-	45 mm (nL)	-
FVDK 12 (fast version)	42 mm (HS)	-	-	-
FVDK 10	-	-	20 mm (nL)	-
FWDK 84 (analog output)	-	-	20 mm (nL)	-

operating modes  
HS High Speed  
FT fast  
nL Standard  
HP High Sensitivity

**order reference**

FSE 200D1Y50



Sb = 1200 mm



- Smooth sensing head

general data	
particular characteristics	standard
type	through beam sensor
actual range Sb	1200 mm
response time / release time	0,05 ... 5 ms
type of head (fiber optic cable)	cylindrical smooth (axial)
width / diameter (head)	4 mm
height / length (head)	20 mm
material (head)	aluminum
bending radius	15 mm
cable jacket diameter	2,2 mm
material cable jacket	PE
material (fiber optic cable)	plastic
length (fiber optic cable)	2000 mm
operating temperature	-30 ... +70 °C

Sensing distance/response time:  
For the definitive sensing distance/response time please see table below "fitting fiber optic sensors".

dimension drawing

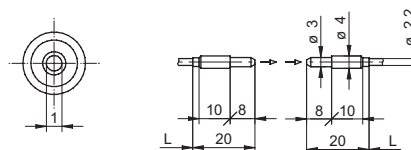

Accessories

10114652	Cutting tool for plastic fiber optics
10119911	Mounting bracket Ø 2,2 mm
10156738	Fiber optic cable extension 2 m
10158142	Fiber optic cable extension 5 m
10145523	Fiber optic cable extension 5 m hochflexibel

for details: see accessories section

fitting fiber optic sensors	actual range Sb (0,05 ms)	actual range Sb (0,25 ms)	actual range Sb (1 ms)	actual range Sb (5 ms)
FVDK 67 (standard version)	130 mm (HS)	-	900 mm (nL)	1200 mm (HP)
FVDK 67 (2 adjustable outputs)	130 mm (HS)	-	900 mm (nL)	1200 mm (HP)
FVDK 67 (master/slave)	130 mm (HS)	-	900 mm (nL)	1200 mm (HP)
FVDK 66 (standard version)	-	220 mm (FT)	390 mm (nL)	-
FVDK 66 (master/slave)	-	220 mm (FT)	390 mm (nL)	-
FVDK 22	-	-	320 mm (nL)	-
FVDK 12	-	-	320 mm (nL)	-
FVDK 12 (fast version)	300 mm (HS)	-	-	-
FVDK 10	-	-	160 mm (nL)	-
FWDK 84 (analog output)	-	-	90 mm (nL)	-

operating modes  
 HS High Speed  
 FT fast  
 nL Standard  
 HP High Sensitivity

order reference
FSE 200C2002

FSE 200C2002 Sb = 1200 mm

Plastic fiber optics / Through beam sensors



Sb = 340 mm



- Smooth sensing head

**general data**

particular characteristics	standard
type	through beam sensor
actual range Sb	340 mm
response time / release time	0,05 ... 5 ms
type of head (fiber optic cable)	cylindrical smooth (axial)
width / diameter (head)	3 mm
height / length (head)	17 mm
material (head)	aluminum
bending radius	8 mm
cable jacket diameter	0,95 mm
material cable jacket	PE
material (fiber optic cable)	plastic
length (fiber optic cable)	2000 mm
operating temperature	-30 ... +70 °C

**dimension drawing**

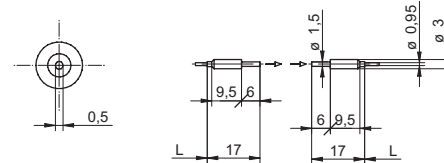

**Accessories**

10114652	Cutting tool for plastic fiber optics
10119912	Mounting bracket Ø 1,1 mm
10140260	Reduction tube
for details: see accessories section	

Sensing distance/response time:  
For the definitive sensing distance/response time please see table below "fitting fiber optic sensors".

fitting fiber optic sensors	actual range Sb (0,05 ms)	actual range Sb (0,25 ms)	actual range Sb (1 ms)	actual range Sb (5 ms)
FVDK 67 (standard version)	40 mm (HS)	-	290 mm (nL)	340 mm (HP)
FVDK 67 (2 adjustable outputs)	40 mm (HS)	-	290 mm (nL)	340 mm (HP)
FVDK 67 (master/slave)	40 mm (HS)	-	290 mm (nL)	340 mm (HP)
FVDK 66 (standard version)	-	70 mm (FT)	125 mm (nL)	-
FVDK 66 (master/slave)	-	70 mm (FT)	125 mm (nL)	-
FVDK 22	-	-	100 mm (nL)	-
FVDK 12	-	-	100 mm (nL)	-
FVDK 12 (fast version)	94 mm (HS)	-	-	-
FVDK 10	-	-	50 mm (nL)	-
FWDK 84 (analog output)	-	-	28 mm (nL)	-

operating modes  
HS High Speed  
FT fast  
nL Standard  
HP High Sensitivity

**order reference**

FSE 200C2004

FSE 200C2004 Sb = 340 mm

Plastic fiber optics / Through beam sensors



Sb = 1200 mm



- Smooth sensing head
- short sensing head

**general data**

particular characteristics	standard short sensing head
type	through beam sensor
actual range Sb	1200 mm
response time / release time	0,05 ... 5 ms
type of head (fiber optic cable)	cylindrical smooth (axial)
width / diameter (head)	3 mm
height / length (head)	15 mm
material (head)	stainless steel
bending radius	20 mm
cable jacket diameter	2,2 mm
material cable jacket	PE
material (fiber optic cable)	plastic
length (fiber optic cable)	2000 mm
operating temperature	-30 ... +70 °C

Sensing distance/response time:  
For the definitive sensing distance/response time please see table below "fitting fiber optic sensors".

**dimension drawing**

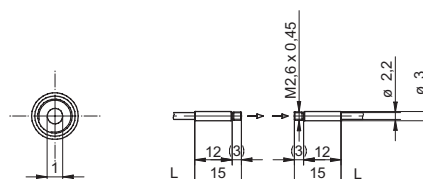

**Accessories**

10114652	Cutting tool for plastic fiber optics
10119911	Mounting bracket Ø 2,2 mm
10156738	Fiber optic cable extension 2 m
10158142	Fiber optic cable extension 5 m
10145523	Fiber optic cable extension 5 m hochflexibel
10134541	Doubling lens increases the actual range (paires)
10134540	Doubling lens increases the actual range (paires)

for details: see accessories section

fitting fiber optic sensors	actual range Sb (0,05 ms)	actual range Sb (0,25 ms)	actual range Sb (1 ms)	actual range Sb (5 ms)
FVDK 67 (standard version)	200 mm (HS)	-	800 mm (nL)	1200 mm (HP)
FVDK 67 (2 adjustable outputs)	200 mm (HS)	-	800 mm (nL)	1200 mm (HP)
FVDK 67 (master/slave)	200 mm (HS)	-	800 mm (nL)	1200 mm (HP)
FVDK 66 (standard version)	-	240 mm (FT)	410 mm (nL)	-
FVDK 66 (master/slave)	-	240 mm (FT)	410 mm (nL)	-
FVDK 22	-	-	100 mm (nL)	-
FVDK 12	-	-	100 mm (nL)	-
FVDK 12 (fast version)	94 mm (HS)	-	-	-
FVDK 10	-	-	160 mm (nL)	-
FWDK 84 (analog output)	-	-	90 mm (nL)	-

operating modes  
HS High Speed  
FT fast  
nL Standard  
HP High Sensitivity

**order reference**

FSE 200C2Y00



Sb = 180 mm



- Smooth sensing head

**general data**

particular characteristics	standard
type	through beam sensor
actual range Sb	180 mm
response time / release time	0,05 ... 5 ms
type of head (fiber optic cable)	cylindrical smooth (axial)
width / diameter (head)	1,5 mm
height / length (head)	15 mm
material (head)	stainless steel
bending radius	4 mm
cable jacket diameter	1 mm
material cable jacket	PE
material (fiber optic cable)	plastic
length (fiber optic cable)	2000 mm
operating temperature	-30 ... +70 °C

**dimension drawing**

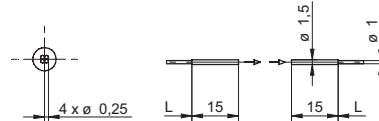

**Accessories**

10114652	Cutting tool for plastic fiber optics
10119912	Mounting bracket Ø 1,1 mm
10140260	Reduction tube
for details: see accessories section	

Sensing distance/response time:  
For the definitive sensing distance/response time please see table below "fitting fiber optic sensors".

fitting fiber optic sensors	actual range Sb (0,05 ms)	actual range Sb (0,25 ms)	actual range Sb (1 ms)	actual range Sb (5 ms)
FVDK 67 (standard version)	30 mm (HS)	-	120 mm (nL)	180 mm (HP)
FVDK 67 (2 adjustable outputs)	30 mm (HS)	-	120 mm (nL)	180 mm (HP)
FVDK 67 (master/slave)	30 mm (HS)	-	120 mm (nL)	180 mm (HP)
FVDK 66 (standard version)	-	38 mm (FT)	60 mm (nL)	-
FVDK 66 (master/slave)	-	38 mm (FT)	60 mm (nL)	-
FVDK 22	-	-	45 mm (nL)	-
FVDK 12	-	-	45 mm (nL)	-
FVDK 12 (fast version)	42 mm (HS)	-	-	-
FVDK 10	-	-	20 mm (nL)	-
FWDK 84 (analog output)	-	-	20 mm (nL)	-

operating modes  
HS High Speed  
FT fast  
nL Standard  
HP High Sensitivity

**order reference**

FSE 200D2Y00



**S<sub>b</sub> = 37 mm**



- Smooth sensing head
- small sensing head

general data	
particular characteristics	small sensing head
type	through beam sensor
actual range S <sub>b</sub>	37 mm
response time / release time	0,05 ... 5 ms
type of head (fiber optic cable)	cylindrical smooth (axial)
width / diameter (head)	3 mm
height / length (head)	20 mm
material (head)	stainless steel
bending radius	15 mm
cable jacket diameter	1 mm
material cable jacket	PE
material (fiber optic cable)	plastic
length (fiber optic cable)	2000 mm
operating temperature	-30 ... +70 °C

**dimension drawing**

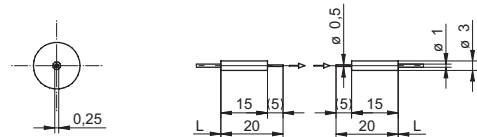

**Accessories**

10114652	Cutting tool for plastic fiber optics
10119912	Mounting bracket Ø 1,1 mm
10140260	Reduction tube
for details: see accessories section	

Sensing distance/response time:  
For the definitive sensing distance/response time please see table below "fitting fiber optic sensors".

fitting fiber optic sensors	actual range S <sub>b</sub> (0,05 ms)	actual range S <sub>b</sub> (0,25 ms)	actual range S <sub>b</sub> (1 ms)	actual range S <sub>b</sub> (5 ms)
FVDK 67 (standard version)	6 mm (HS)	-	25 mm (nL)	37 mm (HP)
FVDK 67 (2 adjustable outputs)	6 mm (HS)	-	25 mm (nL)	37 mm (HP)
FVDK 67 (master/slave)	6 mm (HS)	-	25 mm (nL)	37 mm (HP)
FVDK 66 (standard version)	-	7 mm (FT)	12 mm (nL)	-
FVDK 66 (master/slave)	-	7 mm (FT)	12 mm (nL)	-
FVDK 22	-	-	15 mm (nL)	-
FVDK 12	-	-	15 mm (nL)	-
FVDK 12 (fast version)	14 mm (HS)	-	-	-
FVDK 10	-	-	8 mm (nL)	-
FWDK 84 (analog output)	-	-	4 mm (nL)	-

operating modes  
HS High Speed  
FT fast  
nL Standard  
HP High Sensitivity

order reference
FSE 200D2Y50

FSE 200D2Y50 S<sub>b</sub> = 37 mm

Plastic fiber optics / Through beam sensors



**Sb = 750 mm**



- Smooth sensing head
- side view

**general data**

particular characteristics	side view smooth sensing head without thread
type	through beam sensor
actual range Sb	750 mm
response time / release time	0,05 ... 5 ms
type of head (fiber optic cable)	cylindrical smooth (radial)
width / diameter (head)	4 mm
height / length (head)	22 mm
material (head)	aluminum
bending radius	15 mm
cable jacket diameter	2,2 mm
material cable jacket	PE
material (fiber optic cable)	plastic
length (fiber optic cable)	2000 mm
operating temperature	-30 ... +70 °C

**dimension drawing**

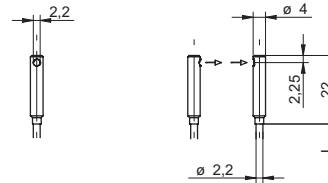

**Accessories**

10114652	Cutting tool for plastic fiber optics
10119911	Mounting bracket Ø 2,2 mm
10156738	Fiber optic cable extension 2 m
10158142	Fiber optic cable extension 5 m
10145523	Fiber optic cable extension 5 m hochflexibel

for details: see accessories section

Sensing distance/response time:  
For the definitive sensing distance/response time please see table below "fitting fiber optic sensors".

fitting fiber optic sensors	actual range Sb (0,05 ms)	actual range Sb (0,25 ms)	actual range Sb (1 ms)	actual range Sb (5 ms)
FVDK 67 (standard version)	80 mm (HS)	-	600 mm (nL)	750 mm (HP)
FVDK 67 (2 adjustable outputs)	80 mm (HS)	-	600 mm (nL)	750 mm (HP)
FVDK 67 (master/slave)	80 mm (HS)	-	600 mm (nL)	750 mm (HP)
FVDK 66 (standard version)	-	150 mm (FT)	260 mm (nL)	-
FVDK 66 (master/slave)	-	150 mm (FT)	260 mm (nL)	-
FVDK 22	-	-	200 mm (nL)	-
FVDK 12	-	-	200 mm (nL)	-
FVDK 12 (fast version)	188 mm (HS)	-	-	-
FVDK 10	-	-	100 mm (nL)	-
FWDK 84 (analog output)	-	-	55 mm (nL)	-

operating modes  
 HS High Speed  
 FT fast  
 nL Standard  
 HP High Sensitivity

**order reference**

**FSE 200C4001**

FSE 200C4001 Sb = 750 mm

Plastic fiber optics / Through beam sensors





Sb = 750 mm



- with thread
- side view

general data	
particular characteristics	side view
type	through beam sensor
actual range Sb	750 mm
response time / release time	0,05 ... 5 ms
type of head (fiber optic cable)	cylindrical threaded (radial)
width / diameter (head)	4 mm
height / length (head)	22 mm
material (head)	brass
bending radius	15 mm
cable jacket diameter	2,2 mm
material cable jacket	PE
material (fiber optic cable)	plastic
length (fiber optic cable)	2000 mm
operating temperature	-30 ... +70 °C

Sensing distance/response time:  
For the definitive sensing distance/response time please see table below "fitting fiber optic sensors".

dimension drawing

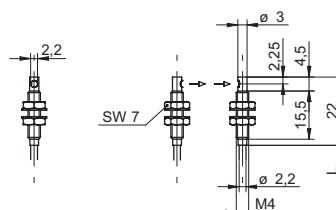

Accessories

10114652	Cutting tool for plastic fiber optics
10119911	Mounting bracket Ø 2,2 mm
10156738	Fiber optic cable extension 2 m
10158142	Fiber optic cable extension 5 m
10145523	Fiber optic cable extension 5 m hochflexibel

for details: see accessories section

fitting fiber optic sensors	actual range Sb (0,05 ms)	actual range Sb (0,25 ms)	actual range Sb (1 ms)	actual range Sb (5 ms)
FVDK 67 (standard version)	80 mm (HS)	-	600 mm (nL)	750 mm (HP)
FVDK 67 (2 adjustable outputs)	80 mm (HS)	-	600 mm (nL)	750 mm (HP)
FVDK 67 (master/slave)	80 mm (HS)	-	600 mm (nL)	750 mm (HP)
FVDK 66 (standard version)	-	150 mm (FT)	260 mm (nL)	-
FVDK 66 (master/slave)	-	150 mm (FT)	260 mm (nL)	-
FVDK 22	-	-	200 mm (nL)	-
FVDK 12	-	-	200 mm (nL)	-
FVDK 12 (fast version)	188 mm (HS)	-	-	-
FVDK 10	-	-	100 mm (nL)	-
FWDK 84 (analog output)	-	-	55 mm (nL)	-

operating modes  
 HS High Speed  
 FT fast  
 nL Standard  
 HP High Sensitivity

order reference
FSE 200C4002

FSE 200C4002 Sb = 750 mm

Plastic fiber optics / Through beam sensors



Sb = 165 mm



- Smooth sensing head
- side view

**general data**

particular characteristics	side view small sensing head smooth sensing head without thread
type	through beam sensor
actual range Sb	165 mm
response time / release time	0,05 ... 5 ms
type of head (fiber optic cable)	cylindrical smooth (radial)
width / diameter (head)	2,5 mm
height / length (head)	27 mm
material (head)	stainless steel
bending radius	15 mm
cable jacket diameter	1 mm
material cable jacket	PE
material (fiber optic cable)	plastic
length (fiber optic cable)	2000 mm
operating temperature	-30 ... +70 °C

**dimension drawing**

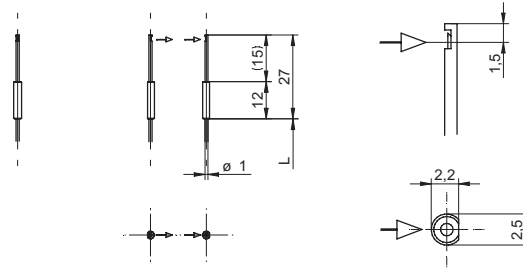

**Accessories**

10114652	Cutting tool for plastic fiber optics
10119912	Mounting bracket Ø 1,1 mm
10140260	Reduction tube
for details: see accessories section	

Sensing distance/response time:  
For the definitive sensing distance/response time please see table below "fitting fiber optic sensors".

fitting fiber optic sensors	actual range Sb (0,05 ms)	actual range Sb (0,25 ms)	actual range Sb (1 ms)	actual range Sb (5 ms)
FVDK 67 (standard version)	27 mm (HS)	-	110 mm (nL)	165 mm (HP)
FVDK 67 (2 adjustable outputs)	27 mm (HS)	-	110 mm (nL)	165 mm (HP)
FVDK 67 (master/slave)	27 mm (HS)	-	110 mm (nL)	165 mm (HP)
FVDK 66 (standard version)	-	33 mm (FT)	55 mm (nL)	-
FVDK 66 (master/slave)	-	33 mm (FT)	55 mm (nL)	-
FVDK 22	-	-	50 mm (nL)	-
FVDK 12	-	-	50 mm (nL)	-
FVDK 12 (fast version)	47 mm (HS)	-	-	-
FVDK 10	-	-	18 mm (nL)	-
FWDK 84 (analog output)	-	-	14 mm (nL)	-

operating modes  
 HS High Speed  
 FT fast  
 nL Standard  
 HP High Sensitivity

**order reference**

FSE 200D4Y00

FSE 200D4Y00 Sb = 165 mm

Plastic fiber optics / Through beam sensors



Sb = 780 mm



- Array
- Line length = Number of holes x hole spacing

general data	
particular characteristics	array (fine light barrier)
type	through beam sensor
actual range Sb	780 mm
response time / release time	0,05 ... 5 ms
type of head (fiber optic cable)	rectangular
width / diameter (head)	15,6 mm
height / length (head)	15,6 mm
depth (head)	5 mm
material (head)	POM
bending radius	4 mm
cable jacket diameter	2,2 mm
material cable jacket	PE
material (fiber optic cable)	plastic
length (fiber optic cable)	2000 mm
operating temperature	-30 ... +70 °C

Sensing distance/response time:  
For the definitive sensing distance/response time please see table below "fitting fiber optic sensors".

dimension drawing

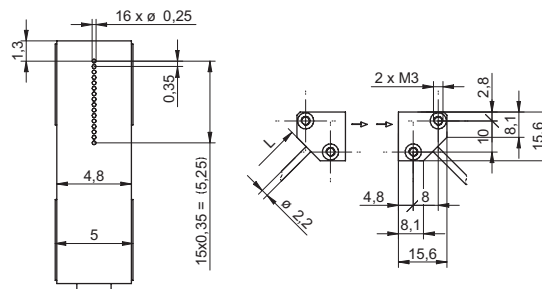

Accessories

10114652	Cutting tool for plastic fiber optics
10119911	Mounting bracket Ø 2,2 mm
10156738	Fiber optic cable extension 2 m
10158142	Fiber optic cable extension 5 m
10145523	Fiber optic cable extension 5 m hochflexibel

for details: see accessories section

fitting fiber optic sensors	actual range Sb (0,05 ms)	actual range Sb (0,25 ms)	actual range Sb (1 ms)	actual range Sb (5 ms)
FVDK 67 (standard version)	130 mm (HS)	-	520 mm (nL)	780 mm (HP)
FVDK 67 (2 adjustable outputs)	130 mm (HS)	-	520 mm (nL)	780 mm (HP)
FVDK 67 (master/slave)	130 mm (HS)	-	520 mm (nL)	780 mm (HP)
FVDK 66 (standard version)	-	150 mm (FT)	270 mm (nL)	-
FVDK 66 (master/slave)	-	150 mm (FT)	270 mm (nL)	-
FVDK 22	-	-	200 mm (nL)	-
FVDK 12	-	-	200 mm (nL)	-
FVDK 12 (fast version)	188 mm (HS)	-	-	-
FVDK 10	-	-	100 mm (nL)	-
FWDK 84 (analog output)	-	-	55 mm (nL)	-

operating modes  
 HS High Speed  
 FT fast  
 nL Standard  
 HP High Sensitivity

order reference
FSE 200C6Y00



Sb = 790 mm



- Array
- Line length = Number of holes x hole spacing

**general data**

particular characteristics	array (fine light barrier)
type	through beam sensor
actual range Sb	790 mm
response time / release time	0,05 ... 5 ms
type of head (fiber optic cable)	rectangular
width / diameter (head)	20 mm
height / length (head)	25 mm
depth (head)	3 mm
material (head)	aluminum
bending radius	4 mm
cable jacket diameter	2,2 mm
material cable jacket	PE
material (fiber optic cable)	plastic
length (fiber optic cable)	2000 mm
operating temperature	-30 ... +70 °C

**dimension drawing**

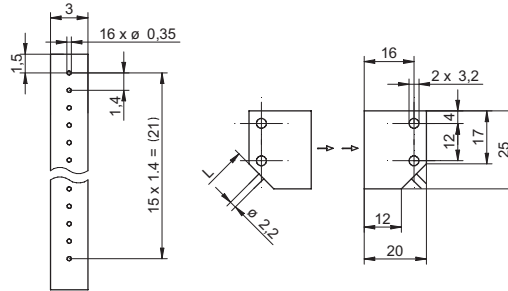

**Accessories**

10114652	Cutting tool for plastic fiber optics
10119911	Mounting bracket Ø 2,2 mm
10156738	Fiber optic cable extension 2 m
10158142	Fiber optic cable extension 5 m
10145523	Fiber optic cable extension 5 m hochflexibel

for details: see accessories section

Sensing distance/response time:  
For the definitive sensing distance/response time please see table below "fitting fiber optic sensors".

fitting fiber optic sensors	actual range Sb (0,05 ms)	actual range Sb (0,25 ms)	actual range Sb (1 ms)	actual range Sb (5 ms)
FVDK 67 (standard version)	85 mm (HS)	-	600 mm (nL)	790 mm (HP)
FVDK 67 (2 adjustable outputs)	85 mm (HS)	-	600 mm (nL)	790 mm (HP)
FVDK 67 (master/slave)	85 mm (HS)	-	600 mm (nL)	790 mm (HP)
FVDK 66 (standard version)	-	150 mm (FT)	260 mm (nL)	-
FVDK 66 (master/slave)	-	150 mm (FT)	260 mm (nL)	-
FVDK 22	-	-	200 mm (nL)	-
FVDK 12	-	-	200 mm (nL)	-
FVDK 12 (fast version)	188 mm (HS)	-	-	-
FVDK 10	-	-	100 mm (nL)	-
FWDK 84 (analog output)	-	-	55 mm (nL)	-

operating modes  
HS High Speed  
FT fast  
nL Standard  
HP High Sensitivity

**order reference**  
FSE 200C6Y02

FSE 200C6Y02 Sb = 790 mm

Plastic fiber optics / Through beam sensors



**S<sub>b</sub> = 790 mm**



- Array
- Line length = Number of holes x hole spacing

**general data**

particular characteristics	array (fine light barrier)
type	through beam sensor
actual range S <sub>b</sub>	790 mm
response time / release time	0,05 ... 5 ms
type of head (fiber optic cable)	rectangular
width / diameter (head)	20 mm
height / length (head)	25 mm
depth (head)	3 mm
material (head)	aluminum
bending radius	4 mm
cable jacket diameter	2,2 mm
material cable jacket	PE
material (fiber optic cable)	plastic
length (fiber optic cable)	2000 mm
operating temperature	-30 ... +70 °C

Sensing distance/response time:  
For the definitive sensing distance/response time please see table below "fitting fiber optic sensors".

**dimension drawing**

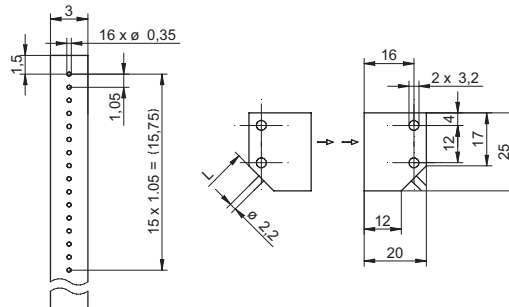

**Accessories**

10114652	Cutting tool for plastic fiber optics
10119911	Mounting bracket Ø 2,2 mm
10156738	Fiber optic cable extension 2 m
10158142	Fiber optic cable extension 5 m
10145523	Fiber optic cable extension 5 m hochflexibel

for details: see accessories section

fitting fiber optic sensors	actual range S <sub>b</sub> (0,05 ms)	actual range S <sub>b</sub> (0,25 ms)	actual range S <sub>b</sub> (1 ms)	actual range S <sub>b</sub> (5 ms)
FVDK 67 (standard version)	85 mm (HS)	-	600 mm (nL)	790 mm (HP)
FVDK 67 (2 adjustable outputs)	85 mm (HS)	-	600 mm (nL)	790 mm (HP)
FVDK 67 (master/slave)	85 mm (HS)	-	600 mm (nL)	790 mm (HP)
FVDK 66 (standard version)	-	150 mm (FT)	260 mm (nL)	-
FVDK 66 (master/slave)	-	150 mm (FT)	260 mm (nL)	-
FVDK 22	-	-	200 mm (nL)	-
FVDK 12	-	-	200 mm (nL)	-
FVDK 12 (fast version)	188 mm (HS)	-	-	-
FVDK 10	-	-	100 mm (nL)	-
FWDK 84 (analog output)	-	-	55 mm (nL)	-

operating modes  
 HS High Speed  
 FT fast  
 nL Standard  
 HP High Sensitivity

**order reference**  
**FSE 200C6Y15**



Sb = 900 mm



- with thread
- ultra flexible

**general data**

particular characteristics	ultra flexible
type	through beam sensor
actual range Sb	900 mm
response time / release time	0,05 ... 5 ms
type of head (fiber optic cable)	cylindrical threaded (axial)
width / diameter (head)	4 mm
height / length (head)	14 mm
material (head)	stainless steel
bending radius	2 mm
cable jacket diameter	2,2 mm
material cable jacket	PE
material (fiber optic cable)	plastic
length (fiber optic cable)	2000 mm
operating temperature	-30 ... +70 °C

Sensing distance/response time:  
For the definitive sensing distance/response time please see table below "fitting fiber optic sensors".

**dimension drawing**

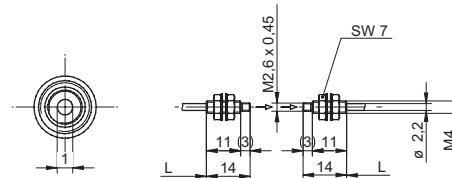

**Accessories**

10114652	Cutting tool for plastic fiber optics
10119911	Mounting bracket Ø 2,2 mm
10156738	Fiber optic cable extension 2 m
10158142	Fiber optic cable extension 5 m
10145523	Fiber optic cable extension 5 m hochflexibel
10134541	Doubling lens increases the actual range (paires)
10134540	Doubling lens increases the actual range (paires)

for details: see accessories section

fitting fiber optic sensors	actual range Sb (0,05 ms)	actual range Sb (0,25 ms)	actual range Sb (1 ms)	actual range Sb (5 ms)
FVDK 67 (standard version)	150 mm (HS)	-	600 mm (nL)	900 mm (HP)
FVDK 67 (2 adjustable outputs)	150 mm (HS)	-	600 mm (nL)	900 mm (HP)
FVDK 67 (master/slave)	150 mm (HS)	-	600 mm (nL)	900 mm (HP)
FVDK 66 (standard version)	-	180 mm (FT)	310 mm (nL)	-
FVDK 66 (master/slave)	-	180 mm (FT)	310 mm (nL)	-
FVDK 22	-	-	270 mm (nL)	-
FVDK 12	-	-	270 mm (nL)	-
FVDK 12 (fast version)	255 mm (HS)	-	-	-
FVDK 10	-	-	120 mm (nL)	-
FWDK 84 (analog output)	-	-	75 mm (nL)	-

operating modes  
HS High Speed  
FT fast  
nL Standard  
HP High Sensitivity

**order reference**

FSE 200E1Y00

FSE 200E1Y00 Sb = 900 mm

Plastic fiber optics / Through beam sensors



Sb = 140 mm



- with thread
- ultra flexible

general data	
particular characteristics	ultra flexible
type	through beam sensor
actual range Sb	140 mm
response time / release time	0,05 ... 5 ms
type of head (fiber optic cable)	cylindrical threaded (axial)
width / diameter (head)	3 mm
height / length (head)	11 mm
material (head)	stainless steel
bending radius	1 mm
cable jacket diameter	1 mm
material cable jacket	PE
material (fiber optic cable)	plastic
length (fiber optic cable)	2000 mm
operating temperature	-30 ... +70 °C

Sensing distance/response time:  
For the definitive sensing distance/response time please see table below "fitting fiber optic sensors".

dimension drawing

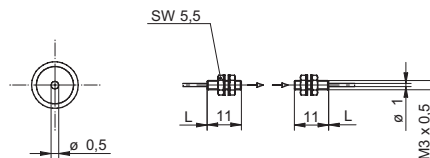

Accessories	
10114652	Cutting tool for plastic fiber optics
10119912	Mounting bracket Ø 1,1 mm
10140260	Reduction tube
for details: see accessories section	

fitting fiber optic sensors	actual range Sb (0,05 ms)	actual range Sb (0,25 ms)	actual range Sb (1 ms)	actual range Sb (5 ms)
FVDK 67 (standard version)	23 mm (HS)	-	95 mm (nL)	140 mm (HP)
FVDK 67 (2 adjustable outputs)	23 mm (HS)	-	95 mm (nL)	140 mm (HP)
FVDK 67 (master/slave)	23 mm (HS)	-	95 mm (nL)	140 mm (HP)
FVDK 66 (standard version)	-	29 mm (FT)	50 mm (nL)	-
FVDK 66 (master/slave)	-	29 mm (FT)	50 mm (nL)	-
FVDK 22	-	-	30 mm (nL)	-
FVDK 12	-	-	30 mm (nL)	-
FVDK 12 (fast version)	28 mm (HS)	-	-	-
FVDK 10	-	-	12 mm (nL)	-
FWDK 84 (analog output)	-	-	8 mm (nL)	-

operating modes  
HS High Speed  
FT fast  
nL Standard  
HP High Sensitivity

order reference
FSE 200F1Y00

Plastic fiber optics / Through beam sensors FSE 200F1Y00 Sb = 140 mm



Sb = 52 mm



- smooth sensing head
- side view

**general data**

particular characteristics	side view small sensing head
type	through beam sensor
actual range Sb	52 mm
response time / release time	0,05 ... 5 ms
type of head (fiber optic cable)	cylindrical smooth (radial)
width / diameter (head)	2,5 mm
height / length (head)	27 mm
material (head)	stainless steel
bending radius	1 mm
cable jacket diameter	1 mm
material cable jacket	PE
material (fiber optic cable)	plastic
length (fiber optic cable)	2000 mm
operating temperature	-30 ... +70 °C

**dimension drawing**

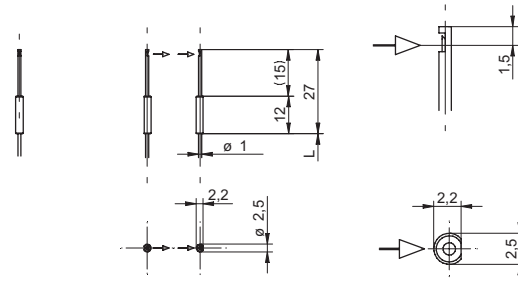

**Accessories**

10114652	Cutting tool for plastic fiber optics
10119912	Mounting bracket $\varnothing 1,1$ mm
10140260	Reduction tube
for details: see accessories section	

Sensing distance/response time:  
For the definitive sensing distance/response time please see table below "fitting fiber optic sensors".

fitting fiber optic sensors	actual range Sb (0,05 ms)	actual range Sb (0,25 ms)	actual range Sb (1 ms)	actual range Sb (5 ms)
FVDK 67 (standard version)	8 mm (HS)	-	35 mm (nL)	52 mm (HP)
FVDK 67 (2 adjustable outputs)	8 mm (HS)	-	35 mm (nL)	52 mm (HP)
FVDK 67 (master/slave)	8 mm (HS)	-	35 mm (nL)	52 mm (HP)
FVDK 66 (standard version)	-	11 mm (FT)	20 mm (nL)	-
FVDK 66 (master/slave)	-	11 mm (FT)	20 mm (nL)	-
FVDK 22	-	-	15 mm (nL)	-
FVDK 12	-	-	15 mm (nL)	-
FVDK 12 (fast version)	14 mm (HS)	-	-	-
FVDK 10	-	-	8 mm (nL)	-
FWDK 84 (analog output)	-	-	4 mm (nL)	-

operating modes  
 HS High Speed  
 FT fast  
 nL Standard  
 HP High Sensitivity

**order reference**

FSE 200F4Y00

FSE 200F4Y00 Sb = 52 mm

Plastic fiber optics / Through beam sensors





Sb = 140 mm



- rectangular
- plastic

**general data**

type	through beam sensor
actual range Sb	140 mm
response time / release time	0,05 ... 5 ms
type of head (fiber optic cable)	rectangular
width / diameter (head)	12 mm
height / length (head)	8 mm
depth (head)	3 mm
material (head)	POM
bending radius	1 mm
cable jacket diameter	1 mm
material cable jacket	PE
material (fiber optic cable)	plastic
length (fiber optic cable)	2000 mm
operating temperature	-30 ... +70 °C

Sensing distance/response time:  
For the definitive sensing distance/response time please see table below "fitting fiber optic sensors".

**dimension drawing**

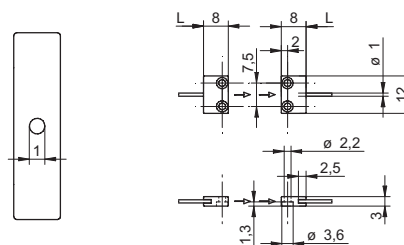

**Accessories**

10114652	Cutting tool for plastic fiber optics
10119912	Mounting bracket Ø 1,1 mm
10140260	Reduction tube
for details: see accessories section	

fitting fiber optic sensors	actual range Sb (0,05 ms)	actual range Sb (0,25 ms)	actual range Sb (1 ms)	actual range Sb (5 ms)
FVDK 67 (standard version)	17 mm (HS)	-	110 mm (nL)	140 mm (HP)
FVDK 67 (2 adjustable outputs)	17 mm (HS)	-	110 mm (nL)	140 mm (HP)
FVDK 67 (master/slave)	17 mm (HS)	-	110 mm (nL)	140 mm (HP)
FVDK 66 (standard version)	-	23 mm (FT)	40 mm (nL)	-
FVDK 66 (master/slave)	-	23 mm (FT)	40 mm (nL)	-
FVDK 22	-	-	40 mm (nL)	-
FVDK 12	-	-	40 mm (nL)	-
FVDK 12 (fast version)	37 mm (HS)	-	-	-
FVDK 10	-	-	15 mm (nL)	-
FWDK 84 (analog output)	-	-	11 mm (nL)	-

operating modes  
 HS High Speed  
 FT fast  
 nL Standard  
 HP High Sensitivity

**order reference**

FSE 100F6Y01

FSE 100F6Y01 Sb = 140 mm

Plastic fiber optics / Through beam sensors



Sb = 140 mm



- rectangular
- brass nickel plated sensor head

**general data**

type	through beam sensor
actual range Sb	140 mm
response time / release time	0,05 ... 5 ms
type of head (fiber optic cable)	rectangular
width / diameter (head)	10 mm
height / length (head)	10 mm
depth (head)	3 mm
material (head)	brass nickel plated
bending radius	1 mm
cable jacket diameter	1 mm
material cable jacket	PE
material (fiber optic cable)	plastic
length (fiber optic cable)	2000 mm
operating temperature	-30 ... +70 °C

**dimension drawing**

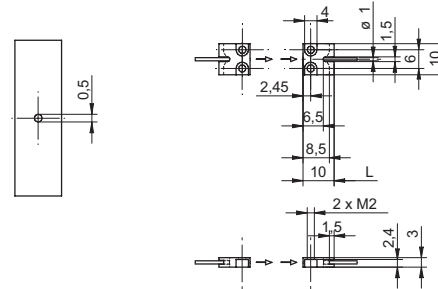

**Accessories**

10114652	Cutting tool for plastic fiber optics
10119912	Mounting bracket Ø 1,1 mm
10140260	Reduction tube
for details: see accessories section	

Sensing distance/response time:  
For the definitive sensing distance/response time please see table below "fitting fiber optic sensors".

fitting fiber optic sensors	actual range Sb (0,05 ms)	actual range Sb (0,25 ms)	actual range Sb (1 ms)	actual range Sb (5 ms)
FVDK 67 (standard version)	23 mm (HS)	-	95 mm (nL)	140 mm (HP)
FVDK 67 (2 adjustable outputs)	23 mm (HS)	-	95 mm (nL)	140 mm (HP)
FVDK 67 (master/slave)	23 mm (HS)	-	95 mm (nL)	140 mm (HP)
FVDK 66 (standard version)	-	29 mm (FT)	50 mm (nL)	-
FVDK 66 (master/slave)	-	29 mm (FT)	50 mm (nL)	-
FVDK 22	-	-	40 mm (nL)	-
FVDK 12	-	-	40 mm (nL)	-
FVDK 12 (fast version)	37 mm (HS)	-	-	-
FVDK 10	-	-	15 mm (nL)	-
FWDK 84 (analog output)	-	-	11 mm (nL)	-

operating modes  
HS High Speed  
FT fast  
nL Standard  
HP High Sensitivity

<b>order reference</b>
<b>FSE 200F6Y00</b>

FSE 200F6Y00 Sb = 140 mm

Plastic fiber optics / Through beam sensors



Sb = 2175 mm



- with thread

general data	
type	through beam sensor
actual range Sb	2175 mm
response time / release time	0,05 ... 5 ms
type of head (fiber optic cable)	cylindrical threaded (axial)
width / diameter (head)	3 mm
height / length (head)	14 mm
material (head)	stainless steel
bending radius	20 mm
cable jacket diameter	2,2 mm
material cable jacket	PE
material (fiber optic cable)	plastic
length (fiber optic cable)	2000 mm
operating temperature	-30 ... +70 °C

Sensing distance/response time:  
For the definitive sensing distance/response time please see table below "fitting fiber optic sensors".

dimension drawing

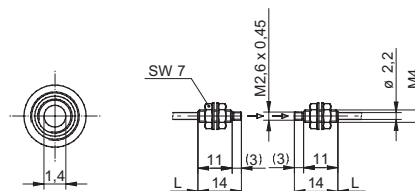

Accessories

10114652	Cutting tool for plastic fiber optics
10119911	Mounting bracket Ø 2,2 mm
10156738	Fiber optic cable extension 2 m
10158142	Fiber optic cable extension 5 m
10145523	Fiber optic cable extension 5 m hochflexibel

for details: see accessories section

fitting fiber optic sensors	actual range Sb (0,05 ms)	actual range Sb (0,25 ms)	actual range Sb (1 ms)	actual range Sb (5 ms)
FVDK 67 (standard version)	360 mm (HS)	-	1450 mm (nL)	2175 mm (HP)
FVDK 67 (2 adjustable outputs)	360 mm (HS)	-	1450 mm (nL)	2175 mm (HP)
FVDK 67 (master/slave)	360 mm (HS)	-	1450 mm (nL)	2175 mm (HP)
FVDK 66 (standard version)	-	450 mm (FT)	770 mm (nL)	-
FVDK 66 (master/slave)	-	450 mm (FT)	770 mm (nL)	-
FVDK 22	-	-	680 mm (nL)	-
FVDK 12	-	-	680 mm (nL)	-
FVDK 12 (fast version)	640 mm (HS)	-	-	-
FVDK 10	-	-	300 mm (nL)	-
FWDK 84 (analog output)	-	-	190 mm (nL)	-

operating modes  
 HS High Speed  
 FT fast  
 nL Standard  
 HP High Sensitivity

order reference

FWE 200C1Y00



Sb = 2350 mm



- Smooth sensing head

**general data**

type	through beam sensor
actual range Sb	2350 mm
response time / release time	0,05 ... 5 ms
type of head (fiber optic cable)	cylindrical smooth (axial)
width / diameter (head)	3 mm
height / length (head)	15 mm
material (head)	stainless steel
bending radius	20 mm
cable jacket diameter	2,2 mm
material cable jacket	PE
material (fiber optic cable)	plastic
length (fiber optic cable)	2000 mm
operating temperature	-30 ... +70 °C

Sensing distance/response time:  
For the definitive sensing distance/response time please see table below "fitting fiber optic sensors".

**dimension drawing**

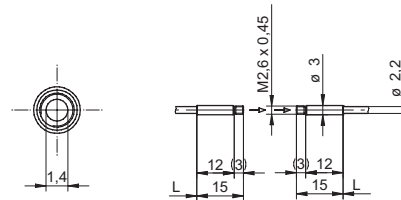

**Accessories**

10114652	Cutting tool for plastic fiber optics
10119911	Mounting bracket Ø 2,2 mm
10156738	Fiber optic cable extension 2 m
10158142	Fiber optic cable extension 5 m
10145523	Fiber optic cable extension 5 m hochflexibel

for details: see accessories section

fitting fiber optic sensors	actual range Sb (0,05 ms)	actual range Sb (0,25 ms)	actual range Sb (1 ms)	actual range Sb (5 ms)
FVDK 67 (standard version)	360 mm (HS)	-	1450 mm (nL)	2350 mm (HP)
FVDK 67 (2 adjustable outputs)	360 mm (HS)	-	1450 mm (nL)	2350 mm (HP)
FVDK 67 (master/slave)	360 mm (HS)	-	1450 mm (nL)	2350 mm (HP)
FVDK 66 (standard version)	-	450 mm (FT)	770 mm (nL)	-
FVDK 66 (master/slave)	-	450 mm (FT)	770 mm (nL)	-
FVDK 22	-	-	680 mm (nL)	-
FVDK 12	-	-	680 mm (nL)	-
FVDK 12 (fast version)	642 mm (HS)	-	-	-
FVDK 10	-	-	300 mm (nL)	-
FWDK 84 (analog output)	-	-	-	-

operating modes  
HS High Speed  
FT fast  
nL Standard  
HP High Sensitivity

<b>order reference</b>
<b>FWE 200C2Y00</b>



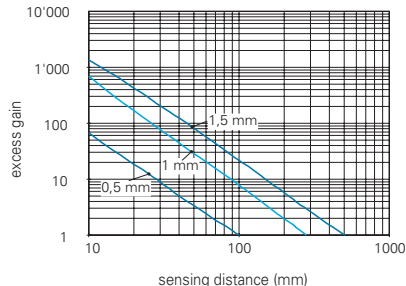
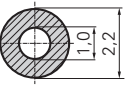
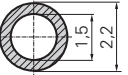

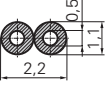
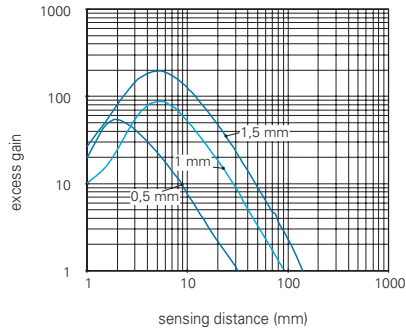
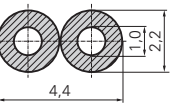

through-beam types	fiber ø	fiber mm <sup>2</sup>	min. bending radius	part nr. <sup>1)</sup>	excess gain curve (2 m cut fiber)
	0,5 mm	≈ 0,2 mm <sup>2</sup>	8 mm	10114158	 <p>reduction of sensing distance: 4 % per meter (valid up to 10 m)</p>
	1 mm	≈ 0,8 mm <sup>2</sup>	15 mm	10114157	
	1,5 mm	≈ 1,8 mm <sup>2</sup>	25 mm	10123729	

Highly flexible version on demand.

reflective types	fiber ø	fiber mm <sup>2</sup>	min. bending radius	part nr. <sup>1)</sup>	excess gain curve (2 m cut fiber)
	2 x 0,5 mm	≈ 2 x 0,2 mm <sup>2</sup>	8 mm	10114594	 <p>reduction of sensing distance: 4 % per meter (valid up to 10 m)</p>
	2 x 1 mm	≈ 2 x 0,8 mm <sup>2</sup>	15 mm	10114595	

Highly flexible version on demand.

<sup>1)</sup> order designation in meters

product family	FZAM 18	FVDM 15	FZAM 18	FZAM 18	FZAM 30
					
width / diameter	18 mm	15 mm	18 mm	18 mm	30 mm
actual range S <sub>b</sub>	310 mm	1200 mm	800 mm	800 mm	600 mm 1400 mm
sensing distance T <sub>w</sub>	60 mm	240 mm	150 mm	150 mm	110 mm 230 mm
response time / release time	< 0,5 ms	< 0,1 ms < 1 ms	< 1 ms	< 1 ms	< 0,25 ms < 2,5 ms
light source	pulsed infrared diode	pulsed infrared diode	pulsed infrared diode	pulsed infrared diode	pulsed infrared diode
adjustment	potentiometer, 15 turn	potentiometer, 20 turn	potentiometer, 270°	Teach-in	potentiometer, 20 turn
output circuit	NPN PNP	NPN PNP	NPN PNP	NPN PNP	NPN PNP
connection types	cable	cable connector	cable connector	cable connector	cable
housing material	metal	metal	metal	metal	metal
<b>page</b>	<b>536</b>	<b>544</b>	<b>537</b>	<b>538</b>	<b>539</b>



## General information

In contrast to plastic fiber optics, glass fiber optics contain hundreds of individual fibers. Each one conveys a part of the emitted light. Depending on the arrangement of the individual fibers, a homogenous light spot or a line can be produced. Also, glass is a high-quality, durable material, which guarantees a long and constant service life. This is only one of the reasons that glass optical fibers are used in the telecommunications industry. The high heat resistance also allows fields of application which are difficult or completely impossible with other sensors.

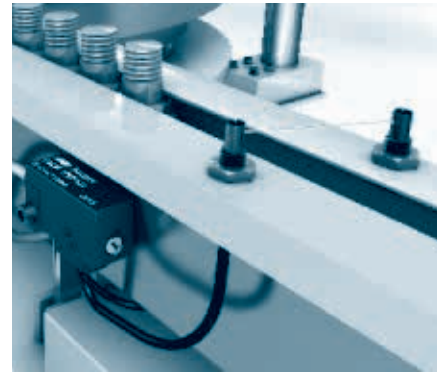

## Typical applications

The wide range of sheath materials and sensing heads make it possible for you to adapt the sensors optimally to your machine concept. A way can always be found to fasten the small fiber optic heads. Due to the different available lengths, the fiber optic sensor can be placed individually at an optimum point.

- Metal-sheathed optical fibers can also be used under harsh conditions
- Detection, differentiation and positioning of different objects
- Monitoring of areas using fiber optic arrays with linear fiber arrangement
- Use at high, low or constantly fluctuating ambient temperatures
- Ranges of up to 1,4 m with fiber optic through beam types

## Characteristics and advantages

### Independent of the environment

As only light is conveyed, electromagnetic fields or high/low temperatures have no effect on the functional reliability.

(plastic-sheathed: -25 ... +70 °C)

(metal-sheathed: -25 ... +250 °C)

### Rugged

Metal-sheathed optical fibers are protected against mechanical effects (chips etc).

All fiber optic sensors are fitted with a rugged metal housing.

### Stable operation

High-quality glass fibers ensure stable operation for a long period. All fiber optic sensors are equipped with high-power infrared light sources, which provide sufficient excess gain even with a certain degree of soiling.

### Area monitoring

Fiber optic arrays with a linear fiber arrangement permit an area to be monitored or the detection of objects which are not precisely conveyed.

### Optimum installation

Apart from the common threaded types, fiber optic sensors with smooth sleeves or side light exit are available.

### Fast processes

Fiber optic sensors with response times of only 50 microseconds permit the detection of objects even in very fast processes.





## Technology and operation

By exploiting the so-called total reflection, it is possible to convey light in a medium such as glass without great loss.

### Explanation of total reflection

When light waves reflect on a barrier layer between two media with different optical densities, they do not simply carry on in a straight line. When they penetrate from an optically denser medium (e.g. glass fiber core) into an optically thinner medium (e.g. glass sheath), there is a smaller angle, the critical angle, under which total reflection occurs. The light wave is reflected back and remains in the optically denser medium.

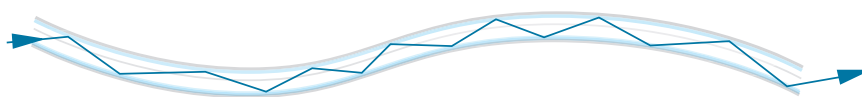

The glass sheath coating the core fiber is decisive for the transmission of light waves almost completely without loss. This ensures an optically consistent density of the sheath and the core and thereby permits a practically constant number of total reflections. This also occurs when the optical fiber is slightly bent. If there would be no core sheath, it would be highly decisive for the total reflection whether the optical fiber is used in an air medium or, for example, water. The critical angle would then change decisively, which could permit an undesired escape of light under certain circumstances.

In the sensing principle, fiber optic solutions are based on intensity differences. With fiber optic through beam types, an object breaking the light beam between the emitter and receiver is detected. With the fiber optic reflective types, the amount of light reflected by an object is evaluated.

For more information, see the section on plastic fiber optics in this chapter.

## Mounting and adjustment

### Fiber optics series 15

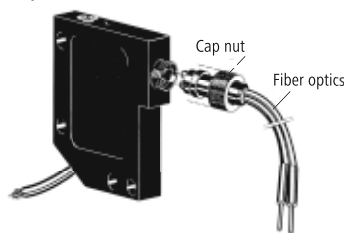

The cap nut to fasten the fiber optics is supplied with every order.

If damaged or lost, the cap nut can be ordered under the following number:

Cap nut 10103230

### Fiber optics series 18



The adjusting plate and cap nut are supplied with every order.

If damaged or lost, they can be ordered under the following part numbers:

Adjusting plate 10101958

Cap nut 10101480

### Fiber optics series 30

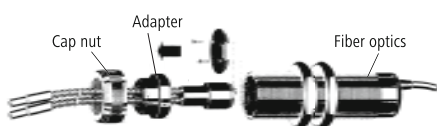

The adapter and the cap nut must be ordered as accessories with every order.

Adapter 10102757

Cap nut 10102801

For installation of the fiber optics, the cover must be removed.

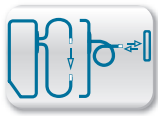

**Sb = 310 mm**  
**Tw = 60 mm**



- sensitivity adjustable via potentiometer (axial)
- rugged metal housing
- infrared light source

**general data**

actual range Sb	310 mm
sensing distance Tw	60 mm
light source	pulsed infrared diode
light indicator	LED yellow
alignment / soiled lens indicator	LED, flashing
adjustment	potentiometer, 15 turn
wave length	880 nm
suppression of reciprocal influence	yes

**electrical data**

response time / release time	< 0,5 ms
voltage supply range +Vs	10 ... 30 VDC
current consumption max. (no load)	45 mA
current consumption typ.	30 mA
voltage drop Vd	< 1,8 VDC
output function	light operate
output current	< 200 mA
short circuit protection	yes
reverse polarity protection	yes

**mechanical data**

width / diameter	18 mm
height / length	50 mm
type	cylindrical threaded
housing material	brass nickel plated / PC
connection types	cabl 3 pin, 2 m

**ambient conditions**

operating temperature	-25 ... +55 °C
protection class	IP 65

**Accessories**

10151658	Sensofix series 18
10101958	Adjusting plate series 18
10101480	Cap nut (replace) for fiber optics series 18

for details: see accessories section

**remarks**

cap nut and adjusting plate are included with fibre

**dimension drawing**

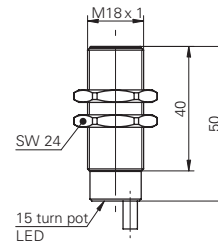

**connection diagrams**

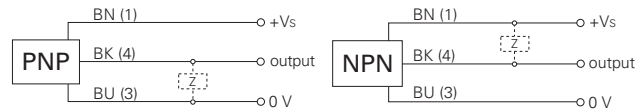

**order reference**                      **output circuit**

<b>FZAM 18N1155</b>	NPN
<b>FZAM 18P1155</b>	PNP

FZAM 18 Sb = 310 mm, Tw = 60 mm

Glass fiber optic sensors

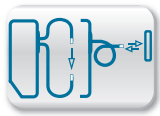

**Sb = 800 mm**  
**Tw = 150 mm**

- sensitivity adjustable via potentiometer (radial)
- rugged metal housing
- infrared light source



### general data

actual range Sb	800 mm
sensing distance Tw	150 mm
light source	pulsed infrared diode
light indicator	LED yellow
alignment / soiled lens indicator	LED, flashing
adjustment	potentiometer, 270°
wave length	880 nm
suppression of reciprocal influence	yes

### electrical data

response time / release time	< 1 ms
voltage supply range +Vs	10 ... 30 VDC
current consumption max. (no load)	45 mA
current consumption typ.	30 mA
voltage drop Vd	< 1,8 VDC
output function	light operate
output current	< 200 mA
short circuit protection	yes
reverse polarity protection	yes

### mechanical data

width / diameter	18 mm
type	cylindrical threaded
housing material	brass nickel plated / PC

### ambient conditions

operating temperature	-25 ... +55 °C
protection class	IP 67

### connectors and mating connectors

ESG 34AH0200	Connector M12, 4 pin, straight, 2 m
ESW 33AH0200	Connector M12, 4 pin, angular, 2 m

additional cable connectors and field wireable connectors: see accessories

### Accessories

10151658	Sensofix series 18
10101958	Adjusting plate series 18
10101480	Cap nut (replace) for fiber optics series 18

for details: see accessories section

### remarks

cap nut and adjusting plate are included with fibre

### dimension drawings

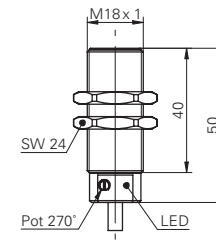
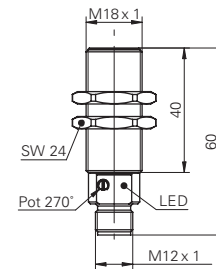

### connection diagrams

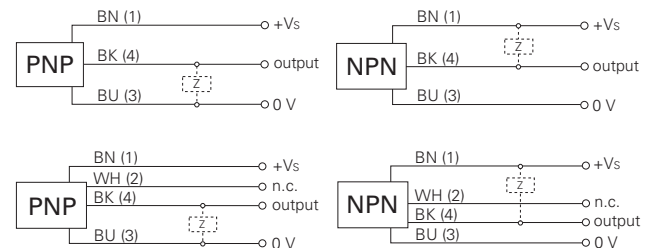

order reference	height / length	output circuit	connection types
FZAM 18N1150	50 mm	NPN	cable 3 pin, 2 m
FZAM 18N1150/S14	60 mm	NPN	connector M12 4 pin
FZAM 18P1150	50 mm	PNP	cable 3 pin, 2 m
FZAM 18P1150/S14	60 mm	PNP	connector M12 4 pin

FZAM 18 Sb = 800 mm, Tw = 150 mm

Glass fiber optic sensors

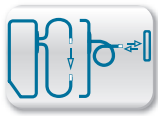

**S<sub>b</sub> = 800 mm**  
**Tw = 150 mm**

- sensitivity adjustable via Teach-in
- light / dark operation programmable
- rugged metal housing



**general data**

actual range S <sub>b</sub>	800 mm
sensing distance Tw	150 mm
light source	pulsed infrared diode
light indicator	LED green
alignment / soiled lens indicator	LED green, flashing
output indicator	LED yellow
adjustment	Teach-in
wave length	880 nm
suppression of reciprocal influence	yes

**electrical data**

response time / release time	< 1 ms
voltage supply range +Vs	10 ... 30 VDC
current consumption max. (no load)	55 mA
current consumption typ.	40 mA
voltage drop V <sub>d</sub>	< 1,8 VDC
output function	light / dark operate switchable
output current	< 200 mA
short circuit protection	yes
reverse polarity protection	yes

**mechanical data**

width / diameter	18 mm
type	cylindrical threaded
housing material	brass nickel plated / PC

**ambient conditions**

operating temperature	-25 ... +55 °C
protection class	IP 67

**connectors and mating connectors**

ESG 34AH0200	Connector M12, 4 pin, straight, 2 m
ESW 33AH0200	Connector M12, 4 pin, angular, 2 m

additional cable connectors and field wireable connectors: see accessories

**Accessories**

10151658	Sensofix series 18
10101958	Adjusting plate series 18
10101480	Cap nut (replace) for fiber optics series 18

for details: see accessories section

**remarks**

cap nut and adjusting plate are included with fibre

**dimension drawings**

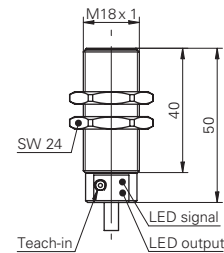
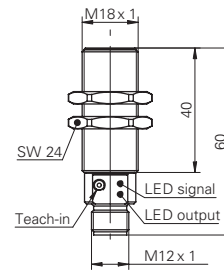

**connection diagrams**



order reference	height / length	output circuit	connection types
FZAM 18N6460	50 mm	NPN	cable 4 pin, 2 m
FZAM 18N6460/S14	60 mm	NPN	connector M12 4 pin
FZAM 18P6460	50 mm	PNP	cable 4 pin, 2 m
FZAM 18P6460/S14	60 mm	PNP	connector M12 4 pin

FZAM 18 S<sub>b</sub> = 800 mm, Tw = 150 mm

Glass fiber optic sensors

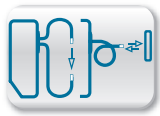

**Sb = 1400 mm**  
**Tw = 230 mm**

- extended sensing distance
- fast version available
- rugged metal housing



### general data

light source	pulsed infrared diode
light indicator	LED yellow
alignment / soiled lens indicator	LED, flashing
adjustment	potentiometer, 20 turn
wave length	880 nm

### electrical data

voltage supply range +Vs	10 ... 30 VDC
voltage drop Vd	< 2,5 VDC
output function	light / dark operate
output current	< 100 mA
short circuit protection	yes
reverse polarity protection	yes

### mechanical data

width / diameter	30 mm
height / length	66 mm
type	cylindrical threaded
housing material	brass nickel plated
connection types	cable 4 pin, 2 m

### ambient conditions

operating temperature	0 ... +65 °C
protection class	IP 65

### Accessories

11200030	Sensofix series 30
ZADAP-M30.STANDARD	Mounting bracket series 30
ZADAP-M30.LONG	Mounting bracket long series 30 (L design)
10102757	Adapter series 30
10106042	Adapter series 30 (angeled fiber optics)
10102801	Cap nut glass cover for sensors series 30

for details: see accessories section

### remarks

cap nut and adapter has to be ordered separatly

### dimension drawing

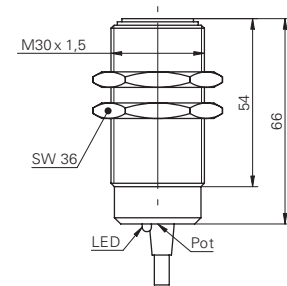

### connection diagrams

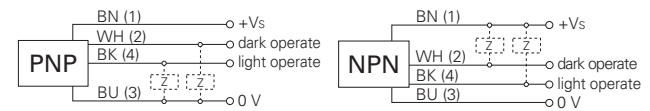

order reference	actual range Sb	sensing distance Tw	response time / release time	current consumption max. (no load)	current consumption typ.	output circuit
<b>FZAM 30N5004</b>	1400 mm	230 mm	< 2,5 ms	50 mA	33 mA	NPN
<b>FZAM 30P5001</b>	600 mm	110 mm	< 0,25 ms	40 mA	30 mA	PNP
<b>FZAM 30P5004</b>	1400 mm	230 mm	< 2,5 ms	50 mA	33 mA	PNP

FZAM 30 Sb = 1400 mm, Tw = 230 mm

Glass fiber optic sensors

# Glass fiber optics for Series 18, 30

## Reflective types

Series 18  
20-turn pot.

Series 18  
Side mounted pot.  
Teach-in

Series 30  
Fast version

Series 30  
Extended Tw

Fiber diameter 2 x 0,5 mm <sup>2</sup>		Part number	Tw = sensing distance [mm]
Sheath material: PVC ø 2,5 mm (FUE ...)	Sheath material: brass chromium plated ø 4 mm (FUF ...)		
	 * can not be bent	<b>FUE 050A2004</b> <b>FUF 050A2004</b> (length 50 cm)	10 20 15 35
	 * can not be bent	<b>FUE 100A2004</b> <b>FUF 100A2004</b> (length 100 cm)	5 20 15 30
	 * can not be bent	<b>FUE 050A2003</b> <b>FUF 050A2005</b> (length 50 cm)	10 20 15 35
	 * can not be bent	<b>FUE 100A2003</b> <b>FUF 100A2005</b> (length 100 cm)	5 20 15 30
	 * can not be bent	<b>FUE 050A1003</b> <b>FUF 050A1005</b> (length 50 cm)	10 20 15 35
	 * can not be bent	<b>FUE 100A1003</b> <b>FUF 100A1005</b> (length 100 cm)	5 20 15 30
		<b>FUE 050A4004</b> <b>FUF 050A4004</b> (length 50 cm)	10 20 15 35
		<b>FUE 100A4004</b> <b>FUF 100A4004</b> (length 100 cm)	5 20 15 30
Fiber diameter 2 x 1 mm <sup>2</sup>		Part number	Tw = sensing distance [mm]
Sheath material: PUR ø 4,5 mm (FUE ...)	Sheath material: brass chromium plated ø 5 mm (FUF ...)		
		<b>FUE 050A2002</b> <b>FUF 050A2007</b> (length 50 cm)	15 40 30 70
		<b>FUE 100A2002</b> <b>FUF 100A2007</b> (length 100 cm)	15 40 30 60
		<b>FUE 050A1002</b> <b>FUF 050A1007</b> (length 50 cm)	15 40 30 70
		<b>FUE 100A1002</b> <b>FUF 100A1007</b> (length 100 cm)	15 40 30 60
		<b>FUE 050A4005</b> <b>FUF 050A4005</b> (length 50 cm)	15 40 30 70
		<b>FUE 100A4005</b> <b>FUF 100A4005</b> (length 100 cm)	15 40 30 60
Fiber diameter 2 x 0,5 mm <sup>2</sup>		Part number	Tw = sensing distance [mm]
Sheath material: Chrome-nickel-steel ø 2 mm FUH 010A2002			
		<b>FUH 010A2002</b> (length 10 cm)	10 20 15 35

Reflective types

Glass fiber optics

# Glass fiber optics for Series 18, 30

## Reflective types

Series 18  
20-turn pot.

Series 18  
Side mounted pot.  
Teach-in

Series 30  
Fast version

Series 30  
Extended Tw

Fiber diameter 2 x 2 mm <sup>2</sup>		Part number	Tw = sensing distance [mm]
Sheath material: PUR ø 4,5 mm (FUE ...)	Sheath material: brass chromium plated ø 5 mm (FUF ...)		
		<b>FUE 050A2011</b> <b>FUF 050A2011</b> (length 50 cm)	35 80 60 115
		<b>FUE 100A2011</b> <b>FUF 100A2011</b> (length 100 cm)	35 80 60 115
		<b>FUE 050A4003</b> <b>FUF 050A4002</b> (length 50 cm)	35 80 60 115
		<b>FUE 100A4003</b> <b>FUF 100A4002</b> (length 100 cm)	35 80 60 115
Fiber diameter 2 x 3 mm <sup>2</sup>		Part number	Tw = sensing distance [mm]
Sheath material: PUR ø 6 mm (FUE ...)	Sheath material: brass chromium plated ø 6 mm (FUF ...)		
		<b>FUE 050A2008</b> <b>FUF 050A2003</b> (length 50 cm)	60 150 100 210
		<b>FUE 100A2008</b> <b>FUF 100A2003</b> (length 100 cm)	55 150 100 200
		<b>FUE 050A1008</b> <b>FUF 050A1003</b> (length 50 cm)	60 150 100 210
		<b>FUE 100A1008</b> <b>FUF 100A1003</b> (length 100 cm)	55 150 100 200
		<b>FUE 050A3001</b> <b>FUF 050A3001</b> (length 50 cm)	60 150 100 210
		<b>FUE 100A3001</b> <b>FUF 100A3001</b> (length 100 cm)	55 150 100 200
Fiber diameter 2 x 4 mm <sup>2</sup>		Part number	Tw = sensing distance [mm]
Sheath material: PUR ø 6 mm (FUE ...)	Sheath material: brass chromium plated ø 6 mm (FUF ...)		
		<b>FUE 050A2001</b> <b>FUF 050A2001</b> (length 50 cm)	60 150 110 230
		<b>FUE 100A2001</b> <b>FUF 100A2001</b> (length 100 cm)	60 150 100 220
		<b>FUE 050A1001</b> <b>FUF 050A1001</b> (length 50 cm)	60 150 110 230
		<b>FUE 100A1001</b> <b>FUF 100A1001</b> (length 100 cm)	60 150 100 220

Reflective types

Glass fiber optics

# Glass fiber optics for Series 18, 30

## Through beam types

Series 18  
20-turn pot.

Series 18  
Side mounted pot.  
Teach-in

Series 30  
Fast version

Series 30  
Extended Sb

Fiber diameter 2 x 1 mm <sup>2</sup>		Part number	Sb = actual range [mm]
Sheath material: PVC ø 2,5 mm (FSE ...)	Sheath material: brass chromium plated ø 4 mm (FSF ...)		
		<b>FSE 050A2002</b> <b>FSF 050A2004</b> (length 50 cm)	90 270 200 450
	* can not be bent	<b>FSE 100A2002</b> <b>FSF 100A2004</b> (length 100 cm)	90 250 190 500
		<b>FSE 050A2001</b> <b>FSF 050A2005</b> (length 50 cm)	90 270 200 450
	* can not be bent	<b>FSE 100A2001</b> <b>FSF 100A2005</b> (length 100 cm)	90 250 190 500
		<b>FSE 050A1001</b> <b>FSF 050A1005</b> (length 50 cm)	90 270 200 450
	* can not be bent	<b>FSE 100A1001</b> <b>FSF 100A1005</b> (length 100 cm)	90 250 190 500
		<b>FSE 050A4003</b> <b>FSF 050A4003</b> (length 50 cm)	90 270 200 450
		<b>FSE 100A4003</b> <b>FSF 100A4003</b> (length 100 cm)	90 250 190 500
Fiber diameter 2 x 2 mm <sup>2</sup>		Part number	Sb = actual range [mm]
Sheath material: PUR ø 4,5 mm (FSE ...)	Sheath material: brass chromium plated ø 5 mm (FSF ...)		
		<b>FSE 050A2006</b> <b>FSF 050A2002</b> (length 50 cm)	180 450 380 450
		<b>FSE 100A2006</b> <b>FSF 100A2002</b> (length 100 cm)	170 500 370 860
		<b>FSE 050A1006</b> <b>FSF 050A1002</b> (length 50 cm)	180 450 380 450
		<b>FSE 100A1006</b> <b>FSF 100A1002</b> (length 100 cm)	170 500 370 860
		<b>FSE 050A4006</b> <b>FSF 050A4002</b> (length 50 cm)	180 450 380 450
		<b>FSE 100A4006</b> <b>FSF 100A4002</b> (length 100 cm)	170 500 370 860



# Glass fiber optics for Series 18, 30

## Through beam types

Series 18  
20-turn pot.

Series 18  
Side mounted pot.  
Teach-in

Series 30  
Fast version

Series 30  
Extended Sb

Fiber diameter 2 x 4 mm <sup>2</sup>		Part number	Sb = actual range [mm]
Sheath material: PVC ø 4 mm (FSE ...)	Sheath material: brass chromium plated ø 5 mm (FSF ...)		
		<b>FSE 050A2003</b> <b>FSF 050A2001</b> (length 50 cm)	310 500 500 500
		<b>FSE 100A2003</b> <b>FSF 100A2001</b> (length 100 cm)	300 800 600 1400
		<b>FSE 050A1003</b> <b>FSF 050A1001</b> (length 50 cm)	310 500 500 500
		<b>FSE 100A1003</b> <b>FSF 100A1001</b> (length 100 cm)	300 800 600 1400
		<b>FSE 050A4004</b> <b>FSF 050A4004</b> (length 50 cm)	310 500 500 500
		<b>FSE 100A4004</b> <b>FSF 100A4004</b> (length 100 cm)	300 800 600 1400

## Arrays (for Series 18 only)

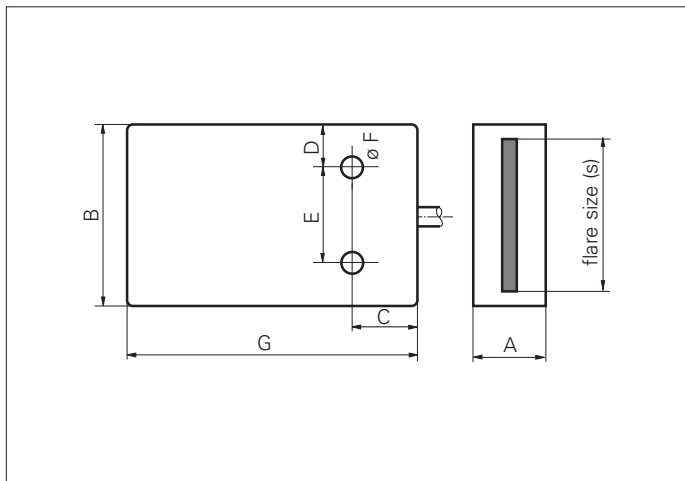

Part number	Sb = actual range [mm]
<b>FSE 050A3020</b> <b>FSE 050A3020</b> (length 50 cm)	310 500
<b>FSF 100A3020</b> <b>FSE 100A3020</b> (length 100 cm)	310 800
<b>FSF 050A3021</b> <b>FSF 050A3022</b> (length 50 cm)	350 500
<b>FSF 100A3021</b> <b>FSF 100A3022</b> (length 100 cm)	350 900

flare size s	dimensions mm							part number
	A	B	C	D	E	F	G	
8 mm	10	10	-	-	-	-	25	FSF 050A3020 FSF 100A3020
8 mm	10	10	-	-	-	-	25	FSE 050A3020 FSE 100A3020
20 mm	10	25	9	6.5	12	3,2	40	FSF 050A3021 FSF 100A3021
35 mm	12	40	12	7.5	25	4,2	50	FSF 050A3022 FSF 100A3022
metal sheath (FSF...)								length 50 cm length 100 cm
plastic sheath (FSE...) (PUR)								length 50 cm length 100 cm

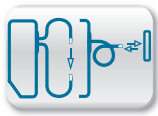

**S<sub>b</sub> = 1200 mm**  
**Tw = 240 mm**

- sensitivity adjustable via potentiometer
- fast version available
- rugged metal housing

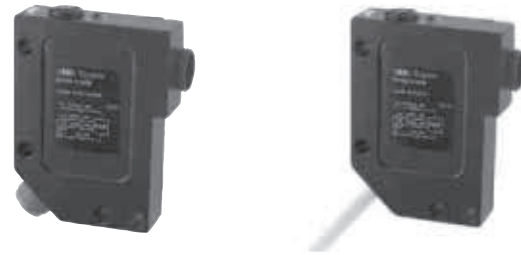

**general data**

actual range S <sub>b</sub>	1200 mm
sensing distance Tw	240 mm
light source	pulsed infrared diode
light indicator	LED yellow
alignment / soiled lens indicator	LED, flashing
adjustment	potentiometer, 20 turn
wave length	880 nm
suppression of reciprocal influence	yes

**electrical data**

voltage supply range +Vs	10 ... 30 VDC
voltage drop V <sub>d</sub>	< 1,8 VDC
output function	light / dark operate
output current	< 200 mA
short circuit protection	yes
reverse polarity protection	yes

**mechanical data**

width / diameter	15 mm
height / length	60 mm
depth	45 mm
type	rectangular
housing material	die-cast aluminum

**ambient conditions**

operating temperature	-25 ... +65 °C
protection class	IP 65

**connectors and mating connectors**

ESG 34AH0200	Connector M12, 4 pin, straight, 2 m
ESW 33AH0200	Connector M12, 4 pin, angular, 2 m
additional cable connectors and field wireable connectors: see accessories	

**Accessories**

10103415	Mounting bracket series 15 (L design)
10103230	Cap nut (replace) for fiber optics series 15

for details: see accessories section

**dimension drawings**

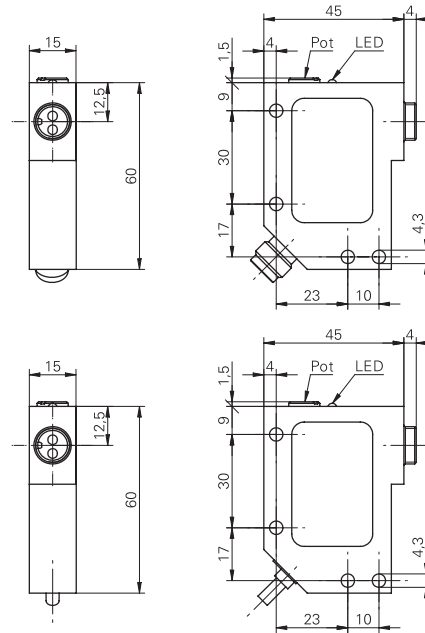

**connection diagrams**



order reference	response time / release time	current consumption max. (no load)	current consumption typ.	output circuit	connection types
FVDM 15N5103	< 1 ms	46 mA	30 mA	NPN	cable 4 pin, 2 m
FVDM 15N5103/S14	< 1 ms	46 mA	30 mA	NPN	connector M12 4 pin
FVDM 15P5103	< 1 ms	46 mA	30 mA	PNP	cable 4 pin, 2 m
FVDM 15P5103/S14	< 1 ms	46 mA	30 mA	PNP	connector M12 4 pin
FVDM 15P5130	< 0,1 ms	60 mA	50 mA	PNP	cable 4 pin, 2 m
FVDM 15P5130/S14	< 0,1 ms	60 mA	50 mA	PNP	connector M12 4 pin

# Glass fiber optics for Series 15

## Reflective types

Fiber diameter 2 x 0,5 mm <sup>2</sup>		Part number	TW = sensing distance [mm]
Sheath material: PVC ø 2,5 mm (FUE ...)	Sheath material: brass chromium plated ø 4 mm (FUF ...)		
		FUE 025B2004 FUF 025B2004 (length 25 cm)	25
		FUE 050B2004 FUF 050B2004 (length 50 cm)	25
		FUE 025B2003 FUF 025B2003 (length 25 cm)	25
		FUE 050B2003 FUF 050B2003 (length 50 cm)	25
		FUE 025B1003 FUF 025B1003 (length 25 cm)	25
		FUE 050B1003 FUF 050B1003 (length 50 cm)	25
		FUE 025B4003 FUF 025B4006 (length 25 cm)	25
		FUE 050B4003 FUF 050B4006 (length 50 cm)	25
Fiber diameter 2 x 1 mm <sup>2</sup>		Part number	TW = sensing distance [mm]
Sheath material: PUR ø 4,5 mm (FUE ...)	Sheath material: brass chromium plated ø 5 mm (FUF ...)		
		FUE 025B2002 FUF 025B2005 (length 25 cm)	60
		FUE 050B2002 FUF 050B2005 (length 50 cm)	60
		FUE 025B1002 FUF 025B1005 (length 25 cm)	60
		FUE 050B1002 FUF 050B1005 (length 50 cm)	60
		FUE 025B4005 FUF 025B4008 (length 25 cm)	60
		FUE 050B4005 FUF 050B4008 (length 50 cm)	60
Fiber diameter 2 x 0,5 mm <sup>2</sup>	Fiber diameter 2 x 1 mm <sup>2</sup>	Part number	TW = sensing distance [mm]
Sheath material: Chrome-nickel-steel ø 2 mm FUH 010B2002	Sheath material: Chrome-nickel-steel ø 3 mm FUH 010B2001		
		FUH 010B2002 (length 10 cm)	25
		FUH 010B2001 (length 10cm)	60

# Glass fiber optics for Series 15

## Reflective types

Series 15

Fiber diameter 2 x 2 mm <sup>2</sup>		Part number	TW = sensing distance [mm]
Sheath material: PUR $\varnothing$ 4,5 mm (FUE ...)	Sheath material: brass chromium plated $\varnothing$ 5 mm (FUF ...)		
		FUE 025B2011 FUF 025B2011 (length 25 cm)	110
		FUE 050B2011 FUF 050B2011 (length 50 cm)	100
		FUE 025B1011 FUF 025B1011 (length 25 cm)	110
		FUE 050B1011 FUF 050B1011 (length 50 cm)	100
		FUE 025B4004 FUF 025B4002 (length 25 cm)	110
		FUE 050B4004 FUF 050B4002 (length 50 cm)	100
Fiber diameter 2 x 3 mm <sup>2</sup>		Part number	TW = sensing distance [mm]
Sheath material: PUR $\varnothing$ 6 mm (FUE ...)	Sheath material: brass chromium plated $\varnothing$ 6 mm (FUF ...)		
		FUE 025B2008 FUF 025B2002 (length 25 cm)	210
		FUE 050B2008 FUF 050B2002 (length 50 cm)	200
		FUE 025B1008 FUF 025B1002 (length 25 cm)	210
		FUE 050B1008 FUF 050B1002 (length 50 cm)	200
		FUE 025B3001 FUF 025B3001 (length 25 cm)	210
		FUE 050B3001 FUF 050B3001 (length 50 cm)	200
Fiber diameter 2 x 4 mm <sup>2</sup>		Part number	TW = sensing distance [mm]
Sheath material: PUR $\varnothing$ 6 mm (FUE ...)	Sheath material: brass chromium plated $\varnothing$ 6 mm (FUF ...)		
		FUE 025B2001 FUF 025B2001 (length 25 cm)	240
		FUE 050B2001 FUF 050B2001 (length 50 cm)	230
		FUE 025B1001 FUF 025B1001 (length 25 cm)	240
		FUE 050B1001 FUF 050B1001 (length 50 cm)	230

Reflective types

Glass fiber optics

# Glass fiber optics for Series 15

## Through beam types

Series 15

Fiber diameter 2 x 1 mm <sup>2</sup>		Part number	Sb = actual range [mm]
Sheath material: PVC ø 2,5 mm (FSE ...)	Sheath material: brass chromium plated ø 4 mm (FSF ...)		
		FSE 025B2002 FSF 025B2002 (length 25 cm)	140
	* can not be bent	FSE 050B2002 FSF 050B2002 (length 50 cm)	320
		FSE 025B2001 FSF 025B2005 (length 25 cm)	140
	* can not be bent	FSE 050B2001 FSF 050B2005 (length 50 cm)	320
		FSE 025B1001 FSF 025B1005 (length 25 cm)	140
	* can not be bent	FSE 050B1001 FSF 050B1005 (length 50 cm)	320
		FSE 025B4003 FSF 025B4003 (length 25 cm)	140
		FSE 050B4003 FSF 050B4003 (length 50 cm)	320
Fiber diameter 2 x 2 mm <sup>2</sup>		Part number	Sb = actual range [mm]
Sheath material: PUR ø 4,5 mm (FSE ...)	Sheath material: brass chromium plated ø 5 mm (FSF ...)		
		FSE 025B2006 FSF 025B2006 (length 25 cm)	160
		FSE 050B2006 FSF 050B2006 (length 50 cm)	450
		FSE 025B1007 FSF 025B1007 (length 25 cm)	160
		FSE 050B1007 FSF 050B1007 (length 50 cm)	450
		FSE 025B4006 FSF 025B4002 (length 25 cm)	160
		FSE 050B4006 FSF 050B4002 (length 50 cm)	450

Through beam types

Glass fiber optics

# Glass fiber optics for Series 15

## Through beam types

Series 15

Fiber diameter 2 x 4 mm <sup>2</sup>		Part number	Sb = actual range [mm]
Sheath material: PVC ø 4 mm (FSE ...)	Sheath material: brass chromium plated ø 5 mm (FSF ...)		
		<b>FSE 025B2003</b> <b>FSF 025B2001</b> (length 25 cm)	160
		<b>FSE 050B2003</b> <b>FSF 050B2001</b> (length 50 cm)	500
		<b>FSE 025B1003</b> <b>FSF 025B1001</b> (length 25 cm)	160
		<b>FSE 050B1003</b> <b>FSF 050B1001</b> (length 50 cm)	500
		<b>FSE 025B4004</b> <b>FSF 025B4004</b> (length 25 cm)	160
		<b>FSE 050B4004</b> <b>FSF 050B4004</b> (length 50 cm)	500



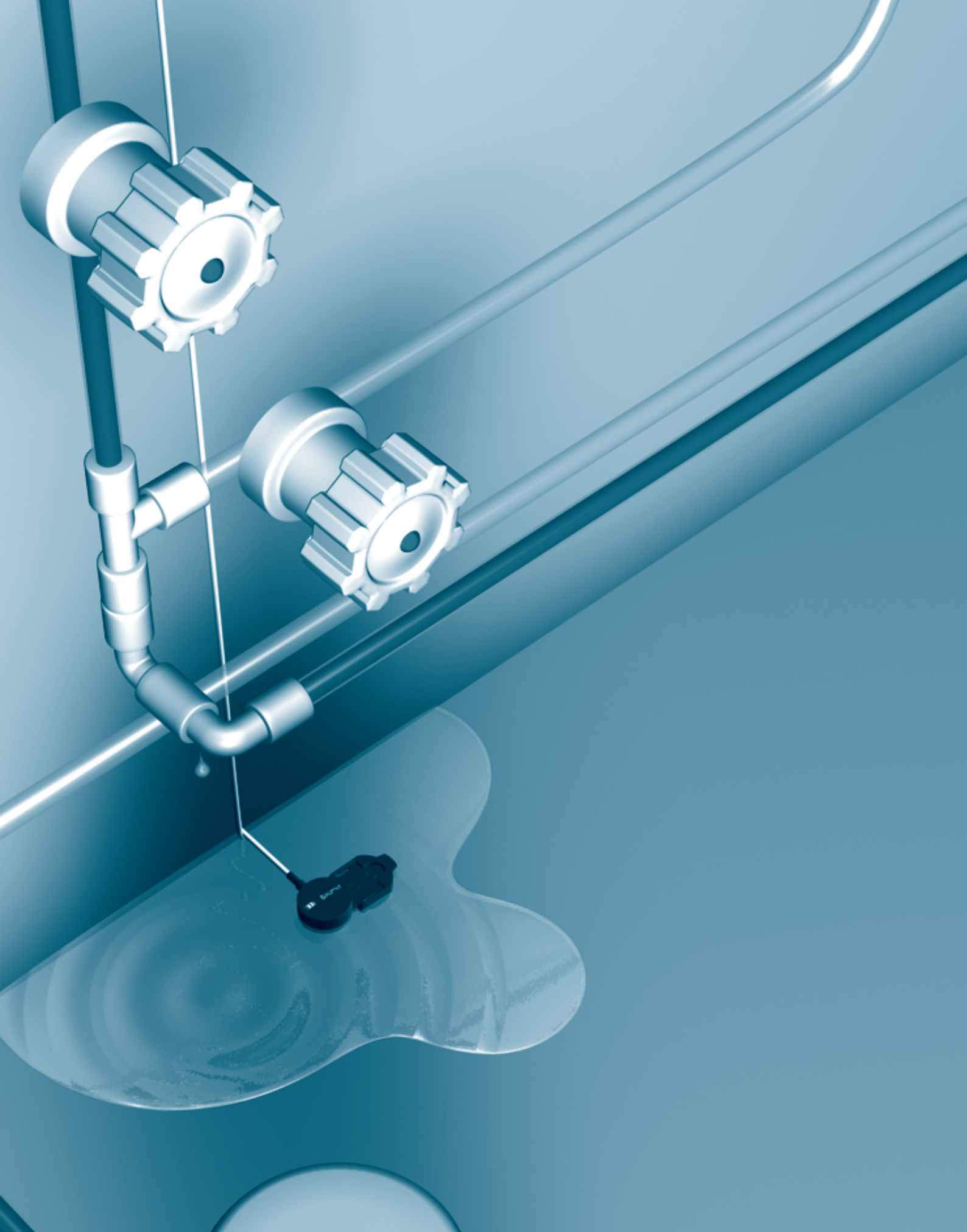



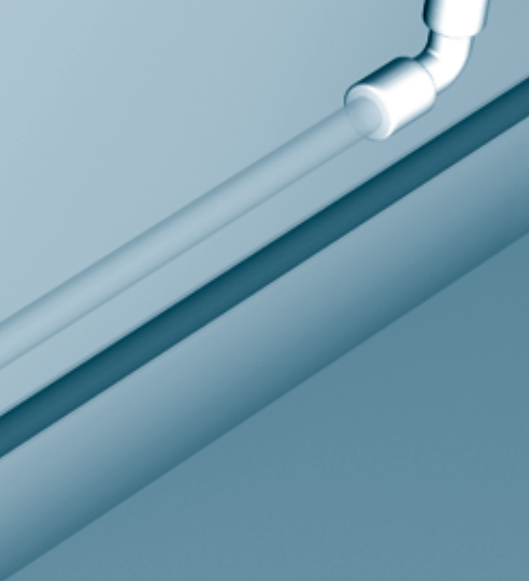







## Level monitoring and leak detecting sensors

Overview	Page 552
Introduction	Page 554
Level monitoring sensors	Page 557
Leak detecting sensors	Page 563
Diverse	Page 564

product family	FFAK 17	FFAK 17	FFAK 16	FFAM 17	FFAM 16	FFDK 16	FODK 23
							
type	liquid level sensor	liquid level sensor	liquid level sensor	liquid level sensor	liquid level sensor	liquid level sensor	Leakage sensor
width / diameter	30 mm	30 mm	30 mm	30 mm	30 mm	16 mm	23 mm
response time / release time						< 2 ms	< 1 ms
light source	pulsed infrared diode	pulsed infrared diode	pulsed infrared diode	pulsed infrared diode	pulsed infrared diode	pulsed infrared diode	pulsed red LED
sensitivity adjustment	no	potentiometer, 15 turn	no	potentiometer, 15 turn	potentiometer, 15 turn	no	no
output circuit	NPN PNP	NPN PNP	NPN PNP	PNP	PNP	PNP	PNP
connection types	cable	cable	cable	cable	cable	cable	cable
thread	G 3/8"	G 3/8"	M16x1 mm	G 3/8"	M16x1 mm		
housing material	plastic	plastic	plastic	metal	metal	plastic	plastic
<b>page</b>	<b>557</b>	<b>558</b>	<b>559</b>	<b>560</b>	<b>561</b>	<b>562</b>	<b>563</b>





## General information

With photoelectric level monitoring and leak sensors, liquids can be easily and reliably detected without the need of an electrical connection or mechanical movement between the liquid and the sensor. There are two possible principles of detection: the sensor is in direct contact with the liquid or it is fastened to a hose or stand pipe to detect the level without contact. The available fiber optic versions permit level and leak control in constricted surroundings and even in hazardous zones.

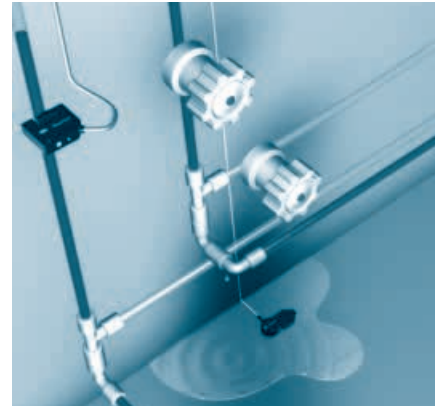

## Typical applications

The chemical resistance of the sensors permits versatile applications:

- Level monitoring of liquids such as
  - acetone
  - acids, e.g. hydrochloric, sulfuric or battery acid
  - alkalis
  - mineral oil
  - milk
  - all non-conductive liquids
- Contact free level detection in (semi) transparent hoses and stand pipes
- Detection of the minimum and maximum levels in trays and tanks
- Leak monitoring of oil trays or lubricant tanks
- Monitoring of leaked liquids in dispensers and other liquid handling systems

## Characteristics and advantages of level monitoring sensors

### Chemical resistance

The sensor housings are made of polysulfonide or stainless steel and are resistant to certain liquids.

### Detectable media

As optical light is used to detect the liquid, various and non-conductive liquids can be detected.

### Simple commissioning

It is unnecessary to adjust sensors with integrated electronics. With fiber optics, the adjustment is made via a fiber optic sensor.

### Hazardous environments

The intrinsically safe fiber optic version with PFA coating can also be used in hazardous environments.

## Characteristics and advantages of leak sensors

### Detectable media

As optical light is used to detect the liquid, various and non-conductive liquids can be detected. Typically, 1ml of leaked liquid is sufficient to initiate an alarm.

### Failsafe facility

The integrated failsafe facility triggers an alarm on leaks, cable rupture, detachment from the fastening or if the sensor is defective.

### Hazardous environments

The intrinsically safe fiber optic version with PFA coating can also be used in hazardous environments.



## Technology and operation

### Level monitoring and leak sensors in contact with the liquid

The operating principles of both types of sensor are shown in the sketch below. The critical angle for total reflection changes depending on whether the sensor tip is surrounded by water or air. If the sensor tip is surrounded by a liquid, the light beam is refracted by the liquid and the sensor output changes its state. The liquid medium may be electrically conductive, turbid or clear. The same operating principle is employed for the leak sensors. Only the volume of the liquid is different. Typically, as little as 1 ml of a liquid can be detected.

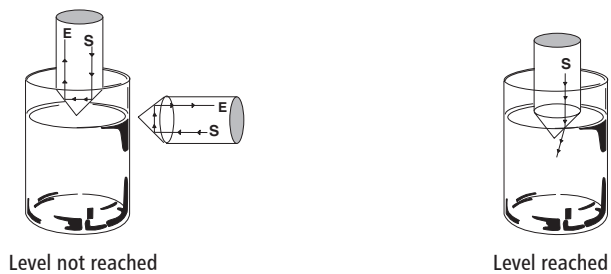

### Level monitoring sensors without contact with the liquid

The level monitoring sensors for hose or stand pipe mounting operate by a similar principle. For example, the FFDK 16 also exploits the refractive properties of liquids. In a state without the liquid, the emitted light (A) impinges directly on the receiver (B). If the liquid enters the detection range, a part of the emitted light is refracted, so that less light impinges on the receiver. This change in the light can be assessed by the sensor.

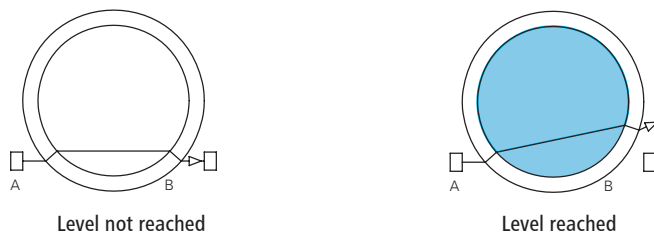

With the fiber optic version FSL 500C6Y00, the principle is exactly the opposite. In a state without the liquid, no light impinges on the receiver (B). It is only when liquid enters the detection range of the array that a part of the emitted light (A) is diverted to the receiver (B). This change in the light can be assessed by the receiver. The advantage of the array configuration with a monitoring range of approx. 5 mm is that interference caused by foam and small air bubbles can be suppressed by a powerful fiber optic sensor.

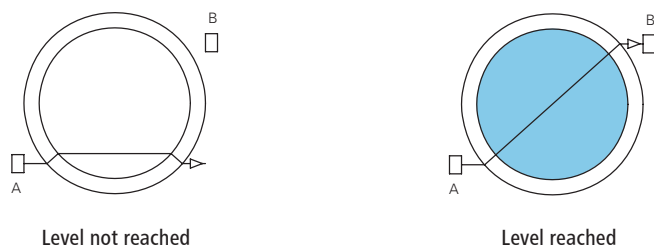



### Mounting and adjustment

#### Level monitoring sensors for hose/stand pipe mounting:

The sensors can very easily be attached to a hose or stand pipe with cable ties. A separate bracket or other holder is unnecessary. No adjustments must be made to the FFDK 16 with integrated electronics. It is only necessary to choose between light and dark switching. With the fiber optic version FSL, the adjustment is made via a fiber optic sensor.

#### Leak sensors:

The leak sensors can be screwed directly to the floor or on a base. No adjustments must be made to the sensor FODK 23. With the fiber optic version FOC, the adjustment is made via a fiber optic sensor. The sensors can be very easily released from their holders for cleaning purposes.

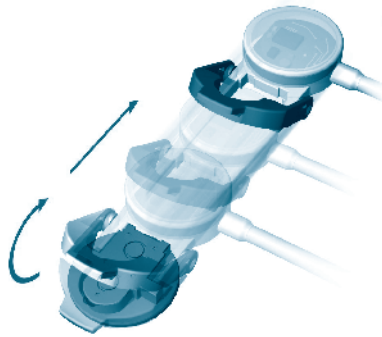



- chemical resistance
- up to 10 bar nominal pressure



### general data

type	liquid level sensor
light source	pulsed infrared diode
nominal pressure (probe tip)	10 bar
output indicator	LED yellow
sensitivity adjustment	no
wave length	880 nm
measurement type	contact with medium

### electrical data

voltage supply range +Vs	10 ... 30 VDC
current consumption max. (no load)	15 mA
voltage drop Vd	< 2 VDC
output function	normally open (NO)
output current	< 200 mA
short circuit protection	no
reverse polarity protection	yes, Vs to GND

### mechanical data

width / diameter	30 mm
height / length	81 mm
thread	G 3/8"
type	cylindrical
material (sensing device)	polysulphone
housing material	polysulphone
connection types	cabl 3 pin, 2 m

### ambient conditions

operating temperature	0 ... +65 °C
protection class	IP 67

### order reference      output circuit

FFAK 17NTD1001/L	NPN
FFAK 17PTD1001/L	PNP

### dimension drawing

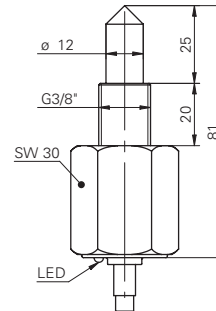

### connection diagrams

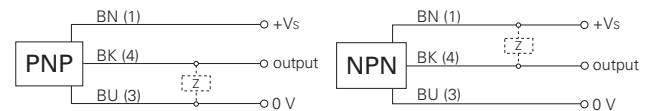

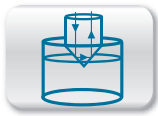

- sensitivity adjustable
- chemical resistance
- up to 10 bar nominal pressure



### general data

type	liquid level sensor
light source	pulsed infrared diode
nominal pressure (probe tip)	10 bar
output indicator	LED yellow
sensitivity adjustment	potentiometer, 15 turn
wave length	880 nm
measurement type	contact with medium

### electrical data

voltage supply range +Vs	10 ... 30 VDC
current consumption max. (no load)	15 mA
voltage drop Vd	< 2 VDC
output function	normally open (NO)
output current	< 200 mA
short circuit protection	no
reverse polarity protection	yes, Vs to GND

### mechanical data

width / diameter	30 mm
height / length	81,5 mm
thread	G 3/8"
type	cylindrical
material (sensing device)	polysulphone
housing material	polysulphone
connection types	connection types

### ambient conditions

operating temperature	0 ... +65 °C
protection class	IP 67

### order reference

FFAK 17NTD1002/L	NPN
FFAK 17PTD1002/L	PNP

### output circuit

### dimension drawing

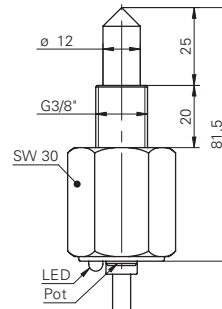

### connection diagrams

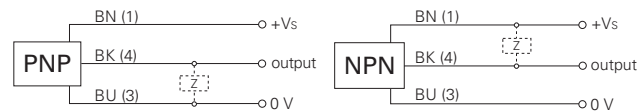





- with thread M16x1
- chemical resistance
- up to 10 bar nominal pressure



### general data

type	liquid level sensor
light source	pulsed infrared diode
nominal pressure (probe tip)	10 bar
output indicator	LED yellow
sensitivity adjustment	no
wave length	880 nm
measurement type	contact with medium

### electrical data

voltage supply range +Vs	10 ... 30 VDC
current consumption max. (no load)	15 mA
voltage drop Vd	< 2 VDC
output function	normally open (NO)
output current	< 200 mA
short circuit protection	no
reverse polarity protection	yes, Vs to GND

### mechanical data

width / diameter	30 mm
height / length	81 mm
thread	M16x1 mm
type	cylindrical
material (sensing device)	polysulphone
housing material	polysulphone
connection types	cable 3 pin, 2 m

### ambient conditions

operating temperature	0 ... +65 °C
protection class	IP 67

order reference	output circuit
-----------------	----------------

FFAK 16NTD1001/L	NPN
FFAK 16PTD1001/L	PNP

### dimension drawing

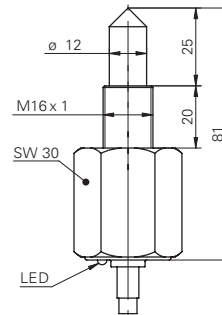

### connection diagrams

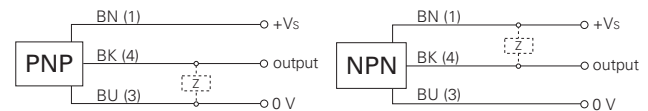

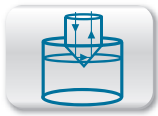

- rugged metal housing
- chemical resistance
- up to 40 bar nominal pressure

### general data

type	liquid level sensor
light source	pulsed infrared diode
nominal pressure (probe tip)	40 bar
output indicator	LED yellow
sensitivity adjustment	potentiometer, 15 turn
wave length	880 nm
measurement type	contact with medium

### electrical data

voltage supply range +Vs	10 ... 30 VDC
current consumption max. (no load)	15 mA
voltage drop Vd	< 2 VDC
output function	normally open (NO)
output circuit	PNP
output current	< 200 mA
short circuit protection	no
reverse polarity protection	yes, Vs to GND

### mechanical data

width / diameter	30 mm
height / length	66,5 mm
thread	G 3/8"
type	cylindrical
material (sensing device)	glass (borosilicate)
housing material	stainless steel DIN 1.4305/AISI 303
connection types	cabl 3 pin, 2 m

### ambient conditions

operating temperature	0 ... +65 °C
protection class	IP 67

### order reference

**FFAM 17PTD1002/L**

### dimension drawing

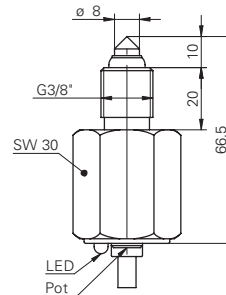

### connection diagram

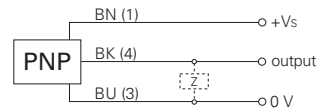



- with thread M16x1
- rugged metal housing
- up to 40 bar nominal pressure



### general data

type	liquid level sensor
light source	pulsed infrared diode
nominal pressure (probe tip)	40 bar
output indicator	LED yellow
sensitivity adjustment	potentiometer, 15 turn
wave length	880 nm
measurement type	contact with medium

### electrical data

voltage supply range +Vs	10 ... 30 VDC
current consumption max. (no load)	15 mA
voltage drop Vd	< 2 VDC
output function	normally open (NO)
output circuit	PNP
output current	< 200 mA
short circuit protection	no
reverse polarity protection	yes, Vs to GND

### mechanical data

width / diameter	30 mm
height / length	66,5 mm
thread	M16x1 mm
type	cylindrical
material (sensing device)	glass (borosilicate)
housing material	stainless steel DIN 1.4305/AISI 303
connection types	cable 3 pin, 2 m

### ambient conditions

operating temperature	0 ... +65 °C
protection class	IP 67

### order reference

**FFAM 16PTD1002/L**

### dimension drawing

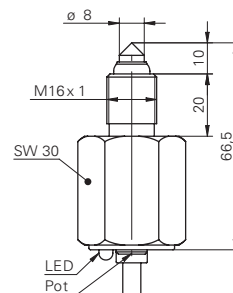

### connection diagram

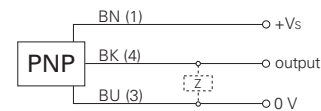

- liquid level sensor for pipe mounting
- pipe diameter from 3 ... 13 mm
- easy setup - no adjustment necessary



### general data

type	liquid level sensor
light source	pulsed infrared diode
output indicator	LED red
sensitivity adjustment	no
wave length	950 nm
max. thickness of the pipe / tube	1 mm

### electrical data

response time / release time	< 2 ms
current consumption max. (no load)	25 mA
voltage drop Vd	< 1 VDC
output function	light / dark operate switchable
output circuit	PNP
output current	< 100 mA
short circuit protection	yes
reverse polarity protection	yes

### mechanical data

width / diameter	16 mm
height / length	28 mm
depth	26 mm
type	rectangular
housing material	PC
connection types	connection types cable 3 pin, 2 m

### ambient conditions

operating temperature	-10 ... +55 °C
protection class	IP 50

### dimension drawing

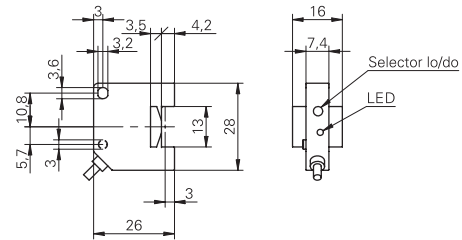

### connection diagram

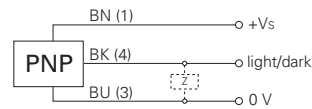

order reference	voltage supply range +Vs	max. outer diameter of the pipe / tube
FFDK 16P50Y0	9 ... 30,8 VDC	8 ... 13 mm
FFDK 16P50Y5	10 ... 30 VDC	3 ... 7 mm

- leakage sensor with integrated electronics
- detects liquid amounts of approx. 1 ml
- chemical resistance thanks to PFA sheath

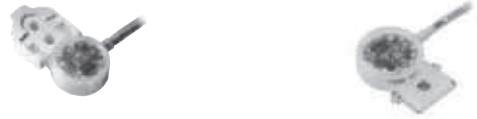

### general data

type	Leakage sensor
light source	pulsed red LED
output indicator	LED orange
light indicator	LED green
sensitivity adjustment	no
wave length	875 nm
measurement type	contact with medium

### electrical data

response time / release time	< 1 ms
voltage supply range +Vs	12 ... 24 VDC
current consumption max. (no load)	30 mA
voltage drop Vd	< 1 VDC
output function	normally closed (NC)
output circuit	PNP
output current	< 50 mA
short circuit protection	yes
reverse polarity protection	yes

### mechanical data

width / diameter	23 mm
height / length	10,5 mm
depth	37,2 mm
type	rectangular
material (sensing device)	PFA

### ambient conditions

operating temperature	-25 ... +50 °C
protection class	IP 67

order reference	housing material	connection types
FODK 23P90Y0	PFA / PVC	cable 3 pin, 2 m
FODK 23P90Y0/0500	PFA / PVC	cable 3 pin, 5 m
FODK 23P90Y5	PFA	cable 3 pin, 2 m

### dimension drawings

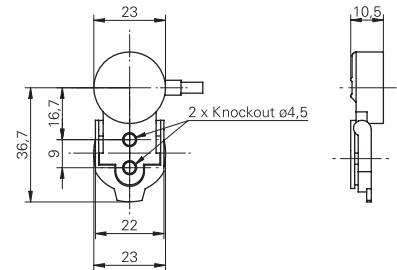

FODK 23P90Y0...

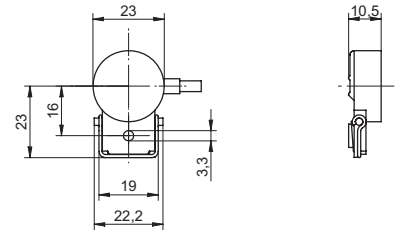

FODK 23P90Y5

### connection diagram

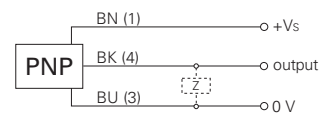

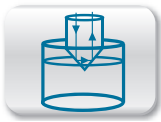

**Fiber optic level sensor FUL**

- the special sensor tip prevents drop formation
- high chemical resistance

general data	
type	liquid level sensor
optical fiber length	2 m / 5 m
mechanical data	
min. bending radius	30 mm
tensile strength	5 N
optical fiber material	PFA
ambient conditions	
operating temperature	-30 ... +105 °C
order reference	
<b>FUL 200D2Y00</b>	(use with fiber optic sensor FVDK 66 / FVDK 67)
<b>FUL 500D2Y00</b>	(use with fiber optic sensor FVDK 66 / FVDK 67)

**dimension drawing**

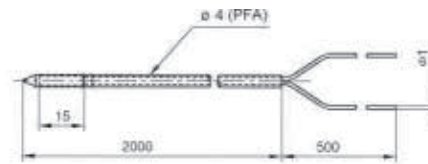

R = 15 mm / 30 mm tip to 40 mm length

**Fiber optic level sensor for stand pipe mounting FSL**

- fine light curtain suppresses foam/air bubbles
- diameter of the pipe/tube 3 ... 13 mm

general data	
type	liquid level sensor
optical fiber length	5 m
max. outer diameter of the pipe/tube	3 ... 13 mm
max. thickness of the pipe/tube	1 mm
mechanical data	
min. bending radius	4 mm
tensile strength	20 N
optical fiber material	PMMA, PFA coated
housing material	PEI / PC
ambient conditions	
operating temperature	-30 ... +70 °C
order reference	
<b>FSL 500C6Y00</b>	(use with fiber optic sensor FVDK 66 / FVDK 67)

**dimension drawing**

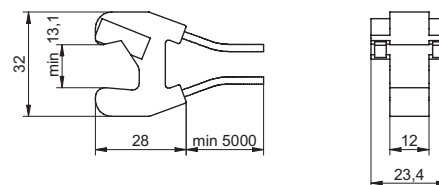

**Fiber optic leak sensor FOC**

- detects typical liquid volumes of 1 ml
- high chemical resistance

general data	
type	leakage sensor
optical fiber length	5 m
mechanical data	
min. bending radius	20 mm
tensile strength	10 N
optical fiber material	PE, PFA coated
housing material	PFA
ambient conditions	
operating temperature	-30 ... +70 °C
order reference	
<b>FOC 500C6Y00</b>	(use with fiber optic sensor FVDK 66 / FVDK 67)

**dimension drawing**

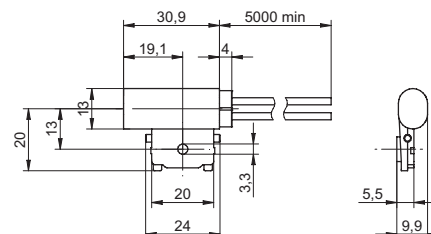





**Baumer**  
CH-8501 Frauenfeld

FLDK 110G 1006/S14

Complies with 21CFR 1040.10 and 1040.11



AVOID EXPOSURE  
Laser radiation is emitted  
from this aperture



CAUTION

SCATEC-2

SWISS CHOCOLATE  
8 Stück  
Schokoküsse

SWISS CHOCOLATE  
8 Stück  
Schokoküsse





SWISS CHOCOLATE  
8 Stück  
Schokoküsse







## Edge measurement and detection

Web edge measurement independent of radial and axial runout	Page 572
Edge detection with wide measuring field	Page 576
Edge measurement by parallel light beam	Page 584
Copy counters <i>SCATEC</i>	Page 590

product family	OXE7	ZADM 023	ZADM 023	ZADM 034
				
	<i>PosCon</i>			<i>ParCon</i>
type	measuring mode: edges, center, width, gap	measuring mode: edges, center, width	measuring mode: edges, center, width	measuring mode: edges, width
measuring field size		30 mm 150 mm 350 mm		24 mm
measuring field size (dep. on measuring dist.)			400 ... 875 mm	
measuring distance (to object)		50 mm 200 mm 500 mm	640 ... 1400 mm	0 ... 40 mm
measuring range towards object				
measuring frequency	90 ... 250 Hz 111 ... 370 Hz 125 ... 500 Hz 159 ... 625 Hz	500 Hz	500 Hz	1800 Hz 2000 Hz
interface		analog and RS 485	analog and RS 485	
output signal	4 ... 20 mA / 0 ... 10 VDC	4 ... 20 mA	4 ... 20 mA	4 ... 20 mA
output circuit	analog and RS 485			analog
connection types	connector	connector	connector	connector
<b>page</b>	<b>574</b>	<b>578</b>	<b>582</b>	<b>584</b>

ZADM 034	ZADM 034
	
<i>ParCon</i>	<i>ParCon</i>
measuring mode: edges, width measuring mode: sum of all dark areas, edges	switchable
22 mm	24 mm
	0 ... 40 mm
0 ... 200 mm	
1100 Hz	4000 Hz
4 ... 20 mA	
analog	PNP
connector	connector
<b>586</b>	<b>588</b>

product family	FLDM 170	FLDM 170	FLDK 110	FLDK 110
				
	<i>SCATEC-15</i>	<i>SCATEC-10</i>	<i>SCATEC-2</i>	<i>SCATEC-2</i>
measuring distance Sd	0 ... 120 mm	0 ... 90 mm	0 ... 60 mm 0 ... 120 mm	0 ... 60 mm 0 ... 120 mm
optimum operating distance	100 mm	70 mm	40 mm 100 mm	40 mm 100 mm
counting rate	< 3000000 copies/h	< 3000000 copies/h	< 600000 copies/h	< 600000 copies/h
output pulse length	0,3 ... 100 ms selectable	0,3 ... 100 ms selectable	5 / 10 / 15 / 20 ms selectable	5 / 10 ms selectable
sensitivity	single sheet/edge thickness 0,15 mm	single sheet/edge thickness 0,1 mm	single sheet/edge thickness 0,2 mm single sheet/edge thickness 0,25 mm	single sheet/edge thickness 0,25 mm single sheet/edge thickness 0,2 mm
false pulse suppression	4 program options	4 program options	on/off switchable	on/off switchable
sensitivity adjustment	4 preset levels or level set by customer	4 preset levels or level set by customer	high/low switchable	
direct gap detection	yes	yes		
interface	serial for ScaDiag software	serial for ScaDiag software		
light source	pulsed red laser diode	pulsed red laser diode	pulsed red laser diode	pulsed red laser diode
output circuit	opto isolated push-pull	opto isolated push-pull	opto isolated push-pull	push-pull
<b>page</b>	<b>594</b>	<b>596</b>	<b>598</b>	<b>602</b>

FLDK 110



SCATEC-J

0 ... 55 mm

40 mm

< 280000 copies/h

10 ms

single sheet/edge thickness  
1,5 mm

no

pulsed red laser diode

push-pull

604



## General information



*PosCon* sensors are based on the principle of 3D light sectioning in which the projected laser line is reflected by the surface and projected onto a two-dimensional optical receiver in a triangulation process. The specially developed multiple lens system ensures the required optical mapping quality. Different specific figures are thus reliably calculated with the help of clever algorithms and powerful coordinate transformation functions. In the measurement mode in question, the measured result can be compared with configurable limit values, and is available in binary form at the switching output. Or the measured value can be output directly in millimeters on the display or at the interface.

## Applications



**Integrated coordinate transformation**  
*PosCon* sensors can be positioned laterally at an angle of  $\pm 30^\circ$  above the object. This allows avoidance of disruptive installation obstacles, greatly extending the range of applications. Integrated coordinate transformation corrects the angle error in the sensor. So no additional, time-consuming programming effort is necessary in the control system.



*qTarget*<sup>®</sup> – optical axis aligned by design  
*qTarget*<sup>®</sup> enables the optical axis of the *PosCon* sensors to be aligned by design to defined reference points of the housing. This allows correct sensor positioning directly in CAD, making subsequent sensor mounting in the application free of further aiming effort.



**Measurement independent of object positions**  
An appropriate object can move within the measuring field without having any impact on the measurement. This absence of sensitivity makes a significant contribution to the reliable functioning of the sensor in the application.



### Characteristics and advantages

#### More freedom in machine construction and easy installation

- Optimum design thanks to optically aligned axis (qTarget)
- Fast sensor alignment thanks to visible laser line and LED indicators
- Any inclined installation position within  $\pm 30^\circ$
- Sensor operation without a reflector

#### Minimized programming effort for fast implementation

- Predefined measuring functions to measure edge and center positions, gaps and object width
- Only few parameters to optimize your measuring task
- No external software required
- Measured value output in millimeters thanks to calibrated sensor

#### Process safety ensured by reliable measuring results even under demanding conditions

- Accurate measurements even on very dark objects
- High measuring rates with fast-moving objects
- Immune to ambient light impacts



Sd = 150 ... 250 mm



- 0-10 VDC / 4-20 mA (adaptive)
- measuring mode: edges, center, width, gap
- RS 485 interface

**general data**

type	measuring mode: edges, center, width, gap
repeat accuracy	± 10 µm
power on indication	LED green
output indicator	LED yellow / LED red
light source	pulsed red laser diode
wave length	656 nm
laser class	1
adjustment	Touch Display, RS485

**electrical data**

voltage supply range +Vs	15 ... 28 VDC
current consumption max. (no load)	150 mA
output circuit	analog and RS 485
output signal	4 ... 20 mA / 0 ... 10 VDC
switching output	push-pull
output function	Out 1 / Alarm
output current	< 100 mA
baud rate	115200, adjustable
reverse polarity protection	yes, Vs to GND
short circuit protection	yes

**mechanical data**

width / diameter	26 mm
height / length	74 mm
depth	55 mm
type	rectangular, front view
housing material	aluminum
front (optics)	glass
connection types	connector M12 8 pin
weight	130 g

**ambient conditions**

operating temperature	-20 ... +50 °C
protection class	IP 67
storage temperature	-25 ... +75 °C
vibration (sinusoidal)	IEC 60068-2-6:2008 1.5 mm p-p at f = 10 - 57 Hz, 10 cycles per axis 10 g at f = 58 - 2000 Hz, 10 cycles per axis
shock (semi-sinusoidal)	IEC 60068-2-27:2009 50 g / 11 ms resp. 100 g / 6 ms, 10 jolts per axis and direction 100 g / 2 ms, 5000 jolts per axis and direction

**connection diagram**

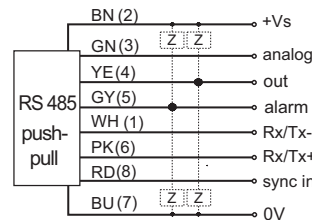

**connectors and mating connectors**

ESG 34FH0200G	Connector M12, 8 pin, straight, 2 m, shielded
ESW 33FH0200G	Connector M12, 8 pin, angular, 2 m, shielded
ESW 33FH0500G	Connector M12, 8 pin, angular, 5 m, shielded
ESW 33FH1000G	Connector M12, 8 pin, angular, 10 m, shielded

additional cable connectors and field wireable connectors: see accessories

**Accessories**

11120705	Mounting bracket X7 90° for PosCon and OM70, incl. accessories
11126836	Mounting bracket X7 30° horizontal for PosCon and OM70, incl. accessories
11126837	Mounting bracket X7 30° vertical for PosCon and OM70, incl. accessories

for details: see accessories section

**laser warning**



IEC 60825-1/2014  
Complies with 21 CFR 1040.10 and 1040.11  
except for deviations pursuant to laser  
notice No. 50, dated June 24, 2007





order reference	measuring range (width)	measuring range (distance)	version	measuring frequency	resolution	linearity error	temperature drift
<b>OXE7.E15T-11177353</b>	48 ... 72 mm	100 ... 150 mm	PosCon OXE7 - for very precise measurements and dark objects	111 ... 370 Hz	20 µm	± 50 ... ± 75 µm	< 0,03 % measured value/K
<b>OXE7.E15T-11148276</b>	48 ... 72 mm	100 ... 150 mm	PosCon OXE7 - for very precise measurements	159 ... 625 Hz	20 µm	± 50 ... ± 75 µm	< 0,03 % measured value/K
<b>OXE7.E25T-11174280</b>	75 ... 125 mm	150 ... 250 mm	PosCon OXE7 - for very dark objects	90 ... 250 Hz	30 ... 50 µm	± 80 ... ± 120 µm	< 0,05 % measured value/K
<b>OXE7.E25T-11111452</b>	75 ... 125 mm	150 ... 250 mm	PosCon OXE7	125 ... 500 Hz	30 ... 50 µm	± 80 ... ± 120 µm	< 0,05 % measured value/K

dimension drawing

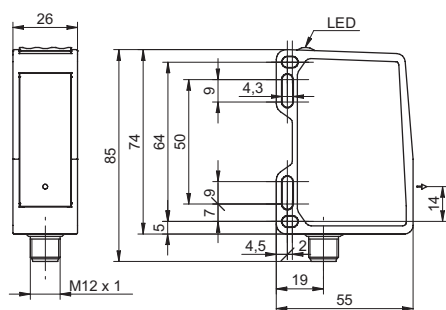



## General information

Line sensors are used to detect object widths and object positions. The position / width is issued as an analog value with high accuracy proportional to the overall measuring area. Although smaller than a deck of playing cards, the sensors contain not only the complete signal conditioning, but also a long-life illumination unit.

The simple switching version of the *ParCon* also allows the detection of small objects within the measuring area.

## Applications



### Edge detection (ZADM 023, *ParCon*)

- Control of textile, plastic or paper edges
- Positioning of objects by the edge
- Level measurement

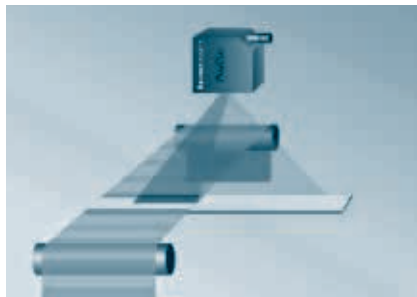

### Width measurement (ZADM 023, *ParCon*)

- Width inspection during the production of fabric and rubber bands



### Center position (ZADM 023)

- Position measurement by the object center, by which bands or objects of different width can be aligned centrally to each other

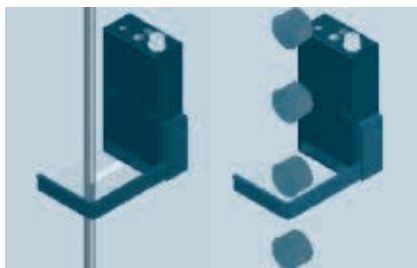

### Counting and detecting objects (*ParCon*), switching output

- Detection and counting of small objects falling through the measuring area
- Wire and belt break monitoring



## Characteristics and advantages

### *ParCon* line sensor

- The two measuring modes (edge, width, center) can be set by a push of a button.
- Due to the parallel light beams, the vertical movement of fabric webs does not affect the measurement signal.
- The high measuring frequency of 1000 Hz in the analog sensor also allows rapid movements to be detected.
- Due to the high measuring frequency of 4 kHz, even small, rapidly moving parts are reliably detected.

### ZADM 023 line sensor

- The measuring area can be restricted by a simple Teach-in process to suppress interfering objects and areas.
- The three different measuring modes (width, edge, center) can be set simply by a push of a button.
- Two threshold values can be programmed with the Teach-in button and serve as tolerance limits for the switching output.
- All functions available with the buttons can also be operated via an RS 485 interface.
- The position and other information can be read via the interface.
- Measurement is possible on transparent objects and films.

## Technology and operation

With the line sensors, the light of the integrated illumination is reflected by a reflective film (special film) installed opposite the sensor and is received by the diode line. The length of the diode line and the optics determine the measuring area. Due to the narrow diode line, the measuring area is also only a narrow band. If an object obstructs a part of the light, no light falls on the corresponding part of the diode line. The integrated microcontroller processes the shaded areas and the transitions from dark to light and calculates the corresponding analog value according to the measuring mode.

The optics of the **ZADM 023** and the *ParCon* are constructed differently. The **ZADM 023** has a diverging measuring field. This makes large measuring areas of up to 800 mm possible. The specified measuring area is achieved at the nominal distance. It becomes larger or smaller proportionally with the distance. This causes an object to appear larger or smaller according to the distance.

The *ParCon* has a parallel measuring field, making an object appear equal in size in the entire measuring area.

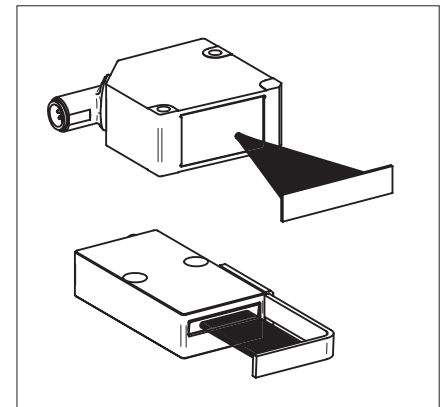

## Mounting and adjustment

The reflective tape specified in the documentation must be used for the **ZADM 023** and *ParCon*.

If the reflective tape is protected against abrasion by a Plexiglas or glass sheet, this must be tilted 7° to the sensor to ensure that the direct reflection does not reflect to the receiver. The reflective tape for the *ParCon* is covered by a protective film.

If highly reflective objects are measured, it is conceivable that a direct reflection will occur just as strong as the light from the reflective film. In this case, measuring errors can occur. This can be prevented by tilting the sensor away from the object.



measuring field size = 350 mm



- Teach-in measuring range
- measuring mode: edges, center, width
- RS 485 interface

#### general data

type	measuring mode: edges, center, width
version	with filter for transparent objects
measuring frequency	500 Hz
linearity error relative	< 0,3 %
light source	pulsed infrared diode
wave length	880 nm
adjustment	Teach-in

#### measuring field size = 30 mm

measuring distance (to object)	50 mm
resolution	< 0,03 mm
smallest object recognizable	0,3 mm

#### measuring field size = 150 mm

measuring distance (to object)	200 mm
resolution	< 0,15 mm
smallest object recognizable	1,2 mm

#### measuring field size = 350 mm

measuring distance (to object)	500 mm
resolution	< 0,35 mm
smallest object recognizable	4 mm

#### electrical data

response time	< 2 ms
voltage supply range +Vs	15 ... 28 VDC
current consumption max. (no load)	150 mA
output signal	4 ... 20 mA
output current	< 100 mA
interface	analog and RS 485
baud rate	19200, adjustable
reverse polarity protection	yes, Vs to GND

#### mechanical data

width / diameter	23 mm
type	rectangular
housing material	die-cast zinc
front (optics)	glass
connection types	connector M12 8 pin, rotatable

#### ambient conditions

operating temperature	0 ... +55 °C
protection class	IP 67

#### connection diagrams

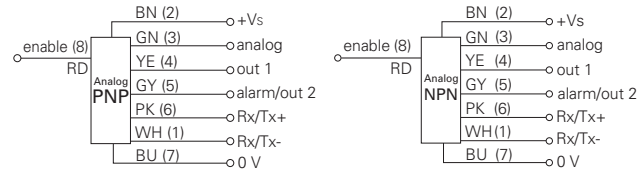

#### connectors and mating connectors

ESG 34FH0200G Connector M12, 8 pin, straight, 2 m, shielded

additional cable connectors and field wireable connectors: see accessories

#### Accessories

10126220 Mounting bracket series 22 L design

for details: see accessories section



order reference	measuring field size	output function	switching output
ZADM 023H151.0001	150 mm	Out 1 / Alarm	PNP
ZADM 023H151.0002	150 mm	Out 1 / Alarm	NPN
ZADM 023H151.0011	150 mm	Out 1 / Out 2	PNP
ZADM 023H151.0012	150 mm	Out 1 / Out 2	NPN
ZADM 023H300.0001	30 mm	Out 1 / Alarm	PNP
ZADM 023H300.0002	30 mm	Out 1 / Alarm	NPN
ZADM 023H300.0011	30 mm	Out 1 / Out 2	PNP
ZADM 023H300.0012	30 mm	Out 1 / Out 2	NPN
ZADM 023H351.0001	350 mm	Out 1 / Alarm	PNP
ZADM 023H351.0002	350 mm	Out 1 / Alarm	NPN
ZADM 023H351.0011	350 mm	Out 1 / Out 2	PNP
ZADM 023H351.0012	350 mm	Out 1 / Out 2	NPN



## reflectors

		reflector	reflector tape on reel		reflective tape	
measuring range	30 mm	FTDR 005I040	FTDL 005I000/... m	width 5 mm	FTDF 005I040	5 x 40 mm
measuring range	150 mm	FTDR 020I175	FTDL 020I000/... m	width 20 mm	FTDF 020I175	20 x 175 mm
measuring range	350 mm	FTDR 035I395	FTDL 035I000/... m	width 35 mm	FTDF 035I395	35 x 395 mm
			FTDL 610I000/... m	width 610 mm		

## dimension drawing

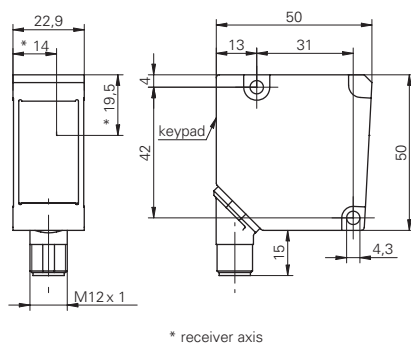





measuring field size = 875 mm



- Teach-in measuring range
- measuring mode: edges, center, width
- RS 485 interface

#### general data

type	measuring mode: edges, center, width
version	without filter, therefore not for transparent objects
measuring field size (dep. on measuring dist.)	400 ... 875 mm
measuring distance (to object)	640 ... 1400 mm
measuring frequency	500 Hz
resolution	0,5 ... 1 mm
smallest object recognizable	8,5 ... 18 mm
linearity error relative	< 0,3 %
light source	pulsed infrared diode
wave length	880 nm
adjustment	Teach-in

#### electrical data

response time	< 2 ms
voltage supply range +Vs	15 ... 28 VDC
current consumption max. (no load)	150 mA
output signal	4 ... 20 mA
output current	< 100 mA
interface	analog and RS 485
baud rate	19200, adjustable
reverse polarity protection	yes, Vs to GND
short circuit protection	yes

#### mechanical data

width / diameter	23 mm
type	rectangular
housing material	die-cast zinc
front (optics)	glass
connection types	connector M12 8 pin, rotatable

#### ambient conditions

operating temperature	0 ... +55 °C
protection class	IP 67

order reference	output function	switching output
ZADM 023H871.0001	Out 1 / Alarm	PNP
ZADM 023H871.0002	Out 1 / Alarm	NPN
ZADM 023H871.0011	Out 1 / Out 2	PNP

#### connection diagrams

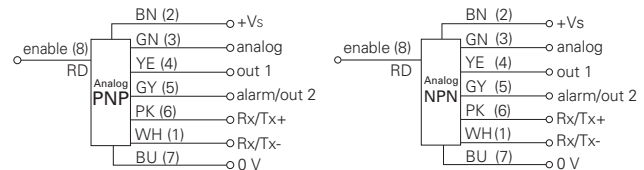

#### connectors and mating connectors

ESG 34FH0200G Connector M12, 8 pin, straight, 2 m, shielded

additional cable connectors and field wireable connectors: see accessories

#### Accessories

10126220 Mounting bracket series 22 L design

for details: see accessories section





**reflectors**

FTDL 050I000/... m	on reel, width 35 mm
FTDL 610I000/... m	on reel, width 610 mm

**conversion factors**

measuring distance (mm)	measuring field size (mm)
640	400
1400	875
meas. distance : meas. field size = 1,6	

measuring distance (mm)	resolution (mm)
640	0,5
1400	1
meas. distance : resolution = 1300	

measuring distance (mm)	smallest object (mm)
640	8,5
1400	18
meas. distance : smallest object = 75	

example	desired measuring field size	=	650 mm
meas. distance	650 mm x 1,6	=	1040 mm
resolution	1040 mm : 1300	=	0,8 mm
smallest object	1040 mm : 75	=	13,9 mm

**dimension drawing**

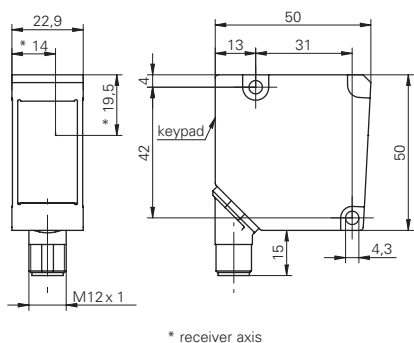



## measuring field size = 24 mm

- measuring of edge position and object width
- parallel, uniform light beam
- high measuring frequency

**general data**

type	measuring mode: edges, width
measuring field size	24 mm
measuring distance (to object)	0 ... 40 mm
resolution	< 0,05 mm
repeat accuracy	< 0,05 mm
smallest object recognizable	1 mm
linearity error	± 0,4 mm (S = 0...40 mm) ± 0,2 mm (S = 20...40 mm)
power on indication	LED green
output indicator	LED yellow
light source	pulsed infrared diode
wave length	880 nm

**electrical data**

response time	< 0,5 ms
voltage supply range +Vs	12 ... 28 VDC
current consumption max. (no load)	120 mA
output circuit	analog
output signal	4 ... 20 mA
reverse polarity protection	yes, Vs to GND
short circuit protection	yes

**mechanical data**

width / diameter	34 mm
housing material	aluminum
front (optics)	glass
connection types	connector M8 4 pin

**ambient conditions**

operating temperature	0 ... +55 °C
protection class	IP 67

**remarks**

reflector bracket can be replaced with a reflective tape.

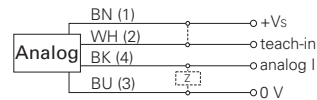
**connection diagram****connectors and mating connectors**

ESG 32AH0200G Connector M8, 4 pin, straight, 2 m, shielded

ESW 31AH0200G Connector M8, 4 pin, angular, 2 m, shielded

additional cable connectors and field wireable connectors: see accessories

order reference	type	measuring frequency
ZADM 034I240.0001	rectangular, side view	1800 Hz
ZADM 034I240.0021	rectangular, front view	2000 Hz



**reflectors**

FTDF 012M050	tape 12 x 50 mm (included)
FTDR 008M030/01	bracket for ZADM 034x240.xx01 (included)
FTDR 008M030/21	bracket for ZADM 034x240.xx21 (included)

optional

FTDF 050M234	tape 50 x 234 mm
--------------	------------------

**dimension drawings**

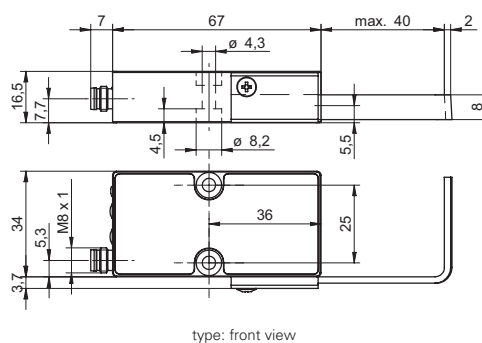
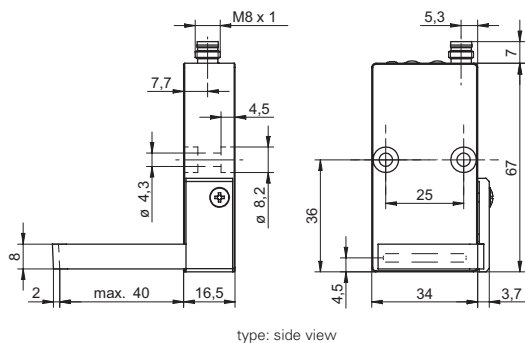



## measuring field size = 22 mm



- measuring of edge position and object width
- parallel, uniform light beam
- high measuring frequency

**general data**

measuring field size	22 mm
measuring range towards object	0 ... 200 mm
measuring frequency	1100 Hz
resolution	< 0,1 mm (S = 0 ... 150 mm) < 0,2 mm (S = 150 ... 200 mm)
repeat accuracy	< 0,1 mm (S = 0 ... 150 mm) < 0,2 mm (S = 150 ... 200 mm)
smallest object recognizable	3 mm
linearity error	± 1,75 mm (S = 0 ... 200 mm) ± 1 mm (S = 50 ... 150 mm)
power on indication	LED green
output indicator	LED yellow
light source	pulsed infrared diode
wave length	880 nm

**electrical data**

response time	< 0,9 ms
voltage supply range +Vs	12 ... 28 VDC
current consumption max. (no load)	120 mA
output circuit	analog
output signal	4 ... 20 mA
reverse polarity protection	yes, Vs to GND
short circuit protection	yes

**mechanical data**

width / diameter	34 mm
type	rectangular, front view
housing material	aluminum
front (optics)	glass
connection types	connector M8 4 pin

**ambient conditions**

operating temperature	0 ... +55 °C
protection class	IP 67

**remarks**

reflector bracket can be replaced with a reflective tape.

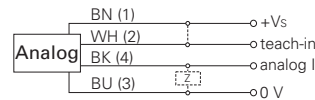
**connection diagram****connectors and mating connectors**

ESG 32AH0200G Connector M8, 4 pin, straight, 2 m, shielded

ESW 31AH0200G Connector M8, 4 pin, angular, 2 m, shielded

additional cable connectors and field wireable connectors: see accessories

**order reference****type**

ZADM 034I220.0021	measuring mode: edges, width
ZADM 034I220.0022	measuring mode: sum of all dark areas, edges

**reflectors**

FTDF 035M050 tape 12 x 50 mm (included)

optional

FTDF 050M234 tape 50 x 234 mm

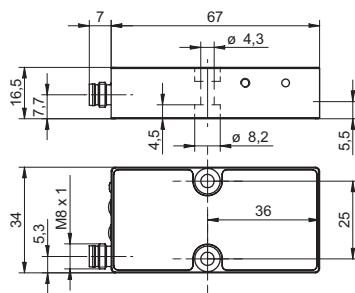
**dimension drawing**

type: front view



measuring field size = 24 mm

- detection of small objects
- measuring area 24 x 40 mm
- high measuring frequency



#### general data

type	switchable
measuring field size	24 mm
measuring distance (to object)	0 ... 40 mm
measuring frequency	4000 Hz
resolution	< 0,1 mm
smallest object recognizable	0,5 mm
hysteresis	0,4 mm
power on indication	LED green
light source	pulsed infrared diode
wave length	880 nm
adjustment	Teach-in

#### electrical data

response time	< 0,25 ms
output pulse length	10 ms
voltage supply range +Vs	12 ... 28 VDC
current consumption max. (no load)	120 mA
output circuit	PNP
output function	light / dark operate
output current	< 100 mA
voltage drop Vd	< 2,2 VDC
reverse polarity protection	yes, Vs to GND
short circuit protection	yes

#### mechanical data

width / diameter	34 mm
housing material	aluminum
front (optics)	glass
connection types	connector M8 4 pin

#### ambient conditions

operating temperature	0 ... +55 °C
protection class	IP 67

#### remarks

reflector bracket can be replaced with a reflective tape.

#### connection diagram



#### connectors and mating connectors

ESG 32AH0200G Connector M8, 4 pin, straight, 2 m, shielded

ESW 31AH0200G Connector M8, 4 pin, angular, 2 m, shielded

additional cable connectors and field wireable connectors: see accessories

#### order reference

order reference	type
ZADM 034P240.6901	rectangular, side view
ZADM 034P240.6921	rectangular, front view



**reflectors**

FTDF 012M050	tape 12 x 50 mm (included)
FTDR 008M030/01	bracket for ZADM 034x240.xx01 (included)
FTDR 008M030/21	bracket for ZADM 034x240.xx21 (included)

optional

FTDF 050M234	tape 50 x 234 mm
--------------	------------------

**dimension drawings**

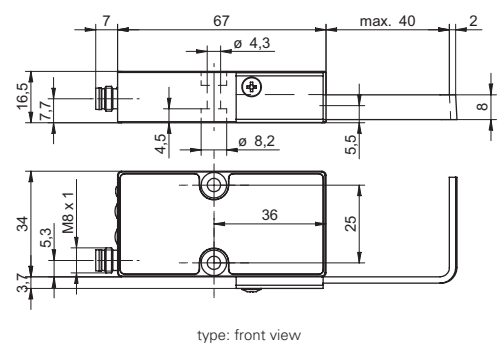
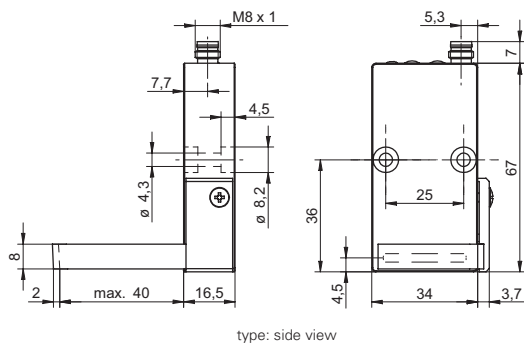



## General information



The sensors in the *SCATEC* range were developed specifically for non-contact counting of overlapped paper sheets and newspapers. Other flat objects conveyed in a lap stream or individually can also be counted. If such an object moves through the laser beam, the sensor replies with an electrical impulse with a fixed time period. The patented optical principle permits objects to be detected regardless of their color and surface; matte black objects are counted just as accurately as white glossy ones.

## Characteristics and advantages

- **Counts regardless of the motion of product direction**  
The copies are counted when an edge facing the laser beam moves through the beam, whether the direction of product motion is forwards or backwards
- **Visible laser beam**  
The red laser line is easily visible on the object and permits simple alignment.
- **Color insensitivity**  
The integrated laser controller makes the *SCATEC* extremely insensitive to different surfaces of the object.
- **No blind region**  
Large counted objects can even touch the sensor without causing counting errors.
- **Sensitivity adjustment**  
Depending on the model, the sensitivity can be adjusted with a DIP switch, on the control panel or via the interface.
- **Edge indicator**  
Yellow LED: light is on as long as an edge is in the laser beam.





## Characteristics and advantages

### Multiple pulse suppression

Particularly with thick copies (newspapers, folded cardboard boxes etc.) or with a small prefold, multiple pulses which can occur at the edge can be suppressed by this function. Error pulse suppression operates by preventing further pulses from being emitted when an output pulse is active or during an idle time. The following programs guarantee optimum adjustment to all counting problems:

Fixed idle time: adjustable in milliseconds

Dynamic dead time: the microcontroller constantly monitors the pulse sequence and eliminates multiple pulses even if the conveying speed varies by dynamically adjusting the dead time to the pulse sequence.

Synchronization to the machine cycle: the *SCATEC* can be synchronized to the machine cycle (e.g. by an encoder) via a synchronization input. The dead time then corresponds to a defined distance which is absolutely independent of the conveying speed.

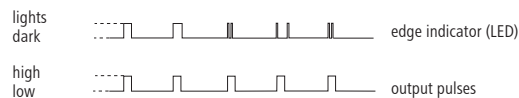
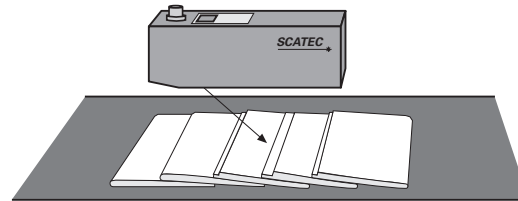

### - No counting errors when the lap stream is interrupted

The *SCATEC* detects only the leading edge of an object. It does not detect trailing edges which become visible when the lap stream is interrupted. Projecting trailing edges can be suppressed by direct gap detection or by delaying the output pulse (*SCATEC-10* or *SCATEC-15*). An integrated retro-reflective sensor allows accurate detection of gaps in the lap stream. This can additionally increase the counting accuracy.

### - Programming and diagnostic software

With the programming software *ScaDiag*, all functions and parameters can be simply adjusted on a PC. Furthermore, measurement sequences can be recorded and stored for diagnosis and troubleshooting.



## Technology and operation

Stated simply, the **SCATEC** consists of a laser light source and two photodetectors. The beam is aimed diagonally at the objects to be detected.

The photodetector **R** is located close to the laser light source and photodetector **V** is a little further away. The sensor determines the ratio between signal **v** (light diffused forwards) and signal **r** (light diffused backwards).

The ratio **v/r** differs widely depending on whether the beam strikes a flat surface or an edge. If an edge moves into the laser beam, the direct view from detector **V** to the laser strike point is obstructed, reducing signal **v**, and also the edge increases the backwards diffusion, which causes signal **r** to rise. Both effects make the ratio **v/r** much smaller at an edge than on a flat surface. If the ratio **v/r** falls below a specific threshold, this is interpreted by the sensor as an edge.

Due to the well-focused laser beam, the **SCATEC** detects even the smallest edges. There is no blind region directly beneath the sensor. Large counted objects may even touch the sensor without causing counting errors.

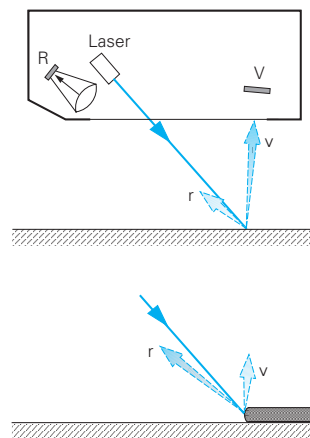

## Mounting and adjustment

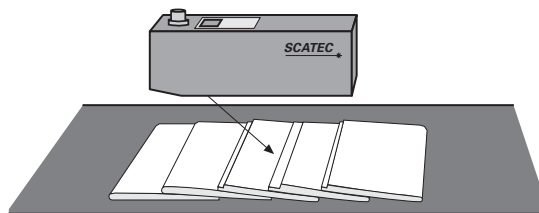

- The objects to be counted must have an edge facing the beam.
- The sensor must be installed parallel above the working plane.
- The laser beam should be blocked by a beam stop mounted parallel and just below the bearing surface. We recommend a light, matte object for this purpose (white paper, light and matte metal surface).



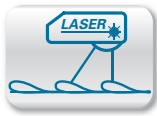

Sd = 0 ... 120 mm

- up to 3 million copies/hour
- Sensitivity  $\geq 0,15$  mm
- display and integrated counter

**general data**

measuring distance Sd	0 ... 120 mm
optimum operating distance	100 mm
counting rate	< 3000000 copies/h
object speed	< 5 m/sec
object cycle distance	> 1 mm
sensitivity	single sheet/edge thickness 0,15 mm
sync. input	yes
measuring point	visible red laser line 8 mm
light source	pulsed red laser diode
wave length	670 nm
laser class	2
edge indicator	LED yellow
power on indication	LED green
false pulse suppression	4 program options
direct gap detection	yes
sensitivity adjustment	4 preset levels or level set by customer

**electrical data**

voltage supply range +Vs	10 ... 30 VDC
current consumption max. (no load)	230 mA
output pulse length	0,3 ... 100 ms selectable
short circuit protection	yes
reverse polarity protection	yes
interface	serial for ScaDiag software

**mechanical data**

width / diameter	30 mm
type	rectangular
housing material	die-cast zinc
connector base (main connector)	DIN 45322, 6 pin
connector base (interface)	DIN 45326, 8 pin
front (optics)	glass

**ambient conditions**

operating temperature	0 ... +50 °C
protection class	IP 54

**Accessories**

10157472	Mounting panel for sensors SCATEC
for details: see accessories section	

order reference	output circuit
FLDM 170C1030/S42	opto isolated
FLDM 170G1030/S42	push-pull



**connection diagrams**

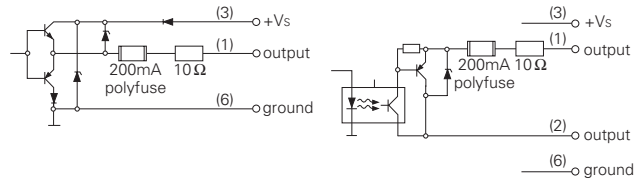

**accessories**

ScaDiag kit diagnostic program includes interface converter and manual	10156491
mounting plate for mounting on round rod	10157472
for details, see accessories section	

**laser warning**

**LASER RADIATION**  
**DO NOT STARE INTO BEAM**  
Wavelength: 640...670nm  
IEC 60825-1, Ed. 3, 2014  
**CLASS 2 LASER PRODUCT**

Complies with 21 CFR 1040.10 and 1040.11 except for deviations pursuant to laser notice No. 50, dated June 24, 2007

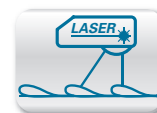

pin assignments

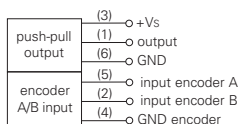

main connector push-pull

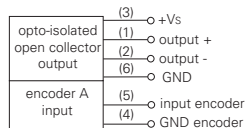

main connector open collector

connectors

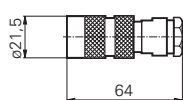

10104236	6 pin	(included)
10153202	8 pin	(optional)

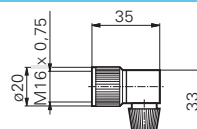

10153094	6 pin	(optional)
10153095	8 pin	(optional)

connector

ESG 16DP1000G main cable, length = 10 m, shielded, 6 pin

reflectors

FTDF 025F025	tape 25 x 25 mm
(included)	

dimension drawing

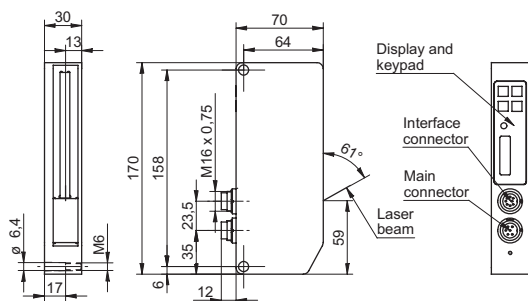

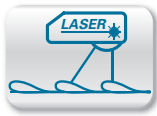

Sd = 0 ... 90 mm

- up to 3 million copies/hour
- Sensitivity  $\geq 0,1$  mm
- display and integrated counter

**general data**

measuring distance Sd	0 ... 90 mm
optimum operating distance	70 mm
counting rate	< 3000000 copies/h
object speed	< 5 m/sec
object cycle distance	> 1 mm
sensitivity	single sheet/edge thickness 0,1 mm
sync. input	yes
measuring point	visible red laser line 6 mm
light source	pulsed red laser diode
wave length	670 nm
laser class	2
edge indicator	LED yellow
power on indication	LED green
false pulse suppression	4 program options
direct gap detection	yes
sensitivity adjustment	4 preset levels or level set by customer

**electrical data**

voltage supply range +Vs	10 ... 30 VDC
current consumption max. (no load)	230 mA
output pulse length	0,3 ... 100 ms selectable
short circuit protection	yes
reverse polarity protection	yes
interface	serial for ScaDiag software

**mechanical data**

width / diameter	30 mm
type	rectangular
housing material	die-cast zinc
connector base (main connector)	DIN 45322, 6 pin
connector base (interface)	DIN 45326, 8 pin
front (optics)	glass

**ambient conditions**

operating temperature	0 ... +50 °C
protection class	IP 54

**Accessories**

10157472	Mounting panel for sensors SCATEC
----------	-----------------------------------

for details: see accessories section

order reference	output circuit
FLDM 170C1011/S42	opto isolated
FLDM 170G1011/S42	push-pull



**connection diagrams**

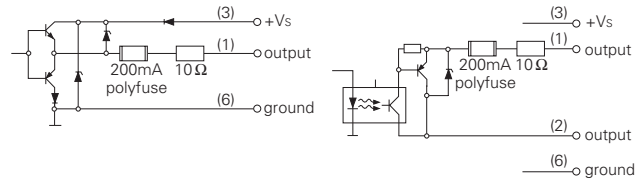

**accessories**

ScaDiag kit diagnostic program includes interface converter and manual	10156490
mounting plate for mounting on round rod	10157472

for details, see accessories section

**laser warning**

**LASER RADIATION**  
**DO NOT STARE INTO BEAM**  
Wavelength: 640...670nm  
IEC 60825-1, Ed. 3, 2014  
**CLASS 2 LASER PRODUCT**

Complies with 21 CFR 1040.10 and 1040.11 except for deviations pursuant to laser notice No. 50, dated June 24, 2007

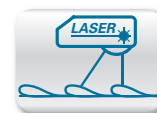

pin assignments

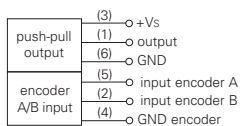

main connector push-pull

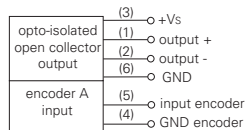

main connector open collector

connectors

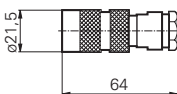

10104236 6 pin (included)

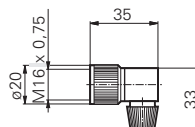

10153094 6 pin (optional)

connector

ESG 16DP1000G main cable, length = 10 m, shielded, 6 pin

reflectors

FTDF 025F025 tape 25 x 25 mm  
(included)

dimension drawing

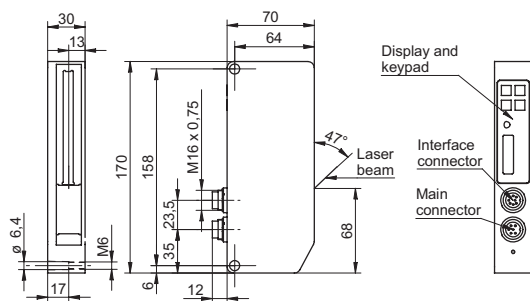

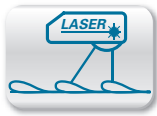

Sd = 0 ... 120 mm

- Smallest laser copy counter on the market
- counting of up to 600'000 copies/hour
- Sensitivity ≥ 0,2 mm



**general data**

counting rate	< 600000 copies/h
object speed	< 5 m/sec
object cycle distance	> 1 mm
sync. input	no
light source	pulsed red laser diode
wave length	670 nm
laser class	2
edge indicator	LED yellow
power on indication	LED green
false pulse suppression	on/off switchable

**electrical data**

voltage supply range +Vs	10 ... 30 VDC
current consumption max. (no load)	180 mA
output pulse length	5 / 10 / 15 / 20 ms selectable
short circuit protection	yes
reverse polarity protection	yes

**mechanical data**

width / diameter	30 mm
type	rectangular
housing material	PA 6
front (optics)	glass

**ambient conditions**

operating temperature	0 ... +50 °C
protection class	IP 54

**connectors and mating connectors**

ESG 34AH0200	Connector M12, 4 pin, straight, 2 m
ESW 33AH0200	Connector M12, 4 pin, angular, 2 m
additional cable connectors and field wireable connectors: see accessories	

**Accessories**

10157472	Mounting panel for sensors SCATEC
for details: see accessories section	

**connection diagrams**

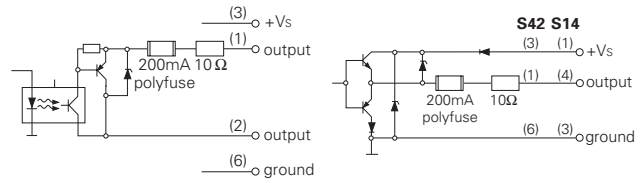

**accessories**

ScaDiag kit (S14) diagnostic program includes interface converter and manual	10156479
ScaDiag kit (S42) diagnostic program includes interface converter and manual	10156489
mounting plate for mounting on round rod	10157472
for details, see accessories section	

**laser warning**

**LASER RADIATION**  
**DO NOT STARE INTO BEAM**  
Wavelength: 640...670nm  
IEC 60825-1, Ed. 3, 2014  
**CLASS 2 LASER PRODUCT**

Complies with 21 CFR 1040.10 and 1040.11 except for deviations pursuant to laser notice No. 50, dated June 24, 2007





order reference	measuring distance Sd	sensitivity	output circuit	optimum operating distance	connector base (main connector)	measuring point	sensitivity adjustment
<b>FLDK 110C1003/S42</b>	0 ... 60 mm	single sheet/edge thickness 0,2 mm	opto isolated	40 mm	DIN 45322, 6 pin	visible red laser line 2 mm	high/low switchable
<b>FLDK 110C1005/S42</b>	0 ... 120 mm	single sheet/edge thickness 0,25 mm	opto isolated	100 mm	DIN 45322, 6 pin	visible red laser line 3 mm	high/low switchable
<b>FLDK 110G1003/S14</b>	0 ... 60 mm	single sheet/edge thickness 0,2 mm	push-pull	40 mm	M12 x 1, 5 pin	visible red laser line 2 mm	high/low switchable
<b>FLDK 110G1003/S42</b>	0 ... 60 mm	single sheet/edge thickness 0,2 mm	push-pull	40 mm	DIN 45322, 6 pin	visible red laser line 2 mm	high/low switchable
<b>FLDK 110G1005/S14</b>	0 ... 120 mm	single sheet/edge thickness 0,25 mm	push-pull	100 mm	M12 x 1, 5 pin	visible red laser line 3 mm	-



connectors

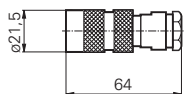

10104236 6 pin DIN 45322

(included)

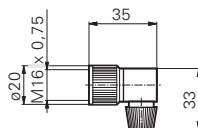

10153094 6 pin DIN 45322

(optional)

connectors M12 x 1

ESG 34AH0200	4 pin	2 m, straight
ESG 34AH0500	4 pin	5 m, straight
ESG 34AH1000	4 pin	10 m, straight

connectors M12 x 1

ESW 33AH0200	4 pin	2 m, angular
ESW 33AH0500	4 pin	5 m, angular
ESW 33AH1000	4 pin	10 m, angular

dimension drawings

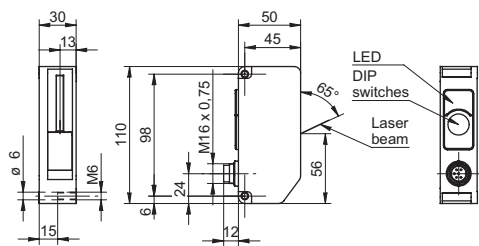

FLDK 110x1003/S42

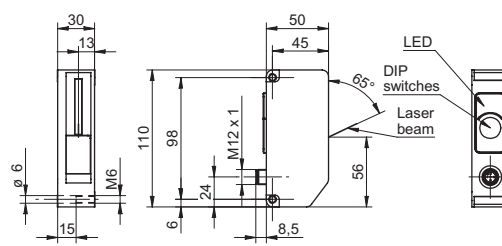

FLDK 110x1003/S14

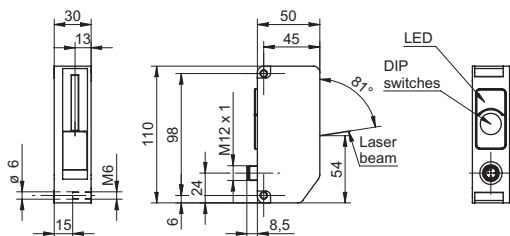

FLDK 110G1005/S14



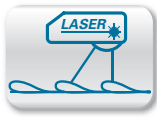

Sd = 0 ... 120 mm

- Laser copy counter / edge detector
- Individual package detection with seamless product detection



**general data**

counting rate	< 600000 copies/h
object speed	< 5 m/sec
sync. input	no
light source	pulsed red laser diode
wave length	670 nm
laser class	2
edge indicator	LED yellow
power on indication	LED green
false pulse suppression	on/off switchable

**electrical data**

voltage supply range +Vs	10 ... 30 VDC
current consumption max. (no load)	180 mA
output circuit	push-pull
output pulse length	5 / 10 ms selectable
short circuit protection	yes
reverse polarity protection	yes

**mechanical data**

width / diameter	30 mm
type	rectangular
housing material	PA 6
connector base (main connector)	M12 x 1, 5 pin
front (optics)	glass

**ambient conditions**

operating temperature	0 ... +50 °C
protection class	IP 54

**connectors and mating connectors**

ESG 34AH0200	Connector M12, 4 pin, straight, 2 m
ESW 33AH0200	Connector M12, 4 pin, angular, 2 m

additional cable connectors and field wireable connectors: see accessories

**Accessories**

10157472	Mounting panel for sensors SCATEC
----------	-----------------------------------

for details: see accessories section

**connection diagram**

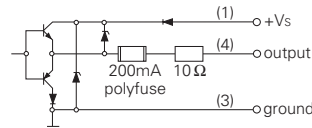

**accessories**

mounting plate for mounting on round rod	10157472
ScaDiag kit diagnostic program includes interface converter and manual	10156479

for details, see accessories section

**laser warning**

**LASER RADIATION**  
**DO NOT STARE INTO BEAM**  
Wavelength: 640...670nm  
  
IEC 60825-1, Ed. 3, 2014  
**CLASS 2 LASER PRODUCT**

Complies with 21 CFR 1040.10 and 1040.11 except for deviations pursuant to laser notice No. 50, dated June 24, 2007

order reference	measuring distance Sd	sensitivity	optimum operating distance	measuring point
<b>FLDK 110G1006/S14</b>	0 ... 120 mm	single sheet/edge thickness 0,25 mm	100 mm	visible red laser line 3 mm
<b>FLDK 110G1303/S14</b>	0 ... 60 mm	single sheet/edge thickness 0,2 mm	40 mm	visible red laser line 2 mm

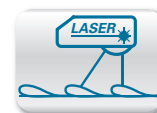

**connectors**

connectors M12 x 1

ESG 34AH0200	4 pin	2 m, straight
ESG 34AH0500	4 pin	5 m, straight
ESG 34AH1000	4 pin	10 m, straight

connectors M12 x 1

ESW 33AH0200	4 pin	2 m, angular
ESW 33AH0500	4 pin	5 m, angular
ESW 33AH1000	4 pin	10 m, angular

**dimension drawing**

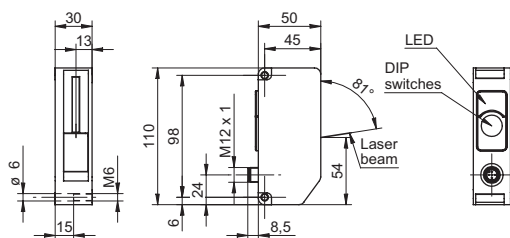

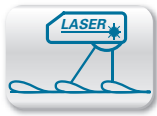

Sd = 0 ... 55 mm

- Smallest laser copy counter on the market
- counting of up to 280'000 copies/hour
- Sensitivity  $\geq 1,5$  mm

**general data**

measuring distance Sd	0 ... 55 mm
optimum operating distance	40 mm
counting rate	< 280000 copies/h
object speed	< 2 m/sec
object cycle distance	> 13 mm
sensitivity	single sheet/edge thickness 1,5 mm
sync. input	no
measuring point	visible red point
light source	pulsed red laser diode
wave length	670 nm
laser class	2
edge indicator	LED yellow
power on indication	LED green
sensitivity adjustment	no

**electrical data**

voltage supply range +Vs	10 ... 30 VDC
current consumption max. (no load)	180 mA
output circuit	push-pull
output pulse length	10 ms
short circuit protection	yes
reverse polarity protection	yes

**mechanical data**

width / diameter	30 mm
type	rectangular
housing material	PA 6
connector base (main connector)	M12 x 1, 5 pin
front (optics)	glass

**ambient conditions**

operating temperature	0 ... +50 °C
protection class	IP 54

**connectors and mating connectors**

ESG 34AH0200	Connector M12, 4 pin, straight, 2 m
ESW 33AH0200	Connector M12, 4 pin, angular, 2 m

additional cable connectors and field wireable connectors: see accessories

**Accessories**

10157472	Mounting panel for sensors SCATEC
----------	-----------------------------------

for details: see accessories section

**order reference**

FLDK 110G1010/S14

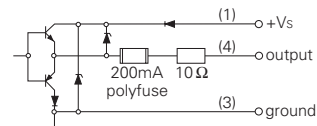
**connection diagram****accessories**

mounting plate for mounting on round rod	10157472
ScaDiag kit diagnostic program includes interface converter and manual	11051709

for details, see accessories section

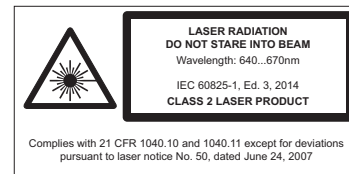
**laser warning**

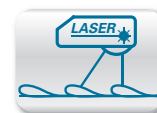

**connectors**

connectors M12 x 1

ESG 34AH0200	4 pin	2 m, straight
ESG 34AH0500	4 pin	5 m, straight
ESG 34AH1000	4 pin	10 m, straight

connectors M12 x 1

ESW 33AH0200	4 pin	2 m, angular
ESW 33AH0500	4 pin	5 m, angular
ESW 33AH1000	4 pin	10 m, angular

**dimension drawing**

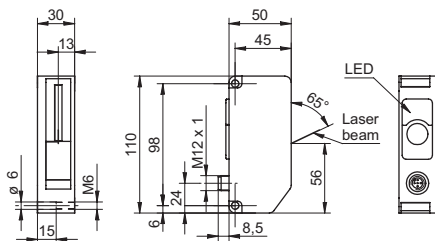



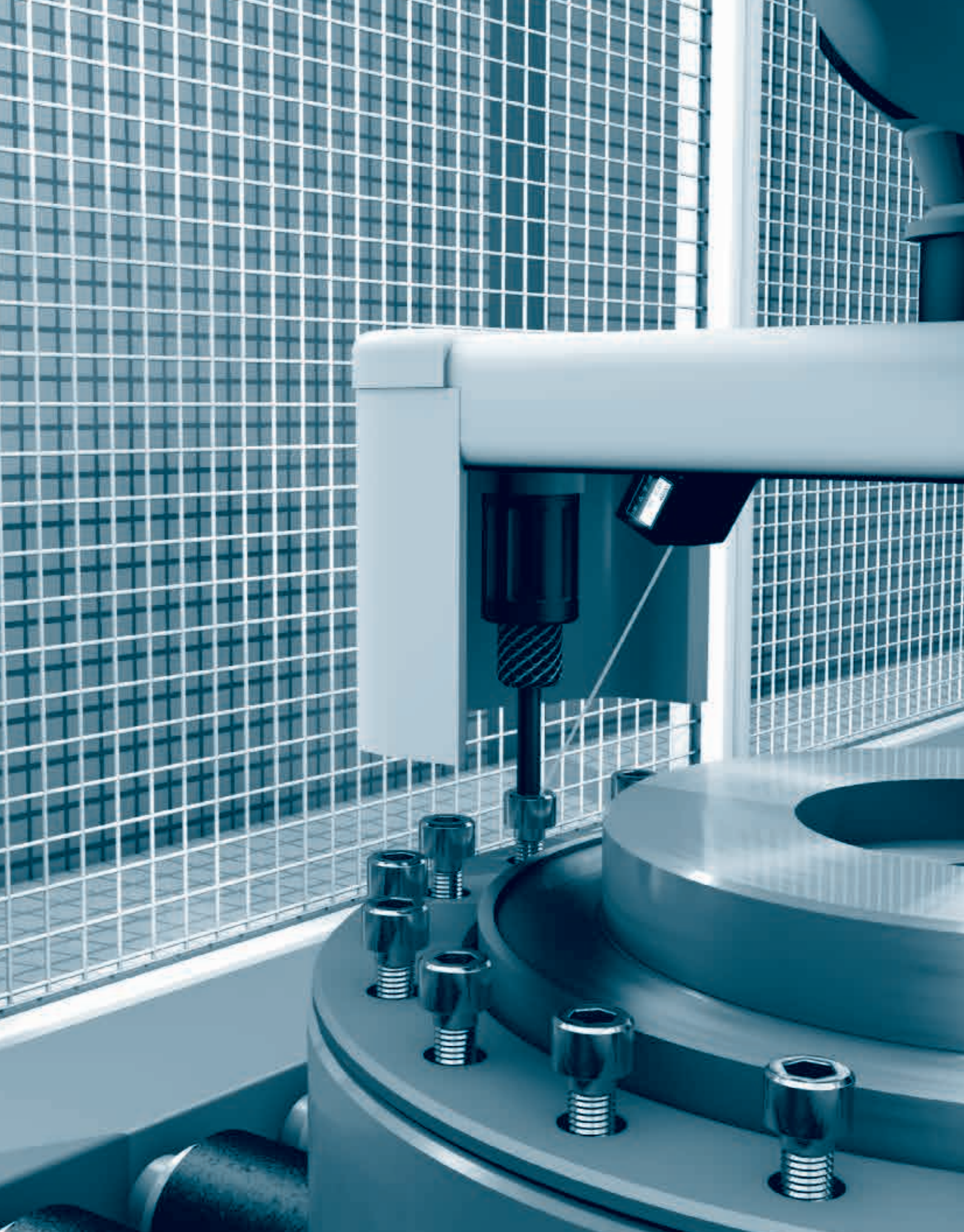



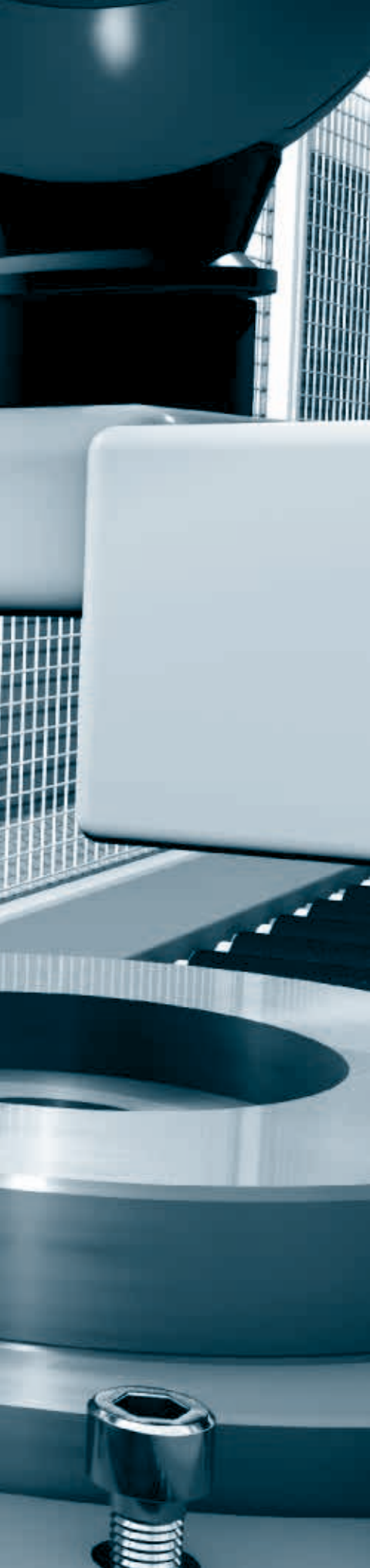





## Distance sensors





Miniature sensors	Page 624
Performance sensors for the fabric automation	Page 646
High-Performance sensors	Page 664
Long range sensors	Page 682
Standard distance sensors	Page 686







laser distance sensors

product family	OADM 12	OADM 12	OADM 12	OADM 13	OADM 13
					
width / diameter	12,4 mm	12,4 mm	12,4 mm	13,4 mm	13,4 mm
measuring distance Sd	16 ... 26 mm 16 ... 120 mm	16 ... 26 mm 16 ... 120 mm	16 ... 26 mm 30 ... 50 mm 16 ... 120 mm	50 ... 350 mm 50 ... 550 mm	50 ... 350 mm 50 ... 550 mm
resolution	0,002 ... 0,005 mm 0,002 ... 0,12 mm	0,002 ... 0,005 mm 0,002 ... 0,12 mm	0,004 ... 0,008 mm 0,01 ... 0,026 mm 0,012 ... 0,12 mm	0,01 ... 0,4 mm 0,01 ... 1,15 mm	0,01 ... 0,4 mm 0,01 ... 1,15 mm
linearity error	± 0,006 ... ± 0,015 mm ± 0,015 ... ± 0,35 mm	± 0,013 ... ± 0,025 mm ± 0,015 ... ± 0,35 mm	± 0,013 ... ± 0,025 mm ± 0,032 ... ± 0,078 mm ± 0,026 ... ± 0,35 mm	± 0,05 ... ± 1,2 mm ± 0,08 ... ± 3,5 mm	± 0,05 ... ± 1,2 mm ± 0,08 ... ± 3,5 mm
response time / release time	< 0,9 ms	2 ... 3 ms	< 1,8 ms < 3 ms	< 0,9 ms < 2 ms	< 0,9 ms < 2 ms
light source	pulsed red laser diode	pulsed red laser diode	pulsed red laser diode	pulsed red laser diode	pulsed red laser diode
adjustment	Teach-in: button / external	Teach-in: button / external	RS 485	Teach-in: button / external	Teach-in: button / external
output circuit	analog	analog	RS 485	analog	analog
output signal	4 ... 20 mA 0 ... 10 VDC	4 ... 20 mA 0 ... 10 VDC		4 ... 20 mA	0 ... 10 VDC
connection types	connector	connector	connector	connector	connector
housing material	metal	metal	metal	metal	metal
<b>page</b>	<b>624</b>	<b>626</b>	<b>628</b>	<b>630</b>	<b>632</b>





OADM 13	OADM 13	OADM 13	OADM 13	OADM 20	OADM 20
					
13,4 mm	13,4 mm	13,4 mm	13,4 mm	20,6 mm	20,6 mm
50 ... 350 mm 50 ... 550 mm	50 ... 350 mm 50 ... 550 mm	50 ... 60 mm 60 ... 100 mm 100 ... 200 mm	50 ... 60 mm 60 ... 100 mm 100 ... 200 mm	30 ... 70 mm 30 ... 130 mm	50 ... 300 mm 100 ... 600 mm
0,05 ... 0,4 mm 0,09 ... 1,15 mm	0,05 ... 0,4 mm 0,09 ... 1,15 mm	< 0,015 mm 0,015 ... 0,038 mm 0,039 ... 0,15 mm	< 0,015 mm 0,015 ... 0,038 mm 0,039 ... 0,15 mm	0,004 ... 0,02 mm 0,005 ... 0,06 mm	0,01 ... 0,33 mm 0,015 ... 0,67 mm
± 0,18 ... ± 1,2 mm ± 0,3 ... ± 3,5 mm	± 0,18 ... ± 1,2 mm ± 0,3 ... ± 3,5 mm	< 0,045 mm ± 0,047 ... ± 0,118 mm ± 0,123 ... ± 0,457 mm	< 0,045 mm ± 0,047 ... ± 0,118 mm ± 0,123 ... ± 0,457 mm	± 0,012 ... ± 0,06 mm ± 0,015 ... ± 0,2 mm	± 0,03 ... ± 1 mm ± 0,05 ... ± 2 mm
< 0,9 ms < 2 ms	< 0,9 ms < 2 ms	< 2 ms	< 2 ms	< 0,9 ms	< 0,9 ms
pulsed red laser diode	pulsed red laser diode	pulsed red laser diode	pulsed red laser diode	pulsed red laser diode	pulsed red laser diode
RS 232	RS 485	Teach-in: button / external	Teach-in: button / external	Teach-in: button / external	Teach-in: button / external
RS 232	RS 485	analog	analog	analog	analog
		4 ... 20 mA	0 ... 10 VDC	4 ... 20 mA 0 ... 10 VDC	4 ... 20 mA 0 ... 10 VDC
connector	connector	connector	connector	connector	connector
metal	metal	metal	metal	metal	metal
<b>634</b>	<b>636</b>	<b>638</b>	<b>642</b>	<b>646</b>	<b>648</b>

laser distance sensors

product family	OADM 20	OADM 20	OADM 20	OADR 20	OADM 21
					
width / diameter	20,6 mm	20,6 mm	20,6 mm	20,3 mm	20,4 mm
measuring distance Sd	30 ... 70 mm 30 ... 130 mm 50 ... 300 mm	100 ... 600 mm 200 ... 1000 mm	50 ... 300 mm 100 ... 600 mm 200 ... 1000 mm	30 ... 130 mm 50 ... 300 mm 100 ... 600 mm	100 ... 600 mm 200 ... 1000 mm
resolution	0,004 ... 0,02 mm 0,005 ... 0,06 mm 0,01 ... 0,33 mm	0,015 ... 0,67 mm 0,12 ... 2,5 mm	0,01 ... 0,4 mm 0,015 ... 0,8 mm 0,12 ... 3 mm	0,005 ... 0,06 mm 0,01 ... 0,33 mm 0,015 ... 0,67 mm	0,01 ... 0,25 mm 0,02 ... 0,4 mm
linearity error	± 0,012 ... ± 0,06 mm ± 0,015 ... ± 0,2 mm ± 0,03 ... ± 1 mm	± 0,05 ... ± 2 mm ± 0,48 ... ± 10 mm	± 0,2 ... ± 1,5 mm ± 0,5 ... ± 3,4 mm ± 0,36 ... ± 9 mm	± 0,015 ... ± 0,2 mm ± 0,03 ... ± 1 mm ± 0,05 ... ± 2 mm	± 0,07 ... ± 1 mm ± 0,11 ... ± 1,65 mm
response time / release time	< 0,9 ms	< 0,9 ms	< 2 ms < 2,5 ms < 3,5 ms	< 0,9 ms	< 4 ms
light source	pulsed red laser diode	pulsed red laser diode	pulsed red laser diode	pulsed red laser diode	pulsed red laser diode
adjustment	Teach-in: button / external	Teach-in: button / external	Teach-in: button / external	external	Teach-in: button / external
output circuit	analog	analog		analog	analog
output signal	4 ... 20 mA / 0 ... 10 VDC	4 ... 20 mA / 0 ... 10 VDC	4 ... 20 mA / 0 ... 10 VDC	4 ... 20 mA / 0 ... 10 VDC	4 ... 20 mA / 0 ... 10 VDC
connection types	connector	connector	cable	connector	connector
housing material	metal	metal	metal	metal	metal
<b>page</b>	<b>650</b>	<b>654</b>	<b>656</b>	<b>658</b>	<b>662</b>





OM70-L	OM70-L	OM70-L	OM70-P	OM70-P	OM70-P
					
26 mm	26 mm	26 mm	26 mm	26 mm	26 mm
30 ... 70 mm 40 ... 140 mm 50 ... 250 mm	100 ... 600 mm 100 ... 1000 mm 150 ... 1500 mm	100 ... 600 mm 100 ... 1000 mm 150 ... 1500 mm	30 ... 70 mm 40 ... 140 mm 50 ... 250 mm	100 ... 600 mm 100 ... 1000 mm 150 ... 1500 mm	100 ... 600 mm 100 ... 1000 mm 150 ... 1500 mm
0,7 ... 1 µm 1) 2) 3) 1,2 ... 2,5 µm 1) 2) 3) 1,4 ... 6,3 µm 1) 2) 3)	3 ... 24 µm 1) 2) 3) 3 ... 63 µm 1) 2) 3) 13 ... 125 µm 1) 2) 3)	3 ... 24 µm 1) 2) 3) 3 ... 63 µm 1) 2) 3) 13 ... 125 µm 1) 2) 3)	0,7 ... 1 µm 1) 2) 3) 1,2 ... 2,5 µm 1) 2) 3) 1,4 ... 6,3 µm 1) 2) 3)	3 ... 24 µm 1) 2) 3) 3 ... 63 µm 1) 2) 3) 13 ... 125 µm 1) 2) 3)	3 ... 24 µm 1) 2) 3) 3 ... 63 µm 1) 2) 3) 13 ... 125 µm 1) 2) 3)
± 0,06 % Mr 1) 2) ± 0,07 % Mr 1) 2) ± 0,09 % Mr 1) 2)	± 0,12 % Mr 1) 2) ± 0,19 % Mr 1) 2) ± 0,32 % Mr 1) 2)	± 0,12 % Mr 1) 2) ± 0,19 % Mr 1) 2) ± 0,32 % Mr 1) 2)	± 0,06 % Mr 1) 2) ± 0,07 % Mr 1) 2) ± 0,09 % Mr 1) 2)	± 0,12 % Mr 1) 2) ± 0,19 % Mr 1) 2) ± 0,32 % Mr 1) 2)	± 0,12 % Mr 1) 2) ± 0,19 % Mr 1) 2) ± 0,32 % Mr 1) 2)
0,8 ms 2)	0,8 ms 2)	0,8 ms 2)	0,8 ms 2)	0,8 ms 2)	0,8 ms 2)
pulsed red laser diode	pulsed red laser diode	pulsed red laser diode	pulsed red laser diode	pulsed red laser diode	pulsed red laser diode
Touch Display, RS485	Touch Display, RS485	Touch Display, RS485	Touch Display, RS485	Touch Display, RS485	Touch Display, RS485
analog and RS 485	analog and RS 485	analog and RS 485	analog and RS 485	analog and RS 485	analog and RS 485
4 ... 20 mA / 0 ... 10 VDC	4 ... 20 mA / 0 ... 10 VDC	4 ... 20 mA / 0 ... 10 VDC	4 ... 20 mA / 0 ... 10 VDC	4 ... 20 mA / 0 ... 10 VDC	4 ... 20 mA / 0 ... 10 VDC
connector	connector	connector	connector	connector	connector
metal	metal	metal	metal	metal	metal
<b>664</b>	<b>666</b>	<b>668</b>	<b>670</b>	<b>672</b>	<b>674</b>

laser distance sensors

product family	OM70-X	OM70-X	OM70-X	OADM 250	OADM 260
					
width / diameter	26 mm	26 mm	26 mm	25,4 mm	25,4 mm
measuring distance Sd	100 ... 150 mm	100 ... 500 mm	100 ... 150 mm	200 ... 4000 mm	200 ... 13000 mm
resolution	2 ... 4 µm 1) 2) 4) 5)	4 ... 25 µm 1) 2) 4) 5)	2 ... 4 µm 1) 2) 4) 5)	1,3 mm	5 mm
linearity error	± 30 ... ± 90 µm 1) 2) 4) ± 100 µm 1) 2) 4) 6) ± 30 ... ± 90 µm 1) 2) 4)				
response time / release time	3,5 ms 2) 3)	1,3 ms 2) 3)	3,5 ms 2) 3)		
light source	pulsed red laser diode				
adjustment	Touch Display, RS485	Touch Display, RS485	Webserver, Ethernet TCP/IP	Teach-in: button / external	Teach-in: button / external
output circuit	analog and RS 485			analog	analog
output signal	4 ... 20 mA / 0 ... 10 VDC	4 ... 20 mA / 0 ... 10 VDC		4 ... 20 mA 0 ... 10 VDC	4 ... 20 mA
connection types	connector	connector	connector	connector	connector
housing material	metal				
<b>page</b>	<b>676</b>	<b>678</b>	<b>680</b>	<b>682</b>	<b>684</b>









photoelectric sensors with analog output

product family	O300.DI	O300.DL	O300.DP	O500.DI	O500.DP
					
width / diameter	12,9 mm	12,9 mm	12,9 mm	18 mm	18 mm
measuring distance Sd	30 ... 300 mm	30 ... 250 mm	30 ... 300 mm	60 ... 550 mm	60 ... 400 mm
resolution	0,5 ... 5 mm	0,5 ... 10 mm	0,5 ... 5 mm	0,5 ... 5 mm	0,5 ... 3 mm
linearity error	± 1,5 ... ± 15 mm	± 1,5 ... ± 12,5 mm	± 1,5 ... ± 15 mm	± 3 ... ± 27,5 mm	± 3 ... ± 20 mm
response time / release time	< 0,49 ms	< 0,25 ms	< 0,49 ms	< 0,49 ms	< 0,49 ms
light source	pulsed infrared diode	pulsed red laser diode	pulsed PinPoint LED	pulsed infrared diode	pulsed PinPoint LED
adjustment	Teach-in and IO-Link	Teach-in and IO-Link	Teach-in and IO-Link	Teach-in and IO-Link	Teach-in and IO-Link
output circuit	push-pull	push-pull	push-pull	push-pull	push-pull
output signal					
connection types	cable connector	cable connector	cable connector	cable connector	cable connector
housing material	plastic	plastic	plastic	plastic	plastic
<b>page</b>	<b>686</b>	<b>688</b>	<b>690</b>	<b>692</b>	<b>694</b>

product family	OADK 25
	
width / diameter	23,4 mm
measuring distance Sd	100 ... 1000 mm
resolution	0,3 ... 4 mm
linearity error	± 1,1 ... ± 15 mm
response time / release time	< 12,8 ms
light source	pulsed red laser diode
adjustment	Teach-in
output circuit	analog
output signal	0 ... 10 VDC 4 ... 20 mA
connection types	cable connector
housing material	plastic
<b>page</b>	<b>708</b>



FADK 14	FADK 14	FADR 14	FADR 14	FADH 14	FADH 14
					
14,8 mm	14,8 mm	19,6 mm	19,6 mm	19,6 mm	19,6 mm
50 ... 400 mm	50 ... 400 mm	50 ... 400 mm	50 ... 400 mm	50 ... 400 mm	50 ... 400 mm
0,1 ... 1 mm	0,1 ... 1 mm	0,1 ... 1 mm	0,1 ... 1 mm	0,1 ... 1 mm	0,1 ... 1 mm
± 1,5 ... ± 4 mm	± 1,5 ... ± 4 mm	± 1,5 ... ± 4 mm	± 1,5 ... ± 4 mm	± 1,5 ... ± 4 mm	± 1,5 ... ± 4 mm
< 3 ms	< 3 ms	< 3 ms	< 3 ms	< 3 ms	< 3 ms
pulsed point source LED	pulsed point source LED	pulsed point source LED	pulsed point source LED	pulsed point source LED	pulsed point source LED
IO-Link	IO-Link	IO-Link	IO-Link	IO-Link	IO-Link
analog	analog	analog	analog	analog	analog
4 ... 20 mA	0 ... 10 VDC	4 ... 20 mA	0 ... 10 VDC	4 ... 20 mA	0 ... 10 VDC
cable connector	cable connector	connector	connector	cable flylead connector	cable flylead connector
plastic	plastic	metal	metal	metal	metal
<b>696</b>	<b>698</b>	<b>700</b>	<b>702</b>	<b>704</b>	<b>706</b>



## General information

Optical distance sensors by Baumer measure accurately to the micrometer and deliver reliable results even on demanding surfaces. The extremely compact sensors with fully integrated electronics are ready to use quickly and with little effort.

## Typical applications

### Reliable and efficient processes

- Laser point, laser line or multi-spot beam shapes for reliable measurement in the sub-micrometer range for demanding surfaces
- Measurements with high repeat accuracy even in the sub-micrometer range
- Precise positioning of objects with a linearity error of  $\pm 0.06\%$
- Smart signal processing in the sensor
- Fast measurements thanks to short measuring cycles

### Long-lasting, robust solutions

- Robust housings made of stainless steel, metal and plastic for different applications
- High ambient light immunity
- Sensors resistant to vibration and sensors in IP 69K washdown design
- Low temperature drift during fluctuations in ambient temperatures

### Simple operation and integration

- Fast, economical initial start-up thanks to Plug & Play
- Fast and simple adjustment of the measuring range using the teach-in button
- Innovative touch display with a simple operating concept
- Factory-calibrated sensors with measuring values displayed in millimeters

## Technology and operation Triangulation

The light beam arrives at the object as a small spot. The sensor's receiver (photodiode array) detects the position of this spot. Depending on the distance, the angle of incidence changes and thus so does the position of the light spot on the receiver. The photodiode array is read by an integral microcontroller. The controller accurately calculates the angle from the light distribution on the photodiode array and then calculates the distance to the object from this. This distance is either transmitted to the serial port or converted into an output current proportional to the distance. The microcontroller guarantees a high degree of linearity and measuring accuracy. The combination of a photodiode array and a microcontroller allows interference from reflections to be suppressed, thus providing reliable data from critical surfaces. The sensor adapts to different colors by adjusting its internal sensitivity, making it almost independent of the color of the object. A digital output is activated if there is no object within the measuring range or if insufficient light is received to detect the object correctly, e.g. if the sensor is dirty. The possible resolution and the accuracy change with the distance. The same distance  $\Delta d$  which causes a significant change in the angle  $\alpha_1$  close to the sensor produces a much smaller change in the angle  $\alpha_2$  at a greater distance (see drawing). This non-linear behavior is corrected by the microcontroller, so that the output signal retains a linear relationship with the distance.

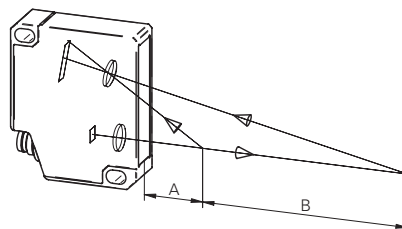



## Time of flight (propagation time measurement)

The propagation time measurement is a process for indirect distance measurement by measuring the amount of time that a signal requires to cover the measuring distance. In practice this means that an emitter sends a signal package which is reflected by the object and by the receiver. In the sensor, the propagation time and/or phase shift is evaluated and converted into a distance. Using this propagation time technology, objects can be detected exactly and reliably at great distances.

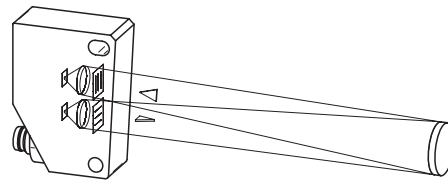

## Light section method

The innovative Baumer multi-spot measuring principle is based on the light section method. On the basis of the triangulation principle, the laser beam, which is up to 62 mm wide, is projected onto a receiver matrix, and up to 600 items of distance information are determined. The intelligent evaluation of this distance information takes place directly in the sensor, which then calculates the resulting distance. Thanks to its resolution of up to 2  $\mu\text{m}$  at a measuring frequency of 500 Hz, the sensor provides exceptionally stable and precise measurement results.

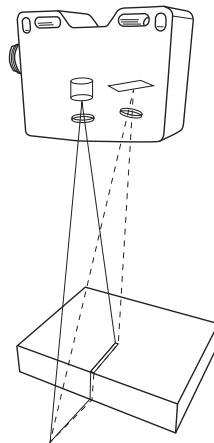



## Measurement functions

### Distance measurements

In the case of distance measurement, the sensor is ready to use immediately and gives the distance from the sensor to the object. The measured value can, for example, be used for the precise positioning of objects or for controlling a system. A digital output can also be parameterized as an option.

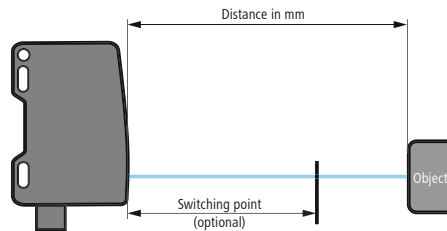

### Tolerance measurements

If, for example, the dimensional accuracy of objects is to be checked, a direct tolerance measurement can be made by teaching-in a reference, thus allowing the deviation from the nominal dimension to be determined directly. Here too, a digital output can be parameterized according-

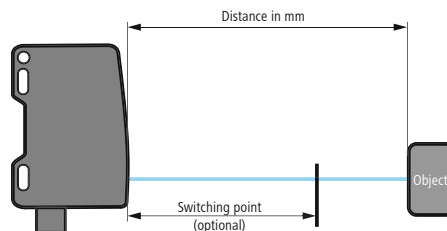

## Beam shapes

Besides different dimensions and ranges, the beam shape plays a particularly important role. Thanks to continuous further development, Baumer can now offer three different beam forms in its portfolio with the new «multi-spot» measuring principle:

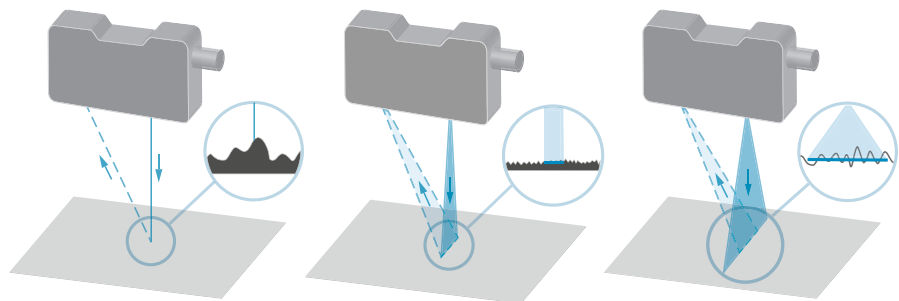

### Laser point

Accurate measurement of small objects thanks to focused laser spot < 0.4 mm

### Laser line

Stable measurements on rough surfaces and textured color surfaces thanks to a fine laser line < 10 mm

### Multi-spot

Stable measurements on inhomogeneously shiny and very rough surfaces from over 600 measurements with an extra-wide laser line < 72 mm



## Optimal focus ranges for OM70 sensors

### Reliable and reproducible measurements

In practice, object surfaces are rarely ideal for optical distance measurement. This often leads to unreliable, unstable measurements. Being the only laser distance sensors on the market, the OM70 sensors therefore offer different focus ranges for the measuring ranges 70, 140, 250, 600 and 1000 mm. This ensures maximum reliability exactly where it is needed in the application.

You are not sure where you want to set the focus range or need the whole measuring range? Then we recommend the basic-type.

#### OM70-P/L0070

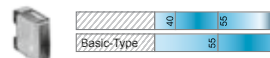

#### OM70-P/L0140

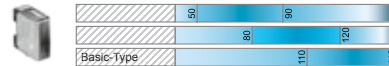

#### OM70-P/L0250

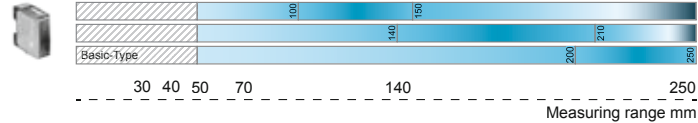

#### OM70-P/L0600



#### OM70-P/L1000

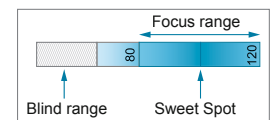
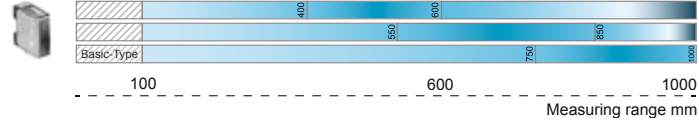



## Mounting and adjustment

In all distance-measuring sensors, care must be taken to ensure that the laser spot can be directly picked up by the optical system of the receiver and that there are no obstacles in front of the receiver.

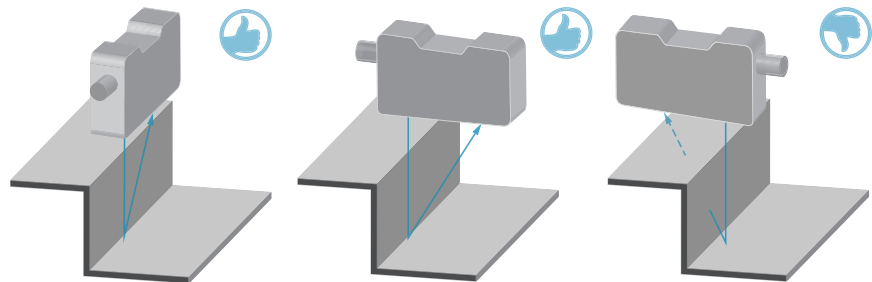

With shiny or reflective surfaces, the reflection may not strike the receiver directly. This can be avoided by tilting the sensor slightly. For optimum measurement results, the sensor must be installed perpendicular to the movement of the object.

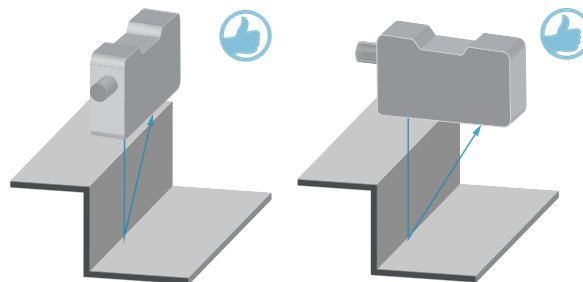

A simple rule applies for triangulation sensors that the distance between the sensor and the object should be kept as small as possible in each application. The shorter the range, the better (more than proportional) the resolution and accuracy.

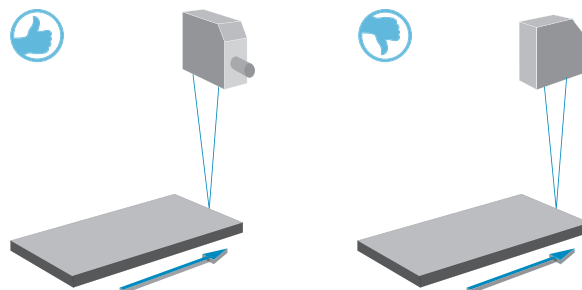

Note on electromagnetic compatibility: Earth the sensor and use a shielded connecting cable.



## Mounting and adjustment

In many applications, several sensors have to be mounted close together. Baumer distance sensors can be arranged side by side without interfering with one another. If mutual interference caused by the installation cannot be avoided, then the sensors can be operated asynchronously using the synchronized input.

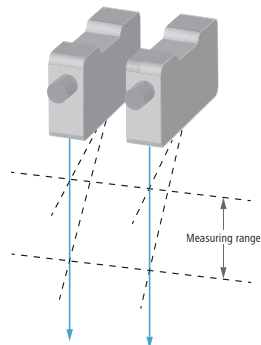

## Parameterization

Baumer's optical distance sensors have not only analog but also digital interfaces, through which the sensors are parameterized and directly integrated into the existing production environment.

### Teach-Button / *qTeach*<sup>®</sup>

Depending on the application, optical distance sensors which only have one analog output can be restricted in their range and thus re-taught or taught in. This may result in greater accuracy, and thus increased process safety can also be achieved. This is done either using a teach-in button or by means of the contactless *qTeach*<sup>®</sup> function.

### Parameterization by means of the display

An innovative touch display offers the option of setting functions and parameters directly on the display. Depending on the arrangement, this ensures a quick and easy start-up.

- Type of measurement
- Light / dark object
- Filter values
- Analog / digital output



### RS 485

The RS 485 serial interface as a bidirectional bus system allows up to 31 sensors to be connected or parameterized. RS 485 also provides fast data transfer of up to 3 Mbit/s, even over longer distances; measured rates of up to 2.5 kHz can be supported in the application.

### IO-Link

IO-Link allows simple and cost-effective parameterization of optical distance sensors by the PLC. The connection is established by means of a conventional 3-pole M12 cable. Thanks to the standardized interface, IO-Link offers an efficient way to integrate the distance sensors quickly by means of a master at field bus level.



## Special features

### High ambient light immunity

Powerful algorithms integrated in the sensor make laser distance sensors very insensitive to external light sources. This guarantees reliable, robust operation.

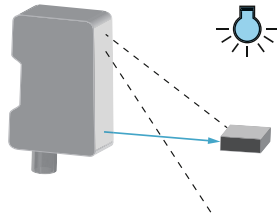

### Automatic exposure control

Optical distance sensors by Baumer automatically adapt to different object colors and brightness levels by varying their transmission intensity and optimizing their exposure time. This means they are not affected by the reflectivity of an object. It is also possible to measure objects with a reflectivity of up to 2%.

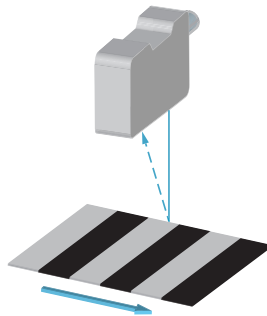

### Sync-in / triggering

The measurements of several sensors can be synchronized through the sync-in input. For thickness measurements, two sensors can be triggered simultaneously in synchronous mode through the sync input. In asynchronous mode, on the other hand, several sensors that interfere with each other in an application can deliberately be operated one after the other.

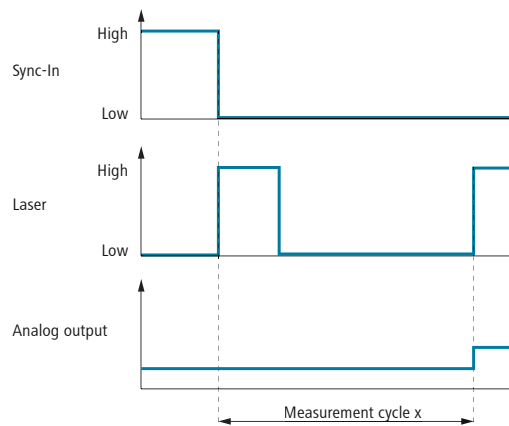





## Special features

### Programmable filter functions

The noise of the output signal can be reduced by activating filtering, thus increasing the resolution. The filter is used to suppress measurement errors. The output changes only after a defined number of measured values. The measuring frequency is not affected by this filter, but the response time is. The filter function can be parameterized through the selection of predefined precision modes.

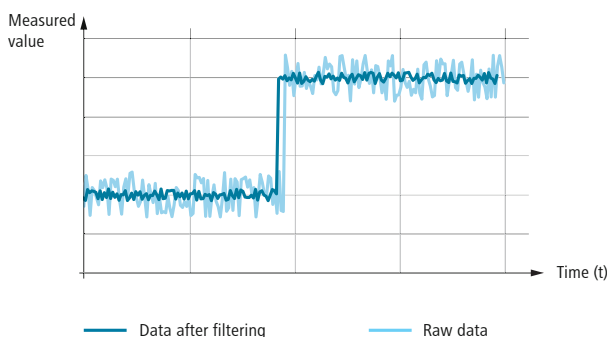

### Programmable measuring ranges

The measuring range can be adjusted by the user within the maximum measuring range with the teach-in button, the teach-in line or through the display. The analog output has its full stroke within this taught-in area and thus higher measuring accuracy. The factory setting is the maximum measuring range.

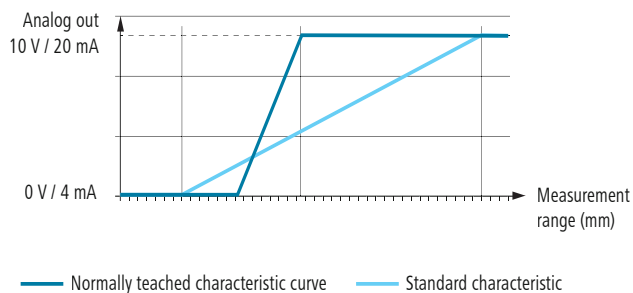

### Configurable switched output

A switched output should switch as soon as a defined measured value exceeds or falls below the set level. For a reliable switching signal, the hysteresis (difference between the switching point and the return switching point) can be parameterized in millimeters in absolute terms. The safe operation of your system is guaranteed, regardless of the position of the object in the field of view.

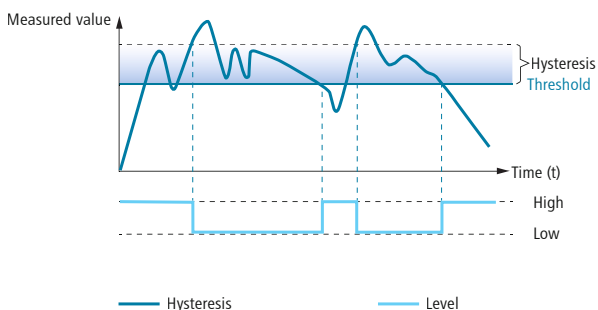

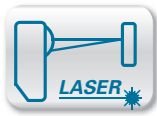

**Sd = 16 ... 120 mm**

- smallest distance measuring sensor
- teachable measuring range  $S_r > 1$  mm
- resolution up to  $2 \mu\text{m}$



**general data**

adjustment	Teach-in: button / external
power on indication	LED green
soiled lens indicator	LED red
light source	pulsed red laser diode
wave length	650 nm
laser class	2
beam type	point
interference suppression	< 30 ms

**measuring distance Sd = 16 ... 26 mm**

Teach-in range min.	> 1 mm
resolution	0,002 ... 0,005 mm
linearity error	$\pm 0,006 \dots \pm 0,015$ mm
beam diameter	0,5 ... 0,2 mm
temperature drift	< 0,04 % Sde/K

**measuring distance Sd = 16 ... 120 mm**

Teach-in range min.	> 2 mm
resolution	0,002 ... 0,12 mm
linearity error	$\pm 0,015 \dots \pm 0,35$ mm
beam diameter	0,9 ... 0,5 mm
temperature drift	< 0,06 % Sde/K

**electrical data**

response time / release time	< 0,9 ms
voltage supply range +Vs	12 ... 28 VDC
current consumption max. (no load)	100 mA
output circuit	analog
short circuit protection	yes
reverse polarity protection	yes, Vs to GND

**mechanical data**

width / diameter	12,4 mm
height / length	37 mm
depth	34,5 mm
type	rectangular
housing material	die-cast zinc
front (optics)	glass
connection types	connector M8 4 pin

**ambient conditions**

operating temperature	0 ... +50 °C
protection class	IP 67

**connection diagrams**

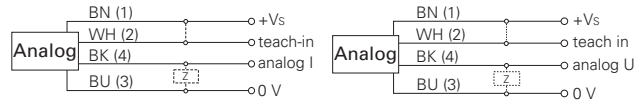

**connectors and mating connectors**

ESG 32AH0200G	Connector M8, 4 pin, straight, 2 m, shielded
ESW 31AH0200G	Connector M8, 4 pin, angular, 2 m, shielded

additional cable connectors and field wireable connectors: see accessories

**Accessories**

10150328	Sensofix series 12
10113873	Mounting bracket series 12 (L design)

for details: see accessories section

**remarks**

For objects with a reflectivity < 4 %, the response time / release time is increased automatically up to max. 1,5 ms. Missed measurement up to 30 cycles (30 ms) will be suppressed. During this time the analog output stays on hold.

**laser warning**

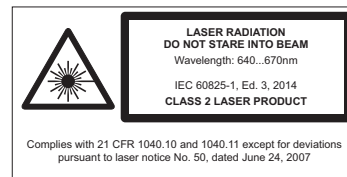

order reference	measuring distance Sd	output signal	load resistance	ambient light immunity
OADM 12I6430/S35A	16 ... 26 mm	4 ... 20 mA	< (+Vs - 6 V) / 0,02 A	< 100 kLux
OADM 12I6460/S35A	16 ... 120 mm	4 ... 20 mA	< (+Vs - 6 V) / 0,02 A	< 30 kLux
OADM 12U6430/S35A	16 ... 26 mm	0 ... 10 VDC	> 100 kOhm	< 100 kLux
OADM 12U6460/S35A	16 ... 120 mm	0 ... 10 VDC	> 100 kOhm	< 30 kLux

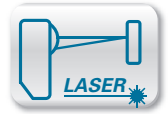

resolution

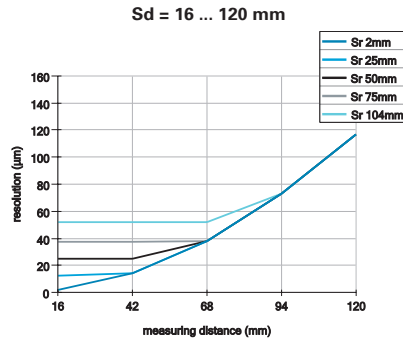
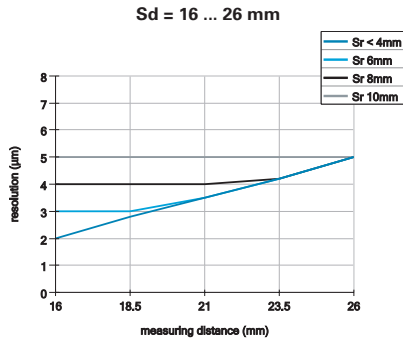

linearity errors

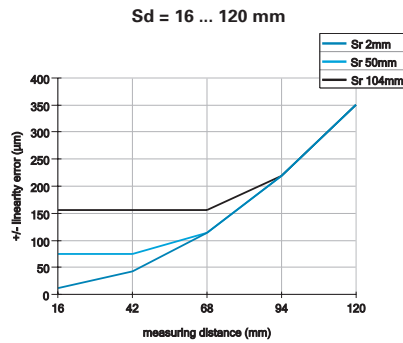
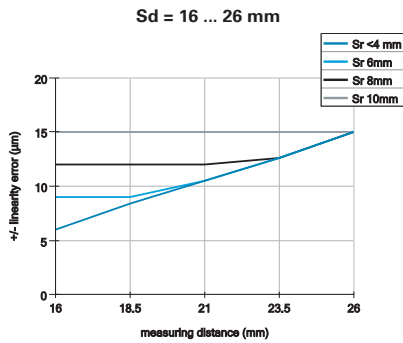

dimension drawing

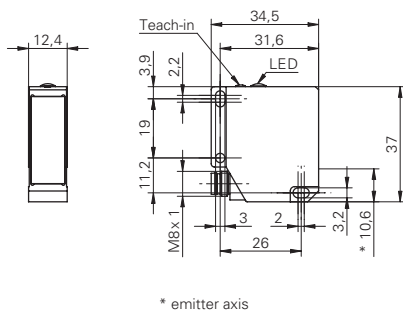

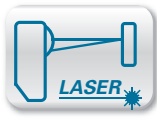

**Sd = 16 ... 120 mm**

- smallest distance measuring sensor
- teachable measuring range  $S_r > 1$  mm
- resolution up to 2  $\mu$ m



**general data**

adjustment	Teach-in: button / external
power on indication	LED green
soiled lens indicator	LED red
light source	pulsed red laser diode
wave length	650 nm
laser class	1
beam type	point
interference suppression	< 30 ms

**measuring distance Sd = 16 ... 26 mm**

Teach-in range min.	> 1 mm
resolution	0,002 ... 0,005 mm
linearity error	$\pm 0,013$ ... $\pm 0,025$ mm
beam diameter	0,5 ... 0,2 mm
temperature drift	< 0,04 % Sde/K

**measuring distance Sd = 16 ... 120 mm**

Teach-in range min.	> 2 mm
resolution	0,002 ... 0,12 mm
linearity error	$\pm 0,015$ ... $\pm 0,35$ mm
beam diameter	0,9 ... 0,5 mm
temperature drift	< 0,06 % Sde/K

**electrical data**

response time / release time	2 ... 3 ms
voltage supply range +Vs	12 ... 28 VDC
output circuit	analog
short circuit protection	yes
reverse polarity protection	yes, Vs to GND

**mechanical data**

width / diameter	12,4 mm
height / length	37 mm
depth	34,5 mm
type	rectangular
housing material	die-cast zinc
front (optics)	glass
connection types	connector M8 4 pin

**ambient conditions**

ambient light immunity	< 50 kLux
operating temperature	0 ... +50 °C
protection class	IP 67

**connection diagrams**

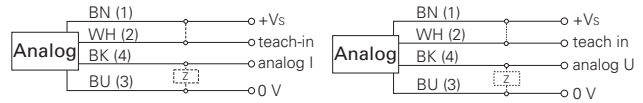

**connectors and mating connectors**

ESG 32AH0200G	Connector M8, 4 pin, straight, 2 m, shielded
ESW 31AH0200G	Connector M8, 4 pin, angular, 2 m, shielded

additional cable connectors and field wireable connectors: see accessories

**Accessories**

10150328	Sensofix series 12
10113873	Mounting bracket series 12 (L design)

for details: see accessories section

**laser warning**



IEC 60825-1/2014  
Complies with 21 CFR 1040.10 and 1040.11  
except for deviations pursuant to laser  
notice No. 50, dated June 24, 2007

order reference	measuring distance Sd	output signal	current consumption max. (no load)	load resistance
OADM 12I7430/S35A	16 ... 26 mm	4 ... 20 mA	100 mA	< (+Vs - 6 V) / 0,02 A
OADM 12I7460/S35A	16 ... 120 mm	4 ... 20 mA	100 mA	< (+Vs - 6 V) / 0,02 A
OADM 12U7430/S35A	16 ... 26 mm	0 ... 10 VDC	80 mA	> 100 kOhm
OADM 12U7460/S35A	16 ... 120 mm	0 ... 10 VDC	80 mA	> 100 kOhm

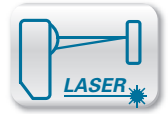

resolution

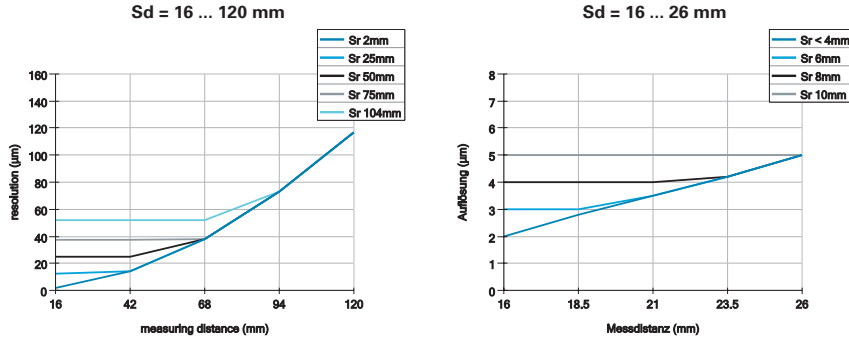

linearity errors

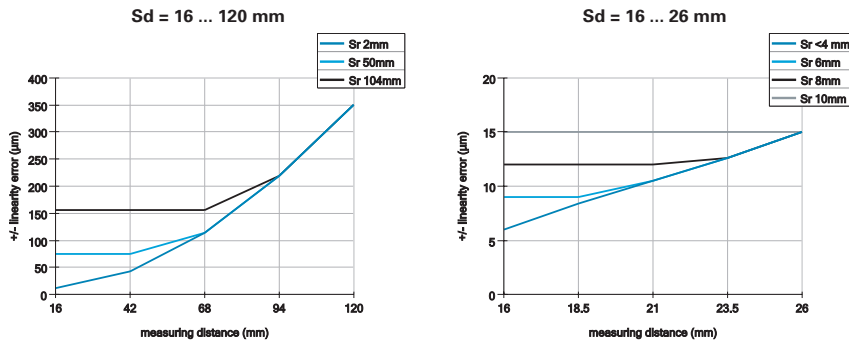

dimension drawing

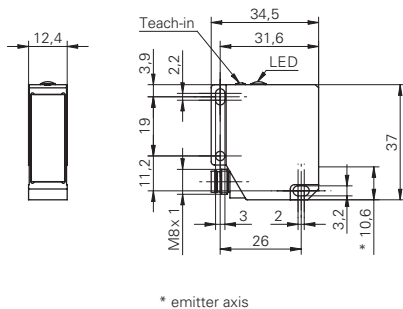

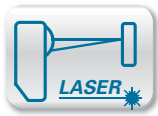

Sd = 16 ... 120 mm

- smallest distance measuring sensor
- serial interface RS 485
- resolution up to 4 µm



**general data**

adjustment	RS 485
power on indication	LED green
light source	pulsed red laser diode
wave length	650 nm
laser class	1
beam type	point
interference suppression	< 30 ms
alarm indicator	LED red

**measuring distance Sd = 16 ... 26 mm**

resolution	0,004 ... 0,008 mm
linearity error	± 0,013 ... ± 0,025 mm
beam diameter	0,5 ... 0,2 mm
temperature drift	< 0,04 % Sde/K

**measuring distance Sd = 30 ... 50 mm**

resolution	0,01 ... 0,026 mm
linearity error	± 0,032 ... ± 0,078 mm
beam diameter	0,7 ... 0,4 mm
temperature drift	< 0,06 % Sde/K

**measuring distance Sd = 16 ... 120 mm**

resolution	0,012 ... 0,12 mm
linearity error	± 0,026 ... ± 0,35 mm
beam diameter	0,9 ... 0,5 mm
temperature drift	< 0,06 % Sde/K

**electrical data**

voltage supply range +Vs	12 ... 28 VDC
current consumption max. (no load)	80 mA
output circuit	RS 485
baud rate	38400, adjustable
short circuit protection	yes
reverse polarity protection	yes, Vs to GND

**mechanical data**

width / diameter	12,4 mm
height / length	37 mm
depth	34,5 mm
type	rectangular
housing material	die-cast zinc
front (optics)	glass
connection types	connector M8 4 pin

**ambient conditions**

ambient light immunity	< 50 kLux
operating temperature	0 ... +50 °C
protection class	IP 67

**connection diagram**

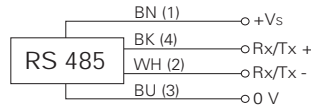

**connectors and mating connectors**

ESG 32AH0200G	Connector M8, 4 pin, straight, 2 m, shielded
ESW 31AH0200G	Connector M8, 4 pin, angular, 2 m, shielded
additional cable connectors and field wireable connectors: see accessories	

**Accessories**

10150328	Sensofix series 12
10113873	Mounting bracket series 12 (L design)
for details: see accessories section	

**laser warning**



IEC 60825-1/2014  
Complies with 21 CFR 1040.10 and 1040.11  
except for deviations pursuant to laser  
notice No. 50, dated June 24, 2007

order reference	measuring distance Sd	response time / release time
OADM 12S7430/S35A	16 ... 26 mm	< 1,8 ms
OADM 12S7440/S35A	30 ... 50 mm	< 1,8 ms
OADM 12S7460/S35A	16 ... 120 mm	< 3 ms

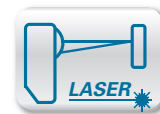

## resolution

Sd = 16 ... 120 mm

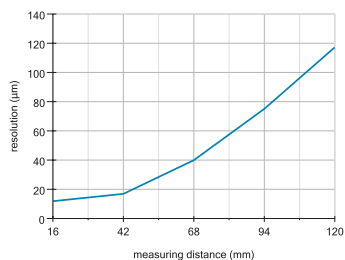

Sd = 30 ... 50 mm

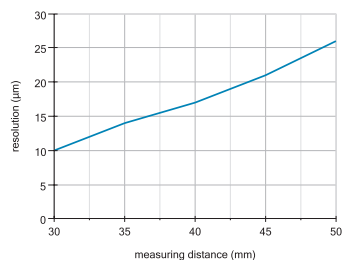

Sd = 16 ... 28 mm

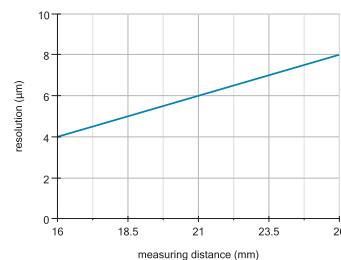

## linearity errors

Sd = 16 ... 120 mm

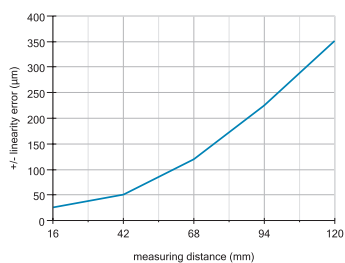

Sd = 30 ... 50 mm

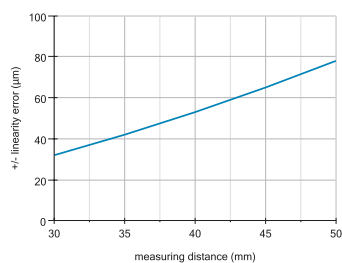

Sd = 16 ... 28 mm

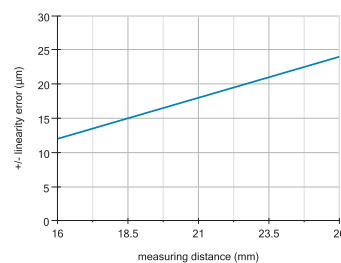

## dimension drawing

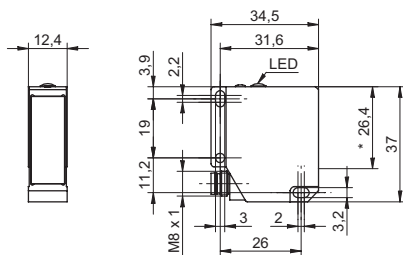

\* emitter axis

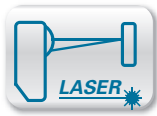

Sd = 50 ... 550 mm



- compact housing, current output
- teachable measuring range  $S_r > 5$  mm
- resolution up to 10  $\mu$ m

**general data**

adjustment	Teach-in: button / external
power on indication	LED green
soiled lens indicator	LED red
light source	pulsed red laser diode
wave length	650 nm
laser class	2
interference suppression	< 30 ms

**measuring distance Sd = 50 ... 350 mm**

Teach-in range min.	> 5 mm
resolution	0,01 ... 0,4 mm
linearity error	$\pm 0,05$ ... $\pm 1,2$ mm
temperature drift	< 0,04 % Sde/K

**measuring distance Sd = 50 ... 550 mm**

Teach-in range min.	> 10 mm
resolution	0,01 ... 1,15 mm
linearity error	$\pm 0,08$ ... $\pm 3,5$ mm
temperature drift	< 0,07 % Sde/K

**electrical data**

voltage supply range +Vs	12 ... 28 VDC
current consumption max. (no load)	100 mA
output circuit	analog
output signal	4 ... 20 mA
load resistance	< $(+Vs - 6 V) / 0,02 A$
short circuit protection	yes
reverse polarity protection	yes, Vs to GND

**mechanical data**

width / diameter	13,4 mm
height / length	48,2 mm
depth	40 mm
type	rectangular
housing material	aluminum
front (optics)	glass
connection types	connector M8 4 pin

**ambient conditions**

operating temperature	0 ... +50 °C
protection class	IP 67

**connection diagram**

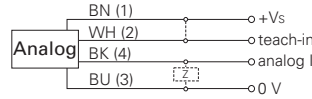

**connectors and mating connectors**

ESG 32AH0200G	Connector M8, 4 pin, straight, 2 m, shielded
ESW 31AH0200G	Connector M8, 4 pin, angular, 2 m, shielded

additional cable connectors and field wireable connectors: see accessories

**Accessories**

10161829	Sensofix series 13
10161695	Mounting bracket for sensors series 13 (L design)

for details: see accessories section

**remarks**

For objects with a reflectivity < 6 %, the response time / release time is increased automatically up to max. 3 ms (OADM 13x6x75/S35A) resp. 5 ms (OADM 13x7x80/S35A). Missed measurement up to 30 cycles (30 ms) will be suppressed. During this time the analog output stays on hold.

**laser warning**

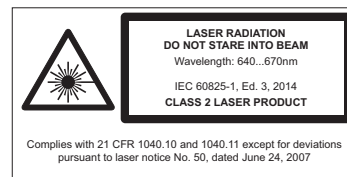

order reference	measuring distance Sd	response time / release time	beam type	beam width	beam height	beam diameter	ambient light immunity
OADM 13I6475/S35A	50 ... 350 mm	< 0,9 ms	point	-	-	1 mm	< 20 kLux
OADM 13I6575/S35A	50 ... 350 mm	< 0,9 ms	line	2 mm	4 ... 9 mm	-	< 30 kLux
OADM 13I7480/S35A	50 ... 550 mm	< 2 ms	point	-	-	1 mm	< 40 kLux
OADM 13I7580/S35A	50 ... 550 mm	< 2 ms	line	2 ... 1 mm	4 ... 11 mm	-	< 40 kLux



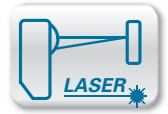

resolution

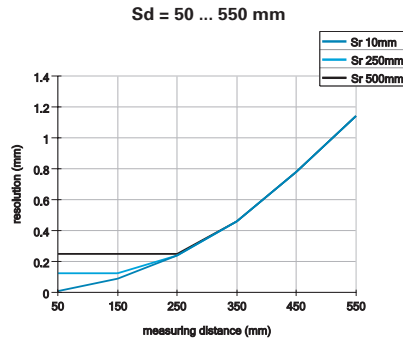
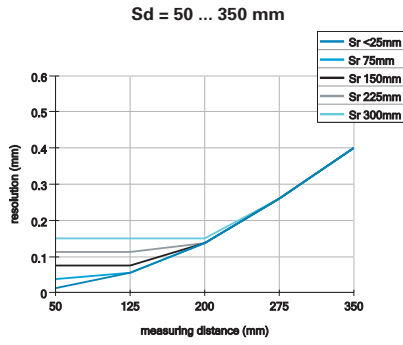

linearity errors

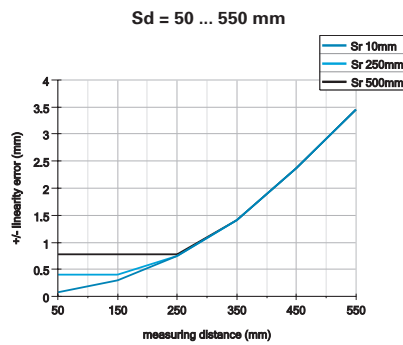
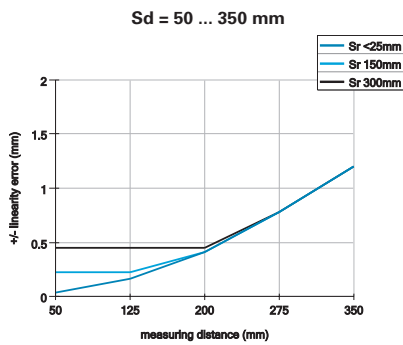

beam alignment (line)

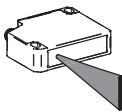

dimension drawing

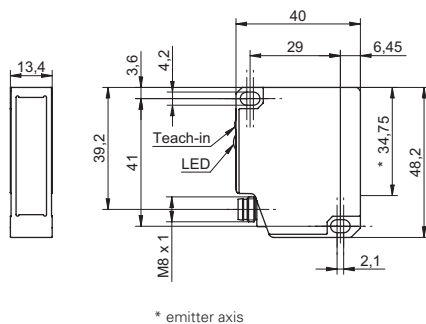

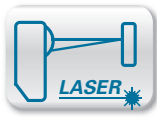

Sd = 50 ... 550 mm



- compact housing, voltage output
- teachable measuring range  $S_r > 5$  mm
- resolution up to 10  $\mu$ m

**general data**

adjustment	Teach-in: button / external
power on indication	LED green
soiled lens indicator	LED red
light source	pulsed red laser diode
wave length	650 nm
laser class	2
interference suppression	< 30 ms

**measuring distance Sd = 50 ... 350 mm**

Teach-in range min.	> 5 mm
resolution	0,01 ... 0,4 mm
linearity error	$\pm 0,05$ ... $\pm 1,2$ mm
temperature drift	< 0,04 % Sde/K

**measuring distance Sd = 50 ... 550 mm**

Teach-in range min.	> 10 mm
resolution	0,01 ... 1,15 mm
linearity error	$\pm 0,08$ ... $\pm 3,5$ mm
temperature drift	< 0,07 % Sde/K

**electrical data**

voltage supply range +Vs	12 ... 28 VDC
current consumption max. (no load)	80 mA
output circuit	analog
output signal	0 ... 10 VDC
load resistance	> 100 kOhm
short circuit protection	yes
reverse polarity protection	yes, Vs to GND

**mechanical data**

width / diameter	13,4 mm
height / length	48,2 mm
depth	40 mm
type	rectangular
housing material	aluminum
front (optics)	glass
connection types	connector M8 4 pin

**ambient conditions**

operating temperature	0 ... +50 °C
protection class	IP 67

**connection diagram**

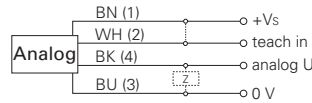

**connectors and mating connectors**

ESG 32AH0200G	Connector M8, 4 pin, straight, 2 m, shielded
ESW 31AH0200G	Connector M8, 4 pin, angular, 2 m, shielded

additional cable connectors and field wireable connectors: see accessories

**Accessories**

10161829	Sensofix series 13
10161695	Mounting bracket for sensors series 13 (L design)

for details: see accessories section

**remarks**

For objects with a reflectivity < 6 %, the response time / release time is increased automatically up to max. 3 ms (OADM 13x6x75/S35A) resp. 5 ms (OADM 13x7x80/S35A). Missed measurement up to 30 cycles (30 ms) will be suppressed. During this time the analog output stays on hold.

**laser warning**

order reference	measuring distance Sd	response time / release time	beam type	beam width	beam height	beam diameter	ambient light immunity
OADM 13U6475/S35A	50 ... 350 mm	< 0,9 ms	point	-	-	1 mm	< 20 kLux
OADM 13U6575/S35A	50 ... 350 mm	< 0,9 ms	line	2 mm	4 ... 9 mm	-	< 30 kLux
OADM 13U7480/S35A	50 ... 550 mm	< 2 ms	point	-	-	1 mm	< 40 kLux
OADM 13U7580/S35A	50 ... 550 mm	< 2 ms	line	2 ... 1 mm	4 ... 11 mm	-	< 40 kLux

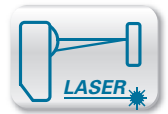

resolution

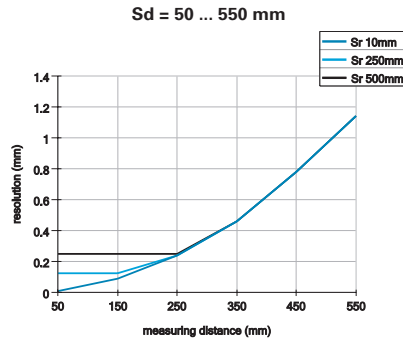
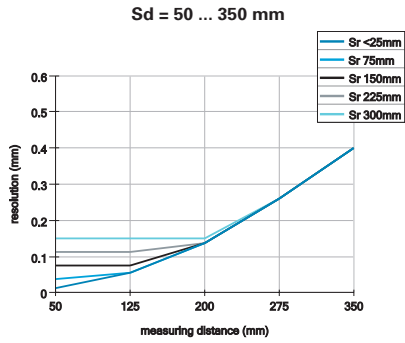

linearity errors

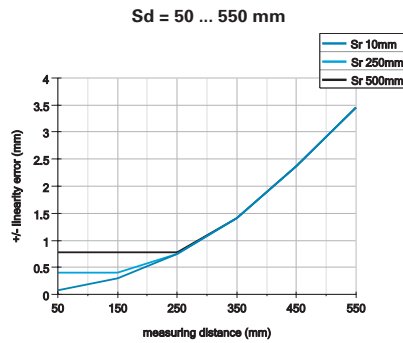
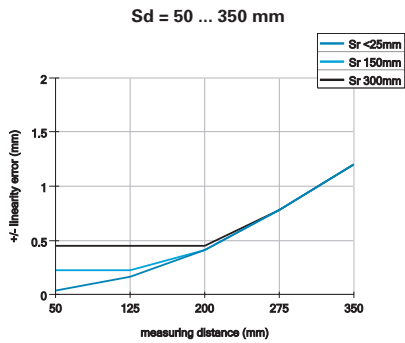

beam alignment (line)

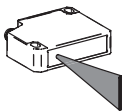

dimension drawing

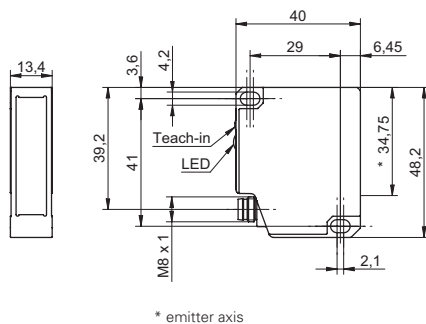

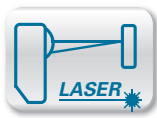

Sd = 50 ... 550 mm



- serial interface RS 232
- resolution up to 50 µm
- also with laser line for rough surfaces

**general data**

adjustment	RS 232
power on indication	LED green
light source	pulsed red laser diode
wave length	650 nm
laser class	2
alarm indicator	LED red

**measuring distance Sd = 50 ... 350 mm**

resolution	0,05 ... 0,4 mm
linearity error	± 0,18 ... ± 1,2 mm
temperature drift	< 0,04 % Sde/K

**measuring distance Sd = 50 ... 550 mm**

resolution	0,09 ... 1,15 mm
linearity error	± 0,3 ... ± 3,5 mm
temperature drift	< 0,07 % Sde/K

**electrical data**

voltage supply range +Vs	12 ... 28 VDC
current consumption max. (no load)	80 mA
output circuit	RS 232
baud rate	38400, adjustable
short circuit protection	yes
reverse polarity protection	yes, Vs to GND

**mechanical data**

width / diameter	13,4 mm
height / length	48,2 mm
depth	40 mm
type	rectangular
housing material	aluminum
front (optics)	glass
connection types	connector M8 4 pin

**ambient conditions**

operating temperature	0 ... +50 °C
protection class	IP 67

**connection diagram**

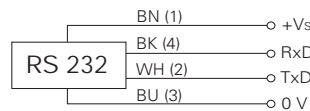

**connectors and mating connectors**

ESG 32AH0200G	Connector M8, 4 pin, straight, 2 m, shielded
ESW 31AH0200G	Connector M8, 4 pin, angular, 2 m, shielded

additional cable connectors and field wireable connectors: see accessories

**Accessories**

10161829	Sensofix series 13
10161695	Mounting bracket for sensors series 13 (L design)

for details: see accessories section

**laser warning**

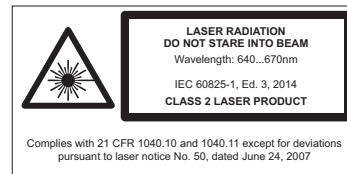

order reference	measuring distance Sd	response time / release time	beam type	beam width	beam height	beam diameter	ambient light immunity
OADM 13T6475/S35A	50 ... 350 mm	< 0,9 ms	point	-	-	1 mm	< 20 kLux
OADM 13T6575/S35A	50 ... 350 mm	< 0,9 ms	line	2 mm	4 ... 9 mm	-	< 30 kLux
OADM 13T7480/S35A	50 ... 550 mm	< 2 ms	point	-	-	1 mm	< 100 kLux
OADM 13T7580/S35A	50 ... 550 mm	< 2 ms	line	2 mm	4 ... 13 mm	-	< 100 kLux

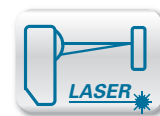

## resolution

Sd = 50 ... 350 mm

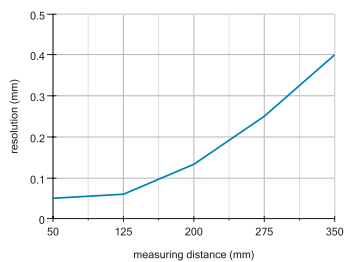

Sd = 50 ... 550 mm

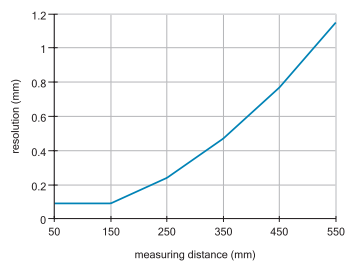

## linearity errors

Sd = 50 ... 350 mm

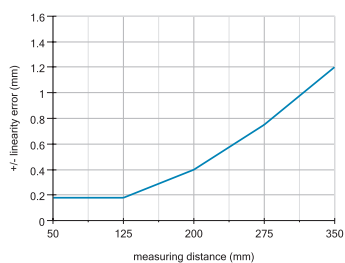

Sd = 50 ... 550 mm

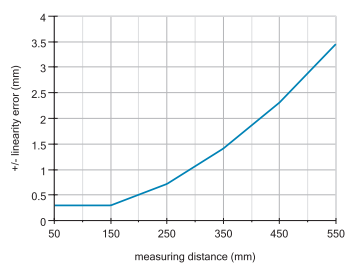

## beam alignment (line)

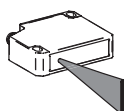

## dimension drawing

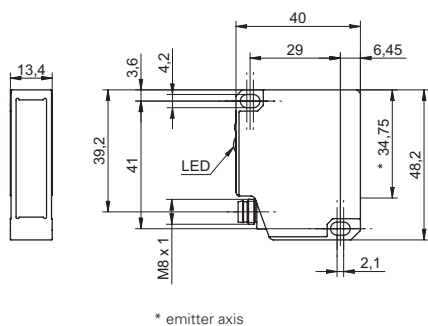

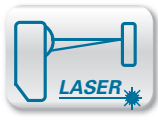

Sd = 50 ... 550 mm



- serial interface RS 485
- resolution up to 50 µm
- also with laser line for rough surfaces

**general data**

adjustment	RS 485
power on indication	LED green
light source	pulsed red laser diode
wave length	650 nm
laser class	2
alarm indicator	LED red

**measuring distance Sd = 50 ... 350 mm**

resolution	0,05 ... 0,4 mm
linearity error	± 0,18 ... ± 1,2 mm
temperature drift	< 0,04 % Sde/K

**measuring distance Sd = 50 ... 550 mm**

resolution	0,09 ... 1,15 mm
linearity error	± 0,3 ... ± 3,5 mm
temperature drift	< 0,07 % Sde/K

**electrical data**

voltage supply range +Vs	12 ... 28 VDC
current consumption max. (no load)	80 mA
output circuit	RS 485
baud rate	38400, adjustable
short circuit protection	yes
reverse polarity protection	yes, Vs to GND

**mechanical data**

width / diameter	13,4 mm
height / length	48,2 mm
depth	40 mm
type	rectangular
housing material	aluminum
front (optics)	glass
connection types	connector M8 4 pin

**ambient conditions**

operating temperature	0 ... +50 °C
protection class	IP 67

**connection diagram**

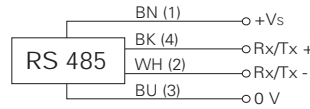

**connectors and mating connectors**

ESG 32AH0200G	Connector M8, 4 pin, straight, 2 m, shielded
ESW 31AH0200G	Connector M8, 4 pin, angular, 2 m, shielded

additional cable connectors and field wireable connectors: see accessories

**Accessories**

10161829	Sensofix series 13
10161695	Mounting bracket for sensors series 13 (L design)

for details: see accessories section

**laser warning**

order reference	measuring distance Sd	response time / release time	beam type	beam width	beam height	beam diameter	ambient light immunity
OADM 13S6475/S35A	50 ... 350 mm	< 0,9 ms	point	-	-	1 mm	< 20 kLux
OADM 13S6575/S35A	50 ... 350 mm	< 0,9 ms	line	2 mm	4 ... 9 mm	-	< 30 kLux
OADM 13S7480/S35A	50 ... 550 mm	< 2 ms	point	-	-	1 mm	< 100 kLux
OADM 13S7580/S35A	50 ... 550 mm	< 2 ms	line	2 mm	4 ... 13 mm	-	< 100 kLux

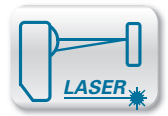

## resolution

Sd = 50 ... 350 mm

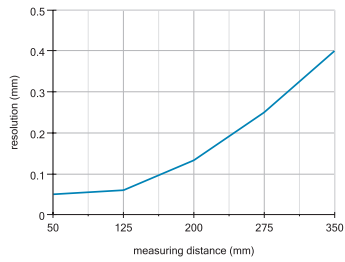

Sd = 50 ... 550 mm

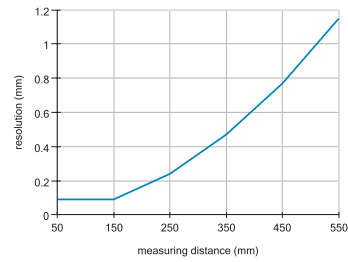

## linearity errors

Sd = 50 ... 350 mm

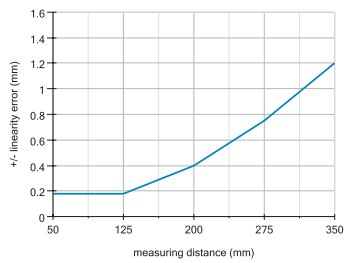

Sd = 50 ... 550 mm

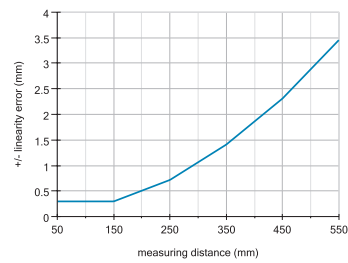

## beam alignment (line)

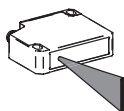

## dimension drawing

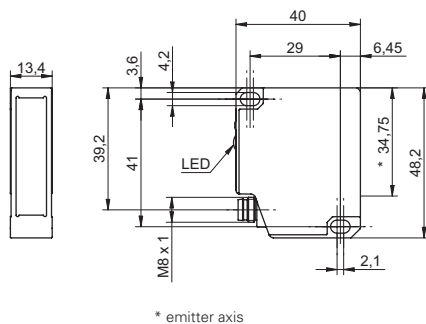

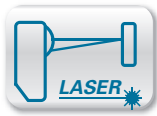

Sd = 50 ... 200 mm



- compact housing, current output
- high sensitivity
- fine laser line

**general data**

adjustment	Teach-in: button / external
power on indication	LED green
soiled lens indicator	LED red
light source	pulsed red laser diode
wave length	650 nm
laser class	1
beam type	line
interference suppression	< 30 ms
temperature drift	< 0,07 % Sde/K

**measuring distance Sd = 50 ... 60 mm**

Teach-in range min.	> 1 mm
resolution	< 0,015 mm
linearity error	< 0,045 mm
object reflectivity	> 0,5 %

**measuring distance Sd = 60 ... 100 mm**

Teach-in range min.	> 4 mm
resolution	0,015 ... 0,038 mm
linearity error	± 0,047 ... ± 0,118 mm
object reflectivity	> 0,8 %

**measuring distance Sd = 100 ... 200 mm**

Teach-in range min.	> 5 mm
resolution	0,039 ... 0,15 mm
linearity error	± 0,123 ... ± 0,457 mm
object reflectivity	> 2 %

**electrical data**

response time / release time	< 2 ms
voltage supply range +Vs	12 ... 28 VDC
current consumption max. (no load)	100 mA
output circuit	analog
output signal	4 ... 20 mA
load resistance	< (+Vs - 6 V) / 0,02 A
short circuit protection	yes
reverse polarity protection	yes, Vs to GND

**mechanical data**

width / diameter	13,4 mm
height / length	48,2 mm
depth	40 mm
type	rectangular
housing material	aluminum
front (optics)	glass
connection types	connector M8 4 pin

**ambient conditions**

ambient light immunity	< 100 kLux
operating temperature	0 ... +50 °C
protection class	IP 67

**connection diagram**

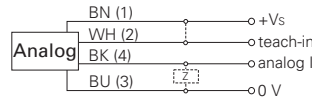

**connectors and mating connectors**

ESG 32AH0200G	Connector M8, 4 pin, straight, 2 m, shielded
ESW 31AH0200G	Connector M8, 4 pin, angular, 2 m, shielded

additional cable connectors and field wireable connectors: see accessories

**Accessories**

10161829	Sensofix series 13
10161695	Mounting bracket for sensors series 13 (L design)

for details: see accessories section

**remarks**

Missed measurement up to 15 cycles (30 ms) will be suppressed. During this time the analog output stays on hold.

**laser warning**



IEC 60825-1/2014  
Complies with 21 CFR 1040.10 and 1040.11  
except for deviations pursuant to laser  
notice No. 50, dated June 24, 2007



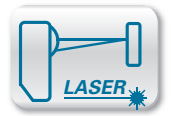

order reference	measuring distance Sd
OADM 13I7730/S35A	50 ... 60 mm
OADM 13I7745/S35A	60 ... 100 mm
OADM 13I7760/S35A	100 ... 200 mm

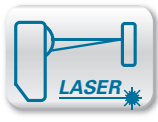

resolution

Sd = 50 ... 60 mm

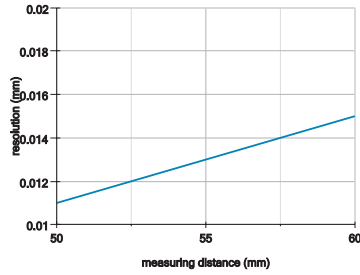

Sd = 60 ... 100 mm

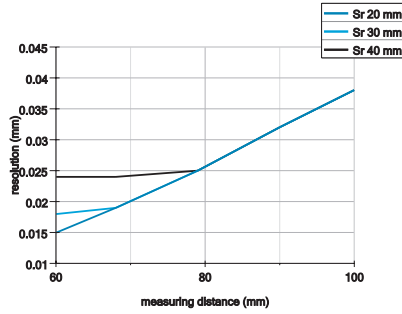

Sd = 100 ... 200 mm

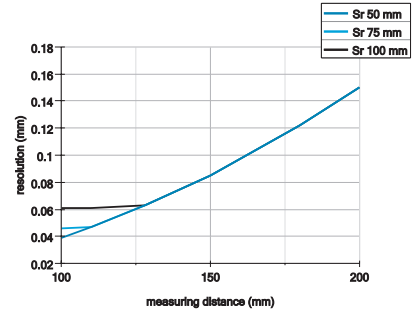

linearity errors

Sd = 50 ... 60 mm

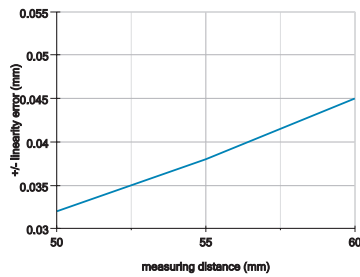

Sd = 60 ... 100 mm

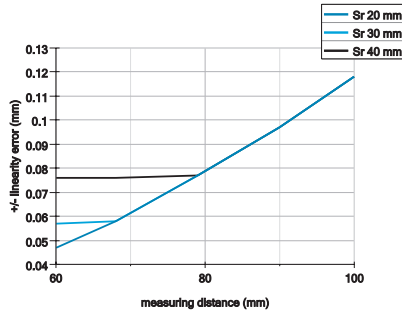

Sd = 100 ... 200 mm

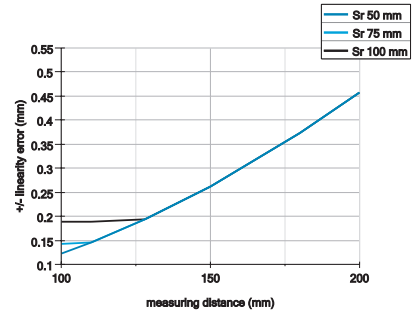

beam alignment (line)

Sd = 50 ... 60 mm

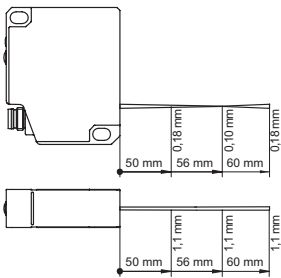

Sd = 60 ... 100 mm

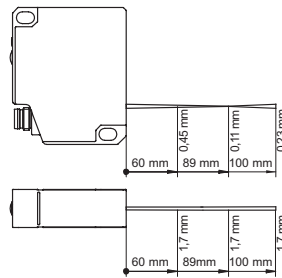

Sd = 100 ... 200 mm

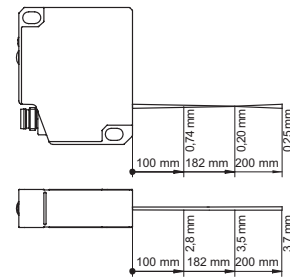

dimension drawing

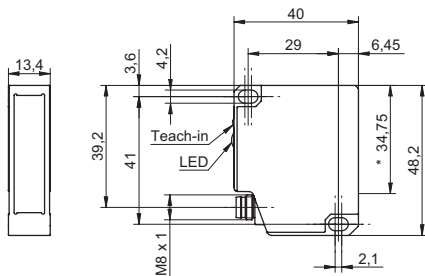

\* emitter axis

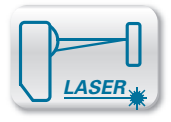

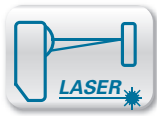

Sd = 50 ... 200 mm



- compact housing, voltage output
- high sensitivity
- fine laser line

**general data**

adjustment	Teach-in: button / external
power on indication	LED green
soiled lens indicator	LED red
light source	pulsed red laser diode
wave length	650 nm
laser class	1
beam type	line
interference suppression	< 30 ms
temperature drift	< 0,07 % Sde/K

**measuring distance Sd = 50 ... 60 mm**

Teach-in range min.	> 1 mm
resolution	< 0,015 mm
linearity error	< 0,045 mm
object reflectivity	> 0,5 %

**measuring distance Sd = 60 ... 100 mm**

Teach-in range min.	> 4 mm
resolution	0,015 ... 0,038 mm
linearity error	± 0,047 ... ± 0,118 mm
object reflectivity	> 0,8 %

**measuring distance Sd = 100 ... 200 mm**

Teach-in range min.	> 5 mm
resolution	0,039 ... 0,15 mm
linearity error	± 0,123 ... ± 0,457 mm
object reflectivity	> 2 %

**electrical data**

response time / release time	< 2 ms
voltage supply range +Vs	12 ... 28 VDC
current consumption max. (no load)	80 mA
output circuit	analog
output signal	0 ... 10 VDC
load resistance	> 100 kOhm
short circuit protection	yes
reverse polarity protection	yes, Vs to GND

**mechanical data**

width / diameter	13,4 mm
height / length	48,2 mm
depth	40 mm
type	rectangular
housing material	aluminum
front (optics)	glass
connection types	connector M8 4 pin

**ambient conditions**

ambient light immunity	< 100 kLux
operating temperature	0 ... +50 °C
protection class	IP 67

**connection diagram**

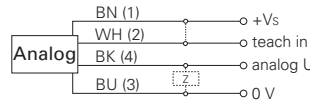

**connectors and mating connectors**

ESG 32AH0200G	Connector M8, 4 pin, straight, 2 m, shielded
ESW 31AH0200G	Connector M8, 4 pin, angular, 2 m, shielded

additional cable connectors and field wireable connectors: see accessories

**Accessories**

10161829	Sensofix series 13
10161695	Mounting bracket for sensors series 13 (L design)

for details: see accessories section

**remarks**

Missed measurement up to 15 cycles (30 ms) will be suppressed. During this time the analog output stays on hold.

**laser warning**



IEC 60825-1/2014  
Complies with 21 CFR 1040.10 and 1040.11  
except for deviations pursuant to laser  
notice No. 50, dated June 24, 2007

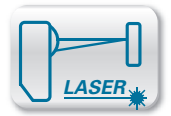

order reference	measuring distance Sd
OADM 13U7730/S35A	50 ... 60 mm
OADM 13U7745/S35A	60 ... 100 mm
OADM 13U7760/S35A	100 ... 200 mm

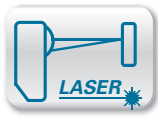

resolution

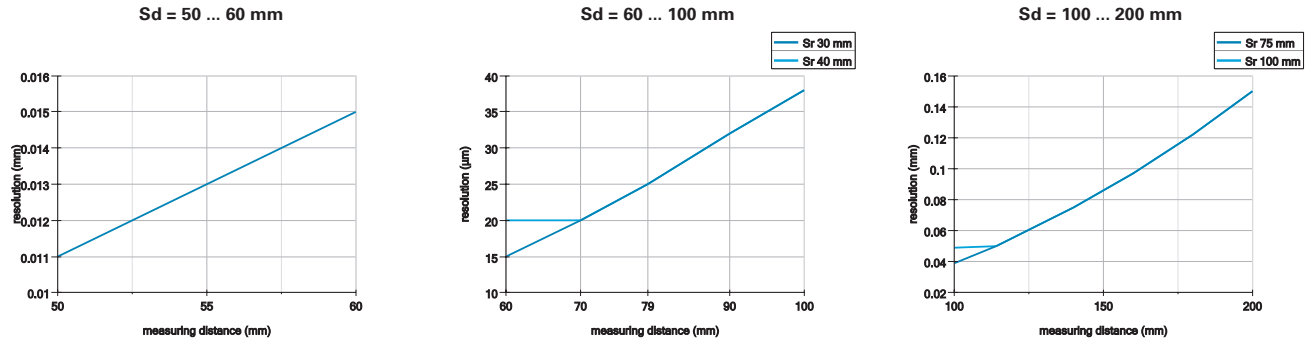

linearity errors

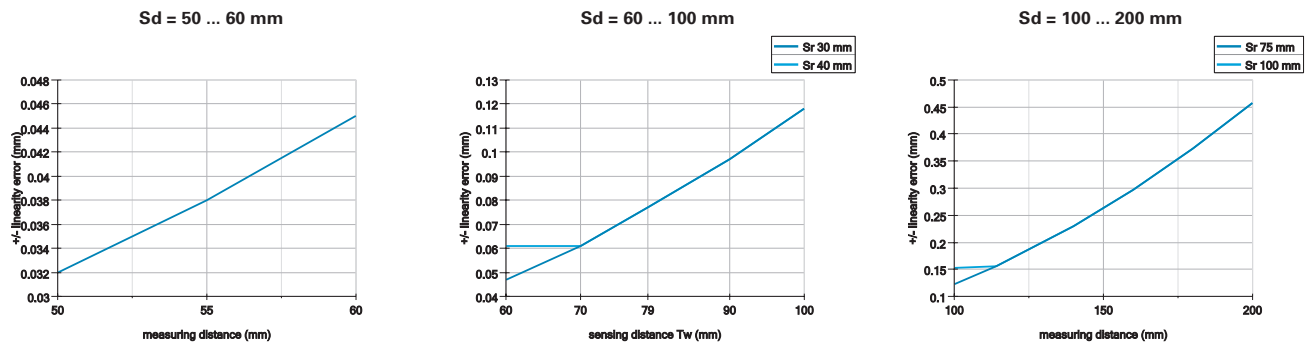

beam alignment (line)

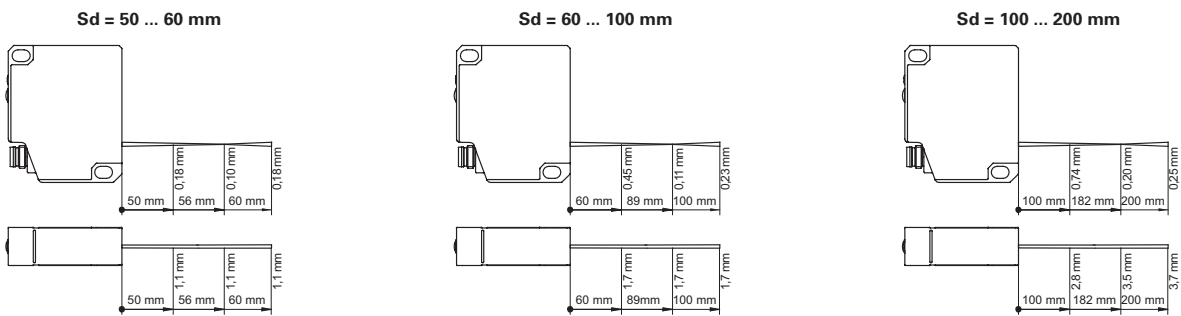

dimension drawing

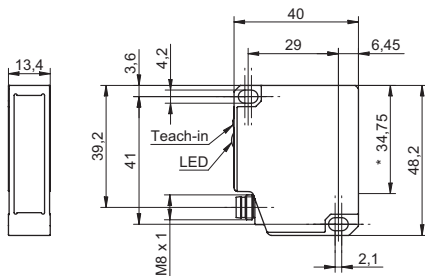

\* emitter axis

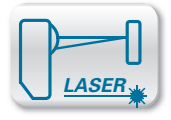

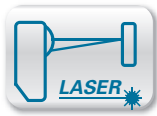

Sd = 30 ... 130 mm

- response time < 0,9 ms
- teachable measuring range Sr >2 mm



**general data**

adjustment	Teach-in: button / external
power on indication	LED green
soiled lens indicator	LED red
light source	pulsed red laser diode
wave length	650 nm
laser class	2
beam type	point

**measuring distance Sd = 30 ... 70 mm**

Teach-in range min.	> 2 mm
resolution	0,004 ... 0,02 mm
linearity error	± 0,012 ... ± 0,06 mm
beam diameter	1 ... 0,2 mm

**measuring distance Sd = 30 ... 130 mm**

Teach-in range min.	> 3 mm
resolution	0,005 ... 0,06 mm
linearity error	± 0,015 ... ± 0,2 mm
beam diameter	2 ... 1 mm

**electrical data**

response time / release time	< 0,9 ms
voltage supply range +Vs	12 ... 28 VDC
current consumption max. (no load)	100 mA
output circuit	analog
short circuit protection	yes
reverse polarity protection	yes, Vs to GND

**mechanical data**

width / diameter	20,6 mm
height / length	65 mm
depth	50 mm
type	rectangular
housing material	die-cast zinc
front (optics)	glass
connection types	connector M12 5 pin, rotatable

**ambient conditions**

operating temperature	0 ... +50 °C
protection class	IP 67

**connection diagram**

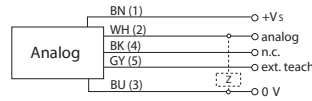

**connectors and mating connectors**

ESG 34CH0200G Connector M12, 5 pin, straight, 2 m, shielded  
 additional cable connectors and field wireable connectors: see accessories

**Accessories**

11010227	Mounting bracket OxDM 20
10156878	Protector cap OxDM 20

for details: see accessories section

**remarks**

Missed measurements up to 30 cycles will be suppressed. During this time the analog output stays on hold.

**laser warning**

order reference	measuring distance Sd	output signal	load resistance (analog U)	load resistance (analog I)
OADM 20I2441/S14C	30 ... 70 mm	4 ... 20 mA	-	< (+Vs - 6 V) / 0,02 A
OADM 20I2460/S14C	30 ... 130 mm	4 ... 20 mA	-	< (+Vs - 6 V) / 0,02 A
OADM 20U2441/S14C	30 ... 70 mm	0 ... 10 VDC	> 100 kOhm	-
OADM 20U2460/S14C	30 ... 130 mm	0 ... 10 VDC	> 100 kOhm	-



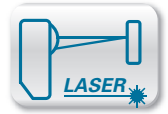

resolution

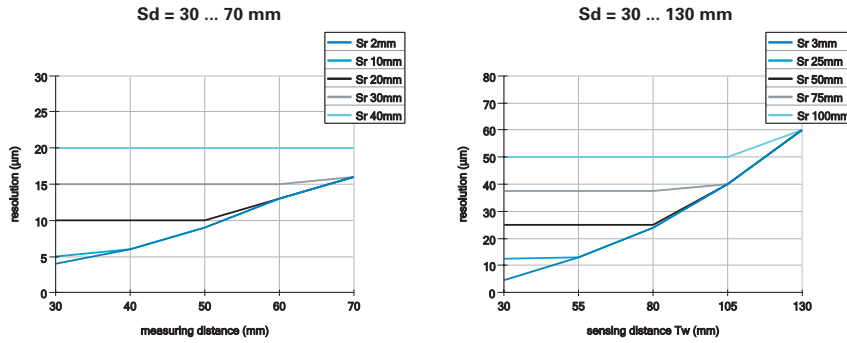

linearity errors

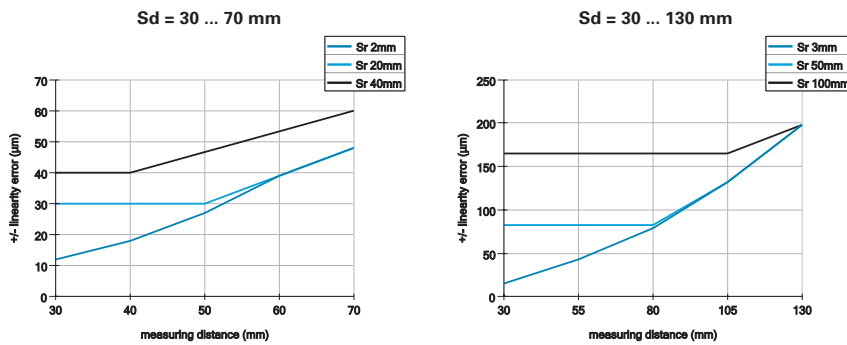

dimension drawing

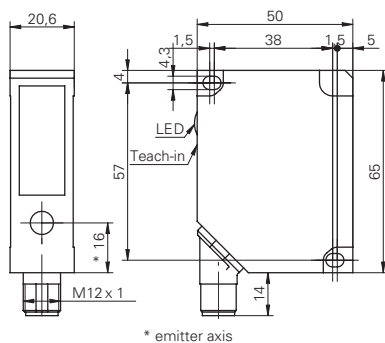

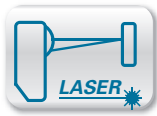

Sd = 50 ... 600 mm

- response time < 0,9 ms
- teachable measuring range Sr > 5 mm



**general data**

adjustment	Teach-in: button / external
power on indication	LED green
soiled lens indicator	LED red
light source	pulsed red laser diode
wave length	650 nm
laser class	2
beam type	point
beam diameter	2 mm

**measuring distance Sd = 50 ... 300 mm**

Teach-in range min.	> 5 mm
resolution	0,01 ... 0,33 mm
linearity error	± 0,03 ... ± 1 mm

**measuring distance Sd = 100 ... 600 mm**

Teach-in range min.	> 10 mm
resolution	0,015 ... 0,67 mm
linearity error	± 0,05 ... ± 2 mm

**electrical data**

response time / release time	< 0,9 ms
voltage supply range +Vs	12 ... 28 VDC
current consumption max. (no load)	100 mA
output circuit	analog
short circuit protection	yes
reverse polarity protection	yes, Vs to GND

**mechanical data**

width / diameter	20,6 mm
height / length	65 mm
depth	50 mm
type	rectangular
housing material	die-cast zinc
front (optics)	glass
connection types	connector M12 5 pin, rotatable

**ambient conditions**

operating temperature	0 ... +50 °C
protection class	IP 67

**connection diagram**

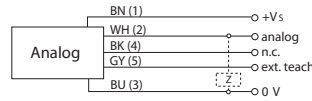

**connectors and mating connectors**

ESG 34CH0200G Connector M12, 5 pin, straight, 2 m, shielded  
 additional cable connectors and field wireable connectors: see accessories

**Accessories**

11010227	Mounting bracket OADM 20
10156878	Protector cap OADM 20

for details: see accessories section

**remarks**

For objects with a reflectivity < 7% (OADM 20x2480/S14C), the response / release time is increased automatically up to max. 2,8 ms. Missed measurements up to 30 cycles will be suppressed. During this time the analog output stays on hold.

**laser warning**

order reference	measuring distance Sd	output signal	load resistance (analog U)	load resistance (analog I)
OADM 20I2472/S14C	50 ... 300 mm	4 ... 20 mA	-	< (+Vs - 6 V) / 0,02 A
OADM 20I2480/S14C	100 ... 600 mm	4 ... 20 mA	-	< (+Vs - 6 V) / 0,02 A
OADM 20U2472/S14C	50 ... 300 mm	0 ... 10 VDC	> 100 kOhm	-
OADM 20U2480/S14C	100 ... 600 mm	0 ... 10 VDC	> 100 kOhm	-

OADM 20 Sd = 50 ... 600 mm Photoelectric distance measuring sensors

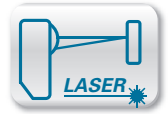

resolution

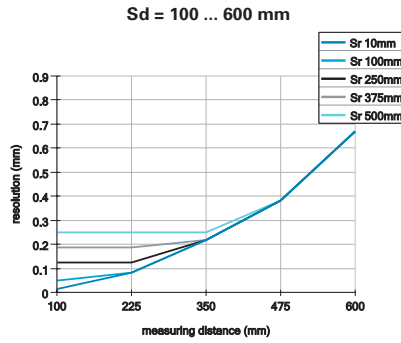
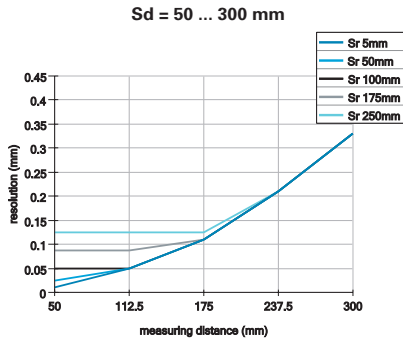

linearity errors

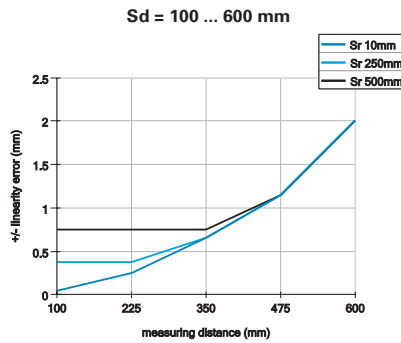
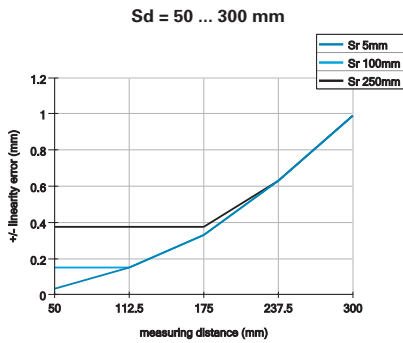

dimension drawing

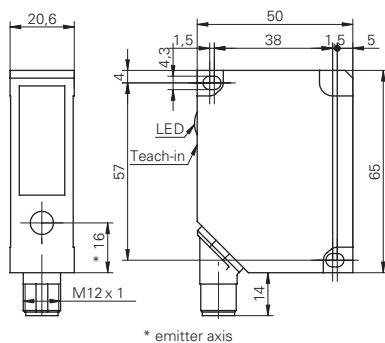

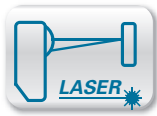

Sd = 30 ... 300 mm



- response time < 0,9 ms
- teachable measuring range  $S_r > 2$  mm
- resolution up to 4  $\mu$ m

**general data**

adjustment	Teach-in: button / external
power on indication	LED green
soiled lens indicator	LED red
light source	pulsed red laser diode
wave length	650 nm
laser class	2

**measuring distance Sd = 30 ... 70 mm**

Teach-in range min.	> 2 mm
resolution	0,004 ... 0,02 mm
linearity error	$\pm 0,012 \dots \pm 0,06$ mm
temperature drift	< 0,015 % Sde/K

**measuring distance Sd = 30 ... 130 mm**

Teach-in range min.	> 3 mm
resolution	0,005 ... 0,06 mm
linearity error	$\pm 0,015 \dots \pm 0,2$ mm
temperature drift	< 0,03 % Sde/K

**measuring distance Sd = 50 ... 300 mm**

Teach-in range min.	> 5 mm
resolution	0,01 ... 0,33 mm
linearity error	$\pm 0,03 \dots \pm 1$ mm
temperature drift	< 0,03 % Sde/K

**electrical data**

response time / release time	< 0,9 ms
voltage supply range +Vs	12 ... 28 VDC
current consumption max. (no load)	100 mA
output circuit	analog
output signal	4 ... 20 mA / 0 ... 10 VDC
load resistance (analog I)	< $(+Vs - 6 V) / 0,02 A$
load resistance (analog U)	> 100 kOhm
output current	< 100 mA
alarm output	PNP
short circuit protection	yes
reverse polarity protection	yes, Vs to GND

**mechanical data**

width / diameter	20,6 mm
height / length	65 mm
depth	50 mm
type	rectangular
housing material	die-cast zinc
front (optics)	glass
connection types	connector M12 8 pin, rotatable

**ambient conditions**

operating temperature	0 ... +50 °C
protection class	IP 67

**connection diagram**

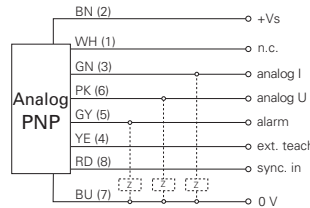

**connectors and mating connectors**

ESG 34FH0200G Connector M12, 8 pin, straight, 2 m, shielded  
 additional cable connectors and field wireable connectors: see accessories

**Accessories**

11010227	Mounting bracket OxDM 20
10156878	Protector cap OxDM 20

for details: see accessories section

**laser warning**

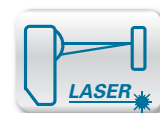

order reference	measuring distance Sd	beam type	beam width	beam height	beam diameter	ambient light immunity
OADM 20I6441/S14F	30 ... 70 mm	point	-	-	1 ... 0,2 mm	< 50 kLux
OADM 20I6460/S14F	30 ... 130 mm	point	-	-	2 ... 1 mm	< 40 kLux
OADM 20I6472/S14F	50 ... 300 mm	point	-	-	2 mm	< 8 kLux
OADM 20I6541/S14F	30 ... 70 mm	line	1 ... 0,2 mm	2 mm	-	< 50 kLux
OADM 20I6560/S14F	30 ... 130 mm	line	2 ... 1 mm	3 ... 5 mm	-	< 40 kLux
OADM 20I6572/S14F	50 ... 300 mm	line	2,5 mm	4 ... 12 mm	-	< 8 kLux

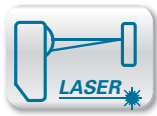

resolution

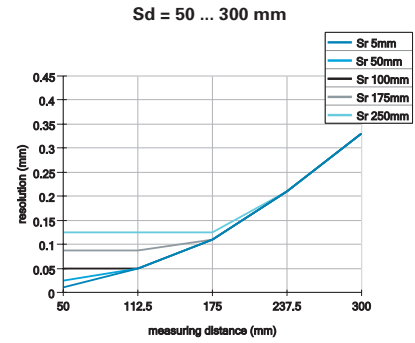
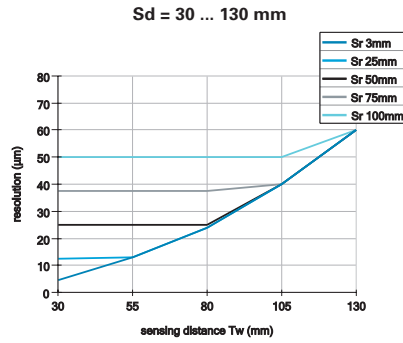
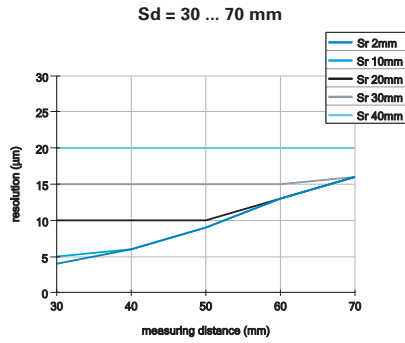

linearity errors

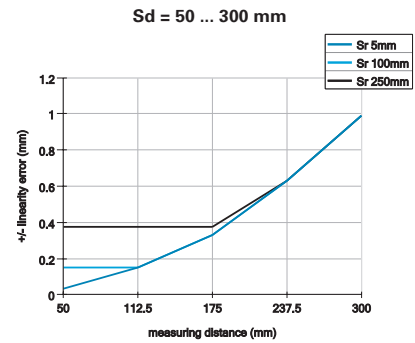
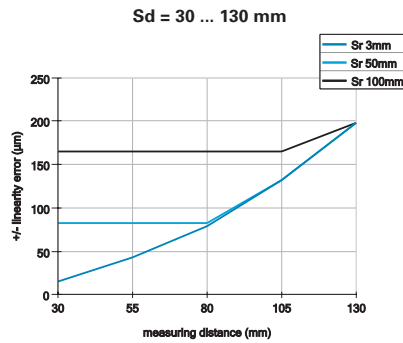
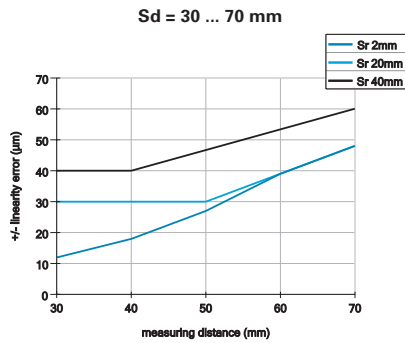

beam alignment (line)

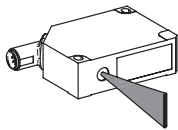

dimension drawing

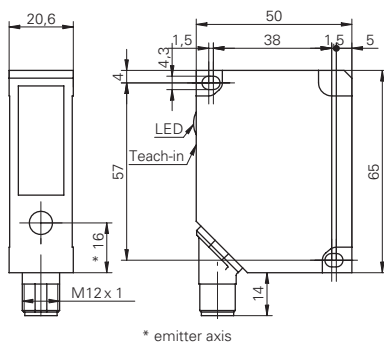

OADM 20 Sd = 30 ... 300 mm

Photoelectric distance measuring sensors

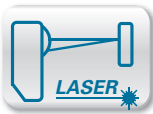

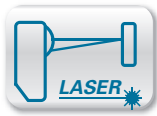

Sd = 100 ... 1000 mm



- response time < 0,9 ms
- teachable measuring range Sr > 10 mm
- resolution up to 15 µm

**general data**

adjustment	Teach-in: button / external
power on indication	LED green
soiled lens indicator	LED red
light source	pulsed red laser diode
wave length	650 nm
laser class	2

**measuring distance Sd = 100 ... 600 mm**

Teach-in range min.	> 10 mm
resolution	0,015 ... 0,67 mm
linearity error	± 0,05 ... ± 2 mm
temperature drift	< 0,03 % Sde/K

**measuring distance Sd = 200 ... 1000 mm**

Teach-in range min.	> 20 mm
resolution	0,12 ... 2,5 mm
linearity error	± 0,48 ... ± 10 mm
temperature drift	< 0,06 % Sde/K

**electrical data**

response time / release time	< 0,9 ms
voltage supply range +Vs	12 ... 28 VDC
current consumption max. (no load)	100 mA
output circuit	analog
output signal	4 ... 20 mA / 0 ... 10 VDC
load resistance (analog I)	< (+Vs - 6 V) / 0,02 A
load resistance (analog U)	> 100 kOhm
output current	< 100 mA
alarm output	PNP
short circuit protection	yes
reverse polarity protection	yes, Vs to GND

**mechanical data**

width / diameter	20,6 mm
height / length	65 mm
depth	50 mm
type	rectangular
housing material	die-cast zinc
front (optics)	glass
connection types	connector M12 8 pin, rotatable

**ambient conditions**

operating temperature	0 ... +50 °C
protection class	IP 67

**connection diagram**

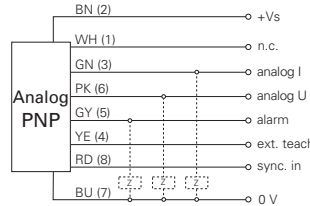

**connectors and mating connectors**

ESG 34FH0200G Connector M12, 8 pin, straight, 2 m, shielded  
 additional cable connectors and field wireable connectors: see accessories

**Accessories**

11010227	Mounting bracket OxDM 20
10156878	Protector cap OxDM 20

for details: see accessories section

**remarks**

For objects with a reflectivity < 7 % (OADM 2016x80/S14F) or < 15 % (OADM 2016x81/S14F) the response time/release time is increased automatically up to 2,8 ms.

**laser warning**

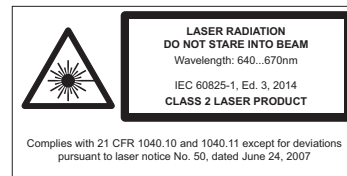

order reference	measuring distance Sd	beam type	beam width	beam height	beam diameter	ambient light immunity
OADM 2016480/S14F	100 ... 600 mm	point	-	-	2 mm	< 10 kLux
OADM 2016481/S14F	200 ... 1000 mm	point	-	-	2 mm	< 5 kLux
OADM 2016580/S14F	100 ... 600 mm	line	2,5 mm	5,5 ... 21 mm	-	< 10 kLux
OADM 2016581/S14F	200 ... 1000 mm	line	2,5 mm	8,5 ... 35 mm	-	< 5 kLux



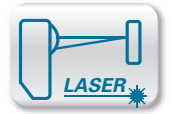

resolution

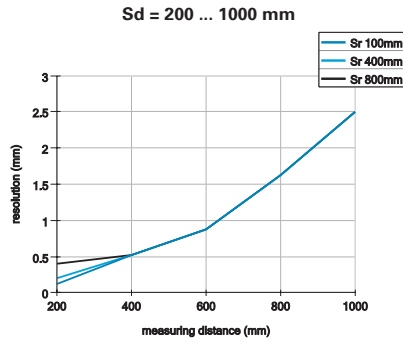
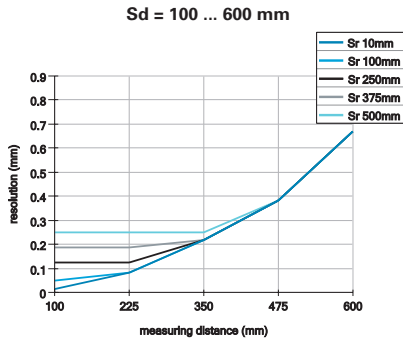

linearity errors

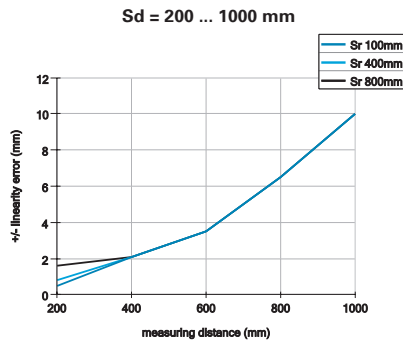
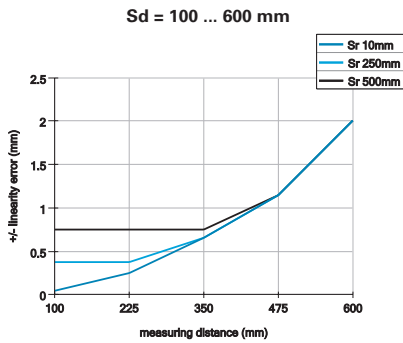

beam alignment (line)

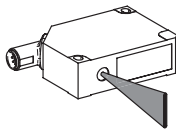

dimension drawing

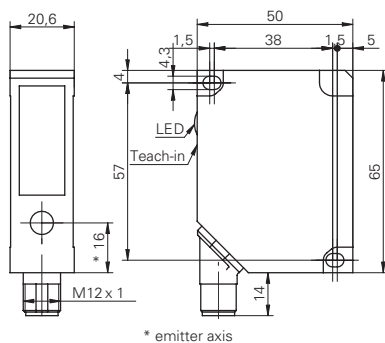

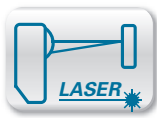

Sd = 50 ... 1000 mm



- for demanding applications
- very high ambient light immunity
- extremely vibration resistant

**general data**

adjustment	Teach-in: button / external
power on indication	LED green
soiled lens indicator	LED red
light source	pulsed red laser diode
wave length	650 nm
laser class	2
beam type	line
temperature drift	< 0,04 % Sde/K

**measuring distance Sd = 50 ... 300 mm**

Teach-in range min.	> 5 mm
resolution	0,01 ... 0,4 mm
linearity error	± 0,2 ... ± 1,5 mm
beam width	2 mm
beam height	6 ... 11 mm

**measuring distance Sd = 100 ... 600 mm**

Teach-in range min.	> 10 mm
resolution	0,015 ... 0,8 mm
linearity error	± 0,5 ... ± 3,4 mm
beam width	2 mm
beam height	7 ... 17 mm

**measuring distance Sd = 200 ... 1000 mm**

Teach-in range min.	> 20 mm
resolution	0,12 ... 3 mm
linearity error	± 0,36 ... ± 9 mm
beam width	3 ... 1 mm
beam height	8 ... 25 mm

**electrical data**

voltage supply range +Vs	12 ... 28 VDC
current consumption max. (no load)	100 mA
output signal	4 ... 20 mA / 0 ... 10 VDC
load resistance (analog I)	< (+Vs - 6 V) / 0,02 A
load resistance (analog U)	> 100 kOhm
output current	< 100 mA
alarm output	PNP
reverse polarity protection	yes, Vs to GND

**mechanical data**

width / diameter	20,6 mm
height / length	65 mm
depth	50 mm
type	rectangular
housing material	die-cast zinc
front (optics)	glass
connection types	cable 8 pin, 2 m

**ambient conditions**

operating temperature	-20 ... +60 °C
protection class	IP 67
vibration (sinusoidal)	IEC 60068-2-6:2008 30 g at f = 10 - 2000 Hz, cycles per axis
shock (semi-sinusoidal)	IEC 60068-2-29:2009 75 g / 6 ms, 4000 jolts per axis and direction

order reference	measuring distance Sd	response time / release time	short circuit protection	ambient light immunity
<b>OADM 20I6591</b>	50 ... 300 mm	< 2 ms	yes	< 100 kLux
<b>OADM 20I6592</b>	100 ... 600 mm	< 2,5 ms	yes	< 100 kLux
<b>OADM 20I6593</b>	200 ... 1000 mm	< 3,5 ms	-	< 60 kLux

OADM 20 Sd = 50 ... 1000 mm

Photoelectric distance measuring sensors

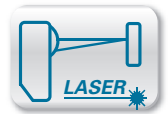

connection diagram

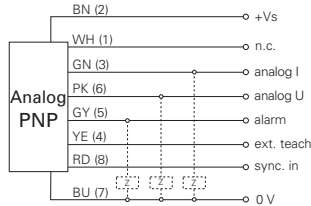

Accessories

11010227	Mounting bracket OxDM 20
10156878	Protector cap OxDM 20

for details: see accessories section

remarks

**Fault suppression**  
 If the laser beam is interrupted or if measurement faults occur, the analog outputs and the alarm output remain at their most recent valid value for a max. of 300 ms. Every valid value is immediately passed on to the outputs. If no valid value appears within 300 ms, the analog outputs switch to 4 mA / 0 V and the alarm output goes to HIGH.

**Vibration stability:**  
 - IEC 60068-2-6 (30 g, 10-2000 Hz, per axis)

**Random stability:**  
 - IEC 60068-2-64 (0,4 g2/Hz, 20-1000 Hz, per axis)

**Bump stability:**  
 - IEC 60068-2-29 (75 g, 6 ms, 4000 pulses per axis and direction)

laser warning



**LASER RADIATION**  
**DO NOT STARE INTO BEAM**  
 Wavelength: 640...670nm  
 IEC 60825-1, Ed. 3, 2014  
**CLASS 2 LASER PRODUCT**

Complies with 21 CFR 1040.10 and 1040.11 except for deviations pursuant to laser notice No. 50, dated June 24, 2007

resolution

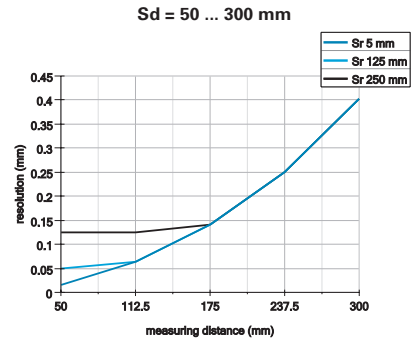

linearity errors

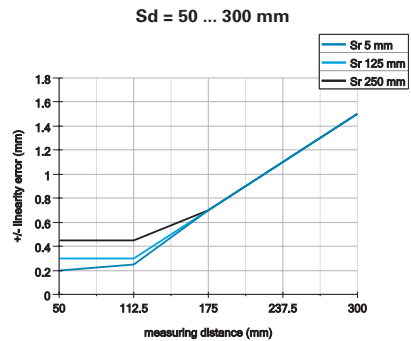

beam alignment (line)

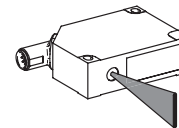

dimension drawing

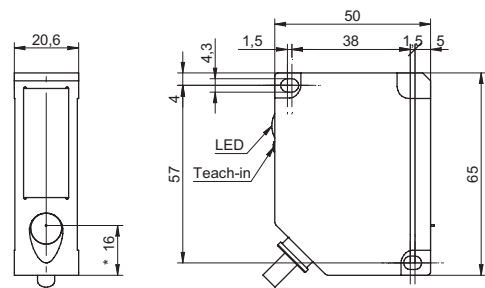

\* emitter axis

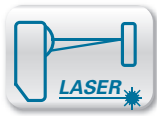

Sd = 30 ... 600 mm

- washdown design
- Ecolab approved
- front screen PMMA



**general data**

special type	Washdown design
adjustment	external
power on indication	LED green
soiled lens indicator	LED red
light source	pulsed red laser diode
wave length	650 nm
laser class	2
temperature drift	< 0,03 % Sde/K
approvals/certificates	Ecolab

**measuring distance Sd = 30 ... 130 mm**

Teach-in range min.	> 3 mm
resolution	0,005 ... 0,06 mm
linearity error	± 0,015 ... ± 0,2 mm

**measuring distance Sd = 50 ... 300 mm**

Teach-in range min.	> 5 mm
resolution	0,01 ... 0,33 mm
linearity error	± 0,03 ... ± 1 mm

**measuring distance Sd = 100 ... 600 mm**

Teach-in range min.	> 10 mm
resolution	0,015 ... 0,67 mm
linearity error	± 0,05 ... ± 2 mm

**electrical data**

response time / release time	< 0,9 ms
voltage supply range +Vs	12 ... 28 VDC
current consumption max. (no load)	100 mA
output circuit	analog
output signal	4 ... 20 mA / 0 ... 10 VDC
load resistance (analog I)	< (+Vs - 6 V) / 0,02 A
load resistance (analog U)	> 100 kOhm
output current	< 100 mA
alarm output	PNP
short circuit protection	yes
reverse polarity protection	yes, Vs to GND

**mechanical data**

width / diameter	20,3 mm
height / length	65 mm
depth	51 mm
type	rectangular
housing material	stainless steel 1.4404 (V4A)
front (optics)	PMMA
connection types	connector M12 8 pin

**ambient conditions**

operating temperature	0 ... +50 °C
protection class	IP 69K & proTect+

**connection diagram**

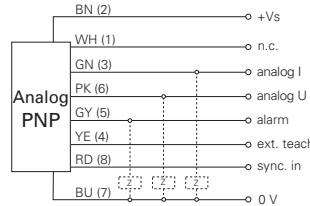

**connectors and mating connectors**

ESG 34FF0500G Connector M12, 8 pin, straight, 5 m, Niro, shielded

additional cable connectors and field wireable connectors: see accessories

**remarks**

For objects with a reflectivity < 7 % (OADR 2016x85/S14F) the response time/release time is increased automatically up to 2.8 ms.

**laser warning**



**LASER RADIATION**  
**DO NOT STARE INTO BEAM**  
Wavelength: 640...670nm  
IEC 60825-1, Ed. 3, 2014  
**CLASS 2 LASER PRODUCT**

Complies with 21 CFR 1040.10 and 1040.11 except for deviations pursuant to laser notice No. 50, dated June 24, 2007

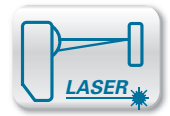

order reference	measuring distance Sd	beam type	beam width	beam height	beam diameter	ambient light immunity
OADR 20I6465/S14F	30 ... 130 mm	point	-	-	2 ... 1 mm	< 40 kLux
OADR 20I6475/S14F	50 ... 300 mm	point	-	-	2 mm	< 8 kLux
OADR 20I6485/S14F	100 ... 600 mm	point	-	-	2 mm	< 10 kLux
OADR 20I6565/S14F	30 ... 130 mm	line	2 ... 1 mm	3 ... 5 mm	-	< 40 kLux
OADR 20I6575/S14F	50 ... 300 mm	line	2,5 mm	4 ... 12 mm	-	< 8 kLux
OADR 20I6585/S14F	100 ... 600 mm	line	2,5 mm	5,5 ... 21 mm	-	< 10 kLux

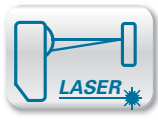

resolution

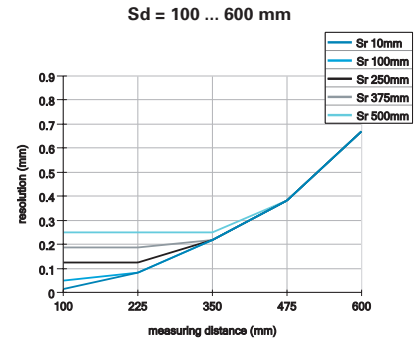
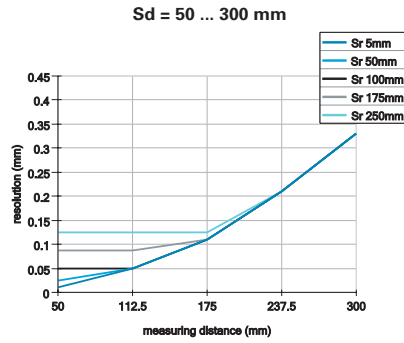
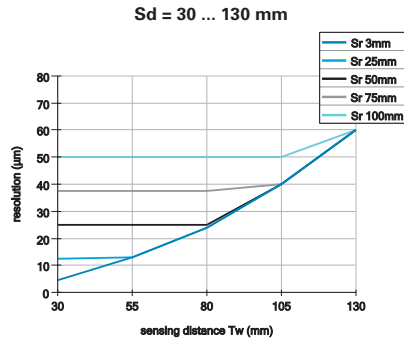

linearity errors

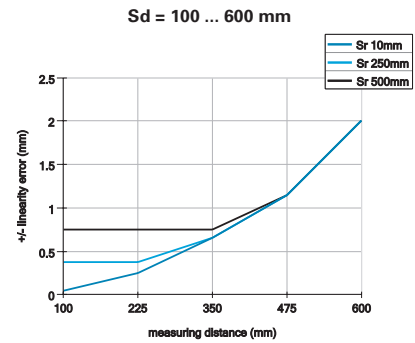
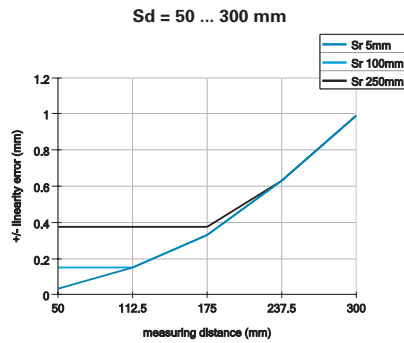
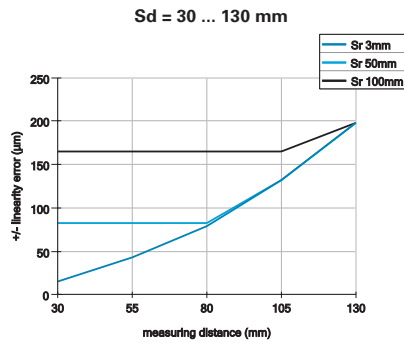

beam alignment (line)

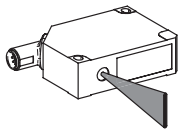

dimension drawing

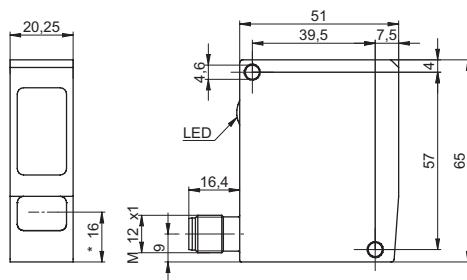

\* emitter axis

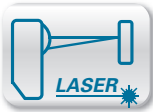

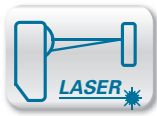

**Sd = 100 ... 1000 mm**

- teachable measuring range  $S_r > 10$  mm
- resolution up to 10  $\mu$ m
- synchronization input

**general data**

adjustment	Teach-in: button / external
Teach-in range min.	> 10 mm
power on indication	LED green
soiled lens indicator	LED red
light source	pulsed red laser diode
wave length	650 nm
laser class	2

**measuring distance Sd = 100 ... 600 mm**

resolution	0,01 ... 0,25 mm
linearity error	$\pm 0,07 \dots \pm 1$ mm
temperature drift	< 0,012 % Sde/K

**measuring distance Sd = 200 ... 1000 mm**

resolution	0,02 ... 0,4 mm
linearity error	$\pm 0,11 \dots \pm 1,65$ mm
temperature drift	< 0,02 % Sde/K

**electrical data**

response time / release time	< 4 ms
voltage supply range +Vs	12 ... 28 VDC
current consumption max. (no load)	100 mA
output circuit	analog
output signal	4 ... 20 mA / 0 ... 10 VDC
load resistance (analog I)	< (+Vs - 6 V) / 0,02 A
load resistance (analog U)	> 100 kOhm
output current	< 100 mA
alarm output	PNP
short circuit protection	yes
reverse polarity protection	yes, Vs to GND

**mechanical data**

width / diameter	20,4 mm
height / length	135 mm
depth	45 mm
type	rectangular
housing material	aluminum
front (optics)	glass
connection types	connector M12 8 pin, rotatable

**ambient conditions**

ambient light immunity	< 10 kLux
operating temperature	0 ... +50 °C
protection class	IP 67



**connection diagram**

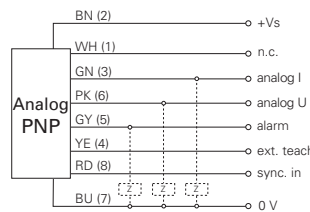

**connectors and mating connectors**

ESG 34FH0200G Connector M12, 8 pin, straight, 2 m, shielded  
 additional cable connectors and field wireable connectors: see accessories

**laser warning**

**LASER RADIATION**  
**DO NOT STARE INTO BEAM**  
 Wavelength: 640...670nm  
 IEC 60825-1, Ed. 3, 2014  
**CLASS 2 LASER PRODUCT**

Complies with 21 CFR 1040.10 and 1040.11 except for deviations pursuant to laser notice No. 50, dated June 24, 2007

order reference	measuring distance Sd	beam type	beam width	beam height	beam diameter
OADM 216480/S14F	100 ... 600 mm	point	-	-	2 mm
OADM 216481/S14F	200 ... 1000 mm	point	-	-	2 mm
OADM 216580/S14F	100 ... 600 mm	line	2 mm	4 ... 13 mm	-
OADM 216581/S14F	200 ... 1000 mm	line	2,5 mm	6 ... 20 mm	-



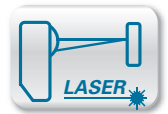

resolution

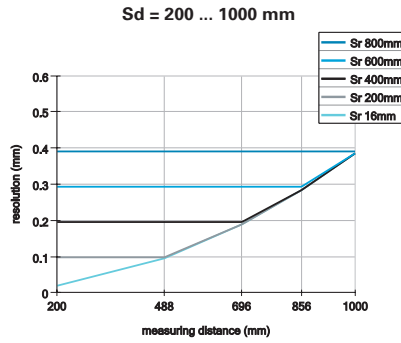
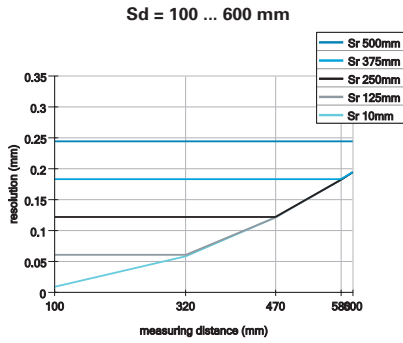

linearity errors

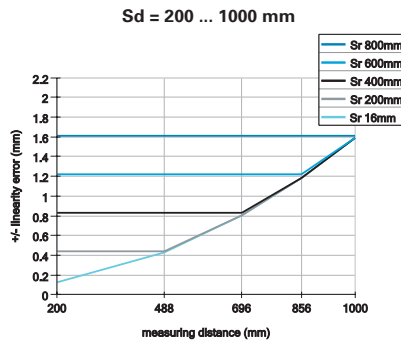
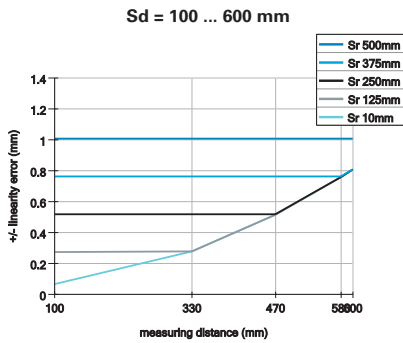

beam alignment (line)

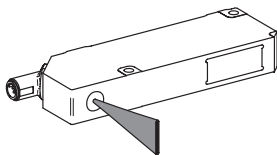

dimension drawing

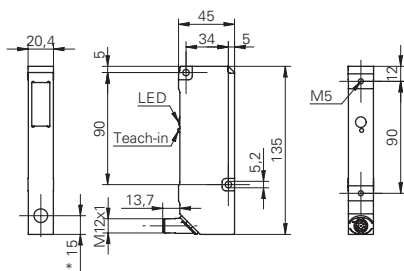

\* emitter axis

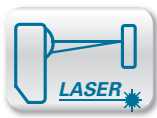

Sd = 30 ... 250 mm



- Distance or tolerance function
- Very high resolution up to 0,7 µm
- Output in mm

**general data**

adjustment	Touch Display, RS485
power on indication	LED green
output indicator	LED yellow / LED red
light source	pulsed red laser diode
wave length	660 nm
laser class	1
beam type	line
hysteresis digital output	adjustable

**measuring distance Sd = 30 ... 70 mm**

measuring range Mr	40 mm
resolution	0,7 ... 1 µm 1) 2) 3)
repeat accuracy	0,1 ... 0,3 µm 1) 2) 3)
linearity error	± 0,06 % Mr 1) 2)
temperature drift	0,01 % Sde/K 1) 2)

**measuring distance Sd = 40 ... 140 mm**

measuring range Mr	100 mm
resolution	1,2 ... 2,5 µm 1) 2) 3)
repeat accuracy	0,3 ... 0,7 µm 1) 2) 3)
linearity error	± 0,07 % Mr 1) 2)
temperature drift	0,015 % Sde/K 1) 2)

**measuring distance Sd = 50 ... 250 mm**

measuring range Mr	200 mm
resolution	1,4 ... 6,3 µm 1) 2) 3)
repeat accuracy	0,3 ... 2 µm 1) 2) 3)
linearity error	± 0,09 % Mr 1) 2)
temperature drift	0,025 % Sde/K 1) 2)

**electrical data**

response time / release time	0,8 ms 2)
measuring frequency	2500 Hz 2)
voltage supply range +Vs	15 ... 28 VDC
current consumption max. (no load)	75 mA
output circuit	analog and RS 485
baud rate	115200, adjustable
output signal	4 ... 20 mA / 0 ... 10 VDC
output current	< 100 mA
switching output	push-pull
short circuit protection	yes
reverse polarity protection	yes, Vs to GND

**mechanical data**

width / diameter	26 mm
height / length	74 mm
depth	55 mm
type	rectangular, front view
housing material	aluminum
front (optics)	glass
connection types	connector M12 8 pin
weight	130 g

**ambient conditions**

operating temperature	-10 ... +50 °C
protection class	IP 67
vibration (sinusoidal)	IEC 60068-2-6:2008 ± 0.75 mm p-p at f = 10 - 58 Hz, 10 cycles per axis 10 g at f = 58 - 2000 Hz, 10 cycles per axis
shock (semi-sinusoidal)	IEC 60068-2-27:2009 50 g / 11 ms resp. 100 g / 6 ms, 10 jolts per axis and direction 100 g / 2 ms, 5000 jolts per axis and direction

order reference	measuring distance Sd	type	ambient light immunity	focal range	sweet spot	version
OM70-11200058	30 ... 70 mm	distance measuring	< 28 kLux	40 ... 55 mm	48 mm	OM70 laser line
OM70-11112017	30 ... 70 mm	distance measuring	< 28 kLux	55 ... 70 mm	65 mm	OM70 laser line basic
OM70-11200062	40 ... 140 mm	distance measuring	< 35 kLux	50 ... 90 mm	70 mm	OM70 laser line
OM70-11200064	40 ... 140 mm	distance measuring	< 35 kLux	80 ... 120 mm	100 mm	OM70 laser line
OM70-11112019	40 ... 140 mm	distance measuring	< 35 kLux	110 ... 140 mm	130 mm	OM70 laser line basic
OM70-11200066	50 ... 250 mm	distance measuring	< 170 kLux	100 ... 150 mm	130 mm	OM70 laser line
OM70-11200068	50 ... 250 mm	distance measuring	< 170 kLux	140 ... 210 mm	180 mm	OM70 laser line
OM70-11112061	50 ... 250 mm	distance measuring	< 170 kLux	200 ... 250 mm	240 mm	OM70 laser line basic
OM70T-11175113	30 ... 70 mm	tolerance measuring	< 28 kLux	55 ... 70 mm	65 mm	OM70 laser line basic
OM70T-11175110	40 ... 140 mm	tolerance measuring	< 35 kLux	110 ... 140 mm	130 mm	OM70 laser line basic
OM70T-11175097	50 ... 250 mm	tolerance measuring	< 170 kLux	200 ... 250 mm	240 mm	OM70 laser line basic

OM70-L Sd = 30 ... 250 mm

Photoelectric distance measuring sensors

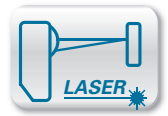

connection diagram

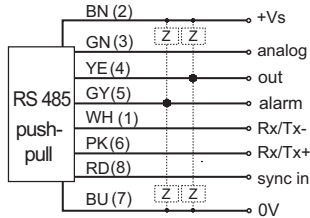

connectors and mating connectors

ESG 34FH0200G	Connector M12, 8 pin, straight, 2 m, shielded
ESW 33FH0200G	Connector M12, 8 pin, angular, 2 m, shielded
ESW 33FH0500G	Connector M12, 8 pin, angular, 5 m, shielded
ESW 33FH1000G	Connector M12, 8 pin, angular, 10 m, shielded

additional cable connectors and field wireable connectors: see accessories

Accessories

11120705	Mounting bracket X7 90° for PosCon and OM70, incl. accessories
----------	--

for details: see accessories section

laser warning



IEC 60825-1/2014  
Complies with 21 CFR 1040.10 and 1040.11  
except for deviations pursuant to laser  
notice No. 50, dated June 24, 2007

resolution

Sd = 50 ... 300 mm

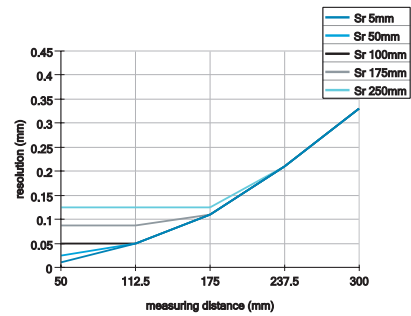

linearity error

Sd = 50 ... 300 mm

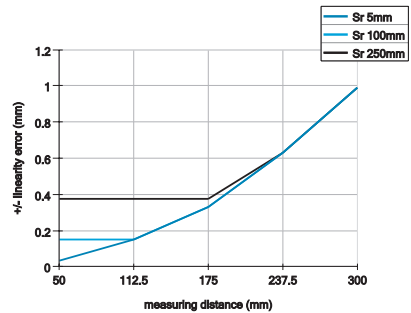

beam alignment (line)

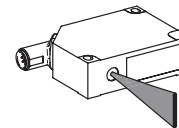

dimension drawing

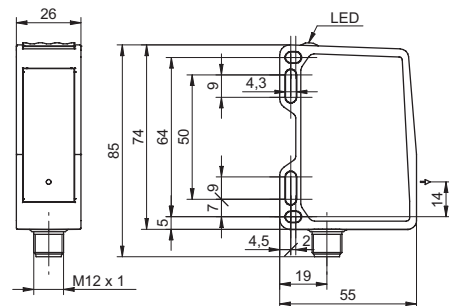

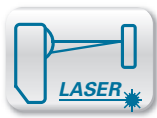

Sd = 100 ... 1500 mm



- Distance or tolerance function
- Very high resolution up to 0,7 µm
- Output in mm

**general data**

type	distance measuring
version	OM70 laser line basic
adjustment	Touch Display, RS485
power on indication	LED green
output indicator	LED yellow / LED red
light source	pulsed red laser diode
wave length	660 nm
laser class	1
beam type	line
hysteresis digital output	adjustable

**measuring distance Sd = 100 ... 600 mm**

measuring range Mr	500 mm
focal range	400 ... 600 mm
sweet spot	500 mm
resolution	3 ... 24 µm 1) 2) 3)
repeat accuracy	1 ... 9 µm 1) 2) 3)
linearity error	± 0,12 % Mr 1) 2)
temperature drift	0,04 % Sde/K 1) 2)

**measuring distance Sd = 100 ... 1000 mm**

measuring range Mr	900 mm
focal range	750 ... 1000 mm
sweet spot	1000 mm
resolution	3 ... 63 µm 1) 2) 3)
repeat accuracy	1 ... 32 µm 1) 2) 3)
linearity error	± 0,19 % Mr 1) 2)
temperature drift	0,065 % Sde/K 1) 2)

**measuring distance Sd = 150 ... 1500 mm**

measuring range Mr	1350 mm
focal range	1000 ... 1500 mm
sweet spot	1500 mm
resolution	13 ... 125 µm 1) 2) 3)
repeat accuracy	3 ... 63 µm 1) 2) 3)
linearity error	± 0,32 % Mr 1) 2)
temperature drift	0,100 % Sde/K 1) 2)

**electrical data**

response time / release time	0,8 ms 2)
measuring frequency	2500 Hz 2)
voltage supply range +Vs	15 ... 28 VDC
current consumption max. (no load)	75 mA
output circuit	analog and RS 485
baud rate	115200, adjustable
output signal	4 ... 20 mA / 0 ... 10 VDC
output current	< 100 mA
switching output	push-pull
short circuit protection	yes
reverse polarity protection	yes, Vs to GND

**mechanical data**

width / diameter	26 mm
height / length	74 mm
depth	55 mm
type	rectangular, front view
housing material	aluminum
front (optics)	glass
connection types	connector M12 8 pin
weight	130 g

**ambient conditions**

operating temperature	-10 ... +50 °C
protection class	IP 67
vibration (sinusoidal)	IEC 60068-2-6:2008 ± 0,75 mm p-p at f = 10 - 58 Hz, 10 cycles per axis 10 g at f = 58 - 2000 Hz, 10 cycles per axis
shock (semi-sinusoidal)	IEC 60068-2-27:2009 50 g / 11 ms resp. 100 g / 6 ms, 10 jolts per axis and direction 100 g / 2 ms, 5000 jolts per axis and direction

order reference	measuring distance Sd	ambient light immunity
-----------------	-----------------------	------------------------

OM70-1112065	100 ... 600 mm	< 170 kLux
OM70-11195788	100 ... 1000 mm	< 100 kLux
OM70-1112012	150 ... 1500 mm	< 35 kLux

OM70-L Sd = 100 ... 1500 mm

Photoelectric distance measuring sensors

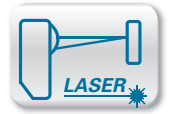

connection diagram

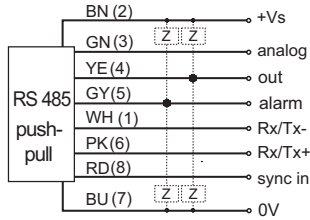

connectors and mating connectors

- ESG 34FH0200G Connector M12, 8 pin, straight, 2 m, shielded
- ESW 33FH0200G Connector M12, 8 pin, angular, 2 m, shielded
- ESW 33FH0500G Connector M12, 8 pin, angular, 5 m, shielded
- ESW 33FH1000G Connector M12, 8 pin, angular, 10 m, shielded

additional cable connectors and field wireable connectors: see accessories

Accessories

- 11120705 Mounting bracket X7 90° for PosCon and OM70, incl. accessories

for details: see accessories section

laser warning



IEC 60825-1/2014  
Complies with 21 CFR 1040.10 and 1040.11  
except for deviations pursuant to laser  
notice No. 50, dated June 24, 2007

resolution

Sd = 50 ... 300 mm

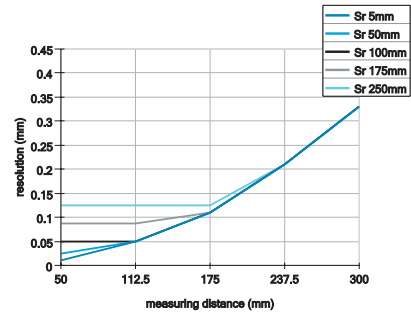

linearity error

Sd = 50 ... 300 mm

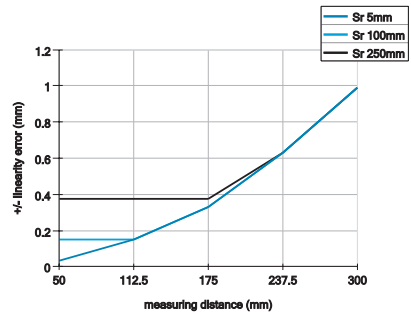

beam alignment (line)

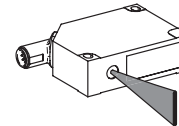

dimension drawing

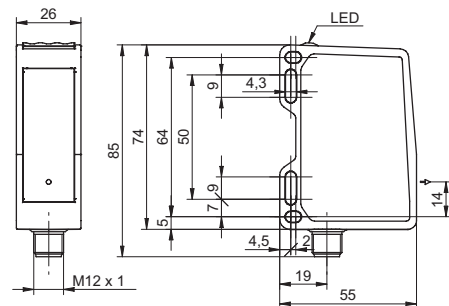

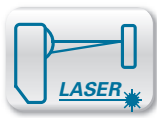

Sd = 100 ... 1500 mm



- Distance function
- Very high resolution up to 8 µm
- Output in mm

**general data**

type	distance measuring
adjustment	Touch Display, RS485
power on indication	LED green
output indicator	LED yellow / LED red
light source	pulsed red laser diode
wave length	660 nm
laser class	2
beam type	line
hysteresis digital output	adjustable

**measuring distance Sd = 100 ... 600 mm**

measuring range Mr	500 mm
resolution	3 ... 24 µm 1) 2) 3)
repeat accuracy	1 ... 9 µm 1) 2) 3)
linearity error	± 0,12 % Mr 1) 2)
temperature drift	0,04 % Sde/K 1) 2)

**measuring distance Sd = 100 ... 1000 mm**

measuring range Mr	900 mm
resolution	3 ... 63 µm 1) 2) 3)
repeat accuracy	1 ... 32 µm 1) 2) 3)
linearity error	± 0,19 % Mr 1) 2)
temperature drift	0,065 % Sde/K 1) 2)

**measuring distance Sd = 150 ... 1500 mm**

measuring range Mr	1350 mm
resolution	13 ... 125 µm 1) 2) 3)
repeat accuracy	3 ... 63 µm 1) 2) 3)
linearity error	± 0,32 % Mr 1) 2)
temperature drift	0,100 % Sde/K 1) 2)

**electrical data**

response time / release time	0,8 ms 2)
measuring frequency	2500 Hz 2)
voltage supply range +Vs	15 ... 28 VDC
current consumption max. (no load)	75 mA
output circuit	analog and RS 485
baud rate	115200, adjustable
output signal	4 ... 20 mA / 0 ... 10 VDC
output current	< 100 mA
switching output	push-pull
short circuit protection	yes
reverse polarity protection	yes, Vs to GND

**mechanical data**

width / diameter	26 mm
height / length	74 mm
depth	55 mm
type	rectangular, front view
housing material	aluminum
front (optics)	glass
connection types	connector M12 8 pin
weight	130 g

**ambient conditions**

operating temperature	-10 ... +50 °C
protection class	IP 67
vibration (sinusoidal)	IEC 60068-2-6:2008 ± 0.75 mm p-p at f = 10 - 58 Hz, 10 cycles per axis 10 g at f = 58 - 2000 Hz, 10 cycles per axis
shock (semi-sinusoidal)	IEC 60068-2-27:2009 50 g / 11 ms resp. 100 g / 6 ms, 10 jolts per axis and direction 100 g / 2 ms, 5000 jolts per axis and direction

order reference	measuring distance Sd	ambient light immunity	focal range	sweet spot	version
OM70-11200090	100 ... 600 mm	< 170 kLux	250 ... 450 mm	350 mm	OM70 laser line
OM70-11112067	100 ... 600 mm	< 170 kLux	400 ... 600 mm	500 mm	OM70 laser line basic
OM70-11199109	100 ... 1000 mm	< 100 kLux	400 ... 600 mm	500 mm	OM70 laser line
OM70-11200095	100 ... 1000 mm	< 100 kLux	550 ... 850 mm	700 mm	OM70 laser line
OM70-11199100	100 ... 1000 mm	< 100 kLux	750 ... 1000 mm	1000 mm	OM70 laser line basic
OM70-11112015	150 ... 1500 mm	< 35 kLux	1000 ... 1500 mm	1500 mm	OM70 laser line basic

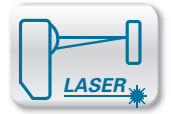

connection diagram

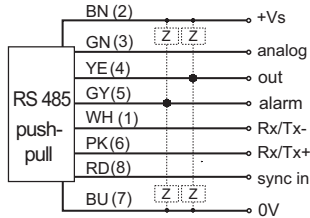

connectors and mating connectors

- ESG 34FH0200G Connector M12, 8 pin, straight, 2 m, shielded
- ESW 33FH0200G Connector M12, 8 pin, angular, 2 m, shielded
- ESW 33FH0500G Connector M12, 8 pin, angular, 5 m, shielded
- ESW 33FH1000G Connector M12, 8 pin, angular, 10 m, shielded

additional cable connectors and field wireable connectors: see accessories

Accessories

- 11120705 Mounting bracket X7 90° for PosCon and OM70, incl. accessories

for details: see accessories section

laser warning



**LASER RADIATION**  
**DO NOT STARE INTO BEAM**  
 Wavelength: 640...670nm  
 IEC 60825-1, Ed. 3, 2014  
**CLASS 2 LASER PRODUCT**

Complies with 21 CFR 1040.10 and 1040.11 except for deviations pursuant to laser notice No. 50, dated June 24, 2007

resolution

Sd = 50 ... 300 mm

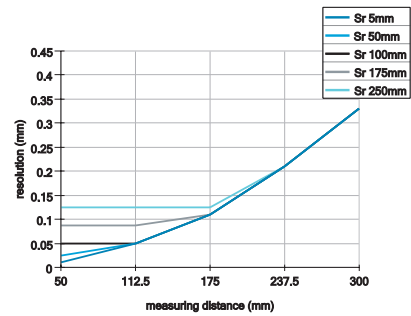

linearity error

Sd = 50 ... 300 mm

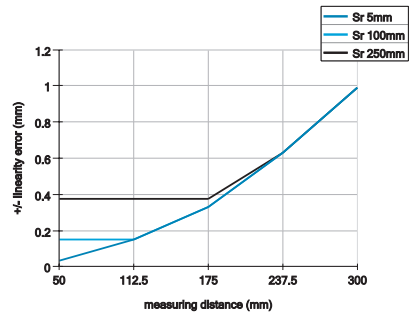

beam alignment (line)

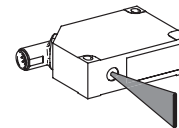

dimension drawing

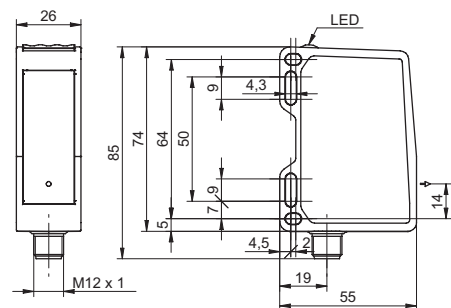

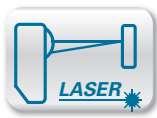

Sd = 30 ... 250 mm



- Distance or tolerance function
- Very high resolution up to 1,2 µm
- Output in mm

**general data**

adjustment	Touch Display, RS485
power on indication	LED green
output indicator	LED yellow / LED red
light source	pulsed red laser diode
wave length	660 nm
laser class	1
beam type	point
hysteresis digital output	adjustable

**measuring distance Sd = 30 ... 70 mm**

measuring range Mr	40 mm
resolution	0,7 ... 1 µm 1) 2) 3)
repeat accuracy	0,1 ... 0,3 µm 1) 2) 3)
linearity error	± 0,06 % Mr 1) 2)
temperature drift	0,01 % Sde/K 1) 2)

**measuring distance Sd = 40 ... 140 mm**

measuring range Mr	100 mm
resolution	1,2 ... 2,5 µm 1) 2) 3)
repeat accuracy	0,3 ... 0,7 µm 1) 2) 3)
linearity error	± 0,07 % Mr 1) 2)
temperature drift	0,015 % Sde/K 1) 2)

**measuring distance Sd = 50 ... 250 mm**

measuring range Mr	200 mm
resolution	1,4 ... 6,3 µm 1) 2) 3)
repeat accuracy	0,3 ... 2 µm 1) 2) 3)
linearity error	± 0,09 % Mr 1) 2)
temperature drift	0,025 % Sde/K 1) 2)

**electrical data**

response time / release time	0,8 ms 2)
measuring frequency	2500 Hz 2)
voltage supply range +Vs	15 ... 28 VDC
current consumption max. (no load)	75 mA
output circuit	analog and RS 485
baud rate	115200, adjustable
output signal	4 ... 20 mA / 0 ... 10 VDC
output current	< 100 mA
switching output	push-pull
short circuit protection	yes
reverse polarity protection	yes, Vs to GND

**mechanical data**

width / diameter	26 mm
height / length	74 mm
depth	55 mm
type	rectangular, front view
housing material	aluminum
front (optics)	glass
connection types	connector M12 8 pin
weight	130 g

**ambient conditions**

operating temperature	-10 ... +50 °C
protection class	IP 67
vibration (sinusoidal)	IEC 60068-2-6:2008 ± 0.75 mm p-p at f = 10 - 58 Hz, 10 cycles per axis 10 g at f = 58 - 2000 Hz, 10 cycles per axis
shock (semi-sinusoidal)	IEC 60068-2-27:2009 50 g / 11 ms resp. 100 g / 6 ms, 10 jolts per axis and direction 100 g / 2 ms, 5000 jolts per axis and direction

order reference	measuring distance Sd	type	ambient light immunity	focal range	sweet spot	version
OM70-11200060	30 ... 70 mm	distance measuring	< 28 kLux	40 ... 55 mm	48 mm	OM70 laser point
OM70-11195785	30 ... 70 mm	distance measuring	< 28 kLux	55 ... 70 mm	65 mm	OM70 laser point basic
OM70-11200061	40 ... 140 mm	distance measuring	< 38 kLux	50 ... 90 mm	70 mm	OM70 laser point
OM70-11200063	40 ... 140 mm	distance measuring	< 38 kLux	80 ... 120 mm	100 mm	OM70 laser point
OM70-11112018	40 ... 140 mm	distance measuring	< 38 kLux	110 ... 140 mm	130 mm	OM70 laser point basic
OM70-11200065	50 ... 250 mm	distance measuring	< 175 kLux	100 ... 150 mm	130 mm	OM70 laser point
OM70-11200067	50 ... 250 mm	distance measuring	< 175 kLux	140 ... 210 mm	180 mm	OM70 laser point
OM70-11112060	50 ... 250 mm	distance measuring	< 175 kLux	200 ... 250 mm	240 mm	OM70 laser point basic
OM70T-11195786	30 ... 70 mm	tolerance measuring	< 28 kLux	55 ... 70 mm	65 mm	OM70 laser point basic
OM70T-11175099	40 ... 140 mm	tolerance measuring	< 38 kLux	110 ... 140 mm	130 mm	OM70 laser point basic
OM70T-11175094	50 ... 250 mm	tolerance measuring	< 175 kLux	200 ... 250 mm	240 mm	OM70 laser point basic



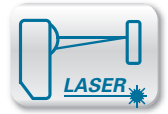

connection diagram

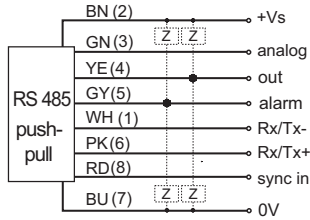

connectors and mating connectors

ESG 34FH0200G	Connector M12, 8 pin, straight, 2 m, shielded
ESW 33FH0200G	Connector M12, 8 pin, angular, 2 m, shielded
ESW 33FH0500G	Connector M12, 8 pin, angular, 5 m, shielded
ESW 33FH1000G	Connector M12, 8 pin, angular, 10 m, shielded

additional cable connectors and field wireable connectors: see accessories

Accessories

11120705	Mounting bracket X7 90° for PosCon and OM70, incl. accessories
----------	--

for details: see accessories section

laser warning



IEC 60825-1/2014  
Complies with 21 CFR 1040.10 and 1040.11  
except for deviations pursuant to laser  
notice No. 50, dated June 24, 2007

resolution

Sd = 50 ... 300 mm

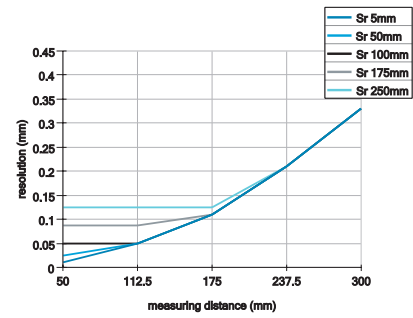

linearity error

Sd = 50 ... 300 mm

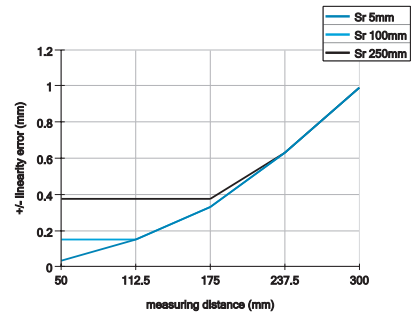

beam alignment (line)

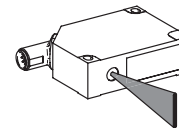

dimension drawing

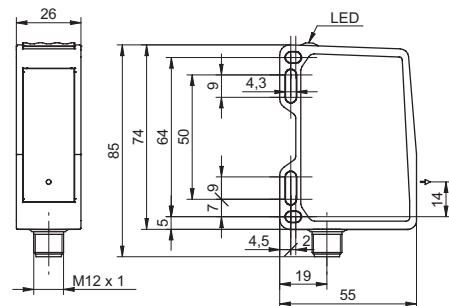

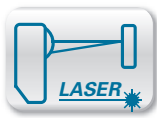

Sd = 100 ... 1500 mm



- Distance or tolerance function
- Very high resolution up to 1,2 µm
- Output in mm

**general data**

type	distance measuring
version	OM70 laser point basic
adjustment	Touch Display, RS485
power on indication	LED green
output indicator	LED yellow / LED red
light source	pulsed red laser diode
wave length	660 nm
laser class	1
beam type	point
hysteresis digital output	adjustable

**measuring distance Sd = 100 ... 600 mm**

measuring range Mr	500 mm
focal range	400 ... 600 mm
sweet spot	500 mm
resolution	3 ... 24 µm 1) 2) 3)
repeat accuracy	1 ... 9 µm 1) 2) 3)
linearity error	± 0,12 % Mr 1) 2)
temperature drift	0,04 % Sde/K 1) 2)

**measuring distance Sd = 100 ... 1000 mm**

measuring range Mr	900 mm
focal range	750 ... 1000 mm
sweet spot	1000 mm
resolution	3 ... 63 µm 1) 2) 3)
repeat accuracy	1 ... 32 µm 1) 2) 3)
linearity error	± 0,19 % Mr 1) 2)
temperature drift	0,065 % Sde/K 1) 2)

**measuring distance Sd = 150 ... 1500 mm**

measuring range Mr	1350 mm
focal range	1000 ... 1500 mm
sweet spot	1500 mm
resolution	13 ... 125 µm 1) 2) 3)
repeat accuracy	3 ... 63 µm 1) 2) 3)
linearity error	± 0,32 % Mr 1) 2)
temperature drift	0,100 % Sde/K 1) 2)

**electrical data**

response time / release time	0,8 ms 2)
measuring frequency	2500 Hz 2)
voltage supply range +Vs	15 ... 28 VDC
current consumption max. (no load)	75 mA
output circuit	analog and RS 485
baud rate	115200, adjustable
output signal	4 ... 20 mA / 0 ... 10 VDC
output current	< 100 mA
switching output	push-pull
short circuit protection	yes
reverse polarity protection	yes, Vs to GND

**mechanical data**

width / diameter	26 mm
height / length	74 mm
depth	55 mm
type	rectangular, front view
housing material	aluminum
front (optics)	glass
connection types	connector M12 8 pin
weight	130 g

**ambient conditions**

operating temperature	-10 ... +50 °C
protection class	IP 67
vibration (sinusoidal)	IEC 60068-2-6:2008 ± 0,75 mm p-p at f = 10 - 58 Hz, 10 cycles per axis 10 g at f = 58 - 2000 Hz, 10 cycles per axis
shock (semi-sinusoidal)	IEC 60068-2-27:2009 50 g / 11 ms resp. 100 g / 6 ms, 10 jolts per axis and direction 100 g / 2 ms, 5000 jolts per axis and direction

order reference	measuring distance Sd	ambient light immunity
-----------------	-----------------------	------------------------

OM70-11112064	100 ... 600 mm	< 300 kLux
OM70-11195787	100 ... 1000 mm	< 100 kLux
OM70-11111994	150 ... 1500 mm	< 35 kLux

OM70-P Sd = 100 ... 1500 mm

Photoelectric distance measuring sensors

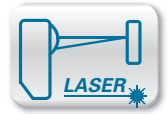

connection diagram

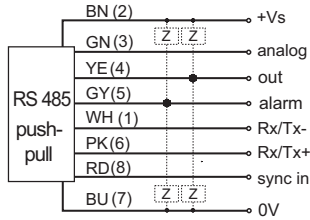

connectors and mating connectors

ESG 34FH0200G	Connector M12, 8 pin, straight, 2 m, shielded
ESW 33FH0200G	Connector M12, 8 pin, angular, 2 m, shielded
ESW 33FH0500G	Connector M12, 8 pin, angular, 5 m, shielded
ESW 33FH1000G	Connector M12, 8 pin, angular, 10 m, shielded

additional cable connectors and field wireable connectors: see accessories

Accessories

11120705	Mounting bracket X7 90° for PosCon and OM70, incl. accessories
----------	--

for details: see accessories section

laser warning



IEC 60825-1/2014  
Complies with 21 CFR 1040.10 and 1040.11  
except for deviations pursuant to laser  
notice No. 50, dated June 24, 2007

resolution

Sd = 50 ... 300 mm

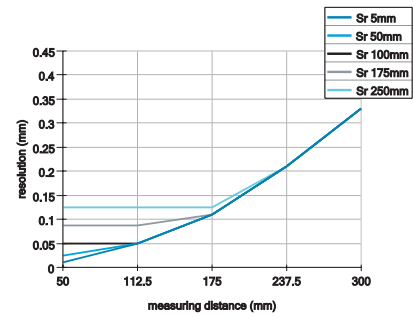

linearity error

Sd = 50 ... 300 mm

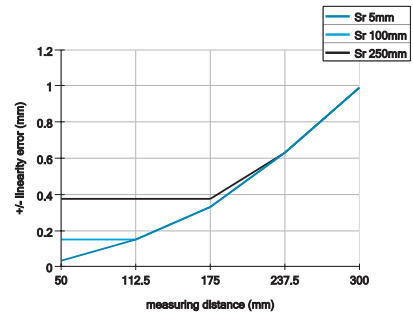

beam alignment (line)

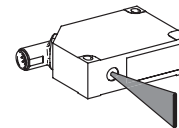

dimension drawing

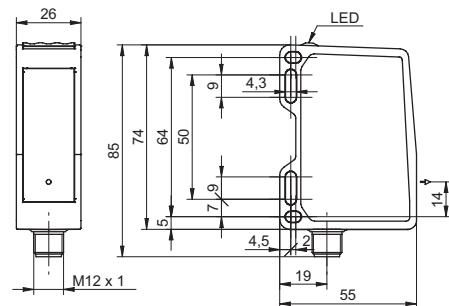

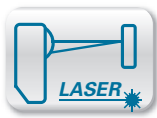

Sd = 100 ... 1500 mm



- Distance function
- Very high resolution up to 13 µm
- Output in mm

**general data**

type	distance measuring
adjustment	Touch Display, RS485
power on indication	LED green
output indicator	LED yellow / LED red
light source	pulsed red laser diode
wave length	660 nm
laser class	2
beam type	point
hysteresis digital output	adjustable

**measuring distance Sd = 100 ... 600 mm**

measuring range Mr	500 mm
resolution	3 ... 24 µm 1) 2) 3)
repeat accuracy	1 ... 9 µm 1) 2) 3)
linearity error	± 0,12 % Mr 1) 2)
temperature drift	0,04 % Sde/K 1) 2)

**measuring distance Sd = 100 ... 1000 mm**

measuring range Mr	900 mm
resolution	3 ... 63 µm 1) 2) 3)
repeat accuracy	1 ... 32 µm 1) 2) 3)
linearity error	± 0,19 % Mr 1) 2)
temperature drift	0,065 % Sde/K 1) 2)

**measuring distance Sd = 150 ... 1500 mm**

measuring range Mr	1350 mm
resolution	13 ... 125 µm 1) 2) 3)
repeat accuracy	3 ... 63 µm 1) 2) 3)
linearity error	± 0,32 % Mr 1) 2)
temperature drift	0,100 % Sde/K 1) 2)

**electrical data**

response time / release time	0,8 ms 2)
measuring frequency	2500 Hz 2)
voltage supply range +Vs	15 ... 28 VDC
current consumption max. (no load)	75 mA
output circuit	analog and RS 485
baud rate	115200, adjustable
output signal	4 ... 20 mA / 0 ... 10 VDC
output current	< 100 mA
switching output	push-pull
short circuit protection	yes
reverse polarity protection	yes, Vs to GND

**mechanical data**

width / diameter	26 mm
height / length	74 mm
depth	55 mm
type	rectangular, front view
housing material	aluminum
front (optics)	glass
connection types	connector M12 8 pin
weight	130 g

**ambient conditions**

operating temperature	-10 ... +50 °C
protection class	IP 67
vibration (sinusoidal)	IEC 60068-2-6:2008 ± 0.75 mm p-p at f = 10 - 58 Hz, 10 cycles per axis 10 g at f = 58 - 2000 Hz, 10 cycles per axis
shock (semi-sinusoidal)	IEC 60068-2-27:2009 50 g / 11 ms resp. 100 g / 6 ms, 10 jolts per axis and direction 100 g / 2 ms, 5000 jolts per axis and direction

order reference	measuring distance Sd	ambient light immunity	focal range	sweet spot	version
OM70-11200069	100 ... 600 mm	< 300 kLux	250 ... 450 mm	350 mm	OM70 laser point
OM70-11112066	100 ... 600 mm	< 300 kLux	400 ... 600 mm	500 mm	OM70 laser point basic
OM70-11199108	100 ... 1000 mm	< 100 kLux	400 ... 600 mm	500 mm	OM70 laser point
OM70-11200091	100 ... 1000 mm	< 100 kLux	550 ... 850 mm	700 mm	OM70 laser point
OM70-11199089	100 ... 1000 mm	< 100 kLux	750 ... 1000 mm	1000 mm	OM70 laser point basic
OM70-11112013	150 ... 1500 mm	< 35 kLux	1000 ... 1500 mm	1500 mm	OM70 laser point basic

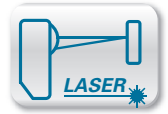

connection diagram

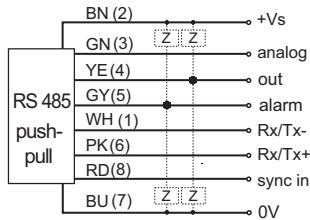

connectors and mating connectors

- ESG 34FH0200G Connector M12, 8 pin, straight, 2 m, shielded
- ESW 33FH0200G Connector M12, 8 pin, angular, 2 m, shielded
- ESW 33FH0500G Connector M12, 8 pin, angular, 5 m, shielded
- ESW 33FH1000G Connector M12, 8 pin, angular, 10 m, shielded

additional cable connectors and field wireable connectors: see accessories

Accessories

- 11120705 Mounting bracket X7 90° for PosCon and OM70, incl. accessories

for details: see accessories section

laser warning



**LASER RADIATION**  
**DO NOT STARE INTO BEAM**  
 Wavelength: 640...670nm  
 IEC 60825-1, Ed. 3, 2014  
**CLASS 2 LASER PRODUCT**

Complies with 21 CFR 1040.10 and 1040.11 except for deviations pursuant to laser notice No. 50, dated June 24, 2007

resolution

Sd = 50 ... 300 mm

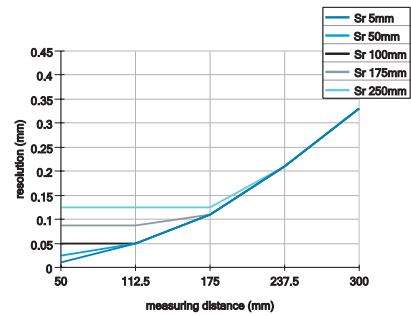

linearity error

Sd = 50 ... 300 mm

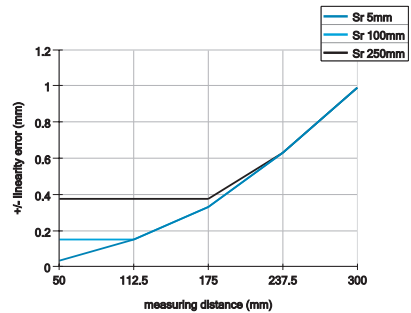

beam alignment (line)

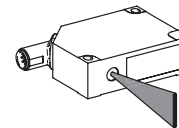

dimension drawing

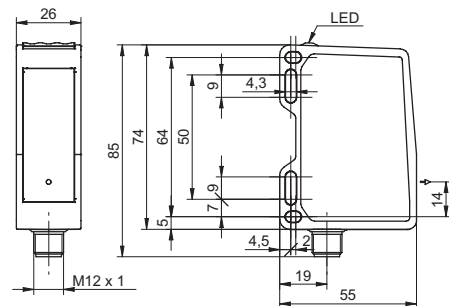

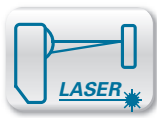

Sd = 100 ... 150 mm



- Stable measurement values even on coarse and shiny surfaces
- Very high resolution up to 2 µm
- Output in mm

general data	
version	OM70 multi-spot
measuring distance Sd	100 ... 150 mm
measuring range (width)	48 ... 72 mm
adjustment	Touch Display, RS485
power on indication	LED green
resolution	2 ... 4 µm 1) 2) 4) 5)
linearity error	± 30 ... ± 90 µm 1) 2) 4)
light source	pulsed red laser diode
wave length	656 nm
laser class	1
beam type	multi-spot
temperature drift	± 0,04 % Sde/K 1) 2) 4)

electrical data	
response time / release time	3,5 ms 2) 3)
measuring frequency	570 Hz 2) 3)
voltage supply range +Vs	15 ... 28 VDC
current consumption max. (no load)	120 mA
output circuit	analog and RS 485
baud rate	115200, adjustable
output signal	4 ... 20 mA / 0 ... 10 VDC
output current	< 100 mA
short circuit protection	yes
reverse polarity protection	yes, Vs to GND

mechanical data	
width / diameter	26 mm
height / length	74 mm
depth	55 mm
type	rectangular, front view
housing material	aluminum
front (optics)	glass
connection types	connector M12 8 pin

ambient conditions	
ambient light immunity	< 35 kLux
operating temperature	-10 ... +50 °C
protection class	IP 67
storage temperature	-25 ... +75 °C
vibration (sinusoidal)	IEC 60068-2-6:2008 1.5 mm p-p at f = 10 - 57 Hz, 10 cycles per axis 10 g at f = 58 - 2000 Hz, 10 cycles per axis
shock (semi-sinusoidal)	IEC 60068-2-27:2009 50 g / 11 ms resp. 100 g / 6 ms, 10 jolts per axis and direction 100 g / 2 ms, 5000 jolts per axis and direction

**order reference**  
OM70-11155463

OM70-X Sd = 100 ... 150 mm

Photoelectric distance measuring sensors

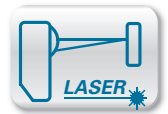

connection diagram

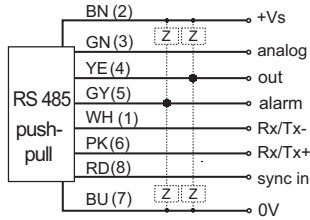

connectors and mating connectors

ESG 34FH0200G	Connector M12, 8 pin, straight, 2 m, shielded
ESW 33FH0200G	Connector M12, 8 pin, angular, 2 m, shielded
ESW 33FH0500G	Connector M12, 8 pin, angular, 5 m, shielded
ESW 33FH1000G	Connector M12, 8 pin, angular, 10 m, shielded

additional cable connectors and field wireable connectors: see accessories

Accessories

11120705	Mounting bracket X7 90° for PosCon and OM70, incl. accessories
----------	--

for details: see accessories section

laser warning



IEC 60825-1/2014  
Complies with 21 CFR 1040.10 and 1040.11  
except for deviations pursuant to laser  
notice No. 50, dated June 24, 2007

resolution

Sd = 50 ... 300 mm

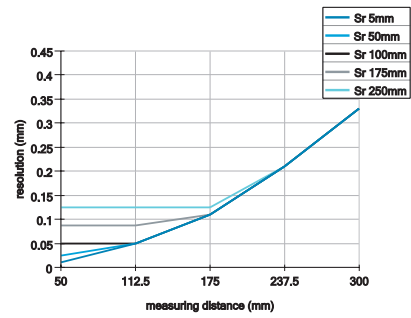

linearity error

Sd = 50 ... 300 mm

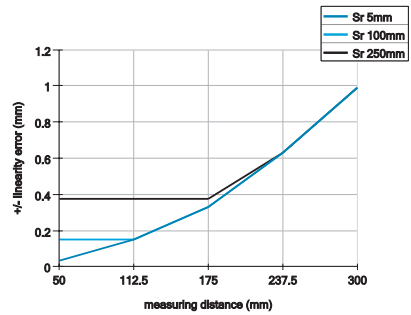

beam alignment (line)

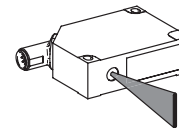

dimension drawing

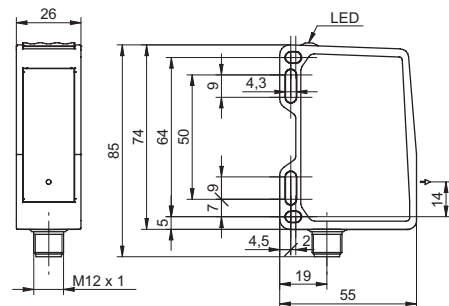

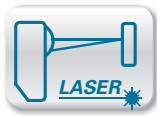

Sd = 100 ... 500 mm



- Stable measurement values even on coarse and shiny surfaces
- Very high resolution up to 4 µm
- Output in mm

general data	
version	OM70 multi-spot
measuring distance Sd	100 ... 500 mm
measuring range (width)	13 ... 66 mm
adjustment	Touch Display, RS485
power on indication	LED green
resolution	4 ... 25 µm 1) 2) 4) 5)
repeat accuracy	4 ... 20 µm 1) 2) 4) 5)
linearity error	± 100 µm 1) 2) 4) 6)
light source	pulsed red laser diode
wave length	660 nm
laser class	2
beam type	multi-spot
temperature drift	± 0,04 % Sde/K 1) 2) 4)

electrical data	
response time / release time	1,3 ms 2) 3)
measuring frequency	1540 Hz 2) 3)
voltage supply range +Vs	15 ... 28 VDC
current consumption max. (no load)	120 mA
output circuit	analog and RS 485
baud rate	115200, adjustable
output signal	4 ... 20 mA / 0 ... 10 VDC
output current	< 100 mA
short circuit protection	yes
reverse polarity protection	yes, Vs to GND

mechanical data	
width / diameter	26 mm
height / length	74 mm
depth	55 mm
type	rectangular, front view
housing material	aluminum
front (optics)	glass
connection types	connector M12 8 pin

ambient conditions	
ambient light immunity	< 35 kLux
operating temperature	-10 ... +50 °C
protection class	IP 67
storage temperature	-25 ... +75 °C
vibration (sinusoidal)	IEC 60068-2-6:2008 1.5 mm p-p at f = 10 - 57 Hz, 10 cycles per axis 10 g at f = 58 - 2000 Hz, 10 cycles per axis
shock (semi-sinusoidal)	IEC 60068-2-27:2009 50 g / 11 ms resp. 100 g / 6 ms, 10 jolts per axis and direction 100 g / 2 ms, 5000 jolts per axis and direction

**order reference**  
OM70-11112069

OM70-X Sd = 100 ... 500 mm

Photoelectric distance measuring sensors



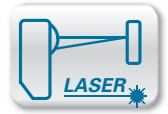

connection diagram

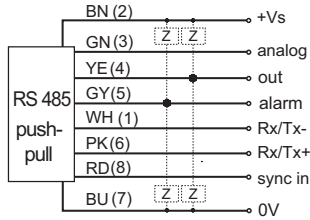

connectors and mating connectors

- ESG 34FH0200G Connector M12, 8 pin, straight, 2 m, shielded
- ESW 33FH0200G Connector M12, 8 pin, angular, 2 m, shielded
- ESW 33FH0500G Connector M12, 8 pin, angular, 5 m, shielded
- ESW 33FH1000G Connector M12, 8 pin, angular, 10 m, shielded

additional cable connectors and field wireable connectors: see accessories

Accessories

- 11120705 Mounting bracket X7 90° for PosCon and OM70, incl. accessories

for details: see accessories section

laser warning



**LASER RADIATION**  
**DO NOT STARE INTO BEAM**  
 Wavelength: 640...670nm  
 IEC 60825-1, Ed. 3, 2014  
**CLASS 2 LASER PRODUCT**

Complies with 21 CFR 1040.10 and 1040.11 except for deviations pursuant to laser notice No. 50, dated June 24, 2007

resolution

Sd = 50 ... 300 mm

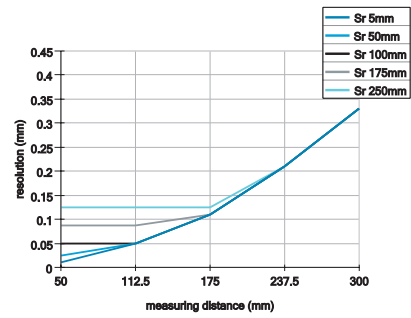

linearity error

Sd = 50 ... 300 mm

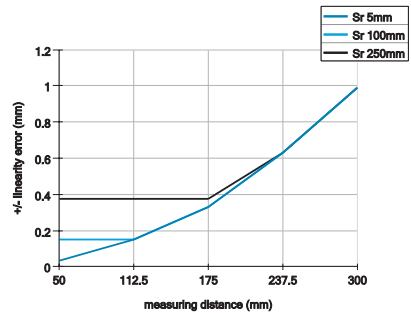

beam alignment (line)

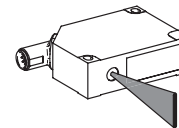

dimension drawing

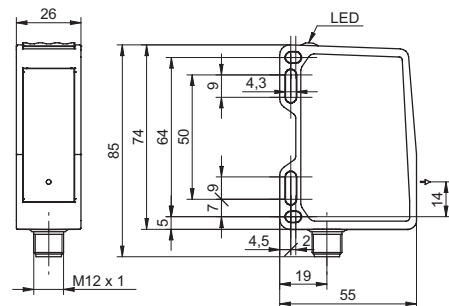

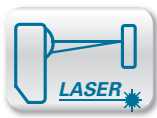

Sd = 100 ... 1500 mm



- Stable measurement values even on coarse and shiny surfaces
- Very high resolution up to 2  $\mu\text{m}$
- Output in mm

**general data**

type	distance measuring
version	OM70 multi-spot
measuring distance Sd	100 ... 150 mm
measuring range (width)	48 ... 72 mm
adjustment	Webserver, Ethernet TCP/IP
power on indication	LED green
output indicator	LED yellow / LED red
ethernet link indication	LED blue
resolution	2 ... 4 $\mu\text{m}$ 1) 2) 4) 5)
linearity error	$\pm 30$ ... $\pm 90$ $\mu\text{m}$ 1) 2) 4)
light source	pulsed red laser diode
wave length	656 nm
laser class	1
beam type	multi-spot
temperature drift	$\pm 0,04$ % Sde/K 1) 2) 4)

**electrical data**

response time / release time	3,5 ms 2) 3)
measuring frequency	570 Hz 2) 3)
voltage supply range +Vs	15 ... 28 VDC
current consumption max. (no load)	150 mA
output current	< 100 mA
switching output	push-pull
short circuit protection	yes
reverse polarity protection	yes, Vs to GND
interface	Ethernet TCP/IP
protocol	Modbus TCP, OPC UA
webserver	yes

**mechanical data**

width / diameter	26 mm
height / length	74 mm
depth	55 mm
type	rectangular, front view
housing material	aluminum
front (optics)	glass
connection types	connector M12 8 pin & M12 4 pin
weight	135 g

**ambient conditions**

ambient light immunity	< 35 kLux
operating temperature	-10 ... +50 °C
protection class	IP 67
storage temperature	-20 ... +60
vibration (sinusoidal)	IEC 60068-2-6:2008 1.5 mm p-p at f = 10 - 57 Hz, 10 cycles per axis 10 g at f = 58 - 2000 Hz, 10 cycles per axis
shock (semi-sinusoidal)	IEC 60068-2-27:2009 30 g / 11 ms, 6 jolts per axis and direction

**order reference**

OM70-11185168

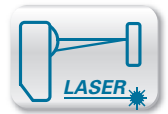

connection diagram

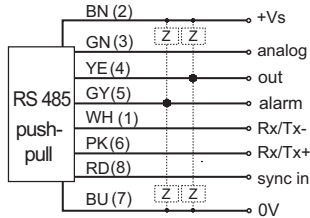

connectors and mating connectors

ESG 34FH0200G	Connector M12, 8 pin, straight, 2 m, shielded
ESW 33FH0200G	Connector M12, 8 pin, angular, 2 m, shielded
ESW 33FH0500G	Connector M12, 8 pin, angular, 5 m, shielded
ESW 33FH1000G	Connector M12, 8 pin, angular, 10 m, shielded
KSG 34A/KSG45AP0200G/E	Ethernet cable; connector M12, straight to RJ45 mating connector, 4-pin, 2 m, shielded
KSG 34A/KSG45AP0500G/E	Ethernet cable; connector M12, straight to RJ45 mating connector, 4-pin, 5 m, shielded
KSG 34A/KSG45AP1000G/E	Ethernet cable; connector M12, straight to RJ45 mating connector, 4-pin, 10 m, shielded

additional cable connectors and field wireable connectors: see accessories

Accessories

11120705	Mounting bracket X7 90° for PosCon and OM70, incl. accessories
----------	--

for details: see accessories section

laser warning



IEC 60825-1/2014  
Complies with 21 CFR 1040.10 and 1040.11  
except for deviations pursuant to laser  
notice No. 50, dated June 24, 2007

resolution

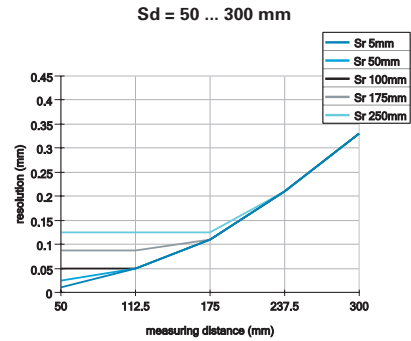

linearity error

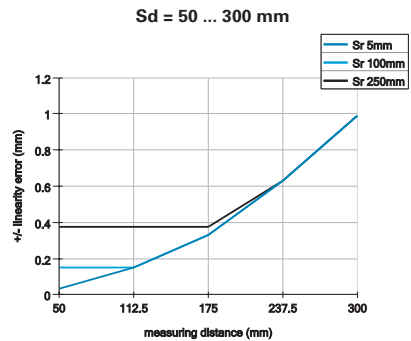

beam alignment (line)

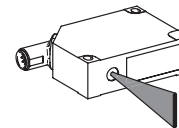

dimension drawing

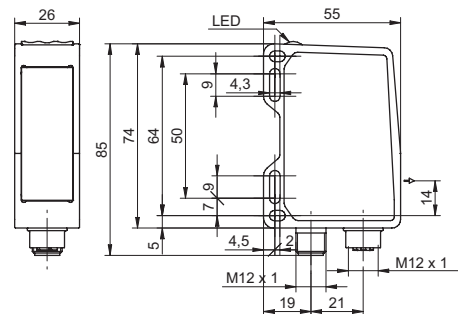

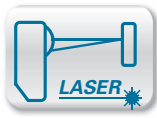

Sd = 0,2 ... 4 m



- measuring independent of colors up to 4 m
- extremely compact housing
- teachable measuring range

**general data**

measuring distance Sd	200 ... 4000 mm
measuring distance Sd (white 90%)	200 ... 4000 mm
measuring distance Sd (grey 18%)	200 ... 4000 mm
measuring distance Sd (black 6%)	200 ... 4000 mm
adjustment	Teach-in: button / external
Teach-in range min.	> 100 mm
power on indication	LED green
soiled lens indicator	LED red
resolution	1,3 mm
repeatability	± 5 mm (with 40 kLux ambient light)
linearity	± 15 mm
light source	pulsed red laser diode
wave length	660 nm
laser class	2
beam type	point
beam diameter	5 ... 20 mm

**electrical data**

measuring rate	10 ms
voltage supply range +Vs	15 ... 28 VDC
current consumption max. (no load)	250 mA (typ. 110 mA @ 24V)
output circuit	analog
output current	< 100 mA
alarm output	push-pull
short circuit protection	yes
reverse polarity protection	yes, Vs to GND

**mechanical data**

width / diameter	25,4 mm
height / length	66 mm
depth	51 mm
type	rectangular
housing material	aluminum
front (optics)	glass
connection types	connector M12 5 pin, rotatable

**ambient conditions**

ambient light immunity	< 40 kLux
operating temperature	-25 ... +50 °C
protection class	IP 67
typ. temp. coefficient	0,2 mm /°C

**connection diagram**

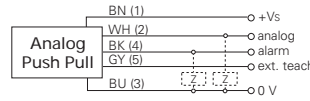

**connectors and mating connectors**

ESG 34CH0200G Connector M12, 5 pin, straight, 2 m, shielded  
 additional cable connectors and field wireable connectors: see accessories

**laser warning**

order reference	output signal	load resistance (analog U)	load resistance (analog I)
OADM 250I1101/S14C	4 ... 20 mA	-	< (+Vs - 6 V) / 0,02 A
OADM 250U1101/S14C	0 ... 10 VDC	> 10 kOhm	-

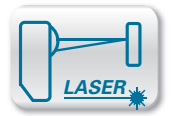

dimension drawing

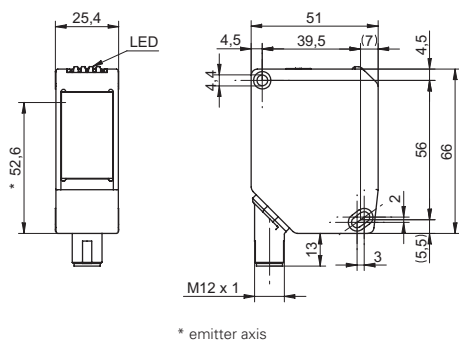

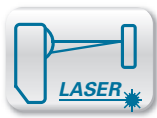

Sd = 0,2 ... 13 m



- measuring up to 13 m
- extremely compact housing
- teachable measuring range

**general data**

measuring distance Sd	200 ... 13000 mm
measuring distance Sd (white 90%)	200 ... 13000 mm
measuring distance Sd (grey 18%)	200 ... 9000 mm
measuring distance Sd (black 6%)	200 ... 4000 mm
adjustment	Teach-in: button / external
Teach-in range min.	> 100 mm
power on indication	LED green
soiled lens indicator	LED red
resolution	5 mm
repeatability	± 15 mm (with 40 kLux ambient light)
linearity	± 15 mm
light source	pulsed red laser diode
wave length	660 nm
laser class	2
beam type	point
beam diameter	5 ... 50 mm

**electrical data**

measuring rate	10 ms
voltage supply range +Vs	15 ... 28 VDC
current consumption max. (no load)	250 mA (typ. 110 mA @ 24V)
output circuit	analog
output signal	4 ... 20 mA
load resistance (analog I)	< (+Vs - 6 V) / 0,02 A
output current	< 100 mA
alarm output	push-pull
short circuit protection	yes
reverse polarity protection	yes, Vs to GND

**mechanical data**

width / diameter	25,4 mm
height / length	66 mm
depth	51 mm
type	rectangular
housing material	aluminum
front (optics)	glass
connection types	connector M12 5 pin, rotatable

**ambient conditions**

ambient light immunity	< 40 kLux
operating temperature	-25 ... +50 °C
protection class	IP 67
typ. temp. coefficient	0,4 mm /°C

**order reference**

OADM 260I1101/S14C

**connection diagram**

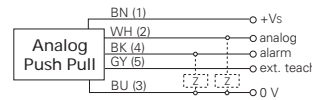

**connectors and mating connectors**

ESG 34CH0200G Connector M12, 5 pin, straight, 2 m, shielded  
 additional cable connectors and field wireable connectors: see accessories

**laser warning**

**LASER RADIATION**  
**DO NOT STARE INTO BEAM**  
 Wavelength: 640...670nm  
 IEC 60825-1, Ed. 3, 2014  
**CLASS 2 LASER PRODUCT**

Complies with 21 CFR 1040.10 and 1040.11 except for deviations pursuant to laser notice No. 50, dated June 24, 2007

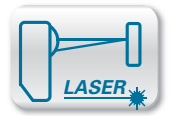

dimension drawing

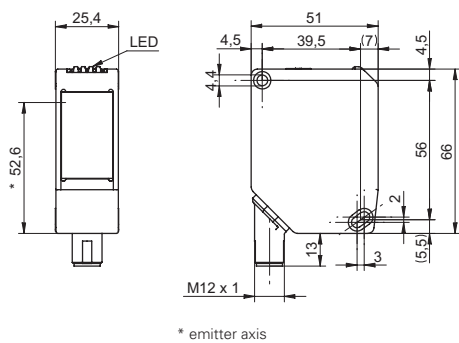

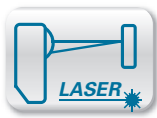

Sd = 30 ... 300 mm



- One inch class
- infrared LED
- distance value via IO-Link

**general data**

type	distance measuring
version	IO-Link measuring
measuring distance Sd	30 ... 300 mm
adjustment	Teach-in and IO-Link
power on indication	LED green
light indicator	LED yellow
resolution	0,5 ... 5 mm
linearity error	± 1,5 ... ± 15 mm
light source	pulsed infrared diode
wave length	860 nm
beam type	point
suppression of reciprocal influence	yes
alignment optical axis	< 2°
temperature drift	< 0,2 % Sde/K

**electrical data**

response time / release time	< 0,49 ms
voltage supply range +Vs	10 ... 30 VDC
current consumption max. (no load)	45 mA
voltage drop Vd	< 3 VDC
output circuit	push-pull
baud rate	38,4 kBaud (COM 2)
output current	< 100 mA
short circuit protection	yes
reverse polarity protection	yes
interface	IO-Link V1.1
cycle time	≥ 2,7 ms
process data length	3 Byte
process data structure	Bit 0 = BDC1 Bit 2 = quality Bit 3 = alarm Bit 8-23 = 16 Bit measurement

**mechanical data**

width / diameter	12,9 mm
height / length	32,3 mm
depth	23 mm
type	rectangular
housing material	plastic (ASA, PMMA)
front (optics)	PMMA

**ambient conditions**

operating temperature	-25 ... +60 °C
protection class	IP 67

**connection diagram**

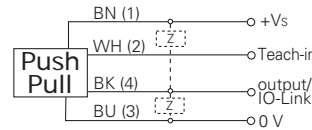

**connectors and mating connectors**

ESG 32AH0200	Connector M8, 4 pin, straight, 2 m
ESW 31AH0200	Connector M8, 4 pin, angular, 2 m

additional cable connectors and field wireable connectors: see accessories

**Accessories**

11104963	Sensofix O300
11102423	Mounting bracket O300 (L design)
11124807	Mounting bracket O300 - Retrofit for sensors series 20

for details: see accessories section

**order reference**

<b>O300.DI-11199080</b>	cable 4 pin, 2 m
<b>O300.DI-11199081</b>	connector M8 4 pin

**connection types**



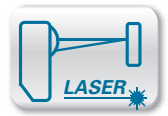

resolution

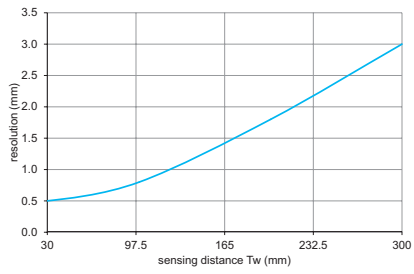

dimension drawings

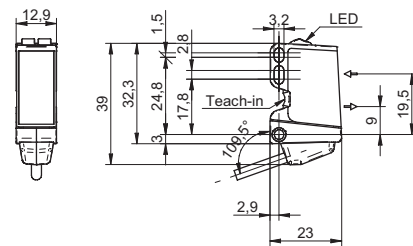
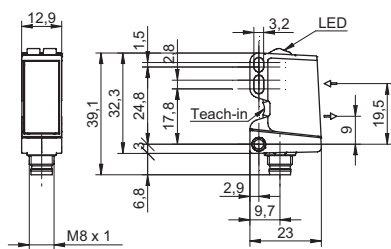

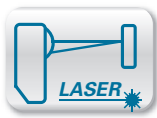

Sd = 30 ... 250 mm



- One inch class
- laser diode
- distance value via IO-Link

**general data**

type	distance measuring
version	IO-Link measuring
measuring distance Sd	30 ... 250 mm
focal distance	400 mm
adjustment	Teach-in and IO-Link
power on indication	LED green
light indicator	LED yellow
resolution	0,5 ... 10 mm
linearity error	± 1,5 ... ± 12,5 mm
light source	pulsed red laser diode
wave length	656 nm
laser class	1
beam type	point
suppression of reciprocal influence	yes
alignment optical axis	< 2°
temperature drift	< 0,2 % Sde/K

**electrical data**

response time / release time	< 0,25 ms
voltage supply range +Vs	11 ... 30 VDC
current consumption max. (no load)	30 mA
voltage drop Vd	< 2,5 VDC
output circuit	push-pull
baud rate	230,4 kBaud (COM 3)
output current	< 100 mA
short circuit protection	yes
reverse polarity protection	yes
interface	IO-Link V1.1
cycle time	≥ 0,6 ms
process data length	3 Byte
process data structure	Bit 0 = BDC1 Bit 2 = quality Bit 3 = alarm Bit 8-23 = 16 Bit measurement

**mechanical data**

width / diameter	12,9 mm
height / length	32,3 mm
depth	23 mm
type	rectangular
housing material	plastic (ASA, PMMA)
front (optics)	PMMA

**ambient conditions**

operating temperature	-10 ... +60 °C
protection class	IP 67

**connection diagram**

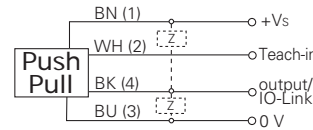

**connectors and mating connectors**

ESG 32AH0200	Connector M8, 4 pin, straight, 2 m
ESW 31AH0200	Connector M8, 4 pin, angular, 2 m

additional cable connectors and field wireable connectors: see accessories

**Accessories**

11104963	Sensofix O300
11102423	Mounting bracket O300 (L design)
11124807	Mounting bracket O300 - Retrofit for sensors series 20

for details: see accessories section

**laser warning**



IEC 60825-1/2014  
Complies with 21 CFR 1040.10 and 1040.11  
except for deviations pursuant to laser  
notice No. 50, dated June 24, 2007

**order reference connection types**

<b>O300.DL-11199078</b>	cable 4 pin, 2 m
<b>O300.DL-11199079</b>	connector M8 4 pin

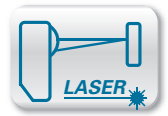

resolution

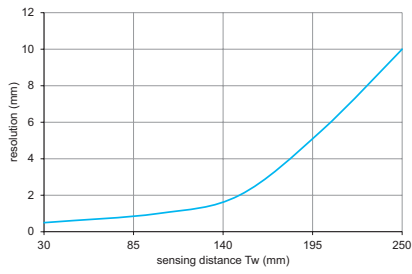

dimension drawings

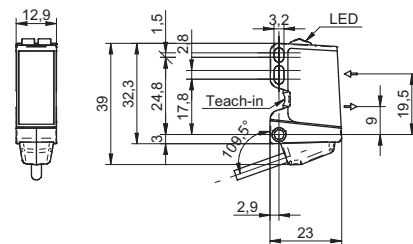
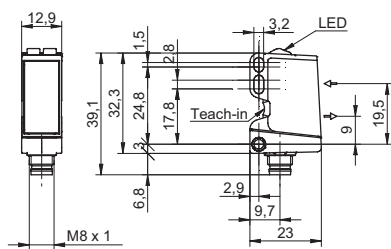

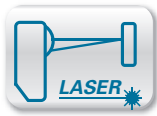

Sd = 30 ... 300 mm

- One inch class
- PinPoint LED
- distance value via IO-Link



**general data**

type	distance measuring
version	IO-Link measuring
measuring distance Sd	30 ... 300 mm
adjustment	Teach-in and IO-Link
power on indication	LED green
light indicator	LED yellow
resolution	0,5 ... 5 mm
linearity error	± 1,5 ... ± 15 mm
light source	pulsed PinPoint LED
wave length	630 nm
beam type	point
suppression of reciprocal influence	yes
alignment optical axis	< 2°
temperature drift	< 0,2 % Sde/K

**electrical data**

response time / release time	< 0,49 ms
voltage supply range +Vs	10 ... 30 VDC
current consumption max. (no load)	45 mA
voltage drop Vd	< 3 VDC
output circuit	push-pull
baud rate	38,4 kBaud (COM 2)
output current	< 100 mA
short circuit protection	yes
reverse polarity protection	yes
interface	IO-Link V1.1
cycle time	≥ 2,7 ms
process data length	3 Byte
process data structure	Bit 0 = BDC1 Bit 2 = quality Bit 3 = alarm Bit 8-23 = 16 Bit measurement

**mechanical data**

width / diameter	12,9 mm
height / length	32,3 mm
depth	23 mm
type	rectangular
housing material	plastic (ASA, PMMA)
front (optics)	PMMA

**ambient conditions**

operating temperature	-25 ... +60 °C
protection class	IP 67

**connection diagram**

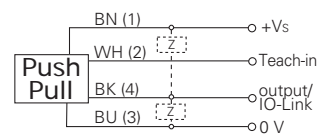

**connectors and mating connectors**

ESG 32AH0200	Connector M8, 4 pin, straight, 2 m
ESW 31AH0200	Connector M8, 4 pin, angular, 2 m

additional cable connectors and field wireable connectors: see accessories

**Accessories**

11104963	Sensofix O300
11102423	Mounting bracket O300 (L design)
11124807	Mounting bracket O300 - Retrofit for sensors series 20

for details: see accessories section

**order reference**                      **connection types**

<b>O300.DP-11199076</b>	cable 4 pin, 2 m
<b>O300.DP-11199077</b>	connector M8 4 pin

Photoelectric distance measuring sensors O300.DP Sd = 30 ... 300 mm

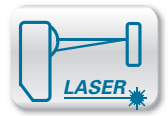

resolution

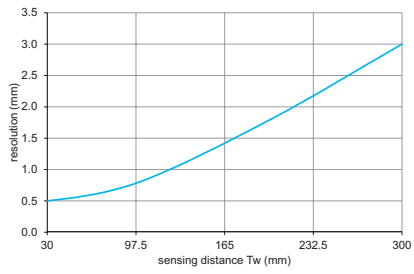

dimension drawings

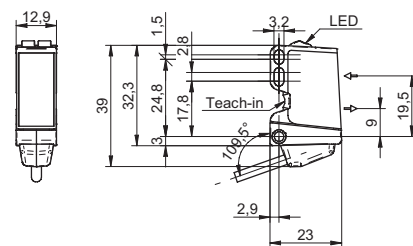
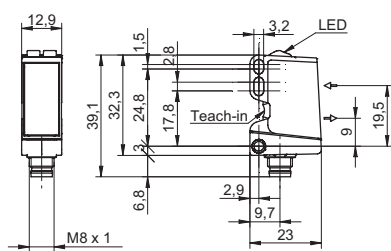

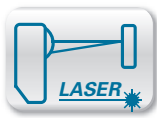

Sd = 60 ... 550 mm



- infrared LED
- distance value via IO-Link
- resolution up to 0,5 mm

**general data**

type	distance measuring
version	IO-Link measuring
measuring distance Sd	60 ... 550 mm
adjustment	Teach-in and IO-Link
power on indication	LED green
light indicator	LED yellow
resolution	0,5 ... 5 mm
linearity error	± 3 ... ± 27,5 mm
light source	pulsed infrared diode
wave length	860 nm
beam type	point
suppression of reciprocal influence	yes
alignment optical axis	< 1°
temperature drift	< 0,2 % Sde/K

**electrical data**

response time / release time	< 0,49 ms
voltage supply range +Vs	10 ... 30 VDC
current consumption max. (no load)	40 mA
voltage drop Vd	< 3 VDC
output circuit	push-pull
baud rate	38,4 kBaud (COM 2)
output current	< 100 mA
short circuit protection	yes
reverse polarity protection	yes
interface	IO-Link V1.1
cycle time	≥ 2,7 ms
process data length	3 Byte
process data structure	Bit 0 = BDC1 Bit 2 = quality Bit 3 = alarm Bit 8-23 = 16 Bit measurement

**mechanical data**

width / diameter	18 mm
height / length	45 mm
depth	32 mm
type	rectangular
housing material	plastic (ASA, PMMA)
front (optics)	PMMA

**ambient conditions**

operating temperature	-25 ... +60 °C
protection class	IP 67

**connection diagram**

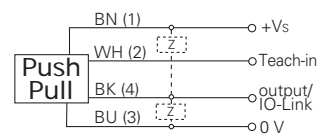

**connectors and mating connectors**

ESG 34AH0200	Connector M12, 4 pin, straight, 2 m
ESW 33AH0200	Connector M12, 4 pin, angular, 2 m

additional cable connectors and field wireable connectors: see accessories

**Accessories**

11099942	Sensofix O500/U500
11092246	Mounting bracket O500/U500 (L design)
11111164	Mounting bracket O500/U500 - Retrofit for sensors series 30

for details: see accessories section

**order reference**                      **connection types**

<b>O500.DI-11199084</b>	cable 4 pin, 2 m
<b>O500.DI-11199085</b>	connector M12 4 pin

O500.DI Sd = 60 ... 550 mm

Photoelectric distance measuring sensors

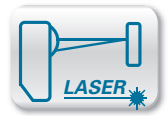

resolution

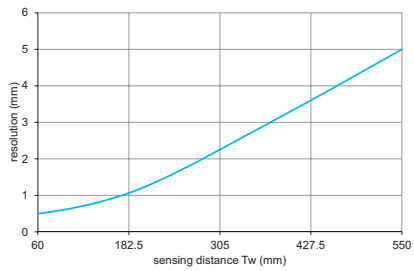

dimension drawings

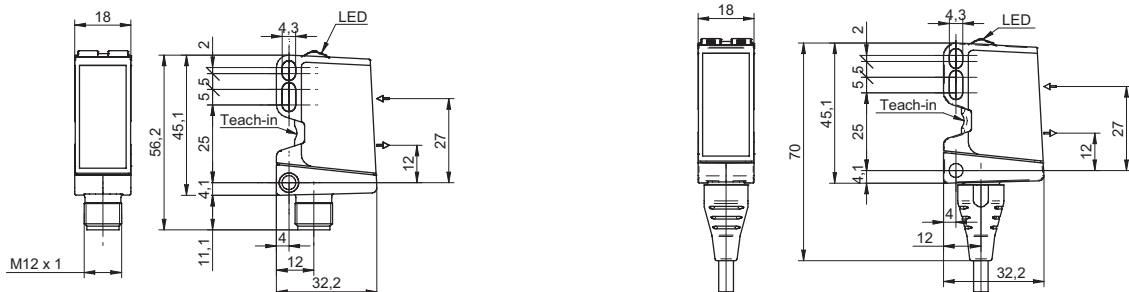

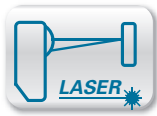

Sd = 60 ... 400 mm

- PinPoint LED
- distance value via IO-Link
- resolution up to 0,5 mm



**general data**

type	distance measuring
version	IO-Link measuring
measuring distance Sd	60 ... 400 mm
adjustment	Teach-in and IO-Link
power on indication	LED green
light indicator	LED yellow
resolution	0,5 ... 3 mm
linearity error	± 3 ... ± 20 mm
light source	pulsed PinPoint LED
wave length	630 nm
beam type	point
suppression of reciprocal influence	yes
alignment optical axis	< 1°
temperature drift	< 0,2 % Sde/K

**electrical data**

response time / release time	< 0,49 ms
voltage supply range +Vs	10 ... 30 VDC
current consumption max. (no load)	40 mA
voltage drop Vd	< 3 VDC
output circuit	push-pull
baud rate	38,4 kBaud (COM 2)
output current	< 100 mA
short circuit protection	yes
reverse polarity protection	yes
interface	IO-Link V1.1
cycle time	≥ 2,7 ms
process data length	3 Byte
process data structure	Bit 0 = BDC1 Bit 2 = quality Bit 3 = alarm Bit 8-23 = 16 Bit measurement

**mechanical data**

width / diameter	18 mm
height / length	45 mm
depth	32 mm
type	rectangular
housing material	plastic (ASA, PMMA)
front (optics)	PMMA

**ambient conditions**

operating temperature	-25 ... +60 °C
protection class	IP 67

**connection diagram**

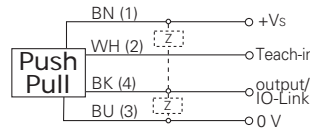

**connectors and mating connectors**

ESG 34AH0200	Connector M12, 4 pin, straight, 2 m
ESW 33AH0200	Connector M12, 4 pin, angular, 2 m

additional cable connectors and field wireable connectors: see accessories

**Accessories**

11099942	Sensofix O500/U500
11092246	Mounting bracket O500/U500 (L design)
11111164	Mounting bracket O500/U500 - Retrofit for sensors series 30

for details: see accessories section

**order reference                      connection types**

<b>O500.DP-11199082</b>	cable 4 pin, 2 m
<b>O500.DP-11199083</b>	connector M12 4 pin



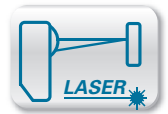

resolution

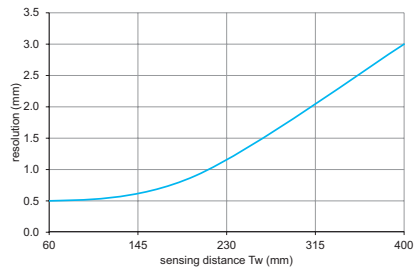

dimension drawings

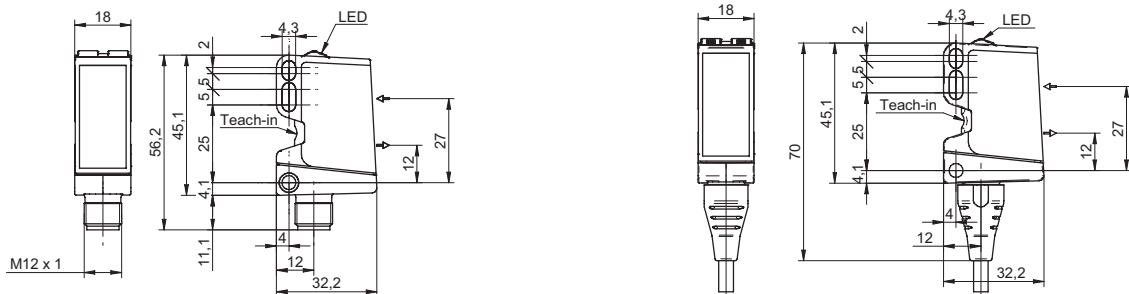

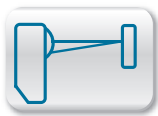

Sd = 50 ... 400 mm



- compact design
- measuring distance Sd 50 ... 400 mm
- resolution up to 0,1 mm

**general data**

measuring distance Sd	50 ... 400 mm
adjustment	IO-Link
Teach-in range min.	> 20 mm
power on indication	LED green
soiled lens indicator	LED red
resolution	0,1 ... 1 mm
linearity error	± 1,5 ... ± 4 mm
light source	pulsed point source LED
wave length	660 nm
beam type	point
beam diameter	8 mm
temperature drift	< 0,1 % Sde/K

**electrical data**

response time / release time	< 3 ms
voltage supply range +Vs	12 ... 26 VDC
current consumption max. (no load)	80 mA
output circuit	analog
output signal	4 ... 20 mA
load resistance (analog I)	< (+Vs - 10 V) / 0,02 A
output current	< 100 mA
alarm output	push-pull
short circuit protection	yes
reverse polarity protection	yes, Vs to GND

**mechanical data**

width / diameter	14,8 mm
height / length	43 mm
depth	31 mm
type	rectangular
housing material	plastic (ASA, MABS)
front (optics)	PMMA

**ambient conditions**

operating temperature	0 ... +50 °C
protection class	IP 67

**order reference**

<b>FADK 14I4470/IO</b>	cable 4 pin, 2 m
<b>FADK 14I4470/S14/IO</b>	connector M12 4 pin
<b>FADK 14I4470/S35A/IO</b>	connector M8 4 pin

**connection types**

**connection diagram**

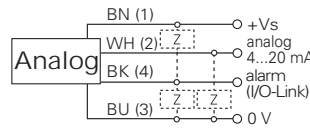

**connectors and mating connectors**

ESW 33AH0200G	Connector M12, 4 pin, angular, 2 m, shielded
ESG 32AH0200G	Connector M8, 4 pin, straight, 2 m, shielded
ESW 31AH0200G	Connector M8, 4 pin, angular, 2 m, shielded

additional cable connectors and field wireable connectors: see accessories

**Accessories**

10134964	Mounting bracket series 14 (L design)
10149011	Sensofix series 14

for details: see accessories section

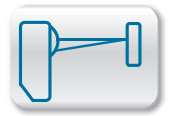

## resolution

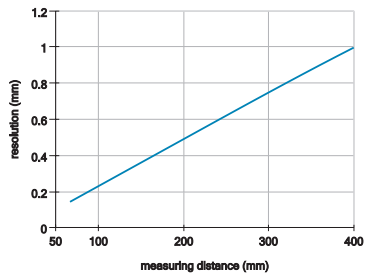

## linearity error

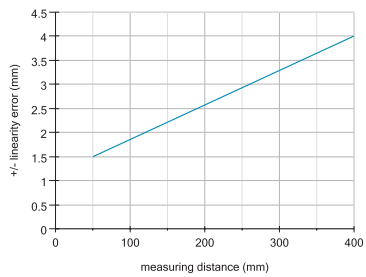

## dimension drawing

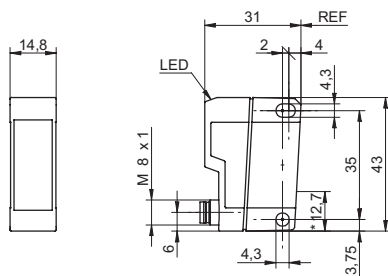

\* emitter axis

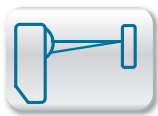

Sd = 50 ... 400 mm



- compact design
- measuring distance Sd 50 ... 400 mm
- resolution up to 0,1 mm

**general data**

measuring distance Sd	50 ... 400 mm
adjustment	IO-Link
Teach-in range min.	> 20 mm
power on indication	LED green
soiled lens indicator	LED red
resolution	0,1 ... 1 mm
linearity error	± 1,5 ... ± 4 mm
light source	pulsed point source LED
wave length	660 nm
beam type	point
beam diameter	8 mm
temperature drift	< 0,1 % Sde/K

**electrical data**

response time / release time	< 3 ms
voltage supply range +Vs	14 ... 26 VDC
current consumption max. (no load)	80 mA
output circuit	analog
output signal	0 ... 10 VDC
load resistance (analog U)	> 100 kOhm
output current	< 100 mA
alarm output	push-pull
short circuit protection	yes
reverse polarity protection	yes, Vs to GND

**mechanical data**

width / diameter	14,8 mm
height / length	43 mm
depth	31 mm
type	rectangular
housing material	plastic (ASA, MABS)
front (optics)	PMMA

**ambient conditions**

operating temperature	0 ... +50 °C
protection class	IP 67

**order reference**

<b>FADK 14U4470/IO</b>	cable 4 pin, 2 m
<b>FADK 14U4470/S14/IO</b>	connector M12 4 pin
<b>FADK 14U4470/S35A/IO</b>	connector M8 4 pin

**connection types**

**connection diagram**

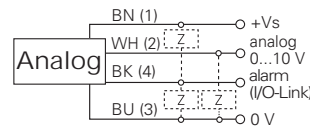

**connectors and mating connectors**

ESW 33AH0200G	Connector M12, 4 pin, angular, 2 m, shielded
ESG 32AH0200G	Connector M8, 4 pin, straight, 2 m, shielded
ESW 31AH0200G	Connector M8, 4 pin, angular, 2 m, shielded

additional cable connectors and field wireable connectors: see accessories

**Accessories**

10134964	Mounting bracket series 14 (L design)
10149011	Sensofix series 14

for details: see accessories section

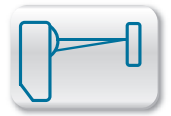

resolution

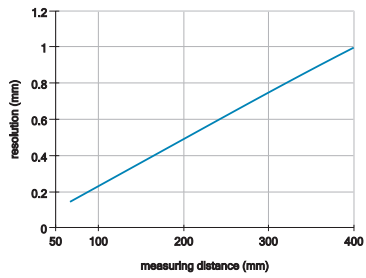

linearity error

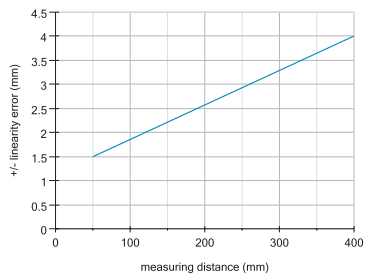

dimension drawing

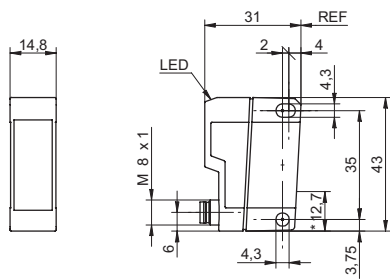

\* emitter axis

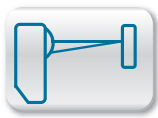

Sd = 50 ... 400 mm



- washdown design
- compact design
- measuring distance Sd 50 ... 400 mm

**general data**

measuring distance Sd	50 ... 400 mm
special type	Washdown design
adjustment	IO-Link
Teach-in range min.	> 20 mm
power on indication	LED green
soiled lens indicator	LED red
resolution	0,1 ... 1 mm
linearity error	± 1,5 ... ± 4 mm
light source	pulsed point source LED
wave length	660 nm
beam type	point
beam diameter	8 mm
temperature drift	< 0,1 % Sde/K
approvals/certificates	Ecolab

**electrical data**

response time / release time	< 3 ms
voltage supply range +Vs	12 ... 26 VDC
current consumption max. (no load)	80 mA
output circuit	analog
output signal	4 ... 20 mA
load resistance (analog I)	< (+Vs - 10 V) / 0,02 A
output current	< 100 mA
alarm output	push-pull
short circuit protection	yes
reverse polarity protection	yes, Vs to GND

**mechanical data**

width / diameter	19,6 mm
height / length	51 mm
depth	34,3 mm
type	rectangular
housing material	stainless steel 1.4404 (V4A); LSR
front (optics)	PMMA
connection types	connector M12

**ambient conditions**

operating temperature	0 ... +50 °C
protection class	IP 68/69K & proTect+

**order reference**

FADR 14I4470/S14/IO

**connection diagram**

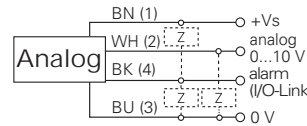

**connectors and mating connectors**

ESG 34AY0200	Connector M12, 4 pin, straight, 2 m, V4A-PP
ESW 33AY0200	Connector M12, 4 pin, angular, 2 m, V4A-PP

additional cable connectors and field wireable connectors: see accessories

**Accessories**

10134964	Mounting bracket series 14 (L design)
10149011	Sensofix series 14

for details: see accessories section

FADR 14 Sd = 50 ... 400 mm

Photoelectric distance measuring sensors

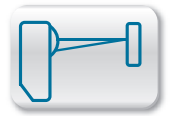

resolution

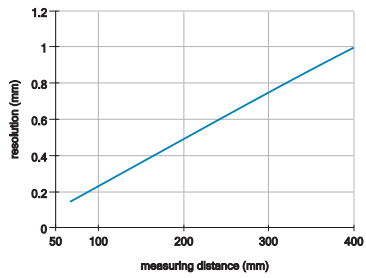

linearity error

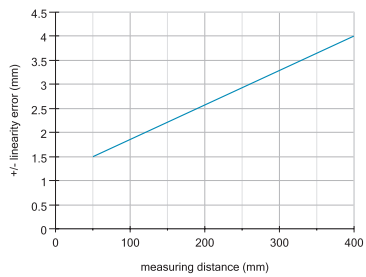

dimension drawing

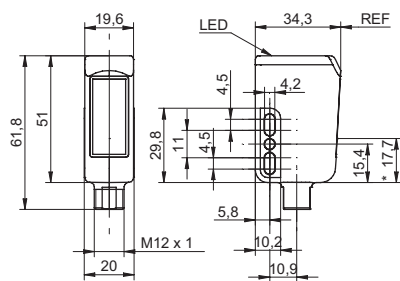

\* emitter axis

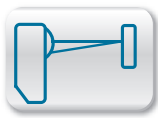

**Sd = 50 ... 400 mm**



- washdown design
- compact design
- measuring distance Sd 50 ... 400 mm

#### general data

measuring distance Sd	50 ... 400 mm
special type	Washdown design
adjustment	IO-Link
Teach-in range min.	> 20 mm
power on indication	LED green
soiled lens indicator	LED red
resolution	0,1 ... 1 mm
linearity error	± 1,5 ... ± 4 mm
light source	pulsed point source LED
wave length	660 nm
beam type	point
beam diameter	8 mm
temperature drift	< 0,1 % Sde/K
approvals/certificates	Ecolab

#### electrical data

response time / release time	< 3 ms
voltage supply range +Vs	14 ... 26 VDC
current consumption max. (no load)	80 mA
output circuit	analog
output signal	0 ... 10 VDC
load resistance (analog U)	> 100 kOhm
output current	< 100 mA
alarm output	push-pull
short circuit protection	yes
reverse polarity protection	yes, Vs to GND

#### mechanical data

width / diameter	19,6 mm
height / length	51 mm
depth	34,3 mm
type	rectangular
housing material	stainless steel 1.4404 (V4A); LSR
front (optics)	PMMA
connection types	connector M12

#### ambient conditions

operating temperature	0 ... +50 °C
protection class	IP 68/69K & proTect+

#### order reference

**FADR 14U4470/S14/IO**

#### connection diagram

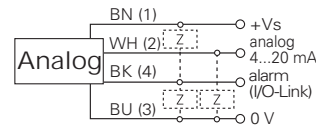

#### connectors and mating connectors

ESG 34AY0200 Connector M12, 4 pin, straight, 2 m, V4A-PP

ESW 33AY0200 Connector M12, 4 pin, angular, 2 m, V4A-PP

additional cable connectors and field wireable connectors: see accessories

#### Accessories

10134964 Mounting bracket series 14 (L design)

10149011 Sensofix series 14

for details: see accessories section





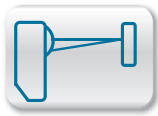

Sd = 50 ... 400 mm



- hygienic design
- compact design
- measuring distance Sd 50 ... 400 mm

**general data**

measuring distance Sd	50 ... 400 mm
special type	hygienic design
adjustment	IO-Link
Teach-in range min.	> 20 mm
power on indication	LED green
soiled lens indicator	LED red
resolution	0,1 ... 1 mm
linearity error	± 1,5 ... ± 4 mm
light source	pulsed point source LED
wave length	660 nm
beam type	point
beam diameter	8 mm
temperature drift	< 0,1 % Sde/K
approvals/certificates	Ecolab EHEDG

**electrical data**

response time / release time	< 3 ms
voltage supply range +Vs	12 ... 26 VDC
current consumption max. (no load)	80 mA
output circuit	analog
output signal	4 ... 20 mA
load resistance (analog I)	< (+Vs - 10 V) / 0,02 A
output current	< 100 mA
alarm output	push-pull
short circuit protection	yes
reverse polarity protection	yes, Vs to GND

**mechanical data**

width / diameter	19,6 mm
height / length	52,2 mm
depth	34,3 mm
type	rectangular
housing material	stainless steel 1.4404 (V4A)
front (optics)	PMMA

**ambient conditions**

operating temperature	0 ... +50 °C
protection class	IP 68/69K & proTect+

**order reference      connection types**

<b>FADH 14I4470/IO</b>	cable 4 pin, 2 m
<b>FADH 14I4470/KS34A/IO</b>	flylead connector M12, L=300 mm

**connection diagram**

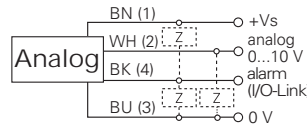

**connectors and mating connectors**

ESG 34AY0200	Connector M12, 4 pin, straight, 2 m, V4A-PP
ESW 33AY0200	Connector M12, 4 pin, angular, 2 m, V4A-PP

additional cable connectors and field wireable connectors: see accessories

**Accessories**

HI17-1H	Mounting for sensors in hygienic design Ø 17 mm
---------	---

for details: see accessories section

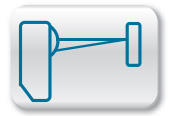

resolution

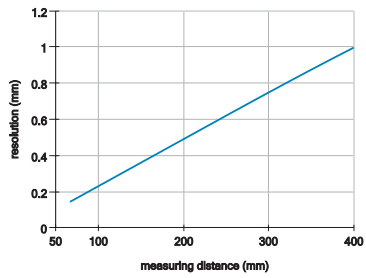

linearity error

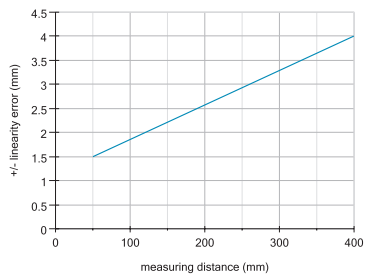

dimension drawing

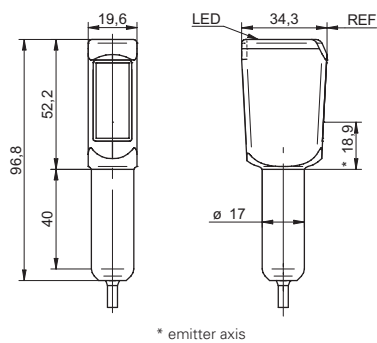

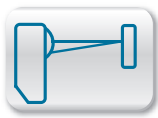

Sd = 50 ... 400 mm



- hygienic design
- compact design
- measuring distance Sd 50 ... 400 mm

**general data**

measuring distance Sd	50 ... 400 mm
special type	hygienic design
adjustment	IO-Link
Teach-in range min.	> 20 mm
power on indication	LED green
soiled lens indicator	LED red
resolution	0,1 ... 1 mm
linearity error	± 1,5 ... ± 4 mm
light source	pulsed point source LED
wave length	660 nm
beam type	point
beam diameter	8 mm
temperature drift	< 0,1 % Sde/K
approvals/certificates	Ecolab EHEDG

**electrical data**

response time / release time	< 3 ms
voltage supply range +Vs	14 ... 26 VDC
current consumption max. (no load)	80 mA
output circuit	analog
output signal	0 ... 10 VDC
load resistance (analog U)	> 100 kOhm
output current	< 100 mA
alarm output	push-pull
short circuit protection	yes
reverse polarity protection	yes, Vs to GND

**mechanical data**

width / diameter	19,6 mm
height / length	52,2 mm
depth	34,3 mm
type	rectangular
housing material	stainless steel 1.4404 (V4A)
front (optics)	PMMA

**ambient conditions**

operating temperature	0 ... +50 °C
protection class	IP 68/69K & proTect+

**order reference      connection types**

<b>FADH 14U4470/IO</b>	cable 4 pin, 2 m
<b>FADH 14U4470/KS34A/IO</b>	flylead connector M12, L=300 mm

**connection diagram**

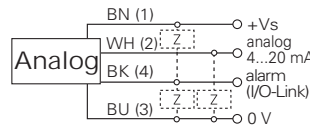

**connectors and mating connectors**

ESG 34AY0200	Connector M12, 4 pin, straight, 2 m, V4A-PP
ESW 33AY0200	Connector M12, 4 pin, angular, 2 m, V4A-PP

additional cable connectors and field wireable connectors: see accessories

**Accessories**

HI17-1H	Mounting for sensors in hygienic design Ø 17 mm
---------	---

for details: see accessories section

FADH 14 Sd = 50 ... 400 mm

Photoelectric distance measuring sensors

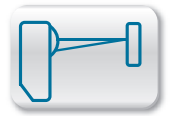

resolution

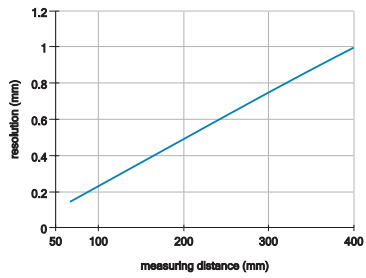

linearity error

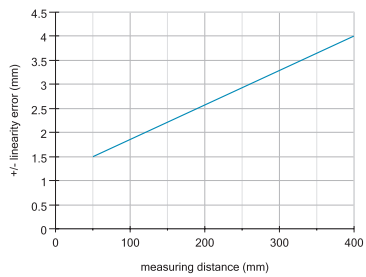

dimension drawing

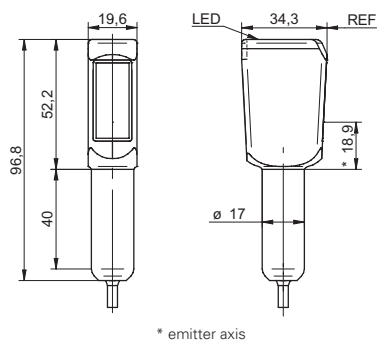

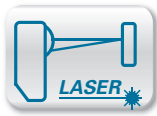

Sd = 100 ... 1000 mm



- qTeach
- alarm output

**general data**

measuring distance Sd	100 ... 1000 mm
adjustment	Teach-in
Teach-in range min.	> 50 mm
power on indication	LED green
soiled lens indicator	LED red
resolution	0,3 ... 4 mm
linearity error	± 1,1 ... ± 15 mm
light source	pulsed red laser diode
wave length	656 nm
laser class	1
beam type	point
beam diameter	3,7 ... 13 mm
interference suppression	< 32 ms

**electrical data**

response time / release time	< 12,8 ms
voltage supply range +Vs	12 ... 30 VDC
current consumption max. (no load)	80 mA
output circuit	analog
output current	< 100 mA
alarm output	push-pull
short circuit protection	yes
reverse polarity protection	yes, Vs to GND

**mechanical data**

width / diameter	23,4 mm
height / length	63 mm
depth	45 mm
type	rectangular
housing material	plastic (SAN LURAN 378P)
front (optics)	PMMA

**ambient conditions**

ambient light immunity	< 20 kLux
operating temperature	0 ... +50 °C
protection class	IP 67

**connection diagrams**

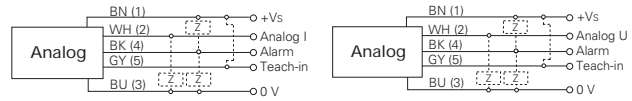

**connectors and mating connectors**

ESG 34CH0200G Connector M12, 5 pin, straight, 2 m, shielded  
 additional cable connectors and field wireable connectors: see accessories

**Accessories**

11077517 Mounting bracket for sensors series 25 (L design)  
 for details: see accessories section

**laser warning**



IEC 60825-1/2014  
 Complies with 21 CFR 1040.10 and 1040.11  
 except for deviations pursuant to laser  
 notice No. 50, dated June 24, 2007

order reference	output signal	connection types	load resistance (analog U)	load resistance (analog I)
OADK 25I7480	4 ... 20 mA	cable, 2 m	-	< (+Vs - 6 V) / 0,02 A
OADK 25I7480/S14C	4 ... 20 mA	connector M12 5 pin	-	< (+Vs - 6 V) / 0,02 A
OADK 25U7480	0 ... 10 VDC	cable, 2 m	> 100 kOhm	-
OADK 25U7480/S14C	0 ... 10 VDC	connector M12 5 pin	> 100 kOhm	-

OADK 25 Sd = 100 ... 1000 mm

Photoelectric distance measuring sensors

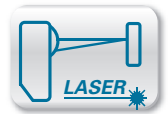

**resolution**

Sd = 100 ... 1000 mm

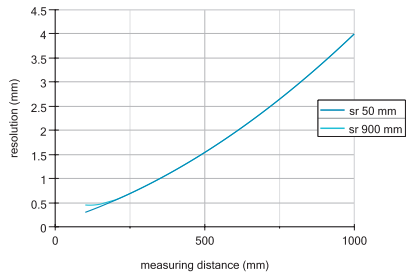

**linearity error**

Sd = 100 ... 1000 mm

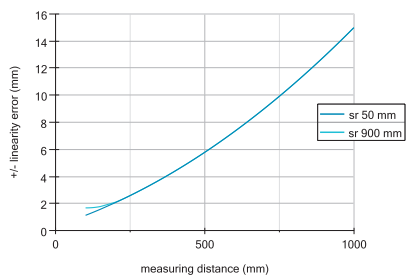

**dimension drawing**

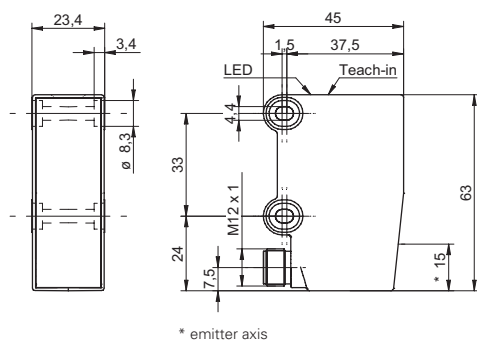







## Smart profile sensors *PosCon*<sup>®</sup>

Overview	Page 712
Width measurement OXE7	Page 714
Height measurement OXH7	Page 716
Measurement of round objects OXC7	Page 720

product family	OXE7	OXH7	OXH7	OXC7
				
	<i>PosCon</i> edges, width, gap	<i>PosCon</i> height measurement	<i>PosCon</i> height measurement	<i>PosCon</i> round objects
laser class	1	2	1	1
resolution	20 µm 30 ... 50 µm	4 ... 25 µm	2 ... 4 µm	10 ... 40 µm
linearity error	± 50 ... ± 75 µm ± 80 ... ± 120 µm	± 100 µm	± 30 ... ± 90 µm	± 35 ... ± 60 µm
measuring frequency	90 ... 250 Hz 111 ... 370 Hz 125 ... 500 Hz 159 ... 625 Hz	1540 Hz	570 Hz	450 Hz
ambient light immunity	< 25 kLux < 35 kLux	< 35 kLux	< 35 kLux	< 25 kLux
output circuit	analog and RS 485	analog and RS 485	analog and RS 485	analog and RS 485
output signal	4 ... 20 mA / 0 ... 10 VDC	4 ... 20 mA / 0 ... 10 VDC	4 ... 20 mA / 0 ... 10 VDC	4 ... 20 mA / 0 ... 10 VDC
<b>page</b>	<b>714</b>	<b>716</b>	<b>718</b>	<b>720</b>





Sd = 150 ... 250 mm



- 0-10 VDC / 4-20 mA (adaptive)
- measuring mode: edges, center, width, gap
- RS 485 interface

**general data**

type	measuring mode: edges, center, width, gap
repeat accuracy	± 10 µm
power on indication	LED green
output indicator	LED yellow / LED red
light source	pulsed red laser diode
wave length	656 nm
laser class	1
adjustment	Touch Display, RS485

**electrical data**

voltage supply range +Vs	15 ... 28 VDC
current consumption max. (no load)	150 mA
output circuit	analog and RS 485
output signal	4 ... 20 mA / 0 ... 10 VDC
switching output	push-pull
output function	Out 1 / Alarm
output current	< 100 mA
baud rate	115200, adjustable
reverse polarity protection	yes, Vs to GND
short circuit protection	yes

**mechanical data**

width / diameter	26 mm
height / length	74 mm
depth	55 mm
type	rectangular, front view
housing material	aluminum
front (optics)	glass
connection types	connector M12 8 pin
weight	130 g

**ambient conditions**

operating temperature	-20 ... +50 °C
protection class	IP 67
storage temperature	-25 ... +75 °C
vibration (sinusoidal)	IEC 60068-2-6:2008 1.5 mm p-p at f = 10 - 57 Hz, 10 cycles per axis 10 g at f = 58 - 2000 Hz, 10 cycles per axis
shock (semi-sinusoidal)	IEC 60068-2-27:2009 50 g / 11 ms resp. 100 g / 6 ms, 10 jolts per axis and direction 100 g / 2 ms, 5000 jolts per axis and direction

**connection diagram**

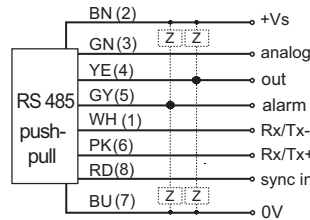

**connectors and mating connectors**

ESG 34FH0200G	Connector M12, 8 pin, straight, 2 m, shielded
ESW 33FH0200G	Connector M12, 8 pin, angular, 2 m, shielded
ESW 33FH0500G	Connector M12, 8 pin, angular, 5 m, shielded
ESW 33FH1000G	Connector M12, 8 pin, angular, 10 m, shielded

additional cable connectors and field wireable connectors: see accessories

**Accessories**

11120705	Mounting bracket X7 90° for PosCon and OM70, incl. accessories
11126836	Mounting bracket X7 30° horizontal for PosCon and OM70, incl. accessories
11126837	Mounting bracket X7 30° vertical for PosCon and OM70, incl. accessories

for details: see accessories section

**laser warning**



IEC 60825-1/2014  
Complies with 21 CFR 1040.10 and 1040.11  
except for deviations pursuant to laser  
notice No. 50, dated June 24, 2007



order reference	measuring range (width)	measuring range (distance)	version	measuring frequency	resolution	linearity error	temperature drift
OXE7.E15T-11177353	48 ... 72 mm	100 ... 150 mm	PosCon OXE7 - for very precise measurements and dark objects	111 ... 370 Hz	20 µm	± 50 ... ± 75 µm	< 0,03 % measured value/K
OXE7.E15T-11148276	48 ... 72 mm	100 ... 150 mm	PosCon OXE7 - for very precise measurements	159 ... 625 Hz	20 µm	± 50 ... ± 75 µm	< 0,03 % measured value/K
OXE7.E25T-11174280	75 ... 125 mm	150 ... 250 mm	PosCon OXE7 - for very dark objects	90 ... 250 Hz	30 ... 50 µm	± 80 ... ± 120 µm	< 0,05 % measured value/K
OXE7.E25T-11111452	75 ... 125 mm	150 ... 250 mm	PosCon OXE7	125 ... 500 Hz	30 ... 50 µm	± 80 ... ± 120 µm	< 0,05 % measured value/K

dimension drawing

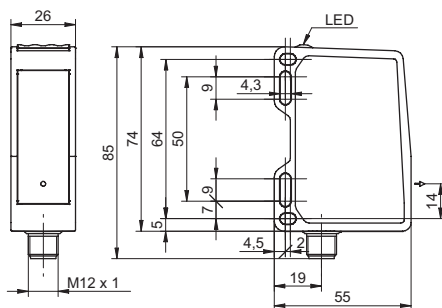



**Sd = 100 ... 500 mm**

- Position-independent height measurements
- Very high resolution up to 4 µm
- Output in mm
- Touch display for parameterization



**general data**

type	height
version	PosCon OXH7
measuring range (width)	13 ... 66 mm
measuring range (distance)	100 ... 500 mm
measuring frequency	1540 Hz
resolution	4 ... 25 µm
repeat accuracy	4 ... 20 µm
linearity error	± 100 µm
temperature drift	± 0,04 % Sde/K
power on indication	LED green
light source	pulsed red laser diode
wave length	660 nm
laser class	2
optical peak power max.	6 mW
adjustment	Touch Display, RS485

**electrical data**

response time / release time	1,3 ms
voltage supply range +Vs	15 ... 28 VDC
current consumption max. (no load)	120 mA
output circuit	analog and RS 485
output signal	4 ... 20 mA / 0 ... 10 VDC
switching output	push-pull
output function	Out 1 / Alarm
output current	< 100 mA
baud rate	115200, adjustable
reverse polarity protection	yes, Vs to GND
short circuit protection	yes

**mechanical data**

width / diameter	26 mm
height / length	74 mm
depth	55 mm
type	rectangular, front view
housing material	aluminum
front (optics)	glass
connection types	connector M12 8 pin
weight	130 g

**connection diagram**

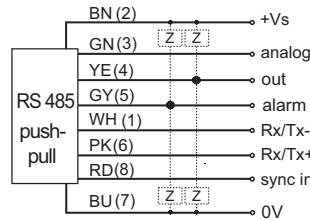

**connectors and mating connectors**

ESG 34FH0200G	Connector M12, 8 pin, straight, 2 m, shielded
ESW 33FH0200G	Connector M12, 8 pin, angular, 2 m, shielded
ESW 33FH0500G	Connector M12, 8 pin, angular, 5 m, shielded
ESW 33FH1000G	Connector M12, 8 pin, angular, 10 m, shielded

additional cable connectors and field wireable connectors: see accessories

**Accessories**

11120705	Mounting bracket X7 90° for PosCon and OM70, incl. accessories
11126836	Mounting bracket X7 30° horizontal for PosCon and OM70, incl. accessories
11126837	Mounting bracket X7 30° vertical for PosCon and OM70, incl. accessories

for details: see accessories section

**laser warning**

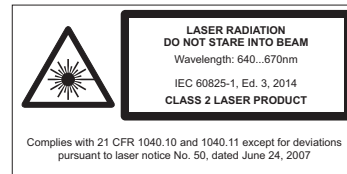

**ambient conditions**

ambient light immunity	< 35 kLux
operating temperature	-10 ... +50 °C
protection class	IP 67
storage temperature	-25 ... +75 °C
vibration (sinusoidal)	IEC 60068-2-6:2008 1.5 mm p-p at f = 10 - 57 Hz, 10 cycles per axis 10 g at f = 58 - 2000 Hz, 10 cycles per axis
shock (semi-sinusoidal)	IEC 60068-2-27:2009 50 g / 11 ms resp. 100 g / 6 ms, 10 jolts per axis and direction 100 g / 2 ms, 5000 jolts per axis and direction



order reference

OXH7-11161809

dimension drawing

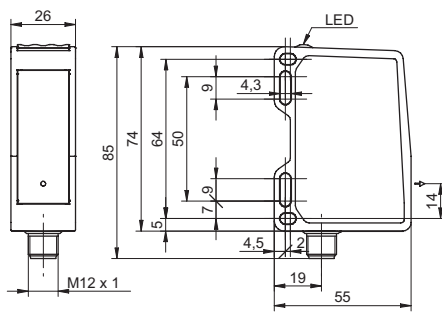



**Sd = 100 ... 150 mm**

- Position-independent height measurements
- Very high resolution up to 2 µm
- Output in mm



**general data**

type	height
version	PosCon OXH7
measuring range (width)	48 ... 72 mm
measuring range (distance)	100 ... 150 mm
measuring frequency	570 Hz
resolution	2 ... 4 µm
linearity error	± 30 ... ± 90 µm
temperature drift	± 0,04 % Sde/K
power on indication	LED green
light source	pulsed red laser diode
wave length	656 nm
laser class	1
optical peak power max.	2,4 mW
adjustment	Touch Display, RS485

**electrical data**

response time / release time	3,5 ms
voltage supply range +Vs	15 ... 28 VDC
current consumption max. (no load)	120 mA
output circuit	analog and RS 485
output signal	4 ... 20 mA / 0 ... 10 VDC
switching output	push-pull
output function	Out 1 / Alarm
output current	< 100 mA
baud rate	115200, adjustable
reverse polarity protection	yes, Vs to GND
short circuit protection	yes

**mechanical data**

width / diameter	26 mm
height / length	74 mm
depth	55 mm
type	rectangular, front view
housing material	aluminum
front (optics)	glass
connection types	connector M12 8 pin
weight	130 g

**ambient conditions**

ambient light immunity	< 35 kLux
operating temperature	-10 ... +50 °C
protection class	IP 67
storage temperature	-25 ... +75 °C
vibration (sinusoidal)	IEC 60068-2-6:2008 1.5 mm p-p at f = 10 - 57 Hz, 10 cycles per axis 10 g at f = 58 - 2000 Hz, 10 cycles per axis
shock (semi-sinusoidal)	IEC 60068-2-27:2009 50 g / 11 ms resp. 100 g / 6 ms, 10 jolts per axis and direction 100 g / 2 ms, 5000 jolts per axis and direction

**connection diagram**

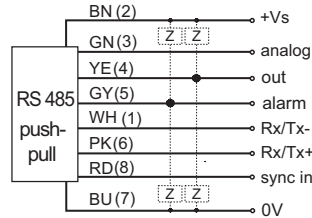

**connectors and mating connectors**

ESG 34FH0200G	Connector M12, 8 pin, straight, 2 m, shielded
ESW 33FH0200G	Connector M12, 8 pin, angular, 2 m, shielded
ESW 33FH0500G	Connector M12, 8 pin, angular, 5 m, shielded
ESW 33FH1000G	Connector M12, 8 pin, angular, 10 m, shielded

additional cable connectors and field wireable connectors: see accessories

**Accessories**

11120705	Mounting bracket X7 90° for PosCon and OM70, incl. accessories
11126836	Mounting bracket X7 30° horizontal for PosCon and OM70, incl. accessories
11126837	Mounting bracket X7 30° vertical for PosCon and OM70, incl. accessories

for details: see accessories section

**laser warning**



IEC 60825-1/2014  
Complies with 21 CFR 1040.10 and 1040.11  
except for deviations pursuant to laser  
notice No. 50, dated June 24, 2007





order reference

OXH7-11159406

dimension drawing

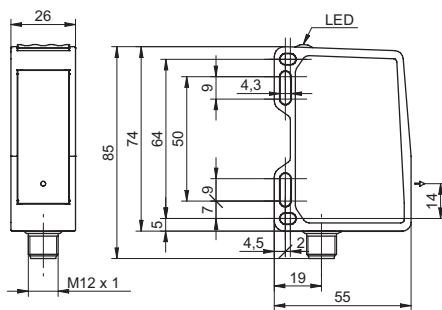



**Sd = 150 ... 250 mm**



- Measurement of center positions, diameters, and outer positions of round objects
- Suitable for outer diameters up to 130 mm
- Output in mm

**general data**

type	measuring mode: center, diameter, limits left, right and top for round objects
version	PosCon OXC7
measuring range (width)	75 ... 125 mm
measuring range (distance)	150 ... 250 mm
measuring frequency	450 Hz
resolution	10 ... 40 µm
repeat accuracy	10 ... 20 µm
linearity error	± 35 ... ± 60 µm
temperature drift	± 0,05 % Sde/K
power on indication	LED green
output indicator	LED yellow / LED red
light source	pulsed red laser diode
wave length	656 nm
laser class	1
optical peak power max.	3 mW
adjustment	Touch Display, RS485
object type	round
object diameter min.	30 mm
object diameter max.	130 mm

**electrical data**

response time / release time	7 ms
voltage supply range +Vs	15 ... 28 VDC
current consumption max. (no load)	120 mA
output circuit	analog and RS 485
output signal	4 ... 20 mA / 0 ... 10 VDC
switching output	push-pull
output function	Out 1 / Alarm
output current	< 100 mA
baud rate	115200, adjustable
reverse polarity protection	yes, Vs to GND
short circuit protection	yes

**mechanical data**

width / diameter	26 mm
height / length	74 mm
depth	55 mm
type	rectangular, front view
housing material	aluminum
front (optics)	glass
connection types	connector M12 8 pin
weight	130 g

**connection diagram**

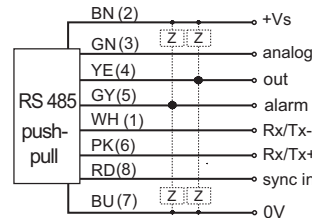

**connectors and mating connectors**

ESG 34FH0200G	Connector M12, 8 pin, straight, 2 m, shielded
ESW 33FH0200G	Connector M12, 8 pin, angular, 2 m, shielded
ESW 33FH0500G	Connector M12, 8 pin, angular, 5 m, shielded
ESW 33FH1000G	Connector M12, 8 pin, angular, 10 m, shielded

additional cable connectors and field wireable connectors: see accessories

**Accessories**

11120705	Mounting bracket X7 90° for PosCon and OM70, incl. accessories
11126836	Mounting bracket X7 30° horizontal for PosCon and OM70, incl. accessories
11126837	Mounting bracket X7 30° vertical for PosCon and OM70, incl. accessories

for details: see accessories section

**laser warning**



IEC 60825-1/2014  
Complies with 21 CFR 1040.10 and 1040.11  
except for deviations pursuant to laser  
notice No. 50, dated June 24, 2007

**ambient conditions**

ambient light immunity	< 25 kLux
operating temperature	-10 ... +50 °C
protection class	IP 67
storage temperature	-25 ... +75 °C
vibration (sinusoidal)	IEC 60068-2-6:2008 1.5 mm p-p at f = 10 - 57 Hz, 10 cycles per axis 10 g at f = 58 - 2000 Hz, 10 cycles per axis
shock (semi-sinusoidal)	IEC 60068-2-27:2009 50 g / 11 ms resp. 100 g / 6 ms, 10 jolts per axis and direction 100 g / 2 ms, 5000 jolts per axis and direction





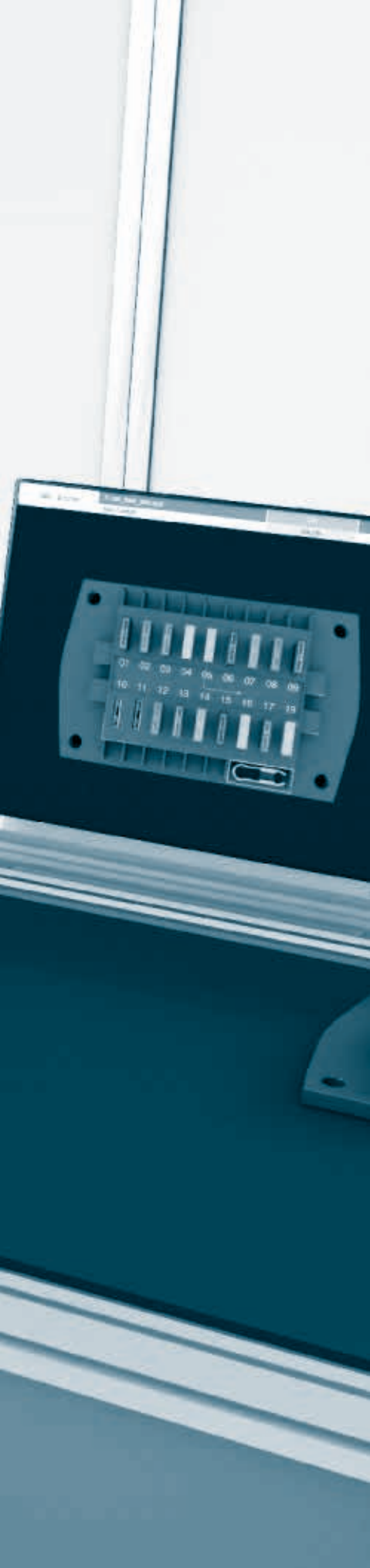

## Vision sensors *VeriSens*<sup>®</sup>

Overview	Page 726
<i>VeriSens</i> <sup>®</sup> CS / ID / XF	Page 728
<i>VeriSens</i> <sup>®</sup> XC	Page 730
<i>VeriSens</i> <sup>®</sup> XF (IP 69K)	Page 732

# Vision sensors *VeriSens*<sup>®</sup>

## Applications



- Presence and completeness check



- Acquisition of part location and correct position



- Reading of numbers and characters



- Reading of barcodes and matrix codes

## Integration – easy and flexible



- Each 5 freely definable digital inputs / outputs
- Encoder interface



- Siemens SIMATIC<sup>®</sup> S7 function modules
- Process interface



- Visualization of live and defect images
- Backup & Restore function



- Industrial Ethernet integrated (PROFINET / EtherNet/IP<sup>™</sup>)
- NAT support



## Fields of application

- Quality control
- Food & beverage
- Assembly/Handling
- Packaging industry
- Electronics industry
- Pharmaceutical industry

The image-processing *VeriSens*<sup>®</sup> vision sensors provide extensive capabilities for a variety of inspection tasks in automation technology. LED lighting, precision optics, a CCD or CMOS camera, processing electronics, and interfaces are integrated in the industrial-suited and compact metal housing (IP 67, IP 69K).

The unified user interface allows intuitive configuration of the vision sensors, even for non-experts in image processing. Visualization or a quick job switching when changing products are also available via a configurable web interface.





## Vision sensor *VeriSens*® for checking and sorting of products

- Completeness and presence control of food packaging

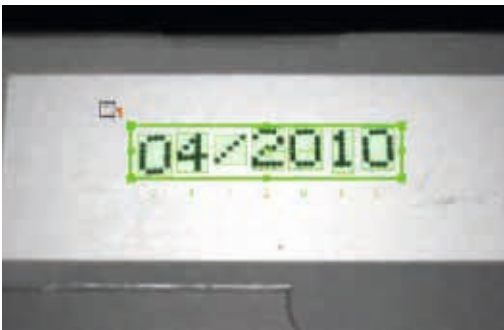

### *VeriSens*® ID series

#### Reading of text and 1D/2D codes

- Multi Reader for text and codes (incl. GS1)
- Reading of text without font training
- Various codes are read simultaneously



### *VeriSens*® CS series

#### Checking and sorting of products

- Presence and completeness check
- Part recognition and part sorting
- Checking of part geometry







### *VeriSens*® XF / XC series

#### Powerful for complex inspection tasks





- Largest set of *VeriSens*® feature checks
- Coordinate conversion for Pick & Place
- Result output via process interface



product family	VS CS100M03	VS ID100M03	VS ID510M03	VS XF700M03
				
	<i>VeriSens</i> <sup>®</sup> CS100	<i>VeriSens</i> <sup>®</sup> ID100	<i>VeriSens</i> <sup>®</sup> ID510	<i>VeriSens</i> <sup>®</sup> XF700
resolution (format)	752 × 480 px (1/3")	752 × 480 px (1/3")	752 × 480 px (1/3")	752 × 480 px (1/3")
sensor	CMOS	CMOS	CMOS	CMOS
optics	10 / 16 mm	10 / 16 mm	12 mm	12 / 16 mm
min. object distance	50 / 70 mm	50 / 70 mm	50 mm	50 / 100 mm
illumination LED white	■	■	■	■
illumination LED infrared	■	■	■	■
<i>VeriFlash</i> <sup>®</sup> integrated flash controller				
communication	setup Ethernet (10 Base-T / 100 Base-TX)	setup Ethernet (10 Base-T / 100 Base-TX) process interface TCP/IP   RS 485	setup Ethernet (10 Base-T / 100 Base-TX) process interface PROFINET (CC-A)/ EtherNet/IP™, TCP/UDP	setup Ethernet (10 Base-T / 100 Base-TX) process interface PROFINET (CC-A)/ EtherNet/IP™, TCP/UDP
material: housing cover glass	Aluminum PMMA	Aluminium PMMA	Aluminum PMMA	Aluminum PMMA
identification functions code/ text		■ / -	■ / ■	
<i>ColorFEX</i> <sup>®</sup> 3D color assistant				■
distortion correction (monochrome only)				■
configurable web interface with <i>MultiViewer</i>	■	■	■	■
page	728	728	728	728





VS XF800M03	VS XC700M	VS XC800M	VS XF105M03	VS XF205M03
				
<i>VeriSens</i> <sup>®</sup> XF800	<i>VeriSens</i> <sup>®</sup> XC700	<i>VeriSens</i> <sup>®</sup> XC800	<i>VeriSens</i> <sup>®</sup> XF105	<i>VeriSens</i> <sup>®</sup> XF205
752 × 480 px (1/3")	A) 640 × 480 px (1/4") B) 1280 × 960 px (1/3") C) 1600 × 1200 px (1/1.8")	A) 640 × 480 px (1/4") B) 1280 × 960 px (1/3") C) 1600 × 1200 px (1/1.8")	752 × 480 px (1/3")	752 × 480 px (1/3")
CMOS	CCD	CCD	CMOS	CMOS
12 / 16 mm	C-mount	C-mount	10 / 16 mm	10 / 16 mm
50 / 100 mm	changeable lens (C-mount)	changeable lens (C-mount)	50 / 70 mm	50 / 70 mm
■			■	■
■			■	■
	■	■		
setup Ethernet (10 Base-T / 100 Base-TX) process interface PROFINET (CC-A)/ EtherNet/IP™, TCP/UDP	setup Ethernet (10 Base-T / 100 Base-TX) process interface PROFINET (CC-A)/ EtherNet/IP™, TCP/UDP	setup Ethernet (10 Base-T / 100 Base-TX) process interface PROFINET (CC-A)/ EtherNet/IP™, TCP/UDP	setup Ethernet (10 Base-T / 100 Base-TX) process interface TCP/IP	setup Ethernet (10 Base-T / 100 Base-TX) process interface TCP/IP
Aluminum PMMA	Aluminum PMMA	Aluminum PMMA	stainless steel 1.4404 PMMA	stainless steel 1.4404 PMMA
■ / ■		■ / ■		■ / ■
■	■	■		
	resolution: A, B	resolution: A, B		
■	■	■		
■	■	■	■	■
<b>728</b>	<b>730</b>	<b>730</b>	<b>732</b>	<b>732</b>



**focal distance = 10 / 12 / 16 mm**

- Image-based quality control with one single sensor
- Easy configuration within a few minutes
- Interfaces: Industrial Ethernet, digital I/Os



**general data**

sensor	CMOS
resolution (format)	752 × 480 px (1/3")
type	monochrome, color
illumination	white, infrared
<b>speed</b>	max. inspections/s (monochrome)
High-resolution mode:	50
High-speed mode:	100 (XF series only)
objectiv (focal distance)	10 mm 12 mm 16 mm
object distance min.	50 mm 50 mm 70/100 mm
number of jobs (products)	up to 255 on the device
features per job	32
inputs	8 ... 30 V
outputs	PNP 100 mA
digital input	Trigger, Job selection, External teach-in, Encoders (CH-A, CH-B) 500 kHz
digital output	Pass / Fail 1-5, Flash Sync, Alarm, Camera Ready, Output Enable

**communication**

initial setup:	Ethernet (10 BASE-T / 100 BASE-TX)
process interface:	PROFINET (CC-A) / EtherNet/IP™, TCP/UDP (Ethernet), RS485

**electrical data**

voltage supply range +Vs	= 18 ... 30 V
power consumption max.	typ. 8 W (I <sub>max</sub> = 1 A at 24 V)

**mechanical data**

width / diameter	53 mm
height / length	99.5 mm
depth	38 mm
type	rectangular
housing material	Aluminum and PMMA
weight	250 g

**ambient conditions**

operating temperature	+5 ... +50 °C @ measurement point
storage temperature	-20 ... +70 °C
humidity	0 ... 90 % (non-condensing)
protection class	IP 67
vibration load	IEC 60068-2-6, IEC 60068-2-64
mechanical shock resistance	EN 60068-2-27

**accessories**

<i>VeriSens</i> <sup>®</sup> mounting adapter	11177010
<i>VeriSens</i> <sup>®</sup> Application Suite CD	included in delivery
additional information	see accessories

**dimension drawing**

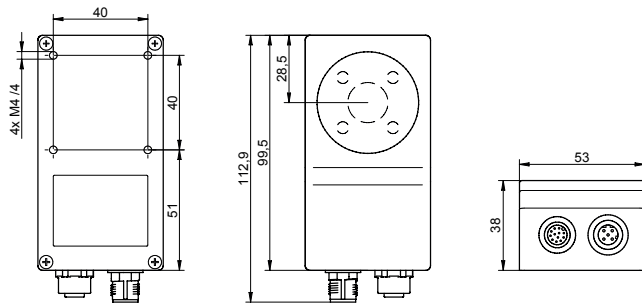

**Electrical connection**

**Type M12 / 12-pin, A-coded**

- 1: Power +18...30 V DC
- 2: Ground
- 3: IN1 (Trigger)
- 4: OUT1
- 5: IN2
- 6: OUT2
- 7: OUT3
- 8: IN3
- 9: OUT4 | RS485+
- 10: IN4
- 11: IN5
- 12: OUT5 | RS485-

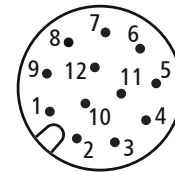

**Electrical connection**

**Type M12 / 4-pin**

- 1: TD+
- 2: RD+
- 3: TD-
- 4: RD-

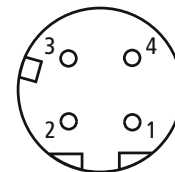

**connectors**

ESG 34JP0200G	12-pin	2 m straight (shielded)
ESG 34JP0500G	12-pin	5 m straight (shielded)
KSG 34A/ KSG45AP0200G/E	4-pin	2 m straight (shielded)
KSG 34A/ KSG45AP0500G/E	4-pin	5 m straight (shielded)

additional cable connectors and field wireable connectors, see accessories

order reference	lens	illumination
VS CS100M03W10EP	10 mm	white
VS CS100M03W16EP	16 mm	white
VS CS100M03I10EP	10 mm	infrared
VS CS100M03I16EP	16 mm	infrared

**functions**  
**Part location:** Part location on contours  
**Geometry:** Distance, Circle  
**Feature comparison:** Count contour points, Contour comparison, Brightness

order reference	lens	illumination
VS ID100M03W10RP	10 mm	white
VS ID100M03W16RP	16 mm	white
VS ID510M03W12IP	12 mm	white
VS ID510M03I12IP	12 mm	infrared

**Funktionen**  
**Identification:** Barcode, Matrix code  
**Identification:** Barcode, Matrix code, Text

order reference	lens	illumination
VS XF700M03W12IP	12 mm	white
VS XF700C03W12IP (color)		
VS XF700M03W16IP	16 mm	white
VS XF700C03W16IP (color)		
VS XF700M03I12IP	12 mm	infrared
VS XF700M03I16IP	16 mm	infrared

**functions (\*VS XF700C03WxxIP only)**  
**Part location:** Part location on contours, Part location on edges, Part location on circle, Part location on text line  
**Geometry:** Distance, Circle, Angle, Count edges, Point position, Edge characteristics  
**Feature comparison:** Count contour points, Contour comparison, Area size, Count areas, Pattern comparison, Find object positions, Brightness, Contrast, Color identification\*, Color positioning\*

order reference	lens	illumination
VS XF800M03W12IP	12 mm	white
VS XF800C03W12IP (color)		
VS XF800M03W16IP	16 mm	white
VS XF800C03W16IP (color)		
VS XF800M03I12IP	12 mm	infrared
VS XF800M03I16IP	16 mm	infrared

**functions (\*VS XF800C03WxxIP only)**  
**Part location:** Part location on contours, Part location on edges, Part location on circle, Part location on text line  
**Geometry:** Distance, Circle, Angle, Count edges, Point position, Edge characteristics  
**Feature comparison:** Count contour points, Contour comparison, Area size, Count areas, Pattern comparison, Find object positions, Brightness, Contrast, Color identification\*, Color positioning\*  
**Identification:** Barcode, Matrix code, Text



**focal distance = 10 / 16 mm**

- Image-based quality control with one single sensor
- Easy configuration within a few minutes
- Interfaces: Industrial Ethernet, digital I/Os



**general data**

sensor	CMOS
resolution (format)	640 × 480 px (1/4") <sup>1)</sup> 1280 × 960 px (1/3") <sup>2)</sup> 1600 × 1200 px (1/1.8") <sup>3)</sup>
type	monochrome <sup>1, 2, 3)</sup> // color <sup>1, 2)</sup>
<b>speed</b>	max. inspections/s (monochrome)
High-resolution mode:	118 // 116 <sup>1)</sup>   32 // 31 <sup>2)</sup>   21 <sup>3)</sup>
High-speed mode:	144 <sup>1)</sup>   54 <sup>2)</sup>   35 <sup>3)</sup>
number of jobs (products)	up to 255 on the device
features per job	32
inputs	8 ... 30V
outputs	PNP 100 mA
digital input	Trigger, Job selection, External teach-in, Encoders (CH-A, CH-B) 500 kHz
digital output	Pass / Fail 1-5, Flash Sync, Alarm, Camera Ready, Output Enable
<b>communication</b>	
initial setup:	Ethernet (10 BASE-T / 100 BASE-TX)
process interface:	PROFINET (CC-A) / EtherNet/IP™, TCP/UDP (Ethernet)

**electrical data**

voltage supply range +Vs	≐ 18 ... 30V
power consumption max.	typ. 5 W (I <sub>max</sub> = 1,5 A at 24 V)

**integrated flash controller**

Voltage (permanent)	≐ 12 V or ≐ 24 V
Voltage (pulsed)	⌈ 24 V or ⌈ 48 V
Current (permanent)	I <sub>max</sub> = 800 mA at ≐ 24 V (±10 %, at least ±100 mA, at 25 °C)
Current (pulsed)	I <sub>max</sub> = 4 A at ⌈ 48 V (+10/-20 %, at least ±100 mA, at 25 °C)
Flash time	max. 1 ms (Duty Cycle max. 1:10)

**Mechanische Daten**

width / diameter	53 mm
height / length	99.5 mm
depth	49.8 mm (without lens / tube)
type	rectangular
housing material	Aluminum and PMMA
weight	300 g (without lens / tube)

**ambient conditions**

operating temperature	+5 ... +50 °C @ measurement point
storage temperature	-20 ... +70 °C
humidity	0 ... 90 % (non-condensing)
protection class	IP 67 (with tube)
vibration load	IEC 60068-2-6, IEC 60068-2-64
mechanical shock resistance	EN 60068-2-27

**dimension drawing: device**

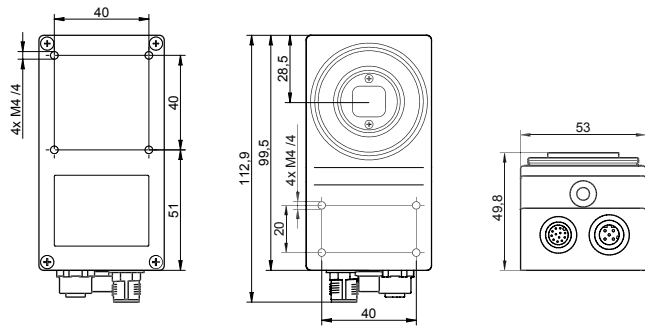

**dimension drawing: tube / tube module**

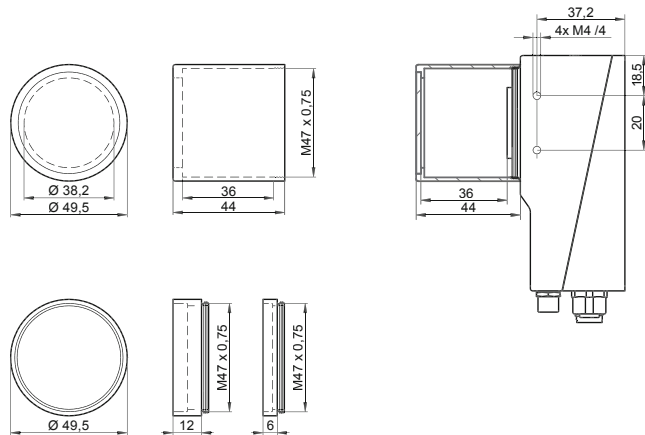

**accessories**

XC Tube, M47, length 44 mm	11088325 (included in delivery)
XC Tube Module, M47, 6 mm	11115649
XC Tube Module, M47, 12 mm	11089149
VeriSens <sup>®</sup> mounting adapter	11177010
VeriSens <sup>®</sup> Application Suite CD	included in delivery
additional information	see accessories

electrical connection	type M12 / 12-pin, A-coded
1: Power +18...30 V DC	
2: Ground	
3: IN1 (Trigger)	
4: OUT1	
5: IN2	
6: OUT2	
7: OUT3	
8: IN3	
9: OUT4	
10: IN4	
11: IN5	
12: OUT5	

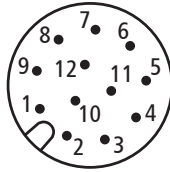

connectors		
ESG 34JP0200G	M12 / 12-pin	2 m straight (shielded)
ESG 34JP0500G	M12 / 12-pin	5 m straight (shielded)
KSG 34A/ KSG45AP0200G/E	M12 / 4-pin	2 m straight (shielded)
KSG 34A/ KSG45AP0500G/E	M12 / 4-pin	5 m straight (shielded)
ESG32A/JSTBV0030	M8 / 4-pin	30 cm straight (shielded), to JST 3-pin
ESG32A/JSTSV0030	M8 / 4-pin	30 cm straight (shielded), to JST 2-pin

additional cable connectors and field wireable connectors, see accessories

electrical connection	type M12 / 4-pin
1: TD+	
2: RD+	
3: TD-	
4: RD-	

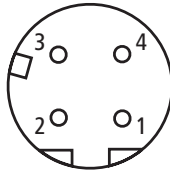

electr. connection illumination*	type M8 / 4-pin
1: +24 V bzw. +48 V Flash	
2: +12 V bzw. +24 V Flash	
3: Ground	
4: Flash Sync PNP 100 mA	

\* voltage outputs configurable by software

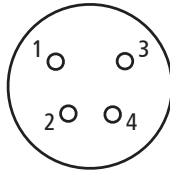

order reference	resolution (sensor)
<b>VS XC700M03X00IP</b>	640 × 480 px (1/4")
<b>VS XC700C03X00IP</b> (color)	
<b>VS XC700M12X00IP</b>	1280 × 960 px (1/3")
<b>VS XC700C12X00IP</b> (color)	
<b>VS XC700M20X00IP</b>	1600 × 1200 px (1/1.8")

functions (*VS XC700CxxX00IP only)
<b>Part location:</b> Part location on contours, Part location on edges, Part location on circle, Part location on text line
<b>Geometry:</b> Distance, Circle, Angle, Count edges, Point position, Edge characteristics
<b>Feature comparison:</b> Count contour points, Contour comparison, Area size, Count areas, Pattern comparison, Find object positions, Brightness, Contrast, Color identification*, Color positioning*

order reference	resolution (sensor)
<b>VS XC800M03X00IP</b>	640 × 480 px (1/4")
<b>VS XC800C03X00IP</b> (color)	
<b>VS XC800M12X00IP</b>	1280 × 960 px (1/3")
<b>VS XC800C12X00IP</b> (color)	
<b>VS XC800M20X00IP</b>	1600 × 1200 px (1/1.8")

functions (*VS XC800CxxX00IP only)
<b>Part location:</b> Part location on contours, Part location on edges, Part location on circle, Part location on text line
<b>Geometry:</b> Distance, Circle, Angle, Count edges, Point position, Edge characteristics
<b>Feature comparison:</b> Count contour points, Contour comparison, Area size, Count areas, Pattern comparison, Find object positions, Brightness, Contrast, Color identification*, Color positioning*
<b>Identification:</b> Barcode, Matrix code, Text



**focal distance = 10 / 16 mm**



- Image-based quality control with one single sensor
- Easy configuration within a few minutes
- Interfaces: PROFINET/EtherNet/IP™ via gateway, digital I/Os

**general data**

sensor	CMOS
resolution (format)	752 × 480 px (1/3")
type	monochrome
illumination	white, infrared
<b>speed</b>	max. inspections/s (monochrome)
High-resolution mode:	50
High-speed mode:	100
objectiv (focal distance)	10 mm 16 mm
object distance min.	50 mm 70 mm
number of jobs (products)	up to 255 on the device
features per job	32
inputs	8 ... 30 V
outputs	PNP 100 mA
digital input	Trigger, Job selection, External teach-in, Encoders (CH-A, CH-B) 500 kHz
digital output	Pass / Fail 1-5, Flash Sync, Alarm, Camera Ready, Output Enable
<b>communication</b>	
initial setup:	Ethernet (10 BASE-T / 100 BASE-TX)
process interface:	TCP/UDP (Ethernet), PROFINET/EtherNet/IP™ (gateway)

**electrical data**

voltage supply range +Vs	= 18 ... 30 V
power consumption max.	typ. 8 W (I <sub>max</sub> = 1 A at 24 V)

**mechanical data**

width / diameter	53 mm
height / length	107,5 mm
depth	38 mm
type	rectangular
housing material	stainless steel 1.4404 and PMMA
weight	700 g

**ambient conditions**

operating temperature	+5 ... +50 °C @ measurement point
storage temperature	-20 ... +70 °C
humidity	0 ... 90 % (non-condensing)
protection class	IP 69K
vibration load	IEC 60068-2-6, IEC 60068-2-64
mechanical shock resistance	EN 60068-2-27

**accessories**

<i>VeriSens</i> <sup>®</sup> mounting adapter	11177010
<i>VeriSens</i> <sup>®</sup> Application Suite CD	included in delivery
additional information	see accessories

**dimension drawing**

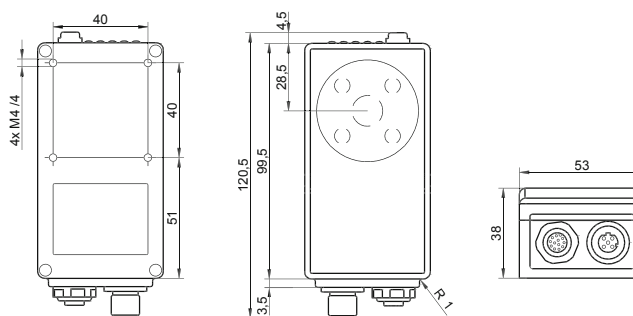

**Electrical connection Type M12 / 12-pin, A-coded**

- 1: Power +18...30 V DC
- 2: Ground
- 3: IN1 (Trigger)
- 4: OUT1
- 5: IN2
- 6: OUT2
- 7: OUT3
- 8: IN3
- 9: OUT4
- 10: IN4
- 11: IN5
- 12: OUT5

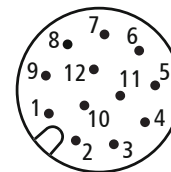

**Electrical connection Type M12 / 4-pin**

- 1: TD+
- 2: RD+
- 3: TD-
- 4: RD-

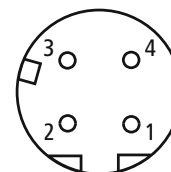

**connectors**

ESG 34JP0200G	12-pin	2 m straight (shielded)
ESG 34JP0500G	12-pin	5 m straight (shielded)
KSG 34A/ KSG45AP0200G/E	4-pin	2 m straight (shielded)
KSG 34A/ KSG45AP0500G/E	4-pin	5 m straight (shielded)

additional cable connectors and field wireable connectors, see accessories

order reference	lens	illumination
VS XF105M03W10EP	10 mm	white
VS XF105M03I10EP	10 mm	infrared
VS XF105M03I16EP	16 mm	infrared

**functions**

**Part location:** Part location on contours, Part location on edges, Part location on circle, Part location on text line

**Geometry:** Distance, Circle, Angle, Count edges, Point position, Edge characteristics

**Feature comparison:** Count contour points, Contour comparison, Area size, Count areas, Pattern comparison, Find object positions, Brightness, Contrast

order reference	lens	illumination
VS XF205M03W10EP	10 mm	white
VS XF205M03W16EP	16 mm	white
VS XF205M03I10EP	10 mm	infrared

**functions**

**Part location:** Part location on contours, Part location on edges, Part location on circle, Part location on text line

**Geometry:** Distance, Circle, Angle, Count edges, Point position, Edge characteristics

**Feature comparison:** Count contour points, Contour comparison, Area size, Count areas, Pattern comparison, Find object positions, Brightness, Contrast

**Identification:** Barcode, Matrix code, Text





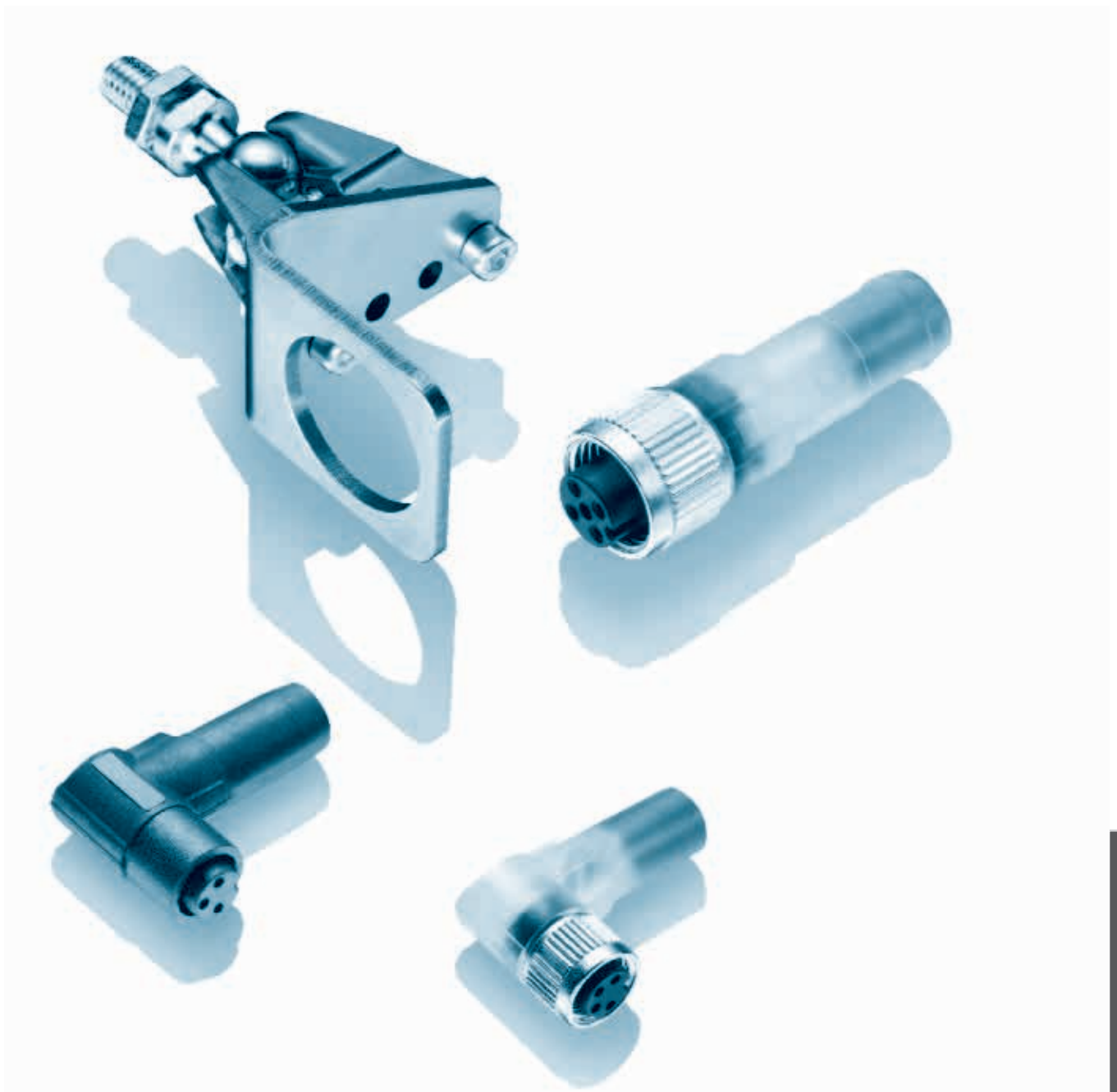

## Accessories

Connectors and mating connectors	Page 736
Connectors / Pin assignment	Page 741
Reflectors	Page 742
Divers	Page 748
Mountings	Page 750
Mounting kits <i>Sensofix</i>	Page 754
Hygienic and washdown	Page 756
Fiber optics	Page 758

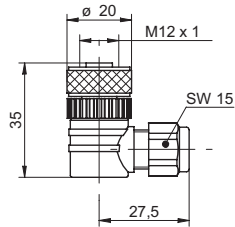
**ES 14** - Cable socket M12 angular, not pre-assembled**order reference**

ES 14A PG7	Connector M12, 4 pin, angular
ES 14C PG7	Connector M12, 5 pin, angular

- Connector female unshielded
- Connector only, no cable supplied
- 4 and 5 pin versions

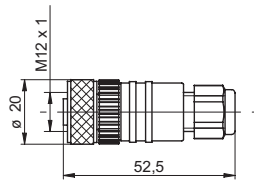
**ES 18** - Cable socket M12 straight, not pre-assembled**order reference**

ES 18A PG7	Connector M12, 4 pin, straight
ES 18C PG7	Connector M12, 5 pin, straight

- Connector female unshielded
- Connector only, no cable supplied
- 4 and 5 pin versions

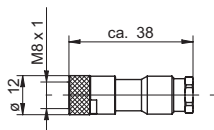
**ES 21** - Cable socket M8 straight, not pre-assembled**order reference**

ES 21	Connector M8, 3 pin, straight
ES 21A	Connector M8, 4 pin, straight

- Connector female unshielded
- Connector only, no cable supplied
- 3 and 4 pin version

**ES 22** - Cable socket M8 angular, not pre-assembled

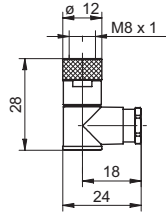

**order reference**

ES 22	Connector M8, 3 pin, angular
ES 22A	Connector M8, 4 pin, angular

- Connector female unshielded
- Connector only, no cable supplied
- 3 and 4 pin versions

**ESG 32** - Connector M8 straight

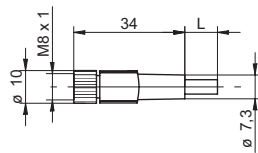

**order reference**

ESG 32AH0200	Connector M8, 4 pin, straight, 2 m
ESG 32AH0500	Connector M8, 4 pin, straight, 5 m
ESG 32AH1000	Connector M8, 4 pin, straight, 10 m
ESG 32SH0200	Connector M8, 3 pin, straight, 2 m
ESG 32SH0500	Connector M8, 3 pin, straight, 5 m
ESG 32SH1000	Connector M8, 3 pin, straight, 10 m

- Connector unshielded
- 3 and 4 pin versions
- Cable coating PUR
- Halogen-free
- Suitable for flexible cable carriers
- UL listed, number E315836
- Meet EN 60079-25 requirements for intrinsically safe ATEX applications

**ESG 32G** - Connector M8 straight, shielded

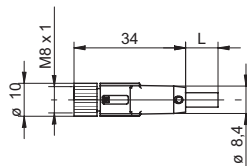

**order reference**

ESG 32AH0200G	Connector M8, 4 pin, straight, 2 m, shielded
ESG 32AH0500G	Connector M8, 4 pin, straight, 5 m, shielded
ESG 32AH1000G	Connector M8, 4 pin, straight, 10 m, shielded
ESG 32SH0500G	Connector M8, 3 pin, straight, 5 m, shielded
ESG 32SH1000G/T	Connector M8, 3 pin, straight, 10 m, shielded

- Connector shielded, screen connected with cap nut
- 3 and 4 pin versions
- Cable coating PUR
- Halogen-free
- Suitable for flexible cable carriers
- UL listed, number E315836

**ESW 31 - Connector M8 angular**

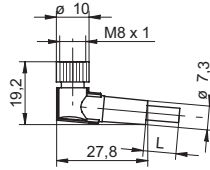

order reference	
ESW 31AH0200	Connector M8, 4 pin, angular, 2 m
ESW 31AH0500	Connector M8, 4 pin, angular, 5 m
ESW 31AH1000	Connector M8, 4 pin, angular, 10 m
ESW 31SH0200	Connector M8, 3 pin, angular, 2 m
ESW 31SH0500	Connector M8, 3 pin, angular, 5 m
ESW 31SH1000	Connector M8, 3 pin, angular, 10 m

- Connector unshielded
- 3 and 4 pin versions
- Cable coating PUR
- Halogen-free
- Suitable for flexible cable carriers
- UL listed, number E315836
- Meet EN 60079-25 requirements for intrinsically safe ATEX applications

**ESW 31G - Connector M8 angular, shielded**

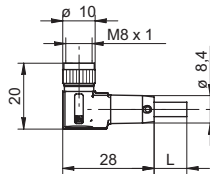

order reference	
ESW 31AH0200G	Connector M8, 4 pin, angular, 2 m, shielded
ESW 31AH0500G	Connector M8, 4 pin, angular, 5 m, shielded
ESW 31AH1000G	Connector M8, 4 pin, angular, 10 m, shielded
ESW 31SH0200G	Connector M8, 3 pin, angular, 2 m, shielded
ESW 31SH0500G	Connector M8, 3 pin, angular, 5 m, shielded

- Connector shielded, screen connected with cap nut
- 3 and 4 pin versions
- Cable coating PUR
- Halogen-free
- Suitable for flexible cable carriers
- UL listed, number E315836

**ESG 34 - Connector M12 straight**

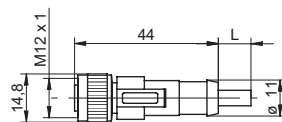

order reference	
ESG 34AH0200	Connector M12, 4 pin, straight, 2 m
ESG 34AH0500	Connector M12, 4 pin, straight, 5 m
ESG 34AH1000	Connector M12, 4 pin, straight, 10 m
ESG 34CH0200	Connector M12, 5 pin, straight, 2 m
ESG 34CH0500	Connector M12, 5 pin, straight, 5 m
ESG 34SH0200	Connector M12, 3 pin, straight, 2 m
ESG 34SH0500	Connector M12, 3 pin, straight, 5 m
ESG 34SH1000	Connector M12, 3 pin, straight, 10 m

- Connector unshielded
- 3, 4 and 5 pin versions
- Cable coating PUR
- Halogen-free
- Suitable for flexible cable carriers
- UL listed, number E315836

**ESG 34G** - Connector M12 straight, shielded

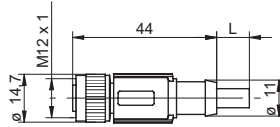

- Connector shielded, screen connected with cap nut
- 4, 5 and 8 pin versions
- Cable coating PUR
- Halogen-free
- Suitable for flexible cable carriers
- UL listed, number E315836

order reference	
ESG 34AH0200G	Connector M12, 4 pin, straight, 2 m, shielded
ESG 34AH0500G	Connector M12, 4 pin, straight, 5 m, shielded
ESG 34AH1000G	Connector M12, 4 pin, straight, 10 m, shielded
ESG 34CH0200G	Connector M12, 5 pin, straight, 2 m, shielded
ESG 34CH0500G	Connector M12, 5 pin, straight, 5 m, shielded
ESG 34CH1000G	Connector M12, 5 pin, straight, 10 m, shielded
ESG 34FH0200G	Connector M12, 8 pin, straight, 2 m, shielded
ESG 34FH0500G	Connector M12, 8 pin, straight, 5 m, shielded
ESG 34FH1000G	Connector M12, 8 pin, straight, 10 m, shielded

**ESG 34F** - Connector M12 straight, PVC/V4A

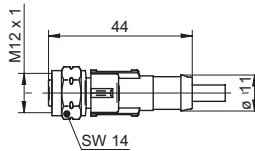

- Connector unshielded
- 4 pin version
- Cable coating PVC
- Cap nut material in stainless steel V4A
- Ecolab certified and FDA conform
- UL listed, number E315836

order reference	
ESG 34AF0500	Connector M12, 4 pin, straight, 5 m, V4A-PVC
ESG 34AF1000	Connector M12, 4 pin, straight, 10 m, V4A-PVC

**ESW 33** - Connector M12 angular

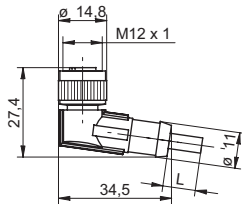

- Connector unshielded
- 3, 4 and 5 pin versions
- Cable coating PUR
- Halogen-free
- Suitable for flexible cable carriers
- UL listed, number E315836

order reference	
ESW 33AH0200	Connector M12, 4 pin, angular, 2 m
ESW 33AH0500	Connector M12, 4 pin, angular, 5 m
ESW 33AH1000	Connector M12, 4 pin, angular, 10 m
ESW 33CH0200	Connector M12, 5 pin, angular, 2 m
ESW 33CH0500	Connector M12, 5 pin, angular, 5 m
ESW 33SH0200	Connector M12, 3 pin, angular, 2 m
ESW 33SH0500	Connector M12, 3 pin, angular, 5 m
ESW 33SH1000	Connector M12, 3 pin, angular, 10 m

**ESW 33G** - Connector M12 angular, shielded

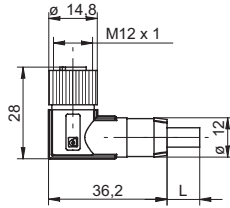

order reference	
ESW 33AH0200G	Connector M12, 4 pin, angular, 2 m, shielded
ESW 33AH0500G	Connector M12, 4 pin, angular, 5 m, shielded
ESW 33AH1000G	Connector M12, 4 pin, angular, 10 m, shielded
ESW 33CH0500G	Connector M12, 5 pin, angular, 5 m, shielded
ESW 33FH0200G	Connector M12, 8 pin, angular, 2 m, shielded
ESW 33FH0500G	Connector M12, 8 pin, angular, 5 m, shielded
ESW 33FH1000G	Connector M12, 8 pin, angular, 10 m, shielded

- Connector shielded, screen connected with cap nut
- 4, 5 and 8 pin versions
- Cable coating PUR
- Halogen-free
- Suitable for flexible cable carriers
- UL listed, number E315836

**ESW 33F** - Connector M12 angular, PVC/V4A

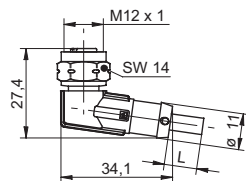

order reference	
ESW 33AF0200	Connector M12, 4 pin, angular, 2 m, V4A-PVC
ESW 33AF0500	Connector M12, 4 pin, angular, 5 m, V4A-PVC
ESW 33AF1000	Connector M12, 4 pin, angular, 10 m, V4A-PVC
ESW 33AF2500	Connector M12, 4 pin, angular, 25 m, V4A-PVC

- Connector unshielded
- 4 pin version
- Cable coating PVC
- Cap nut material in stainless steel V4A
- Ecolab certified and FDA conform
- UL listed, number E315836

**3 pin**

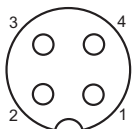

- 1 = BN
- 2 = n.c.
- 3 = BU
- 4 = BK

**ESG 34**  
**ESW 33**

**3 pin**

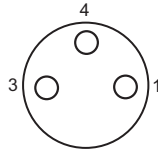

- 1 = BN
- 3 = BU
- 4 = BK

**ES 21**  
**ES 22**  
**ESG 32**  
**ESG 32G**  
**ESW 31**  
**ESW 31G**

**4 pin**

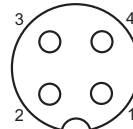

- 1 = BN (+Vs)
- 2 = WH (output)
- 3 = BU (0V)
- 4 = BK (output)

**ES 14**  
**ES 18**  
**ESG 34**  
**ESG 34F**  
**ESG 34G**  
**ESW 33**  
**ESW 33F**  
**ESW 33G**

**4 pin**

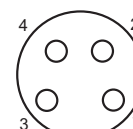

- 1 = BN
- 2 = WH
- 3 = BU
- 4 = BK

**ES 21A**  
**ES 22A**  
**ESG 32**  
**ESG 32G**  
**ESW 31**  
**ESW 31G**

**5 pin**

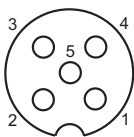

- 1 = BN
- 2 = WH
- 3 = BU
- 4 = BK
- 5 = GY

**ES 14C**  
**ES 18C**  
**ESG 34**  
**ESG 34G**  
**ESW 33**  
**ESW 33G**

**8 pin**

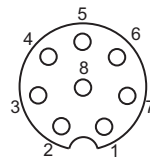

- 1 = WH
- 2 = BN
- 3 = GN
- 4 = YE
- 5 = GY
- 6 = PK
- 7 = BU
- 8 = RD

**ESG 34G**  
**ESW 33G**

## FTAR 013

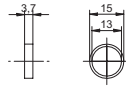

- Fastening method self-adhesive
- Micro structure
- For Retro-reflective sensors

**order reference**

FTAR 013A000 Reflector round Ø 15 mm

## FTAR 014

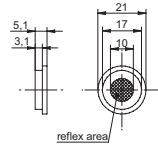

- Fastening method self-adhesive
- For Retro-reflective sensors

**order reference**

FTAR 014A000 Reflector round Ø 21 mm

## FTAR 020

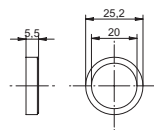
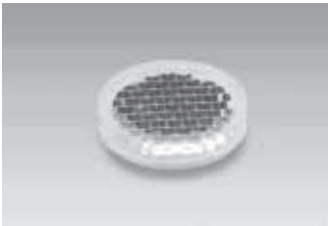

- Fastening method self-adhesive
- Micro structure
- For Retro-reflective sensors

**order reference**

FTAR 020A000 Reflector round Ø 25,2 mm

## FTAR 038

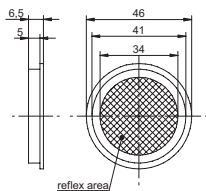

- Fastening method self-adhesive
- For Retro-reflective sensors

**order reference**

FTAR 038A000 Reflector round Ø 46 mm

## FTDR 010A

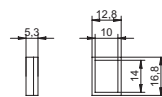

- Fastening method self-adhesive
- For Retro-reflective sensors

**order reference**

FTDR010A014 Reflector rectangular 16,8 x 12,8 mm

## FTDR 010D

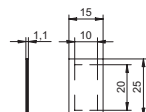

- Fastening method self-adhesive
- For laser light sensors

**order reference**

FTDR 010D020 Reflector rectangular 15 x 25 mm



**FTDR 015**

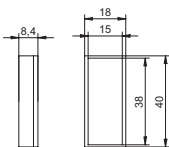

- Fastening method self-adhesive
- For Retro-reflective sensors

**order reference**  
 FTDR 015A038 Reflector rectangular 40 x 18 mm

**FTDR 017**

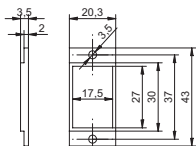

- Fastening method screw mounting
- Micro structure
- For Retro-reflective sensors

**order reference**  
 FTDR 017A027 Reflector rectangular 43 x 20,3 mm

**FTDR 029**

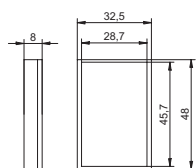

- Fastening method self-adhesive
- For Retro-reflective sensors

**order reference**  
 FTDR 029A046 Reflector rectangular 48 x 32,5 mm

**FTDR 047**

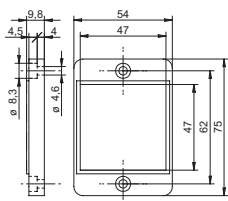
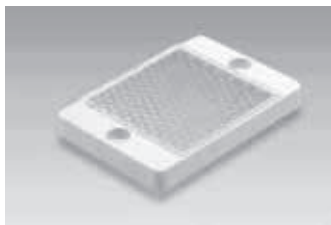

- Fastening method screw mounting
- For Retro-reflective sensors

**order reference**  
 FTDR 047A048 Reflector rectangular 75 x 54 mm

**FTDR 051**

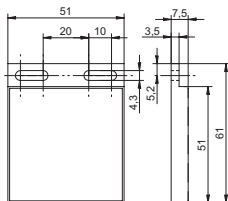
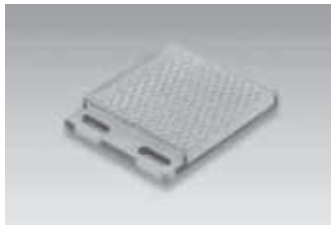

- Detergent resistant reflector
- Ecolab approved
- For Retro-reflective sensors

**order reference**  
 FTDR 051E051 Ecolab approved reflector

**FTDR 050**

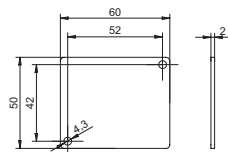
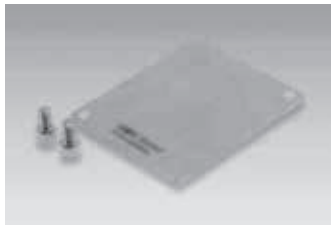

- Stainless steel reflector for SmartReflect in washdown design
- Material: Stainless steel V4A

**order reference**  
 FTDR 050R060 Stainless steel reflector for SmartReflect in washdown design

**FTDR 084**

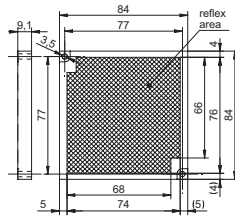
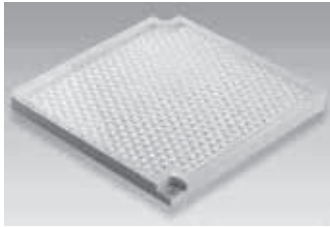

- Fastening method screw mounting
- For Retro-reflective sensors

**order reference**

FTDR 084A084 Reflector rectangular 84 x 84 mm

**FTDR 017W**

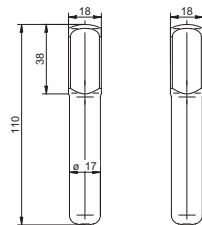

- Stainless steel reflector for SmartReflect in hygiene design
- EHEDG-certified

Accessorie: "mounting for sensors in hygienic design Ø17", order reference HI17-1H

**order reference**

FTDR 017W035 Stainless steel reflector for SmartReflect in hygiene design

**FTDF 020F**



- Fastening method self-adhesive
- For laser light sensors

**order reference**

FTDF 020F020 Reflective tape rectangular 20 x 20 mm

**FTDR 005**

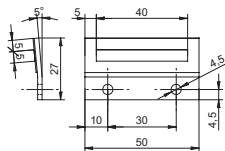

- Fastening method screw mounting
- For pocket-size edge sensor *PosCon*

**order reference**

FTDR 005I040 Reflector rectangular 50 x 27 mm

**FTDR 020**

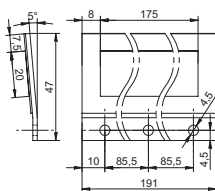

- Fastening method screw mounting
- For pocket-size edge sensor *PosCon*

**order reference**

FTDR 020I175 Reflector rectangular 191 x 47 mm

**FTDR 035**

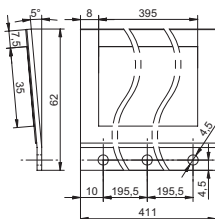

- Fastening method screw mounting
- For pocket-size edge sensor *PosCon*

**order reference**

FTDR 035I395 Reflector rectangular 411 x 62 mm

**FTDF 005**

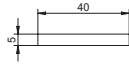

- Fastening method self-adhesive
- For pocket-size edge sensor *PosCon*

**order reference**

FTDF 005I040 Reflective tape rectangular 5 x 40 mm

**FTDF 020**

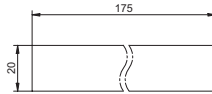
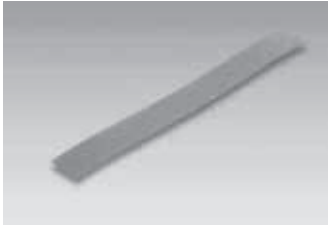

- Fastening method self-adhesive
- For pocket-size edge sensor *PosCon*

**order reference**

FTDF 020I175 Reflective tape rectangular 20 x 175 mm

**FTDF 035I**

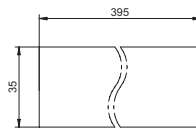

- Fastening method self-adhesive
- For pocket-size edge sensor *PosCon*

**order reference**

FTDF 035I395 Reflective tape rectangular 35 x 395 mm

**FTDF 012**

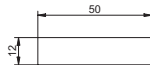

- Fastening method self-adhesive
- For pocket-size edge sensor *ParCon*

**order reference**

FTDF 012M050 Reflective tape rectangular 12 x 50 mm

**FTDF 035**

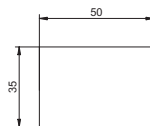
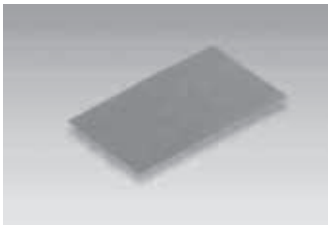

- Fastening method self-adhesive
- For pocket-size edge sensor *ParCon*

**order reference**

FTDF 035M050 Reflective tape rectangular 35 x 50 mm

**FTDF 050**

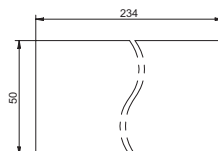

- Fastening method self-adhesive
- For pocket-size edge sensor *ParCon*

**order reference**

FTDF 050M234 Reflective tape rectangular 50 x 234 mm

FTDR 008/01

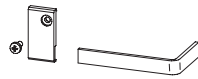
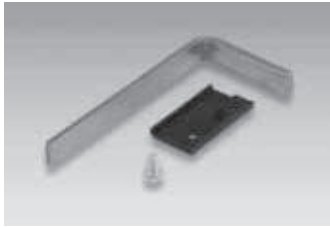

- Bracket with reflective tape
- For pocket-size edge sensor *ParCon*

**order reference**

FTDR 008M030/01 Reflector bracket high

FTDR 008/21

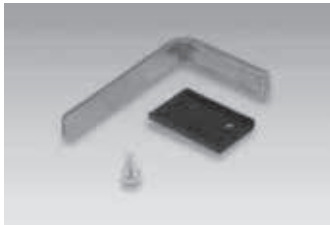

- Bracket with reflective tape
- For pocket-size edge sensor *ParCon*

**order reference**

FTDR 008M030/21 Reflector bracket lateral

Z-FTDF 005

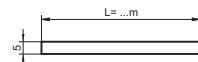

- Fastening method self-adhesive
- For pocket-size edge sensor *PosCon*

**order reference**

Z-FTDF 005I0100 Reflective tape rectangular 5 x 100 mm

Z-FTDF 005I0500 Reflective tape rectangular 5 x 500 mm

Z-FTDF 005I1000 Reflective tape rectangular 5 x 1000 mm

Z-FTDF 005I1600 Reflective tape rectangular 5 x 1600 mm

Z-FTDF 020

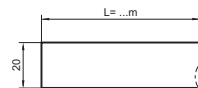

- Fastening method self-adhesive
- For pocket-size edge sensor *PosCon*

**order reference**

Z-FTDF 020I0100 Reflective tape rectangular 20 x 100 mm

Z-FTDF 020I0180 Reflective tape rectangular 20 x 180 mm

Z-FTDF 020I0500 Reflective tape rectangular 20 x 500 mm

Z-FTDF 020I1000 Reflective tape rectangular 20 x 1000 mm

Z-FTDF 020I1600 Reflective tape rectangular 20 x 1600 mm

Z-FTDF 035

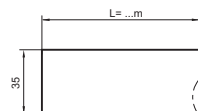

- Fastening method self-adhesive
- For pocket-size edge sensor *PosCon*

**order reference**

Z-FTDF 035I0100 Reflective tape rectangular 35 x 100 mm

Z-FTDF 035I0500 Reflective tape rectangular 35 x 500 mm

Z-FTDF 035I1000 Reflective tape rectangular 35 x 1000 mm

Z-FTDF 035I1600 Reflective tape rectangular 35 x 1600 mm

Z-FTDF 050

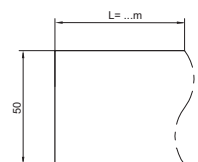

- Fastening method self-adhesive
- For pocket-size edge sensor *PosCon*

**order reference**

Z-FTDF 050I0100 Reflective tape rectangular 50 x 100 mm

Z-FTDF 050I0500 Reflective tape rectangular 50 x 500 mm

Z-FTDF 050I1000 Reflective tape rectangular 50 x 1000 mm

Z-FTDF 050I1600 Reflective tape rectangular 50 x 1600 mm

**Z-FTDF 610**

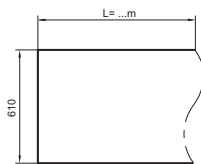

- Fastening method self-adhesive
- For pocket-size edge sensor *PosCon*

order reference	
Z-FTDF 610I0100	Reflective tape rectangular 610 x 100 mm
Z-FTDF 610I0500	Reflective tape rectangular 610 x 500 mm
Z-FTDF 610I1000	Reflective tape rectangular 610 x 1000 mm
Z-FTDF 610I1600	Reflective tape rectangular 610 x 1600 mm

**Z-FTDF 050K**

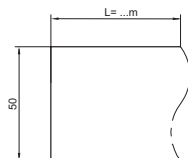
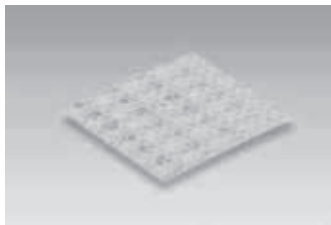

- Fastening method self-adhesive
- For Retro-reflective sensors

order reference	
Z-FTDF 050K0100	Reflective type rectangular 50 x 100 mm
Z-FTDF 050K0500	Reflective type rectangular 50 x 500 mm
Z-FTDF 050K1000	Reflective type rectangular 50 x 1000 mm
Z-FTDF 050K9999	Reflective type rectangular 50 x 10000 mm

## Slot aperture stickers series 14

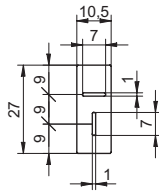

- Material: Polyester foil
- Contents: 2 pieces
- self-adhesive

For use with FSDK 14 / FEDK 14

**order reference**

10144075 Slot aperture stickers series 14

## Protector cap for OxDM 20

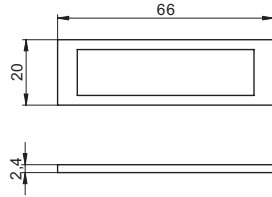

- Material: PMMA
- Self-adhesive

**order reference**

10156878 Protector cap OxDM 20

## Glass cover for sensors series 18

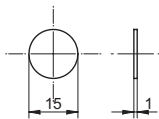

- Material: glass

For use with cap nut series 18

**order reference**

10103068 Glass cover series 18

## Glass cover for sensors series 30

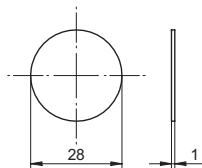

- Material: glass

For use with cap nut series 30

**order reference**

10103226 Glass cover series 30

## Doubling lens for sensors serie 18

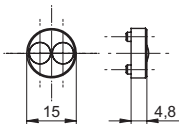

- Material: PBTP / glass
- For double the sensing distance FZAM 18

For use with FZAM 18

**order reference**

10107250 Doubling lens series 18 FZAM 18

## Doubling lens for sensors serie 30

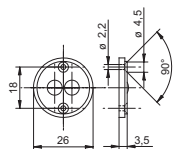

- Material: PC / glass
- For double the sensing distance FZAM 30

For use with FZAM 30

**order reference**

10107408 Doubling lens series 30 FZAM 30

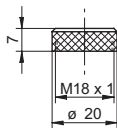
**Cap nut for photoelectric sensors series 18**

- Material: Nickel-plated brass

For use with FZAM 18 (with glass cover)

**order reference**

10103067 Cap nut glass cover for sensors series 18

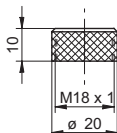
**Cap nut for photoelectric sensors series 18**

- Material: Nickel-plated brass

For use with FZAM 18 (with doubling lens)

**order reference**

10115913 Cap nut glass cover and doubling lens for sensors series 18

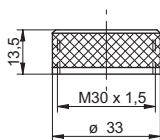
**Cap nut for photoelectric sensors series 30**

- Material: Nickel-plated brass

For use with FZAM 30 (with glass cover)

**order reference**

10102801 Cap nut glass cover for sensors series 30





**Mounting bracket for sensors series 10**

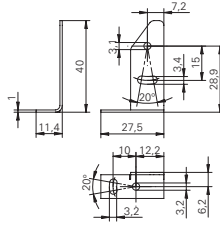

- Material: Steel

For use with UxDK 10, FxDK 10, OxDK 10

**order reference**

10118798 Mounting bracket series 10

**Mounting bracket for sensors series 10 (L design)**

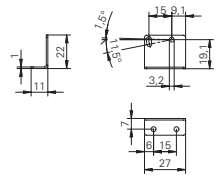

- Material: Steel

For use with UxDK 10, FxDK 10, OxDK 10

**order reference**

10113792 Mounting bracket series 10 (L design)

**Mounting bracket for sensors series 10 (U design)**

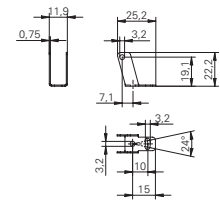

- Material: Steel

For use with UxDK 10, FxDK 10, OxDK 10 (only cabel versions)

**order reference**

10114501 Mounting bracket series 10 (U design)

**Mounting bracket for sensors series 12**

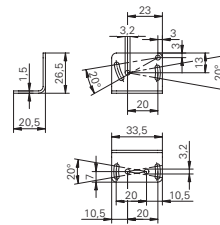
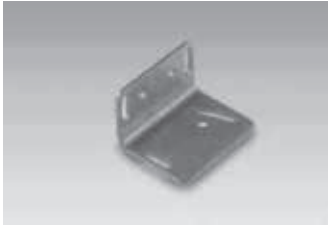

- Material: Steel

For use with FxDM 12, OxDM 12

**order reference**

10113873 Mounting bracket series 12 (L design)

**Mounting bracket for sensors series 13**

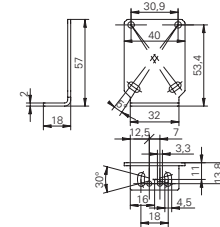
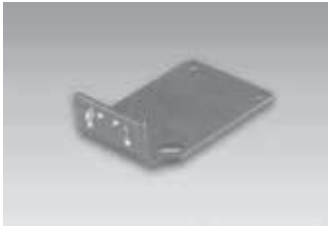

- Material: Steel

For use with OxDM 13

**order reference**

10161695 Mounting bracket for sensors series 13 (L design)

**Mounting bracket for sensors series 14**

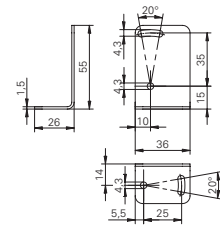

- Material: Steel

For use with FxDK 14, OxDK 14

**order reference**

10134964 Mounting bracket series 14 (L design)



Mounting bracket for Logipal/PosCon

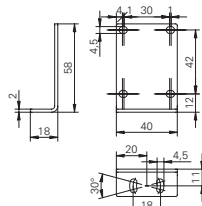
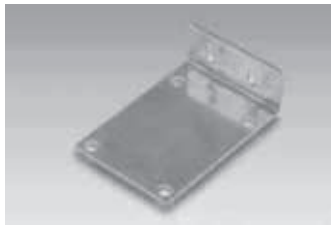

- Material: Steel

For use with ZADM 023, FKDM 22

order reference

10126220 Mounting bracket series 22 L design

Mounting bracket for sensors series 26

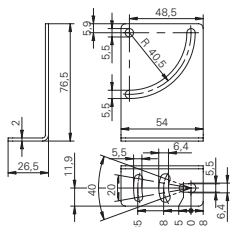
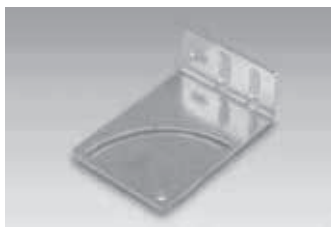

- Material: Steel

For use with FxDK 26

order reference

10112477 Mounting bracket series 26 (L design)

Mounting bracket for Verisens

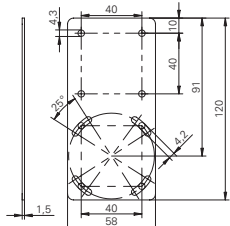
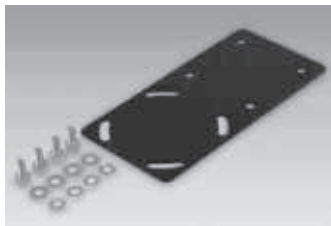

- Material: Steel

order reference

10159905 Mounting bracket for Verisens

Mounting bracket for Verisens (L design)

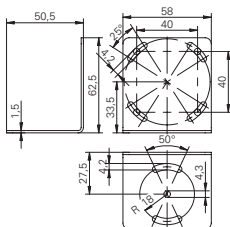

- Material: Steel

order reference

10159906 Mounting bracket for Verisens (L design)





**ESG 34F** - Connector M12 straight, PVC/V4A

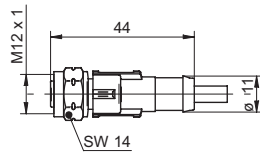

order reference	
ESG 34AF0500	Connector M12, 4 pin, straight, 5 m, V4A-PVC
ESG 34AF1000	Connector M12, 4 pin, straight, 10 m, V4A-PVC

- Connector unshielded
- 4 pin version
- Cable coating PVC
- Cap nut material in stainless steel V4A
- Ecolab certified and FDA conform
- UL listed, number E315836

**ESW 33F** - Connector M12 angular, PVC/V4A

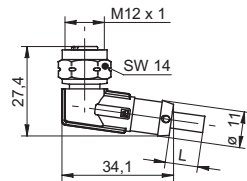

order reference	
ESW 33AF0200	Connector M12, 4 pin, angular, 2 m, V4A-PVC
ESW 33AF0500	Connector M12, 4 pin, angular, 5 m, V4A-PVC
ESW 33AF1000	Connector M12, 4 pin, angular, 10 m, V4A-PVC
ESW 33AF2500	Connector M12, 4 pin, angular, 25 m, V4A-PVC

- Connector unshielded
- 4 pin version
- Cable coating PVC
- Cap nut material in stainless steel V4A
- Ecolab certified and FDA conform
- UL listed, number E315836

**Mounting HI17-1H for sensors in hygienic design Ø 17 mm**

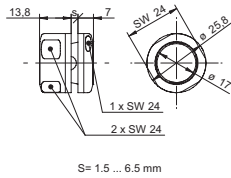

- Material: Stainless steel V4A
- EHEDG-certified

For use with inductive sensors 17 mm and photoelectric sensors in hygienic design

**order reference**  
HI17-1H Mounting for sensors in hygienic design Ø 17 mm

**Mounting bracket for washdown sensors series 14**

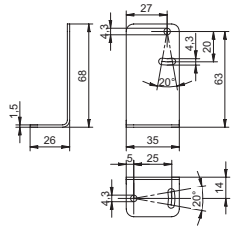

- Material: Stainless Steel
- For use with FxDR 14

**order reference**  
11046278 Mounting bracket series 14 washdown

**Sensofix-Mounting kit for washdown sensors series 14**

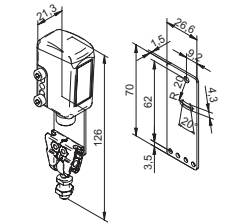

- Clamps made of stainless steel
- Ball pivots made of galvanized steel
- Mounting panel made of stainless steel

For use with FxDR 14

**order reference**  
11046279 Sensofix series 14 washdown

**FTDR 051**

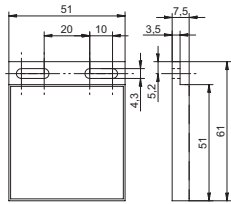
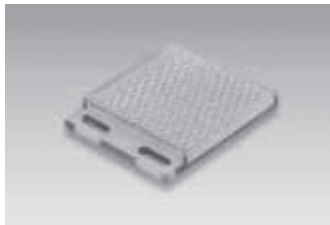

- Detergent resistant reflector
- Ecolab approved
- For Retro-reflective sensors

**order reference**  
FTDR 051E051 Ecolab approved reflector

**FTDR 050**

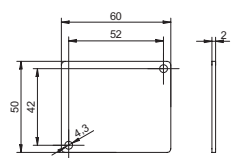

- Stainless steel reflector for SmartReflect in washdown design
- Material: Stainless steel V4A

**order reference**  
FTDR 050R060 Stainless steel reflector for SmartReflect in washdown design

**FTDR 017W**

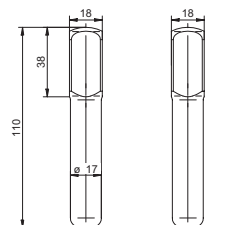

- Stainless steel reflector for SmartReflect in hygiene design
- EHEDG-certified

Accessory: "mounting for sensors in hygienic design Ø17", order reference HI17-1H

**order reference**  
FTDR 017W035 Stainless steel reflector for SmartReflect in hygiene design

**Doubling lens M2,6**

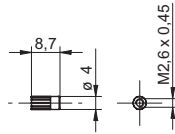

- Increases the actual range  $S_b$  by a factor of 6
- Contents: 2 pieces

For fiber optic: FSE 200C1Y00 / FSE 200C2Y00, FSA 200C1Y00, FSG 200C1Y00, FSE 200E1Y00

**order reference**

10134541 Doubling lens increases the actual range (paires)

**Doubling lens M2,6 (side view version)**

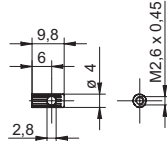

- Side view version
- Increases the actual range  $S_b$  by a factor of 6
- Contents: 2 pieces

For fiber optic: FSE 200C1Y00 / FSE 200C2Y00, FSA 200C1Y00, FSG 200C1Y00, FSE 200E1Y00

**order reference**

10134540 Doubling lens increases the actual range (paires)

**Doubling lens M3**

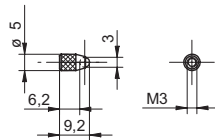

- Material: brass / glass
- Increases the actual range  $S_b$  by a factor of 6
- Contents: 2 pieces

For fiber optic: FSE 200C1004

**order reference**

10119910 Doubling lens M3 increases the actual range (paires)

**Doubling lens M4**

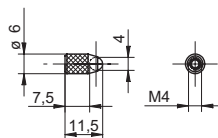

- Material: brass / glass
- Increases the actual range  $S_b$  by a factor of 6
- Contents: 2 pieces

For fiber optic: FSE 200C1004

**order reference**

10119909 Doubling lens M4 increases the actual range (paires)

**Focusing lens M3  $\varnothing$  0,1 mm**

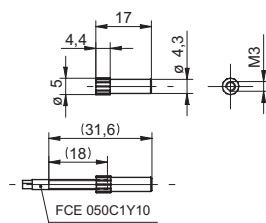

- Light spot  $\varnothing$  0,1 mm at a distance of 4,6 mm

For fiber optic: FCE 050C1Y10 (empfohlen), FCE 200D1Y00, FCE 200D1Y01, FCE 200E1Y00

**order reference**

10134544 Focusing lens M3  $\varnothing$  0,1 mm

**Focusing lens M3  $\varnothing$  0,4 mm**

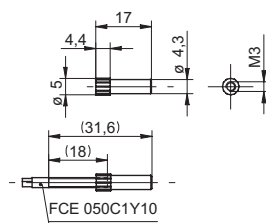

- Light spot  $\varnothing$  0,4 mm at a distance of 7 mm

For fiber optic: FCE 050C1Y10 (empfohlen), FCE 200D1Y00, FCE 200D1Y01, FCE 200E1Y00

**order reference**

10134543 Focusing lens M3  $\varnothing$  0,4 mm



**Focusing lens M3 ø 2 mm**

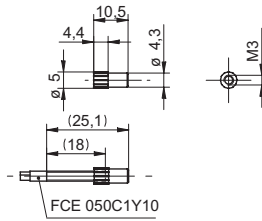

- Light spot Ø 2 mm at a distance of 19 mm

For fiber optic: FCE 050C1Y10 (empfohlen), FCE 200D1Y00, FCE 200D1Y01, FCE 200E1Y00

**order reference**

10134542 Focusing lens M3 ø 2 mm

**Mounting bracket 1,1 mm**

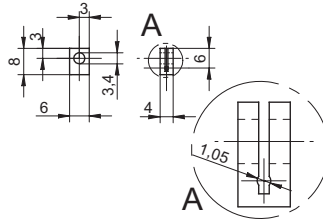

- Material: Aluminum

For fiber optic through beam type with 1,1 mm sheath diameters

**order reference**

10119912 Mounting bracket Ø 1,1 mm

**Mounting bracket 2,2 mm**

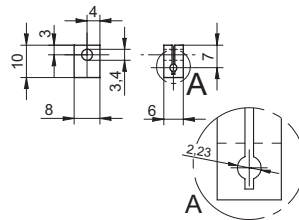

- Material: Aluminum

For fiber optic through beam type with 2,2 mm sheath diameters

**order reference**

10119911 Mounting bracket Ø 2,2 mm

**Mounting bracket for fiber optic sensors series 12**

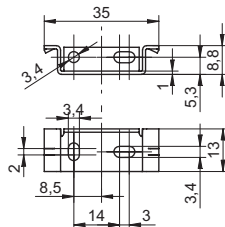

- Material: Steel
- Delivered with every plastic fiber optic sensor series 12

For use with FVDK 12

**order reference**

10145702 Mounting bracket for fiber optic sensors series 12

**Mounting bracket for fiber optic sensors series 22**

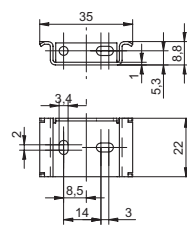

- Material: Steel
- Delivered with every plastic fiber optic sensor series 22

For use with FVDK 22

**order reference**

10125534 Mounting bracket for fiber optic sensors series 22

**Mounting bracket for fiber optic sensors series 60**

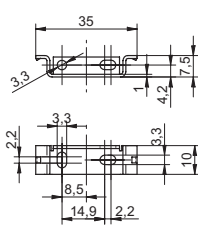

- Material: Steel
- Must be ordered separately for series 66 and series 67 sensors

For use with FVDK 66, FVDK 67

**order reference**

10159806 Mounting bracket for fiber optic sensors series 60, 66, 67, 80

Reduction tube

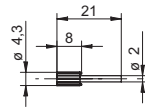

- Set of 2
- Delivered with every 1 mm diameter plastic fiber optic

order reference

10140260 Reduction tube

Fiber optic cable extension



- Reduction in range due to fiber optic extension: 2 m = approx. 25%
- Reduction in range due to fiber optic extension: 5 m = approx. 60%

order reference

10145523 Fiber optic cable extension 5 m hochflexibel

10156738 Fiber optic cable extension 2 m

10158142 Fiber optic cable extension 5 m

Cutting tool



- Delivered with every plastic fiber optic

order reference

10114652 Cutting tool for plastic fiber optics

Adapter for glass fiber optic sensors 30

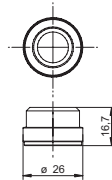

- Material: POM
- For use with fiber optic amplifier FZAM 30

order reference

10102757 Adapter series 30

10106042 Adapter series 30 (angeled fiber optics)

Adjusting plate for glass fiber optic sensors 18 (replace)

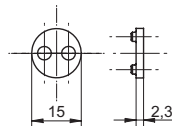

- Material: PETP
- For re-orders when lost
- Enclosed with every glass fiber optic of type A

order reference

10101958 Adjusting plate series 18

Cap nut for glass fiber optic sensors 15 (replace)

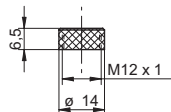

- Material: Nickel-plated brass
- For re-orders when lost
- Enclosed with every glass fiber optic of type B

For use with FVDM 15

order reference

10103230 Cap nut (replace) for fiber optics series 15

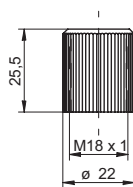
**Cap nut for glass fiber optic sensors 18 (replace)**

- Material: POM
- For re-orders when lost
- Enclosed with every glass fiber optic of type A

For use with FZAM 18

**order reference**

10101480 Cap nut (replace) for fiber optics series 18



IP65

PinPoint

Teach-in

Analog

NPN

*qTarg*



Active zone

The zone in which an object can be detected in front of the sensor. With diffuse sensors, this is approximately equivalent to the zone within the maximum sensing distance where the emitted beam and the reception angle intersect. With retro-reflective sensors, this is the zone from the emitted beam exit plane to the reflector and from there back to the receiver entrance plane. With through beam sensors, this is the zone from the emitted beam exit plane to the receiver entrance plane.

Actual range  $S_b$

Like the nominal range  $S_n$ , but including an excess gain of 50% excess gain, i.e. the maximum distance at which reliable operation of the sensor is possible

Adjustment aid

See «Output indicator»

Alarm output

Output function which indicates an inadequate signal level. The alarm output usually has a «dynamic» function which indicates whether the excess gain of 150% of the switching threshold was exceeded or not during the last light switching operation. It is also usually available as a «static» function: in this case, the alarm output indicates whether the current value of the signal is within the «critical range» between 100% and 150% of the switching threshold.

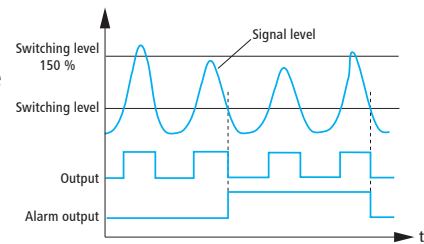

Ambient light immunity

Maximum permissible light intensity of the ambient light measured with a non-pulsed light source to IEC60947-5-2 and directed together with the receiver at a white reference paper which clearly covers the received beam. The light intensity is measured on the reference paper. In almost all sensor ranges, direct exposure of the white object to sunlight has no effect on the measurement. However, direct exposure of the received beam to sunlight almost certainly causes measuring errors.

Analog output

In contrast to the binary output with two possible output states, the analog output allows one continuous value such as a voltage or current to be emitted, resulting in a higher resolution of the measured values (see «Resolution»). Usually available as a voltage output 0 ... 10 V and current output 0 ... 20 mA or 4 ... 20 mA. The analog value can also be transmitted via a digital interface like RS 485.

Background suppression

Diffuse sensors usually operate by the triangulation principle. Thanks to this accurate distance measurement, a background may be located close behind the adjusted switching point without interfering with the measurement. The background is «suppressed».

Beam alignment, squint

Due to the addition of the production tolerances of the optical and mechanical components which cannot be compensated by adjustment during manufacture, a squint between the emitter and receiver beams of up to several degrees can occur. From a light distance of more than approx. 40 cm, retro-reflective sensors must usually be aligned. (Exception: OAxX/OBxx range is factory-adjusted.)

Beam-interrupting

Sensor class in which the presence of an object is detected by interruption of the light beam between an emitter (and possibly a reflector) and an associated receiver.

Binary output

Output which can assume two states, i.e. a switching output



Black-white (gray-white) offset	For diffuse sensors with foreground and background suppression, there is a reduction in the sensing distance on gray or black reference paper in comparison with white reference paper (foreground suppression: increased sensing distance). This is also known as the black-white and gray-white offset. The sensing distance diagram shows the reduction in the sensing distance to gray or black as a function of the adjusted sensing distance.																		
Blind region	Because the emitter and receiver axes are usually offset to each other, it is possible at very close distances to the object that no light emitted by the emitted beam is within the detected angle of the receiver. In this situation, the sensor is dark-switched, or «blind».																		
CE conformity	Designates compliance of the products with European Union directives. The CE marking of the products is conditional on metrological proof of their electromagnetic compatibility (EMC) according to IEC 61000-4-x standards. Please also note the information on the safety concept.																		
Closing delay	Output function which extends the dark-switched state of a binary sensor by a specific time. This causes a delay in the switching of a light-switching output and the dark-switching output switches later.																		
Color sensor <i>LOGIPAL</i>	A color sensor determines the magnitude of deviation of the color components between a taught-in color and the color reflected by the object. The switching output indicates whether at least one color component is outside the specified tolerance bands.																		
Color-based	Sensor class which detects a specific composition of the reflected light spectrum, meaning colors or gray scales (=contrasts). The distance and received light intensity are secondary.																		
Complementary output	Depending on the wiring the output can be used as a light-switching or dark-switching output. Both output versions are available simultaneously.																		
Correction factor	<p>The material and the surface texture of the object affect the switching distance of a diffuse sensor with intensity difference. To determine the corrected switching distance, the following values must therefore be applied to the relative receiving signal (KFs) and as an approximation to the distance (KFd).</p> <table border="0" style="width: 100%; border-collapse: collapse;"> <thead> <tr> <th style="text-align: left;">Material</th> <th style="text-align: left;">KFs</th> <th style="text-align: left;">KFd</th> </tr> </thead> <tbody> <tr> <td>Kodak test card</td> <td>100%</td> <td>100%</td> </tr> <tr> <td>Light, planed wood 80%</td> <td>90%</td> <td></td> </tr> <tr> <td>Rough wood</td> <td>20%</td> <td>45%</td> </tr> <tr> <td>Drawn aluminum</td> <td>25%</td> <td>50%</td> </tr> <tr> <td>Cardboard, matt black</td> <td>7%</td> <td>26%</td> </tr> </tbody> </table>	Material	KFs	KFd	Kodak test card	100%	100%	Light, planed wood 80%	90%		Rough wood	20%	45%	Drawn aluminum	25%	50%	Cardboard, matt black	7%	26%
Material	KFs	KFd																	
Kodak test card	100%	100%																	
Light, planed wood 80%	90%																		
Rough wood	20%	45%																	
Drawn aluminum	25%	50%																	
Cardboard, matt black	7%	26%																	
Current consumption	Because photoelectric sensors usually operate with pulsed light, their operating current is not constant, but assumes a saw-tooth shape due to the internal smoothing of the current. An average value and a maximum value can be specified from this. Usually this is the maximum value.																		



Degree of remission	The degree of remission designates the diffuse proportion of the reflected light, i.e. without the reflective proportion.
Diffuse sensor	Diffuse sensors detect the presence of an object by illuminating it with emitted light, which is then reflected by the object to the receiver in a diffused form (remitted).
Direction of approach	With triangulation sensors, the approach of an object edge in the direction from the emitter lens to the receiver lens or the reverse can lead to incorrect results. The directions of approach from the front or the side cause no errors.
Distance-based	Sensor class in which the distance to the object is primarily assessed as the measured value. The intensity of the received signal, colors or gray scales are secondary.
ECOLAB approved	The sensors are resistant to many common cleaning agents.
EHEDG (Hygienic Design)	Sensors and mounting accessories meet the design criteria for hygienic applications. These sensors can be used in close proximity to foodstuff and facilitate the certification of the machine.
EMC	All sensors undergo type testing with regard to their electromagnetic compatibility (EMC) according to the standards IEC61000-4-2, -3, -4.
Error correction	Photoelectric sensors usually operate by measuring pulsed light reflected by the object to the receiver. Because a measurement of this kind can be interfered with by various effects from the surroundings, e.g. rapid changes in the ambient light (switching fluorescent lighting on and off, welding sparks etc.), not all received light pulses appear in their correct magnitude, which could lead to switching errors. Fault correction evaluates the received pulses and only changes the switching state when a significant majority of pulses received within a time window indicate the need to change the switching state.
Excess gain	Because signal losses can occur in applications with optical sensors due to soiling of the optics and ageing of the light source, an excess gain must be allowed in the design of the application by presuming a shorter distance to the object than that indicated by the switching point. For reliable operation, an excess gain of at least 150% of the switching threshold is required. This distance correction can either be read off from the excess gain diagram or by exploiting the point at which the output indicator stops flashing. There are corresponding correction factors for diffuse sensors with intensity difference.
External teach-in input	See «Teach-in»
FDA compliant	Consistent use of food compliant materials only.
Fiber optic sensor	An intensity-based sensor in which the emitter and receiver optics are replaced by an optical fiber connection.





Focusing	Particularly for sensors operating by the triangulation principle, it is ideal when the size of the light spot is as small as possible. However, according to the laws of optics, it is only possible to bundle the light rays at one point of the light path, the so-called point of focus. For this reason, light sources are focused at a specific distance. This distance is optimum for the detection of very small objects.
Infrared light	Light in a long-wave range which is invisible to the human eye. In comparison with red light LEDs, IR LEDs can supply a higher radiated power. Unsuitable for use with plastic optical fibers, but suitable for glass optical fibers.
Intensity-based	Sensor class in which the light intensity impinging on the receiver is processed as a measured value (which is only an indirect measure of the distance to the object). The distance, colors or gray scales (= contrast) are secondary.
Inverted output	Depending on the wiring the output can be used as a light-switching or dark-switching output. Both output variants exist at the same time.
 <b>IO-Link</b>	This is a communication standard for point-to-point connections between a master (connecting module) and a slave (sensor/actor). Non-screened standard sensor cables can be used as the transmission medium. Process data (analog/binary) and service data (parameters/diagnostics) can be transmitted by serial communication. IO-Link compatible sensors can be connected to existing I/O modules (without using serial communication). The advantage of IO-Link is the reduction in project planning and installation costs by a uniform interface and convenient parameter adjustment and management.
Laser diode	Light source featuring an exit zone of the light that is very small and can therefore be focused by downstream optics to form a very small measuring point (light spot). Another feature is that the light intensity is regulated by a monitor function and therefore remains practically unchanged during the service life of the laser diode.
Laser protection class	Lasers are subdivided into different protection classes according to their danger to the human eye: 1: Harmless 1M: Harmless as long as not further bundled by optical measures 2: Laser radiation exists only in the visible spectral range (400 ... 700 nm). Harmless for short periods of irradiation (max. 0.25s, as normally given by the natural protective reflex of the eyelid) 2M: Like 2 as long as not further bundled by optical measures
Light/dark operation	Light operation: the output switches when the receiver receives light. Dark operation: the output switches when the receiver receives no light.
Linearity deviation	Deviation from a proportional linear function (straight line). This is specified as an absolute value in mm or as a relative value as a percentage of the far limit of the measuring range.



Linking capability of outputs

**Parallel connection of the outputs (OR function)**

Sensors with identical output stages (NPN or PNP) can be connected in parallel if they are connected to the same power supply unit. The number of sensors which can be connected in parallel depends on the respective load current and the currents flowing through the internal pull-up and pull-down resistors (typically 3 mA). The sum of all load currents plus the sum of all internal currents must not exceed the specified maximum switching current of a single sensor.

**Series connection of sensors (AND function)**

Relay outputs may be connected in series. For sensors with electronic outputs, it is not permissible to switch on the supply of one sensor via the output of a preceding sensor and implement an AND function in this way. Because a sensor represents a high capacitive load, this would activate the short circuit protection.

Measuring range

The sensor supplies a valid measurement result within this range. The measuring range and the limits of the measuring range are adjustable in some sensors.

Minimum pulse length

Output function which forces a minimum length, e.g. 4 ms, for the two output states of a binary sensor, so that even a slow controller can detect such a state without difficulty. In contrast to release/response delay, an output state longer than the minimum impulse length is not extended.

Mounting distance

Distance between sensors (in diffuse sensors between the emitted light spots on the object) to prevent optical interference. Sensors with measures to reduce optical interference are not affected by this, but if the number of 3 is exceeded, the specified mounting distance for the next sensor but one is applicable.

Mounting instructions (MAL)

Some sensors are supplied with mounting instructions (MAL) which contain detailed notes on the connection and operation of the sensor

Nominal range  $S_n$

The guaranteed maximum switching distance of retro-reflective sensors under ideal conditions (at +25° C, not soiled, sensors adjusted to each other).

NPN output

Binary open collector switching output with NPN transistor switching to 0 V. Consequently the load current flows from the switching output through the load resistance to +Vs. A suppressor diode is integrated and also an internal load resistor of approx. 10 ... 50 kOhm for measurement purposes.

Off delay

Output function which extends the light-switched state of a binary sensor by a specific time. As a result, the light-switched output drops out later and the dark-switched output is switched after a delay.

On delay

Output function which extends the dark-switched state of a binary sensor by a specific time. As a result the light-switching output switches after a delay and the dark-switching output will drop out later.

*OneBox Design*

*OneBox Design* stands for a new Baumer housing design. Baumer *NextGen* sensors feature the same dimensions, through holes and control elements for all sensor principles and technologies within the series.

One Inch Class

Compact sensor for one-inch mounting hole spacing is ideally suited for systems with extremely tight spaces..

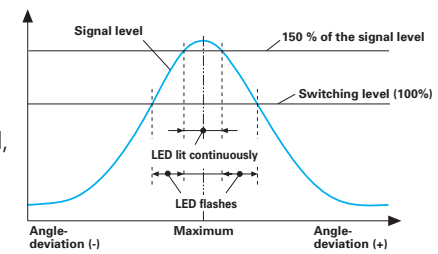

Optical fiber	Cable made of glass or plastic fibers which conveys the light of a photoelectric sensor and enables the detection of an object at a constrained point due to its small size.
Optical interference	Without countermeasures, pulsed light sources which illuminate the same point on an object can overlap, which can cause switching errors. Sensors which are insensitive to optical interference use methods by which the pulses can evade each other and minimize situations in which switching errors are possible. These methods allow operation of up to 3 sensors in the same operating range, i.e. each sensor may «see» 2 interfering neighbors. The method becomes more reliable the better the neighboring sensors can be «seen», enabling the evasion algorithms to be suitably adjusted.
Output current	Maximum permissible current load at the outputs. Because the short-circuit protection secures all outputs together in sensors with several outputs and therefore monitors the sum of all output currents, it must be observed that the output current specification refers to this sum.
Output indicator	<p>Visual display on the sensor, usually a yellow LED which indicates the status of the sensor receiver. LED off: receiving signal &lt; switching threshold, LED flashing: receiving signal between 100 ... 150% of the switching threshold, LED steady on: receiving signal &gt;150% of the switching threshold.</p> 
Overvoltage protection	Protection against brief voltage surges in accordance with the standard IEC 61000-4
<i>ParCon/PosCon</i> line sensor	The line sensor is able to detect edges, widths and positions of objects without additional illumination. The measured value is issued with high accuracy as an analog value or via a serial interface.
PNP output	Binary open collector switching output with PNP transistor switching to +Vs. Consequently the load current flows from the switching output through the load resistance to 0 V. A suppressor diode is integrated and also an internal load resistor of approx. 10 ... 50 kOhm for measurement purposes.
Point source LED	Form of LED in which, in contrast to conventional LEDs, the light exit is not diffuse and distributed around the entire chip, but exits from the front in a circular and therefore clearly defined shape. A very small light spot can be created in this way (ideal for diffuse sensors with background suppression), similar to a laser, but at the expense of the total light intensity.
Polarization filter	Polarization filters only allow light to pass which is polarized in a specific plane. Retro-reflective sensors with polarization filters have polarization planes at the emitter and receiver twisted towards one another by 90°, so they only detect light which is reflected by a retro-reflector and depolarized in this way. For this reason, the light beam itself is always reliably interrupted by reflective objects (which leave the polarization plane unchanged).



## *proTect*<sup>+</sup>

Unique impermeability concept – it guarantees that the sensors comply with protection class IP 68/IP 69K standards even after many temperature cycles and therefore have a long service life and high reliability.

## Protection class (to IEC 60529)

**IP 65:** Protection against the penetration of dust and full protection against electrical contact. Protection against a water jet from any direction.

**IP 67:** Protection against the penetration of dust and full protection against electrical contact. Protection against water when the housing is immersed in water under specific pressure and time conditions.

## Pulsed light

The sensitivity of a photoelectric sensor to ambient light can substantially be reduced by using pulsed light. On the one hand, the emitter LEDs can emit a higher peak power in pulsed operation, on the other, this makes differential measurement possible during which the difference in the received light with the light source switched on or off can be evaluated and non-pulsed light can be effectively compensated.

## Push-pull output

Compared to the open collector output variants PNP (= load virtually 0V) and NPN (= load virtually +Vs), the push-pull output enables random switching of the load within the limits of the supply voltage. However, compared to the above named open collector output variants, it is not admissible to connect outputs in parallel.

## *qTarget*<sup>TM</sup>

The Baumer design aligns the sensor's light beam to the fixing holes. This will not only compensate tolerances between individual components but ensures consistent alignment accuracy within the complete sensor series.

## *qTeach*<sup>TM</sup>

With *qTeach* we are introducing a new, convenient and wear-free teach procedure. Teaching of O500 sensors is just by a touch with any ferromagnetic tool. A blue LED light provides clear optical feedback. To prevent user errors, *qTeach* locks autonomously after 5 minutes.

## Range sensor

Diffuse sensor with a switching output where two switching points can be set. This makes it possible to detect the presence of an object within a specified distance range.

## Red light

Standard light color in the visible range, also suitable for use with plastic optical fibers. Advantage: due to its visibility, this improves the adjustment and monitoring of the application.

## Reflection foil

See «(Retro-) reflector»

## Relative receiving signal

The relative receiving signal is specified in diffuse sensors operating by the intensity difference principle. This signal represents the signal level received from a white object as a function of the distance. With the aid of this diagram, it is possible to determine the sensing distance for an object which is not white. The correction factor of the respective material is required for this purpose.

## Release delay

Output function which extends the light-switched state of a binary sensor by a specific time. The light-switched output thereby opens later and the dark-switched output is switched after a delay.



Release time	The minimum time required for an object to have left the scanning range to cause a change in the output state. This change in state is immediate, unless a signal processing time is also specified by which this change in state is further delayed. Compliance with this release time is conditional on the switching threshold falling by max. 50%. If it is necessary for the sensor to take measures to reduce interference with other sensors, this time may be extended by up to 50 $\mu$ s.
Reproducibility (Repeat accuracy)	Max. deviation between two measurements under identical conditions (object position, soiling, temperature, duty cycle)
Residual ripple	Maximum proportion of alternating current which may be superimposed on the DC voltage supply with the momentary values remaining within the specified voltage supply range. Specified as a percentage of the mean value of +Vs.
Resolution	The smallest possible change in the measured value to cause a discernible change in the output signal.
Response time	The minimum time required for an object to be within the sensing distance to cause a change in the output state. This change in state is immediate, unless a signal processing time is also specified by which this change in state is further delayed. Compliance with this response time is conditional on an excess gain of at least 50% (the output indicator does not flash). If it is necessary for the sensor to take measures to reduce interference with other sensors, this time may be extended by up to 50 $\mu$ s.
(Retro-) reflector	Reflector that casts light back in the direction of incidence and as a result, in contrast to a mirror, requires no exact alignment. They are available in the form of a triple reflector or reflective film.
Reverse polarity protection	Protection against reverse polarity is generally ensured between any connections of the sensor unless otherwise specified (e.g. only supply connections).
Safety concept	The safety concept defines the technical, instructional and legal measures which ensure the user (machine manufacturer, owner, user) a high degree of safety when handling our components. The safety concept also serves as the basis for the CE marking of our products and can be obtained in German, English or French.
Sensing range Tb	The sensing range Tb ranges between the adjusted sensing distance and the blind region. The blind region defines the range immediately in front of the sensor where an object cannot be reliably detected. The sensing distance is therefore the distance where an object (Kodak white) is reliably detected.
Sensing distance Tw	The sensing distance Tw is the maximum achievable distance of a diffuse sensor measured at +25° C on white paper (Kodak Card No. 1 527 795) size 200 x 200 mm. At a maximum sensing distance of under 400 mm, the reference paper size is 100 x 100 mm. The excess gain necessary for reliable operation under ideal conditions (50%) is already included. Sensors with adjusting aids indicate this point by a continuously lit reception indicator.
Sensitivity adjustment	Sensors operating with intensity difference or as retro-reflective sensors may have adjustable sensitivity. The sensitivity can then be adjusted to the application using a potentiometer or by teach-in.



Sensor standard	The sensor standard IEC60947-5-2 forms the basis for all type tests on photoelectric sensors.
Shape-based	Sensor class which detects specific features of shape, e.g. edges, the height of newspaper copies, etc. The distance, received light intensity, colors or gray scales are secondary.
Short circuit protection	In optical sensors, short circuit protection is clocked (switches the output off for approx. 20 ms), self-resetting (attempts to switch the output again after the shut-off time has elapsed) and start-delayed (to handle capacitive loads of up to 50 nF occurring with longer cables).
Signal processing time	Delay between the detection of the future output state and its transmission to the output caused by signal processing. This has no effect on the maximum measurement frequency!
Smallest object	If the optical prerequisites for the detection of small objects are fulfilled, i.e. a sufficient signal difference exists, the following generally applies to the detection of moving objects with diffuse sensors: time in the scanning range > response time. For retro-reflective sensors: time in the scanning range > release time. The time in the scanning range $t_e$ can be calculated by: $t_e = \text{distance in the scanning range} / \text{object speed}$
SmartReflect light barriers	Light barriers without reflectors. See section on SmartReflect light barriers.
Soiled lens indicator	See «Output indicator»
Start pulse suppression	Start pulse suppression suppresses undefined states during the starting phase by disabling all outputs during the first 20 ms after the voltage supply was switched on.
Switching hysteresis	Switching hysteresis is employed to prevent the normal fluctuations of the measured value close to the switching points of binary outputs from producing uncertain switching states (oscillating) at the output. A higher switching threshold to switch on the sensor is adjusted than to switch it off, resulting in a difference between the distances for switching on and off.
Teach-in	Electronic teaching of an operating parameter (e.g. sensitivity adjustment) by pressing a button or via an external teach-in input. The «static teach-in» function is available as a standard feature. During teach-in the on position and off position are taught in and the sensor calculates the optimum switching point from this. The on position is always used as a normally open function and the off position always as a normally closed function. There is also a «dynamic teach-in» function, during which the maximum and minimum values of the results measured over a desired time are analyzed and an optimum switching threshold for this situation is automatically adjusted afterwards.
Teach-input external	See «Teach-in».
Temperature drift	In photoelectric sensors, the emitter light sources (apart from laser diodes), receiver elements and amplifiers are subject to certain thermal effects. This dependency of the measured values on the temperature is specified by the designation «temperature drift».



---

## Test input

Some sensors provide a means of switching off the emitter for a function test by activating an input. If the sensor was previously switched to light, the output of the sensor must consequentially change to the dark switching state

---

## Triangulation principle

Measuring principle used in diffuse sensors with background suppression and in distance-measuring sensors. The emitter, the object and the receiver form a triangular arrangement. The receiver is designed to enable measurement of the angle between the beams from the emitter to the object and from the object to the receiver. This angle depends on the distance to the object, which is determined by the position at which the received beam strikes the receiver element.

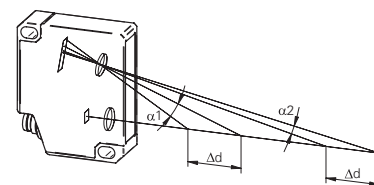

---

## UL test mark

The UL mark on a product indicates that samples of the complete product were tested by UL according to nationally acknowledged safety standards, that they are free from unacceptable, foreseeable risks such as fire, electric shocks and similar hazards and that the product was manufactured under UL supervision. Most products from Baumer electric are UL-listed. The file with the listed products can be viewed at [HYPERLINK "http://www.ul.com/database"](http://www.ul.com/database).

---

## Voltage supply range

The voltage supply must be within a specified voltage supply range at all times to ensure the correct function of the sensor.

---







order reference	page	order reference	page	order reference	page
<b>1</b>				<b>F</b>	
10101480	761	ES 14A PG7	736	FADH 14I4470/IO	704
10101958	760	ES 14C PG7	736	FADH 14I4470/KS34A/IO	704
10102757	760	ES 18A PG7	736	FADH 14U4470/IO	706
10102801	749	ES 18C PG7	736	FADH 14U4470/KS34A/IO	706
10103067	749	ES 21	736	FADK 14I4470/IO	696
10103068	748	ES 21A	736	FADK 14I4470/S14/IO	696
10103226	748	ES 22	737	FADK 14I4470/S35A/IO	696
10103230	760	ES 22A	737	FADK 14I4470/S14/IO	698
10103415	752	ESG 32AH0200	737, 741	FADK 14U4470/S14/IO	698
10106042	760	ESG 32AH0200G	737	FADK 14U4470/S35A/IO	698
10107250	748	ESG 32AH0500	737, 741	FADR 14I4470/S14/IO	700
10107408	748	ESG 32AH0500G	737	FADR 14U4470/S14/IO	702
10112477	753	ESG 32AH1000	737, 741	FCE 050C1Y10	473
10113873	751	ESG 32AH1000G	737	FCE 200C1Y00	474
10113917	752	ESG 32SH0200	737, 741	FCE 200C1Y01	475
10114501	751	ESG 32SH0500	737, 741	FCE 200D1Y00	476
10114652	760	ESG 32SH0500G	737	FCE 200D1Y01	477
10115913	749	ESG 32SH1000	737, 741	FCE 200E1Y00	478
10116407	752	ESG 32SH1000G/T	737	FEAM 08P1002	192
10118798	751	ESG 34AF0500	739, 756	FEAM 08P1002/S35L	192
10119373	752	ESG 34AF1000	739, 756	FEAM 08P3002	192
10119909	758	ESG 34AH0200	738	FEAM 08P3002/S35L	192
10119910	758	ESG 34AH0200G	739	FECK 07N6901	184
10119911	759	ESG 34AH0500	738	FECK 07N6901/KS35A	184
10119912	759	ESG 34AH0500G	739	FECK 07P6901	184
10125534	759	ESG 34AH1000	738	FECK 07P6901/KS35A	184
10126220	753	ESG 34AH1000G	739	FEDK 07N6901	186
10133792	751	ESG 34CH0200	738	FEDK 07N6901/KS35A	186
10134540	758	ESG 34CH0200G	739	FEDK 07P6901	186
10134541	758	ESG 34CH0500	739	FEDK 07P6901/KS35A	186
10134542	759	ESG 34CH0500G	739	FEDK 10N5101	194
10134543	758	ESG 34CH1000G	739	FEDK 10N5101/S35A	194
10134544	758	ESG 34FH0200G	739	FEDK 10P1101/KS35	194
10134964	751	ESG 34FH0500G	739	FEDK 10P3101/KS35	194
10140260	760	ESG 34FH1000G	739	FEDK 10P5101	194
10144075	748	ESG 34SH0200	738	FEDK 10P5101/S35A	194
10145523	760	ESG 34SH0500	738	FEDK 14N5101	200
10145702	759	ESG 34SH1000	738	FEDK 14N5101/S14	200
10149010	754	ESW 31AH0200	738	FEDK 14N5101/S35A	200
10149011	755	ESW 31AH0200G	738	FEDK 14P5101	200
10150326	755	ESW 31AH0500	738	FEDK 14P5101/S14	200
10150328	754	ESW 31AH0500G	738	FEDK 14P5101/S35A	200
10150844	750	ESW 31AH1000	738	FEDM 08P1001	188
10151658	755	ESW 31AH1000G	738	FEDM 08P1001/S35L	188
10151719	755	ESW 31SH0200	738	FEDM 08P1002	190
10151720	754	ESW 31SH0200G	738	FEDM 08P1002/S35L	190
10151721	755	ESW 31SH0500	738	FEDM 08P3001	188
10156738	760	ESW 31SH0500G	738	FEDM 08P3001/S35L	188
10156878	748	ESW 31SH1000	738	FEDM 08P3002	190
10158142	760	ESW 33AF0200	740, 756	FEDM 08P3002/S35L	190
10159806	759	ESW 33AF0500	740, 756	FEDM 12P5101	196
10159905	753	ESW 33AF1000	740, 756	FEDM 12P5101/S35A	196
10159906	753	ESW 33AF2500	740, 756	FFAK 16NTD1001/L	559
10161695	751	ESW 33AH0200	739	FFAK 16PTD1001/L	559
10161829	754	ESW 33AH0200G	740	FFAK 17NTD1001/L	557
10162083	750	ESW 33AH0500	739	FFAK 17NTD1002/L	558
10163196	750	ESW 33AH0500G	740	FFAK 17PTD1001/L	557
10163299	750	ESW 33AH1000	739	FFAK 17PTD1002/L	558
11010227	752	ESW 33AH1000G	740	FFAM 16PTD1002/L	561
11046278	752, 757	ESW 33CH0200	739	FFAM 17PTD1002/L	560
11046279	755, 757	ESW 33CH0500	739	FFDK 16P50Y0	562
11092246	750	ESW 33CH0500G	740	FFDK 16P50Y5	562
11099942	754	ESW 33FH0200G	740	FGLM 050P8001/S35L	247
11102423	750	ESW 33FH0500G	740	FGLM 080P8001/S35L	248
11104963	754	ESW 33FH1000G	740	FGLM 120P8001/S35L	249
		ESW 33SH0200	739	FGUM 020P8001/S35L	239
		ESW 33SH0500	739	FGUM 030P6901/S35A	241
		ESW 33SH1000	739		
<b>E</b>					

order reference	page
FGUM 030P8001/S35L	240
FGUM 050P6901/S35A	243
FGUM 050P8001/S35L	242
FGUM 080P6901/S35A	245
FGUM 080P8001/S35L	244
FGUM 120P8001/S35L	246
FHCK 07N6901	272
FHCK 07N6901/KS35A	272
FHCK 07P6901	272
FHCK 07P6901/KS35A	272
FHDH 14G6901	352
FHDH 14G6901/IO	352
FHDH 14G6901/KS34A	352
FHDH 14G6901/KS34A/IO	352
FHDK 04G6101	270
FHDK 04G6101/KS35A	270
FHDK 04G6102	270
FHDK 04G6102/KS35A	270
FHDK 04G6111	270
FHDK 04G6111/KS35A	270
FHDK 04G6112	270
FHDK 04G6112/KS35A	270
FHDK 07N6901	274
FHDK 07N6901/KS35A	274
FHDK 07P6901	274
FHDK 07P6901/KS35A	274
FHDK 10G5120	276
FHDK 10G5120/S35A	276
FHDK 10G5121	276
FHDK 10G5121/S35A	276
FHDK 10G5122	276
FHDK 10G5122/S35A	276
FHDK 10N1101/KS35	278
FHDK 10N5101	278
FHDK 10N5101/S35A	278
FHDK 10N5110	280
FHDK 10N5110/S35A	280
FHDK 10N5150	282
FHDK 10N5150/S35A	282
FHDK 10N5160/S35A	344
FHDK 10P1101/KS35	278
FHDK 10P5101	278
FHDK 10P5101/S35A	278
FHDK 10P5110	280
FHDK 10P5110/S35A	280
FHDK 10P5150	282
FHDK 10P5150/S35A	282
FHDK 10P5160/S35A	344
FHDK 14N5101	296
FHDK 14N5101/S14	296
FHDK 14N5101/S35A	296
FHDK 14N5104	296
FHDK 14N5104/S14	296
FHDK 14N5104/S35A	296
FHDK 14N6901	298
FHDK 14N6901/S14	298
FHDK 14N6901/S35A	298
FHDK 14P5101	296
FHDK 14P5101/S14	296
FHDK 14P5101/S35A	296
FHDK 14P5104	296
FHDK 14P5104/S14	296
FHDK 14P5104/S35A	296
FHDK 14P6901	298
FHDK 14P6901/S14	298
FHDK 14P6901/S35A	298
FHDK 20N6901/S35A	308
FHDK 20P6901/S35A	308
FHDM 12N5001	284

order reference	page
FHDM 12N5001/S35A	284
FHDM 12P5001	284
FHDM 12P5001/S35A	284
FHDM 16N5001	300
FHDM 16N5001/S14	300
FHDM 16N5004	300
FHDM 16N5004/S14	300
FHDM 16P5001	300
FHDM 16P5001/S14	300
FHDM 16P5004	300
FHDM 16P5004/S14	300
FHDR 14G6901/S14	350
FHDR 14G6901/S14/IO	350
FKDH 14G6901	426
FKDH 14G6901/KS34A	426
FKDK 14G6901	428
FKDK 14G6901/S14	428
FKDK 14G6901/S35A	428
FKDM 22N1901/S14F	420
FKDM 22N1902/S14F	421
FKDM 22P1901/S14F	420
FKDM 22P1902/S14F	421
FKDM 22P1911/S14F	422
FKDM 22P3902/S14F	421
FKDR 14G6901/S14	430
FKE 200D1Y00	479
FLC 200D2Y00	501
FLDK 110C1003/S42	599
FLDK 110C1005/S42	599
FLDK 110G1003/S14	599
FLDK 110G1003/S42	599
FLDK 110G1005/S14	599
FLDK 110G1006/S14	602
FLDK 110G1010/S14	604
FLDK 110G1303/S14	602
FLDM 170C1011/S42	596
FLDM 170C1030/S42	594
FLDM 170G1011/S42	596
FLDM 170G1030/S42	594
FLE 200C1Y00	480
FLE 200D1Y00	481
FNCK 07N6910	26
FNCK 07N6910/KS35A	26
FNCK 07P6910	26
FNCK 07P6910/KS35A	26
FNDH 14G6901	80
FNDH 14G6901/IO	80
FNDH 14G6901/KS34A	80
FNDH 14G6901/KS34A/IO	80
FNDH 14G6902	66
FNDH 14G6902/IO	66
FNDH 14G6902/KS34A	66
FNDH 14G6902/KS34A/IO	66
FNDH 14G6903	66
FNDH 14G6903/IO	66
FNDH 14G6903/KS34A	66
FNDH 14G6903/KS34A/IO	66
FNDK 07N6910	28
FNDK 07N6910/KS35A	28
FNDK 07P6910	28
FNDK 07P6910/KS35A	28
FNDK 14G6902/IO	62
FNDK 14G6902/S14/IO	62
FNDK 14G6902/S35A/IO	62
FNDK 14G6903/IO	62
FNDK 14G6903/S14/IO	62
FNDK 14G6903/S35A/IO	62
FNDK 14G6904/IO	38
FNDK 14G6904/S14/IO	38

order reference	page
FNDK 14G6904/S35A/IO	38
FNDK 14P6910/S14	36
FNDK 14P6910/S35A	36
FNDR 14G6901/S14	78
FNDR 14G6901/S14/IO	78
FNDR 14G6902/S14	64
FNDR 14G6902/S14/IO	64
FNDR 14G6903/S14	64
FNDR 14G6903/S14/IO	64
FOC 500C6Y00	482, 564
FODK 23P90Y0	563
FODK 23P90Y0/0500	563
FODK 23P90Y5	563
FPAM 18N3151	122
FPAM 18N3151/S14	122
FPAM 18P3151	122
FPAM 18P3151/S14	122
FPCK 07N6901	98
FPCK 07N6901/KS35A	98
FPCK 07P6901	98
FPCK 07P6901/KS35A	98
FPDH 14N5101	168
FPDH 14N5101/KS34A	168
FPDH 14P5101	168
FPDH 14P5101/KS34A	168
FPDK 07N6901	100
FPDK 07N6901/KS35A	100
FPDK 07P6901	100
FPDK 07P6901/KS35A	100
FPDK 10N5130	102
FPDK 10N5130/S35A	102
FPDK 10N5135	102
FPDK 10N5135/S35A	102
FPDK 10P5130	102
FPDK 10P5130/S35A	102
FPDK 10P5135	102
FPDK 10P5135/S35A	102
FPDK 14N5101	112
FPDK 14N5101/S14	112
FPDK 14N5101/S35A	112
FPDK 14N5111	112
FPDK 14N5111/S14	112
FPDK 14N5111/S35A	112
FPDK 14P5101	112
FPDK 14P5101/S14	112
FPDK 14P5101/S35A	112
FPDK 14P5111	112
FPDK 14P5111/S14	112
FPDK 14P5111/S35A	112
FPDK 20N5101/S35A	120
FPDK 20P5101/S35A	120
FPDM 12N3401/S35A	104
FPDM 12N5101	104
FPDM 12N5101/S35A	104
FPDM 12P3401	104
FPDM 12P3401/S35A	104
FPDM 12P5101	104
FPDM 12P5101/S35A	104
FPDM 16N5101	118
FPDM 16N5101/S14	118
FPDM 16P3921/S14	150
FPDM 16P5101	118
FPDM 16P5101/S14	118
FPDM 16P5105	118
FPDM 16P5105/S14	118
FPDR 14N5101/S14	166
FPDR 14P5101/S14	166
FPE 200C1Y00	502

order reference	page	order reference	page	order reference	page
FPE 200C4Y00	504	FSE 100A4004	543	FSL 500C6Y00	564
FPE 200D1Y00	503	FSE 100A4006	542	FTAR 013A000	742
FRDK 14N6901	146	FSE 100F6Y01	527	FTAR 014A000	742
FRDK 14N6901/S14	146	FSE 200C1002	508	FTAR 020A000	742
FRDK 14N6901/S35A	146	FSE 200C1004	509	FTAR 038A000	742
FRDK 14P6901	146	FSE 200C1013	510	FTDF 005I040	745
FRDK 14P6901/S14	146	FSE 200C1Y00	511	FTDF 012M050	745
FRDK 14P6901/S35A	146	FSE 200C2002	513	FTDF 020F020	744
FSA 200C1Y00	505	FSE 200C2004	514	FTDF 020I175	745
FSAM 08D9002	192	FSE 200C2Y00	515	FTDF 035I395	745
FSAM 08D9002/S35	192	FSE 200C4001	518	FTDF 035M050	745
FSB 200C1Y00	506	FSE 200C4002	519	FTDF 050M234	745
FSC 200C4Y00	507	FSE 200C6Y00	521	FTDR 005I040	744
FSCK 07D9601	184	FSE 200C6Y02	522	FTDR 008M030/01	746
FSCK 07D9601/KS35A	184	FSE 200C6Y15	523	FTDR 008M030/21	746
FSDK 07D9601	186	FSE 200D1Y50	512	FTDR 010A014	742
FSDK 07D9601/KS35A	186	FSE 200D2Y00	516	FTDR 010D020	742
FSDK 10D9001/KS35	194	FSE 200D2Y50	517	FTDR 015A038	743
FSDK 10D9601	194	FSE 200D4Y00	520	FTDR 017A027	743
FSDK 10D9601/S35A	194	FSE 200E1Y00	524	FTDR 017W035	744, 757
FSDK 14D9601	200	FSE 200F1Y00	525	FTDR 020I175	744
FSDK 14D9601/S14	200	FSE 200F4Y00	526	FTDR 029A046	743
FSDK 14D9601/S35A	200	FSE 200F6Y00	528	FTDR 035I395	744
FSDM 08D9001	188	FSF 025B1001	548	FTDR 047A048	743
FSDM 08D9001/S35	188	FSF 025B1005	547	FTDR 050R060	743, 757
FSDM 08D9002	190	FSF 025B1007	547	FTDR 051E051	743, 757
FSDM 08D9002/S35	190	FSF 025B2001	548	FTDR 084A084	744
FSDM 12D9601	196	FSF 025B2002	547	FUA 200C1Y00	483
FSDM 12D9601/S35A	196	FSF 025B2005	547	FUB 200C1Y00	484
FSE 025B1001	547	FSF 025B2006	547	FUC 200C2Y00	485
FSE 025B1003	548	FSF 025B4002	547	FUE 025B1001	546
FSE 025B1007	547	FSF 025B4003	547	FUE 025B1002	545
FSE 025B2001	547	FSF 025B4004	548	FUE 025B1003	545
FSE 025B2002	547	FSF 050A1001	543	FUE 025B1008	546
FSE 025B2003	548	FSF 050A1002	542	FUE 025B1011	546
FSE 025B2006	547	FSF 050A1005	542	FUE 025B2001	546
FSE 025B4003	547	FSF 050A2001	543	FUE 025B2002	545
FSE 025B4004	548	FSF 050A2002	542	FUE 025B2003	545
FSE 025B4006	547	FSF 050A2004	542	FUE 025B2004	545
FSE 050A1001	542	FSF 050A2005	542	FUE 025B2008	546
FSE 050A1003	543	FSF 050A3020	543	FUE 025B2011	546
FSE 050A1006	542	FSF 050A3021	543	FUE 025B3001	546
FSE 050A2001	542	FSF 050A3022	543	FUE 025B4003	545
FSE 050A2002	542	FSF 050A4002	542	FUE 025B4004	546
FSE 050A2003	543	FSF 050A4003	542	FUE 025B4005	545
FSE 050A2006	542	FSF 050A4004	543	FUE 050A1001	541
FSE 050A3020	543	FSF 050B1001	548	FUE 050A1002	540
FSE 050A4003	542	FSF 050B1005	547	FUE 050A1003	540
FSE 050A4004	543	FSF 050B1007	547	FUE 050A1008	541
FSE 050A4006	542	FSF 050B2001	548	FUE 050A1011	541
FSE 050B1001	547	FSF 050B2002	547	FUE 050A2001	541
FSE 050B1003	548	FSF 050B2005	547	FUE 050A2002	540
FSE 050B1007	547	FSF 050B2006	547	FUE 050A2003	540
FSE 050B2001	547	FSF 050B4002	547	FUE 050A2004	540
FSE 050B2002	547	FSF 050B4003	547	FUE 050A2008	541
FSE 050B2003	548	FSF 050B4004	548	FUE 050A2011	541
FSE 050B2006	547	FSF 100A1001	543	FUE 050A3001	541
FSE 050B4003	547	FSF 100A1002	542	FUE 050A4003	541
FSE 050B4004	548	FSF 100A1005	542	FUE 050A4004	540
FSE 050B4006	547	FSF 100A2001	543	FUE 050A4005	540
FSE 100A1001	542	FSF 100A2002	542	FUE 050B1001	546
FSE 100A1003	543	FSF 100A2004	542	FUE 050B1002	545
FSE 100A1006	542	FSF 100A2005	542	FUE 050B1003	545
FSE 100A2001	542	FSF 100A3020	543	FUE 050B1008	546
FSE 100A2002	542	FSF 100A3021	543	FUE 050B1011	546
FSE 100A2003	543	FSF 100A3022	543	FUE 050B2001	546
FSE 100A2006	542	FSF 100A4002	542	FUE 050B2002	545
FSE 100A3020	543	FSF 100A4003	542	FUE 050B2003	545
FSE 100A4003	542	FSF 100A4004	543	FUE 050B2004	545

order reference	page
FUE 050B2008	546
FUE 050B2011	546
FUE 050B3001	546
FUE 050B4003	545
FUE 050B4004	546
FUE 050B4005	545
FUE 050C2Y10	490
FUE 100A1001	541
FUE 100A1002	540
FUE 100A1003	540
FUE 100A1008	541
FUE 100A1011	541
FUE 100A2001	541
FUE 100A2002	540
FUE 100A2003	540
FUE 100A2004	540
FUE 100A2008	541
FUE 100A2011	541
FUE 100A3001	541
FUE 100A4003	541
FUE 100A4004	540
FUE 100A4005	540
FUE 200C1003	486
FUE 200C1004	487
FUE 200C1012	488
FUE 200C2003	491
FUE 200C2004	492
FUE 200C2Y00	493
FUE 200C4Y00	495
FUE 200C6Y00	496
FUE 200D1Y00	489
FUE 200D2Y00	494
FUE 200E1Y00	497
FUE 200F1Y00	498
FUF 025B1001	546
FUF 025B1002	546
FUF 025B1003	545
FUF 025B1005	545
FUF 025B1011	546
FUF 025B2001	546
FUF 025B2002	546
FUF 025B2003	545
FUF 025B2004	545
FUF 025B2005	545
FUF 025B2011	546
FUF 025B3001	546
FUF 025B4002	546
FUF 025B4006	545
FUF 025B4008	545
FUF 050A1001	541
FUF 050A1003	541
FUF 050A1005	540
FUF 050A1007	540
FUF 050A1011	541
FUF 050A2001	541
FUF 050A2003	541
FUF 050A2004	540
FUF 050A2005	540
FUF 050A2007	540
FUF 050A2011	541
FUF 050A3001	541
FUF 050A4002	541
FUF 050A4004	540
FUF 050A4005	540
FUF 050B1001	546
FUF 050B1002	546
FUF 050B1003	545
FUF 050B1005	545
FUF 050B1011	546

order reference	page
FUF 050B2001	546
FUF 050B2002	546
FUF 050B2003	545
FUF 050B2004	545
FUF 050B2005	545
FUF 050B2011	546
FUF 050B3001	546
FUF 050B4002	546
FUF 050B4006	545
FUF 050B4008	545
FUF 100A1001	541
FUF 100A1003	541
FUF 100A1005	540
FUF 100A1007	540
FUF 100A1011	541
FUF 100A2001	541
FUF 100A2003	541
FUF 100A2004	540
FUF 100A2005	540
FUF 100A2007	540
FUF 100A2011	541
FUF 100A3001	541
FUF 100A4002	541
FUF 100A4004	540
FUF 100A4005	540
FUH 010A2002	540
FUH 010B2001	545
FUH 010B2002	545
FUL 200D2Y00	499, 564
FUL 500D2Y00	500
FVDK 10N5101	462
FVDK 10N5101/S35A	462
FVDK 10N66Y0	467
FVDK 10N66Y0/S35A	467
FVDK 10N66YM	466
FVDK 10N66YR	467
FVDK 10N66YS	466
FVDK 10N67Y0	470
FVDK 10N67Y0/S35A	470
FVDK 10N67Y2	468
FVDK 10N67YM	469
FVDK 10N67YR	470
FVDK 10N67YS	469
FVDK 10N81Y0	471
FVDK 10N83Y0	471
FVDK 10P5101	462
FVDK 10P5101/S35A	462
FVDK 10P66Y0	467
FVDK 10P66Y0/S35A	467
FVDK 10P66YM	466
FVDK 10P66YR	467
FVDK 10P66YS	466
FVDK 10P67Y0	470
FVDK 10P67Y0/KS35A	470
FVDK 10P67Y0/S35A	470
FVDK 10P67Y2/S35A	468
FVDK 10P67YM	469
FVDK 10P67YR	470
FVDK 10P67YS	469
FVDK 10P81Y0	471
FVDK 10P81Y0/KS35A	471
FVDK 10P83Y0	471
FVDK 10P83Y0/KS35A	471
FVDK 12P6101	463
FVDK 12P6101/S35A	463
FVDK 12P6401	463
FVDK 12P6401/S35A	463
FVDK 12P6410/S35A	464
FVDK 12P6501/S35A	463

order reference	page
FVDK 22P6101	465
FVDK 22P6101/S14C	465
FVDK 22P6401	465
FVDK 22P6401/S14C	465
FVDK 22P6501/S14C	465
FVDM 15N5103	544
FVDM 15N5103/S14	544
FVDM 15P5103	544
FVDM 15P5103/S14	544
FVDM 15P5130	544
FVDM 15P5130/S14	544
FWDK 10U84Y0	472
FWE 200C1Y00	529
FWE 200C2Y00	530
FZAM 08P1001	388
FZAM 08P1001/S35L	388
FZAM 08P1002	388
FZAM 08P1002/S35L	388
FZAM 08P3001	388
FZAM 08P3001/S35L	388
FZAM 08P3002	388
FZAM 08P3002/S35L	388
FZAM 12N1104/S14	390
FZAM 12N3104	390
FZAM 12N3104/S14	390
FZAM 12P1104	390
FZAM 12P1104/S14	390
FZAM 12P3104	390
FZAM 12P3104/S14	390
FZAM 18N1150	398, 537
FZAM 18N1150/S14	398, 537
FZAM 18N1155	396, 536
FZAM 18N6460	394, 538
FZAM 18N6460/S14	394, 538
FZAM 18P1150	398, 537
FZAM 18P1150/S14	398, 537
FZAM 18P1155	396, 536
FZAM 18P6460	394, 538
FZAM 18P6460/S14	394, 538
FZAM 30N5002	400
FZAM 30N5004	539
FZAM 30P5001	539
FZAM 30P5002	400
FZAM 30P5003	400
FZAM 30P5004	539
FZCK 07N6901	370
FZCK 07N6901/KS35A	370
FZCK 07P6901	370
FZCK 07P6901/KS35A	370
FZDK 07N6901	372
FZDK 07N6901/KS35A	372
FZDK 07P6901	372
FZDK 07P6901/KS35A	372
FZDK 10N1101/KS35	376
FZDK 10N5101	376
FZDK 10N5101/S35A	376
FZDK 10P1101/KS35	376
FZDK 10P5101	376
FZDK 10P5101/S35A	376
FZDK 14N5101	378
FZDK 14N5101/S35A	378
FZDK 14P5101	378
FZDK 14P5101/S14	378
FZDK 14P5101/S35A	378
FZDK 20N5101/S35A	382
FZDK 20P5101/S35A	382
FZDM 08P1001	374
FZDM 08P1001/S35L	374
FZDM 08P1002	374

order reference	page	order reference	page	order reference	page
FZDM 08P1002/S35L	374	O300.GR-11199072	292	O300H.GP-11127745	348
FZDM 08P3001	374	O300.RL-11172767	128	O300H.GP-11157157	348
FZDM 08P3001/S35L	374	O300.RL-11172769	128	O300H.RL-11172813	130
FZDM 08P3002	374	O300.RL-11172800	128	O300H.RL-11172814	130
FZDM 08P3002/S35L	374	O300.RL-11172801	128	O300H.RP.T-11157335	144
FZDM 16N5101	380	O300.RL-11172802	128	O300H.RP.T-11157337	144
FZDM 16N5101/S14	380	O300.RL-11172803	128	O300H.RP-11127716	164
FZDM 16P5101	380	O300.RP.T-11157331	140	O300H.RP-11157327	164
FZDM 16P5101/S14	380	O300.RP.T-11157334	140	O300H.SL-11179007	52
<b>H</b>		O300.RP-11110445	107	O300H.SL-11179008	52
HI17-1H	757	O300.RP-11110446	107	O300H.SP.T-11136925	60
<b>O</b>		O300.RP-11110447	107	O300H.SP.T-11136926	60
O300.DI-11199080	686	O300.RP-11110448	107	O300H.SP-11127754	76
O300.DI-11199081	686	O300.RP-11110449	107	O300H.SP-11136904	76
O300.DL-11199078	688	O300.RP-11120107	107	O300H.TL-11181225	217
O300.DL-11199079	688	O300.RP-11120110	107	O300H.TL-11181227	217
O300.DP-11199076	690	O300.RP-11120112	107	O300H.TR-11167291	226
O300.DP-11199077	690	O300.RP-11120120	107	O300H.TR-11167292	226
O300.EL-11176842	209	O300.RP-11120121	107	O300W.EL-11181085	213
O300.EL-11176843	209	O300.RP-11120129	107	O300W.ER-11167301	224
O300.EL-11181069	209	O300.RP-11143019	107	O300W.GL-11171770	328
O300.EL-11181080	209	O300.RR-11110443	110	O300W.GP-11127755	346
O300.EL-11181081	209	O300.RR-11110444	110	O300W.RL-11172815	132
O300.EL-11181082	209	O300.RR-11120114	110	O300W.RP.T-11157338	142
O300.ER-11128044	198	O300.RR-11120118	110	O300W.RP-11127720	162
O300.ER-11128047	198	O300.SL-11176826	46	O300W.SP-11179009	50
O300.ER-11128055	198	O300.SL-11176827	46	O300W.SP.T-11136922	58
O300.ER-11167265	198	O300.SL-11179003	46	O300W.SP-11127758	74
O300.ER-11167266	198	O300.SL-11179004	46	O300W.TL-11181228	213
O300.ER-11167267	198	O300.SL-11179005	46	O300W.TR-11167300	224
O300.GI-11121712	294	O300.SL-11179006	46	O500.DI-11199084	692
O300.GI-11128081	294	O300.SL-11199074	48	O500.DI-11199085	692
O300.GL-11171740	322	O300.SP.T-11136905	56	O500.DP-11199082	694
O300.GL-11171741	322	O300.SP.T-11136906	56	O500.DP-11199083	694
O300.GL-11171742	322	O300.SP-11110450	31	O500.ER-11128072	202
O300.GL-11171743	322	O300.SP-11110451	31	O500.ER-11128075	202
O300.GL-11171745	322	O300.SP-11110453	31	O500.ER-11128078	202
O300.GL-11171747	322	O300.SP-11120122	31	O500.ER-11167280	202
O300.GL-11171748	322	O300.SP-11120123	31	O500.ER-11167281	202
O300.GL-11196492	324	O300.SP-11120126	31	O500.ER-11167282	202
O300.GL-11199070	324	O300.SP-11120126	31	O500.ER-11167283	202
O300.GP-11110415	286	O300.SP-11125057	31	O500.GI-11120203	306
O300.GP-11110441	286	O300.SP-11125077	31	O500.GI-11128082	306
O300.GP-11110442	286	O300.SP-11135851	31	O500.GP-11096064	302
O300.GP-11120101	286	O300.SP-11135852	31	O500.GP-11096065	302
O300.GP-11120103	286	O300.SP-11135854	31	O500.GP-11096066	302
O300.GP-11120104	286	O300.SP-11135855	31	O500.GP-11096067	302
O300.GP-11125023	286	O300.SP-11135855	31	O500.GP-11096068	302
O300.GP-11125058	286	O300.SP-11139109	31	O500.GP-11096069	302
O300.GP-11135827	286	O300.SP-11140097	31	O500.GP-11125079	302
O300.GP-11135828	286	O300.SP-11199073	34	O500.GP-11125084	302
O300.GP-11135829	286	O300.SP-11199086	34	O500.GP-11135857	302
O300.GP-11135850	286	O300.TL-11176844	209	O500.GP-11135859	302
O300.GP-11143644	286	O300.TL-11176845	209	O500.GP-11135861	302
O300.GP-11147416	286	O300.TR-11128022	198	O500.GP-11135862	302
O300.GP-11199038	288	O300.TR-11167264	198	O500.GR-11096062	304
O300.GP-11199039	288	O300.ZL-11176829	408	O500.GR-11096063	304
O300.GR-11110414	290	O300.ZL-11176840	408	O500.GR-11123121	304
O300.GR-11120106	290	O300.ZL-11181086	408	O500.GR-11123131	304
O300.GR-11128552	290	O300.ZL-11181087	408	O500.GR-11135863	304
O300.GR-11135876	290	O300.ZL-11181088	408	O500.GR-11135864	304
O300.GR-11135879	290	O300.ZL-11181089	408	O500.GR-11135886	304
O300.GR-11135880	290	O300.ZR-11128014	384	O500.GR-11135888	304
O300.GR-11135881	290	O300.ZR-11128017	384	O500.GR-11135889	304
O300.GR-11135882	290	O300H.EL-11181083	217	O500.GR-11135891	304
O300.GR-11135883	290	O300H.EL-11181084	217	O500.RP.T-11157339	152
O300.GR-11135885	290	O300H.ER-11167293	226	O500.RP.T-11157351	152
O300.GR-11199071	292	O300H.ER-11167294	226	O500.RP-11096094	114
		O300H.GL-11171768	326	O500.RP-11096096	114
		O300H.GL-11171769	326	O500.RP-11096098	114



order reference	page	order reference	page	order reference	page
O500.RP-11096099	114	OADM 13I7580/S35A	630	OEDK 14P5101/S35A	220
O500.RP-11096101	114	OADM 13I7730/S35A	639	OGUM 030P8001/S35L	251
O500.RP-11096103	114	OADM 13I7745/S35A	639	OGUM 030P8002/S35L	250
O500.RR-11096090	116	OADM 13I7760/S35A	639	OGUM 050P8001/S35L	253
O500.RR-11096091	116	OADM 13S6475/S35A	636	OGUM 050P8002/S35L	252
O500.RR-11096092	116	OADM 13S6575/S35A	636	OGUM 080P8001/S35L	255
O500.RR-11096093	116	OADM 13S7480/S35A	636	OGUM 080P8002/S35L	254
O500.SP.T-11136920	68	OADM 13S7580/S35A	636	OGUM 120P8001/S35L	257
O500.SP.T-11136921	68	OADM 13T6475/S35A	634	OGUM 120P8002/S35L	256
O500.SP-11096080	41	OADM 13T6575/S35A	634	OHDK 10N5101	316
O500.SP-11096081	41	OADM 13T7480/S35A	634	OHDK 10N5101/S35A	316
O500.SP-11096083	41	OADM 13T7580/S35A	634	OHDK 10N5150/S35A	318
O500.SP-11096085	41	OADM 13U6475/S35A	632	OHDK 10P5101	316
O500.SP-11096086	41	OADM 13U6575/S35A	632	OHDK 10P5101/S35A	316
O500.SP-11096088	41	OADM 13U7480/S35A	632	OHDK 10P5150/S35A	318
O500.SP-11125082	41	OADM 13U7580/S35A	632	OHDK 14N5101	332
O500.SP-11125089	41	OADM 13U7730/S35A	643	OHDK 14N5101/S14	332
O500.SP-11135865	41	OADM 13U7745/S35A	643	OHDK 14N5101/S35A	332
O500.SP-11135866	41	OADM 13U7760/S35A	643	OHDK 14P5101	332
O500.SP-11135867	41	OADM 20I2441/S14C	646	OHDK 14P5101/S14	332
O500.SP-11135869	41	OADM 20I2460/S14C	646	OHDK 14P5101/S35A	332
O500.SP-11139106	41	OADM 20I2472/S14C	648	OHDK 25G6911	342
O500.TR-11128041	202	OADM 20I2480/S14C	648	OHDK 25G6911/S14	342
O500.TR-11167269	202	OADM 20I6441/S14F	651	OHDK 25G6912	342
O500.ZR-11128018	386	OADM 20I6460/S14F	651	OHDK 25G6912/S14C	342
O500.ZR-11128020	386	OADM 20I6472/S14F	651	OHDK 25G6921	340
O500H.ER-11167297	230	OADM 20I6480/S14F	654	OHDK 25G6921/S14	340
O500H.ER-11167299	230	OADM 20I6481/S14F	654	OHDM 12N6901/S35A	320
O500H.GP-11125101	354	OADM 20I6541/S14F	651	OHDM 12P6901/S35A	320
O500H.GP-11125102	354	OADM 20I6560/S14F	651	OHDM 13N6901/S35A	330
O500H.RP.T-11157354	156	OADM 20I6572/S14F	651	OHDM 13P6901/S35A	330
O500H.RP.T-11157356	156	OADM 20I6580/S14F	654	OHDM 13P6951/S35A	330
O500H.RP-11107831	174	OADM 20I6581/S14F	654	OHDM 16N5001	334
O500H.RP-11107832	174	OADM 20I6591	656	OHDM 16N5001/S14	334
O500H.SP.T-11136929	72	OADM 20I6592	656	OHDM 16N5651	336
O500H.SP.T-11136930	72	OADM 20I6593	656	OHDM 16P5001	334
O500H.SP-11125106	86	OADM 20U2441/S14C	646	OHDM 16P5001/S14	334
O500H.SP-11125107	86	OADM 20U2460/S14C	646	OHDM 16P5002/S14	334
O500H.TR-11167295	230	OADM 20U2472/S14C	648	OHDM 16P5012	334
O500H.TR-11167296	230	OADM 20U2480/S14C	648	OHDM 16P5012/S14	334
O500W.ER-11167303	228	OADM 21I6480/S14F	662	OHDM 16P5651	336
O500W.GP-11125092	356	OADM 21I6481/S14F	662	OHDM 20P6990/S14C	338
O500W.GP-11137000	358	OADM 21I6580/S14F	662	OM70-11111994	672
O500W.RP.T-11157357	154	OADM 21I6581/S14F	662	OM70-11112012	666
O500W.RP-11107745	170	OADM 250I1101/S14C	682	OM70-11112013	674
O500W.RP-11125066	172	OADM 250U1101/S14C	682	OM70-11112015	668
O500W.SP.T-11136924	70	OADM 260I1101/S14C	684	OM70-11112017	664
O500W.SP-11125098	82	OADR 20I6465/S14F	659	OM70-11112018	670
O500W.SP-11137002	84	OADR 20I6475/S14F	659	OM70-11112019	664
O500W.SP-11137003	84	OADR 20I6485/S14F	659	OM70-11112060	670
O500W.TR-11167302	228	OADR 20I6565/S14F	659	OM70-11112061	664
OADK 25I7480	708	OADR 20I6575/S14F	659	OM70-11112064	672
OADK 25I7480/S14C	708	OADR 20I6585/S14F	659	OM70-11112065	666
OADK 25U7480	708	OBDM 12N6910/S35A	448	OM70-11112066	674
OADK 25U7480/S14C	708	OBDM 12N6920/S35A	449	OM70-11112067	668
OADM 12I6430/S35A	624	OBDM 12N6930/S35A	450	OM70-11112069	678
OADM 12I6460/S35A	624	OBDM 12N6940/S35A	451	OM70-11155463	676
OADM 12I7430/S35A	626	OBDM 12N6950/S35A	452	OM70-11185168	680
OADM 12I7460/S35A	626	OBDM 12P6910/S35A	448	OM70-11195785	670
OADM 12S7430/S35A	628	OBDM 12P6920/S35A	449	OM70-11195787	672
OADM 12S7440/S35A	628	OBDM 12P6930/S35A	450	OM70-11195788	666
OADM 12S7460/S35A	628	OBDM 12P6940/S35A	451	OM70-11199089	674
OADM 12U6430/S35A	624	OBDM 12P6950/S35A	452	OM70-11199100	668
OADM 12U6460/S35A	624	OEDK 10N5105	206	OM70-11199108	674
OADM 12U7430/S35A	626	OEDK 10N5105/S35A	206	OM70-11199109	668
OADM 12U7460/S35A	626	OEDK 10P5105	206	OM70-11200058	664
OADM 13I6475/S35A	630	OEDK 10P5105/S35A	206	OM70-11200060	670
OADM 13I6575/S35A	630	OEDK 14P5101	220	OM70-11200061	670
OADM 13I7480/S35A	630	OEDK 14P5101/S14	220	OM70-11200062	664

order reference	page	order reference	page	order reference	page
OM70-11200063	670	OR18.RR-11157780	124	OZDM 16P1901	414, 438
OM70-11200064	664	OR18.RR-11157781	124	OZDM 16P1901/S14	414, 438
OM70-11200065	670	OR18.RR-11157782	124	OZDM 16P3001	412, 440
OM70-11200066	664	OR18.RR-11157783	124	OZDM 16P3001/S14	412, 440
OM70-11200067	670	OR18.SP-11128095	44	<b>V</b>	
OM70-11200068	664	OR18.SP-11129340	44	VS CS100M03I10EP	729
OM70-11200069	674	OR18.SP-11129342	44	VS CS100M03I16EP	729
OM70-11200090	668	OR18.TI-11157821	204	VS CS100M03W10EP	729
OM70-11200091	674	OR18.TI-11157823	204	VS CS100M03W16EP	729
OM70-11200095	668	OR18.TI-11157825	204	VS ID100M03W10RP	729
OM70T-11175094	670	OR18.TL-11157829	222	VS ID100M03W16RP	729
OM70T-11175097	664	OR18.TL-11157840	222	VS ID510M03I12IP	729
OM70T-11175099	670	OR18.ZI-11157790	392	VS ID510M03W12IP	729
OM70T-11175110	664	OR18.ZI-11157791	392	VS XC700C03X00IP	731
OM70T-11175113	664	OR18.ZI-11157792	392	VS XC700C12X00IP	731
OM70T-11195786	670	OR18.ZI-11157793	392	VS XC700M03X00IP	731
ONDK 25G6911	54	OR18.ZI-11157794	392	VS XC700M12X00IP	731
ONDK 25G6911/S14	54	OR18.ZI-11157795	392	VS XC700M20X00IP	731
OPDK 14P1902	148	OR18.ZI-11157796	392	VS XC800C03X00IP	731
OPDK 14P1902/S14	148	OR18.ZI-11157797	392	VS XC800C12X00IP	731
OPDK 14P1902/S35A	148	OR18.ZI-11157798	392	VS XC800M03X00IP	731
OPDK 14P1903	148	OR18.ZI-11157799	392	VS XC800M12X00IP	731
OPDK 14P1903/S14	148	OR18.ZI-11157800	392	VS XC800M20X00IP	731
OPDK 14P1903/S35A	148	OR18.ZI-11157801	392	VS XF105M03I10EP	733
OPDK 14P3902	148	OR18.ZL-11157802	416	VS XF105M03I16EP	733
OPDK 14P3902/S14	148	OR18.ZL-11157803	416	VS XF105M03W10EP	733
OPDK 14P3902/S35A	148	OR18.ZL-11157805	416	VS XF205M03I10EP	733
OPDK 14P3903	148	OR18.ZL-11157806	416	VS XF205M03W10EP	733
OPDK 14P3903/S14	148	OR18W.El-11157851	232	VS XF205M03W16EP	733
OPDK 14P3903/S35A	148	OR18W.El-11157854	232	VS XF700C03W12IP	729
OPDK 14P5901	134	OR18W.GR-11157856	360	VS XF700C03W16IP	729
OPDK 14P5901/S14	134	OR18W.GR-11157857	360	VS XF700M03I12IP	729
OPDK 14P5901/S35A	134	OR18W.RR.T-11157845	160	VS XF700M03I16IP	729
OPDM 12N5101/S35A	126	OR18W.RR.T-11157846	160	VS XF700M03W12IP	729
OPDM 12P5101	126	OR18W.RR-11157843	176	VS XF700M03W16IP	729
OPDM 12P5101/S35A	126	OR18W.RR-11157844	176	VS XF800C03W12IP	729
OPDM 12P5102/S35A	126	OR18W.TI-11157855	232	VS XF800C03W16IP	729
OPDM 12P5103/S35A	126	OR18W.ZI-11157847	402	VS XF800M03I12IP	729
OPDM 12P5104/S35A	126	OR18W.ZI-11157848	402	VS XF800M03I16IP	729
OPDM 16P5102	136	OR18W.ZI-11157849	402	VS XF800M03W12IP	729
OPDM 16P5102/S14	136	OR18W.ZI-11157850	402	VS XF800M03W16IP	729
OPDM 16P5103/S14	136	OSDK 10D9005	206	<b>Z</b>	
OR18.El-11157811	204	OSDK 10D9005/S35A	206	ZADM 023H151.0001	579
OR18.El-11157812	204	OSDK 14D9001	220	ZADM 023H151.0002	579
OR18.El-11157813	204	OSDK 14D9001/S14	220	ZADM 023H151.0011	579
OR18.El-11157814	204	OSDK 14D9001/S35A	220	ZADM 023H151.0012	579
OR18.El-11157815	204	OXC7-11170024	721	ZADM 023H300.0001	579
OR18.El-11157816	204	OXE7.E15T-11148276	575, 715	ZADM 023H300.0002	579
OR18.El-11157817	222	OXE7.E15T-11177353	575, 715	ZADM 023H300.0011	579
OR18.El-11157818	222	OXE7.E25T-11111452	575, 715	ZADM 023H300.0012	579
OR18.El-11157819	222	OXE7.E25T-11174280	575, 715	ZADM 023H351.0001	579
OR18.El-11157820	222	OXH7-11159406	719	ZADM 023H351.0002	579
OR18.GP-11128094	310	OXH7-11161809	717	ZADM 023H351.0011	579
OR18.GP-11129323	310	OZDK 10N5101	404, 434	ZADM 023H351.0012	579
OR18.GP-11129327	310	OZDK 10N5101/S35A	404, 434	ZADM 023H351.0021	579
OR18.GR.F-11157807	314	OZDK 10N5150	406, 432	ZADM 023H351.0022	579
OR18.GR.F-11157808	314	OZDK 10N5150/S35A	406, 432	ZADM 023H871.0001	582
OR18.GR.F-11157809	314	OZDK 10P5101	404, 434	ZADM 023H871.0002	582
OR18.GR.F-11157810	314	OZDK 10P5101/S35A	404, 434	ZADM 023H871.0011	582
OR18.GR-11157841	312	OZDK 10P5150	406, 432	ZADM 034I220.0021	586
OR18.GR-11157842	312	OZDK 10P5150/S35A	406, 432	ZADM 034I220.0022	586
OR18.RL-11157784	138	OZDK 14N1901/S14	410, 436	ZADM 034I240.0001	584
OR18.RL-11157785	138	OZDK 14P1901	410, 436	ZADM 034I240.0021	584
OR18.RL-11157786	138	OZDK 14P1901/S14	410, 436	ZADM 034P240.6901	588
OR18.RL-11157787	138	OZDK 14P1901/S35A	410, 436	ZADM 034P240.6921	588
OR18.RR.T-11157788	158	OZDM 16N1001	412, 440	Z-FTDF 005I0100	746
OR18.RR.T-11157789	158	OZDM 16N1001/S14	412, 440	Z-FTDF 005I0500	746
OR18.RR-11157680	124	OZDM 16P1001	412, 440	Z-FTDF 005I1000	746
OR18.RR-11157768	124	OZDM 16P1001/S14	412, 440	Z-FTDF 005I1600	746



order reference	page
Z-FTDF 020I0100	746
Z-FTDF 020I0180	746
Z-FTDF 020I0500	746
Z-FTDF 020I1000	746
Z-FTDF 020I1600	746
Z-FTDF 035I0100	746
Z-FTDF 035I0500	746

order reference	page
Z-FTDF 035I1000	746
Z-FTDF 035I1600	746
Z-FTDF 050I0100	746
Z-FTDF 050I0500	746
Z-FTDF 050I1000	746
Z-FTDF 050I1600	746
Z-FTDF 050K0100	747

order reference	page
Z-FTDF 050K0500	747
Z-FTDF 050K1000	747
Z-FTDF 050K9999	747
Z-FTDF 610I0100	747
Z-FTDF 610I0500	747
Z-FTDF 610I1000	747
Z-FTDF 610I1600	747

# Baumer – the strong partner.

We at Baumer are close to our customers, understand their needs and provide the best solution. Worldwide customer service for Baumer starts with on-the-spot personal discussions and qualified consultation. Our application engineers speak your language and strive from the start, through an interactive problem analysis, to offer comprehensive and user-compatible solutions.

## We are close to you across the globe.

The worldwide Baumer sales organizations guarantee short delivery times and readiness to supply. Many of our customers are directly linked via our electronic order system with the JIT logistics process.

A worldwide network coupled with the most modern communication techniques enable us to deliver information quickly and transparently to decision makers in all Baumer locations.

Closeness to the customer for Baumer means being available for your needs anywhere and at any time.



# Worldwide presence.



## Africa

Algeria  
Cameroon  
Côte d'Ivoire  
Egypt  
Morocco  
Reunion  
South Africa

## America

Brazil  
Canada  
Colombia  
Mexico  
United States  
Venezuela

## Asia

Bahrain  
China  
India  
Indonesia  
Israel  
Japan  
Kuwait  
Malaysia  
Oman  
Philippines  
Qatar  
Saudi Arabia  
Singapore  
South Korea  
Taiwan  
Thailand  
UAE

## Europe

Austria  
Belgium  
Bulgaria  
Croatia  
Czech Republic  
Denmark  
Finland  
France  
Germany  
Greece  
Hungary  
Italy  
Malta  
Martinique  
Netherlands  
Norway  
Poland  
Portugal  
Romania  
Russia  
Serbia  
Slovakia  
Slovenia  
Spain  
Sweden  
Switzerland  
Turkey  
United Kingdom

## Oceania

Australia  
New Zealand



For more information  
about our worldwide  
locations go to:  
[www.baumer.com/worldwide](http://www.baumer.com/worldwide)

# Our overall portfolio

Baumer provides for every application the perfect solution.

## Presence detection

- Inductive sensors
- Photoelectric sensors
- Ultrasonic sensors
- Capacitive sensors
- Magnetic sensors
- Mechanical precision switches

## Distance measurement

- Inductive sensors
- Photoelectric sensors
- Ultrasonic sensors
- Bearingless linear encoders
- Cable-pull encoders

## Rotary encoders / Angle measurement

- Absolute encoders
- Incremental encoders
- HeavyDuty encoders
- Bearingless encoders
- Format alignment
- Inclination sensors

## Identification / Image processing

- Industrial Cameras
- Vision Sensors

## Process instrumentation

- Level measurement
- Temperature measurement
- Pressure measurement
- Conductivity measurement
- Force/strain sensors
- Counters
- Process displays



**Baumer Group**  
International Sales  
P.O. Box · Hummelstrasse 17 · CH-8501 Frauenfeld  
Phone +41 52 728 1122 · Fax +41 52 728 1144  
sales@baumer.com · www.baumer.com

Represented by: