

Distance sensors

OADM 20I6481/S14F

dimension drawing

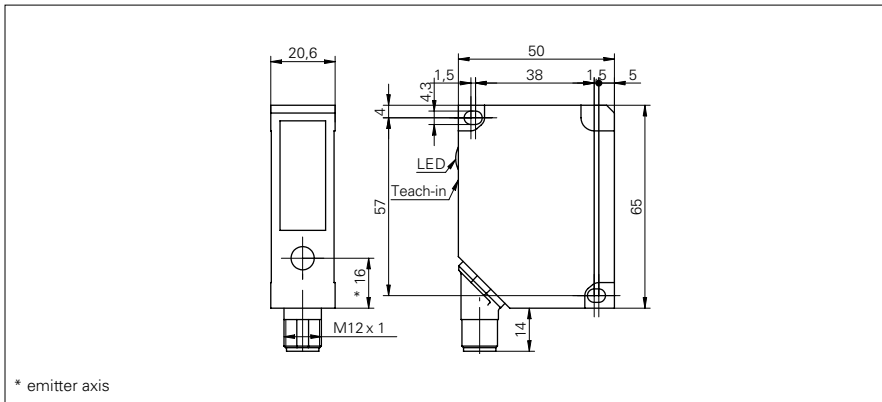

general data

measuring distance Sd	200 ... 1000 mm
adjustment	Teach-in: button / external
Teach-in range min.	> 20 mm
power on indication	LED green
soiled lens indicator	LED red
resolution	0,12 ... 2,5 mm
linearity error	± 0,48 ... ± 10 mm
light source	pulsed red laser diode
wave length	650 nm
laser class	2
beam type	point
beam diameter	2 mm
temperature drift	< 0,06 % Sde/K

electrical data

response time / release time	< 0,9 ms
voltage supply range +Vs	12 ... 28 VDC
current consumption max. (no load)	100 mA
output circuit	analog
output signal	4 ... 20 mA / 0 ... 10 VDC
load resistance (analog I)	< (+Vs - 6 V) / 0,02 A
load resistance (analog U)	> 100 kOhm
output current	< 100 mA
alarm output	PNP
short circuit protection	yes
reverse polarity protection	yes, Vs to GND

mechanical data

width / diameter	20,6 mm
height / length	65 mm
depth	50 mm
type	rectangular
housing material	die-cast zinc
front (optics)	glass
connection types	connector M12 8 pin, rotatable

photo



connection diagram

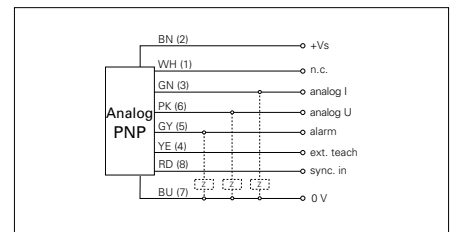

laser warning

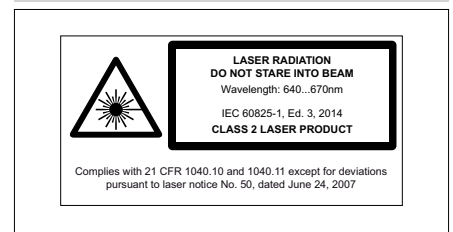

Distance sensors**OADM 20I6481/S14F****ambient conditions**

ambient light immunity	< 5 kLux
operating temperature	0 ... +50 °C
protection class	IP 67