

TX4S Series

LCD Display PID Control Temperature Controller

NEW



White Character LCD

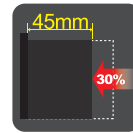

Reduced Depth



11-Segment Display



Various Output Options
(Relay/SSR/Current/Alarm/Communication)



High-Speed Sampling

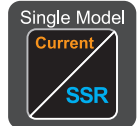

Selectable Output

Features

Large LCD Display with Easy-to-Read White PV Characters

Large LCD display with 15.3 mm white PV characters provides high visibility in various environment.

Bright environment

Dark environment



The display highly visible from various viewing angles.



Compact Sized Design with 45mm Rear-Length

Minimized installation-space requirements by reducing the depth size by 30% compared to similar-sized Autonics models (48×48mm models).



11-Segment Display Provides Improved Readability

11-segment displays used for PV and SV provide improved readability of alphanumeric characters.

7-Segment display

TX4S



LCD Display PID Control

• 50ms High-Speed Sampling Cycle

50ms high-speed sampling rate allows accurate temperature control in applications requiring fast response speeds.



• Switch Between Current Output and SSR Drive Output

Users can select between current output and SSR drive output through parameter settings of a single unit.

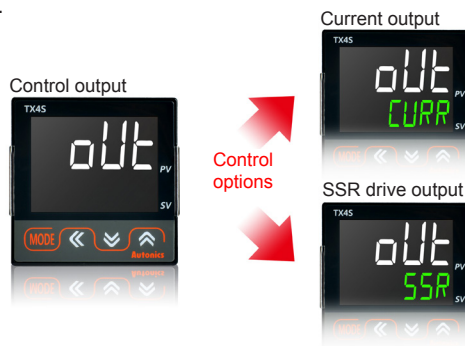

• SSR Drive Output (SSRP Function) Control Options

Users can select from ON/OFF control, cycle control, and phase control using standard SSR drive output option. Precise and accurate control is possible at low costs.

SSR drive output method



Control options

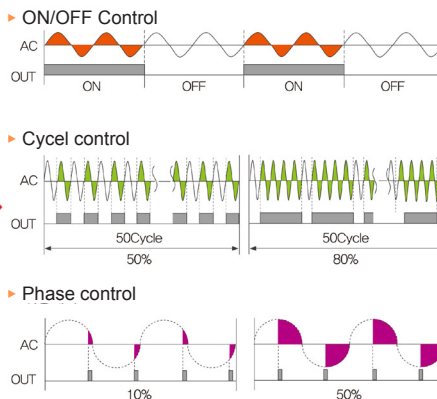

■ Application

Accurate Temperature Control of Commercial Coffee Roasters



(A)	Photoelectric Sensors
(B)	Fiber Optic Sensors
(C)	Door/Area Sensors
(D)	Proximity Sensors
(E)	Pressure Sensors
(F)	Rotary Encoders
(G)	Connectors/ Sockets
(H)	Temperature Controllers
(I)	SSRs / Power Controllers
(J)	Counters
(K)	Timers
(L)	Panel Meters
(M)	Tacho / Speed / Pulse Meters
(N)	Display Units
(O)	Sensor Controllers
(P)	Switching Mode Power Supplies
(Q)	Stepper Motors & Drivers & Controllers
(R)	Graphic/ Logic Panels
(S)	Field Network Devices
(T)	Software

TX4S Series

LCD Display PID Control

NEW

■ Features

- Super high-speed sampling with 50ms
- Improved visibility with LCD display
- Communication function supported: RS485(Modbus RTU)
- **Convenient parameter setting** (RS485 communication)
 - : Free download the comprehensive device management program(DAQMaster)
- SSR drive output / Current output selectable
- SSRP output (standard/phase/cycle control selectable)
- Mounting space saving with compact design
 - : downsized by approx. 30% in depth compared with same size of other Series(panel back length: 60mm)
 - ※ Terminal cover, sold separately: RSA-COVER



⚠ Please read "Caution for your safety" in operation manual before using.



■ Comprehensive Device Management Program (DAQMaster)

- DAQMaster is comprehensive device management program. It is available for parameter setting, monitoring.
- Visit our website (www.autonics.com) to download user manual and comprehensive device management program.

< Computer specification for using software >

Item	Minimum requirements
System	IBM PC compatible computer with Intel Pentium III or above
Operating system	Microsoft Windows 98/NT/XP/Vista/7/8/10
Memory	256MB or more
Hard disk	More than 1GB of free hard disk space
VGA	1024×768 or higher resolution display
Others	RS-232 serial port (9-pin), USB port

< DAQMaster screen >







■ Ordering Information

TX 4 S - 1 4 R

Control output	R	Relay output
	S	SSR drive output
	C	Selectable current output or SSR drive output
Power supply	4	100-240VAC 50/60Hz
Option output	1	Alarm output 1
	2	Alarm output 1+Alarm output 2
	A	Alarm output 1+Alarm output 2+Trans. output
	B	Alarm output 1+Alarm output 2+RS485 com. output
Size	S	DIN W48×H48mm
Digit	4	9999(4digit)
Item	TX	LCD display standard PID temperature controller

LCD Display PID Control

■ Specifications

Series		TX4S
Power supply		100-240VAC 50/60Hz
Allowable voltage range		90 to 110% of rated voltage
Power consumption		Max. 8VA
Display method		11 segments (PV: white, SV: green), other display (yellow) with LCD method ^{※1}
Character size	PV(W×H)	6.9×15.3mm
	SV(W×H)	4.1×9.2mm
Input type	RTD	DPT100Ω, Cu50Ω (permissible line resistance max. 5Ω)
	TC	K(CA), J(IC), L(IC), T(CC), R(PR), S(PR)
Display accuracy ^{※2}	RTD	●At room temperature (23°C±5°C): (PV ±0.3% or ±1°C, select the higher one) ±1digit
	TC	●Out of room temperature: (PV ±0.5% or ±2°C, select the higher one) ±1digit
Control output	Relay	250VAC 3A 1a
	SSR	Max. 12VDC ± 2V 20mA
	Current	DC4-20mA or DC0-20mA (load resistance max. 500Ω)
Option output	Alarm output	AL1, AL2 Relay: 250VAC 3A 1a
	Trans. output	DC4-20mA (load resistance max. 500Ω, output accuracy: ±0.3%F.S.)
	Com. output	RS485 Communication output (Modbus RTU method)
Control method		ON/OFF control, P, PI, PD, PID control
Hysteresis		1 to 100°C/°F (0.1 to 50.0°C/°F) variable
Proportional band(P)		0.1 to 999.9°C/°F
Integral time(I)		0 to 9999 sec.
Derivative time(D)		0 to 9999 sec.
Control period(T)		0.5 to 120.0 sec.
Manual reset		0.0 to 100.0%
Sampling period		50ms
Dielectric strength		3,000VAC 50/60Hz for 1 min. (between all terminals and case)
Vibration		0.75mm amplitude at frequency 5 to 55Hz (for 1 min.)in each X, Y, Z direction for 2 hours
Relay life cycle	Mechanical	OUT, AL1/2: Min. 5,000,000 operations
	Electrical	OUT, AL1/2: Min. 200,000 (250VAC 3A resistance load)
Insulation resistance		Min. 100MΩ (at 500VDC megger)
Noise resistance		Square shaped noise by noise simulator (pulse width 1μs) ±2kV R-phase, S-phase
Memory retention		Approx. 10 years (non-volatile semiconductor memory type)
Environment	Ambient temp.	-10 to 50°C, storage: -20 to 60°C
	Ambient humi.	35 to 85%RH, storage: 35 to 85%RH
Protection structure		IP50 (front panel, IEC standards)
Insulation type		Double insulation or reinforced insulation(mark:  , dielectric strength between all terminals and case: 3kV)
Approval		  
Weight ^{※3}		Approx. 135.2g (approx. 85.2g)

※1: When using the unit at low temperature (below 0°C), display cycle is slow.
Control output operates normally.

※2: ○ At room temperature(23°C±5°C)
 • TC R(PR), S(PR), below 200°C: (PV ±0.5% or ±3°C, select the higher one) ±1 digit
 , over 200°C: (PV ±0.5% or ±2°C, select the higher one) ±1 digit
 • TC L(IC), RTD Cu50Ω: (PV ±0.5% or ±2°C, select the higher one) ±1 digit
 ○ Out of room temperature range

• TC R(PR), S(PR): (PV ±1.0% or ±5°C, select the higher one) ±1 digit
 • TC L(IC), RTD Cu50Ω: (PV ±0.5% or ±3°C, select the higher one) ±1 digit

※3: The weight includes packaging. The weight in parentheses is for unit only.

※Environment resistance is rated at no freezing or condensation.

(A)
Photoelectric
Sensors

(B)
Fiber
Optic
Sensors

(C)
Door/Area
Sensors

(D)
Proximity
Sensors

(E)
Pressure
Sensors

(F)
Rotary
Encoders

(G)
Connectors/
Sockets

(H)
Temperature
Controllers

(I)
SSRs / Power
Controllers

(J)
Counters

(K)
Timers

(L)
Panel
Meters

(M)
Tacho /
Speed / Pulse
Meters

(N)
Display
Units

(O)
Sensor
Controllers

(P)
Switching
Mode Power
Supplies

(Q)
Stepper Motors
& Drivers
& Controllers

(R)
Graphic/
Logic
Panels

(S)
Field
Network
Devices

(T)
Software

TX4S Series

Connections

OUT
SSR
12VDC±2V 20mA Max.
Current
DC0/4-20mA
Load 500Ω Max.
Relay
250VAC 3A 1a
RESISTIVE LOAD

※Shaded terminals are standard model.

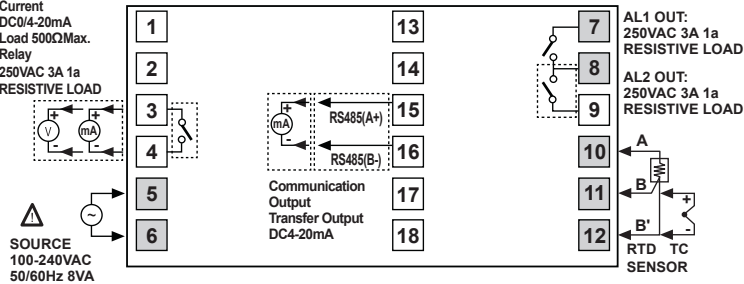

Dimensions

(unit: mm)

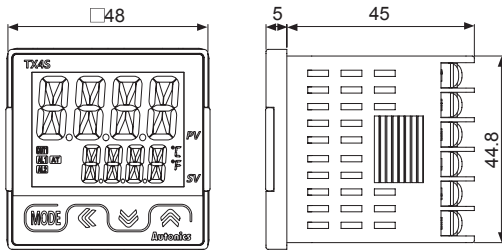

Panel cut-out

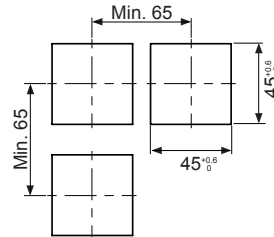

Bracket

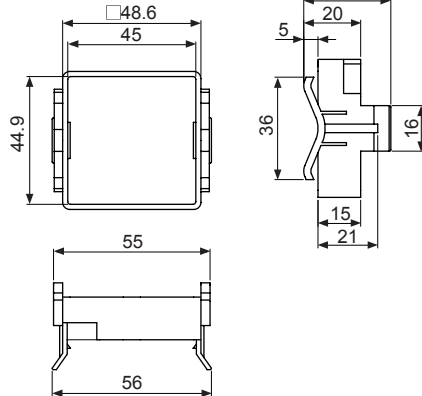

Terminal cover (sold separately)

●RSA Cover(48×48mm)

(unit: mm)

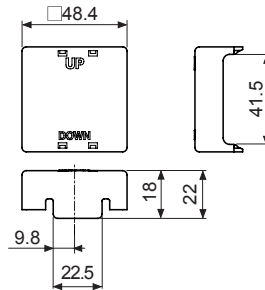

Product Mounting

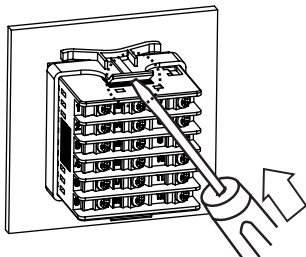

Mount the unit on the panel. Push the bracket with tools to fix the unit as the figure.

Sold Separately

●SCM-US
(USB to Serial converter)

●EXT-US
(converter cable)



LCD Display PID Control

Unit Description

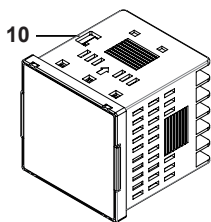
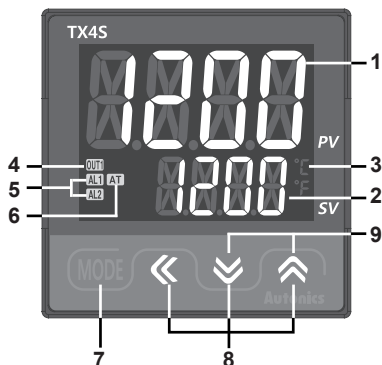

- 1. Measured value (PV) component:**
 RUN mode: Displays current measured value (PV).
 SETTING mode: Displays parameters.
- 2. Setting value (SV) display component:**
 RUN mode: Displays setting value(SV).
 SETTING mode: Displays setting value of parameter.
- 3. Temperature unit(°C/°F) indicator:**
 Displays the set temperature unit as temperature unit [UNIT] of parameter group 2.
- 4. Control output (OUT1) indicator:**
 Turns ON while control output is ON.
 ※Turns ON when MV is over 3.0% at cycle/phase control of SSR drive output method.
- 5. Alarm output (AL1, AL2) indicator:**
 Turns ON when the corresponding alarm output turns ON.
- 6. Auto-tuning indicator:**
 Flashes during auto-tuning every 1 sec.

- 7. [MODE] key:** Enters parameter group, returns to RUN mode, moves parameters, and saves the setting value.
- 8. Setting value adjustment key:** Enters SV setting mode and move digits.
- 9. Digital input key:**
 Press the [d1] + [d2] keys for 3 sec. to execute the digital input key functions which is set at digital input key [d1 - d2] of parameter group 2 (RUN/STOP, clear alarm output, auto-tuning).
- 10. PC loader port:**
 It is for serial communication to set parameter and monitoring by DAQMaster installed in PC. Use this for connection EXT-US (converter cable, sold separately) + SCM-US (USB to Serial converter, sold separately).

Parameter Group

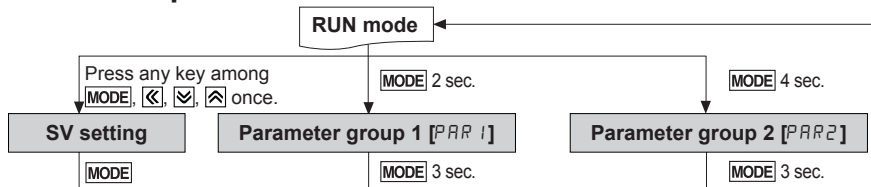

- ※Order of parameter setup **Parameter group 2** → **Parameter group 1** → **SV setting**
- All parameters are related one another. Set the parameters as above order.
- ※If there is no key input for 30 sec. while setting SV or the parameters, the new settings are ignored, and the unit will return to RUN mode with previous settings.
- ※When returning to RUN mode by holding the [MODE] key for over 3 sec., press the [MODE] key within 1 sec. to re-enter the first parameter of previous parameter group.
- ※Hold the [d1] + [d2] + [d3] keys for 5 sec. in RUN mode, to enter re-set parameter menu. Select 'RES' and all parameters are reset as factory default.

• SV setting

※To change set temperature from 210°C to 250°C

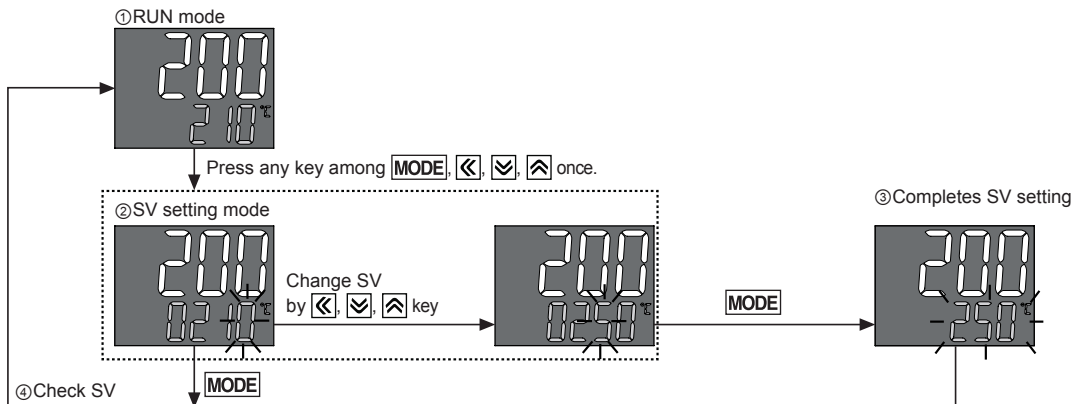

(A)	Photoelectric Sensors
(B)	Fiber Optic Sensors
(C)	Door/Area Sensors
(D)	Proximity Sensors
(E)	Pressure Sensors
(F)	Rotary Encoders
(G)	Connectors/ Sockets
(H)	Temperature Controllers
(I)	SSRs / Power Controllers
(J)	Counters
(K)	Timers
(L)	Panel Meters
(M)	Tacho / Speed / Pulse Meters
(N)	Display Units
(O)	Sensor Controllers
(P)	Switching Mode Power Supplies
(Q)	Stepper Motors & Drivers & Controllers
(R)	Graphic/ Logic Panels
(S)	Field Network Devices
(T)	Software

TX4S Series

Parameter group 1

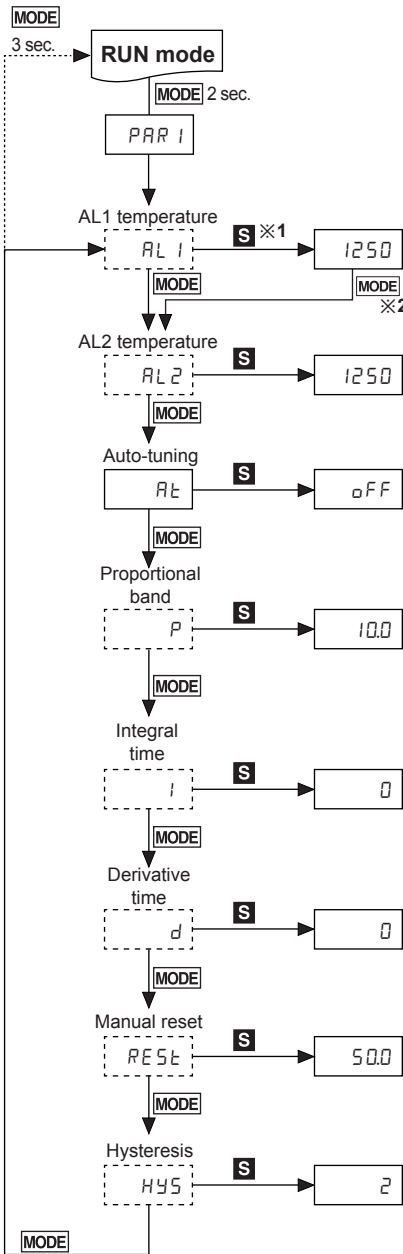

※1: **S**: Press any key among , , .

※2: Press the **MODE** key once after changing the setting value, to save the setting value and move to the next parameter

※Hold the **MODE** key for 3 sec. to save the setting value and return to RUN mode after changing the setting value.

※:  Dotted parameters may not appear by model type or other parameter settings.

Setting range: Deviation alarm(- [F.S] to [F.S]).
Absolute value alarm(temperature range)

※Does not appear when AL1/AL2 alarm operation [AL - 1, AL - 2] of parameter group 2 is set as $RM0_15bR□/LbR□$.

※Only alarm output 2 models have [AL 2].

※When setting as oN , the unit starts auto-tuning. After completing, oFF is automatically set.

※During auto-tuning, the auto-tuning indicator flashes (every 1 sec.).

Setting range: 0.1 to 999.9°C/°F

Setting range: 0 to 9999 sec.
※Integral operation will be OFF when the setting value is '0'.

Setting range: 0 to 9999 sec.
※Derivative operation will be OFF when the setting value is '0'.

Setting range: 0.0 to 100.0%
※Only appears in P, PD control.

Setting range: 1 to 100°C/°F (0.1 to 50.0°C/°F)

※Only appears when control method [-Md] of parameter group 2 is set as $oNoF$.

※Only appears when control method [-Md] of parameter group 2 is set as $P1d$.

LCD Display PID Control

Parameter group 2

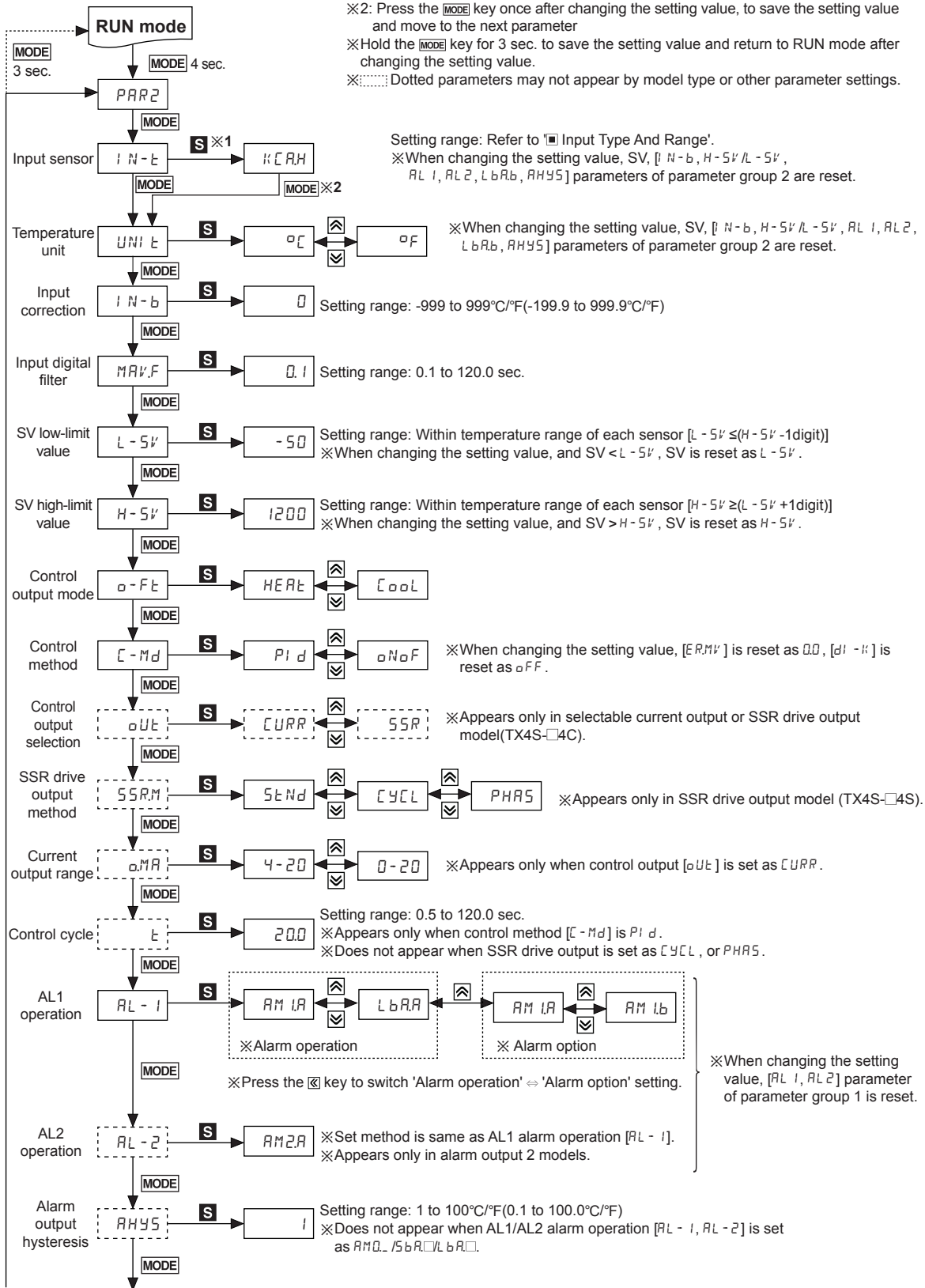

(A)	Photoelectric Sensors
(B)	Fiber Optic Sensors
(C)	Door/Area Sensors
(D)	Proximity Sensors
(E)	Pressure Sensors
(F)	Rotary Encoders
(G)	Connectors/Sockets
(H)	Temperature Controllers
(I)	SSRs / Power Controllers
(J)	Counters
(K)	Timers
(L)	Panel Meters
(M)	Tacho / Speed / Pulse Meters
(N)	Display Units
(O)	Sensor Controllers
(P)	Switching Mode Power Supplies
(Q)	Stepper Motors & Drivers & Controllers
(R)	Graphic/Logic Panels
(S)	Field Network Devices
(T)	Software

TX4S Series

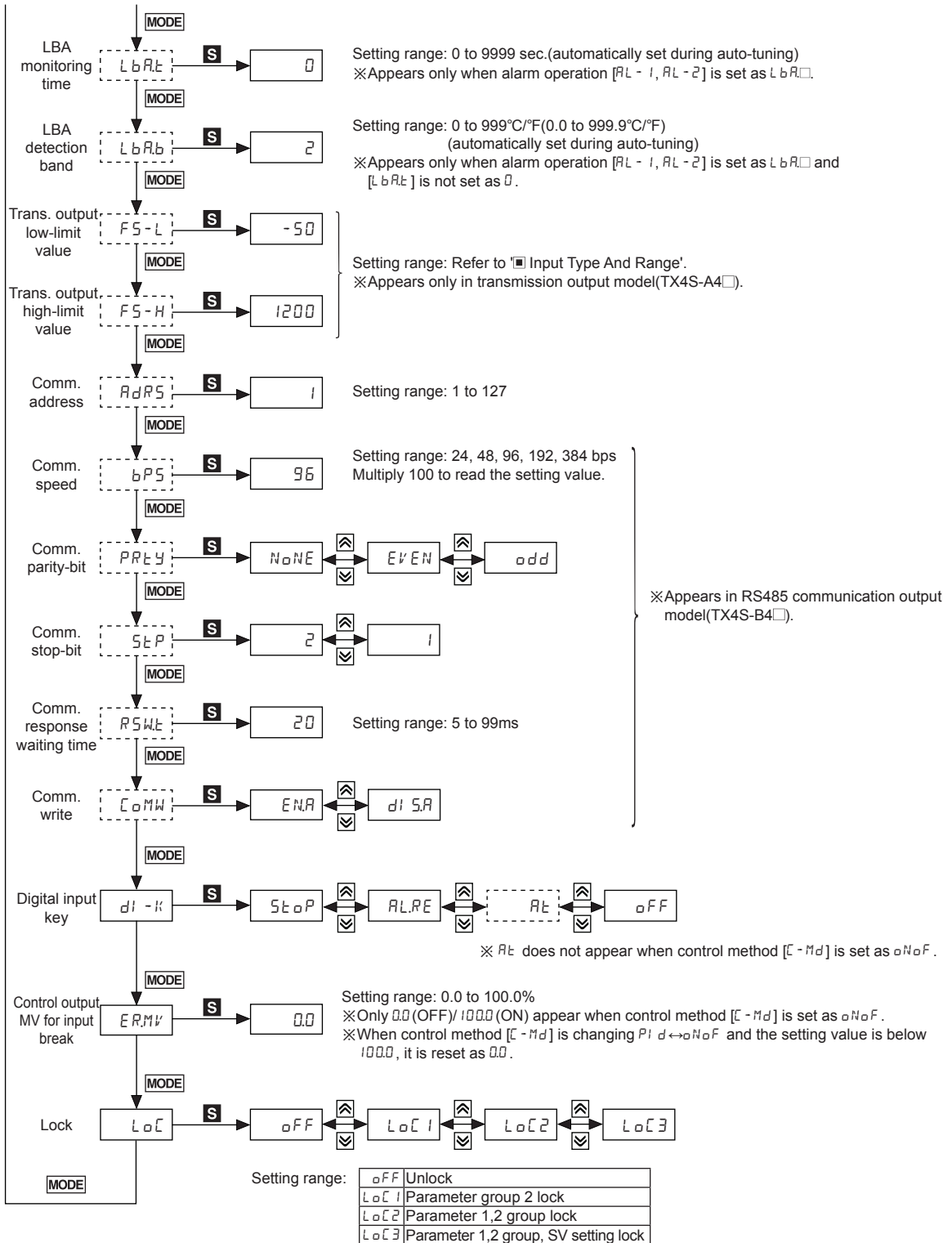

LCD Display PID Control

Input Type And Range

Input type		Decimal point	Display	Input range(°C)	Input range(°F)
Thermocouple	K(CA)	1	KCAH	-50 to 1200	-58 to 2192
		0.1	KCAL	-50.0 to 999.9	-58.0 to 999.9
	J(IC)	1	JICH	-30 to 800	-22 to 1472
		0.1	JICL	-30.0 to 800.0	-22.0 to 999.9
	L(IC)	1	LICH	-40 to 800	-40 to 1472
		0.1	LICL	-40.0 to 800.0	-40.0 to 999.9
	T(CC)	1	TCH	-50 to 400	-58 to 752
		0.1	TCL	-50.0 to 400.0	-58.0 to 752.0
R(PR)	1	RPR	0 to 1700	32 to 3092	
S(PR)	1	SPR	0 to 1700	32 to 3092	
RTD	DPT 100Ω	1	dPcH	-100 to 400	-148 to 752
		0.1	dPcL	-100.0 to 400.0	-148.0 to 752.0
	CU50Ω	1	CUSH	-50 to 200	-58 to 392
		0.1	CUSL	-50.0 to 200.0	-58.0 to 392.0

Factory Default

SV setting

Parameter	Factory default
-	0

Parameter group 1

Parameter	Factory default
RL1	1250
RL2	
RL	OFF
P	10.0
i	0
d	
RESL	50.0
HYS	2

Parameter group 2

Parameter	Factory default	Parameter	Factory default
IN-L	KCAH	AHYS	1
UNI-L	°C	LbAL	0
IN-b	0	LbAb	2
MAV-F	0.1	FS-L	-50
L-SV	-50	FS-H	1200
H-SV	1200	AdRS	1
o-FL	HEAL	bPS	96
C-Md	PI d	PRLY	NONE
oUL	CURR	SEp	2
SSRM	SEnd	RSWt	20
oMA	4-20	CoMW	ENR
t	20.0(Relay)	di-k	SEoP
	2.0(SSR,one)	ERMV	0.0
RL-1	AM1A	LoC	OFF
RL-2	AM2A		

Error

Display	Description	Troubleshooting
oPEN	Flashes when input sensor is disconnected or sensor is not connected.	Check input sensor status.
HHHH	Flashes when measured value is higher than input range.	When input is within the rated input range, this display disappears.
LLLL	Flashes when measured value is lower than input range.	

(A) Photoelectric Sensors

(B) Fiber Optic Sensors

(C) Door/Area Sensors

(D) Proximity Sensors

(E) Pressure Sensors

(F) Rotary Encoders

(G) Connectors/ Sockets

(H) Temperature Controllers

(I) SSRs / Power Controllers

(J) Counters

(K) Timers

(L) Panel Meters

(M) Tacho / Speed / Pulse Meters

(N) Display Units

(O) Sensor Controllers

(P) Switching Mode Power Supplies

(Q) Stepper Motors & Drivers & Controllers

(R) Graphic/ Logic Panels

(S) Field Network Devices

(T) Software

TX4S Series

Alarm

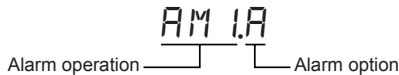

Set both alarm operation and alarm option by combining. Each alarm operates individually in two alarm output models. When the current temperature is out of alarm range, alarm clears automatically. If alarm option is alarm latch or alarm latch and standby sequence 1/2, press digital input key $\left[\text{DI} + \text{K} \right]$ 3 sec., digital input key $\left[\text{DI} - \text{K} \right]$ of parameter group 2 set as RLRE), or turn OFF the power and turn ON to clear alarm.

Alarm operation

Mode	Name	Alarm operation	Description
$\text{AM}0$	-	-	No alarm output
$\text{AM}1$	Deviation high-limit alarm		If deviation between PV and SV as high-limit is higher than set value of deviation temperature, the alarm output will be ON.
$\text{AM}2$	Deviation low-limit alarm		If deviation between PV and SV as low-limit is higher than set value of deviation temperature, the alarm output will be ON.
$\text{AM}3$	Deviation high/low-limit alarm		If deviation between PV and SV as high/low-limit is higher than set value of deviation temperature, the alarm output will be ON.
$\text{AM}4$	Deviation high/low-limit reserve alarm		If deviation between PV and SV as high/low-limit is higher than set value of deviation temperature, the alarm output will be OFF.
$\text{AM}5$	Absolute value high limit alarm		If PV is higher than the absolute value, the output will be ON.
$\text{AM}6$	Absolute value low limit alarm		If PV is lower than the absolute value, the output will be ON.
SbR	Sensor break alarm	-	It will be ON when it detects sensor disconnection.
LbR	Loop break alarm	-	It will be ON when it detects loop break.

※ H: Alarm output hysteresis [RH35]

Alarm option

Option	Name	Description
$\text{AM}a$	Standard alarm	If it is an alarm condition, alarm output is ON. If it is a clear alarm condition, alarm output is OFF.
$\text{AM}b$	Alarm latch	If it is an alarm condition, alarm output is ON and maintains ON status. (Alarm output HOLD)
$\text{AM}c$	Standby sequence 1	First alarm condition is ignored and from second alarm condition, standard alarm operates. When power is supplied and it is an alarm condition, this first alarm condition is ignored and from the second alarm condition, standard alarm operates.
$\text{AM}d$	Alarm latch and standby sequence 1	If it is an alarm condition, it operates both alarm latch and standby sequence. When power is supplied and it is an alarm condition, this first alarm condition is ignored and from the second alarm condition, alarm latch operates.
$\text{AM}e$	Standby sequence 2	First alarm condition is ignored and from second alarm condition, standard alarm operates. When re-applied standby sequence and if it is alarm condition, alarm output does not turn ON. After clearing alarm condition, standard alarm operates.
$\text{AM}f$	Alarm latch and standby sequence 2	Basic operation is same as alarm latch and standby sequence 1. It operates not only by power ON/OFF, but also alarm setting value, or alarm option changing. When re-applied standby sequence and if it is alarm condition, alarm output does not turn ON. After clearing alarm condition, alarm latch operates.

※ Condition of re-applied standby sequence for standby sequence 1, alarm latch and standby sequence 1: Power ON
Condition of re-applied standby sequence for standby sequence 2, alarm latch and standby sequence 2: Power ON, changing set temperature, alarm temperature [RL 1, RL 2] or alarm operation [RL - 1, RL - 2], switching STOP mode to RUN mode.

LCD Display PID Control

•Sensor break alarm

The function that alarm output will be ON when sensor is not connected or when sensor's disconnection is detected during temperature controlling. You can check whether the sensor is connected with buzzer or other units using alarm output contact. It is selectable between standard alarm [5bRR] or alarm latch [5bRb].

• Loop break alarm(LBA)

It checks control loop and outputs alarm by temperature change of the subject. For heating control(cooling control), when control output MV is 100%(0% for cooling control) and PV is not increased over than LBA detection band [LbRb] during LBA monitoring time [LbRt], or when control output MV is 0%(100% for cooling control) and PV is not decreased below than LBA detection band [LbRb] during LBA monitoring time [LbRt], alarm output turns ON.

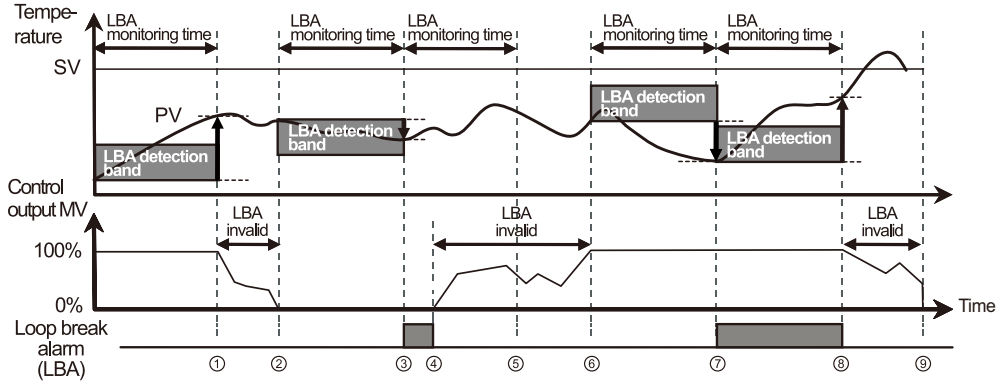

Start control to ①	When control output MV is 100%, PV is increased over than LBA detection band [LbRb] during LBA monitoring time [LbRt].
① to ②	The status of changing control output MV (LBA monitoring time is reset.)
② to ③	When control output MV is 0% and PV is not decreased below than LBA detection band [LbRb] during LBA monitoring time [LbRt], loop break alarm (LBA) turns ON after LBA monitoring time.
③ to ④	Control output MV is 0% and loop break alarm (LBA) turns and maintains ON.
④ to ⑥	The status of changing control output MV (LBA monitoring time is reset.)
⑥ to ⑦	When control output MV is 100% and PV is not increased over than LBA detection band [LbRb] during LBA monitoring time [LbRt], loop break alarm (LBA) turns ON after LBA monitoring time.
⑦ to ⑧	When control output MV is 100% and PV is increased over than LBA detection band [LbRb] during LBA monitoring time [LbRt], loop break alarm (LBA) turns OFF after LBA monitoring time.
⑧ to ⑨	The status of changing control output MV (LBA monitoring time is reset.)

※When executing auto-tuning, LBA detection band [LbRb] and LBA monitoring time are automatically set based on auto tuning value. When alarm operation mode [RL-1, RL-2] is set as loop break alarm(LBA) [LbR□], LBA detection band [LbRb] and LBA monitoring time [LbRt] parameter is displayed.

(A) Photoelectric Sensors

(B) Fiber Optic Sensors

(C) Door/Area Sensors

(D) Proximity Sensors

(E) Pressure Sensors

(F) Rotary Encoders

(G) Connectors/Sockets

(H) Temperature Controllers

(I) SSRs / Power Controllers

(J) Counters

(K) Timers

(L) Panel Meters

(M) Tacho / Speed / Pulse Meters

(N) Display Units

(O) Sensor Controllers

(P) Switching Mode Power Supplies

(Q) Stepper Motors & Drivers & Controllers

(R) Graphic/Logic Panels

(S) Field Network Devices

(T) Software

TX4S Series

■ Functions

1. Input correction [I N - b]

Controller itself does not have errors but there may be error by external input temperature sensor. This function is for correcting this error. E.g.) If actual temperature is 80°C but controller displays 78°C, set input correction value [I N - b] as '2' and controller displays 80°C.
 ※As the result of input correction, if current temperature value (PV) is over each temperature range of input sensor, it displays HHHH or LLLL.

2. Input digital filter [M V F]

If current temperature (PV) is fluctuating repeatedly by rapid change of input signal, it reflects to MV and stable control is impossible. Therefore, digital filter function stabilizes current temperature value.
 For example, set input digital filter value as 0.4 sec, and it applies digital filter to input values during 0.4 sec and displays these values. Current temperature may be different by actual input value.

3. SSR drive output method (SSRP function) [5 5 R M]

- SSRP function is selectable one of standard ON/OFF control, cycle control, phase control by utilizing standard SSR drive output.
- This function parameter appears only in SSR drive output model (TX4S-□4S).
- Realizing high accuracy and cost effective temperature control with both current output (4-20mA) and linear output(cycle control and phase control)
- Select one of standard ON/OFF control [5 t N d], cycle control [C y C L], phase control [P H R S] at 5 5 R M parameter of parameter group 2. For cycle control, connect a zero cross turn-on SSR or random turn-on SSR. For phase control, connect random turn-on SSR.

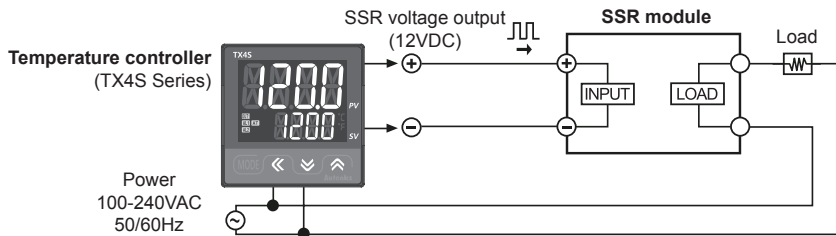

※When selecting cycle or phase control mode, **the power supply for a load and a temperature controller must be the same.**

※Control cycle [t] is able to set only when control method [C - M d] of parameter group 2 is set as P i d and SSR drive output method [5 5 R M] is set as 5 t N d.

※In case of selectable current output or SSR drive output model(TX4S-□4C), this parameter does not appear.
 Standard ON/OFF control by SSR is only available.

1) Standard ON/OFF control [5 t N d]

Controls ON (100% output)/OFF (0% output) as same as standard relay output.

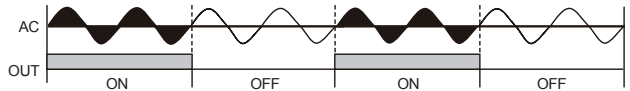

2) Cycle control [C y C L]

Controls the load by repeating output ON / OFF according to the rate of output within setting cycle based on certain period (50-cycle).

Control accuracy is almost the same with phase control's.

This control has improved ON/OFF noise than phase control's due to zero cross type which turns ON/OFF at zero point of AC.

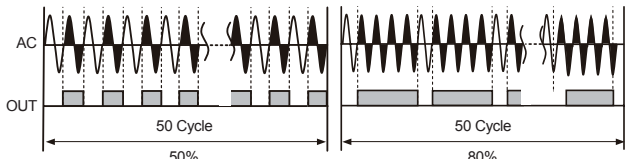

3) Phase control [P H R S]

Controls the load by controlling the phase within AC half cycle. Serial control is available.

Must use random turn-on SSR for this mode.

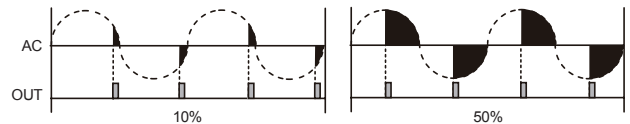

4. Current output range [a M R]

In case of selectable current output or SSR drive output model(TX4S-□4C), when control output [a U L] parameter group 2 is set as [C U R R], you can select high/low-limit range, 4-20mA [4 - 2 0] or 0-20mA [0 - 2 0] of current output.

5. Hysteresis [H Y S]

Set interval between ON and OFF of control output for ON/OFF control.

●If hysteresis is too narrow, hunting(oscillation, chattering) could occur due to external noise.

●In case of ON / OFF control mode, even if PV reaches stable status, there still occurs hunting. It could be due to hysteresis [H Y S] setting value, load's response characteristics or sensor's location. In order to reduce hunting to a minimum, it is required to take into following factors consideration when designing temp. controlling; proper Hysteresis [H Y S], heater's capacity, thermal characteristics, sensor's response and location.

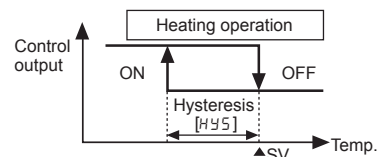

LCD Display PID Control

6. Manual reset [RESE]

When selecting P/PD control mode, certain temperature difference exists even after PV reaches stable status because heater's rising and falling time is inconsistent due to thermal characteristics of controlled objects, such as heat capacity, heater capacity. This temperature difference is called offset and manual reset [RESE] function is to set/correct offset.

When PV and SV are equal, reset value is 50.0%. After control is stable, PV is lower than SV, reset value is over 50.0% or PV is higher than SV, reset value is below 50.0%.

●Manual reset [RESE] by control result

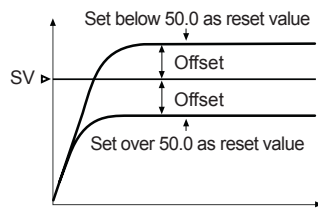

7. Digital input key [OK] + [F3] 3 sec. [d1 - t]

Parameter		Operation
OFF	OFF	It does not use digital input key function.
RUN/STOP	STOP	Pauses control output. Auxiliary output (except loop break alarm, sensor break alarm)except Control output operates as setting. Hold the digital input keys for 3 sec. to restart.
Clear alarm	ALRE	Clears alarm output by force. (only when alarm option is alarm latch, or alarm latch and standby sequence 1/2.) This function is applied when present value is out of alarm operation range but alarm output is ON. Alarm operates normally right after clearing alarm.
Auto-tuning	RE	Starts/Stops auto-tuning. This function is same as auto-tuning [RE] of parameter group 1. (You can start auto-tuning [RE] of parameter group 1 and stop it by digital input key.) ※ This parameter RE appears only when control method [C-Md] parameter group 2 is set as PID. When control method [C-Md] parameter group 2 is set as ONOFF, this parameter is changed as OFF.

8. Control output MV for input break [ERMV]

When input sensor is break, set control output MV.

When control method [C-Md] of parameter group 2 is set as ONOFF, set control output MV as 0.0 (OFF) or 100.0 (ON). When control method [C-Md] is set as PID, setting range for control output MV is 0.0 to 100.0.

RS485 Communication Output

Applicable for models with RS485 communication output through option output(TX4S-B4□).
Please refer to 'Ordering Information'.

1. Communication Specifications

Com. protocol	Modbus RTU	Com. speed	2400, 4800, 9600, 19200, 38400 bps
Applied standard	EIA RS485		
Max. connections	31 units(address: 1 to 99)	Start-bit	1-bit fixed
Com. method	2-wire half duplex	Data-bit	8-bit fixed
Synchronization method	Asynchronous	Parity-bit	None, Even, Odd
Com. distance	Within 800m	Stop-bit	1, 2Bit
Com. response time	5 to 99ms		

2. Modbus Mapping Table

2-1. Read Coil Status (Func 01) / Force Single Coil (Func 05) [Func: 01/05, R/W: R/W]

No.(Address)	Type		Description	Setting/Display range	Unit	Default
00001(0000)	RUN/STOP	Related coil, variable	Control output run/stop	0: RUN 1: STOP	-	STOP
00002(0001)	AT		Auto-tuning run/stop	0: OFF 1: ON	-	OFF
00003(0003)	Alarm Reset		Alarm output clear	0: OFF 1: ON	-	OFF
00004 to 00050	Reserved					

2-2. Read Discrete Inputs(Func 02) [Func: 02, R/W: R]

No.(Address)	Type		Description	Setting/Display range	Unit	Default
100001(0000)	°C indicator	Front indicator	Unit indicator	0: OFF 1: ON	-	-
100002(0001)	°F indicator		Unit indicator	0: OFF 1: ON	-	-
100003(0002)	OUT indicator		Control output indicator	0: OFF 1: ON	-	-
100004(0003)	AT indicator		Auto-tuning indicator	0: OFF 1: ON	-	-
100005(0004)	AL1 indicator		Alarm output 1 indicator	0: OFF 1: ON	-	-
100006(0005)	AL2 indicator		Alarm output 2 indicator	0: OFF 1: ON	-	-
100006 to 100050	Reserved					

(A) Photoelectric Sensors
(B) Fiber Optic Sensors
(C) Door/Area Sensors
(D) Proximity Sensors
(E) Pressure Sensors
(F) Rotary Encoders
(G) Connectors/ Sockets
(H) Temperature Controllers
(I) SSRs / Power Controllers
(J) Counters
(K) Timers
(L) Panel Meters
(M) Tacho / Speed / Pulse Meters
(N) Display Units
(O) Sensor Controllers
(P) Switching Mode Power Supplies
(Q) Stepper Motors & Drivers & Controllers
(R) Graphic/ Logic Panels
(S) Field Network Devices
(T) Software

TX4S Series

2-3. Read Input Registers (Func 04) [Func:02, R/W : R]

No.(Address)	Type	Description	Setting/Display range	Unit	Default	
300001 to 300100	Reserved					
300101(0064)	-	Product number H	-	-	Dedicated model number	
300102(0065)	-	Product number L	-	-	Dedicated model number	
300103(0066)	-	Hardware version	-	-	□	
300104(0067)	-	Software version	-	-	□	
300105(0068)	-	Model 1	-	-	"TX"	
300106(0069)	-	Model 2	-	-	"4"	
300107(006A)	-	Model 3	-	-	"S"	
300108(006B)	-	Model 4	-	-	"14"	
300109(006C)	-	Model 5	-	-	"R"	
300110(006D)	-	Model 6	-	-	" "	
300111(006E)	-	Model 7	-	-	" "	
300112(006F)	-	Model 8	-	-	" "	
300113(0070)	-	Model 9	-	-	" "	
300114(0071)	-	Model 10	-	-	" "	
300115(0072)	-	Reserved	-	-	-	
300116(0073)	-	Reserved	-	-	-	
300117(0074)	-	Reserved	-	-	-	
300118(0075)	-	Coil status start address	-	-	0000	
300119(0076)	-	Coil status quantity	-	-	0	
300120(0077)	-	Input status start address	-	-	0000	
300121(0078)	-	Input status quantity	-	-	0	
300122(0079)	-	Holding register start address	-	-	0000	
300123(007A)	-	Holding register quantity	-	-	0	
300124(007B)	-	Input register start address	-	-	0000	
300125(007C)	-	Input register quantity	-	-	0	
300127 to 300200	Reserved					
301001(03E8)	PV	Present value	-1999 to 9999	°C/°F	-	
301002(03E9)	DOT	Decimal point location	0:0, 1:00, 2:000, 3:0000	-	-	
301003(03EA)	UNIT	Display unit	0: °C, 1: °F	-	-	
301004(03EB)	SV	Setting value	Within L - 5V to H - 5V	°C/°F	0	
301005(03EC)	°C indicator	Front indicator	Unit indicator	0: OFF 1: ON	-	-
	°F indicator		Unit indicator	0: OFF 1: ON	-	-
	OUT indicator		Control output indicator	0: OFF 1: ON	-	-
	AT indicator		Auto-tuning indicator	0: OFF 1: ON	-	-
	AL1 indicator		Alarm output 1 indicator	0: OFF 1: ON	-	-
	AL2 indicator		Alarm output 2 indicator	0: OFF 1: ON	-	-
310006 to 310050	Reserved					

2-4. Read Holding Register (Func 03)/Preset Single Register (Func 06)/Preset Multiple Registers (Func 16) [Func:03/06/16, R/W : R/W]

2-4-1. SV setting

No.(Address)	Parameter	Description	Setting/Display range	Unit	Default
400001(0000)	Set value	SV setting value	Within L - 5V to H - 5V	°C/°F	0
400002 to 400050	Reserved				

2-4-2. Parameter group 1 [PRR 1]

No.(Address)	Parameter	Description	Setting/Display range	Unit	Default
400051(0032)	RL1	AL1 temperature	Deviation temperature: -F.S. to F.S.	°C/°F	1250
400052(0033)	RL2	AL2 temperature	Absolute value alarm: Temperature range	°C/°F	1250
400053(0034)	RE	Auto-tuning	0: OFF 1: ON	-	OFF
400054(0035)	P	Proportional band	1 to 9999: 0.1 to 999.9	°C/°F	10.0
400055(0036)	I	Integral time	0 to 9999: 0 to 999.9	Sec.	0
400056(0037)	D	Derivative time	0 to 9999: 0 to 999.9	Sec.	0
400057(0038)	RES	Manual reset	0 to 1000: 0.0 to 100.0	%	50.0
400058(0039)	HYS	Hysteresis	1 to 100(1 to 500): 1 to 100(0.1 to 50.0)	-	2
400059 to 400100	Reserved				

LCD Display PID Control

2-4-3. Parameter group 2 [PAR2]

No.(Address)	Parameter	Description	Setting/Display range	Unit	Default
400101(0064)	IN-E	Input sensor	Refer to 'Input Type And Range'	-	ICRH
400102(0065)	UNIT	Temperature unit	0: °C, 1: °F	-	°C
400103(0066)	IN-b	Input correction	-999 to 999(-1999 to 9999): -999 to 999(-999 to 999.9)	-	0
400104(0067)	MAV.F	Input digital filter	1 to 1200: 0.1 to 120.0	Sec.	0.1
400105(0068)	L-SV	SV low-limit value	Refer to 'Input Type And Range'	°C/°F	-5.0
400106(0069)	H-SV	SV high-limit value			120.0
400107(006A)	o-Fe	Control output mode	0: HEARt, 1: CoOL	-	HEARt
400108(006B)	C-Md	control method	0: Pid, 1: oNoF	-	Pid
400109(006C)	oUt	Control output selection	0: SSR, 1: CURR	-	CURR
400110(006D)	SSRM	SSR drive output method	0: SEnD, 1: CYCL, 2: PHAS	-	SEnD
400111(006E)	oMR	Current output range	0: 4-20, 1: 0-20	-	4-20
400112(006F)	t	Control cycle	5 to 1200: 0.5 to 120.0	Sec.	20.0 2.0
400113(0070)	AL-1	AL1 operation	00: AMO., 10 to 15: AMIA to AMIF, ... 60 to 65: AM6A to AM6F, 70: 5bAA, 71: 5bAb, 80: LbAA, 81: LbAb	-	AMIA
400114(0071)	AL-2	AL2 operation		-	AM2A
400115(0072)	AHYS	Alarm output hysteresis	1 to 100(1 to 500): 1 to 100(0.1 to 50.0)	-	1
400116(0073)	LbALt	LBA detection time	0 to 9999: 0 to 9999	Sec.	0
400117(0074)	LbAb	LBA detection band	0 to 999(0 to 9999): 0 to 999(0.0 to 999.9)	°C/°F	2
400118(0075)	F5-L	Trans. output low-limit value	Refer to 'Input Type And Range'.	-	-5.0
400119(0076)	F5-H	Trans. output high-limit value		-	120.0
400120(0077)	AdRS	Com. address	1 to 127: 1 to 127	-	1
400121(0078)	bPS	Com. speed	0: 24, 1: 48, 2: 96, 3: 192, 4: 384	-	96
400122(0079)	PRtY	Com. parity bit	0: NoNE, 1: EVEN, 2: oDD	-	NoNE
400123(007A)	StP	Com. stop bit	0: 1, 1: 2	-	2
400124(007B)	R5Wt	Com. response waiting time	5 to 99: 5 to 99	ms	20
400125(007C)	CoMW	Com. write	0: ENA, 1: dISA	-	ENA
400126(007D)	dI-K	Digital input key	0: oFF, 1: St oP, 2: ALRE, 3: Rt	-	St oP
400127(007E)	ERMV	Control output MV for input break	0 to 1000: 0.0 (OFF) to 100.0 (ON)	%	0.0
400128(007F)	LoC	Lock	0: oFF, 1: LoC1, 2: LoC2, 3: LoC3	-	oFF
400129 to 400150	Reserved				

■ Proper Usage

1. Please separate the unit wiring from high voltage lines or power lines to prevent inductive noise.
2. For crimp terminal, select following shaped terminal (M3).

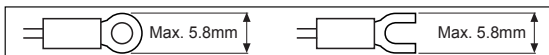

3. Install a power switch or circuit breaker to control the power supply.
4. The power switch or circuit breaker should be installed where it is easily accessible by the user.
5. The unit is for temperature controller. Do not use the unit as volt-meter or ampere-meter.
6. When using RTD temperature sensor, must wire it as 3-wire type. If cable is extended, use 3 wires which are same thickness as the line. It might cause the deviation of temperature when line resistance is different.
7. If power line and input signal line are close each other, install line filter for noise protection at power line and use shielded input signal line.
8. Keep away from the high frequency instruments.(High frequency welding machine & sewing machine, large capacity SCR controller).
9. When supplying the measured input, the unit displays HHHH or LLLL, the measured input may have problem. Turn OFF the power to the unit and check the line.
10. This unit may be used in the following environments.
 - ① It shall be used indoor.
 - ② Altitude up to 2,000m.
 - ③ Pollution degree 2.
 - ④ Installation category II.

(A) Photoelectric Sensors

(B) Fiber Optic Sensors

(C) Door/Area Sensors

(D) Proximity Sensors

(E) Pressure Sensors

(F) Rotary Encoders

(G) Connectors/ Sockets

(H) Temperature Controllers

(I) SSRs / Power Controllers

(J) Counters

(K) Timers

(L) Panel Meters

(M) Tacho / Speed / Pulse Meters

(N) Display Units

(O) Sensor Controllers

(P) Switching Mode Power Supplies

(Q) Stepper Motors & Drivers & Controllers

(R) Graphic/ Logic Panels

(S) Field Network Devices

(T) Software