

Compact Digital Pressure Sensors



Wide Pressure Range

2 Independent Outputs

Analog Output

Stable Output

Features

- Pressure Measurement Range (Negative, Standard, Compound)

Pressure Measurement Range

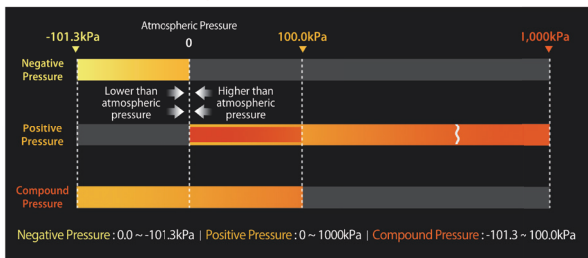

- Auto Shift Function

With change in the original pressure, the external input adjusts the determined level to match the change in pressure. (only available in models with auto shift/hold function)

- Without Auto Shift

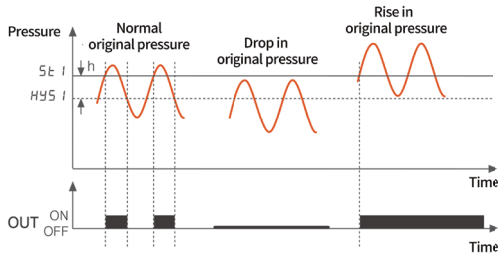

- With Auto Shift

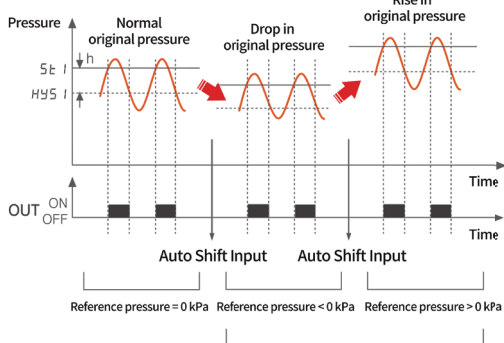

Correction set value [Set I]' = [Set I] + [SH n]
 Correction set value [HYS I]' = [HYS I] + [SH n]
 * [SH n] is the reference pressure set by Auto Shift input

- 2 Independent Outputs

Two independent outputs are available (OUT1, OUT2) for precise and detailed control.

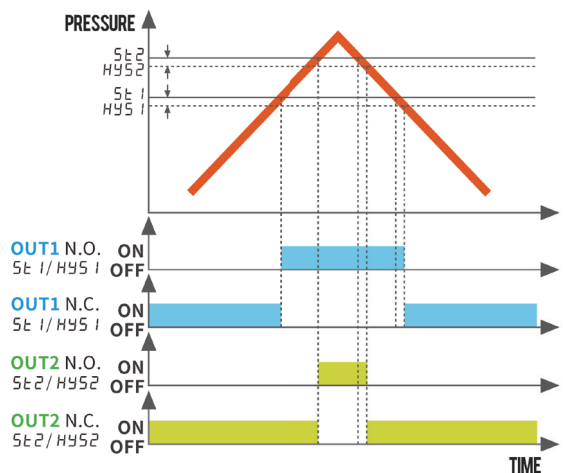

- (A) Photoelectric Sensors
- (B) Fiber Optic Sensors
- (C) Door/Area Sensors
- (D) Proximity Sensors
- (E) Pressure Sensors
- (F) Rotary Encoders
- (G) Connectors/ Connector Cables/ Sensor Distribution Boxes/Sockets
- (H) Temperature Controllers
- (I) SSRs / Power Controllers
- (J) Counters
- (K) Timers
- (L) Panel Meters
- (M) Tacho / Speed / Pulse Meters
- (N) Display Units
- (O) Sensor Controllers
- (P) Switching Mode Power Supplies
- (Q) Stepper Motors & Drivers & Controllers
- (R) Graphic/ Logic Panels
- (S) Field Network Devices
- (T) Software

PSAN Series

● Analog Outputs

The series is available in DC4-20mA current output and 1-5VDC voltage output models.

● Voltage output

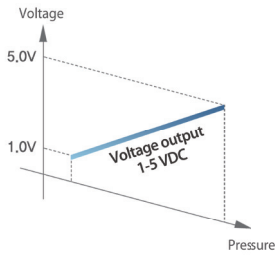

● Current output

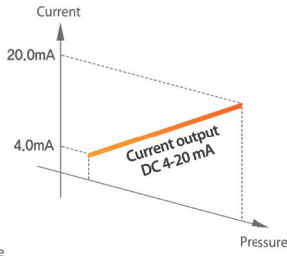

● One-Touch Connector Wiring

The one-touch, push-to-connect wiring allows easier connection and maintenance (connector types only)

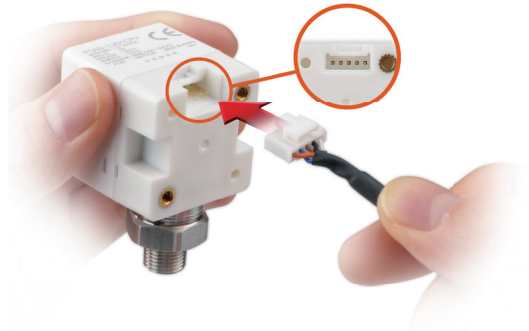

● Supports 8 Types of Pressure Units

The sensors support 8 types of pressure units including MPa, kPa, kgf/cm², bar, psi, mmHg, inHg, and mmH₂O.

● For Negative or Compound Pressure

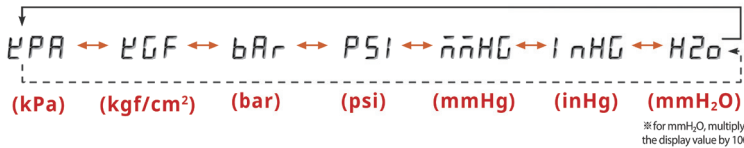

● For Standard Pressure

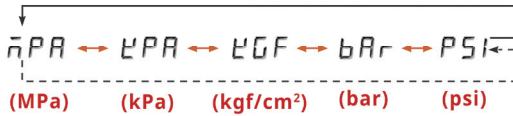

■ Application

Digital pressure sensors used to measure pressure of pressure cylinders. (connector type)

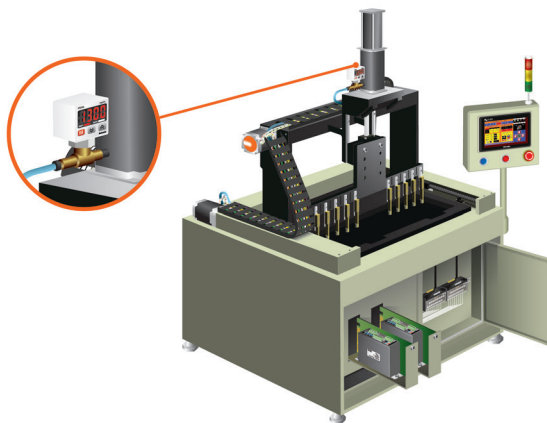

Compact Digital Pressure Sensors

■ Features

- Pressure measurement of any gas, liquid or oil (×except substances which may corrode stainless steel 316L)
- Auto shift function
: with change in the original pressure, the external input adjusts the determined level to match the change in pressure (only available in models with auto shift/hold function)
- High display resolutions - negative pressure: 0.1kPa
- standard pressure: 0.1kPa, 1kPa
- compound pressure: 0.1kPa
- Two independent outputs (N.O./N.C. output selectable)
- Hold function: hold current display value or control output
- Forced output control mode for device testing and maintenance
- One-touch connector type for easy wiring and maintenance
- Analog output: voltage (1-5VDC), current (DC4-20mA)
- Zero-point adjustment function, peak value monitoring function, chattering prevention function



Pneumatic type

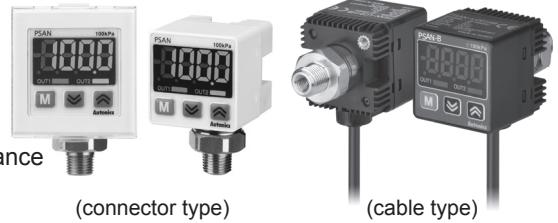

(connector type)

(cable type)

Fluid type

⚠ Please read "Caution for your safety" in operation manual before using.



■ Ordering Information

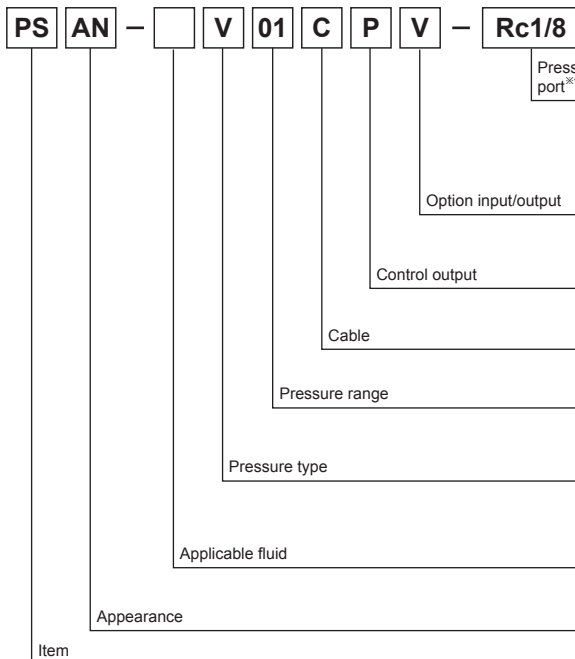

R1/8	Standard (fluid type), Option (pneumatic type)
Rc1/8	Standard (pneumatic type)
NPT1/8	Option
7/16-20UNF	Option (fluid type)
9/16-18UNF	Option (fluid type)
V	Voltage (1-5VDC) output
A	Current (DC4-20mA) output
H	Hold/Auto shift input
No mark	NPN open collector output
P	PNP open collector output
C	Connector type
No mark	Cable type
01	100kPa
1	1,000kPa
No mark	Standard pressure
V	Negative pressure
C	Compound pressure
No mark	Pneumatic type (gas)/rear port fitting
L	Fluid type (gas, liquid, oil)/bottom port fitting
B	Fluid type (gas, liquid, oil)/rear port fitting
AN	Regular square New type (30×30mm)
PS	Pressure Sensor

※1: In case of using M5 port, use PSO-Z01 (M5 Gender) together.

■ Pressure And Max. Pressure Display Range

Type	MPa	kPa	kgf/cm ²	bar	psi	mmHg	inHg	mmH ₂ O
Negative pressure	—	0.0 to -101.3 (5.0 to -101.3)	0.000 to -1.033 (0.051 to -1.033)	0.000 to -1.013 (0.050 to -1.013)	0.00 to -14.70 (0.74 to -14.70)	0 to -760 (38.0 to -760.0)	0.0 to -29.9 (1.50 to -29.90)	0.0 to -103.3 (5.1 to -103.3)
Standard pressure	0 to 0.100 (-0.005 to 0.110)	0.0 to 100.0 (-5.0 to 110.0)	0.000 to 1.020 (-0.051 to 1.122)	0.000 to 1.000 (-0.050 to 1.100)	0.00 to 14.50 (-0.72 to 15.96)	—	—	—
	0 to 1.000 (-0.050 to 1.100)	0 to 1000 (-101.3 to 1100)	0.00 to 10.20 (-0.51 to 11.22)	0.00 to 10.00 (-0.50 to 11.00)	0.0 to 145.0 (-7.2 to 159.6)	—	—	—
Compound pressure	—	-101.3 to 100.0 (-101.3 to 110.0)	-1.034 to 1.020 (-1.034 to 1.122)	-1.013 to 1.000 (-1.013 to 1.100)	-14.70 to 14.50 (-14.70 to 15.96)	-760 to 750 (-760.0 to 824.0)	-29.9 to 29.5 (-29.88 to 32.58)	-103.4 to 102.0 (-103.4 to 112.2)

※ () is Max. pressure display range.

※ For using a unit mmH₂O, multiply display value by 100.

- (A) Photoelectric Sensors
- (B) Fiber Optic Sensors
- (C) Door/Area Sensors
- (D) Proximity Sensors
- (E) Pressure Sensors
- (F) Rotary Encoders
- (G) Connectors/ Connector Cables/ Sensor Distribution Boxes/Sockets
- (H) Temperature Controllers
- (I) SSRs / Power Controllers
- (J) Counters
- (K) Timers
- (L) Panel Meters
- (M) Tacho / Speed / Pulse Meters
- (N) Display Units
- (O) Sensor Controllers
- (P) Switching Mode Power Supplies
- (Q) Stepper Motors & Drivers & Controllers
- (R) Graphic/ Logic Panels
- (S) Field Network Devices
- (T) Software

PSAN Series

Pressure Conversion Chart

from to	Pa	kPa	MPa	kgf/cm ²	mmHg	mmH ₂ O	psi	bar	inHg
1Pa	1	0.001	0.000001	0.00010197	0.007501	0.101972	0.000145038	0.00001	0.0002953
1kPa	1000	1	0.001	0.010197	7.500617	101.971626	0.145038	0.01	0.2953
1MPa	1000000	1000	1	10.197162	7500.61683	101971.626	145.038243	10	295.299875
1kgf/cm ²	98066.5	98.0665	0.098067	1	735.55924	10000.0005	14.223393	0.980665	28.959025
1mmHg	133.322368	0.133322	0.000133	0.001359	1	13.595099	0.019337	0.001333	0.039370
1mmH ₂ O	9.80665	0.009807	0.000099	0.000099	0.073556	1	0.00142	0.000098	0.002896
1psi	6894.733	6.89473	0.006895	0.070307	51.714752	703.0167161	1	0.068947	2.036014
1bar	100000	100	0.100000	1.019716	750.062	10197.1626	14.503824	1	29.529988
1inHg	3386.388	3.386388	0.003386	0.034532	25.40022	345.315507	0.491156	0.033864	1

E.g.) For calculating 760mmHg to kPa

: According to above chart, 1mmHg is 0.133322kPa, therefore 760mmHg will be 760×0.133322kPa=101.32472kPa.

Specifications

Pressure type		Gauge pressure(In case of fluid type, negative pressure, compound pressure, 1,000kPa/standard pressure are sealed gauge pressure ^{※5})							
		Negative pressure		Standard pressure			Compound pressure		
Model ^{※1}	Voltage output	Connector	PSAN-(L)V01C (P)V-□	PSAN-(L)01C (P)V-□	PSAN-(L)1C (P)V-□	PSAN-B1 (P)V-□	PSAN-(L)C01C (P)V-□	PSAN-BC01 (P)V-□	
		Cable	—	—	—	—	—	—	
	Current output	Connector	PSAN-(L)V01C (P)A-□	PSAN-(L)01C (P)A-□	PSAN-(L)1C (P)A-□	PSAN-(L)1C (P)A-□	PSAN-(L)C01C (P)A-□	PSAN-BC01 (P)A-□	
Model ^{※1}	Hold/Auto shift input	Connector	PSAN-(L)V01C (P)H-□	PSAN-(L)01C (P)H-□	PSAN-(L)1C (P)H-□	PSAN-B1 (P)H-□	PSAN-(L)C01C (P)H-□	PSAN-BC01 (P)H-□	
		Cable	—	—	—	—	—	—	
Rated pressure range		0.0 to -101.3kPa			0.0 to 100.0kPa		0 to 1,000kPa		
Display pressure range		5.0 to -101.3kPa			-5.0 to 110.0kPa		-101.3 to 1,100kPa		
Min. display unit		0.1kPa			0.1kPa		1kPa		0.1kPa
Max. pressure range		2 times of rated pressure				1.5 times of rated pressure		2 times of rated pressure	
Applied vapor		• Pneumatic type - Air, Non-corrosive gas							
Applied fluid		• Fluid type - Air, Non-corrosive gas and fluid that do not corrode SUS316L							
Power supply		12V-24VDC ±10% (ripple P-P:Max. 10%)							
Current consumption		Max. 50mA (analog current output type: max. 75mA)							
Control output		NPN or PNP open collector output • Load voltage: max. 30VDC • Load current: max. 100mA • Residual voltage - NPN: max. 1V, PNP: max. 2V							
Hysteresis ^{※2}		Min. display interval							
Repeat error		±0.2%F.S. ± Min. display interval							
Response time		Selectable 2.5ms, 5ms, 100ms, 500ms, 1000ms							
Short circuit protection		Built-in							
Analog output ^{※3}	Voltage output	• Output voltage: 1-5VDC ±2% F.S. • Linear: Within ±1% F.S. • Output impedance: 1kΩ • Zero point: Max. 1VDC ±2% F.S. • Span: Max. 4VDC ±2% F.S. • Response time: 50ms • Resolution: Automatically changed to 1/1000 or 1/2000 by display unit							
	Current output	• Output current: DC4-20mA ±2% • Linear: Max. ±1% F.S. • Zero-point: Max. DC4mA ±2% F.S. • Span: Max. DC16mA ±2% F.S. • Response time: 70ms • Resolution: Automatically changed to 1/1000 or 1/2000 by display unit							
Display digit		4½digit							
Display method		7 segment LED Display							
Min. display interval	MPa	—	—	0.001	—	0.001	—	—	—
	kPa	0.1	—	0.1	—	1	—	—	0.1
	kgf/cm ²	0.001	—	0.001	—	0.01	—	—	0.001
	bar	0.001	—	0.001	—	0.01	—	—	0.001
	psi	—	0.01	—	0.01	—	0.1	—	0.02
	mmHg	—	0.4	—	—	—	—	—	0.8
	inHg	—	0.02	—	—	—	—	—	0.03
	mmH ₂ O	0.1	—	—	—	—	—	—	0.1
Display accuracy		0 to 50°C: max. ±0.5% F.S., -10 to 0°C: max. ±1% F.S.							
Insulation resistance		Over 50MΩ (at 500VDC megger)							
Dielectric strength		1000VAC 50/60Hz for 1 minute							
Vibration		1.5mm amplitude at frequency of 10 to 55Hz (for 1 min) in each X, Y, Z direction for 2 hours							
Environment	Ambient temp.	-10 to 50°C, storage: -20 to 60°C							
	Ambient humi.	30 to 80%RH, storage: 30 to 80%RH							
Protection structure		Connector type: IP40 (IEC standard), Cable type: IP65 (IEC standard)							
Material		• Pneumatic type - Front, Rear case: Polycarbonate, Pressure port: Nickel Plated Brass • Fluid type - Front case: Polycarbonate, Rear case: Polyamide 6, Pressure port: Stainless steel 316L							
Cable		Ø4mm, 5-wire, 2m (connector type), 3m (cable type), AWG24, Core diameter: 0.08mm, Number of cores: 40, Insulator out diameter: Ø1mm							
Approval		CE							
Weight ^{※4}		• Pneumatic type: Approx. 165g (approx. 80g) • Fluid type - Connector type: Approx. 173g (approx. 88g) • Fluid type - Cable type: Approx. 167g (approx. 90g)							

※1: For ' (L)', ' (P)', ' □ ' of model name, please refer to ' Ordering Information '.

※2: In hysteresis output mode, detection difference is variable.

※3: It is allowed to select one analog output type only.

※4: The weight includes packaging. The weight in parentheses in for unit only.

※5: The unit is sealed structure. It is based on atmospheric pressure 101.3kPa.

※F.S.: Rated pressure.

※There may be ±1digit error in hysteresis by pressure unit calculation error.

※Environment resistance is rated at no freezing or condensation.

Unit Description

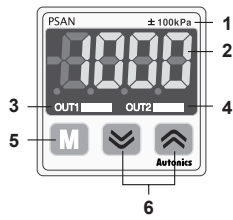

1. Range of rated pressure

: It is possible to change the pressure unit in Pressure sensor.
Please attach component label which is fit for specific indication unit.

2. 4-digit LED display (Red)

: Used to indicate measured pressure value, setting value and error message.

3. Output1 indicator (Red):

Output1 is ON, LED will be ON.

4. Output2 indicator (Green):

Output2 is ON, LED will be ON.

5. M key:

Used to enter into Preset/Parameter setting mode and to save Setting mode.

⏏, ⏏ key: Used to set parameter and preset, peak value check mode, function setting or output operation mode.

⏏+⏏ key: Used for zero point adjustment function by pressing ⏏+⏏ keys over 1 sec simultaneously in RUN mode.

Dimensions

⊙ Pneumatic type

(unit: mm)

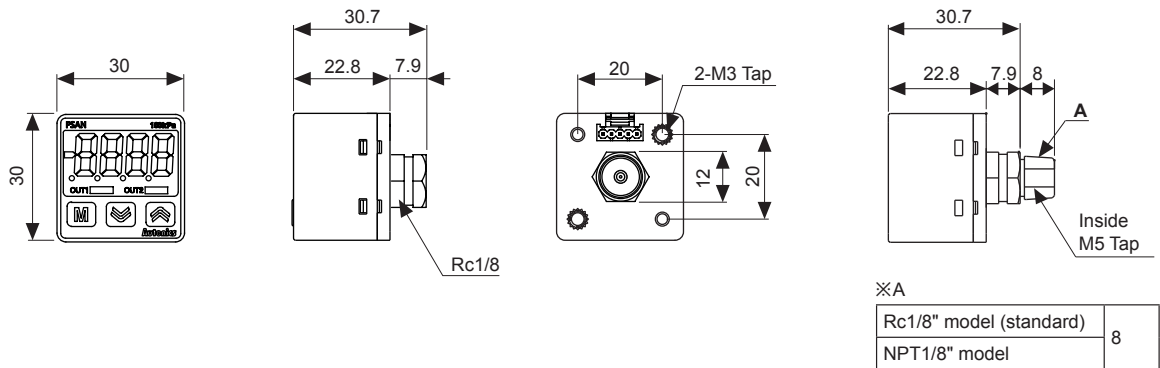

⊙ Fluid type

1. Connector type

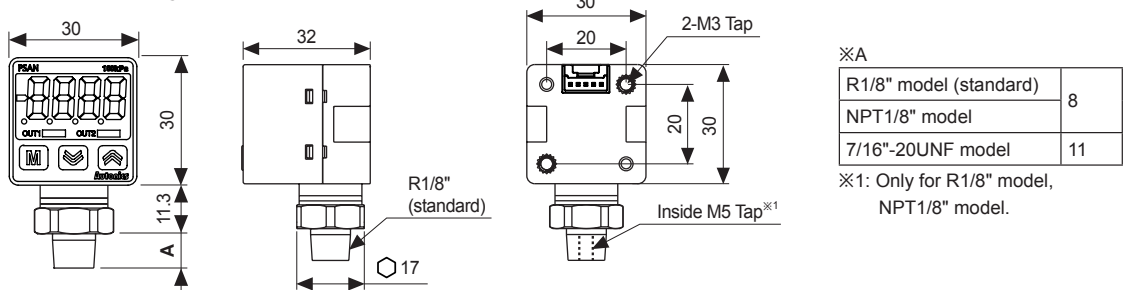

2. Cable type

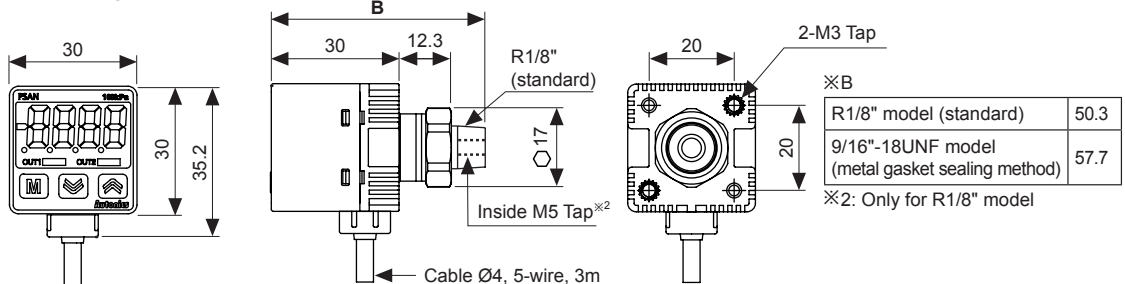

- (A) Photoelectric Sensors
- (B) Fiber Optic Sensors
- (C) Door/Area Sensors
- (D) Proximity Sensors
- (E) Pressure Sensors
- (F) Rotary Encoders
- (G) Connectors/ Connector Cables/ Sensor Distribution Boxes/Sockets
- (H) Temperature Controllers
- (I) SSRs / Power Controllers
- (J) Counters
- (K) Timers
- (L) Panel Meters
- (M) Tacho / Speed / Pulse Meters
- (N) Display Units
- (O) Sensor Controllers
- (P) Switching Mode Power Supplies
- (Q) Stepper Motors & Drivers & Controllers
- (R) Graphic/ Logic Panels
- (S) Field Network Devices
- (T) Software

PSAN Series

◎ Accessory

(unit: mm)

● Bracket A

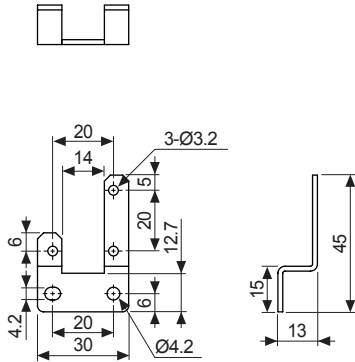

● Bracket B

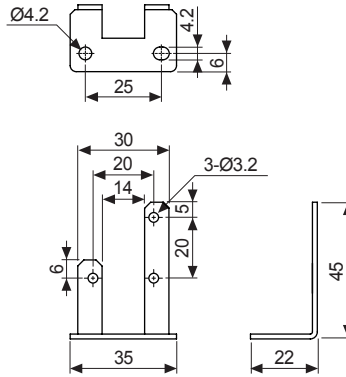

● Bracket C

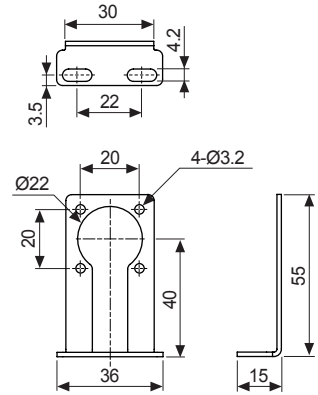

※Bracket A, B: Pneumatic type, Fluid type (connector type)
Bracket C: Fluid type (cable type)

● Pressure unit label

±100kPa	-101.3kPa	2kPa	10kPa	100kPa	1MPa
±1.020kgf/cm ²	-1.034kgf/cm ²	0.204kgf/cm ²	1.020kgf/cm ²	10.20kgf/cm ²	10.20kgf/cm ²
±14.50psf	-14.70psf	29.00psf	145.0psf	145.50psf	145.0psf
±1.00bar	-1.013bar	2.000bar	10.00bar	1.000bar	10.00bar
±29.5mmHg	-29.9mmHg			/100	/100
±102.0mmHg	-103.4mmHg	2.040mmHg	10.20mmHg	X100	X100

DISPLAY UNIT LABEL

● Connector cable (PSO-C01, 2m)

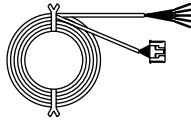

◎ Sold separately

● Front cover (PSO-P01)

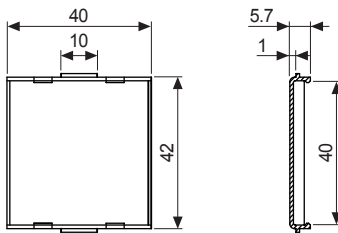

● Panel bracket (PSO-B02/B03)

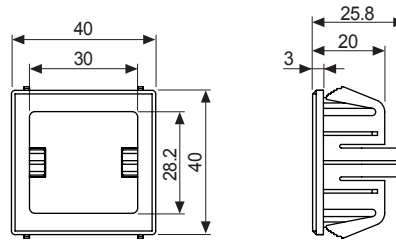

● Panel cut-out

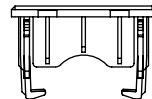
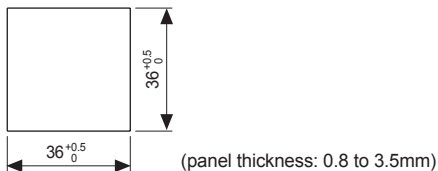

※PSO-B02 (white): Pneumatic type, Fluid type (connector type)
PSO-B03 (black): Fluid type (cable type)

Control Output Diagram

⊙ Voltage (1-5VDC) output type (PSAN-□□□□□ V-□)
 Current (DC4-20mA) output type (PSAN-□□□□□ A-□)

• NPN open collector output type

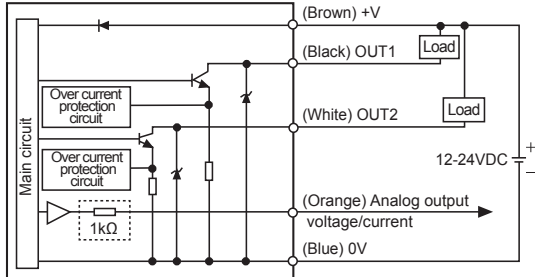

• PNP open collector output type

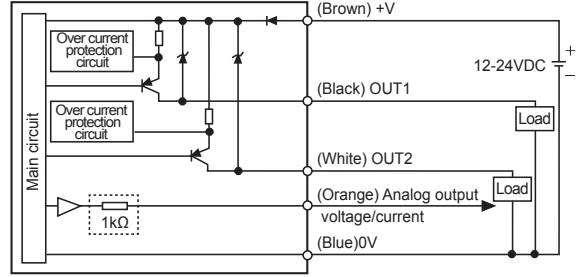

✗ In case of analog voltage output type models short-circuit protection is not embodied. (□□□□□: For voltage output type only.) Do not connect of power source or capacitive load directly.

✗ Be careful with input impedance of connecting devices when using analog voltage output type models.

✗ Be careful with voltage drop due to cable resistance when extending sensor cable.

⊙ Hold/Auto shift input (PSAN-□□□□□ H-□)

• NPN open collector output type

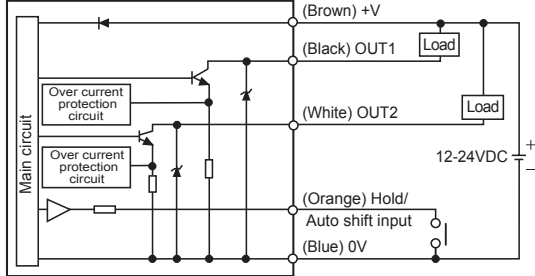

• PNP open collector output type

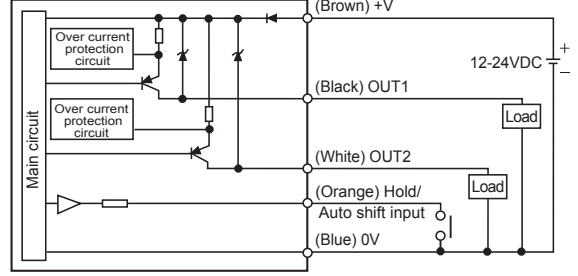

Analog Output Characteristic

• Analog output voltage and current - Pressure characteristic

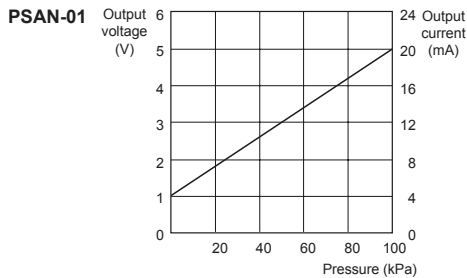

• Analog output voltage and current - Linear characteristic

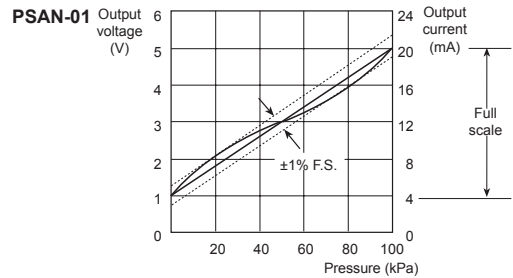

Setting

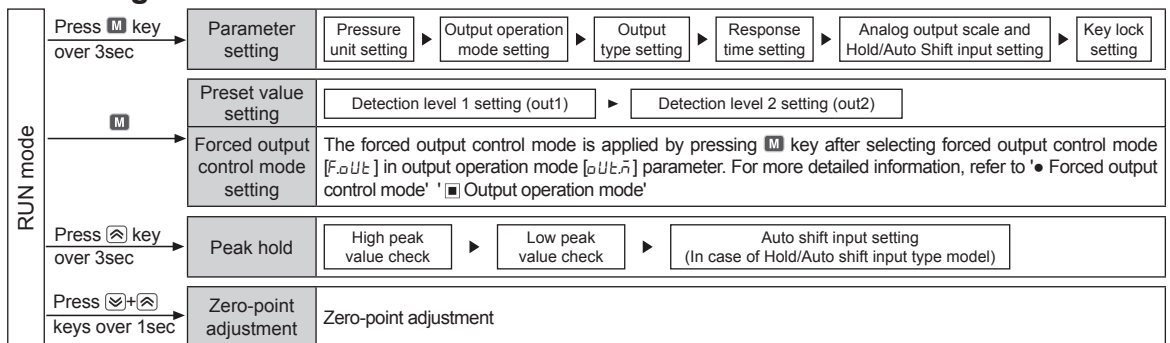

- (A) Photoelectric Sensors
- (B) Fiber Optic Sensors
- (C) Door/Area Sensors
- (D) Proximity Sensors
- (E) Pressure Sensors
- (F) Rotary Encoders
- (G) Connectors/ Connector Cables/ Sensor Distribution Boxes/Sockets
- (H) Temperature Controllers
- (I) SSRs / Power Controllers
- (J) Counters
- (K) Timers
- (L) Panel Meters
- (M) Tacho / Speed / Pulse Meters
- (N) Display Units
- (O) Sensor Controllers
- (P) Switching Mode Power Supplies
- (Q) Stepper Motors & Drivers & Controllers
- (R) Graphic/ Logic Panels
- (S) Field Network Devices
- (T) Software

Zero Point Adjustment

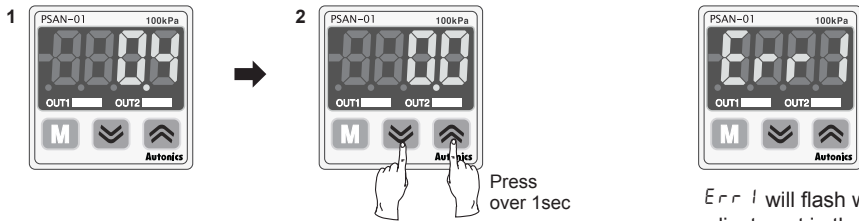

1. In state of atmospheric pressure during RUN mode, press \checkmark key and \otimes key at the same time for over 1sec
 2. When the zero-point adjustment is complet, it will display 0.0 and return to RUN mode automatically.
- ※Please execute zero-point adjustment regularly.

Err 1 will flash while you execute zero point adjustment in the condition that external pressure exists. Please execute zero-point adjustment again in state of atmospheric pressure without external pressure.

Parameter Setting

1. It is able to set pressure unit, display resolution, output operation mode, output type, Response time, analog output scale, Hold/Auto shift and key lock setting in parameter setting mode.
2. If the key lock is set (lock1 or lock2), unlock the key lock before setting parameters. (Refer to Key Lock setting below.)

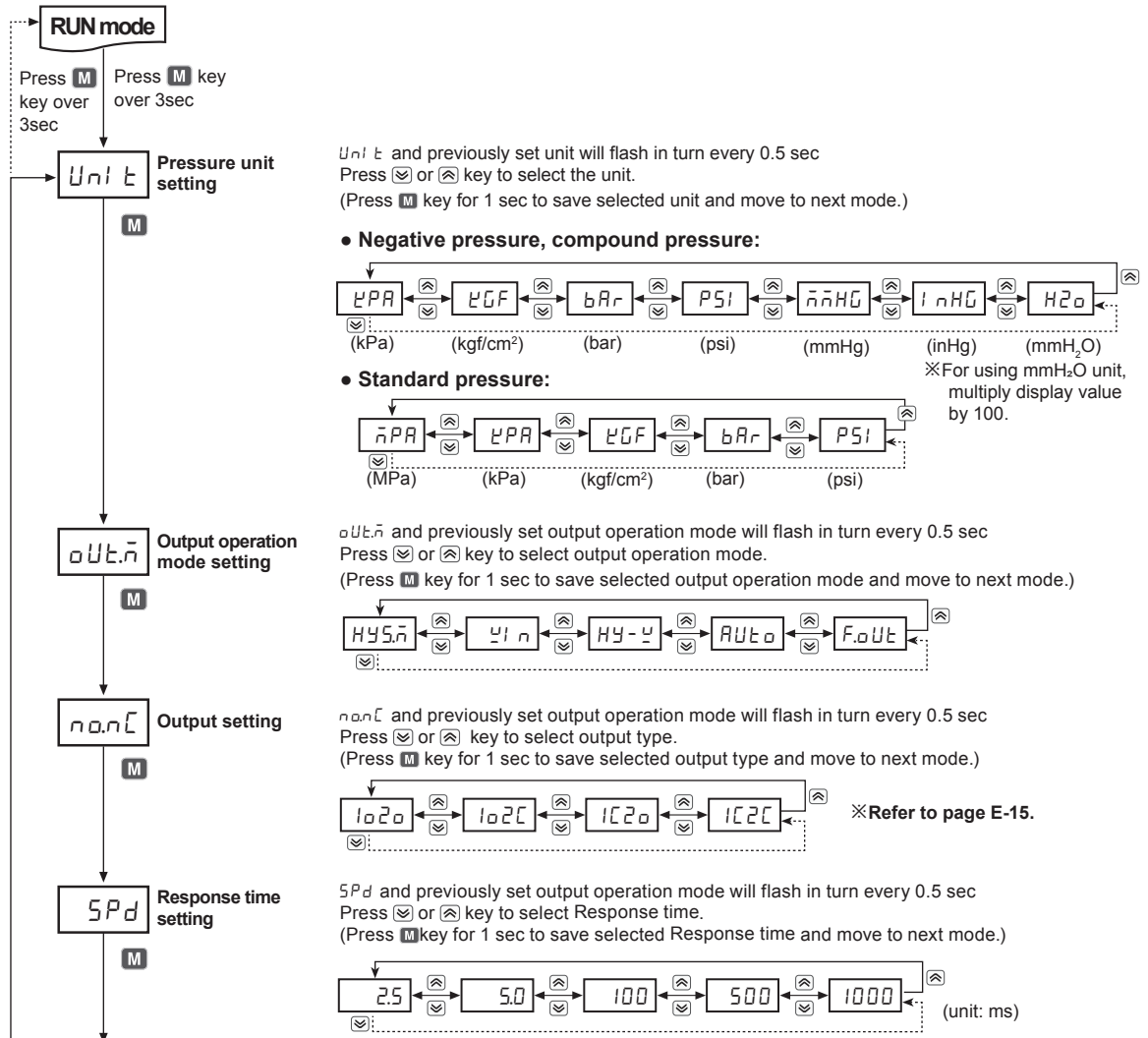

Pressure Sensor

※Refer to page E-13.

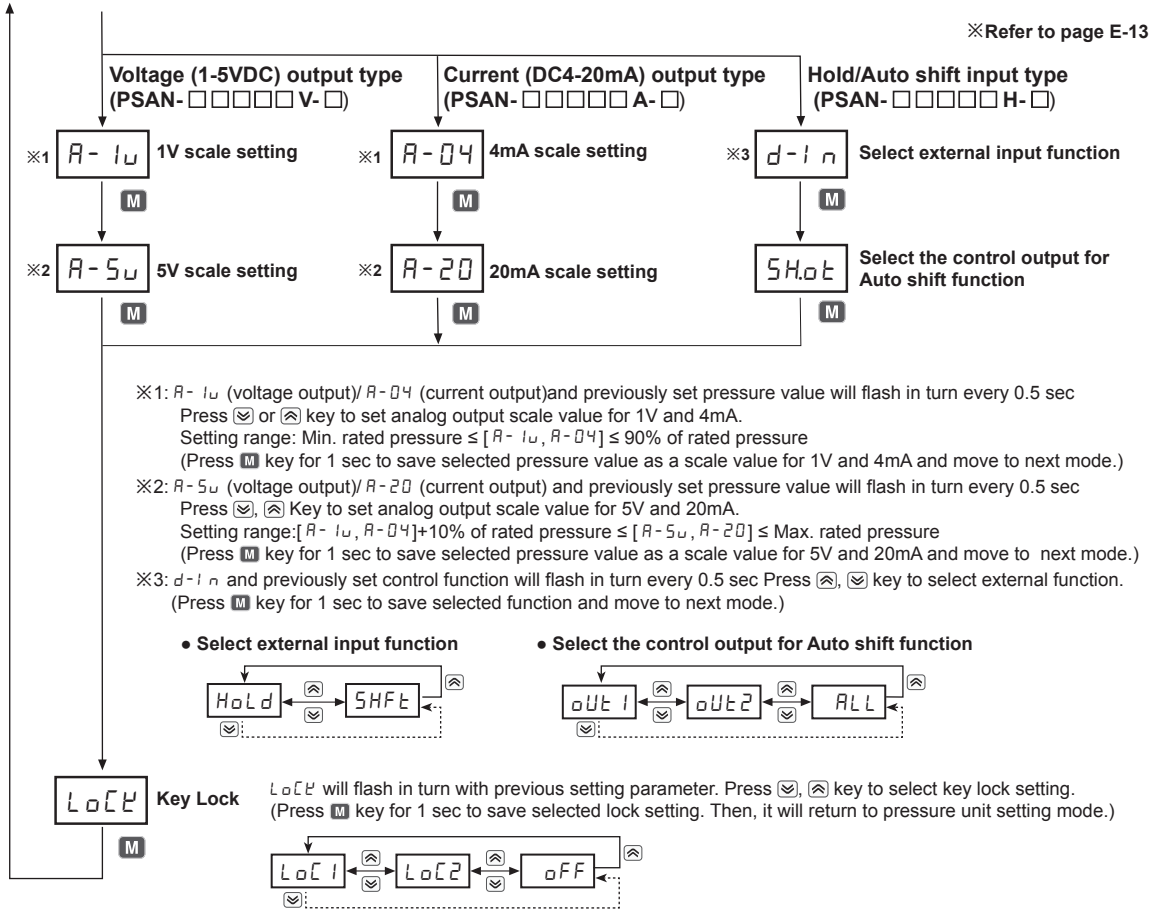

※When pressing **M** key for 3 sec in the middle of parameter setting, current setting value will be saved and it will return to RUN mode. If there is no additional key operation within 60 sec while setting, current set value is not valid and previous set value will remain.
※All settings are saved regardless of power failure. Make sure that this unit has a limited write life cycle (100,000 times).

■ Preset Setting

◎ Hysteresis mode [HY5 \bar{n}]

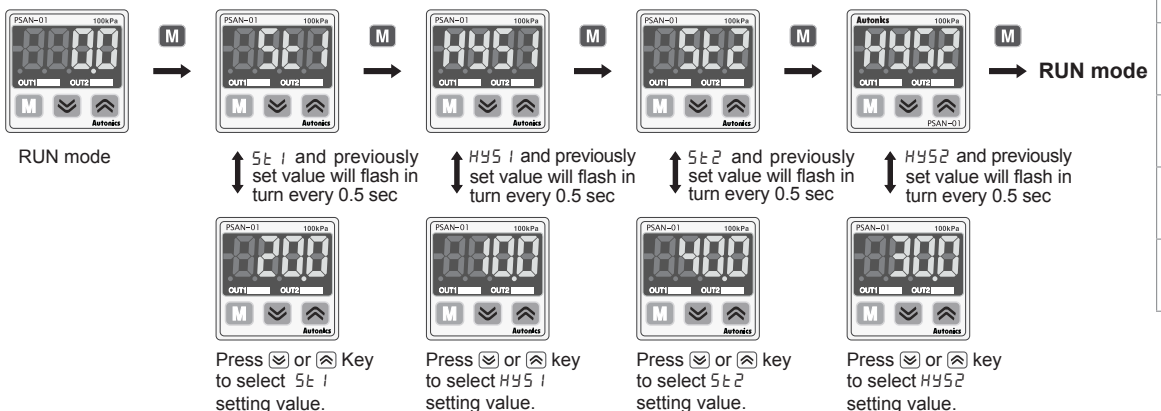

※5t1 setting range : Min. display pressure < 5t1 \leq Max. display pressure
 ※HY51 setting range : Min. display pressure \leq HY51 < 5t1
 ※5t2 setting range : Min. display pressure < 5t2 \leq Max. display pressure
 ※HY52 setting range : Min. display pressure \leq HY52 < 5t2

(A)	Photoelectric Sensors
(B)	Fiber Optic Sensors
(C)	Door/Area Sensors
(D)	Proximity Sensors
(E)	Pressure Sensors
(F)	Rotary Encoders
(G)	Connectors/ Connector Cables/ Sensor Distribution Boxes/Sockets
(H)	Temperature Controllers
(I)	SSRs / Power Controllers
(J)	Counters
(K)	Timers
(L)	Panel Meters
(M)	Tacho / Speed / Pulse Meters
(N)	Display Units
(O)	Sensor Controllers
(P)	Switching Mode Power Supplies
(Q)	Stepper Motors & Drivers & Controllers
(R)	Graphic/ Logic Panels
(S)	Field Network Devices
(T)	Software

◎ Window comparison output mode [ㄩ ㄷ]

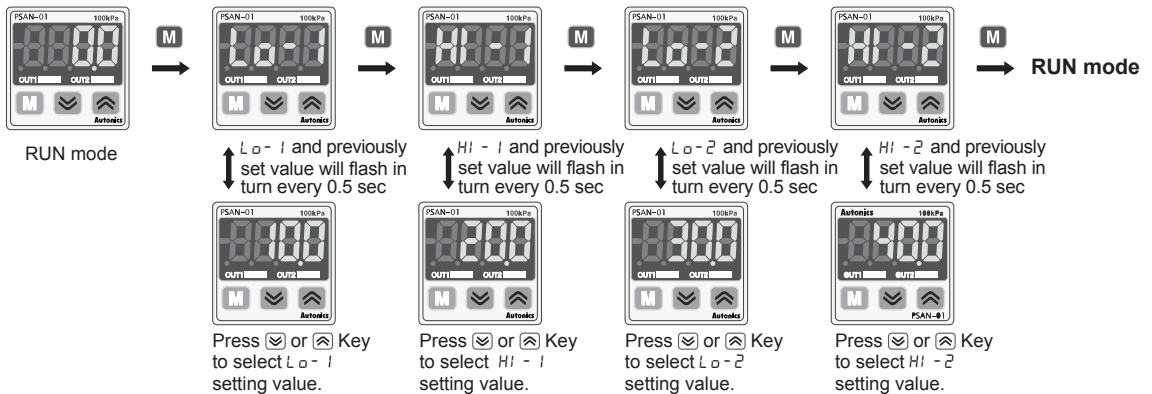

※ $L0-1$ setting range: Min. display pressure $\leq L0-1 \leq$ Max. display pressure - (3×min. display interval)

※ $H1-1$ setting range: $L0-1 + (3 \times \text{min. display interval}) \leq H1-1 \leq$ Max. display pressure

※ $L0-2$ setting range: Min. display pressure $\leq L0-2 \leq$ Max. display pressure - (3×min. display interval)

※ $H1-2$ setting range: $L0-2 + (3 \times \text{min. display interval}) \leq H1-2 \leq$ Max. display pressure

※ The minimum display interval for hysteresis is fixed to 1.

◎ Hysteresis-Window comparison output mode [ㄩ ㄷ]

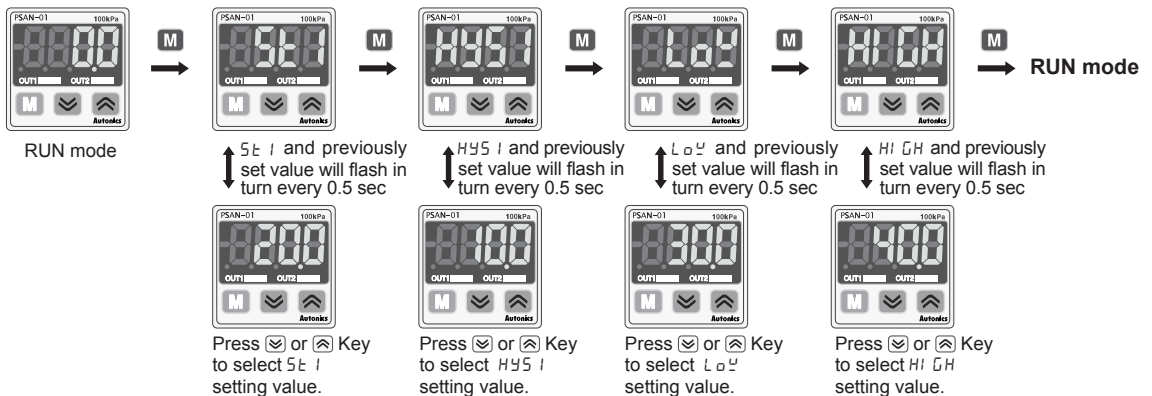

※ $5t1$ setting range: Min. display pressure $< 5t1 \leq$ Max. display pressure

※ $HYS1$ setting range: Min. display pressure $\leq HYS1 < 5t1$

※ $L0H$ setting range: Min. display pressure $\leq L0H \leq$ Max. display pressure - (3×min. display interval)

※ $H1GH$ setting range: Low value + (3×min. display interval) $\leq H1GH \leq$ Max. display pressure

※ In case $HYS1$ and $5t1$ have the same setting values, it will have the minimum display unit as a hysteresis.

◎ Automatic sensitivity setting mode [ㄹ ㄷ ㄱ]

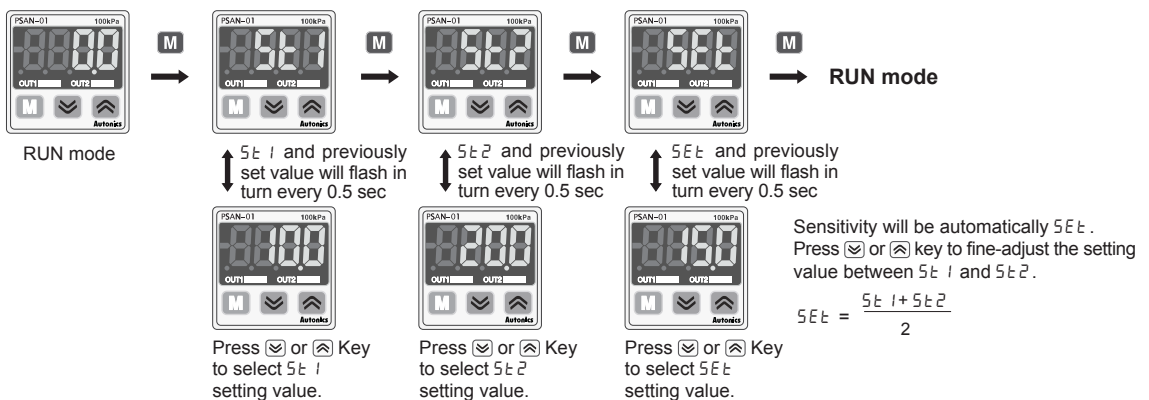

※ $5t1$ setting range: Min. display pressure $< 5t1 \leq$ Max. display pressure - 1% of rated pressure

※ $5t2$ setting range: $5t1 + 1\%$ of rated pressure $< 5t2 \leq$ Max. display pressure

※ If certain detection level difference is not ensured, or setting conditions are not met, $Err3$ message will flash three times and return to $5t2$ setting mode. Check all setting conditions and set proper setting values.

Ⓞ Forced output control mode [F.oUt]

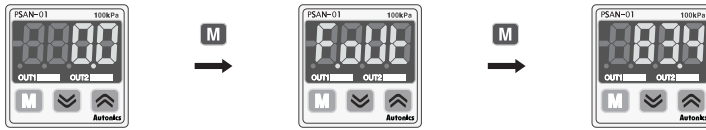

If forced output control mode is selected, pressure value is displayed only. (No output will be provided.)

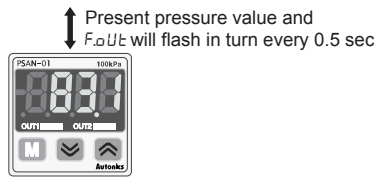

- ⊗ When there is no additional key operation within 60 sec while setting, it returns to Run mode (Except for force output mode). Previously set values remain.
- ⊗ In case of changing output operation mode, no preset values will be initialized. Instead, previous output operation settings will become the preset values.
- ⊗ When using the forced output function, Hold/Auto shift function is not available to use in Hold/Auto shift model.
- ⊗ When changing pressure display unit, resolution, and Hold Auto shift input function, preset values will be initialized as shown on the next table. (When changing pressure display unit, preset value will be automatically switched to changed pressure unit.)

• Factory default

(unit: kPa)

Output mode	Negative pressure 0.0 to -101.3	Standard pressure 0.0 to 100.0	Standard pressure 0 to 1,000	Compound pressure -101.3 to 100.0
<i>Hy5.n</i>	5Et 1:-50.0 Hy5 1:0.0 5Et 2:-50.0 Hy5 2:0.0	5Et 1:50.0 Hy5 1:0.0 5Et 2:50.0 Hy5 2:0.0	5Et 1:500 Hy5 1:0 5Et 2:500 Hy5 2:0	5Et 1:50.0 Hy5 1:-50.0 5Et 2:50.0 Hy5 2:-50.0
<i>Hy.n</i>	Lo- 1:0.0 Hi- 1:-50.0 Lo- 2:0.0 Hi- 2:-50.0	Lo- 1:0.0 Hi- 1:50.0 Lo- 2:0.0 Hi- 2:50.0	Lo- 1:0 Hi- 1:500 Lo- 2:0 Hi- 2:500	Lo- 1:-50.0 Hi- 1:50.0 Lo- 2:-50.0 Hi- 2:50.0
<i>Hy-u</i>	5Et 1:-50.0 Hy5 1:0.0 Lo 1:0.0 Hi GH:-50.0	5Et 1:50.0 Hy5 1:0.0 Lo 1:0.0 Hi GH:50.0	5Et 1:500 Hy5 1:0 Lo 1:500 Hi GH:0	5Et 1:50.0 Hy5 1:-50.0 Lo 1:-50.0 Hi GH:50.0
<i>Auto</i>	5Et 1:0.0 5Et 2:-50.0 5Et 1:-25.0	5Et 1:0.0 5Et 2:50.0 5Et 1:25.0	5Et 1:0 5Et 2:500 5Et 1:250	5Et 1:-50.0 5Et 2:50.0 5Et 1:0.0

■ High Peak/Low Peak Function And Auto Shift Reference Pressure Check/Change

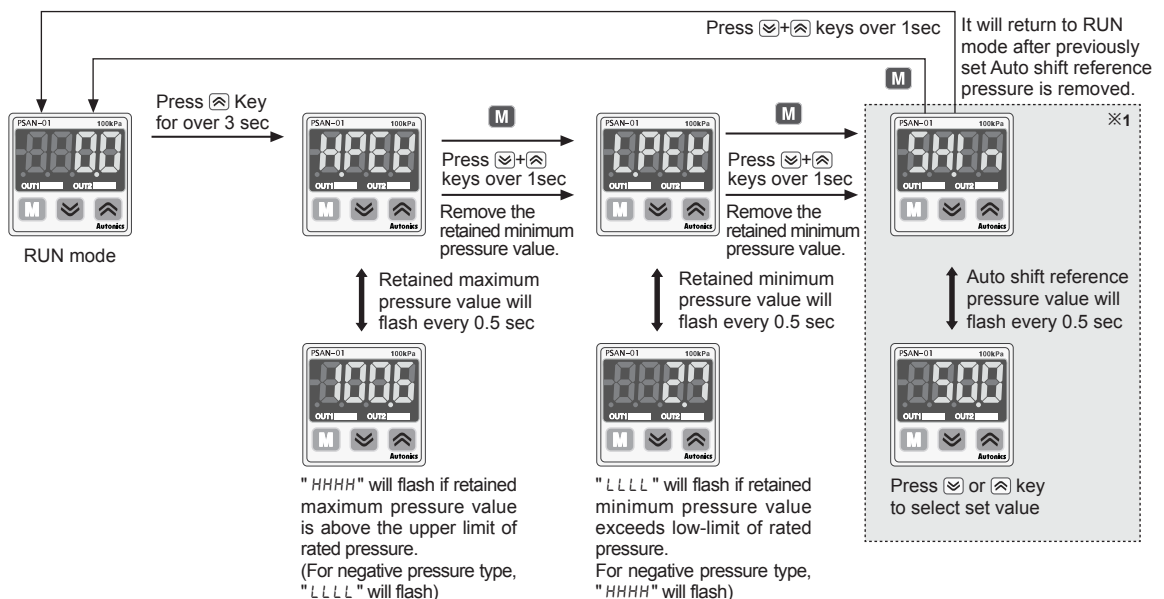

- ⊗1: Displayed only when *d-n* is set to *SHFt* (PSAN-□□□□H□ models only)
- ⊗ If there is no Auto shift input, "0" will be displayed. (Refer to page E-15 for more details.)

- (A) Photoelectric Sensors
- (B) Fiber Optic Sensors
- (C) Door/Area Sensors
- (D) Proximity Sensors
- (E) Pressure Sensors
- (F) Rotary Encoders
- (G) Connectors/ Connector Cables/ Sensor Distribution Boxes/Sockets
- (H) Temperature Controllers
- (I) SSRs / Power Controllers
- (J) Counters
- (K) Timers
- (L) Panel Meters
- (M) Tacho / Speed / Pulse Meters
- (N) Display Units
- (O) Sensor Controllers
- (P) Switching Mode Power Supplies
- (Q) Stepper Motors & Drivers & Controllers
- (R) Graphic/ Logic Panels
- (S) Field Network Devices
- (T) Software

Output Operation Mode

1. Hysteresis mode [HY5n]

It is able to set certain value for pressure detection level [SE1, SE2] and hysteresis [HYS1, HYS2].

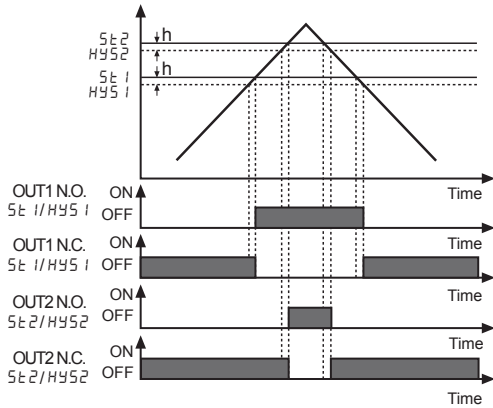

2. Window comparison output mode [ULn]

- It is able to set the range for high [HI-1, HI-2], low [LO-1, LO-2] limit of pressure detection level when it is required to detect pressure at a certain range.
- Detection hysteresis is fixed to min. display range.

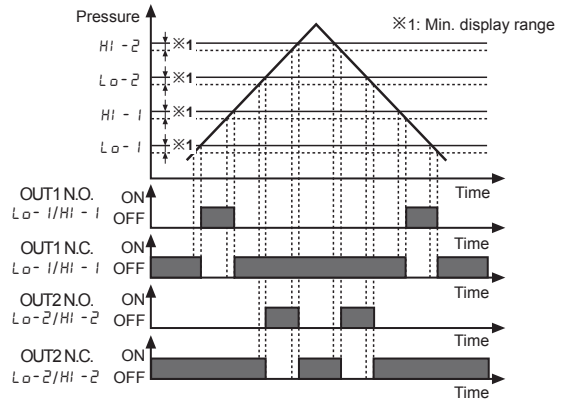

3. Hysteresis-window comparison output mode [HY-U]

- It is available to set hysteresis mode and window comparison output mode when both hysteresis mode [SE1, SE2] and window comparison output mode [LO-U, HI-UH] are necessary.
- Detection hysteresis is fixed to min. display range.

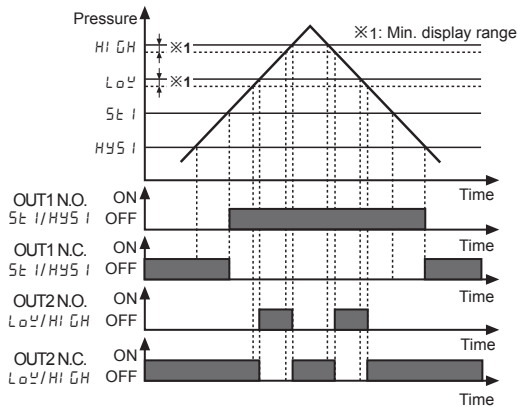

4. Automatic sensitivity setting mode [AUTa]

- This function is to set pressure detection level to the proper position automatically. It is set by applied pressure from two positions [SE1, SE2].
- Detection hysteresis is fixed to min. display range.
- The pressure detection level [SEt] is shown in the following calculation.

$$SEt = \frac{(SE1 + SE2)}{2}$$

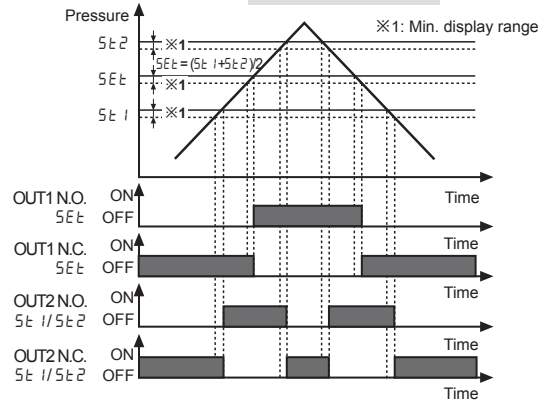

5. Forced output control mode [FOUT]

- Used to display pressure with forcibly holding comparing output OFF regardless of setting value.
- In parameter setting, if output operation mode setting 'OUTn' is changed to 'FOUT', forced output control mode is operated.
- Output 1, 2 can be ON/OFF manually by pressing [M], [M] key while the forced output control mode is applied.

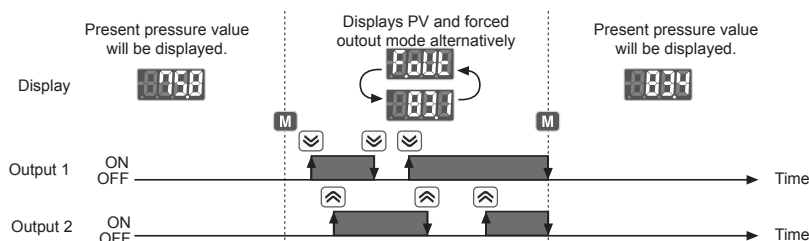

■ Functions

◎ Pressure unit change

PSAN-V01C (P) and PSAN-C01C (P) has 7 kinds of pressure unit, PSAN-01C (P) and PSAN-1C (P) has 5 kinds of pressure unit. Please select the proper unit for application.

- PSAN-V01C (P), PSAN-C01C (P)
: kPa, kgf/cm², bar, psi, mmHg, inHg, mmH₂O
- PSAN-01C (P), PSAN-1C (P) : MPa, kPa, kgf/cm², bar, psi
- ※When using mmH₂O unit, multiply display value by 100.

◎ Output mode change

There are 5 kinds of control output mode in order to realize the various pressure detection.

- **Hysteresis mode [HYS]**
When needed to change hysteresis for detecting pressure.
- **Window comparison output mode [W]**
When needed to detect pressure in certain area.
- **Hysteresis - Window comparison output mode [HW]**
When both hysteresis mode and window comparison output mode are required.
- **Automatic sensitivity setting mode [AUT]**
When needed to set detection sensitivity automatically at proper position.
- **Forced output control mode [FOUT]**
When needed to display pressure with remaining comparison output OFF regardless of setting value.

◎ Control output change

Type of control output for Out1 and Out2 can be able to set Normally Open or Normally Closed.

※Note that Normally Open and Normally Closed provide opposite output.

OUT1 output	OUT2 output	Parameter setting value
Normally Open	Normally Open	1020
Normally Open	Normally Closed	1021
Normally Closed	Normally Open	1120
Normally Closed	Normally Closed	1121

◎ Response time change (chattering prevention)

It can prevent chattering of control output by changing Response time. It is able to set 5 kinds of Response time (2.5ms, 5ms, 100ms, 500ms, 1000ms) and if the Response time is getting longer, the detection will be more stable by increasing the number.

◎ Analog output scale setting

• **Analog voltage output scale setting**
The scale function for analog output voltage (1-5VDC) is not fixed to the rated pressure range. It can be changed for User's application. Analog output voltage range will be fixed to 1-5VDC within the pressure range from pressure point of 1VDC output [R-1V] to pressure point of 5VDC output [R-5V].

• **Analog current output scale setting**
The scale for analog output Current (DC4-20mA) is not fixed to the rated pressure range. It can be changed for User's application. Analog output voltage will be fixed to DC4-20mA within the rated pressure range from pressure point of 4mA output [R-04] to pressure point of 20mA output [R-20].

◎ Hold/Auto shift input setting

• Hold

A function to hold present pressure value and control output at the time of hold signal input.

※Present pressure value and Hold message will flash in turn every 0.5 sec while Hold function is set. Make sure that Hold function is not able to execute while forced output mode is executed.

▶ Control output timing chart

When Hold signal is applied in Hysteresis mode, refer to 'Control output diagram' of page E-9.

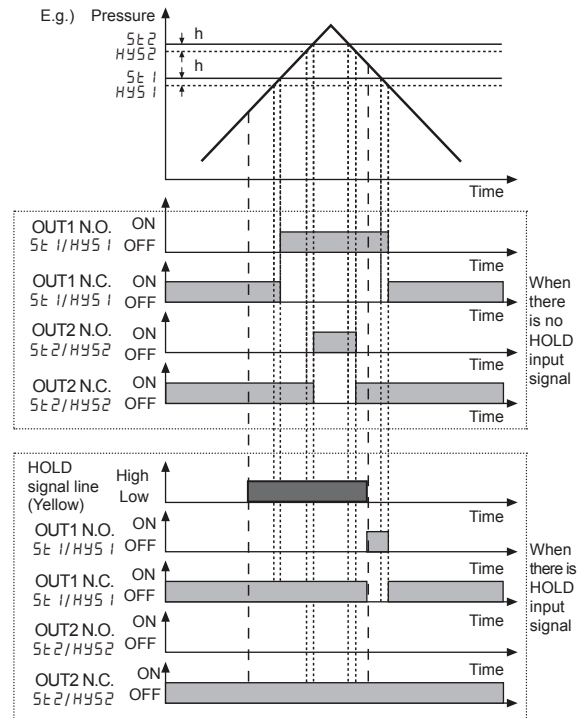

※[Hold] and present pressure value will flash in turn every 0.5 sec while Hold signal is applied.

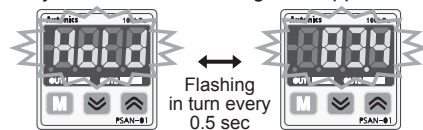

• Auto shift

A function to use the measured pressure at the moment of auto shift input as a reference pressure in order to correct the set point values of control output when initial pressure changes.

- ※Reference pressure is fixed to atmospheric pressure (0.0kPa) when Auto shift function is not used.
- ※SH (Auto shift compensation value) will be reset to 0 when changing control output or preset values.
- ※Auto shift function will not be executed if "HHHH" or "LLLL" error occurs or if forced output mode is set.
- SH: Reference pressure change through setting.
- 01: Changed reference will be applied to control output 1 only.
- 02: Changed reference will be applied to control output 2 only.
- RL: Changed reference will be applied to both control output 1 and control output 2.

(A) Photoelectric Sensors

(B) Fiber Optic Sensors

(C) Door/Area Sensors

(D) Proximity Sensors

(E) Pressure Sensors

(F) Rotary Encoders

(G) Connectors/ Connector Cables/ Sensor Distribution Boxes/Sockets

(H) Temperature Controllers

(I) SSRs / Power Controllers

(J) Counters

(K) Timers

(L) Panel Meters

(M) Tacho / Speed / Pulse Meters

(N) Display Units

(O) Sensor Controllers

(P) Switching Mode Power Supplies

(Q) Stepper Motors & Drivers & Controllers

(R) Graphic/ Logic Panels

(S) Field Network Devices

(T) Software

PSAN Series

► When Auto shift is used

When Auto shift input signal remains at low level more than 1ms, the measured pressure at this point will be saved as a reference value to make correct judgment regardless of pressure changes. Corrected preset pressure value will be applied after 7.5ms.

Measured reference pressure value will be saved in [5HI n].

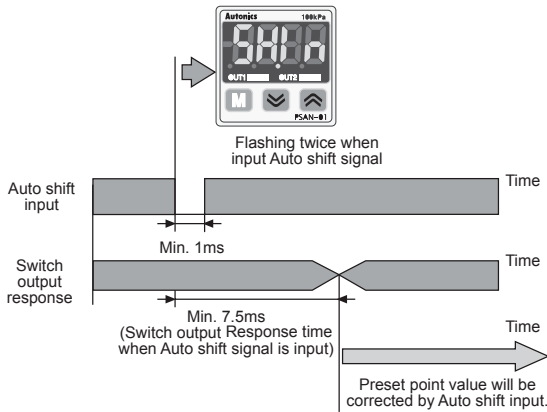

※When Auto shift function is used, the possible set pressure range will be wider than rated set pressure range.

※The possible set pressure range for Auto shift type models.

Pressure type	Set pressure range	Possible set pressure range for Auto shift type models
Vacuum pressure	-101.3kPa to 5.0kPa	-101.3kPa to 101.3kPa
Vacuum pressure	-5.0kPa to 110.0kPa	-110.0kPa to 110.0kPa
Compound pressure	-101.3kPa to 110.0kPa	-101.3kPa to 110.0kPa

※If the set point value corrected by auto shift input exceeds set pressure range, an error message will flash three times and corrected value is not saved.

→[-HH-] displayed when the set point value corrected by Auto shift input is above the upper limit of set pressure range.

→[-LLL-] displayed when the set point value corrected by Auto shift input is below the lower limit of set pressure range.

► Example of Auto shift

< When Auto shift is not used >

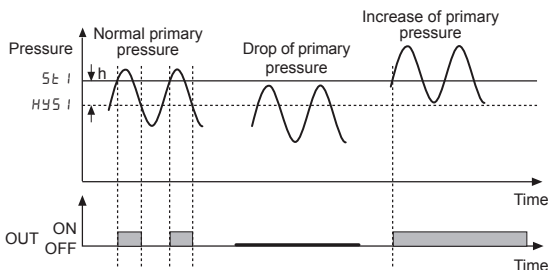

< When Auto shift is used >

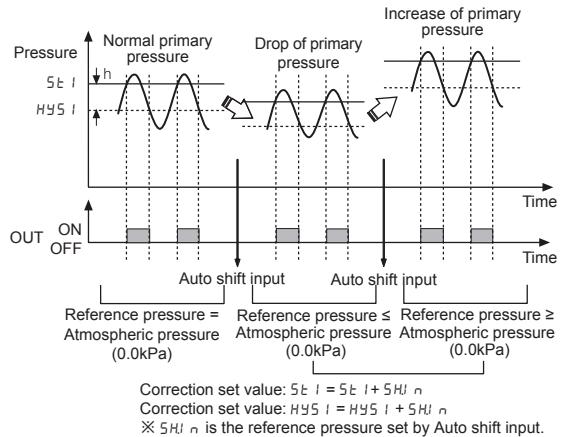

◎ Key lock

The key lock function prevents key operations so that conditions set in each mode.

- **L o C 1**: All keys are locked; therefore it is not available to change parameter settings, preset value, zero adjustment, High/Low peak check, and 5HI n data initialization. (Lock setting change is available)
- **L o C 2**: Partially locked status; therefore it is not available to change parameter settings only (Lock setting change is available). Other settings are still available.
- **o F F**: All of the setting is available, all keys are unlocked. to set detection sensitivity automatically at proper position.

◎ Zero-point adjustment

The key lock function prevents key operations so that conditions set in each mode.

The zero-point adjustment function forcibly sets the pressure value to "zero" when the pressure port is opened to atmospheric pressure. When the zero adjustment is applied, analog output [Voltage or Current] is changed by this function.

(Press + keys over 1 sec in RUN mode.)

◎ High Peak / Low Peak Hold

This function is to diagnosis malfunction of the system caused by parasitic pressure or to check through memorizing the max./min. pressure occurred from the system.

Error display	Description	Troubleshooting
Err 1	When external pressure is input while adjusting zero point	Try again after removing external pressure
Err 2	When overload is applied on control output	Remove overload
Err 3	When setting condition is not met in Auto sensitivity setting mode	Check setting conditions and set proper setting values
LLLL	When applied pressure exceeds Low-limit of display pressure range	Apply pressure within display pressure range
HHHH	When applied pressure exceeds High-limit of display pressure range	
-HH- -LL- -Ho-	Auto shift correction error	Set the corrected setting value within setting pressure range.

■ Installation

- Pressure port is divided as standard and option specification. Therefore, be sure that to use commercially available one touch fitting.
 - Standard
Pneumatic type: Rc1/8", Fluid type: R1/8"
 - Option
Pneumatic type: NPT1/8", R1/8"
Fluid type: Connector type-NPT1/8", 7/16"-20UNF
Cable type-9/16"-18UNF
- Please connect it by using spanner (pneumatic type 12mm, fluid type 17mm) at the metal part in order not to overload on the body when connecting one touch fitting.

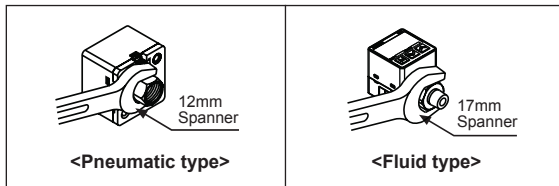

⚠ Caution

The tightening torque of one touch fitting should be max.10N·m. If not, it may cause mechanical problem.

- Two different brackets are provided for pneumatic type and three different brackets are provided for fluid type. Select proper one with considering your application environments.
- At first, please unscrew hexagon wrench bolt and assemble the bracket on this unit by fixing hexagon the wrench bolt.

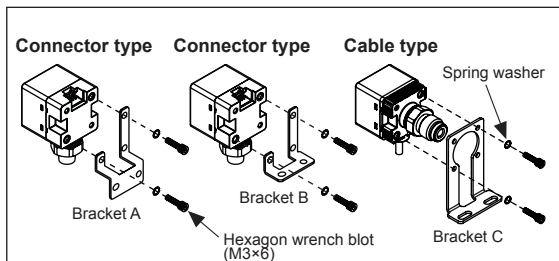

⚠ Caution

In this case, tightening torque of hexagon wrench should be max. 3N·m. If not, it may cause mechanical problem.

- Panel bracket (PSO-B02/B03) and front cover (PSO-P01) are sold separately. Please see the pictures for installation.

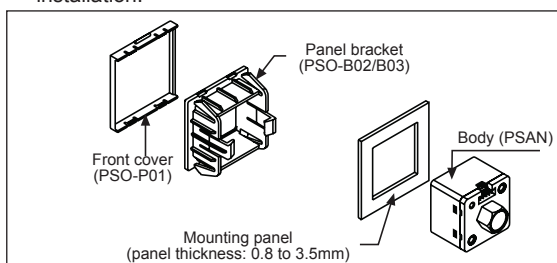

■ Proper Usage

⚠ Caution

PSAN Series is for sensing of non corrosive gas. Do not use this product at corrosive gas or flammable gas, etc.

- Please using this unit within the range of specification, if applying pressure is larger than specification, it may not be working properly due to damage.
- After supplying power, it takes 3 sec to work.
- When using switching mode power supply, frame ground (F.G.) terminal of power supply should be grounded.

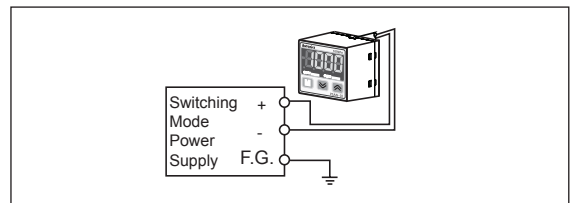

- It may cause malfunction by noise, when wiring with power line or high voltage line.
- Do not insert any sharp or pointed object into pressure port. It may cause mechanical problem due to sensor damage.
- Do not use this unit with flammable gas, because this is not an explosion proof structure.
- Be sure that this unit should not be contacted directly with water, oil, thinner, etc.

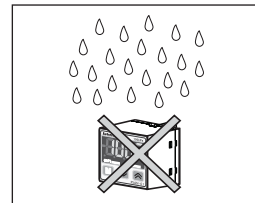

- Wiring must be done with power off.

(A) Photoelectric Sensors

(B) Fiber Optic Sensors

(C) Door/Area Sensors

(D) Proximity Sensors

(E) Pressure Sensors

(F) Rotary Encoders

(G) Connectors/ Connector Cables/ Sensor Distribution Boxes/Sockets

(H) Temperature Controllers

(I) SSRs / Power Controllers

(J) Counters

(K) Timers

(L) Panel Meters

(M) Tacho / Speed / Pulse Meters

(N) Display Units

(O) Sensor Controllers

(P) Switching Mode Power Supplies

(Q) Stepper Motors & Drivers & Controllers

(R) Graphic/ Logic Panels

(S) Field Network Devices

(T) Software