

DIN W72×H36mm, W96×H48mm, digital multi panel meter

■ Features

- Super version of panel meter
- Various output options(Default : Indicator)
RS485 Communication output, Low speed serial output, Current(4-20mA), BCD output, NPN/PNP open collector output, Relay output
- Max. measuring input specification : 500VDC, 500VAC, 5ADC, 5ACA
- Max. display range : -1999 to 9999
- High/Low scale function
- **AC frequency measurement function : 0.1 to 9999Hz**
- Various functions : Monitoring function for max. and min. display value function, display cycle delay function, **Zero function**, High display correction function, **Current output scale function**
- Wide range of power supply : 12-24VDC, 100-240VAC 50/60Hz



⚠ Please read "Caution for your safety" in operation manual before using.



※ Upgraded version is released on April of 2006.
Refer to the 4th Autonics catalogue for the before version.

■ Ordering information

MT 4 W - DV - 4 N

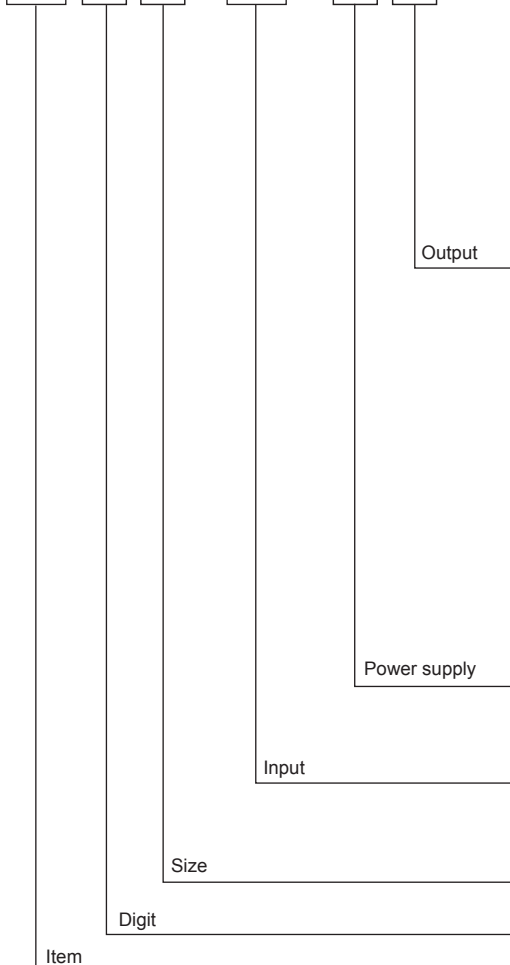

N	Indicator(Without output function)
0	Relay contact output
1	NPN open collector output
2	PNP open collector output
3※1	Relay contact output+Transmission output(DC4-20mA)
4※1	Relay contact output+RS485 communication output
5	BCD dynamic output
6	Low speed serial output

※Output(0 to 6) : Option

N	Indication type(No output function)
0	Relay contact output+Transmission output(DC4-20mA)
1	Relay contact output
2	NPN open collector output+BCD dynamic output
3	PNP open collector output+BCD dynamic output
4	NPN open collector output+Transmission output(DC4-20mA)
5	PNP open collector output+Transmission output(DC4-20mA)
6	NPN open collector output+Low speed serial output
7	PNP open collector output+Low speed serial output
8	NPN open collector output+RS485 output
9	PNP open collector output+RS485 output

※Output(0 to 9) : Option

1※2	12-24VDC
4	100-240VAC 50/60Hz
DV	DC Voltage
DA	DC Ampere
AV	AC Voltage
AA	AC Ampere
Y	DIN W72×H36mm
W	DIN W96×H48mm
4	9999(4digit)
MT	Multi meter

※1: Relay contact output of 3, 4 is able only to Low out.

※2: Only for MT4W.

※To measure the current over DC 5A, please select DV type because the shunt should be used.

※In case of selecting frequency display, no output will be provided even if it is output support models. (Main output, Sub output and RS485 output)

(A)	Photo electric sensor
(B)	Fiber optic sensor
(C)	Door/Area sensor
(D)	Proximity sensor
(E)	Pressure sensor
(F)	Rotary encoder
(G)	Connector/Socket
(H)	Temp. controller
(I)	SSR/ Power controller
(J)	Counter
(K)	Timer
(L)	Panel meter
(M)	Tacho/ Speed/ Pulse meter
(N)	Display unit
(O)	Sensor controller
(P)	Switching mode power supply
(Q)	Stepper motor& Driver&Controller
(R)	Graphic/ Logic panel
(S)	Field network device
(T)	Software
(U)	Other

MT4Y/MT4W Series

Specifications

Series	MT4Y-DV-4□ MT4Y-DA-4□	MT4Y-AV-4□ MT4Y-AA-4□	MT4W-DV-4□ MT4W-DA-4□	MT4W-AV-4□ MT4W-AA-4□	MT4W-DV-1□ MT4W-DA-1□	MT4W-AV-1□ MT4W-AA-1□
Measurement input	DC voltage, ampere	AC voltage, ampere, Frequency	DC voltage, ampere	AC voltage, ampere, Frequency	DC voltage, ampere	AC voltage, ampere, Frequency
Power supply	100-240VAC 50/60Hz (Allowable voltage range: 90 to 110%)				12-24VDC (Allowable voltage range: 90 to 110%)	
Power consumption	5VA				5W	
Display method	7Segment LED display(red)(Character height: 14.2mm)					
Display accuracy	• 23°C±5°C - DC Type: F.S. ±0.1% rdg±2digit / AC Type: F.S. ±0.3% rdg±3digit DC/AC Type F.S. +0.3% rdg +3digit max. only for 5A terminal. • -10°C to 50°C - DC/AC Type: F.S.±0.5% rdg±3digit					
Max. allowable input	110% F.S for each measured input range					
A/D conversion method	Practical oversampling using successive approximation ADC					
Sampling cycle	DC type: 50ms, AC type: 16.6ms					
Max. indication range	-1999 to 9999(4digit)					
Preset output	• Relay output - Contact capacity: 250VAC 3A, 30VDC 3A / Contact composition: N.O(1a) • NPN/PNP Open collector output - 12-24VDC ±2V 50mA Max. (Resistive load)					
Sub output (Transmission output)	• RS485 communication output - Baud rate: 1200/2400/4800/9600, Communication method: 2-wire half duplex, Synchronous method: Asynchronous method, Protocol: Modbus type • Serial/BCD output - NPN Open collector output: 12-24VDC Max. 50mA(Resistive load) • DC4-20mA output - Resolution: 12,000 division(Load resistance max. 600Ω)					
AC measuring function※1	Selectable RMS or AVG					
Frequency measurement function※1	Measurement range : 0.100 to 9999Hz(Variable by decimal point position)					
Hold function※2	Includes(External hold function)					
Insulation resistance	Min. 100MΩ(at 500VDC megger) between external terminal and case					
Dielectric strength	2,000VAC for 1minute between external terminal and case					
Noise strength	±2kV the square wave noise(pulse width : 1μs) by the noise simulator					
Vibration	Mechanical	0.75mm amplitude at frequency of 10 to 55Hz(for 1 min.) in each of X, Y, Z directions for 2hours				
	Malfunction	0.5mm amplitude at frequency of 10 to 55Hz(for 1 min.) in each of X, Y, Z directions for 10minutes				
Shock	Mechanical	100m/s²(approx. 10G) in each of X, Y, Z directions for 3 times				
	Malfunction	300m/s²(approx. 30G) in each of X, Y, Z directions for 3 times				
Relay life cycle	Malfunction	Min. 20,000,000 operations				
	Mechanical	Min. 100,000 operations(250VAC 3A Load current)				
Environ-ment	Ambient temperature	-10 to 50°C, storage: -20 to 60°C				
	Ambient humidity	35 to 85%RH, storage: 35 to 85%RH				
Insulation type	Double insulation or reinforced insulation (Mark: □, dielectric strength between the measuring input part and the power part: 1kV)					
Approval	CE c RU us				CE	
Unit weight	Approx. 134g			Approx. 211g		

※1: AC measuring function, and frequency measuring function are only for AC measuring input type.

If only frequency input the AC type(display method of measuring input) which option is in MT4W, MT4W will operate the only indicating type.

※2: MT4Y-□-4N model has no hold function.

※Environment resistance is rated at no freezing or condensation.

Front panel identification

MT4Y Series



1. HI : High output indication of preset
2. GO : GO output indication of preset
3. LO : Low output indication of preset

MT4W Series

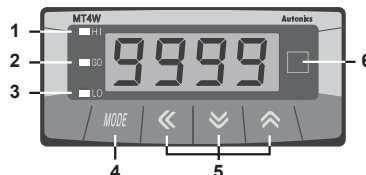

4. MODE key : Mode Key
5. [Left Arrow] : Moves digit, enters parameter mode, [Right Arrow] : changes SV
6. Unit label part

※There is no 1, 2, 3 on a display panel of MT4Y-□-4N, 45, 46 and MT4W-□-4N.

※In MT4Y-□-□3, □4, OUT is used for Go output display and there is no 1, 3 in display panel.

■ Connections

◎ Measuring input connection of MT4Y Series

● MT4Y-DV-4□

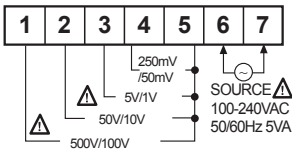

● MT4Y-AV-4□

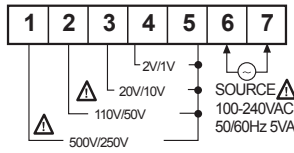

● MT4Y-DA-4□

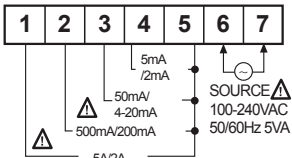

● MT4Y-AA-4□

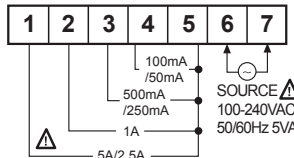

◎ Output terminal of connection of MT4Y Series

● MT4Y-□-4N (Indicator)

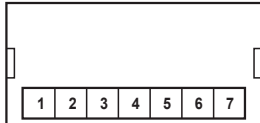

● MT4Y-□-40

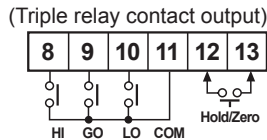

● MT4Y-□-41

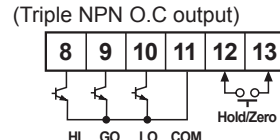

● MT4Y-□-42

(Triple PNP O.C output)

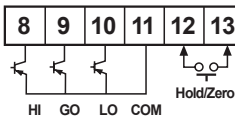

● MT4Y-□-43

(Relay output+Transmission output)

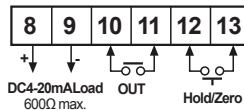

● MT4Y-□-44

(Relay+RS485 communication output)

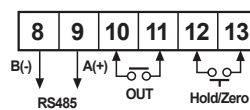

● MT4Y-□-45

(BCD Dynamic output)

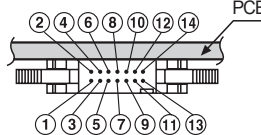
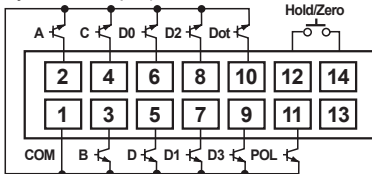

● MT4Y-□-46 (Low speed serial output)

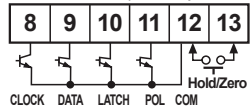

※POL : When a display value is "-", the signal of "-" will be outputted.

※Hirose connector pin header model of the unit : HIF3BA-14PA-2.54DS

※Contact Hirose Electric to purchase socket and wires of Hirose connector.

[Socket : HIF3BA-14D-2.54R]

◎ Measuring input connection of MT4W Series

● MT4W-DV-□□

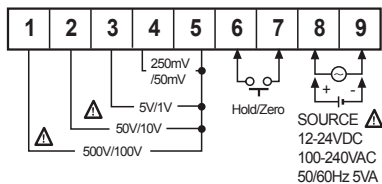

● MT4W-AV-□□

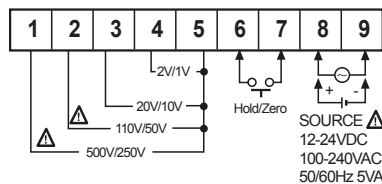

● MT4W-DA-□□

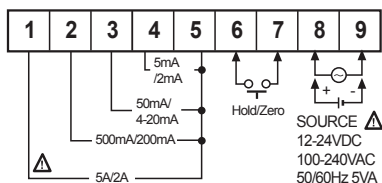

● MT4W-AA-□□

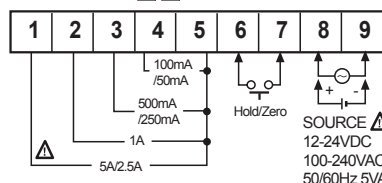

(A)	Photo electric sensor
(B)	Fiber optic sensor
(C)	Door/Area sensor
(D)	Proximity sensor
(E)	Pressure sensor
(F)	Rotary encoder
(G)	Connector/Socket
(H)	Temp. controller
(I)	SSR/ Power controller
(J)	Counter
(K)	Timer
(L)	Panel meter
(M)	Tacho/ Speed/ Pulse meter
(N)	Display unit
(O)	Sensor controller
(P)	Switching mode power supply
(Q)	Stepper motor& Driver&Controller
(R)	Graphic/ Logic panel
(S)	Field network device
(T)	Software
(U)	Other

MT4Y/MT4W Series

◎ Output terminal connection of MT4W Series

- **MT4W-□-□0** (Triple relay contact output + Transmission output)

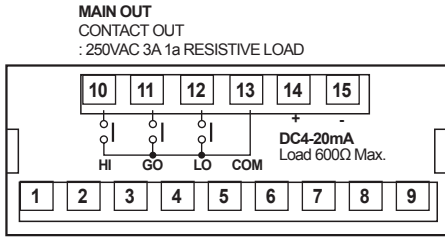

- **MT4W-□-□1** (Triple relay contact output)

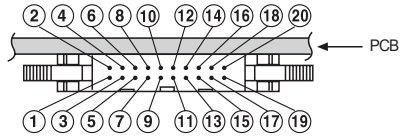
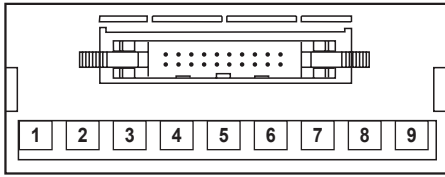
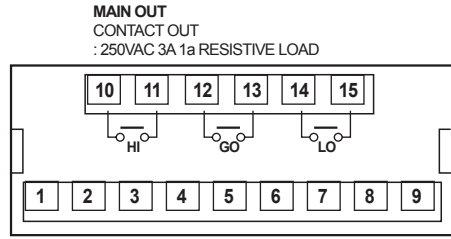

※Hirose connector pin header model of the unit : HIF3BA-20PA-2.54DS
※Contact Hirose Electric to purchase socket and wires of Hirose connector. [Socket: HIF3BA-20D-2.54R]

- **MT4W-□-□2 / MT4W-□-□3** (Triple NPN/PNP open collector output+BCD output)

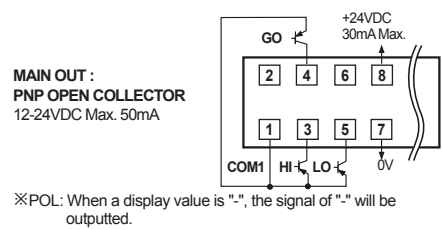
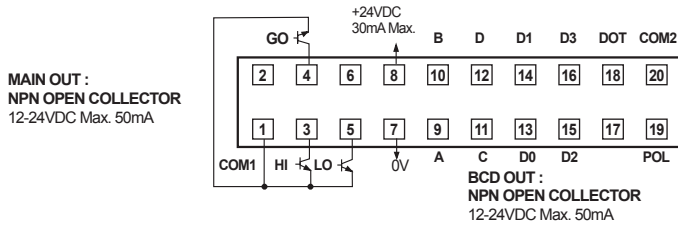

- **MT4W-□-□4 / MT4W-□-□5** (Triple NPN/PNP open collector output+Transmission output)

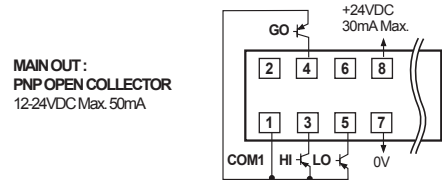
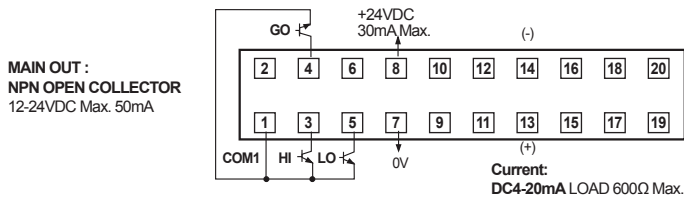

- **MT4W-□-□6 / MT4W-□-□7** (Triple NPN/PNP open collector output+Low speed serial output)

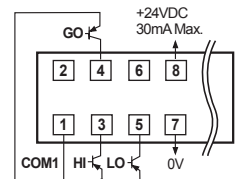
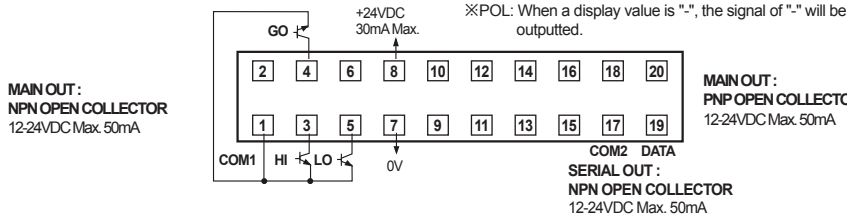

- **MT4W-□-□8 / MT4W-□-□9** (Triple NPN/PNP open collector output+RS485 output)

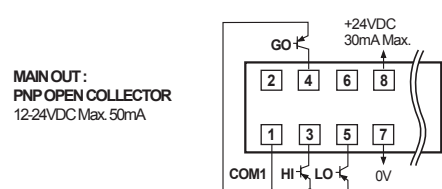
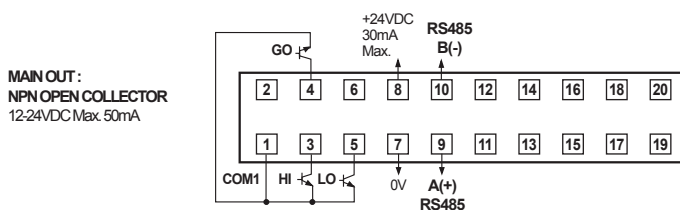

■ Dimensions

(unit: mm)

● MT4Y-□-4N, 45, 46

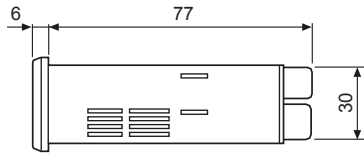
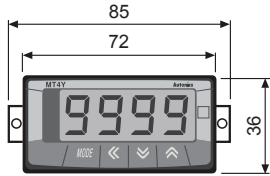

<MT4Y-□-4N, 40 to 44, 46>

● Panel cut-out

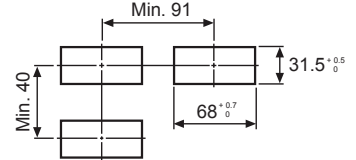

● MT4Y-□-43, 44

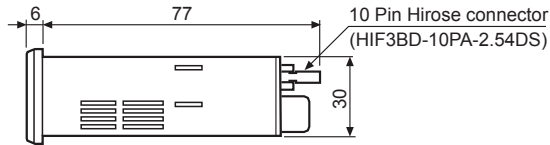

<MT4Y-□-45>

● MT4Y-□-40, 41, 42



● MT4W-□-□N (Indicator)

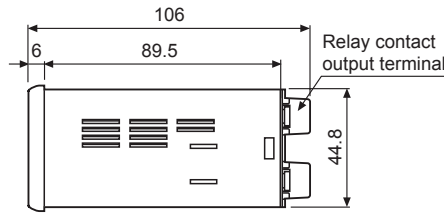
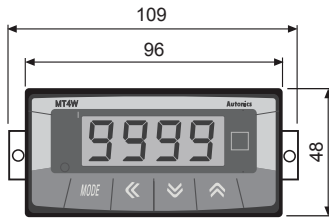

※ There is no Relay contact output terminal block in indication type.

< MT4W-□-□N, MT4W-□-□0, □1 >

● Panel cut-out

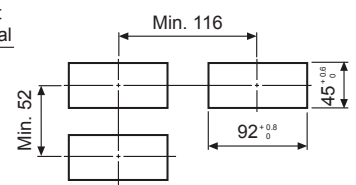

● MT4W-□-□0 to □9

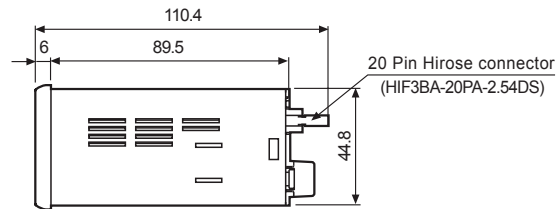

< MT4W-□-□2 to □9 >

■ Parameter setting

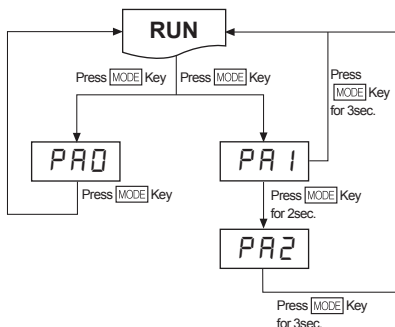

※ Press **[MODE]** key in **RUN** status, it will advance to **[PA□]**(Parameter 0) group.

※ Press **[MODE]** key for 2 sec. in **RUN** mode, **[PA □]** is displayed.

※ Press **[MODE]** key for 4 sec. in **RUN** mode, **[PA □]** is displayed after **[PA □]**.

When pressing **[MODE]** key continually, it stops displaying at **[PA □]**.

※ It is advanced to current display parameter releasing **[MODE]** key at **[PA □]** or **[PA □]**.

※ Press **[MODE]** key for 3 sec., it is returned to **RUN** at any position.

※ If any key is not touched for 60 sec. in each parameter, it returns to **RUN** mode.

※ After return to **RUN** mode, press **[MODE]** key within 2 sec., it returns to previous parameter. (Refer to the below descriptions for set parameter.)

※ It cannot advance to **[PA □]** when preset output operation mode of **[PA □]** is **[OFF]**.

(A)	Photo electric sensor
(B)	Fiber optic sensor
(C)	Door/Area sensor
(D)	Proximity sensor
(E)	Pressure sensor
(F)	Rotary encoder
(G)	Connector/Socket
(H)	Temp. controller
(I)	SSR/ Power controller
(J)	Counter
(K)	Timer
(L)	Panel meter
(M)	Tacho/ Speed/ Pulse meter
(N)	Display unit
(O)	Sensor controller
(P)	Switching mode power supply
(Q)	Stepper motor& Driver&Controller
(R)	Graphic/ Logic panel
(S)	Field network device
(T)	Software
(U)	Other

MT4Y/MT4W Series

Parameter 1 group

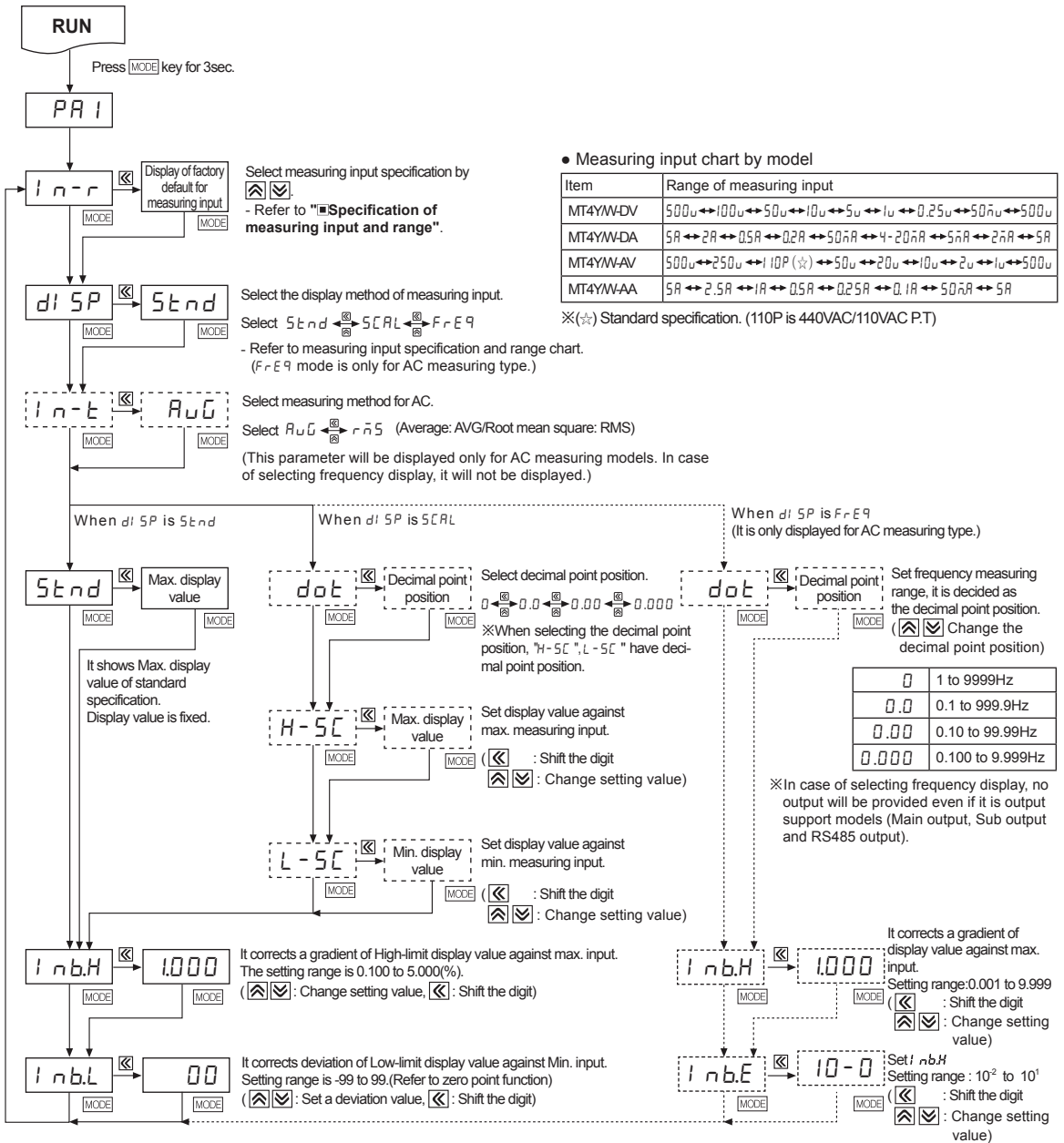

※After setting each mode, press **MODE** key for 2 sec. to return to RUN.
 ※If any key is untouched for 60sec. after advance to Parameter, it will return to RUN.

Factory defaults

Parameter	MT4Y/W-DV	MT4Y/W-DA	MT4Y/W-AV	MT4Y/W-AA	Parameter	MT4Y/W-DV	MT4Y/W-DA	MT4Y/W-AV	MT4Y/W-AA
In-r	500 μ	5A	500 μ	5A	In-b.H	1.000	1.000	1.000	1.000
di SP	Stnd	Stnd	Stnd	Stnd	In-b.L	00	00	00	00
In-t	—	—	AuG	AuG	dot	0.0	0.000	0.0	0.000
Stnd	500.0	5.000	500.0	5.000	In-b.E	—	—	10-0	10-0

Parameter 2 group

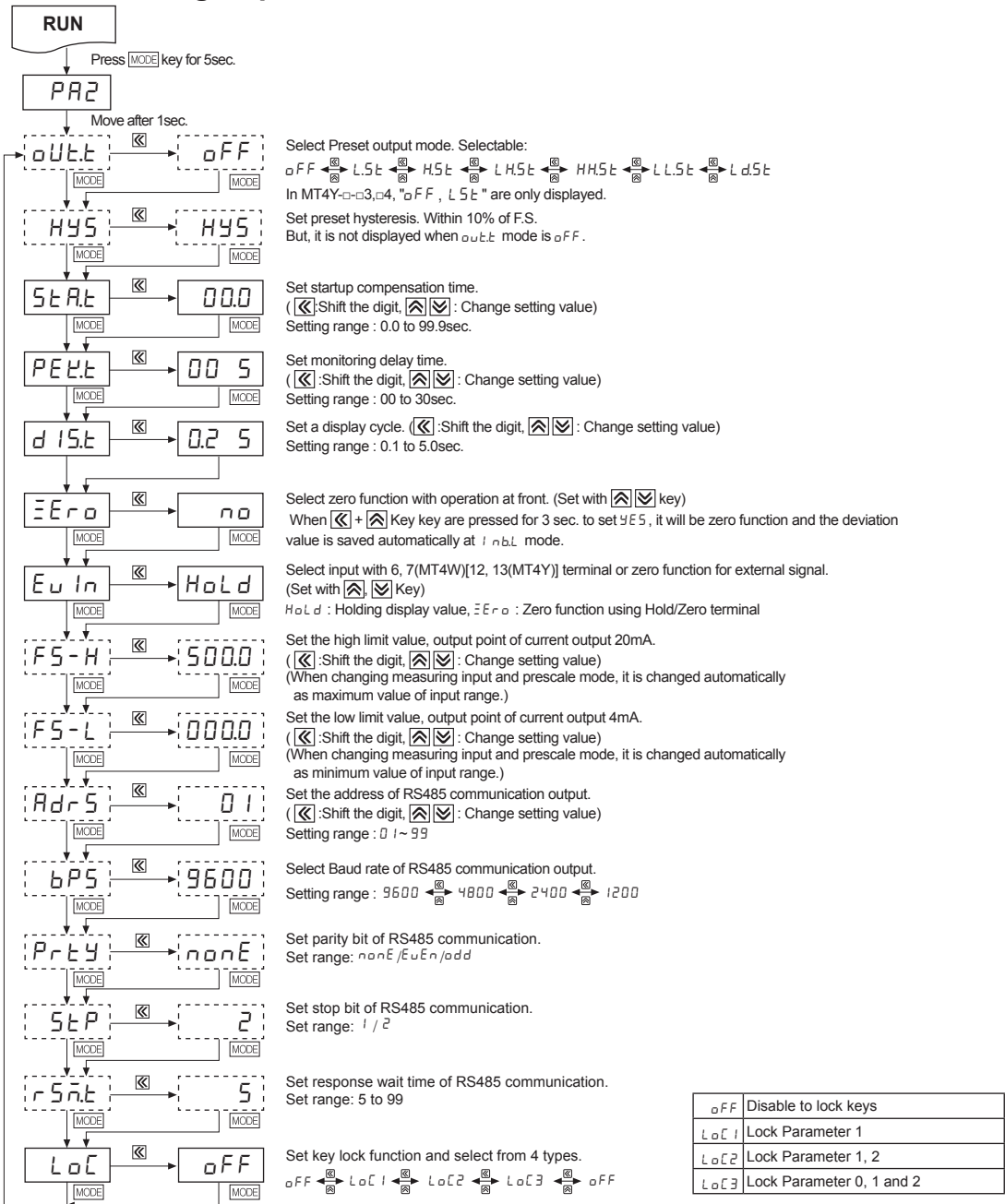

※The dotted mode is only displayed for output type.

※After setting each mode, press [MODE] key for 2 sec. to return to RUN mode.

※If any key is untouched for 60sec. after advance to PARAMETER, it will return to RUN mode.

Factory defaults

Parameter	MT4Y/W-DV	MT4Y/W-DA	MT4Y/W-AV	MT4Y/W-AA	Parameter	MT4Y/W-DV	MT4Y/W-DA	MT4Y/W-AV	MT4Y/W-AA
oUt	oFF	oFF	oFF	oFF	EuIn	HoLd	HoLd	HoLd	HoLd
HYS	001	001	001	001	FS-H	5000	5000	5000	5000
StAr	000	000	000	000	FS-L	0000	0000	0000	0000
PElt	005	005	005	005	AdRS	01	01	01	01
dISt	0.25	0.25	0.25	0.25	bPS	9600	9600	9600	9600
Err	no	no	no	no	LoC	oFF	oFF	oFF	oFF

(A)	Photo electric sensor
(B)	Fiber optic sensor
(C)	Door/Area sensor
(D)	Proximity sensor
(E)	Pressure sensor
(F)	Rotary encoder
(G)	Connector/Socket
(H)	Temp. controller
(I)	SSR/Power controller
(J)	Counter
(K)	Timer
(L)	Panel meter
(M)	Tacho/Speed/Pulse meter
(N)	Display unit
(O)	Sensor controller
(P)	Switching mode power supply
(Q)	Stepper motor& Driver&Controller
(R)	Graphic/Logic panel
(S)	Field network device
(T)	Software
(U)	Other

MT4Y/MT4W Series

Parameter 0 group

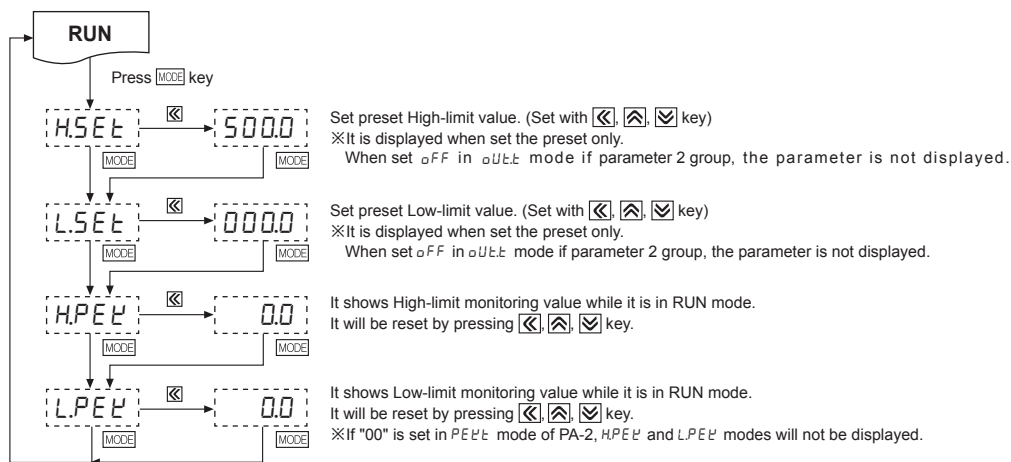

※If any key is untouched for 60sec. after advance to Parameter, it will return to **RUN** mode.

Factory defaults

Parameter	MT4Y/W-DV	MT4Y/W-DA	MT4Y/W-AV	MT4Y/W-AA	Parameter	MT4Y/W-DV	MT4Y/W-DA	MT4Y/W-AV	MT4Y/W-AA
HSEt	500.0	5.000	500.0	5.000	HPEt	0.0	0.000	0.0	0.000
LSEt	000.0	0.000	000.0	0.000	LPEt	0.0	0.000	0.0	0.000

Measuring input and range

Type	Measuring input and range	Input impedance	Display range [5tnd]	Prescale display range [5CR L]										
DC Volt	0-500V [500v]	4.33MΩ	0.0 to 500.0	<table border="1"> <tr> <th>dot</th> <th>Display range</th> </tr> <tr> <td>0</td> <td>-1999 to 9999</td> </tr> <tr> <td>0.0</td> <td>-199.9 to 999.9</td> </tr> <tr> <td>0.00</td> <td>-19.99 to 99.99</td> </tr> <tr> <td>0.000</td> <td>-1.999 to 9.999</td> </tr> </table> <p>(The display range is changed according to the decimal point position.)</p> <p>※Please connect proper terminal its max. input voltage is within 30 to 100% of input terminal. When it is higher than input voltage, it may cause a breakdown of terminal and over display range and the accuracy is decreased when it is connected to the terminal under 30%.</p> <p>※110P is standard specification 440V/110VAC P.T.</p>	dot	Display range	0	-1999 to 9999	0.0	-199.9 to 999.9	0.00	-19.99 to 99.99	0.000	-1.999 to 9.999
	dot	Display range												
	0	-1999 to 9999												
	0.0	-199.9 to 999.9												
	0.00	-19.99 to 99.99												
	0.000	-1.999 to 9.999												
	0-100V [100v]	4.33MΩ	0.0 to 100.0											
	0-50V [50v]	433.15kΩ	0.00 to 50.00											
0-10V [10v]	433.15kΩ	0.00 to 10.00												
0-5V [5v]	43.15kΩ	0.000 to 5.000												
0-1V [1v]	43.15kΩ	0.000 to 1.000												
0-250mV [0.25v]	2.15kΩ	0.0 to 250.0												
0-50mV [50mv]	2.15kΩ	0.00 to 50.00												
DC Ampere	0-5A [5A]	0.01Ω	0.000 to 5.000											
	0-2A [2A]	0.01Ω	0.000 to 2.000											
	0-500mA [0.5A]	0.1Ω	0.0 to 500.0											
	0-200mA [0.2A]	0.1Ω	0.0 to 200.0											
	0-50mA [50ma]	1.0Ω	0.00 to 50.00											
	4-20mA [4-20]	1.0Ω	4.00 to 20.00											
	0-5mA [5ma]	10.0Ω	0.000 to 5.000											
	0-2mA [2ma]	10.0Ω	0.000 to 2.000											
AC Volt	0-500V [500v]	4.98MΩ	0.0 to 500.0											
	0-250V [250v]	4.98MΩ	0.0 to 250.0											
	0-110V [110P]	1.08MΩ	0.0 to 440.0											
	0-50V [50v]	1.08MΩ	0.00 to 50.00											
	0-20V [20v]	200kΩ	0.00 to 20.00											
	0-10V [10v]	200kΩ	0.00 to 10.00											
	0-2V [2v]	20kΩ	0.000 to 2.000											
0-1V [1v]	20kΩ	0.000 to 1.000												
AC Ampere	0-5A [5A]	0.01Ω	0.000 to 5.000											
	0-2.5A [2.5A]	0.01Ω	0.000 to 2.500											
	0-1A [1A]	0.05Ω	0.000 to 1.000											
	0-500mA [0.5A]	0.1Ω	0.0 to 500.0											
	0-250mA [0.25A]	0.1Ω	0.0 to 250.0											
	0-100mA [0.1A]	0.5Ω	0.0 to 100.0											
0-50mA [50ma]	0.5Ω	0.00 to 50.00												

■ Functions

◎ AC frequency measurement function

[PA 1 group: $d15P$]

It measures input signal frequency when it is AC input. It uses fixed decimal point[PA1: $d0E$], measured range can be changed by setting and measured range of decimal point position is as below chart. It is available to adjust the upper gradient at [PA 1: $i nbH$]and [PA 1: $i nbE$]. In order to measure frequency normally, input signal, over 10% F.S. of the measured range, should be supplied. Please select the proper point of

① Measuring range

Decimal point position	0.000	0.00	0.0	0
Measurement range	0.100 to 9.999Hz	0.10 to 99.99Hz	0.1 to 999.9Hz	1 to 9999Hz

※Accuracy of frequency measurement :

Below 1kHz, F.S. $\pm 0.1rdg \pm 2digit$.

From 1kHz to 10kHz, F.S. $\pm 0.3rdg \pm 2digit$.

② $i nbH$: 0.100 to 9.999 [Gradient adjustment of high value]

③ $i nbE$: $10^{-2}, 10^{-1}, 10^0, 10^1$ [Index adjustment of $i nbH$]

◎ Zero adjustment function

(Deviation correction function of low limit display value)

It adjusts the display value of the optional configured input value as zero by force, zero point error can be adjusted with 3 ways as below. When zero point adjustment with front key and Hold terminal is finished normally, zero point of measurement terminal is displayed and the adjusted value at saved in $i nbL$ automatically.

Operation	Input correction value	Front panel key	External input signal
Description	PA 1: Direct input correction value method at $i nbL$ mode.	Press both $\left[\text{Key} \right]$, $\left[\text{Key} \right]$ keys for 3 sec. at the measuring mode.	Short-circuit external Hold terminal no.11,12 [no. 6, 7(MT4W)]over min. 50m. ※It is enable to use in option mode.

※Refer to "◎ Error correction function", "◎ Error display function" and "■ Parameter 2" for function and error.

◎ Current output(DC4-20mA) scale function [PA2 group: $F5-H / F5-L$]

It sets current output for the display value at the output current DC 4-20mA.

It sets display value for 4mA at $F5-L$ and 20mA at $F5-H$ and the range between $F5-H$ and $F5-L$ should be 10%

※When min. set interval between $F5-H$ and $F5-L$ is set as under 10% F.S., it changed as over 10% F.S. automatically.)

※Preset display value is fixed to output as 4mA at under $F5-L$ and 20mA at over $F5-H$.

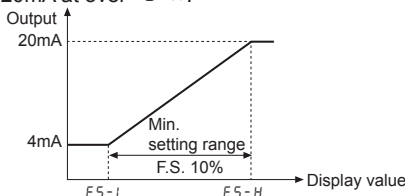

◎ Initialization function

It initializes as the factory default status. If press $\left[\text{Key} \right]$, $\left[\text{Key} \right]$, $\left[\text{Key} \right]$ keys together for 2sec. in RUN mode, $i nbL$ mode and the setting value ($n0$) is displayed every 0.5 sec. and it will be initialized as the factory default when press $\left[\text{MODE} \right]$ key after

change $n0 \rightarrow 4E5$.

◎ Startup compensation time function

[PA 2 group : $5tRt$]

This time function limits the operation of an output until the measured input(overvoltage or inrush current) is stable at moment of power on. All outputs are off during startup compensation time setting after power is applied.

Setting range : 00.0 to 99.9(unit: sec.)

Factory default : 00.0

◎ Error display function

Display	Description
HHHH	Flashing when measuring input is exceeded the max. allowable input(110%)
LLLL	Flashing when measuring input is exceeded the minx. allowable input(-10%)
d-HH	Lights when display input is exceeded the max. display range(9999) or $H-5E$ setting value
d-LL	Lights when display input is exceeded the min. display range (-1999) or $L-5E$ setting value
F-HH	Flashes when measuring frequency is exceeded themax. measuring value (9999)
00Er	Flashes when it exceeds zero adjustment range(± 99)

※Error display is released automatically when it is in the measured and display range.

※"LLLL" is displayed when the measuring input is 4-20mA.

※ After flashing "00Er" 2 times when it exceeds the zero range, it returns to RUN mode.

◎ Display scale function[PA 1 group: $H-5E / L-5E$]

This function is to display setting(-1999 to 9999) of particular High/Low-limit value in order to display High/Low-limit value of measured input. If measured inputs are 'a' and 'b' and particular values are 'A' and 'B', it will display $a=A$, $b=B$ as below graphs.

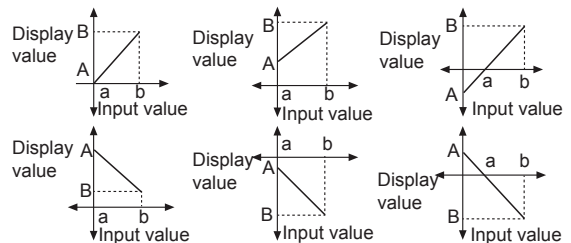

◎ Gradient correction function

[PA 1 group: $i nbH$]

This function is to correct a gradient of prescale value and display value. (Fig.1) Display value Y can be used as α , β times against X input value by correction function[$i nbH$]. And also can be used as correction function of max. display value($H-5E$). Adjustment range is 0.100 to 5.000 and multiply current gradient.

Ex)Input : DC200mV, Display : 3.000 for MT4W-DV

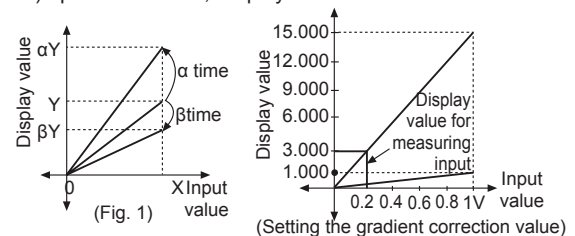

(A)	Photo electric sensor
(B)	Fiber optic sensor
(C)	Door/Area sensor
(D)	Proximity sensor
(E)	Pressure sensor
(F)	Rotary encoder
(G)	Connector/Socket
(H)	Temp. controller
(I)	SSR/ Power controller
(J)	Counter
(K)	Timer
(L)	Panel meter
(M)	Tacho/ Speed/ Pulse meter
(N)	Display unit
(O)	Sensor controller
(P)	Switching mode power supply
(Q)	Stepper motor& Driver&Controller
(R)	Graphic/ Logic panel
(S)	Field network device
(T)	Software
(U)	Other