

# AREA SENSOR BW SERIES

M A N U A L

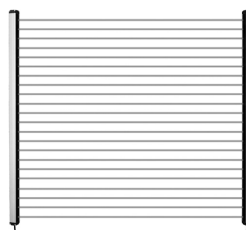

Thank you for choosing our Autonics product.

Please read the following safety considerations before use.

## ■ Safety Considerations

- ※ Please observe all safety considerations for safe and proper product operation to avoid hazards.
- ※ Safety considerations are categorized as follows.
- Warning** Failure to follow these instructions may result in serious injury or death.
- Caution** Failure to follow these instructions may result in personal injury or product damage.
- ※ The symbols used on the product and instruction manual represent the following:
  - ⚠ symbol represents caution due to special circumstances in which hazards may occur.

### ⚠ Warning

- Fail-safe device must be installed when using the unit with machinery that may cause serious injury or substantial economic loss. (e.g. nuclear power control, medical equipment, ships, vehicles, railways, aircraft, combustion apparatus, safety equipment, crime/disaster prevention devices, etc.) Failure to follow this instruction may result in personal injury, fire, or economic loss.
- The unit is not safety sensor protecting from damages of property or injury from dangerous parts of mechanical equipment. The unit detects a normal object or intrusion into the working area regardless of safety.
- Do not use the unit as safety equipment for the cutter or press.
- The unit does not follow any international safety standard. Check the safety standard of the country the unit is used.
- Make sure that you do not take any responsibilities for the problem related to overseas laws or <Product Liability (PL)> are happened by using as follows:
  - ① Safety equipment for protecting a hand or other parts of worker at dangerous area
  - ② Interlock on mechanical equipment
  - ③ Safety sensor on mechanical equipment for stopping it when sensing a hand or other parts of worker
  - ④ Using for detecting a hand or other parts of worker at dangerous area and controlling door or window

### ⚠ Caution

- Do not use the unit outdoors. Failure to follow this instruction may result in electric shock or shorten the life cycle of the unit. Use the unit indoors only. Do not use the unit outdoors, where it may be affected by external environmental factors. (e.g. rain, dust, frost, sunlight, condensation, etc.)
- Do not wire the unit in power ON status. Failure to follow this instruction may result in electric shock.
- Use the unit within the rated specifications. Failure to follow this instruction may shorten the life cycle of the unit.
- Ground Frame Ground (F.G.) terminal when supplying power by switching power.
- Avoid using the unit where fluorescent light with high frequency, high speed start or signal light may be present affecting to sensing ability.
- When installing the unit within 0.5m on a flat surface, or wall, the reflection off the surface may cause malfunction. Refer to the <■ Installation>.
- When installing the units in parallel, it may cause sensing error because as light interference. Refer to the <■ Installation>.
- Install an emitter and a receiver in the same direction. The emitting light is not transferred to the receiver if the emitter is installed in opposite direction.
- Do not use the unit where heavy vibration may be present. Failure to follow this instruction may result in product damage or fire.
- Do not use water or oil-based detergent when cleaning the unit. Failure to follow this instruction may result in electric shock or fire.
- Power and output lines should be shorten as possible (max. 30m), or it may cause malfunction by surge, etc.

## ■ Ordering Information

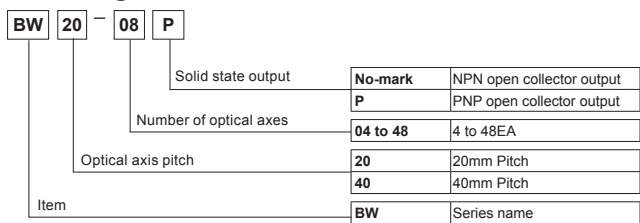

## ■ Function

### ⊙ Light Emitted Stop Function (external diagnosis function)

When TEST input (black) of emitter is 0V, emit is stopped and red LED of emitter flashes. It is available to check whether sensor operates properly with stopping the transmission when TEST input (black) of emitter is 0V. (It is changed to light OFF status when emit the transmission is stopped, control output of receiver is OFF.)

### • Connections for TEST input

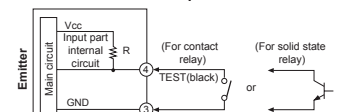

### • Control output pulse by TEST input

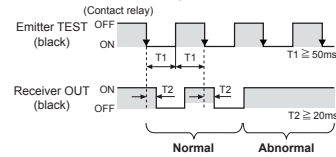

### ⊙ Self-Diagnosis Function

Control output will be OFF and operating indicator is ON when malfunction is checked by self-diagnosis regularly in normal operation.

### • Diagnosis items

- Emitter: ① Break of light emitting element, ② Break of light emitter, ③ Malfunction of MASTER/SLAVE line (Operation in MASTER)
- Receiver: ① Break of light receiver, ② Overcurrent at output part, ③ Synchronous line noise

※ Refer to "■ Operation indicator" for the display operation of diagnosis.

### ⊙ Interference Protection Function

In case of using 2 sensors in parallel in order to extend sensing width, it may cause sensing error because as light interference. This function is operating a sensor as MASTER and another sensor as SLAVE to avoid these sensing errors by the light interference.

### • Time chart for MASTER/SLAVE transmission pulse

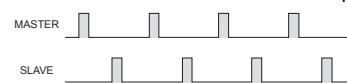

### • MASTER/SLAVE connections

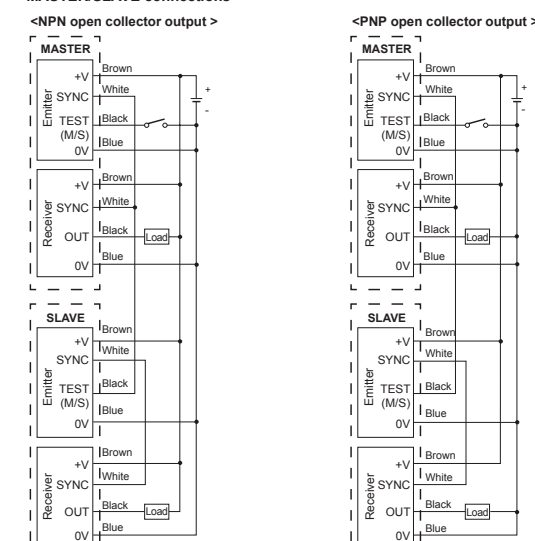

※ Connect "TEST"/M/S" of SLAVE emitter to "SYNC" of MASTER.  
 ※ The above specifications are subject to change and some models may be discontinued without notice.

## ■ Specifications

Model	BW20- (P)	BW40- (P)
Sensing method	Through-beam	
Sensing distance	0.1 to 7m	
Sensing target	Opaque materials of min. Ø30mm	Opaque materials of min. Ø50mm
Optical axis pitch	20mm	40mm
Number of optical axis	8 to 48EA	4 to 24EA
Sensing width	140 to 940mm	120 to 920mm
Power supply	12-24VDC ±10%(Ripple P-P: Max. 10%)	
Reverse polarity protection	Built in	
Current consumption	Emitter: Max. 120mA, Receiver: Max. 120mA	
Control output	NPN or PNP open collector output • Load voltage: Max. 30VDC • Load current: Max. 100mA • Residual voltage - NPN: Max. 1V, PNP : Max. 2.5V	
Operation mode	Light ON fixed	
Short-circuit protection	Built-in	
Response time	Max. 10ms	
Light source	Infrared LED(850nm modulated)	
Synchronization type	Synchronized by synchronous line	
Self-diagnosis	Emitter/Receiver light circuit monitoring, Direct light monitoring, Output circuit monitoring	
Interference protection	Interference protection by master/slave function	
Ambient illumination	Ambient light : 100,000lx	
Ambient temperature	-10 to 55°C, storage : -20 to 60°C	
Ambient humidity	35 to 85%RH, storage : 35 to 85%RH	
Noise resistance	±240V the square wave noise (pulse width 1µs) by the noise simulator	
Dielectric strength	1,000VAC 50/60Hz for 1minute	
Insulation resistance	Min. 20MΩ(at 500VDC megger)	
Vibration	1.5mm amplitude at frequency of 10 to 55Hz(for 1 min.) in each X, Y, Z direction for 2 hours	
Shock	500m/s <sup>2</sup> (approx. 50G) in each X, Y, Z direction for 3 times	
Protection	IP65(IEC standard)	
Material	• Case : Aluminum • Cover, sensing part : Acrylic	
Cable	Ø5mm, 4-wire, length: 300mm, M12 connector	
Accessory	Bracket A : 4ea, Bracket B : 4ea, Bolt : 8ea	
Approval	CE	
Weight*1	Approx. 2.1kg(approx. 1.4kg) (BW20-48)	Approx. 2.1kg (approx. 1.4kg) (BW40-24)

\*1: The weight includes packaging. The weight in parentheses is for unit only.  
 ※The temperature and humidity of environment resistance is rated at non-freezing or condensation.

## ■ Structure

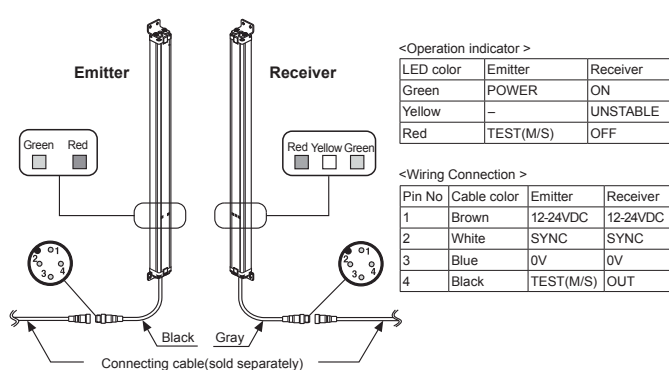

## ■ Connecting Cable(sold separately)

Model	L	Cable color
Emitter		
CID4-3T	3m	Black
CID4-5T	5m	Black
CID4-7T	7m	Black
CID4-10T	10m	Black
CID4-3R	3m	Gray
CID4-5R	5m	Gray
CID4-7R	7m	Gray
CID4-10R	10m	Gray
Receiver		

※ Connecting cable is sold separately as one set; each of emitter's and receiver's.

## ■ Control Output Diagram

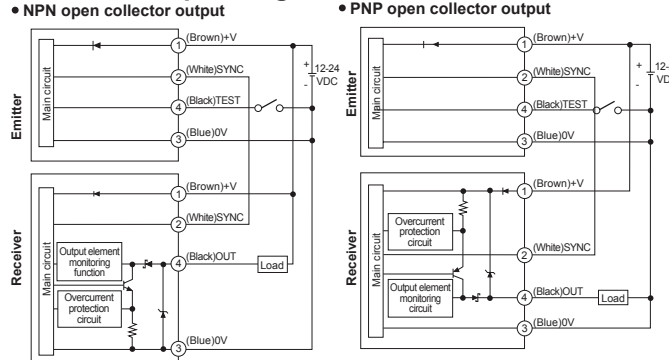

## ■ Operation Timing Diagram

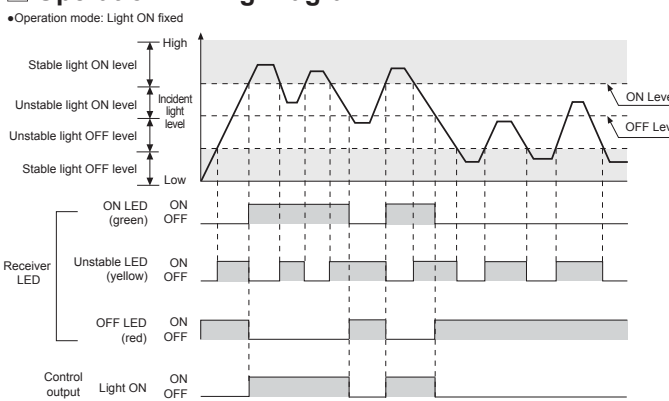

## ■ Installation

### ⊙ For Direction Of Installation

Emitter and receiver should be installed in same up/down direction.

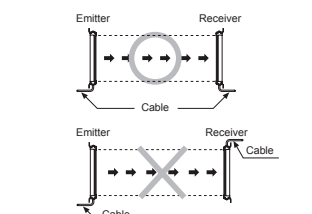

### ⊙ For Reflection From The Surface Of Wall And Flat

When installing it as below the light reflected from the surface of wall and flat will not be shaded. Please, check whether it operates normally or not with a sensing target before using. (Interval distance : Min. 0.5m)

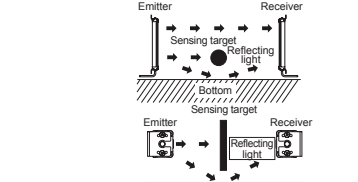

### ⊙ For Prevention Of Interference

It may cause interference when installing more than 2 sets of the sensor. In order to avoid the interference of the sensor, please install as following figures and use the interference protection function.

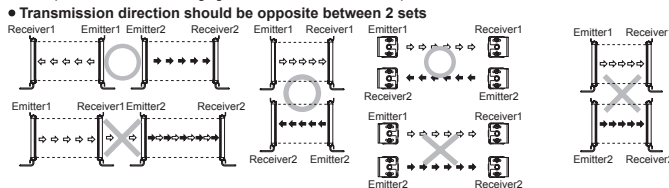

### • Baffle should be installed between 2 sets

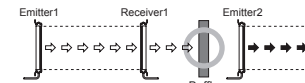

### • It should be installed out of the interference distance

Emitter1	Receiver1	Emitter2	Receiver2
Sensing distance (L)			
Installation allowable distance (D)			
0.1 to 3m		Min. 0.4m	
Min. 3m		L×tanθ = L×0.14 min	

※ There can be a little different based on installation environment.

## ■ Dimensions

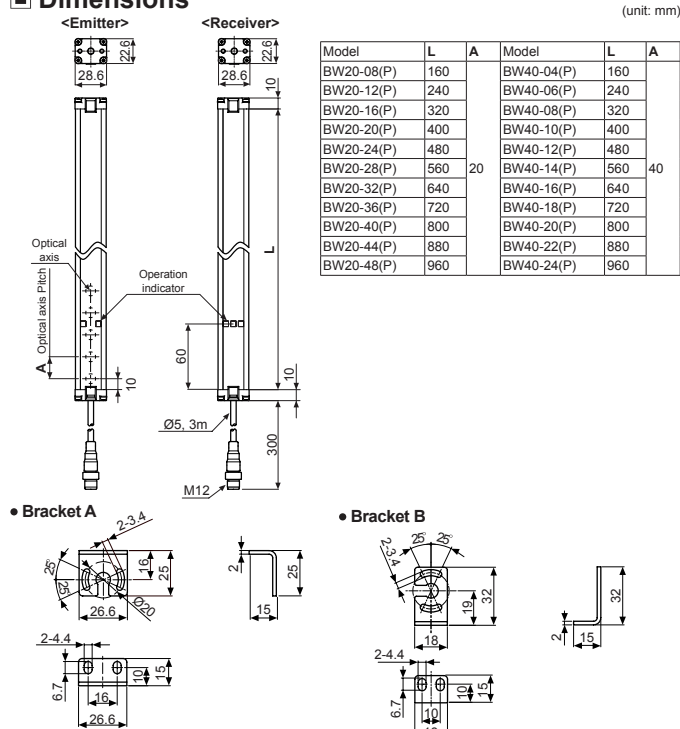

## ■ Bracket Mounting



## ■ Optical Axis Pitch/Number Of Optical Axis/Sensing Height

Model	Number of optical axis	Sensing height	Optical axis pitch	Model	Number of optical axis	Sensing height	Optical axis pitch
BW20-08(P)	8ea	140mm	20mm	BW40-04(P)	4ea	120mm	40mm
BW20-12(P)	12ea	220mm	20mm	BW40-06(P)	6ea	200mm	40mm
BW20-16(P)	16ea	300mm	20mm	BW40-08(P)	8ea	280mm	40mm
BW20-20(P)	20ea	380mm	20mm	BW40-10(P)	10ea	360mm	40mm
BW20-24(P)	24ea	460mm	20mm	BW40-12(P)	12ea	440mm	40mm
BW20-28(P)	28ea	540mm	20mm	BW40-14(P)	14ea	520mm	40mm
BW20-32(P)	32ea	620mm	20mm	BW40-16(P)	16ea	600mm	40mm
BW20-36(P)	36ea	700mm	20mm	BW40-18(P)	18ea	680mm	40mm
BW20-40(P)	40ea	780mm	20mm	BW40-20(P)	20ea	760mm	40mm
BW20-44(P)	44ea	860mm	20mm	BW40-22(P)	22ea	840mm	40mm
BW20-48(P)	48ea	940mm	20mm	BW40-24(P)	24ea	920mm	40mm

## ■ Operation Indicator

Item	Emitter Indicator		Receiver Indicator		Control output
	Green	Red	Green	Yellow	
Power ON	ON	OFF	ON	OFF	Light ON
MASTER operation	ON	OFF	ON	OFF	-
SLAVE operation	ON	OFF	ON	OFF	-
Test input	ON	OFF	ON	OFF	-
Break of emitter	ON	OFF	ON	OFF	-
Break of light emitting element	ON	OFF	ON	OFF	OFF
Install mode	Normal installation	ON	ON	ON	OFF
	Hysteresis installation	ON	ON	ON	OFF
	Abnormal installation	ON	ON	ON	OFF
Stable light ON	ON	OFF	ON	ON	ON
Unstable light ON	ON	OFF	ON	ON	ON
Unstable dark ON	ON	OFF	ON	ON	OFF
Stable dark ON	ON	OFF	ON	ON	OFF
Break of receiver	ON	OFF	ON	ON	OFF
Control output overcurrent	ON	OFF	ON	ON	OFF
Synchronous line noise	ON	OFF	ON	ON	OFF
Emitter failure(Time out)	ON	OFF	ON	ON	OFF

Display classification list

Light ON	ON	Cross-Flashing by 0.5 sec.
Light OFF	OFF	Sequence-Flashing by 0.5 sec.
Flashing by 0.5 sec.	ON	Cross-Flashing twice by 0.5 sec.
Flashing simultaneously by 0.5 sec.	ON	

## ■ Troubleshooting

Malfunction	Cause	Troubleshooting
Non-operation	Power supply Cable incorrect connection or disconnection Rated connection failure	Supply rated power. Check the wiring. Use it within rated sensing distance.
Non-operation in sometimes	Pollution by dirt of sensor cover Connector connection failure	Remove dirt by soft brush or cloth. Check the assembled part of the connector.
Control output is OFF even though there is not a target object.	Out of rated sensing distance There is an obstacle to cut off the light emitted between emitter and receiver There is a strong electric wave or noise generated by motor, electric generator, high voltage line etc.)	Use within rated sensing distance. Remove the obstacle. Put away the strong electric wave or noise generator.
LED displays for break of light emitting element	Break of light emitting element	Contact our company.
LED displays for break of emitter	Break of light emitting circuit	Contact our company.
LED displays for break of receiver	Break of light emitting receiving element	Contact our company.
LED displays for synchronous line malfunction	Synchronous line incorrect connection or disconnection Break of synchronous circuit of emitter or receiver	Check the wiring. Contact our company.
LED displays for over current	Control output line is shorten Over load	Check the wiring. Check the rated load capacity.
LED displays for emitter malfunction	Emitter malfunction	Treat after checking the emitter display LED.

## ■ Cautions During Use

- Make the interval enough between 2 sets or exchange the positions of emitter and receiver in order to remove interference as occurring interference by the emitter of another set when emitter/receiver more than 2 sets closely.
  - If the sensor is installed directly on a flat surface, the reflection off the surface may cause malfunction. Make sure there is enough height space (approx. up to 0.5m) between the sensor and the surface.
  - Avoid using the unit where fluorescent light with high frequency, high speed start or signal light may be present affecting to sensing ability.
  - If the sensor is wired with a high voltage line or power line, it may cause product damage or malfunction. Use separate wiring or a dedicated conduit.
  - Avoid installation in places where dust or corrosion may be present, as it may cause product malfunction.
  - Please use short cables for wiring the sensors. Power surge from extended wiring may cause product malfunction.
  - When the lens is stained by foreign substances, clean the lens lightly with dry cloth. Do not use chemical or organic solvents.
  - When using switching mode power supplies (S.M.P.S.) to supply power, the F.G. terminal must be grounded, and a noise removing condenser must be installed between 0V and F.G. terminals.
  - This unit may be used in the following environments.
    - ① It shall be used indoor
    - ② Altitude up to 2,000m
    - ③ Pollution degree 2
    - ④ Installation category II
- ※ Failure to follow these instructions may result in product damage.

## ■ Major Products

- Photoelectric Sensors
- Fiber Optic Sensors
- Door Sensors
- Door Side Sensors
- Area Sensors
- Proximity Sensors
- Pressure Sensors
- Rotary Encoders
- Sensor/Sockets
- Switching Mode Power Supplies
- Control Switches/Lamps/Buzzers
- I/O Terminal Blocks & Cables
- Stepper Motors/Drivers/Motion Controllers
- Graphical Logic Panels
- Field Network Devices
- Laser Marking System(Fiber, Co. Nd:Yag)
- Laser Welding/Soldering System
- Temperature Controllers
- Temperature/Humidity Transducers
- SSR/Power Controllers
- Counters
- Timers
- Panel Meters
- Tachometer/Pulse(Rate)/Meters
- Display Units
- Sensor Controllers

Autonics corporation  
<http://www.autonics.com>

Satisfiable Partner For Factory Automation

HEADQUARTERS:  
 18, Bansong-ro 513beon-gil, Haeundae-gu, Busan, Korea  
 OVERSEAS SALES:  
 #402-404, Bucheon Techno Park, 655, Pyeongcheon-ro,  
 Womni-gu, Bucheon, Gyeonggi-do, Korea  
 TEL: 82-32-610-2730 / FAX: 82-32-329-0728  
 E-mail: sales@autonics.com